

CECW-EG Engineer Manual 1110-2-3506	Department of the Army U.S. Army Corps of Engineers Washington, DC 20314-1000	EM 1110-2- 3506 20 January 1984
	Engineering and Design GROUTING TECHNOLOGY	
	Distribution Restriction Statement Approved for public release; distribution is unlimited.	

DEPARTMENT OF THE ARMY
U. S. Army Corps of Engineers
Washington, D. C. 20314

EM 1110-2-3506

DAEN-ECE-G

Engineer Manual
No. 1110-2-3506

20 January 1984

Engineering and Design
GROUTING TECHNOLOGY

1. Purpose. This manual provides technical criteria and guidance for civil works grouting applications. Information on procedures, materials, and equipment for use in planning and executing a grouting project is included, and types of problems that might be solved by grouting are discussed. Methods of grouting that have proven to be effective are described and various types of grouts and their proportions are listed.
2. Applicability. This manual is applicable to all field operating activities having civil works responsibilities.
3. Discussion. Grouting in civil works activities is performed as: (a) an increment of permanent construction, (b) a post-construction remedial treatment, and (c) an increment of expedient construction or repair.

FOR THE COMMANDER:



PAUL F. KAVANAUGH
Colonel, Corps of Engineers
Chief of Staff

DEPARTMENT OF THE ARMY
U. S. Army Corps of Engineers
Washington, D. C. 20314

EM 1110-2-3506

Engineer Manual
No. EM 1110-2-3506

20 January 1984

Engineering and Design
GROUTING TECHNOLOGY

Table of Contents

<u>Subject</u>	<u>Paragraph</u>	<u>Page</u>
CHAPTER 1. INTRODUCTION		
Purpose and Scope	1-1	1-1
Applicability	1-2	1-1
References	1-3	1-1
Changes	1-4	1-1
General Considerations	1-5	1-1
Terminology	1-6	1-1
CHAPTER 2. PURPOSES AND LIMITATIONS OF GROUTING		
Purposes	2-1	2-1
Limitations	2-2	2-1
Selection of Methods of Treatment	2-3	2-2
CHAPTER 3. GEOLOGIC CONSIDERATIONS FOR INVESTIGATION AND DESIGN		
Rock Types	3-1	3-1
Structural Geology	3-2	3-3
Geohydrology	3-3	3-4
Investigation Methods	3-4	3-6
Test Grouting	3-5	3-8
CHAPTER 4. PLANNING AND PROCEDURES		
Considerations	4-1	4-1
Planning Considerations	4-2	4-2
Quality Management	4-3	4-2
Grout Hole Drilling	4-4	4-3
Types of Treatment	4-5	4-6
Grouting Methods	4-6	4-13
Foundation Drainage	4-7	4-19

This manual supersedes EM 1110-2-3501 dated 1 Jul 66 and EM 1110-2-3503 dated 19 Aug 63.

20 Jan 84

	<u>Subject</u>	<u>Paragraph</u>	<u>Page</u>
CHAPTER 5.	GROUT MATERIALS		
	Grout Materials	5-1	5-1
	Portland Cement Grout Mixtures	5-2	5-5
	Special Cements and Mixtures	5-3	5-9
	Mixture Adjustments	5-4	5-10
	Chemical Grouts	5-5	5-14
	Asphalt Grouts	5-6	5-15
	Clay Grouts	5-7	5-15
CHAPTER 6.	EQUIPMENT		
	Introduction	6-1	6-1
	Drilling and Grouting Equipment	6-2	6-1
	Special Monitoring Equipment	6-3	6-29
CHAPTER 7.	APPLICATION TO WATER RETENTION STRUCTURES		
	Concrete Dams	7-1	7-1
	Earth and Rockfill Dams	7-2	7-5
CHAPTER 8.	APPLICATION TO TUNNELS, SHAFTS, AND CHAMBERS		
	General Applications	8-1	8-1
	Purposes of Grouting	8-2	8-1
	Applications	8-3	8-1
CHAPTER 9.	APPLICATION TO NAVIGATION STRUCTURES		
	General	9-1	9-1
	Foundation Treatment	9-2	9-1
	Repairs	9-3	9-1
	Grout Curtain Through the Lock Area	9-4	9-2
CHAPTER 10.	APPLICATION TO BUILDING FOUNDATIONS		
	General	10-1	10-1
	Pregrouting Investigation	10-2	10-1
	Soil Stabilization	10-3	10-1
	Rock Foundations	10-4	10-3
CHAPTER 11.	PRECISION AND SPECIALTY GROUTING		
	General Statement	11-1	11-1
	Scope	11-2	11-1
	Applications	11-3	11-1

<u>Subject</u>	<u>Paragraph</u>	<u>Page</u>
CHAPTER 12. PERFORMANCE OF WORK		
General Considerations	12-1	12-1
Contracts	12-2	12-1
Hired Labor	12-3	12-1
CHAPTER 13. FIELD PROCEDURES		
General Considerations	13-1	13-1
Drilling Operation	13-2	13-1
Grouting Operations	13-3	13-3
Completion of Grouting	13-4	13-9
CHAPTER 14. METHODS OF ESTIMATING		
General Considerations	14-1	14-1
Test Grouting	14-2	14-1
Grouting Records	14-3	14-1
Evaluation of Exploration Borings	14-4	14-5
"Unit Take" Estimates	14-5	14-1
Bid Items	14-6	14-2
CHAPTER 15. RECORDS AND REPORTS		
General	15-1	15-1
Records	15-2	15-6
APPENDIX A. REFERENCES AND BIBLIOGRAPHY		
References	A-1	A-1
Bibliography	A-2	A-3
APPENDIX B. EXAMPLE: FIELD PROCEDURE FOR CLARENCE CANNON DAM		B-1
APPENDIX C. PRESSURE COMPUTATION SAMPLES		C-1
APPENDIX D. PHYSICAL CHARACTERISTICS OF SANDED GROUTS		D-1

20 Jan 84

CHAPTER 1 INTRODUCTION

1-1. Purpose. This manual provides technical criteria and guidance for civil works grouting applications. Information on procedures, materials, and equipment for use in planning and executing a grouting project is included, and types of problems that might be solved by grouting are discussed. Methods of grouting that have proven to be effective are described and various types of grout and their proportions are listed. The manual discusses grouts composed primarily of cementitious suspensions and additives although other types are mentioned.

1-2. Applicability. This manual is applicable to all field operating activities responsible for the design and construction of civil projects.

1-3. References. See Appendix A for list of references.

1-4. Changes. Users of this manual are encouraged to submit recommended changes or comments to improve it. Comments should be keyed to the specific page, paragraph, and line of the text in which the change is recommended. Reasons should be provided for each comment to ensure understanding and complete evaluation. Comments should be prepared using DA Form 2028 (Recommended Changes to Publications) and forwarded directly to HQUSACE (DAEN-ECE-G) WASH DC 20314.

1-5. General Considerations. Grouting in civil works activities is performed as: (a) an increment of permanent construction, (b) a postconstruction remedial treatment, and (c) an increment of expedient construction or repair. Examples of permanent construction are curtain grouting in the foundations for a dam and ground stabilization of foundation materials for large buildings. Examples of postconstruction remedial treatment include grouting voids under concrete structures and reducing leakage through a dam foundation or abutment. Grouting is used for both temporary and permanent treatments. It should be considered in combination with other appropriate types of treatment for best results. Other types of treatment may include excavation, compaction, concrete cutoff walls, slurry trenches, impervious blankets, drainage blankets and filter zones, relief wells, drilled drains, sheet pile cutoff, dental concrete, grouting and drainage tunnels and galleries, underpinning, and structural foundations. Purposes of expedient grouting include repair of roadways and cofferdams, and stability and groundwater control during construction.

1-6. Terminology.

a. Alkali-Aggregate Reaction. Chemical reaction in grout between alkalis (sodium and potassium) from portland cement or other sources and certain constituents of some aggregates; under certain conditions, deleterious expansion of the grout may result.

20 Jan 84

- b. Aquiclude. A body of relatively impermeable rock or soil that is capable of absorbing water slowly but functions as an upper or lower boundary of an aquifer and does not transmit groundwater rapidly enough to supply a well or spring.
- c. Aquifer. A stratum or zone below the surface of the earth capable of producing water as from a well.
- d. Aquitard. A confining bed that retards but does not prevent the flow of water to or from an adjacent aquifer; a leaky confining bed.
- e. Area Grouting. Grouting of a shallow zone in a particular area that utilizes holes arranged in a pattern or grid. This type of grouting is sometimes referred to as blanket or consolidation grouting.
- f. Bentonite. A clay composed principally of minerals of the montmorillonite group, characterized by high adsorption and very large volume change with wetting.
- g. Blanket Grouting. As stated in e above.
- h. Bursting Pressure (Grouting Equipment). The pressure at which equipment becomes inoperative.
- i. Cement Factor. Quantity of cement contained in a unit volume of grout, expressed as weight or volume.
- j. Cementitious Factor. Quantity of cement and cementitious materials contained in a unit volume of concrete, grout, or mortar, expressed as weight or volume.
- k. Circuit Grouting. Grouting in a continuous manner with a grout circulating from the pump to the bottom of the zone to be treated and back to the pump.
- l. Coefficient of Permeability (to Water). As stated in ad below.
- m. Colloidal Grout. A grout that has an artificially induced cohesiveness, or the ability to retain the dispersed solid particles in suspension; i.e., a grout mixture that does not settle or bleed.
- n. Consolidation Grouting. As stated in e above.
- o. False Set. The rapid development of rigidity in a freshly mixed grout without the evolution of much heat. Such rigidity can be dispelled and plasticity can be regained by further mixing without the addition of water. Premature stiffening, hesitation set, early stiffening, and rubber set are other terms that refer to the same phenomenon.

20 Jan 84

p. Final Set. A degree of stiffening of a grout mixture greater than initial set, generally stated as an empirical value indicating the time in hours and minutes that is required for cement paste to stiffen sufficiently to resist the penetration of a weighted test needle.

q. Flash Set. The rapid development of rigidity in a freshly mixed grout, usually with the evolution of considerable heat, and rigidity cannot be dispelled nor can plasticity be regained by further mixing without the addition of water; also referred to as quick set or grab set.

r. Free Water. Water that is free to move through a soil mass under the influence of gravity. Other terms are gravitational water, groundwater, and phreatic water.

s. Grout. A mixture of cementitious or noncementitious material, with or without aggregate, to which sufficient water or other fluid is added to produce a flowing consistency.

t. Grout Placement. The introduction of grout by gravity or pressure into voids; usually accomplished by grouting through pipes placed in the medium to be grouted or through drilled open holes penetrating the medium.

u. Grout Take. The volume of grout placed.

v. Heat of Hydration. Heat generated by chemical reactions of cementitious materials with water, such as that evolved during the setting and hardening of portland cement.

w. Hydrofracturing. The fracturing of an embankment or underground strata by pumping water under a pressure in excess of the tensile strength and minor principal stress.

x. Hydrostatic Head. The pressure produced by the height of a fluid above a given point.

y. Initial Set. A degree of stiffening of a grout mixture generally stated as an empirical value indicating the time in hours and minutes that is required for cement paste to stiffen sufficiently to resist the penetration of a weighted test needle.

z. Neat Cement Grout. A fluid mixture of cement and water or the hardened equivalent of such mixtures. Also called neat slurry.

aa. Packers. Expandable mechanical or pneumatic devices used to seal a hole or isolate portions of a hole.

ab. Perched Groundwater. Any groundwater separated by unsaturated rock from an underlying body of groundwater.

20 Jan 84

ac. Perched Water Table. The water table above an impermeable bed underlain by unsaturated rock or soil of sufficient permeability to allow movement of groundwater.

ad. Permeability (Laboratory) (to Water, Coefficient of). The rate of discharge of water under laminar flow conditions through a unit cross-sectional area of a porous medium under a unit hydraulic gradient and standard temperature conditions, usually 20°C.

ae. Pore Pressure. Stress transmitted through the pore water (water filling voids). Also called neutral stress and pore-water pressure.

af. Pressure Testing. Test performed to measure the rate at which water can be forced into a hole under a specific pressure.

ag. Pressure Washing. A process of washing between holes to remove mud and loose material from cracks and seams in the rock. In effect, it is a sluicing operation whereby water or air and water alternately are introduced under pressure into a hole and allowed to vent into adjacent cracks or escape from one or more adjacent holes.

ah. Primary Hole. The first series of holes to be drilled and grouted, usually at the maximum allowable spacing.

ai. Primary Permeability. The permeability of intact rock, rather than permeability due to fracturing.

aj. Primary Porosity. The porosity that develops during final stages of sedimentation or that was present within the sedimentary particles at the time of deposition.

ak. Refusal. The point during grout injection when little or no grout is accepted under the maximum allowable pressure or other specified conditions.

al. Secondary Hole. The second series of holes to be drilled and grouted, spaced midway between primary holes.

am. Section. A linear or areal subdivision of the grout treatment pattern without regard to the depth of treatment.

an. Seep. An area where water oozes from the earth.

ao. Series Grouting. Similar to stage grouting, except each successively deeper zone is grouted by means of a newly drilled hole, eliminating the need for washing grout out before drilling the hole deeper.

ap. Split Spacing. The procedure by which additional grout injection holes are located equidistant from previously grouted holes.

20 Jan 84

aq. Stage. A stage is one complete operational cycle of drilling, cleaning, pressure washing, pressure testing, pressure grouting, and grout cleanout within a zone. Depths of stages in any hole depend on conditions encountered in drilling that dictate where drilling should stop and grouting commence.

ar. Stage Grouting. The grouting of progressively deeper zones in stages. Previously emplaced grout is removed prior to hardening, the hole is drilled to a deeper depth, and another stage is emplaced.

as. Stop Grouting. The grouting of a hole beginning at the lowest zone (bottom) after the hole is drilled to total depth. Packers are used to isolate the zone to be grouted.

at. Sulfate Attack. Harmful or deleterious reactions between sulfates in soil or groundwater and grout.

au. Tertiary Hole. The third series of holes to be drilled and grouted, spaced midway between previously grouted primary and secondary holes.

av. Thixotropy. The property of a material that enables it to stiffen in a short period, on standing, and to regain its initial viscosity by mechanical agitation; the process is reversible.

aw. Time of Setting.

(1) Final setting time. The time required for a freshly mixed grout to achieve final set (harden).

(2) Initial setting time. The time required for a freshly mixed grout to achieve initial set.

ax. Unit Weight. The weight of freshly mixed grout per unit volume, often expressed as pounds per cubic foot.

ay. Viscosity. Friction within a liquid due to mutual adherence of its particles; i.e., the "thickness" of a mixture.

az. Void Ratio. The ratio of the volume of void space to the volume of solid particles in a given soil mass.

ba. Washing. The physical act of cleaning a hole by circulating either water, water and air, acid washes, or water and dissolved chemical substances, through drill rods or tremie pipe in an open hole.

bb. Water/Cement Ratio (Cement Only). The ratio of the amount of water to the amount of cement in a grout mixture, expressed by weight or volume.

20 Jan 84

bc. Water/Cement Ratio (Total Cementitious Materials). The ratio of the amount of water to the amount of total cementitious materials in a grout mixture, expressed by weight or volume.

bd. Water Table. The upper surface of a saturation zone, except where that surface is formed by an impermeable body.

be. Working Pressure. The pressure adjudged best for any particular set of conditions encountered during grouting. Factors influencing the determination are size of voids to be filled, depth of zone to be grouted, lithology of area to be grouted, grout viscosity, and resistance of the formation to fracture or uplift.

bf. Zone. A predetermined subdivision of the overall depth of grout treatment. A single zone may make up the full depth of treatment, or the depth of treatment may be divided into several zones.

CHAPTER 2 PURPOSES AND LIMITATIONS OF GROUTING

2-1. Purposes. Pressure grouting involves the injection under pressure of a liquid or suspension into the voids of a soil or rock mass or into voids between these materials and an existing structure. The injected grout must eventually form either a gel or a solid within the treated voids, or the grouting process must result in the deposition of suspended solids in these voids. The primary purposes of pressure grouting a soil or rock mass are to improve the strength and durability of the mass and/or to reduce the permeability of the mass. This manual provides guidance in the use of pressure grouting as a means to improve existing or anticipated subsurface conditions. Information on procedures, materials, and equipment for use in planning and executing a grouting project is included, and types of problems that might be solved by pressure grouting are discussed. Methods of pressure grouting that have proven to be effective are described, and various types of grouts and their properties are listed.

a. Permeability Reduction. Grouting applications relating to permeability reduction include: (1) in association with other measures, reduction of hydrostatic forces acting on the base of water retention structures and on tunnel linings; (2) reduction of reservoir water loss; (3) in association with other measures, inhibition of internal erosion of foundation and embankment materials; and (4) facilitation of excavation by stabilization, consolidation, and/or water control. For those applications involving structural safety (i.e. hydrostatic force reduction and erosion inhibition) grouting is not to be considered as the sole defense. Multiple defenses, such as grouting in association with drains and/or filters, are to be used.

b. Improvement of Mechanical Properties. Grouting applications relating to mechanical property improvement include: (1) enhancement of bearing capacity, and (2) consolidation of overburden or highly fractured rocks to facilitate surface or underground excavations.

c. Void Filling. Grouting may be necessary to fill both surface and subsurface voids.

d. Stabilization and Lifting. Grouting is used for the stabilization of foundations and for lifting and stabilization of footings, slabs, and pavements.

2-2. Limitations. There are two general types of limitations that apply to grouting: (1) limitations inherent in the physical nature of the grouting materials and in the physical and chemical properties of the materials that the grout will contact, and (2) limitations on grouting operations and methods. Specifically, grouting limitations are delineated in the following paragraphs.

20 Jan 84

a. Physical Limitations. Some physical limitations on cement grouting effectiveness are:

- (1) The maximum and minimum size and geometry of voids to be grouted.
- (2) The particle size of the cement, bentonite, or other solid constituents in the grout mix.
- (3) The presence of minerals in the groundwater or foundation materials that have a detrimental effect on grout strength, setting time, volume, or permanency.
- (4) The possible noncompatibility of grouting materials used in the mix.
- (5) The presence of clay or other erodible materials in the foundation that cannot be completely removed by washing.
- (6) Settlement of cement particles from suspension in the grout.
- (7) The presence of unknown subsurface features or conditions detrimental to the grouting program.

b. Limitations. Examples of limitations to grouting effectiveness related to field operations and methods include:

- (1) Uplift and damage to foundations resulting from excessive pressures.
- (2) Use of improper drilling and grouting equipment.
- (3) Improper plugging of foundation voids by thickening the mix prematurely or by unsuitable injection methods.
- (4) Improper hole spacing or orientation of grout holes.
- (5) Failure to utilize experienced geological and inspection personnel to supervise and inspect drilling and grouting operations.

2-3. Selection of Methods of Treatment. Grouting is one method of treating subsurface materials to reduce permeability or improve strength and stability. However, other methods of treatment may be required in addition to or in lieu of grouting. As stated, where structural safety is involved, the multiple defense approach will be required. The selection of grouting as the method of treatment should be based on an evaluation of all pertinent aspects of the problem, including engineering needs, subsurface conditions, and economic considerations.

CHAPTER 3
GEOLOGIC CONSIDERATIONS FOR INVESTIGATION AND DESIGN

3-1. Rock Types. The differing properties of various rock types by nature of their origin, lithology, and structure will influence the grouting conditions at a particular site. A thorough knowledge of the rock types present at the site, and their geologic history, is therefore essential for the design and treatment of the foundation. The exploration and grouting programs must be adapted to the site geologic conditions. Different rocks with the same general fracture permeability and void characteristics can be loosely grouped together. Examples of some of the more common rock types are listed, together with those general characteristics that could influence required foundation treatment.

a. Crystalline. Crystalline rock is an inexact but convenient term that identifies igneous and metamorphic as opposed to sedimentary rocks.

(1) Intrusive igneous rocks include granites, syenites, diorites, and gabbros. Some features commonly found in these rocks are sheet jointing, shear zones, dikes, and sills.

(2) Jointing in three directions is characteristic of intrusives. One set is usually near-horizontal (sheet or uplift jointing), and the other two are near-vertical and generally normal to each other. The spacing of sheet joints is frequently close near the surface but increases with depth.

(3) Grout take normally occurs in the joints and the fractures, and the volume is dependent on the size and continuity of the openings along the fractures. Certain metamorphic rocks such as gneisses would react in a manner similar to that of the granites. Grout takes in schists and slates are dependent on the presence and characteristics of associated jointing or fine fracturing. Most quartzites are highly fractured and would readily accept grout. Marble is a crystalline rock but should also be considered in the category of karstic formations since solution cavities should be anticipated.

b. Volcanics. Volcanics generally include the extrusive igneous rocks. Felsites, a group of very dense, fine-grained rocks, are extrusive and near-surface equivalents of granites, syenites, and other related crystalline rocks. In addition to granite-like jointing they may also exhibit columnar structure. Basalts are a group of very dense, dark, igneous rock. The jointing may be platy or columnar. Basalts in many flows commonly exhibit columns with three to six sides. Pumice and scoria are often associated with basalts. Pyroclastics, such as agglomerates and tuffs, are materials formed by explosive volcanic activity and consist of fragments torn loose by such explosions, or deposits of wind-borne ash. Large-scale engineering operations in pyroclastic rocks are generally difficult. Volcanics require extensive examination before engineering characteristics can be determined and will usually require special treatment. The presence of columnar jointing in lava flows tends to lower the

20 Jan 84

strength of the mass as a whole, and extensive grouting can be expected. Permeabilities may be great in lava flows due to the extensive jointing which normally is present and due to the presence of piped vesicles and gas cavities. These features may transmit copious flows of water. In some cases, however, the joints are tight and/or filled and the rock mass may have a very low permeability. Each case must be evaluated individually to determine the need for and effectiveness of grouting.

c. Soluble Rocks. Limestone, dolomite, gypsum, anhydrite, and halite are included in this group. The principal defect in this rock group is solubility in varying degrees that can ultimately cause high mass permeability, slump, collapse, and sinks, resulting in karst topography.

(1) Limestones and dolomites are the most widespread of the soluble sediments. These rocks may be vuggy and may display a wide range of permeability as a unit. Limestone and dolomite are generally jointed and usually exhibit two or three distinct sets of jointing. Solutioning is frequently well developed along bedding planes and joints, and contacts with other rock types. Joints and cavities may be either filled or open and the size may vary greatly. Dependent upon the extent of jointing and cavities, extensive treatment and grouting can be anticipated.

(2) Anhydrite is pure calcium sulfate whereas gypsum is the hydrated form. Both are soft and fairly soluble in water. Both types may be jointed and have a varying number and size of solution cavities. The cavities often are filled with clay or other reworked material. Grout takes depend on the presence and characteristics of the joints and cavities.

(3) Halite (rock salt) is soft and soluble in water. The extremely soluble halite is not found in outcrop but may be found at depth. The principal engineering significance of halite is the effect its presence or proximity may have on the proposed project, such as solutioning and subsidence, in addition to effects on groundwater.

(4) Grouting in solutioned limestone and dolomite often meets with a mixed degree of success. Grouting will frequently dramatically reduce initial seepage. However, the seepage often has a tendency to increase with time after grouting is completed. The increased seepage is attributed to the erosion of void-filling materials that were not adequately removed before grouting. The erosion or piping of this unconsolidated material creates seepage windows in the grout curtain that become progressively larger and more prolific with time.

d. Clastic Sedimentary Rocks. Conglomerates, sandstones, siltstones, and shales are the principal types of clastic sedimentary rocks. The physical properties of sandstone, siltstone, and conglomerate depend on the degree and type of cementation. These coarser clastics may be tight and impermeable, or may be sufficiently porous and permeable to need treatment. Jointing would be

the main concern in impermeable clastics as to need for treatment. The finer clastics, such as claystones and shales, are made up of clay minerals, various oxides, silica, fine particles of ordinary minerals, and some amount of colloidal and organic materials. These clastics may contain a great amount of water. Two shale types are cementation shale and compaction shale. Compaction shales usually contain no joints capable of being grouted. Cemented shales are more resistant to change and have engineering properties superior to those of the compaction type. Cemented to slightly metamorphosed shales are sufficiently brittle to react to structural changes and develop joints similar to those in sandstone.

e. Unconsolidated Materials. Unconsolidated materials include residual overburden derived from the weathering of the parent rock. Residual soils are in situ as opposed to transported sediments. The properties of the materials reflect to a certain extent the properties of the original material. Finer derivations of the parent rock, such as clays and silts, are generally impervious and would not require grouting. However, in certain instances where soluble rocks underlie the overburden, voids or very soft and loose material caused from the collapse of the overburden into the solution channels may require treatment. Transported sediments may include outwash deposits and alluvial deposits generally found in stream valleys, terrace deposits, and most glacial deposits. If the project design does not require removal of these deposits, grouting or other treatment may be required to reduce or control permeability and improve stability. Soil samples should be investigated by laboratory tests for permeability, gradation, and density.

3-2. Structural Geology.

a. Structure. The term "rock structure" refers to the spatial relationships of rocks and their discontinuities, and affects engineering projects in many ways. Folds and faults influence the selection of dam sites, and even such seemingly small matters as the spacing of joints may have an important bearing on the distribution of uplift pressures.

b. Folds. A common type of deformation is folding. The folded rocks often show considerable fracturing along the axis of the fold. The severity of engineering problems is dependent upon the complexity of the fold with relation to the type and geometry of the proposed structures and would include excavation, stability, and leakage problems.

c. Faults. Faults are fractures along which masses of rock have been moved in a direction parallel to the fault surface. The movement may vary from a few centimeters or less to many kilometers.

(1) Faults very rarely show a clean and uncomplicated break. The rocks will normally exhibit folding, fracturing, crushing, and grinding. Sometimes the walls exhibit polished and smoothly striated surfaces called slickensides. The rocks on the opposite sides of the fault surface may occasionally be

broken into angular fragments referred to as fault breccia. In addition to these mechanical effects, faults may result in channels for circulating water or may be impermeable and form groundwater barriers.

(2) Recognition of faults is of great importance because faults represent zones of weakness in the crust of the earth, and the presence of these zones would affect the engineering properties of a site, including seismological considerations, excavation, tunnel support, dam stability, and leakage problems.

d. Joints. Joints are almost universally present and are of considerable engineering importance for that reason. Joints offer channels for groundwater circulation, and joints below the groundwater table may greatly increase water problems. Joints may also exert an important influence on weathering and excavation characteristics.

e. Grouting Considerations. Since many rock types have a low primary permeability but a relatively high fracture and joint permeability, the importance of grouting the structural defects is apparent. The type of structural feature (e.g. fault, fold, joint) will dictate to a large extent the type and extent of excavation treatment and the grouting methods. The spacing and nature of the fractures (e.g. open, weathered, solutioned) influence the type of grout treatment selected, such as consolidation grouting and curtain grouting. The selection of a single-line or multiple-line curtain and the grout hole spacing are also affected. The orientation (dip and strike) of these features in relation to a structure influences the planned angle and direction of the grout holes and the drain holes. The depth of the fractures affects the depth of a grout curtain. The grout holes should intersect all the features, and each inclined or vertical feature should ideally be intersected by several holes at different depths. Faults may be gouge filled and impermeable, thereby forming a barrier, or may be open and carry groundwater. Joints may be filled or open, may have weathered or nonweathered faces, and may intersect and be connected over a wide area. The condition of the joints would affect the drilling, the cleaning, the pressure testing, and the grouting of the hole. Since structural features influence the grouting program so profoundly, the site exploration should be sufficiently thorough to base the design on actual site conditions.

3-3. Geohydrology. Almost all engineering projects are affected by subsurface water. The importance of subsurface water is especially obvious in respect to water retention structures. A thorough understanding of the regional and site specific groundwater conditions is necessary to safely design, construct, and operate these projects. A brief discussion of a few general principles follows. Application of the principles to specific problems such as foundation treatment and grouting can then be determined.

a. Porosity and Permeability. Almost all rocks contain pore spaces to some extent. To be permeable, however, pore spaces in rock must be

interconnected and sufficiently large to allow the passage of water. Most sandstones are both porous and permeable. Shale, on the other hand, has a high porosity but the pores are limited to capillary sizes and water passage through the shale is extremely slow. Although intact shale is porous but impermeable, joints and other fractures permit the passage of water even though the water cannot readily pass through the interior of the joint-bounded rocks. Even in regions where the bedrock is granite or a similarly massive and impermeable rock, water occurs in fractures at least in limited quantities and to some depth. Understanding the nature of the joint system is of crucial importance in areas such as these.

b. Groundwater.

(1) Groundwater is the water in the zone of saturation. The upper limit of this zone is referred to as the water table. The depth to the water table may vary considerably depending on site conditions. The groundwater may be found either in continuous bodies or in several separate strata, and the thickness may vary considerably. Local saturated zones that may occur above the main water table are termed perched water.

(2) Local geology, permeability of the formations, including solutioning and fracturing, and recharge and movement within the zone are factors that affect aquifer characteristics. Any mass of permeable rock material from which a significant amount of water can be recovered is called an aquifer. Aquifers may be unconfined or confined. An unconfined aquifer occurs when the upper limit of the aquifer coincides with the water table, since the surface of the water is at atmospheric pressure. The hydraulic pressure at any level under this system is the same as the depth from the water table to the subject depth and may be expressed as hydraulic head in feet of water. Water under artesian conditions is under hydrostatic pressure and therefore rises in a well. When the pressure is sufficient to bring the water above the ground surface, a flowing artesian well occurs. Water that rises only to an intermediate level is a nonflowing artesian well.

(3) Artesian water also occurs in a similar fashion in jointed bedrock. Certain sets of joints may be more openly developed, and a large amount of water may gather in the joints under artesian conditions. A drill may pass through a few hundred feet of impermeable rock in which the joints are few and tightly closed. When the permeable, jointed zone is reached, the hydrostatic pressure at that depth causes the water to rise. The number of joints, as well as the degree of openness, normally decreases with depth, and the chance of penetrating a water-bearing zone is generally greatest in the upper portion of the bedrock.

c. Springs. Any natural surface emergence of water from a subterranean course is a spring. Many small springs represent water from rain or snow from higher ground that moves under gravitational force to a place of emergence. The course and flow rate of a spring depend on the permeability and structure

of the material through which the water moves. Some springs flow upward with a measurable force, indicating that they are under pressure. Springs are most common in sandstones, cavernous carbonate rocks, vesicular lava flows, and highly jointed or fractured rocks of any kind. Some of the largest springs develop along the borders of karst regions.

d. Water Quality. The quality of the groundwater is primarily due to the mineralogical character of the reservoir rocks and their degree of solubility in water. The groundwater in limestone areas usually contains a large proportion of dissolved carbonates. Rock salt (halite) furnishes a ready source of chlorides, while gypsums and anhydrites supply quantities of sulfates. Water containing humic and other acids, dissolved sulfates, chlorides, and similar chemicals may act corrosively on steel and iron and may be injurious to grout and concrete. Ferrous iron in water may oxidize into an unsightly limonitic stain in certain cases. Iron may also lead to development of growths of iron bacteria. The source of the ferrous iron is generally rocks that contain pyrite or marcasite (iron sulfides). These minerals are common in many shales, especially carbonaceous shales. Water from such sources may also contain hydrogen sulfide. In areas where coal mining has occurred, both ground and surface water may be highly acidic.

e. Grouting Considerations.

(1) Since groundwater conditions have an important effect on design and construction, the regional and local conditions must be studied during the investigation stages so that potential problems may be evaluated. The grouting program should be designed for the existing groundwater conditions as well as for postconstruction conditions. Different methods and procedures may be employed, depending on the formation permeability, the depth to water table, and the type of aquifer present (confined and unconfined). These conditions affect the type of grout, the grouting procedure, the depth and extent of treatment, the spacing of holes, the need for a multiple- or single-line grout curtain, and the pressures that should be used.

(2) Aquifer conditions also have a direct bearing on the need for and type of drainage required. The chemistry of the groundwater should be considered with respect to the materials to be used in the proposed structure and to the grout to be used. Samples should be tested for pH and the chemistry analyzed. Springs in the construction area may require special treatment, including special grouting methods.

3-4. Investigation Methods.

a. Background.

(1) Investigations must be oriented toward identifying both the normal and the abnormal conditions and the discontinuities of even the smallest degree, because these conditions may control the design of the structure.

Special drilling procedures and equipment with detailed attention to the discontinuities and anomalies may be required. Besides the grouting design, the investigations are also used to determine the type and extent of excavation, groundwater conditions, and foundation preparation and treatment required.

(2) The type and scope of the drilling program are determined by the type of the proposed project and by the geology. The staged investigations may emphasize certain geologic features, such as stratigraphy and structure, groundwater investigations, or foundation analysis. Therefore, a variety of investigative methods may be required. These may include seismic and electrical resistivity surveys, core holes of all sizes, noncored holes, calyx holes for in situ foundation inspection, downhole logging techniques, swab tests, pump tests, pressure tests, and borehole photography. Each hole drilled should be designed to give the maximum information possible that is pertinent to the situation.

b. Site Conditions. Since grouting and drainage requirements and procedures are primarily based on geological conditions at a particular site and proposed structure, the exploration program must be comprehensive and accurate. If investigations confirm the presence of certain adverse geological conditions, treatment by excavation, grouting, or relocation of the site may need to be considered. The adverse conditions may include such things as the presence of soluble rocks, evidence of solution activity, prominent open joints, broken or intensively jointed rock, sheet jointing, open bedding planes, faulting, or unusual groundwater conditions. Besides drilling at the site as described in para c., and where no outcrop exist at the site, observations of the same formations should be made at nearby outcrops to get a better feel for joint and fracture spacing, continuity, and openings.

c. Drilling. Specific information on subsurface conditions is needed to plan the grouting program. To determine the scope and to estimate the costs of drilling and grouting operations in rock, information should be available on: overall geologic structure and stratigraphy; orientation, attitude, and spacing of joints; joint openings including type of any filler; boundaries of rock types; location of faults; location of broken zones, depth to sound rock, and position of water table. Sufficient drilling should be performed to delineate the above features. Tools such as borehole and television cameras and geophysical logging instruments should be used where needed to define subsurface conditions. Extensive use should be made of angle holes to give the maximum information possible concerning high angle jointing and faulting, particularly on the abutments where sheet or relief joints often occur. Each hole should be pressure tested and/or pumped to determine not only water take but to isolate the water-bearing or open zones in the hole. Therefore the hole should either be tested as it is drilled or tested by the use of a straddle packer after drilling is completed. If artesian conditions are encountered, these zones should be isolated and tested.

3-5. Test Grouting.

a. General. Field grouting tests prior to detailed design are very important. They provide the most accurate information for designing the complete grout program and for estimating the quantities to be required. The grout test can also be very valuable in evaluating the effectiveness that may be expected from the complete curtain. The grout test can also provide information as to which drilling method is most adaptable to the rock formation to be grouted.

(1) A test performed in each different geologic environment that the construction grouting will encounter is usually advisable if the differences are significant.

(2) The grout test may range from a very simple test of several different grout mixtures pumped into a few holes to determine the amount of each mix that can be injected, to a very comprehensive test that uses observation wells and pump tests before and after to evaluate the effectiveness of the grouting. The type of test selected should be based upon information needed, size of project, and complexity of geologic conditions. The grout test should be supervised in the field by the geologist responsible for designing the final grouting program. Testing should not include rock which will be excavated during the project construction.

b. Single Line Test Curtain.

(1) The simplest grouting test is to drill and grout a line of holes along the proposed grout line. Very careful records should be kept of each operation involved in the test. It is normally advisable to begin the grouting with a thin mixture, such as six parts water to one part cement, then gradually thicken the mixture if the hole continues to take grout. Care must be taken not to inject the hole with a mixture that is too thick and will stop the hole from taking grout prematurely. If this appears to be happening, immediately thin the mixture being pumped.

(2) Grouting of one hole is not an adequate grout test. Geologic conditions are normally far too variable for one hole to be representative. The number of holes used for a grouting test must be based on the designer's judgment and knowledge of the geologic conditions, but normally would include split spaced holes, that is, holes spaced equidistant between previously grouted holes.

(3) The main benefit from a single line grout test is to obtain an indication of the amount of grout the formation will take for estimating purposes and primary and split spacing distances. It also provides design information on drilling and grouting procedures to use.

c. Circle Grouting.

(1) A more comprehensive grout test is performed by grouting an area around a test well. This test will provide all of the information described in b above and will also allow an evaluation of grouting effectiveness by running pump tests before and after in the observation well.

(2) A test should be made with a radius of about 25 feet depending on rock properties. The grout holes drilled around the circumference of the circle should be spaced as planned for the final grout curtain. The holes should be drilled and grouted according to the split-spacing procedures normally followed in grouting.

(3) At least two lines of piezometers should be installed along lines radiating from the test well, which should be drilled at the center of the circle. It is normally of most benefit for a dam project to align the piezometer lines essentially parallel to the anticipated lines of flow from the impounded lake. Good locations for piezometers are one inside the circle, one in the grout curtain, and two outside the circle on each line.

(4) Pump tests should be made before and after the grout is placed. The differences in the permeability between the two tests are a reflection of the effectiveness of the grouting. The test well and the piezometers will sometimes become grouted up during the grouting operation, and reinstallation will be necessary after the grout is placed and before the final pump test is performed.

d. Multiple Line Grouting. A satisfactory grout test may be performed in some cases by drilling two or more lines of grout holes along the proposed grout curtain and a test well adjacent to the grout curtain. The test well should be pump tested before and after the grouting operation. A line of piezometers should be installed across the curtain to measure drawdown before and after grouting. The well or the piezometers may become clogged during the placement of grout, in which case new ones should be installed. Most of the information available from circle grouting tests is also available from this test. Multiple line grouting has the advantage of requiring fewer grout holes and less space to perform the test than required for circle grouting.

e. Observation Wells and Piezometers. Test wells and piezometers are useful in evaluating the effectiveness of the grout curtain.

(1) Well depth should be somewhat less than that of the grout holes. If the well is cored, the core should be carefully logged to note the location of fractured zones. The well should be pressure tested with straddle packers to locate permeable zones in the hole.

(2) Piezometers or observation wells should be installed so that the cone of depression can be established and the permeabilities of the rock

20 Jan 84

formation can be computed for the pumping tests before and after grout placement. The piezometers can normally be installed in smaller diameter holes such as NW (75.7 millimeters in diameter). Their depths, like those of the test wells, should be somewhat less than the depth of the grout holes, since the purpose of the piezometers is to provide an indication of the effect of the grout curtain on the permeability of the rock in which it is installed. The piezometers should be installed so that they are open to most of the column of rock in the hole. It is frequently acceptable to install piezometers by setting and grouting the casing into firm rock, then drilling to the planned depth and leaving the rock portion of the hole in open communication. The casing is left in place to serve as the piezometer pipe. Obtaining a seal between the casing and the rock is very important in this type of installation. This type of piezometer is actually a small-diameter observation well.

(3) A more sensitive piezometer installation consists of a small-diameter porous tube, or wellpoint, approximately 2-1/2 feet long connected to a small-diameter riser pipe. The porous tube, or wellpoint, is set near the bottom of the drilled hole, and sand is placed in the hole below, around, and above the tube. A seal of bentonite pellets is installed above the porous tube or wellpoint. This type of piezometer has two advantages over the open-hole installation described in (2) above: (a) It is considerably less likely to become grouted up during grouting operations because the grout will not travel far through the sand pack, and (b) it reflects changes more quickly in the water table in the surrounding rock because much less storage area is available for water in the hole.

f. Exploratory Holes. Exploratory holes drilled into the grout curtain are frequently advisable to evaluate grout intrusion into the fractures and fissures in the rock. It may be necessary to drill large-diameter core to fully recover grout in the fractures for evaluation. The chemical phenolphthalein ($C_{20}H_{14}O_4$) may be used to identify traces of grout in rock core. The exploratory holes should be pressure tested.

g. Evaluation of Results. Where test grouting is above the existing static water level, drawdown pump tests cannot be used to evaluate results. Consideration of the grout mixtures and pressures used, the reduction of take with split spacing, pump-in test results before and after grouting, and core holes as discussed in paragraph f are the principal methods for evaluation. Geophysical methods have also been used, but are not as reliable. In evaluating reduction of take with split spacing, it is helpful to reduce the data to a "unit take" such as take expressed as cubic feet of grout per foot of drill hole.

h. Determination of Drilling Procedures. One important piece of design information that should be obtained from a test grouting program is an evaluation of the best drilling method to be used to drill the grout holes at that particular site. Rotary and percussion drilling techniques should be

EM 1110-2-3506
20 Jan 84

evaluated. Various grout hole diameters should also be tried and evaluated. If these parameters are established during the test grouting program, they can be specified for the complete program and should eliminate the possibility of expensive contract modifications.

CHAPTER 4
PLANNING AND PROCEDURES

4-1. Considerations. The need for grouting should be determined early in the planning stage of a project and should be governed by the requirements for the particular structure and geologic setting. Grouting to reduce seepage that might have an adverse effect on performance of a structure is the most common design purpose for grouting. Grouting also provides thorough exploration of possible adverse conditions. If foundation seepage is not detrimental to the structure, a deep grout curtain may not be necessary. Economics may dictate grouting to reduce water losses in cases where water is valuable, such as in an upper reservoir of a pumped storage project.

a. Geologic Considerations. Plans for a grouting program should be based on the knowledge obtained during exploratory investigations of the geologic conditions. The design of grouting programs should never be based on a predetermined formula, but should be selected to accomplish the design purpose of the grouting in the geologic setting at hand. Geologic considerations are required from the initial planning stage through the completion and evaluation stages of the grouting program.

b. Program Objectives. The planning of grouting operations and techniques is not only influenced by the subsurface conditions encountered, but also by the purpose and objectives of the grouting program. Is the grouting intended to be a permanent treatment, or is it a temporary construction expedient? Is the tightest cutoff obtainable needed, or is something less than that acceptable? Should the maximum amount of grout possible be injected into the rock regardless of spread, or should an effort be made to restrict the spread to reasonable limits, or should it be restricted to very narrow limits? The answers to these questions and the effects of the often overriding factors of time and cost form the basis for planning drilling and grouting operations. The treatment of a reservoir to permanently store a liquid pollutant is an example of one extreme. Sufficient time and money must be allocated and every effort and decision designed to provide the tightest seal possible, otherwise the project cannot be successful. At the other extreme, a grouting program may be conceived to reduce, but not necessarily to stop, seepage into an excavation during construction as a measure to save on dewatering costs. Time will be a factor if grouting delays other work. Cost is a factor, since the saving on dewatering costs must be a ceiling for grouting costs. Permanence of treatment is not vital in this case, and grouting techniques are directed toward constructing the most effective cutoff possible for a specified expenditure of time and money. The objectives of most grouting operations fall between the examples cited above. The objectives for all grouting should be clearly defined so that the designer, geologist, project engineer, and inspector will understand them and can then contribute to their realization.

4-2. Planning Considerations.

a. After the need for and purpose of grouting has been determined, the planning of a grouting program can begin. Planning should consist of:

(1) Making a study of exploratory investigations and using the information to determine the extent, method, and parameters for the safe and efficient injection of grout into the foundation and that will provide the optimal hole orientations, depth, and spacing.

(2) Determining at what project construction stage the grouting should be done.

(3) Preparing suitable plans and specifications that will represent site conditions and work to be performed.

(4) Estimating drilling quantities and amount of grout materials required.

b. Unforeseen geological conditions may necessitate modification of the grouting program after grouting operations are under way. Therefore, flexibility should be provided as an integral part of planning and should be preserved through the completion of the grouting.

c. Grouting is usually on the critical path of construction, and, with particular weather restraints, there is a tendency to modify or curtail grouting as a construction expedient. Once the determination is made that grouting is a required part of design, it cannot become secondary to any time or scheduling restrictions.

4-3. Quality Management. It is extremely difficult to determine the quality of the end product resulting from a grouting operation. As a consequence, the portions of a construction contract dealing with grouting almost invariably specify a very detailed construction procedure. The specified detailed construction procedure and the difficulty in determining the quality of the post-grouting end product combine to make the grouting quality management program extremely important.

a. Quality of Personnel. Guidance for Corps personnel staffing on Civil Works Construction Projects is contained in ER 415-2-100. Staffing for grouting work shall be with qualified personnel, preferably with key personnel having prior grouting experience. The staff shall include an engineering geologist or geotechnical engineer and one or more technicians qualified to perform the day-to-day supervision of grouting activities. The geologist or engineer shall be experienced in grouting and foundation design. Depending on the complexity of the project other technical specialists may be required. These specialists shall either be assigned directly to the project or be available for prolonged and frequent temporary assignments from other

20 Jan 84

organizations. On large projects, assignments in the early stages of grouting may be arranged so that inexperienced personnel can observe the action and decisions made by an experienced staff. Thus, a competent team can be trained that will operate at maximum efficiency at a later time when the work is in full swing. Some grouting operations, however, may not involve a large organization, and the grouting technician will not have anyone with experience in the peculiarities of this work to whom he can turn quickly for advice and counsel. Only experienced construction personnel should be given such assignments.

b. Grouting Records. Under most contract requirements, the contractor will keep daily records of all items for measurement and payment. These items should be reconciled on a daily basis and agreement reached between the contractor and Government on all measured quantities. Disputes over payment items should be reconciled as soon as possible between responsible representatives of the contractor and the Government. The contracting officer will keep records of all grouting operations, including but not limited to a log of the grout holes, results of washing and pressure testing operations, time of each change of grouting operation, pressure, rate of pumping, amount of cement for each change in water-cement ratio, and other data as deemed necessary. These records are a valuable tool for the evaluation of each step of the grouting program. To facilitate control of the grouting program and provide a graphic picture of the results for review, an up-to-date visual plot of the grouting operations should be maintained. A further detailed discussion of grouting records and reports is contained in Chapter 15.

4-4. Grout Hole Drilling.

a. Location. The location for the grout holes is determined by the type of structure to be grouted, geologic conditions, and purpose of the grouting.

b. Hole Size. The diameter of grout hole selected will be based upon the type and condition of the rock to be grouted and the depth and inclination of the hole. The grout hole required should normally be specified as the minimum acceptable diameter. The contractor may elect to drill a larger diameter hole. Minimum hole sizes normally specified range from 38 to 76 millimeters (1.5-3 inches). Except where percussion drilling is used, the smaller diameter holes may be preferred because of their lower cost.

c. Selection of Minimum Hole Size. Hard rock with widely spaced, relatively clean fractures may be successfully grouted through EW (38 millimeters) holes. Larger diameter holes are required for successful drilling and grouting in rock of poorer quality. Conditions to be considered are rock formations that (1) tend to cave in, (2) contain fractures filled with unconsolidated material, or (3) contain open joints and fractures which may be intruded by drill cuttings. The larger diameter holes will allow the insertion of a wash pipe or tremie pipe in the hole with sufficient space between the pipe and the wall of the hole for removal of cuttings or grout and for washing or

20 Jan 84

backfilling. Larger diameter holes may also be required to produce a straighter hole. Drift due to smaller diameter and more flexible drill rods may be excessive. Other factors affecting minimum hole size include hole depth, anticipated grout mixture, and method of grouting.

d. Spacing. The spacing, as well as the pattern, of grout holes should be based on geologic conditions, the results expected to be obtained, and the purpose for which the grouting is being done. The spacing will be influenced by the characteristics of the foundation and, in the case of curtain grouting, by the hydrostatic head to which it will be subjected. Primary hole spacings should be sufficiently wide so that connections between grout holes do not normally occur. In practice, primary hole spacing commonly varies from 10 to 40 feet. Final spacing between 2-1/2 and 10 feet is common for curtain grout holes. Aside from primary hole spacing and the maximum allowable spacing, however, grout hole spacing cannot be predetermined satisfactorily. The final spacing should be determined during the grouting operations on the basis of the results being obtained from these operations. Holes in curtain grouting, for example, may still take considerable quantities of grout after hole spacing has been reduced to an anticipated minimum interval, and the spacing should be reduced further until the section or area is considered to be grouted satisfactorily. Curtain grout holes on some projects have been spaced as close as 1 foot on center.

e. Depth. The depths to which grout holes are drilled should be governed by conditions in the foundation rock, and for curtain grouting, by the hydrostatic head to which the foundation rock will be subjected. Depths for a grout curtain should be sufficient to minimize seepage and assist in the reduction of uplift and the need for extensive drainage facilities. Where conditions permit, grout holes should bottom in sound, relatively impervious rock. Depths should never be based simply on precedent.

f. Direction. Grout holes for curtain grouting of concrete dams are commonly inclined in an upstream direction, and drilling and grouting is done from a gallery. Inclining the holes allows them to intersect vertical or steeply dipping fractures and joints that would not be intersected otherwise, and holes inclined in an upstream direction provide an adequate separation of the grout and drainage curtains. The direction in which to drill any grout hole should be based on the nature of the imperfections to be grouted, the purpose of the grouting, and the environment under which the grouting is done. Grout holes should be drilled in such a direction and angle as to intersect as many of the imperfections in the rock as possible for the prevailing conditions. Angle or horizontal grout holes should be incorporated in abutments where needed.

g. Types of Drilling. Drilling experience gained during foundation investigations should be considered in the selection of the type or types of drilling to be used in the grouting program. There are different types of

drilling which may be selected for grout hole drilling. Each has advantages and disadvantages.

(1) Rotary drilling. Perhaps the most common type of drilling used in grouting is rotary drilling. Clear water is normally used as the medium for removal of drill cuttings. Diamond bits are usually used to advance the hole. In some cases the bits may be coring bits and in other cases they may be plug bits. In soft rock drilling, drag bits may be used. In those situations where it is especially important to prevent drill cuttings from intruding rock fractures, reverse circulation rotary drilling may be used. This technique is more time consuming and expensive than conventional rotary drilling and should only be specified in those cases where it is required for satisfactory grout injection. An advantage of the rotary drilling method is that it permits ready identification of intervals in the foundation where drilling fluid is lost, thus allowing the drilling to be stopped and the interval grouted before the fracture or fractures become clogged. Another advantage is that the hole can be washed clean after drilling without removal of the drill from the hole. Disadvantages of rotary drilling are that it may be more costly than percussion drilling, and drill cuttings tend to intrude into fractures by the pressure of the drilling fluid.

(2) Percussion drilling. A second type of drilling is percussion drilling. There are several variations of this technique. One method is to use blast-hole type drills with air and/or water as the medium for removing cuttings. A second method is to use a down-the-hole hammer with air as the medium of cutting removal. Both types of drills have been used successfully for grout hole drilling. In cases where it is necessary to drill through a zone or stratum which contains clay or silt that tends to ball up in the hole and block the passage of the air, small quantities of water may be injected into the air stream with a high pressure, low capacity pump. This often greatly improves performance of the drill through these intervals. In some cases it may also be useful to introduce a foaming agent with the water to facilitate removal of clay cuttings. The advantages of this type of drilling are that it is normally less expensive than rotary drilling, hole advance is faster, and there is less tendency to intrude rock fractures to significant depths with drill cuttings in those cases where air rather than water is used as the medium of cutting removal. A disadvantage is the tendency to smear the wall of the hole with cuttings in soft rock types. After the hole is completed it should be thoroughly washed to remove any smeared cuttings. In some cases, fractures in soft rock are filled with cuttings which cannot be removed by washing. Another disadvantage is that circulation losses are usually not apparent where air alone is used, thus eliminating one of the main criteria on which a decision is made to stop and stage grout the hole after encountering a feature which needs grouting. Another disadvantage is the possibility of subjecting the hole to the full pressure of the compressed air should a blockage occur above the bit. These pressures may be capable of lifting or jacking the foundation due to intrusion of air along low angle fractures in the rock. This concern is magnified if the grout holes are being drilled through a

20 Jan 84

completed embankment. Blockages in the hole will subject the embankment to the full air pressure and will probably fracture the embankment fill. The use of air drilling in embankments and their foundations has now been prohibited by the Corps of Engineers (ER 1110-2-1807).

4-5. Types of Treatment.

a. General Considerations. The types of grouting treatment applicable to civil construction fall into one of the following categories: (1) curtain grouting, (2) area grouting (also referred to as consolidation, stabilization, or blanket grouting), (3) tunnel grouting, (4) cavity filling, (5) backfilling boreholes, (6) contact grouting, and (7) specialized applications. Treatment by grouting is an important design feature of many dam and structural foundations. Grouting has also been effective many times as a remedial treatment to correct foundation deficiencies or to repair damage.

b. Curtain Grouting.

(1) Curtain grouting is performed to cut off seepage under dams or other structures, or reduce it to a point that it can be controlled economically by the drainage installations. Control is accomplished by drilling and grouting one or more lines of grout holes in the foundation, usually parallel to the alignment of the dam or normal to the direction of water movement. A barrier to the movement of water in the foundation is constructed by filling the voids or water passageways with grout. In theory, the barrier needs only to be a curtain of moderate width. In practice, however, the barrier obtained will be wider than necessary in some places and levels, and possibly not wide enough at others.

(2) The holes for curtain grouting may be drilled on either a single-line or a multiple-line arrangement. The grouting of a single line of holes will ordinarily provide a satisfactory curtain for concrete dams that are constructed on competent rock. The grout curtain is commonly located as far upstream as possible in these cases. The exact location of the curtain is determined by the type of structure as well as by the foundation conditions peculiar to the sites. The grout curtain for dams constructed on inferior rock may consist of a multiple-line arrangement of grouted holes (Figures 7-1 and 7-2). The holes in adjacent rows in a multiple-line arrangement should be staggered with relation to each other. A triple line curtain should be installed in the following sequence: install either the upstream or downstream line, then the other; and lastly the center line. Distances between lines may vary according to field conditions, but generally will not exceed 5 feet. For embankment dams a multiple line should be considered in the upper zone beneath the impervious core. If solutioned rock is present, or where joints or fissures are fine, closely spaced, and erratic, a multiple-line curtain may need to be constructed to the full depth. A single-line curtain is generally used for rim or upland grouting. However, specifications should be flexible enough to add additional lines of grout holes at any location or depth as determined necessary in the field.

(3) Curtain grout holes may be vertical, inclined, horizontal, or any combination thereof as discussed in paragraph 4-4. Grout curtains under embankment dams are generally located in a cutoff trench close to the embankment impervious core center line. Designs requiring an upstream location must consider the possible need for future grouting and the frequency of high pools blocking access. Locations downstream of the impervious section increase uplift pressures under the core. A good procedure at abutments is to incline the holes with a component into the abutment. Horizontal grout holes are sometimes very effective for grouting high angle fractures of limited vertical extent. The depths to which grout holes are drilled should be governed by the hydrostatic head to which the foundation will be subjected and by the geologic conditions in the foundation such as the depths of impervious rock. Depths for a grout curtain should be such that the seepage path is long enough to offer sufficient resistance to seepage and to prevent the occurrence of high exit gradients near the downstream toe or excessively high uplift pressure under the downstream portion of the dam. Grout holes should bottom in sound, relatively impervious rock where possible. Final depths should never be based on precedent. A rule of thumb often used for preliminary planning of hole depth is two-thirds the hydraulic height of the dam. Foundation rock permeability usually decreases with depth. Grouting done from the foundation surface, such as for embankment dams, should use low or near gravity pressures for the upper zone. Grouting through an embankment is sometimes necessary for remedial or deferred grouting. Special precautions should be taken in these cases to avoid fracturing or eroding the embankment. Grouting through a few feet of fill is sometimes required to protect sensitive materials or for winter grouting to insulate the foundation and the freshly placed grout near the surface. In these cases, a good practice is to remove the fill and perform final foundation preparation after the grouting. Grouting of sensitive foundations is sometimes accomplished before excavation of the final 2 or 3 feet to limit freezing or exposure damage.

(4) Grouting from galleries is normally done after the structure is near completion to take advantage of the surcharge so that higher pressures may be used. Drilling for drains should not be done until after grouting is finished.

c. Area Grouting.

(1) Area grouting usually consists of grouting a shallow zone in a particular area utilizing holes arranged in a pattern or grid. The grouting is done (a) to increase the supporting capacity of the rock or (b) to prevent underflow through weathered or partially disintegrated rock, highly fractured rock, or horizontally stratified rock where curtain grouting would not be sufficiently effective. The grouting operation in the first instance is often called "consolidation grouting." Grouting in the second instance merges into multiple-line curtain grouting. Deeper area grouting is sometimes done to grout specific geologic conditions, such as fault zones, or to consolidate subsurface materials at shafts or deep structures. Area grouting near the surface is usually done with low or gravity pressures; however, where deeper

20 Jan 84

zones are grouted, higher pressures can be used safely.

(2) Area grouting to increase the load-bearing capacity of foundation rock is sometimes used as a means of solidifying seamy but otherwise good rock and thereby decreasing the amount of rock excavation and the amount of concrete backfill. However, the effectiveness of area grouting is questionable under foundation conditions where the seams in the rock are filled with clay, and the clay must be removed before grout injection for consolidation grouting can be effective. Because of the irregular pattern of the seams and the character of the filling material, it is not possible to know how much of the clay actually is removed, and consequently, how effective the grouting has been. It will probably take less time, and may cost less, to excavate broken and seamy rock rather than to treat it by grouting.

(3) Treatment of stratified or seamy rock may result in wasting a large quantity of grout through joints and seams leading away from the foundation area. This waste can be prevented by grouting a line of holes on the periphery of the area at low pressure. Substantial savings may sometimes result from taking these precautions.

d. Tunnel Grouting.

(1) Grout treatment for tunnels may be for backpacking tunnel liners, consolidation of material surrounding the bore, seepage control, contact grouting, or ring grouting. Preexcavation grouting may be required for consolidation and water control. To accomplish grouting after tunnel excavation, imbedded pipes or formed holes are provided through the liner, if necessary. Pressure grouting for backpacking behind cast-in-place concrete liners should not be done until 7 days after the placement of the liner. However, where precast concrete or steel ring liners are used, grouting should be accomplished as quickly as possible after liner placement. A sanded mixture is normally required for grouting behind tunnel liners. Injection begins at the invert and is moved up as grouting proceeds. The final step is contact grouting with neat cement grout at the crown after the liner grouting has been completed and the grout has aged and shrunk.

(2) Ring curtain grouting is a treatment akin to curtain grouting under a dam in that it forms a grout barrier intended to reduce the possibility of water percolating from the reservoir along the tunnel bore. The stage-grouting method usually will produce the best results.

(3) The necessity for grout rings, the number of rings required, and the depth and the spacing of holes in the rings all depend upon the type and the conditions of the rock through which the tunnel is excavated and the anticipated hydrostatic head that will tend to develop seepage through the rock. The rings commonly are located on the extended line of the grout curtain under the dam. Where the rock is fairly tight, however, grout rings may function

more efficiently if they are only a short distance downstream from the control structure location.

(4) The grout rings are formed by drilling and grouting four or more holes equally spaced around the tunnel bore. Split spacing procedures should be used when there is significant grout take. Where multiple ring treatment is required, holes in the alternate rings should be staggered radially. The rings should be as far as practicable from the transverse joints of the lining, especially if the joints do not contain water or grout stops, because leakage of grout from the joints may be difficult to control.

(5) For consolidation grouting or water control the holes generally should extend into the rock well beyond any fracturing that may have been caused by tunnel driving and should intercept as many natural fractures, solution openings, and similar imperfections as possible.

e. Cavity Filling.

(1) Cavity filling is one of the least standardized types of grouting. The effectiveness of grouting a clay-filled cavity is questionable; however, air- or water-filled cavities or large, open joints can successfully be grouted with cement grout. The extent of a cavity is not known after the penetration of a single grout hole. More exploration or drilling may be necessary before treatment can be determined. A thick, tremied grout, grouting of pre-placed aggregate, or other materials requiring specialized mixtures may be required.

(2) When a cavity is encountered in drilling, the hole should be grouted. A sanded mixture is normally required to complete the grouting of the cavity. Intermittent grouting may be necessary.

(3) Intermittent grouting is the process of injecting some amount of grout into the hole and waiting several hours before injecting more grout. Several waiting periods may be necessary. During each injection period the last batch of thick mortar grout injected into the hole should be followed by the injection of water into the hole through the pump system. Grouting should resume, after the waiting period, with neat cement grout before returning to injection of the mortar mix. The amount of grout to be injected during each period is normally a predetermined limit. The maximum amount of grout to be injected into a cavity through a single hole should also be predetermined before considering other procedures.

(4) When refusal is reached, it is assumed that grout has at least filled the portion of the cavity penetrated by the grout hole. Additional grout holes are then drilled and grouted until the desired results are achieved.

(5) If pressures fail to build up or the cavity is obviously too large

20 Jan 84

to grout in this manner, grouting should continue beyond the cavity. Additional exploration, consultation, evaluation, and design of remedial measures can then take place without delaying the contractor. These measures may call for specialized grouting procedures or materials such as foaming agents, positive cutoff diaphragm or formed concrete wall, additional excavation, or some other solution. Tremie or gravity grouting is a method often successfully used to grout cavities or large voids.

f. Backfilling Boreholes.

(1) Backfilling boreholes and grout holes are an important part of the grouting program. These holes may act like relief wells under the reservoir head, and if not properly grouted, they could contribute to seepage and piping. Holes in the rock foundation should be backfilled with grout that has a water-cement ratio of 1.0 to 0.7 and about 4 percent bentonite. A minimum diameter, 1-inch delivery line with a steel section at the end is extended to the bottom of the hole after the line is completely full of grout. Grout is then pumped until it flows from the hole, and the delivery line is slowly withdrawn while pumping continues. If settlement of grout occurs, the holes are topped off or rebackfilled before fill is placed.

(2) The tremie method is also used to backfill holes in embankments or fill; however, the backfill mix in these applications is designed to be more plastic.

g. Contact Grouting. Contact grouting is the injection of neat cement grout at the contact of a concrete structure with an adjacent surface. Contact grouting fills the void at the contact that results from shrinkage. Contact grouting may be done through either header pipes installed for that purpose during construction, or drill holes. The header pipes or grout holes are thoroughly washed before the grouting operation. Grouting pressures may vary but the highest safe pressure should be used. Contact grouting is a sealing operation intended to bring about a fully bonded contact between any concrete or steel structure and the adjacent rock. Shrinkage of the concrete as it sets or deflection of the loaded structure may produce seepage paths along the contact. Contact grouting is advisable where such conditions are critical. This treatment is used most frequently in the abutment areas of concrete dams and in the crown areas of lined tunnels in rock. The grouting is usually done in both instances after the main structure has been completed. A typical piping arrangement for contact grouting is shown in figure 4-1.

h. Soil Grouting. The methods described in a through g, above, were developed primarily for grouting rock, and may or may not be applicable for grouting soil. Soil grouting is usually conducted to reduce or arrest water movement and/or for increasing the bearing load of the soil, to reduce settlement, and to improve resistance of soil to erosion by water and/or rain. The term soil is used here in the broadest sense, and includes unconsolidated granular materials ranging from clays with increasing coarseness through fine,

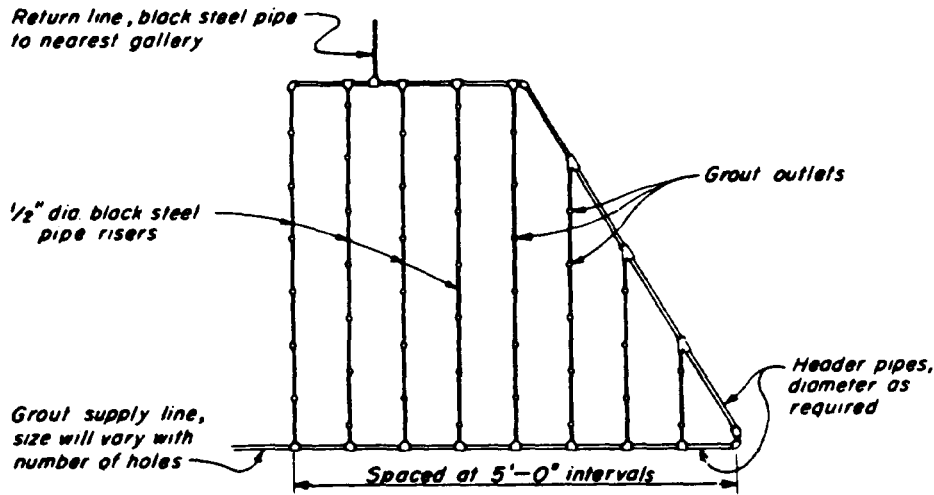

PIPING SYSTEM

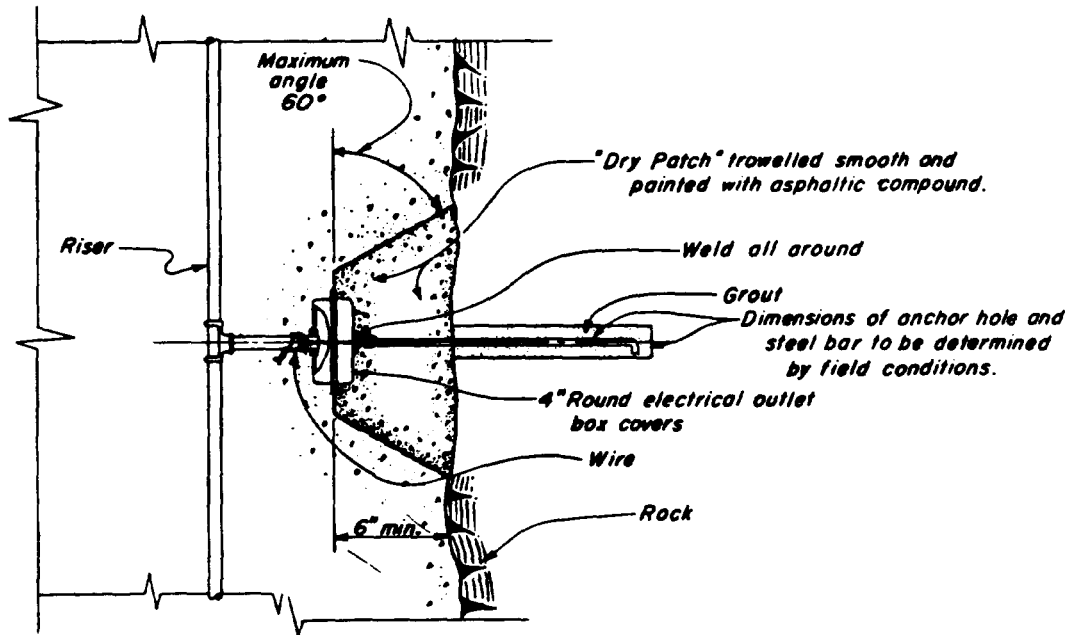

DETAIL OF GROUT OUTLET

Figure 4-1. Detail of contact surface grouting

20 Jan 84

medium, and coarse silts; fine, medium, and coarse sands; and up to and including fine gravels. A method for determining the limits of groutability for the coarser granular soils, i.e., medium sands through fine gravels, is described in paragraph 5-2e. Treatment of fine granular materials, i.e., through coarse silts, is covered in EM 1110-2-3504. Methods of soil grouting are summarized as follows:

(1) Casing. A casing may be drilled, jetted, or pushed to the full depth to be treated and then withdrawn as grout is pumped into the soil. The escape of grout up the contact surface of the casing and the soil may be a problem. This method is used extensively in chemical grouting at shallow depths.

(2) Grout sheath. In this method, a flush-joint grout pipe is grouted in, using a special brittle grout that prevents leakage up the outside of the pipe. The grout pipe is withdrawn a short distance, leaving a brittle grout sleeve below the pipe. Grout is pumped into the soil through cracks produced by the pressure of the grout in the brittle grout sleeve below the end of the grout pipe.

(3) Pierced casing. A patented soil grouting method has been developed in which the casing is grouted in using a special grout. The casing can be pierced at any selected point by firing an explosive-impelled projectile from a device lowered into the casing.

(4) Tubes a manchette. In this method, a perforated pipe is grouted into the hole with a special sleeve grout. The perforations are covered with short sections of a rubber sleeve (manchettes) on the outside of the pipe that act as one-way valves. Perforated sections of the pipe are placed opposite injection locations. A double packer is used to control the treatment location. The pressure on the grout pumped into the hole between the confining packers causes it to push past the small rubber sleeves covering the perforations, rupture the sleeve grout, and enter the soil. This device is suitable for injecting cement, clay, or chemical grout. The same holes and the same rubber-sleeved vents have been used in some instances for the injection of each of these grouts separately and in rotation into a soil. This permits economical treatment of soil containing large voids with an expensive chemical grout by first filling the large voids with less costly clay and cement grout.

(a) Clays and fine silts. Grouts in such materials can only displace the grains by penetrating planes of weakness to form lenses or by compacting the materials by forming grout bulbs. This type of grouting can be conducted using cements or cements proportioned with other fine solids.

(b) Medium and coarse silts and fine sands. Granular material through which water will move with relative ease will accept low viscosity chemical grouts to fill voids and form a more or less consolidated mass.

20 Jan 34

(c) Coarse sands and gravels. High viscosity chemical grouts and highly fluid cement slurries are usually found suitable for injection into such materials.

(5) EM 1110-2-3504 provides detailed information relative to the injectivity limits that may be expected of various types of chemical and portland cement grouts when they are injected into granular materials ranging from nonplastic silt to fine gravel. The limits are also shown in figure 5-1.

i. Specialized Applications. Many specialized applications of grouting are currently in use. A discussion of some of these applications is presented in Chapter 11. It is recommended that for specialized applications of grouting, or for any grouting using admixtures in the grout, laboratory tests be performed on the grout and field test programs be considered. Chemical tests of groundwater or mixing water in areas of suspected mineralized water should also be made, and the results should be used in the mix design.

4-6. Grouting Methods.

a. General Considerations. The best-known grouting methods are stage grouting, stop grouting, series grouting, circuit grouting, and tremie or gravity grouting. In each method the split spacing procedure is followed to determine final hole spacing. Holes for the initial or primary set are drilled at the maximum spacing (10 to 40 feet) and grouted, and the spacing of holes is reduced with each succeeding set until the criteria for completion of grouting are fulfilled. The holes for curtain grouting may be drilled on either a single-line or a multiple-line arrangement (para 4-5). Usually the grout curtain will be divided into horizontal reaches called sections. The length of the section is dependent on individual project characteristics, but may be based on not including more than three or four primary holes. Drilling of grout holes should not be allowed in the same section where grouting is being done, and sometimes not in the adjacent section. The purpose of this restriction is to limit the number of open ungrouted holes that could accidentally be grouted by interconnection and to prevent the disturbance of uncured grout by drilling fluids.

b. Stage Grouting.

(1) In the stage grouting method, progressively deeper zones are drilled and grouted in stages from the top of the grout hole. A stage of drilling is completed either when a predetermined depth of zone is reached or when a specified condition is encountered. A single zone may include more than one stage. Primary holes in a given area are drilled to the first stage of depth, grouting is done at low pressure, and grout within the hole is subsequently removed by jetting or other methods before it has sufficiently set to require redrilling. Similar stages of drilling and grouting are repeated as necessary to reach the bottom of the first zone.

(2) After all first-zone grouting of primary holes in the section or area has been completed and a minimum period of 24 hours has elapsed since the completion of grouting operations in any given hole, intermediate holes, located by the split spacing method, are drilled and grouted to the bottom of the first zone. Upon completion of all holes to the bottom of the first zone and after a 24-hour period, the primary holes are drilled to the next stage in the second zone and grouted at higher pressures. The process of drilling, washing, pressure testing, pressure washing, and grouting at progressively higher pressures is continued until the ground is satisfactorily tight to the required depth.

(3) The shallow zones of the grout curtain are initially grouted under low pressure; however, during grouting of deeper zones under the stage grouting method, the shallow zone is subjected to progressively higher pressures. Theoretically, the zone can withstand the higher pressures because the voids in the shallow zone should have been filled with grout during the low pressure grouting of the shallow zone. Normally, there is little or no intrusion of grout into this zone under the higher pressures used for deeper zones and no foundation lifting. There are exceptions, however, and the grout inspector must be aware of the possibility and must be prepared to stop grouting immediately to prevent heaving of the foundation.

(4) If any stage of a hole is found to be adequately tight as determined by pressure testing, grouting of that stage may be omitted and the hole left open for drilling in the next lower stage.

c. Stop Grouting.

(1) Stop grouting, sometimes called "up-staging," is a method whereby packers or expansion plugs block off preselected portions of the holes while those portions are being grouted. The holes are drilled to their full depth, are pressure tested, and are grouted in successive stops or zones from the bottom up. (An exception to the requirement of drilling the hole to final depth is made when lost circulation or artesian conditions are encountered. In either of these cases, the hole is grouted prior to drilling to final depth.) Packers or expansion plugs are set in the holes at the top of the interval to be grouted, blocking off the higher portions of the holes, and the interval is pressure-tested and grouted. The lowest zone is grouted first. The packers are then raised to the top of the next higher stop, and grouting is repeated. Grouting of holes of any one set (i.e., primary, secondary, etc.) should be completed for all zones in a particular section before drilling of split-spaced holes for the next set is commenced. Grouting pressures are ordinarily reduced with each higher stop because of less cover over the zone being grouted.

(2) Where grout communication from hole to hole is anticipated, a variation of the stop grouting method may be employed utilizing a multiple packer system. Experience has shown that holes grouted by transmission of grout from

20 Jan 84

an adjacent hole or holes are only partially grouted, and therefore incomplete. The multiple packer procedure consists initially of the simultaneous use of individual packers in adjacent holes during pressure testing. The procedure involves testing at least two holes in advance of the hole to be grouted to predetermine the zones of possible grout take ahead of the grouting schedule. (Figure 4-2 shows examples of multiple packer settings under various conditions of water take.) The packers are left in each hole just above the lowest take zone, and the hole is grouted under the maximum allowable pressure for the zone. This allows the header to be shifted from hole to hole and thus increases the effectiveness of the job. This procedure reduces the costly requirement of redrilling and regrouting holes that have been grouted by transmission (interconnection of holes). Knowledge of which adjacent holes accept water or grout is also helpful in determining the bottom hole depth for split-spaced holes.

d. Series Grouting. Series grouting is similar to stage grouting except that each successively deeper zone is grouted by means of a newly drilled hole to eliminate the need for washing grout out of the hole before drilling deeper. Holes at regular intervals are drilled to the depth of the first zone and individually grouted from the top of rock at low pressure. The split-spacing method of reducing the grout hole interval is followed until the uppermost zone refuses grout at the permissible pressure. After the first zone has been completed, another series of holes is drilled into the second zone and grouted from the top of rock at higher pressures, following the same procedure as outlined for the first zone. Additional series of holes may be drilled, depending upon the final depth of grouting required. Maximum pressure is applied to the deepest zone. The justification for using the higher pressures in the deeper zones with this method is based upon the assumption that a blanket or barrier, as provided by the previously grouted zones, prevents the escape of grout through, or the development of uplift in, the shallower zones. Sometimes this does not occur and grout is intruded into the shallow rock under high pressure. If this occurs, the foundation may be lifted and grouting must be terminated or packers used.

e. Circuit Grouting. Circuit grouting requires the use of a double line grouting system. The pump line is attached to a pipe that extends through an expansion plug or packer or special header to within 5 feet of the bottom of the hole. Grout venting from this pipe fills the hole, flows through a second opening in the expansion plug or header into the attached return line, and returns to the grout sump for recirculation. Thus, as soon as the pumping rate exceeds the rate at which grout is injected into the rock, the grout hole becomes part of the grout circulation system. Circuit grouting may be used to grout a hole drilled to full depth as a one-time operation, or it may be used as a modification of any of the other grouting methods described.

f. Gravity Grouting.

(1) Sometimes referred to as tremie grouting, gravity grouting is often

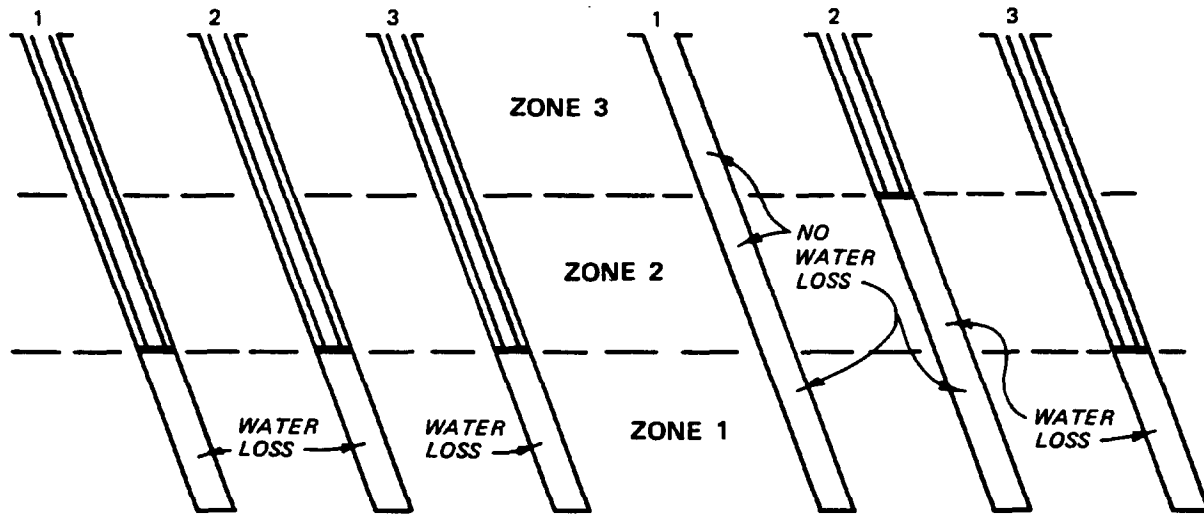

ALL WATER LOSSES IN SAME ZONE - START GROUTING ON HOLE WITH LARGEST WATER TAKE.

ONE HOLE "TIGHT" - TWO HOLES WITH WATER TAKE IN DIFFERENT ZONES - REMOVE PACKERS FROM TIGHT HOLE - START GROUTING ON HOLE WITH DEEPEST WATER TAKE.

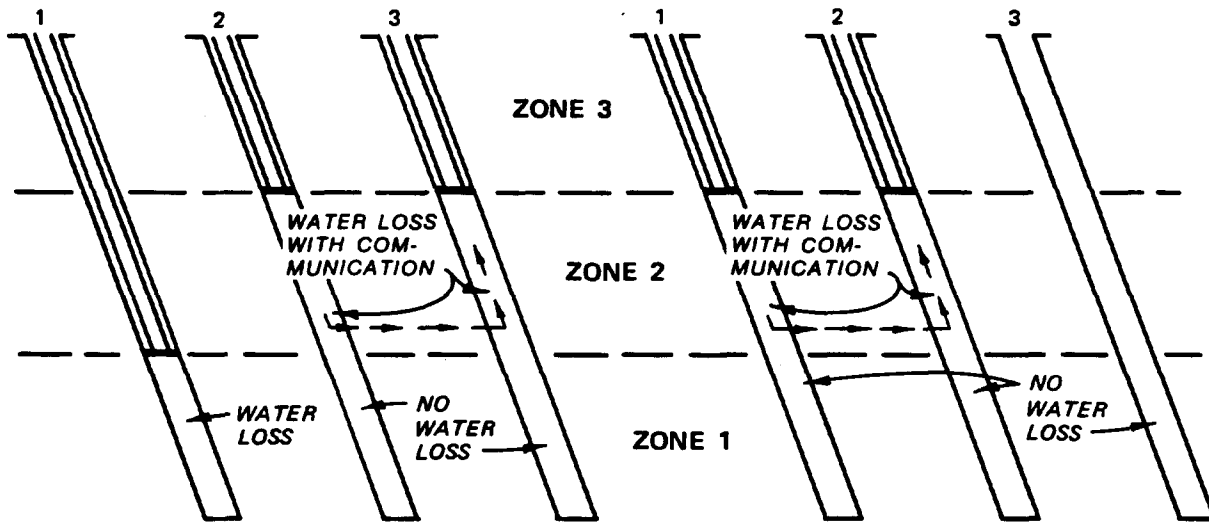

WATER LOSSES IN DIFFERENT ZONES WITH COMMUNICATION BETWEEN HOLES - START GROUTING ON HOLE WITH DEEPEST WATER TAKE - THEN START GROUTING ON HOLE WITH LARGEST WATER TAKE IN CONNECTED HOLES - ZONE 2.

ONE HOLE TIGHT - TWO HOLES WITH WATER LOSS IN SAME ZONE WITH COMMUNICATION. REMOVE PACKER FROM TIGHT HOLE - START GROUTING ON HOLE WITH LARGEST WATER TAKE IN ZONE 2.

Figure 4-2. Examples of stop grouting with multiple packers

used in cases where large, open voids exist which will take grout freely. Examples of this condition are found in soluble formations, basalt flows, and mine cavities. The gravity technique consists of drilling the hole to total depth, lowering a grout pipe to near the bottom of the hole, and pumping in grout under near gravity pressure. When the pressure begins to build up, the grout pipe is slowly raised and the grouting is continued. The procedure is repeated until the hole is completely grouted. The grout pipe should be kept submerged in the grout at all times.

g. Critique of Grouting Methods.

(1) Stage grouting.

(a) Advantages. All stage grouting, regardless of depth of zone, is done from the top of the hole, usually through a short pipe or packer set in the top of the hole. This method eliminates the need for deep packer settings required for stop grouting. A smaller hole can sometimes be used for stage grouting than that for stop grouting since no packer is involved. Stage grouting has a flexibility that permits special attention to be given to almost any local condition encountered, provided the specifications are written to permit payment for the contractor's efforts. Drill cuttings from lower zones cannot clog groutable openings in higher zones. The grouting of all zones is done through a single hole, making drilling costs much less than those for series grouting, which requires a new hole for each cycle of drilling and grouting. Surface rock is subjected to increasing pressures and repeated application of grout from grouting of the deeper zones.

(b) Disadvantages. The principal disadvantage of stage grouting is the danger of lifting or heaving the surface rock when grouting without a heavy confining load. Heaving causes grout waste and may seriously damage the rock and/or any superjacent structure. Lifting occurs at comparatively low pressures when grout is actually injected into and displaces rock near the surface. Thinly bedded, horizontally stratified rocks and highly fractured rocks are easily lifted. A second major disadvantage of stage grouting, as compared to stop grouting, is higher cost. A drill must be set up over each grout hole at least once for each zone in the hole, and grout lines must be connected to the hole equally often. Both items add time and money costs to the job. Connections to grout holes are usually pay items, and more are required for stage grouting. Labor is expended and grout is wasted for each stage of grout hole that is cleaned before deepening. Premature cleanout may result in flowback of the grout injected into the rock, and this grout will also be wasted.

(2) Stop grouting.

(a) Advantages. This grouting method has several advantages: Imperfections disclosed by drilling operations may be isolated by means of the expansion plug and given special treatment. Only one drill setup per hole is required; pressure washing and testing may be concentrated in small segments of

the holes by means of double expansion plugs, thereby improving the efficiency of these operations; cleaning or drilling out holes after grouting is unnecessary, less connections are required, and the method is more economical than the other methods.

(b) Disadvantages. Some disadvantages of stop grouting are: grout sometimes bypasses the grout stops, or expansion plugs, through vertical or near vertical fractures or joints; a tight seal is difficult to obtain with expansion plugs in fractured or broken rock, and in cavernous or solution honeycombed rock; leaks into nearby holes may cause difficulties and may plug fractures and seams and other imperfections in those holes above the zone being grouted; and sizes of holes that can be used for grouting are limited to the sizes of packers or expansion plugs obtainable. Packers are frequently lost due to their becoming grouted into the hole.

(3) Series grouting.

(a) Advantages. The advantages stated for stage grouting (except the last listed) also apply to series grouting. Other advantages of series grouting are that all grouting is done from a new hole in freshly exposed rock, providing maximum exposure of groutable voids, and grout injected into the rock is not lost by poorly timed cleanouts as in stage grouting.

(b) Disadvantages. The major disadvantages of stage grouting, which are the danger of heaving and an increased expenditure of time and money, apply to series grouting also. The increased amount of drilling makes series grouting the most expensive of the methods described. There is a much greater danger of heaving the surface rock with series grouting than in stage grouting.

(4) Circuit grouting.

(a) Advantages. Grout is kept alive in the entire hole until grouting is complete. Thus, small openings occurring below large ones can be grouted after the large openings are filled. Caving holes can be grouted by jetting the grout pipes through the caving zones. Holes can be flushed more thoroughly during the grouting operation in circuit grouting than by any other method. Caving or sloughing materials are removed from the hole by the rising column of grout and later removed from the system by a screen placed between the return line and sump.

(b) Disadvantages. If the packer is set near the top of the hole, the entire hole must be grouted at a sufficiently low pressure to prevent lifting of surface rock. If the packer is set several feet below the surface, the upper part of the rock is ungrouted. A larger hole must be provided to permit installation of the assembly. Excessive time is required to assemble and disassemble grout pipe in the hole. In addition, the cost is higher than for stage or stop grouting.

(5) Combining methods. No large grouting job is likely to be completed using only one grouting method in the strictest sense of the definitions. For example, the drill water may be lost during the drilling of a hole for stop grouting, and drilling must be stopped immediately and the hole grouted. In such cases it can be said that stop grouting is done by stages. In stage grouting if the upper rock is so fractured that it cannot be sealed well enough to withstand the higher pressures desired for the lower zones, it may be necessary to grout the lower zones through a packer set below the fractured rock. This is also a combination of the stage and stop grouting methods. In some cases circuit grouting may be used in fractured zones. A badly fractured upper zone extended over a considerable area may require treatment by a grid of shallow holes grouted by the series or stage methods. The grid forms a grouted rock blanket before stop, stage, or series grouting is continued in the lower zones of the area. Specifications should be flexible enough to permit the use of the method or methods best suited to whatever situation is encountered and should provide a means of compensating the contractor for the work performed.

(6) Selection of method. Stage grouting and stop grouting are the two most common methods of grouting. Service records show that effective results can be obtained by either method. If grouting is delaying another construction operation and time is an important factor, stop grouting should be given serious consideration. If higher pressures are needed in lower zones of the grout hole than near the top, stop grouting is the best suited method. Examples of the latter are reservoir rims, dam abutments, mine shafts or other similar deep excavations, and underground structures grouted from the surface. Portions of grout holes must occasionally be drilled through rock above the horizons requiring treatment. Since grouting the upper rock is unnecessary, stop grouting is well adapted to this situation. If sufficient rock overlies the grouting horizon, the entire hole may be grouted with one stop and with only low or gravity pressure at the collar of the hole. If the surface rock in the grouting area is thinly bedded and has a nearly horizontal attitude, stop grouting is the best method to avoid lifting. A stage of grouting is usually required if the drill water is lost before the hole reaches final depth. Stage grouting should be used to prevent natural muds formed by drill cuttings from shales or similar rocks from filling or obstructing groutable openings at higher horizons. Consolidation of the upper rock may be desirable or necessary before any grouting at depth proceeds, and will necessitate the stage or series grouting method. If grouting the foundation of an existing structure is desired at pressures comparable to the load imposed by the structure, great care must be exercised to avoid heaving and tilting the structure. The danger of heaving is less if the rock is massive or medium bedded, the joints are at high angles, or the strata are steeply dipping.

4-7. Foundation Drainage.

- a. Galleries are generally provided in concrete dams for drilling,

20 Jan 84

grouting, and drainage. Where possible, the minimum size of the gallery should be 8 by 8 feet.

b. In addition to grouting, drainage may be required to control seepage and pressures in foundations or abutments. Foundation drainage features, filters, and other measures act together, or in combination with the grout curtain (if present), to control seepage, reduce pressures, and prevent piping. Foundation drainage features include drilled drains, relief wells, drainage adits, drainage galleries, and pervious drains or filters.

c. Galleries have not been constructed in embankment dams built by the Corps of Engineers but may be considered for future projects.

d. Drainage is one of the most effective means of seepage control. Drains should not be drilled until after grouting has been completed. When grouting is necessary near existing drainage features, caution is necessary to avoid grouting the drains or wells. Effectiveness of the drainage features should be checked after the grouting program, and the drains or wells should be cleaned and/or rehabilitated and new drains or wells provided as necessary.

e. Foundation drains in galleries are frequently inclined downstream to increase the distance between the drains and the grout holes. Drain holes should be a minimum of 3 inches in diameter and may or may not be lined with slotted polyvinyl chloride or metal casing, depending on the geologic conditions and groundwater. Gravel or sand should never be used to fill the hole.

f. Drains in tunnels and abutments may be horizontal or inclined at any angle. If drains are horizontal or inclined upward in shale or other sensitive materials, they should be provided with traps at the collar to prevent air circulation in the hole and should be cased if necessary.

g. Drains should be designed so that they are accessible and can be periodically inspected and cleaned.

CHAPTER 5
GROUT MATERIALS

5-1. Grout Materials.

a. Introduction. The user of portland cement grout must consider two major factors: (1) the compatibility of the individual materials and (2) the intended purpose of each of the constituents. The results of adding various materials to the grout mixture will enable the user not only to develop a wide range of physical properties in the grout but also to make adjustments in the field to meet changes in project conditions.

b. Portland Cements. The most common and best known hydraulic cements used worldwide as the basic ingredient for cement grouts are portland cements. Some of the cements listed below may not be economically available in all sections of the country. The availability of portland cement should be determined before the type is specified. Types of portland cement produced, and those which may be considered for use in grouting applications, are as follows:

(1) Type I portland cement. Type I is accepted as the general purpose cement for use in the vast majority of grouting applications when special properties of other types are not required.

(2) Type II portland cement. Type II is manufactured to resist moderate sulphate attack and to generate a slower rate of heat of hydration than that exhibited by Type I.

(3) Type III portland cement. Type III is used when high early strengths are desired, usually 2 weeks or less. It is considered for use in emergency repairs in instances that require grouting application or phases of grouting applications to be put into service quickly. Since particle size is smaller than in other types, it is sometimes specified for grouting fine cracks.

(4) Type IV portland cement. Type IV generates less heat during hydration than Type II cement. It develops strength at a much slower rate than Type I. It is considered for use in large mass grout placements when high temperatures of heat of hydration are objectionable.

(5) Type V portland cement. Type V is manufactured for use in grout exposed to severe sulphate action. It is used principally when a high sulphate content is present in soils or groundwaters.

(6) Air-entraining portland cement, Types IA, IIA, and IIIA. These types correspond in composition to Types I, II, and III, respectively. These cements contain small quantities of air-entraining materials that are incorporated by intergrinding them with the clinker during manufacture. They are rarely used in grouts and are only considered if a grout may be exposed to severe freezing and thawing conditions.

(7) Oil well cements. Cements manufactured for use in wells are subject to wide ranges of temperature and pressure and consequently differ from the ASTM types that are manufactured for use in a less harsh environment. In meeting well requirements the American Petroleum Institute (API) provides specifications covering eight classes of oil-well cements, designated Classes A, B, C, D, E, F, G, and H. The API Classes A, B, and C correspond to ASTM Types I, II, and III. There are no corresponding API Classes for ASTM Types IV and V.

c. Pozzolans. These materials are siliceous or siliceous and aluminous that in finely divided forms and in the presence of water chemically react with calcium hydroxide of portland cements to form compounds embodying cementitious properties. Pozzolans may be divided into three classes.

(1) Class N. This class includes raw or calcined natural pozzolans, such as certain diatomaceous earths; opaline cherts and shales; tuffs and volcanic ashes, such as pumicites, which may or may not be processed by calcination; and some clays and shales that require calcination to induce satisfactory properties.

(2) Class F and Class C. These are fly ashes that are finely divided residues resulting from combustion processes of ground or powdered coal. Fly ash is the most commonly used pozzolan for grouts.

d. Admixtures. Any material other than water, fine aggregate, and hydraulic cement added to the grout immediately before or during its mixing to alter its chemical or physical properties to a desired characteristic during its fluid or plastic state is classified as an admixture. The principal materials used for these purposes are as follows:

(1) Accelerators. The most widely used accelerator in grout mixtures is calcium chloride (CaCl_2). Generally, calcium chloride can be safely used in amounts up to two percent by weight of the cement. It is mainly used when early stiffening and setting of grout mixtures are desired. Use of calcium chloride in instances where grout may be exposed to cold weather is effective in minimizing the possibility of grout freezing during setting. This accelerator may aggravate sulphate attack, alkali-silica reaction, and in high concentrations, it acts as a retarder. It should not be used when the grout is in contact with steel. Other accelerators include certain soluble carbonates, silicates, and triethanolamine. Granular and flaked calcium chloride can be successfully used if added to the grout by being dissolved in a portion of the mix water.

(2) Retarders. The most commonly used retarders are organic chemicals, most likely lignosulfonic acid salts or hydroxylated carboxylic acid salts or modifications of these additives. Retarders are used to offset the undesirable accelerating effects of high placement temperatures and to prolong grout injection or placement time. A retarder may be required for temperatures above 70 degrees Fahrenheit.

(3) Water reducers. The kinds of materials used for retarders are essentially the same components for water reducers. They increase the pumpability of grout mixtures by increasing their fluidity and increase their strengths by reducing the water content of the mixtures while at the same time maintaining the same degree of fluidity. Water reduction also decreases the permeability and porosity of portland cement grout mixtures.

(4) Aluminum powder. Aluminum powder is sometimes used in portland cement grouts to produce shrinkage compensation or a slight to moderate amount of controlled expansion during the plastic state of the grout. This expansion is a result of the reaction of the alkalis of the cement with the aluminum, which produces a small amount of hydrogen gas in the grout. The amount and rate of the expansion is largely dependent on the temperature of the grout, the alkali content of the cement, and the type, fineness, and particle shape of the aluminum powder used. Unpolished, nonleafing powders of high purity and low grease have been found to be satisfactory in portland cement grouts. The expansion occurs during the fluid state of the grout and is completed prior to final setting of the grout. Two or three grams, or about 1 teaspoonful, of the powder per sack of cement is generally used. Laboratory or field trial mixtures are essential prior to the use of aluminum powder in project work.

(5) Fluidifiers. Fluidifiers in grout mixtures inhibit early stiffening, hold fine particles in suspension, and produce a controlled amount of expansion prior to initial setting. The composition of the fluidifier may include several constituents to produce the stipulated properties. The principal ingredients are usually a gas-generating additive, a retarder, and a dispersing agent. Pumpability of portland cement grout mixtures is improved by the addition of small to moderate amounts of finely ground fly ash, rock flour, pumicites, diatomites, and bentonites. These admixtures, with the exception of most fly ashes, will usually require an increase in mixture water. Trial mixtures should be tested for desired performance characteristics prior to using those materials in field work.

e. Fillers. Sometimes referred to as extenders, fillers are various types of materials used in grout mixtures to replace various amounts of cement, mainly for reasons of economy when substantial quantities of grout are required to fill large voids, trenches, and cavities, and to stem bore holes, shafts, and tunnels.

(1) Filler use. Caution should be exercised in the use of fillers as they tend to increase the setting time of grouts, and in the case of high water content grouts, may result in a high degree of shrinkage and strength loss. Silts and clays require careful selection as they may contain excessive amounts of organic materials. Accelerators and water-reducing admixtures should be considered when fillers are used.

(2) Fine mineral fillers. Rock flour, clay, fly ash, silt, diatomite, pumice, barite, and others are fine mineral fillers.

(3) Coarse fillers. Ordinary sand is the most common of all coarse grout fillers and is usually screened to a desired gradation. Two parts of sand to one part of cement by weight is the practical upper limit of sand content in a grout mixture unless mineral fillers or admixtures are used. Other coarse fillers where strength is not a consideration include shredded rubber, perlite, wood shavings and chips, shredded and chopped cellophane, crushed cottonseed hulls, mica flakes, steel, nylon and plastic fibers, plastic and polystyrene beads, and others.

(4) Mineral fillers. Care is required in the selection of mineral fillers as materials for permanent work. The fillers generally used are sand, rock flour, and fly ash; the latter has become more commonly used in recent years. Trial batches should be conducted when fillers are introduced in portland cement mixtures.

(5) Fly ash. Fly ash may be used both as a filler and an admixture, and in both instances it will produce cementitious properties in the grout mixture when the finely divided siliceous residue reacts chemically with the portland cement. The maximum amount of fly ash should not exceed 30 percent of the cement by weight as a replacement material of the cement if strength levels maintained at approximately the 28-day age are desired.

(6) Diatomite. Diatomite is made up of fossils of minute marine organisms and is composed principally of silica. The fineness of processed diatomite may range from three to 15 times finer than that of cement. It resembles fine powder in texture and appearance. Small amounts improve pumpability in grouts; however, in large amounts as a filler material, a very high water-cement ratio will be required and it can be used only to fulfill job requirements for low-strength grouts.

(7) Pumicite. Pumicite is a processed material produced from the pulverizing of volcanic ash, ashstone, tuff, or pumice. Pumicite serves not only as a filler, but in small amounts, it also promotes pumpability. Pumicite also produces pozzolanic cementitious properties in the mixture. The mixture water demand is higher than that of fly ash but not nearly as high as that required by diatomite.

(8) Bentonite. Bentonite is a montmorillonite sodium base clay often called gel, and has grown in use in recent years to improve the pumpability in grouts. Advantages of using bentonite also include its tendency to reduce shrinkage and to prevent bleeding. Bentonite may also be used as a filler; however, the mixture water demand, like that of diatomite, increases considerably. Strength reductions are consequently quite high. Mixtures using bentonite prehydrated prior to being mixed in the grout require approximately 75 percent less bentonite than those using bentonite introduced as a dry ingredient.

20 Jan 84

(9) Barite. A naturally occurring barium sulphate (BaSO_4), barite has a specific gravity of approximately 4.5. Processed barite resembles bentonite in physical characteristics. Barite has an extremely high water demand which results in low strength development in grouts. Barite can serve as a filler in small to moderate amounts when high density grouts are desirable and low strengths are acceptable.

f. Mixing Water. Water acceptable for drinking is generally accepted for use as the mixture water for grouts. The suspected presence of objectionable impurities, especially those in large concentrations, should be investigated. These impurities include dissolved sodium or potassium salts, alkalies, organic matter, mineral acids, sugars or sugar derivatives, and silts. Water obtained from natural sources "onsite" must be tested (CRD-C 400) and approved.

5-2. Portland Cement Grout Mixtures.

a. Proportioning.

(1) The water-cement ratio in grouting mixtures should be carefully considered. The ratio not only influences strength and workability but also affects pumpability, viscosity, penetration, grout take, setting time, and pumping pressures. A high water-cement ratio may also adversely affect the long-time durability of grouts used in various permanent types of grouting applications.

(2) The volume basis is commonly used in the field for the sake of convenience in that it eliminates batch weighings when precision weighing of constituents is not essential. Mixtures used in the field are frequently expressed as the ratio of the volume of water in cubic feet to one sack of cement having a "loose" volume of one cubic foot. The mixtures may range from 6:1 to 0.6:1 for much field work. Mixtures as thin as 10:1 are sometimes employed in rare cases; however, such admixtures as accelerators, retarders, fluidifiers, and water reducers may be required to modify these mixtures to meet certain job conditions. The volume of fluid grout actually produced by any combination of properly proportioned materials is equal to the sum of the absolute volume of cement plus absolute volume of filler material or significant amounts of admixtures plus volume of water. The absolute volume of one 94-pound sack of cement (using an average specific gravity of 3.15 for portland cement) is 0.478 cubic feet. Usually only approximations are necessary and one sack of cement can be assumed to yield 0.5 cubic foot.

b. Neat Slurries. Mixtures with a high degree of fluidity, which usually contain no sand and only cement and water and small amounts of modifiers that do not appreciably alter the fluidity characteristics of the mixtures, are referred to as slurries. Such mixtures have a very low viscosity and sometimes are referred to as self-leveling, thin, or highly fluid.

c. Foamed Slurries. Sometimes referred to as cellular grout, foamed

20 Jan 84

slurries are used in special applications, such as backpacking, for buried hardened structures that will or might be subjected to impact or dynamic loading. This slurry is also used to protect monitoring instrumentation from shock blast when it is used in tests associated with nuclear or high-explosive testing and as a backfill material as well as a material that can be developed to control rates and amounts of permeability when such permeability is desired. This grout is also used in temporary construction because of its ease of excavation.

(1) Mixture. The slurry is composed of a water-portland cement mixture to which a proprietary foam is added in various amounts to obtain a range of strength and density levels that will result in low stresses and high strains. The foam is provided in liquid form and is transformed using a foam generator. One manufacturer of a foaming product describes his product as a hydrolized, neutralized, stabilized protein foaming agent.

(2) Physical properties. Compressive strengths may range from 50 to 1000 pounds per square inch and densities from 40 to 80 pounds per cubic foot. Type I or II cement is normally used in the neat phase of the slurry. The water-cement ratios normally range from 0.5 to 0.6 by weight.

d. Sanded Grouts. Sand in grouts is used mainly as a filler for reasons of economy. Other benefits include lower water-cement ratios, less heat of hydration, and less shrinkage. The higher the degree of sphericity of the sand, the better the pumpability becomes. Pumpability also increases with the fineness of the sand; however, a higher water content is required. Processed and bank run sands are usually screened over a No. 16 screen; however, they may frequently be used "as is." Natural or manufactured sand may also be used. A series of investigations was conducted by the U. S. Army Engineer Waterways Experiment Station (WES) covering the testing of sanded grouts. Physical characteristics of sanded grouts determined from these investigations are summarized in Appendix D. The investigations have indicated the following:

(1) Two parts of sand to one part of cement can be pumped without the aid of admixtures at normal temperatures.

(2) Small amounts of diatomite appreciably increase the sand-carrying capacity of grouts. Bentonite contents in excess of 10 percent by weight of cement permit enormous amounts of sand in mixtures but result in very little strength development due to their extremely high water demand.

(3) Sand deficient in material passing the No. 100 sieve requires the addition of finely divided mineral admixtures to increase the sand-carrying capacity of the grout. Sand containing as much as 25 percent of fines passing the No. 100 sieve can be successfully pumped at one to three ratios of cement to sand by volume or weight.

20 Jan 84

(4) The addition of fine materials requires increases in water contents when a given degree of fluidity is desired.

(5) Sands manufactured from limestone and traprock can be successfully pumped.

(6) Limestone fines were more efficient pound for pound in promoting pumpability than was fly ash or loess.

(7) When 1.5 parts of fly ash and 1.0 part of diatomite were proportioned to one part of cement by weight in mixtures containing crushed limestone having 10 percent fines passing the No. 100 sieve, 7.5 and 12.0 parts of sand could be pumped, respectively. High water contents and low strengths are also revealed.

(8) The quality of portland cement grout proportioned with 25 percent fly ash by weight of cement did not appear to be lower than similar grout without fly ash.

e. Groutability Ratio. Groutability ratio is an indication of the injectability of solid suspension grouts into granular materials. The "D" size is the designation given to the percentage-passing sieve size of a cement, sand, or gravel. A grout having 85 percent passing the No. 200 sieve is said to have a D_{85} of 74 microns, the sieve opening; and a sand having 15 percent passing the No. 16 sieve has a D_{15} size of 1,190 microns. The Groutability Ratio N is derived from these values and is expressed as D_{15}/D_{85} , which in this instance results in $1,190/74 = 16$. Caution should be exercised in selecting N . The $N = D_{15}/D_{85}$ ratio may be satisfactory in the above case where $N = 16$. Groutability becomes questionable as N approaches 6, which is the value where filtering begins. N generally should be greater than 25 but in some cases may be as low as 15, depending upon physical properties of the grout materials. Figure 5-1 gives a graphic interpretation of this equation. It shows (1) typical grain-size curves for portland cement, Boston blue clay, ordinary asphalt emulsion, and special Shellperm asphalt emulsion, and (2) the lower limits (D_{15}) of sand groutable by the above-described grout materials.

f. Fluid Physical Properties. Fluidity is the major indication of the degree of pumpability or nonpumpability that a grout will exhibit. In addition to stiff and thin, fluidity is expressed in the three following terms. High fluidity is a fluid mixture of the "self-leveling" type, is highly flowable, often referred to as very thin, and is very low in viscosity. Moderate fluidity is a flowable mixture that is described as being within the limits of flowability having a moderate degree of viscosity. Minimum fluidity is a stiff mixture classified as being in the plastic range, exhibiting a few inches of slump, and described at times as being nonflowable or thick. Measurements of fluidity include grouts having time-of-efflux ranging between 10

20 Jan 84

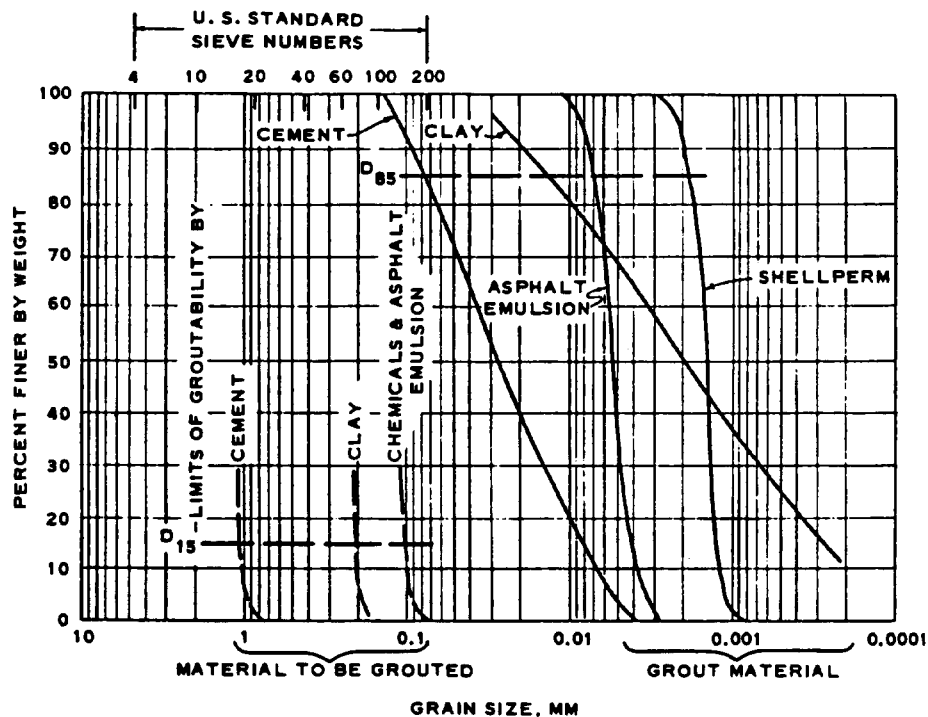

Figure 5.1 Soil and grout materials grain-size curves

and 30 seconds as measured by the flow cone test (CRD-C 611) are usually highly pumpable and range in viscosity from approximately 100 to 10,000 centipoises. The moderately fluid grouts will measure between 125 and 145 flow on the flow table at five drops. These viscosities may range between 10,000 and 50,000 centipoises and have slumps in excess of eight inches. Minimum fluid grouts, stiff and thick, exhibit flow table flows of 100 to 125 at five drops and slumps no greater than eight inches. High and moderate fluidity grouts may be pumped utilizing most types of grout pumps of the nonsurging variety when pressure applications are made; however, minimum fluidity grouts are usually placed in large cavities by using concrete pumps or tremies or may be placed in structural concrete cracks, scoured holes, or similar voids by means other than pumps or tremies.

g. Hardened Physical Properties. Most neat cement slurries having a high degree of fluidity will range in density from approximately 90 to 110 pounds per cubic foot and have compressive strengths ranging from a few hundred pounds per square inch for the conventional moderately thin mixtures to 2,000 pounds per square inch for the thicker type. Flexural strength of grouts will normally range from 10 to 15 percent of the compressive strengths. The modulus of elasticity (E) will be

20 Jan 84

approximately half of that exhibited for concrete of the same level of strength. The moderately fluid grouts usually have densities in the range of 110 to 125 pounds per cubic foot and compressive strengths between 2,000 and 3,000 pounds per square inch, and the minimum fluidity types will have densities ranging from 125 to 140 pounds per cubic foot and compressive strengths between 3,000 and 6,000 pounds per square inch. In critical areas, such as for machine bases, laboratory strength tests may be conducted to determine suitable mixes. Shrinkage, permeability (CRD-C 48), and creep tests may also be desirable.

5-3. Special Cements and Mixtures.

a. Expansive Cements. Expansive cements have become commercially available in recent years principally for use in compensating for normal shrinkage occurring during the first few weeks of curing and hardening of grouts. These types of expanding cements are not to be confused with the expansion obtained by hydrogen, oxygen, or nitrogen gas liberation that occurs in grouts only during the fluid phase. A chemical compound present in expansive cement is an anhydrous calcium sulfoaluminate, which in the presence of lime, calcium sulfate, and water, hydrates to form ettringite and to produce the expansion. The bar method restrained expansion tests (American Society for Testing and Materials (ASTM) C 878) of the cements will range from approximately 0.04 to 0.10 percent. Grout mixtures containing these cements may be used under machine bases or column bases, for bolt anchorage, in concrete cracks, behind tunnel and shaft liners, for borehole and tunnel stemming, and in similar applications where drying shrinkage does not occur to a significant degree. These cements do exhibit early stiffening characteristics; consequently, re-tarding and water-reducing admixtures should be considered.

b. Gypsum Cements. Gypsum cements are generally quick setting, are commonly used for pothole and chuckhole quick repair, and are sometimes selected for use in rock and anchor bolting. Because of their quick setting properties, gypsum cements are sometimes used when temperatures are near freezing. A slight amount of expansion is normal in these types of cements. Caution must be exercised in their use as durability is questionable when they are exposed to aggressive environments (i.e., freezing, salts, high temperatures, wetting and drying). Gypsum cements are available in a wide range of setting times and strengths. Their behavior is quite variable from one brand to another. Gypsum cement is sometimes used as an admixture to accelerate the set of portland cements as well as in small quantities to overcome false set problems that may occur in portland cements. Gypsum cements should be evaluated in the laboratory before they are used, especially if the application will require a degree of permanence. They should not be used for permanent grout curtains in dams.

c. Quick-Setting Cements. Cements that reveal an initial and final setting time of approximately one-half that exhibited by normally setting cements, such as Type I or Type II, are considered quick setting. Gypsum, Type III,

high alumina, and regulated-set cements, the latter containing haloaluminate, are the most commonly used when quick setting is required. High temperature environments will further accelerate the setting time of these quick sets to a point that may approach flash setting. Quick-set cements should be laboratory and field tested prior to use.

d. Fluid and Hardened Properties. Expansive cement, gypsum, and quick-setting cements require somewhat higher water contents than other types as a result of initial hydration, causing early stiffening. All must be batched and placed quickly to avoid setting up in mixers, pumps, lines, or buckets. Generally, the mixtures are initially self-leveling; however, within seconds or minutes, they begin to stiffen and set. Some gypsum cements will develop compressive strengths ranging up to 10,000 pounds per square inch in a matter of a few days. Type III cement grouts normally develop in 7 to 10 days age strengths that Types I, II, IV, and V develop in 28 days age. High alumina and regulated-set cements behave somewhat like Type III; however, they are somewhat quicker setting and higher in ultimate strength development.

5-4. Mixture Adjustments.

a. As noted in paragraph 5-2a the volume of fluid grout produced by any combination of properly proportioned materials is equal to the sum of the absolute volume of the cement plus the absolute volume of filler material or significant amounts of admixtures plus the volume of water. The absolute volume of loose material (e.g. cement, fly ash, diatomite, bentonite, and sand) is always computed from weight and specific gravity:

$$\text{Absolute Volume} = \frac{\text{weight of loose material}}{\text{specific gravity} \times \text{unit weight of water}}$$

and volume of liquids is computed:

$$\text{Volume} = \frac{\text{weight of liquid}}{\text{unit weight of liquid}}$$

b. When it is desirable to maintain a given yield for a grout batch, or to increase or decrease the amount of water or loose materials, the preceding computations must be made in making such adjustments whether such adjustments are made for improving pumpability, for increasing or decreasing strength of grout mixtures, or for possible adjustment of density or other desired physical properties. Strength may not be a controlling factor, as in much subsurface water control grouting, and thinning and thickening of the basic mixture may therefore be required to obtain the desired grout take at any given location of a downhole injection.

c. Figures 5-2, 5-3, and 5-4 are charts including portland cement content of mixtures, and portland cement thickening and thinning, respectively. For either thinning or thickening, the cement content of a given volume of

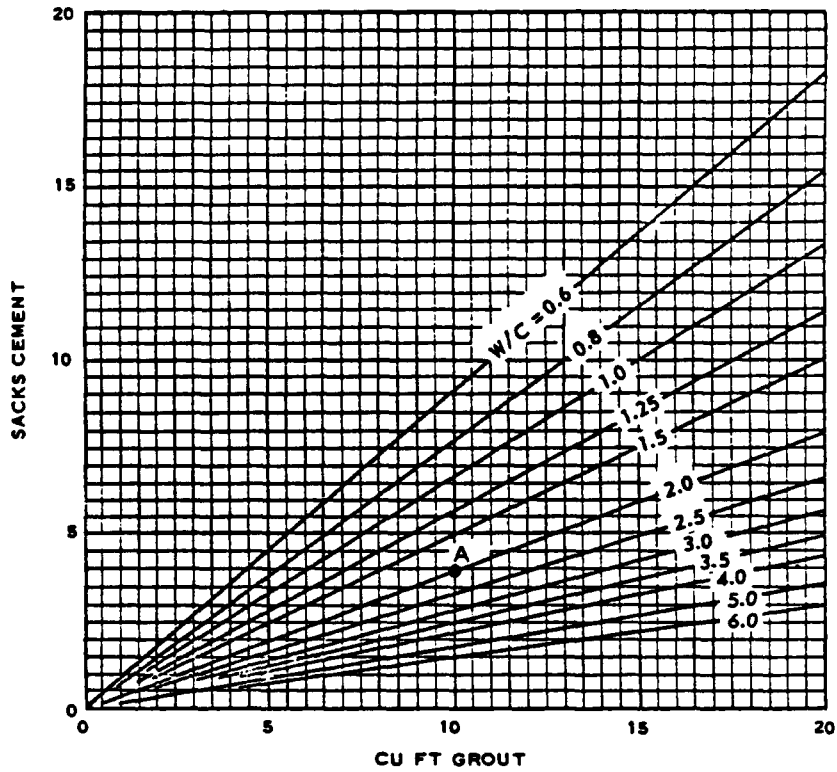

EXAMPLE: 10 CU FT OF 2.0 W/C GROUT (A) = 4.0 SACKS CEMENT.

NOTE: WATER-CEMENT RATIO (W/C) = CUBIC FEET WATER + SACKS OF CEMENT.

Figure 5-2. Cement content of portland-cement grout mixtures

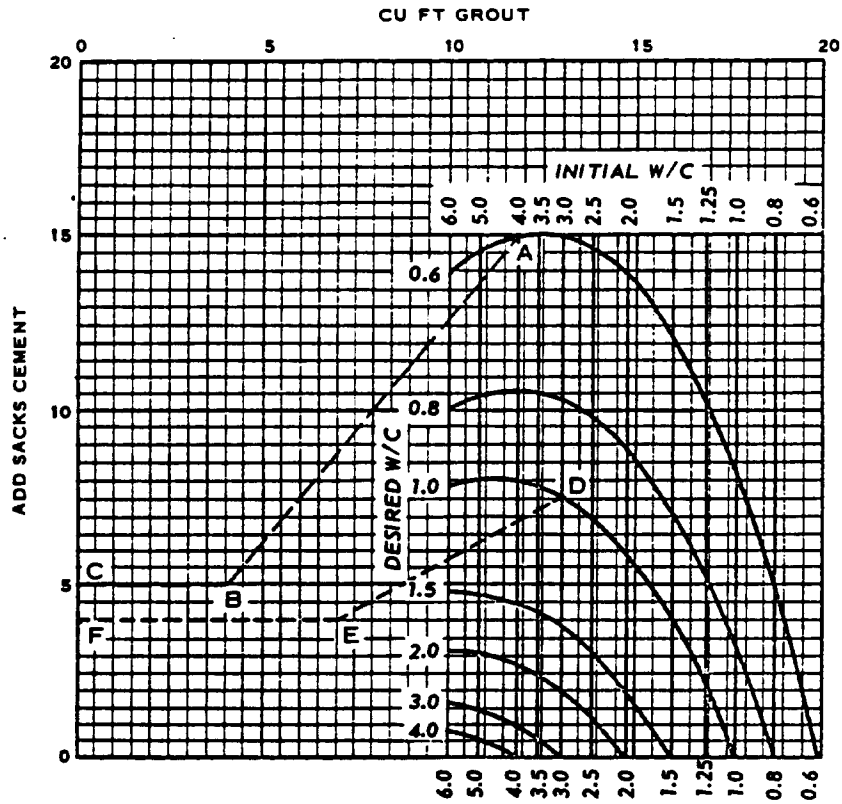

EXAMPLE 1: CEMENT REQUIRED TO THICKEN 4.0 CU FT OF 4.0 W/C GROUT TO 0.6 W/C (ABC) = 5.0 SACKS.

EXAMPLE 2: CEMENT REQUIRED TO THICKEN 7.0 CU FT OF 3.0 W/C GROUT TO 1.0 W/C (DEF) = 4.0 SACKS.

NOTE: WATER-CEMENT RATIO (W/C) = CUBIC FEET WATER + SACKS OF CEMENT.

FOR DETERMINATION OF QUANTITY OF CEMENT TO ADD, LAY STRAIGHTEDGE FROM POINT OF INTERSECTION OF DESIRED WATER-CEMENT CURVE AND VERTICAL LINE REPRESENTING INITIAL WATER-CEMENT RATIO TO POINT 0 AT LOWER LEFT-HAND CORNER OF CHART. READ AMOUNT OF CEMENT TO ADD ON LEFT SIDE OF CHART OPPOSITE POINT WHERE STRAIGHTEDGE INTERSECTS VERTICAL LINE REPRESENTING CUBIC FEET OF GROUT TO BE THICKENED.

Figure 5-3. Portland-cement grout thickening chart

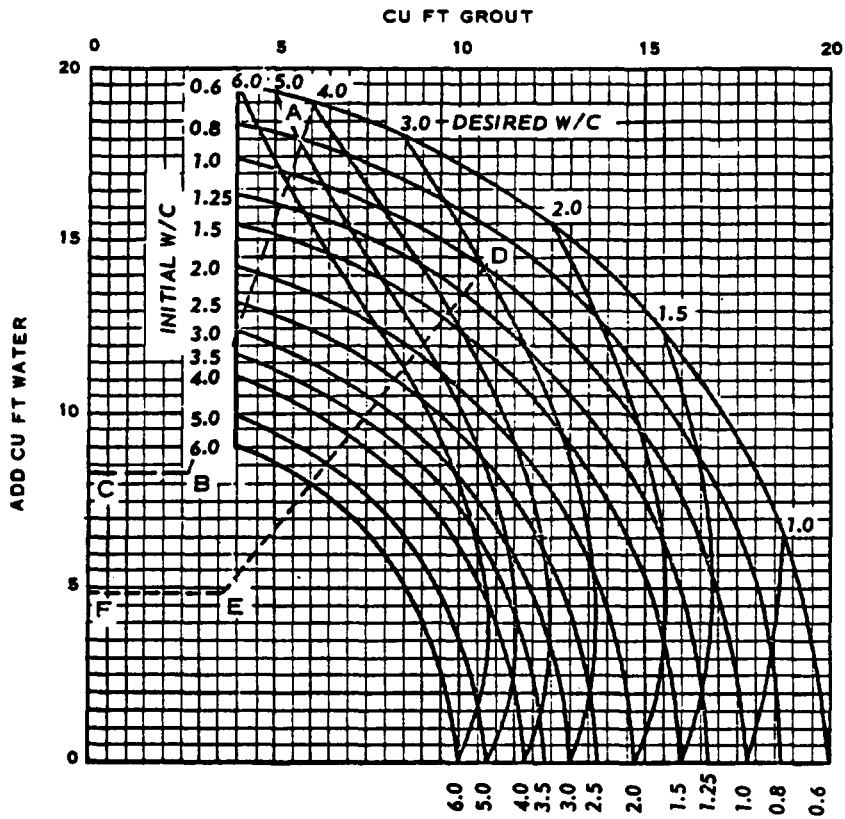

EXAMPLE 1: WATER REQUIRED TO THIN 2.7 CU FT OF 0.6 W/C GROUT TO 4.0 W/C (ABC) = 8.3 CU FT.

EXAMPLE 2: WATER REQUIRED TO THIN 3.7 CU FT OF 1.0 W/C GROUT TO 3.0 W/C (DEF) = 4.9 CU FT.

NOTE: WATER-CEMENT RATIO (W/C) = CUBIC FEET WATER + SACKS OF CEMENT.

FOR DETERMINATION OF QUANTITY OF WATER TO ADD, LAY STRAIGHTEDGE FROM POINT OF INTERSECTION OF INITIAL AND DESIRED WATER-CEMENT RATIO CURVES TO POINT 0 AT LOWER LEFT-HAND CORNER OF CHART. READ AMOUNT OF WATER TO ADD ON LEFT SIDE OF CHART OPPOSITE POINT WHERE STRAIGHTEDGE INTERSECTS VERTICAL LINE REPRESENTING CUBIC FEET OF GROUT TO BE THINNED.

Figure 5-4. Portland cement grout thinning chart

20 Jan 84

grout is first determined. The cubic feet of grout is divided by the cubic feet of grout obtained from a one-sack batch, based on the absolute volume of a sack of cement being approximately 0.5 cubic foot.

EXAMPLE: Find the number of sacks of cement in a 12.6-cubic-foot batch of 4:1 grout and in a 12.6-cubic-foot batch of 0.75:1 grout.

For 4:1 mixture

$$4 \text{ (cubic feet of water)} + 0.5 \text{ (solid volume of 1 sack of cement)} \\ = 4.5 \text{ cubic feet. } 12.6 \div 4.5 = 2.8 \text{ sacks of cement}$$

For 0.75:1 mixture

$$0.75 \text{ (cubic foot of water)} + 0.5 \text{ (solid volume of 1 sack of cement)} \\ = 1.25 \text{ cubic feet. } 12.6 \div 1.25 = 10.1 \text{ sacks of cement}$$

d. The measured thinning of a grout requires the addition of cubic feet of water equal in number to the number of sacks of cement in the grout to be thinned multiplied by the difference between the figures representing the water in the water-cement ratios for the grout on hand and the mixture desired.

EXAMPLE: Determine cubic feet of water necessary to thin 7.2 cubic feet of 1:1 grout to 3:1 grout.

There are 4.8 sacks of cement in 7.2 cubic feet of 1:1 grout
($7.2 \div 1.5 = 4.8$).

The difference between the figures representing the water in the water-cement ratios of the two mixtures (3:1 and 1:1) is 2. The amount of water needed to bring 7.2 cubic feet of a 1:1 mixture to a 3:1 mixture is 9.6 ($2 \times 4.8 = 9.6$).

e. The measured thickening of a grout is accomplished by subtracting the absolute volume of the sacks of cement in cubic feet from the cubic feet of grout to obtain the volume of water in the grout. Cement is then added to give the desired water-cement ratio with this volume of water. The adjustment should be made to the nearest whole sack so as to simplify batching operations. The following is an example of thickening:

Thicken a 5.6-cubic-foot mixture to a 1:1 mixture.

Mixture contains 4.8 cubic feet of water and 1.6 sacks of cement. Required are 4.8 cubic feet of water and 4.8 sacks of cement for producing a 1:1 ratio. The addition of 3.2 sacks could be made; however, to avoid fractions of sacks of cement during batching, add 0.8 cubic foot of water and 4.0 sacks of cement.

5-5. Chemical Grouts.

a. General Statement. Chemical grout provides the construction

industry with a variety of benefits that are a result of improved gel-timing injection control and extended injectivity limits as well as increases in the strength development of various systems. Chemical grouts may be defined as true solutions composed of two or more chemicals that react to form soft, flexible gels, and semirigid and hard rigid gels.

b. Application Areas. Most chemical grout systems (e.g., acrylamides, silicates, and lignins) are used to increase the mass strength of soils and in subsurface water control. The great majority of applications are associated with foundation work. Epoxy and polyester resins are used not only in shallow crack repairs in concrete and rock but also for the emplacement of rock bolts and anchors. Water-base resins, somewhat higher in viscosity than acrylamide and silicate types but much lower than the viscosities common in portland cement grout, may be considered for grouting medium sands and coarse silts. Caution should be exercised in the use of chemical grouts since various systems have toxic and caustic constituents. Environmental restrictions may eliminate the use of certain chemicals for many grouting applications.

c. Self-Contained Systems. Self-contained two-component systems that could be classified as chemical grouts have recently become available. These systems are designed primarily for the anchoring of tendons, rebars, and rockbolts.

d. Reference. Engineer Manual EM 1110-2-3504 should be used as a guide when the use of chemical grouts is being considered. The manufacturer of those systems that appear to meet job requirements should be contacted for verification. Consideration should be given to conducting laboratory and field evaluations of the system or systems being considered as likely candidates for a given application.

5-6. Asphalt Grouts. Asphalt grouts have occasionally been used in successfully sealing moderate to large subsurface water flows in rock channels where cement grouts failed, or where the use of cement grout was not considered practical because of the configuration of the area to be grouted and the volume and velocity of the water flow. Hot asphalts and asphalt emulsions have been used to form barriers to water flow. Hot asphalts are generally heated to approximately 400° F when used for grouting. Care should be exercised in maintaining the heating temperature of a hot asphalt system below its reported flash point. Asphalt emulsions, immiscible in water, are applied cold and are suspended in water in colloidal form. Special chemicals are added to the mixture to cause "breaking," which brings about flocculation and subsequent coagulation in forming an effective grout. The control of coagulation time is an important factor to ensure that the proper amount of coagulation occurs at the proper time at the desired subsurface location.

5-7. Clay Grouts. Fine clays are useful as fillers in lean portland cement grouts. Benefits derived from their use include improved pumpability, injectivity, and economy. The two principal types of clays employed in grouting

EM 1110-2-3506

20 Jan 84

work are montmorillonite and kaolin. Attapulgite is a third type that is used in salt domes and in seawater grouting or other areas of application where moderate to high saline conditions are present. Bentonite is used in grout mainly because of its gel swelling properties, which are not exhibited by kaolin.

CHAPTER 6 EQUIPMENT

6-1. Introduction. Guidance for selecting or approving the specialized equipment necessary for a grouting project is provided below, and operational principles for the equipment are outlined and related to job requirements. Additional guidance for selection of drilling methods is contained in paragraph 4-4.

6-2. Drilling and Grouting Equipment.

a. Drill Rigs. In the selection of a drill, site considerations and job drilling/grouting requirements dictate the type and size of drill to be used. Drilling from the surface may require either a crawler, wheel, or skid mounted unit. On steep abutments a post drill which attaches to the grout nipple may be the only feasible choice, and may be suitable for other drilling. A multi-purpose drill embodying auger, rotary, and rock coring capabilities is desirable (fig. 6-1). The size of drill is dependent on the depth and size of holes and the type of formation drilled. Additional requirements may include stable outrigging and a highly visible and centralized control panel. Drilling from within an adit, tunnel, shaft, gallery, or buried structure usually requires small, lightweight, and compact type drills (fig. 6-2 and 6-3). Fast rod coupling, 360-degree angle drilling, self towing, and multiple power options are major considerations for subsurface drills. Comparisons between drilling methods and equipment are discussed in paragraph 4-4.

b. Percussion Drilling. Percussion drills are operated by air- or hydraulic-driven hammers. The best known types are the jackhammer, the drifter, and the wagon drill. The drill proper consists of a hollow steel rod, which is fitted with a fixed or detachable bit on one end and a shank on the other.

(1) Operation. Percussion drills are used for drilling in rock. The percussion drill does not reciprocate. The shank fits loosely into the chuck at the forward end of the machine, where it is struck by a hammerlike piston actuated by compressed air or hydraulic fluid. The air compressor capacity necessary to operate a single-hammer drill ranges from 50 to 200 cubic feet per minute, depending upon the size of the drill cylinder and the pressure at which air is supplied. The bit remains in close contact with the rock at the bottom of the hole at all times during drilling except during the slight rebound caused by impact of the hammer. Drills are provided with a mechanism that causes the drill steel rod to rotate between blows of the hammer. Cuttings or sludge materials are removed from the hole by air or water that passes through the machine and down the hollow steel drill rod to the bottom of the hole, and then rises up the hole to the surface. Removal of cuttings by water is sometimes preferred for grout hole drilling but is not mandatory in all cases. In some instances, it may be desirable to remove cuttings by

EM 1110-2-3506
20 Jan 84

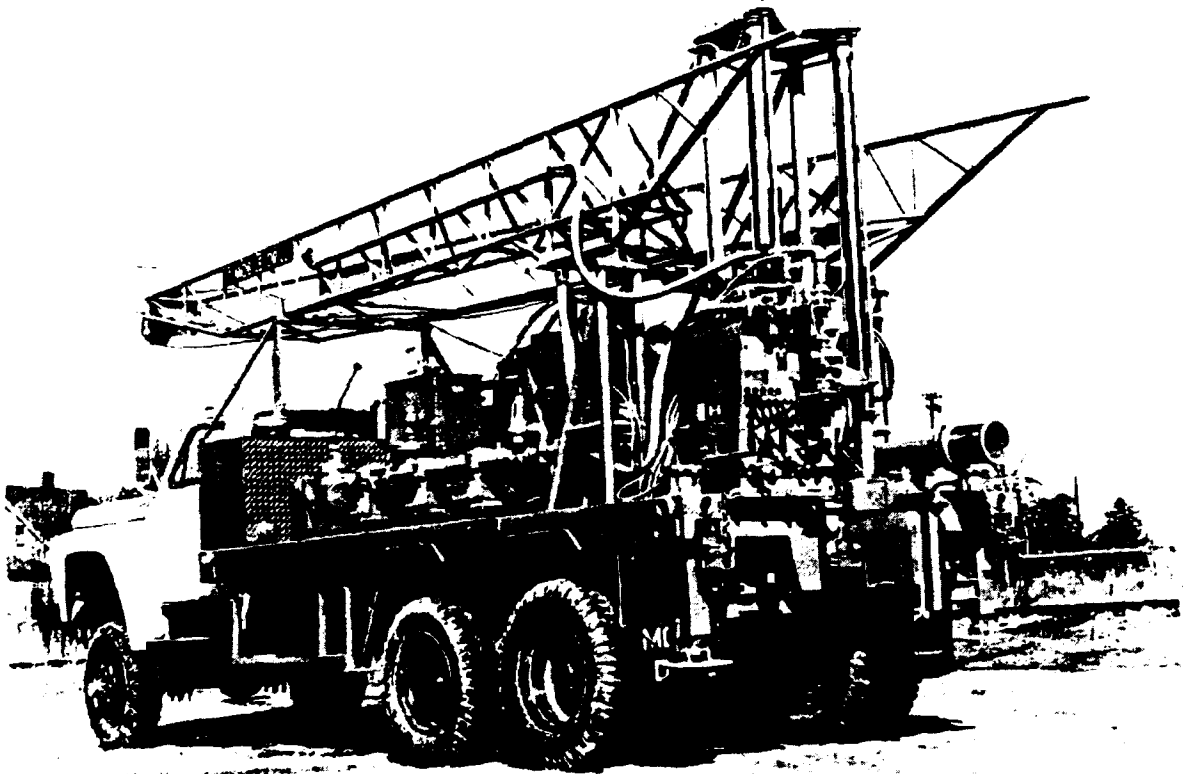

Figure 6-1. Typical truck-mounted drill rig (permission by Mobile Drilling Company)

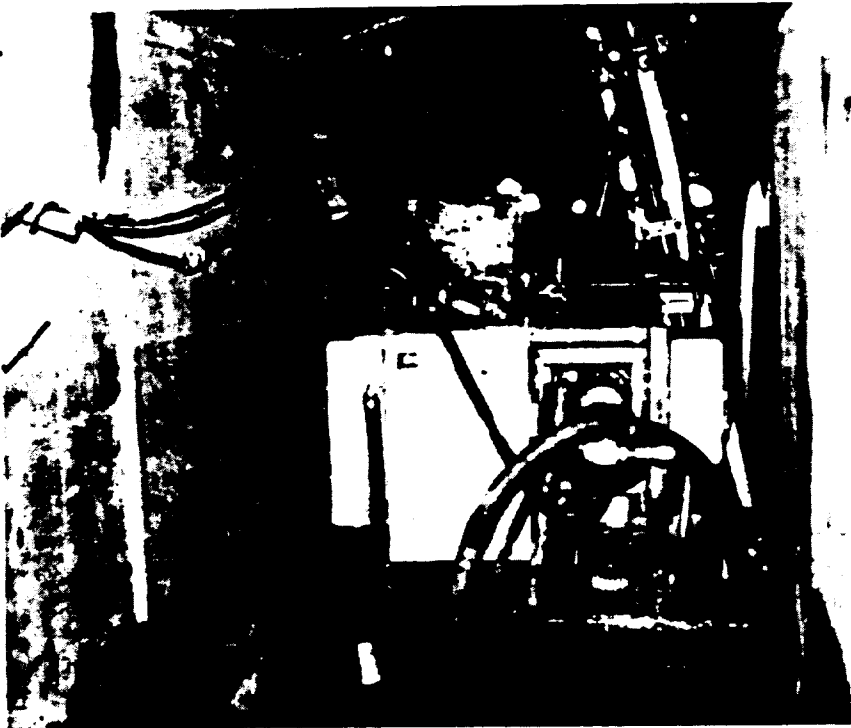
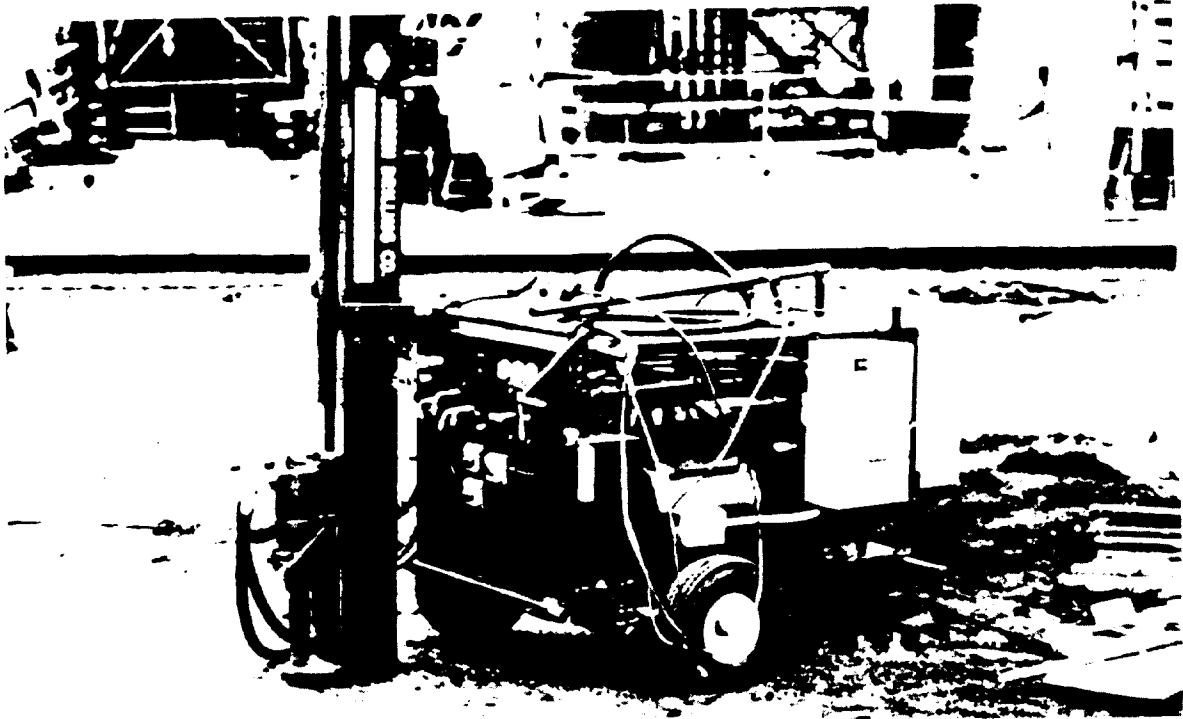

Figure 6-2. Electric over hydraulic drill rigs for gallery grouting

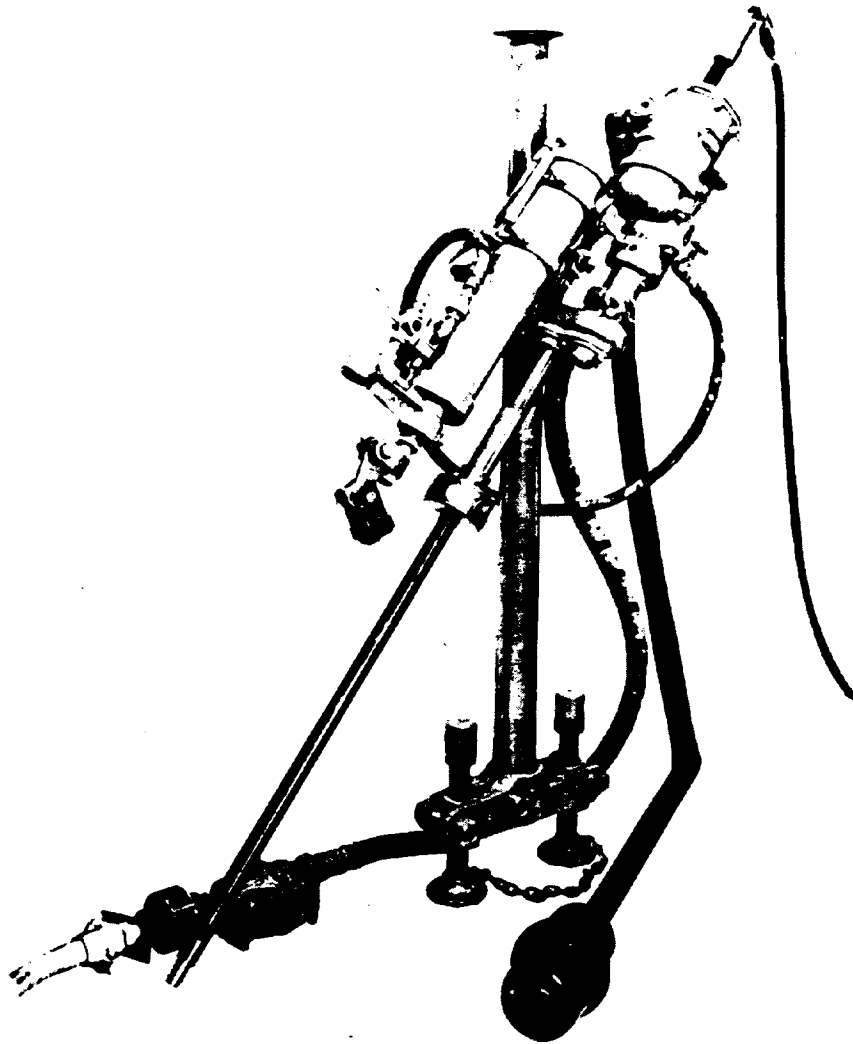

Figure 6-3. Post drill

air. Jackhammer drills are only suitable for shallow work, and due to their light weight, are usually held in position by hand. Drifter-type drills are designed for tripod, bar mounts, or jumbos. The commercially available wagon drill is composed of a drill head mounted in leads that are supported on a track, wheel-, or skid-mounted chassis (fig. 6-4).

(2) Application. Generally, percussion drilling produces acceptable grout holes and is the most economical method of drilling shallow holes. This advantage decreases with depth. The edges or wings of the bit wear away during the drilling operation, and a progressively smaller hole is drilled.

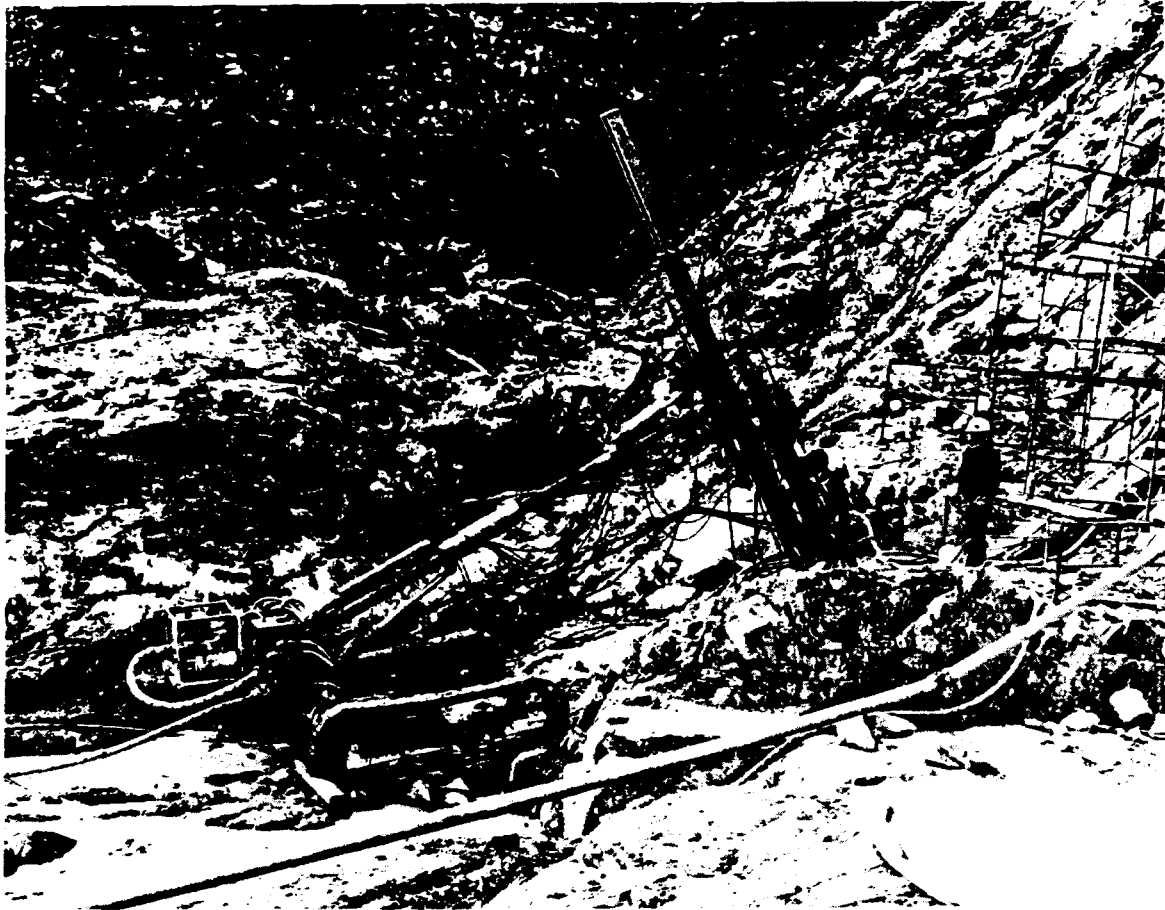
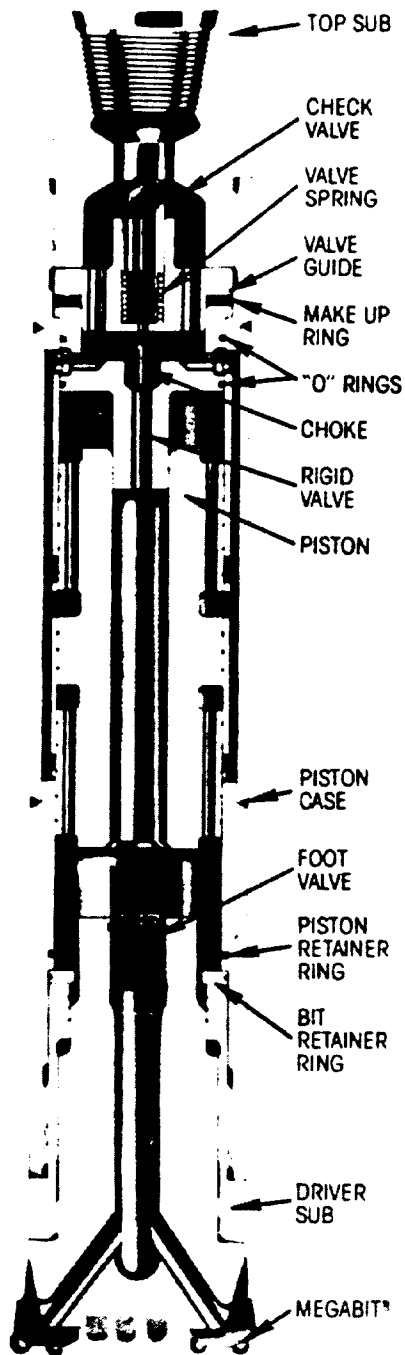

Figure 6-4. Air Trac drill

Therefore, contract specifications should state the minimum acceptable size of grout hole whenever size is a pertinent factor, and provide the method for checking hole size.

(3) Down-hole hammer. Air activated bottom-hole-hammers are used in most types of rock strata. These hammers can be used on most drills that can be slowly rotated and have slow and closely controlled down-hole feed. The hammer air exhaust is released at the bottom of the hole. Cuttings are blown from the hole by exhaust air which cools the bit. The hammer is a versatile tool for the drilling of rock sockets and blast holes in hard rock (fig. 6-5).

c. Rotary Drilling. Rotary drilling is the process of making a hole by advancing a drilling bit attached to a rotating column of hollow drill pipe. The drill pipe is turned by a motor at speeds ranging from approximately 200-300 to 3,000 rpm or more. Pressure on the bit is applied hydraulically or



PREPARATION FOR DRILLING

PRINCIPLES OF OPERATION

The piston is the only moving part during operation of the Megadril®. (See Figure 1) The piston's up-and-down strokes are controlled by the flow of high-pressure air through the case.

With bit in extended position
(tool off bottom)

The Megadril® is designed to pass full air volume when off bottom, in order to blow water from the hole or to accelerate periodic cleaning of the hole.

Figure 6-5. Down-hole hammer

mechanically. Water is forced through the drill pipe to wash cuttings out of the hole. Drill rigs vary in size from small, lightweight machines capable of drilling holes only a few hundred feet deep to large rigs that can drill holes miles in depth. The small rigs are usually satisfactory for grout hole drilling and are desirable from the standpoint of portability. Drill bits adaptable to a great variety of subsurface conditions are available. Some of the common types are shown in figure 6-6 and are discussed as follows:

(1) Diamond bits. Diamond bits may be either a core or a plug type. Both types employ a diamond-studded bit to cut the rock. The bit is cooled and the hole is continuously cleaned by water or compressed air pumped through the drill rods.

(a) Core type. The core-type bit consists of a hollow steel cylinder, the end of which is studded with diamonds. The bit is fitted to the lower end of a hollow steel chamber (core barrel) that is rotated rapidly while the bit is held firmly against the rock so that the diamonds cut an annular channel in the rock. The rock that lies within the channel and projects into the barrel constitutes the core.

(b) Plug type. Two varieties of plug bits are available commercially. One is a concave type, the head of which is depressed toward the center; and the other is a pilot type and has a protruding cylindrical element that is smaller in diameter than the main bit head. Noncoring diamond bits have a wide field of usefulness in foundation grouting. However, plug bits are more costly than coring bits for drilling in extremely hard foundations and in badly fractured rock because of greater diamond cost. Since plug bits produce only cuttings, more diamonds are required to make a given footage of hole than if a large part of the rock encountered is removed as core. The loss of one or two diamonds from the center of a noncoring bit occasionally occurs when shattered rock is drilled and renders the bit useless for further cutting. Except where wire line is used, the plug bit may be less expensive to use than the core bit in deep holes due to the time saved by not having to pull out of the hole to empty the core barrel or to clean a blocked bit. A commercially available bit utilizing polycrystalline diamond blanks has proven very effective. Penetration rates reportedly two and three times greater than tungsten carbide and surface set diamond drill bits, respectively, have been obtained.

(c) Size. The sizes of diamond bits are standard and are generally shown by the code letters EW, AW, BW, NW. The dimensions of each size are presented in the tabulation that follows. Most diamond-drilled grout hole sizes are EW or AW.

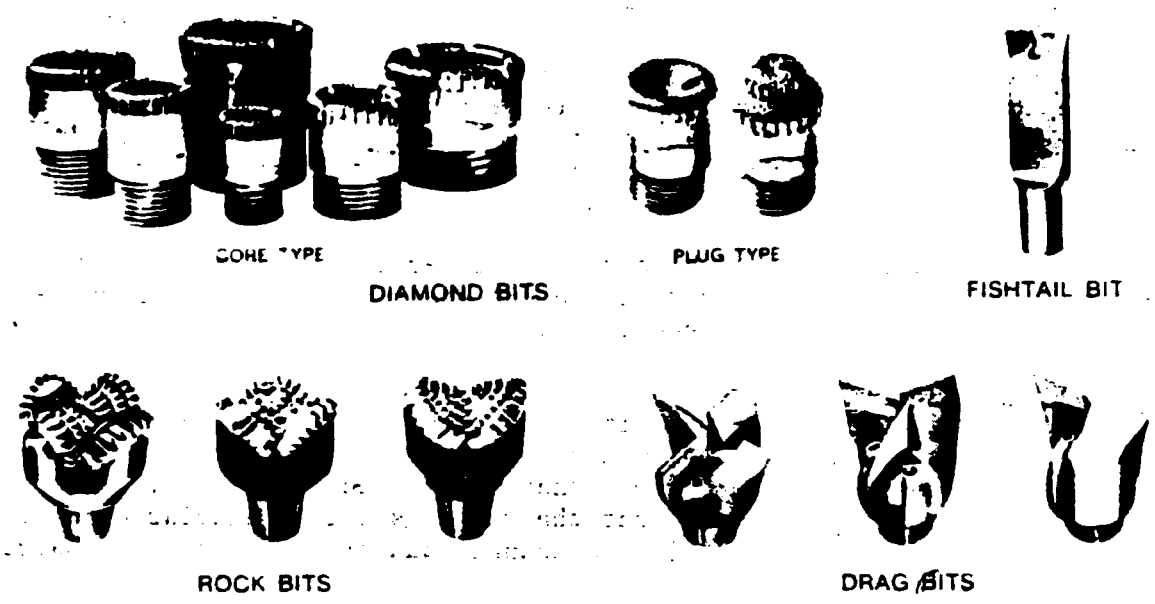

Figure 6-6. Drill bits

Code	Size, inches		Size, mm	
	Hole	Core	Hole	Core
EW	1-31/64	27/32	37.7	21.5
AW	1-57/64	1-3/16	48.0	30.1
BW	2-23/64	1-21/32	60.0	42.0
NW	2-63/64	2-5/32	75.7	54.7

Wire line bits listed below yield the same size hole but not the same size core as the bit shown above.

Code	Size, inches		Size, mm	
	Hole	Core	Hole	Core
AQ	1-57/64	1-1/16	48.0	27.0
BQ	2-23/64	1-7/16	60.0	36.5
NQ	2-63/64	1-7/8	75.7	47.6

(2) Hard metal bits. Drill bits of hardened steel notched to resemble the teeth of a saw can be placed on the core barrel to substitute for a more costly diamond bit. In some soft rocks this type of bit makes a hole much faster, is not as easily blocked, and is much cheaper than a diamond bit. The teeth of such bits are often faced with one of the alloys of tungsten carbide, or replaceable inserts of a hard alloy are welded into holes cut into the bit blank. The hard alloys can also be used to make a noncoring bit.

20 Jan 84

(3) Roller rock bits. Rock bits, like diamond bits, are attached to the bottom of a hollow drill pipe column. The bit is made of toothed rollers or cones, and each turns or rolls on the rock as the bit rotates with the drill pipe. Cutting is accomplished by crushing and chipping operations. The shape, attitude, and number of teeth and the number of rollers vary. Most bits have three or four cones or rollers; some have two. The teeth and other parts of the bits subjected to intense abrasion are made of hard alloys. Cuttings and sludge are washed out of the hole by circulating water or drilling mud through the drill pipe and back to the surface between the drill pipe and the walls of the hole. The roller rock bit is not extensively used for grouthole drilling because the smallest available size is approximately the same as that of an NW-diamond bit.

(4) Drag and fishtail bits. The drag bit is a general service bit for rotary drilling. The bit is capable of drilling soft rock and most soils and is used extensively in foundation explorations and grouthole drilling. The fishtail bit is so named because of its resemblance to a fish tail. The divided ends of the single-blade bit are curved away from the direction of rotation. Other drag bits have three or four blades, which may or may not be replaceable. The cutters or cutting edges of the blades are made of hardened steel or are covered with hard alloys. Almost any desired size is available.

(5) Summary. Drill bit types and the materials in which they are generally used are as follows:

<u>Drill Bit Type</u>	<u>Principal Use</u>	<u>Not Suited for</u>
Diamond Core	Rock and concrete	Unconsolidated soils
Plug	Rock	Extremely hard rock, extremely soft rock, unconsolidated soils, and shattered or fractured rock
Hard metal	Soft rock, hard clay, and cemented soils	Hard rock and uncon- solidated soils
Rock	Rock	Unconsolidated soils and very hard rock
Drag and fishtail	Soft rock and soil	Hard rock
Percussion	Rock and concrete	Unconsolidated soils

e. Auger Drills. The auger drilling rig powers either short, spiral-shaped tools or drill rods with continuous helical fluting. The spiral-shaped tool is run on a torque bar and serves as a platform to remove cuttings. The drill rod acts as a screw conveyor to remove cuttings produced by an

auger-drill head, and is also referred to as a continuous-flight auger. The auger bits are made of hard steel or tungsten-carbide-tipped cutting teeth. The larger diameter continuous-flight augers are available with a hollow tube/stem through which grout can be placed. Auger drilling is conducted in soils and very soft rocks to depths rarely exceeding 100 feet.

f. Grout Pumps. A great variety of grout pumps of various makes and sizes is available for the placement of grout. They can be air, gasoline, or electrically powered. The air-powered type of pumps have become more prominent in grouting operations. Constant speed-type pumps are powered by electric motors or internal combustion engines. The air-powered pumps provide variable speeds. Grout pumps should be carefully selected to ensure a built-in flexibility that provides close control of pumping pressures and variable rate of injection. The pumps should be the type that can be easily and quickly serviced during grouting operations. Pumps for most grouting projects should be of the minimum surging or nonsurging type, which avoids the pulsating effect transmitted to a hose, pipeline, drill stem, or grout hole at the completion of each compression stroke of a reciprocating-piston pump. Air or electrically powered pumps are best suited for shaft, tunnel, silo, or other similar types of underground work. Spare pumps and spare parts should be available during all grouting operations (fig. 6-7 and 6-8).

(1) Line-type slush pumps. Slush pumps have the discharge valves located directly above the suction valves. This arrangement helps in expediting the removal of both types of valves for cleaning or correcting malfunctions; however, the valves are not interchangeable.

(2) Sidepot-type sump pumps. Sump pumps are designed with each valve in a separate chamber or pot, each with its own cover. This arrangement provides for the removal of the suction valves without disturbing the exhaust valves. One problem, especially with sanded grouts, is the necessity of having to remove cement and sand that frequently collect in the bottom of the pots.

(3) Divided fluid-cylinder valvepot-type pumps. Valvepot pumps are somewhat heavier than the line-type pump that has comparable capacities. The valves and seats of this pump are interchangeable, and the fluid end is easily cleaned.

(4) Progressive cavity pumps. Cavity pumps under the trade name Moyno or Roper are two of the most popular pumps currently used in a wide variety of grouting applications. The major components of this type of pump consist of a wormlike hardened steel screw rotor that rotates in a helically formed stator in which grout is forced forward. The larger pumps will pass particles up to a size of approximately 1-1/8 inches. It is a valveless unit and has few working parts and comparatively is more trouble free. Progressing cavity pumps can generate pressures up to approximately 1,000 pounds per square inch and have a top capacity of approximately 200 gallons per minute. The stator liner can be exchanged to provide a stator for handling highly abrasive grouts,

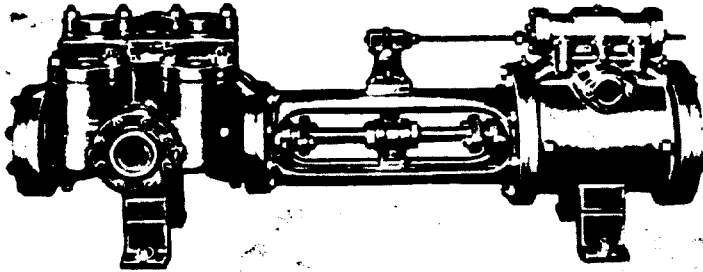

a. SIDE-POT-TYPE PUMP

(Courtesy of Wagener Pump Division, Canton Stoker Corp., Canton, Ohio, Bulletin No. WS-150A)

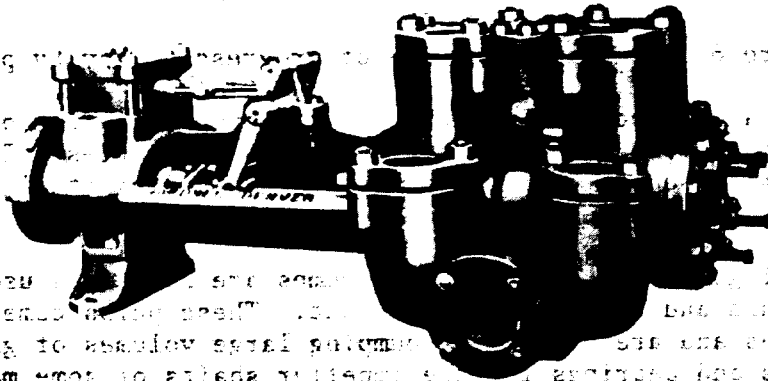

b. DIVIDED FLUID-CYLINDER VALVE-POT-TYPE PUMP

(Courtesy of Gardner-Denver Co., Quincy, Ill., Composite Catalog 62-63)

Figure 6-7. Slush pumps

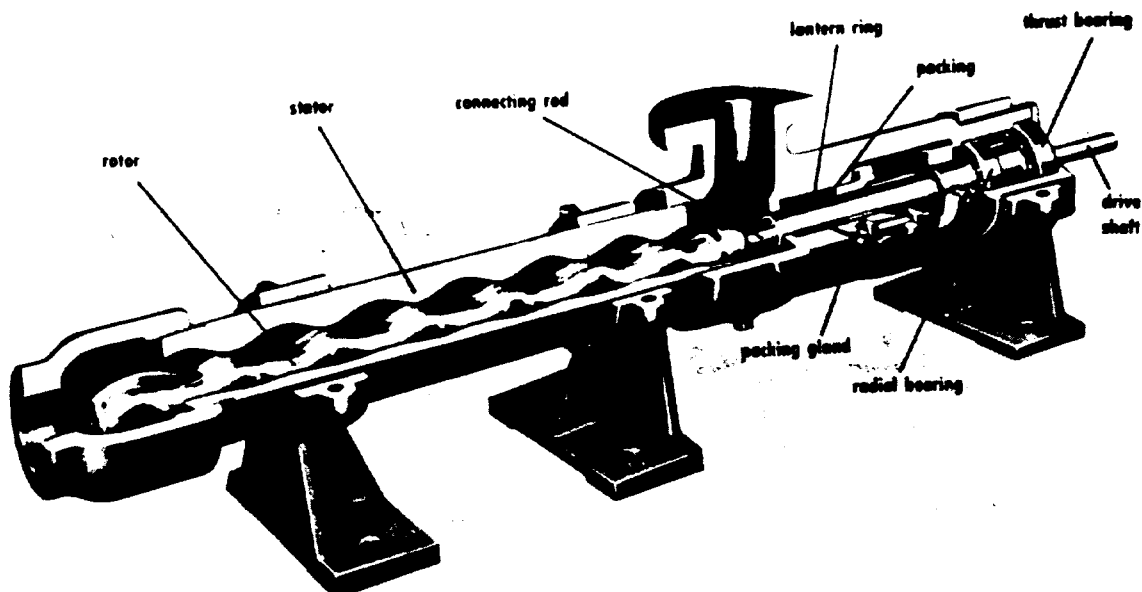

*(Courtesy of Robins and Myer Pump Division,
Springfield, Ohio Bulletin No. 30-C)*

Figure 6-8. Cutaway section of progressive cavity pump

chemical grouts, and petroleum products. These pumps are free of pulsation and can be used to pump a great range of grout consistencies. The larger pumps are sometimes used to pump sanded grouts containing steel fibers. The open-throat types are the best suited for handling grouts containing fillers.

(5) **Centrifugal pumps.** Centrifugal pumps are sometimes used to pump highly fluid sanded and unsanded cement grout. These pumps come in a variety of sizes and makes and are capable of pumping large volumes of grout at low pressures. Seals and bearings for the impeller shafts of some makes of these pumps require frequent replacement as a result of wear and tear by abrasion.

g. **Concrete Pumps.** Concrete pumps are occasionally used to pump sanded and unsanded cement grouts in cases where the consistencies of such mixtures range from moderate to near minimum fluidity. The latter mixture is often described as being stiff or having a standard slump cone consistency ranging between 4 and 8 inches. These pumps can easily handle aggregate to a maximum size of 1 inch and are also capable of pumping grouts containing steel fibers. These units are composed of reciprocating pistons housed at the bottom of a stowing type hopper. The piston delivers the grout directly into 4-inch or larger steel pipelines through a swedged head-type coupling. The pumps are normally either truck or trailer mounted and gasoline powered. They are not used in grouting applications that require close pressure controls but are mainly used in filling large cavities, and at times are used to deliver grout to tremies when such cavities are filled with water.

h. Grout Mixers. The first consideration in the selection of a grout mixer is to ensure that it has the desired capacity and will produce a homogeneous mixture in a desired period of time.

(1) Tub mixers (fig. 6-9). Tub mixers of various capacities and arrangements of mixing blades are the most common type used. They are usually air powered, and the grout is mixed by several horizontal blades mounted on a vertical spindle. These mixers are used individually but more often than not consist of two or more tubs that are either parallel or in a series. The paddle blades are arranged in pitch to force grout to the lower section of the tub where the grout is discharged through either a quick-opening syrup/petroleum

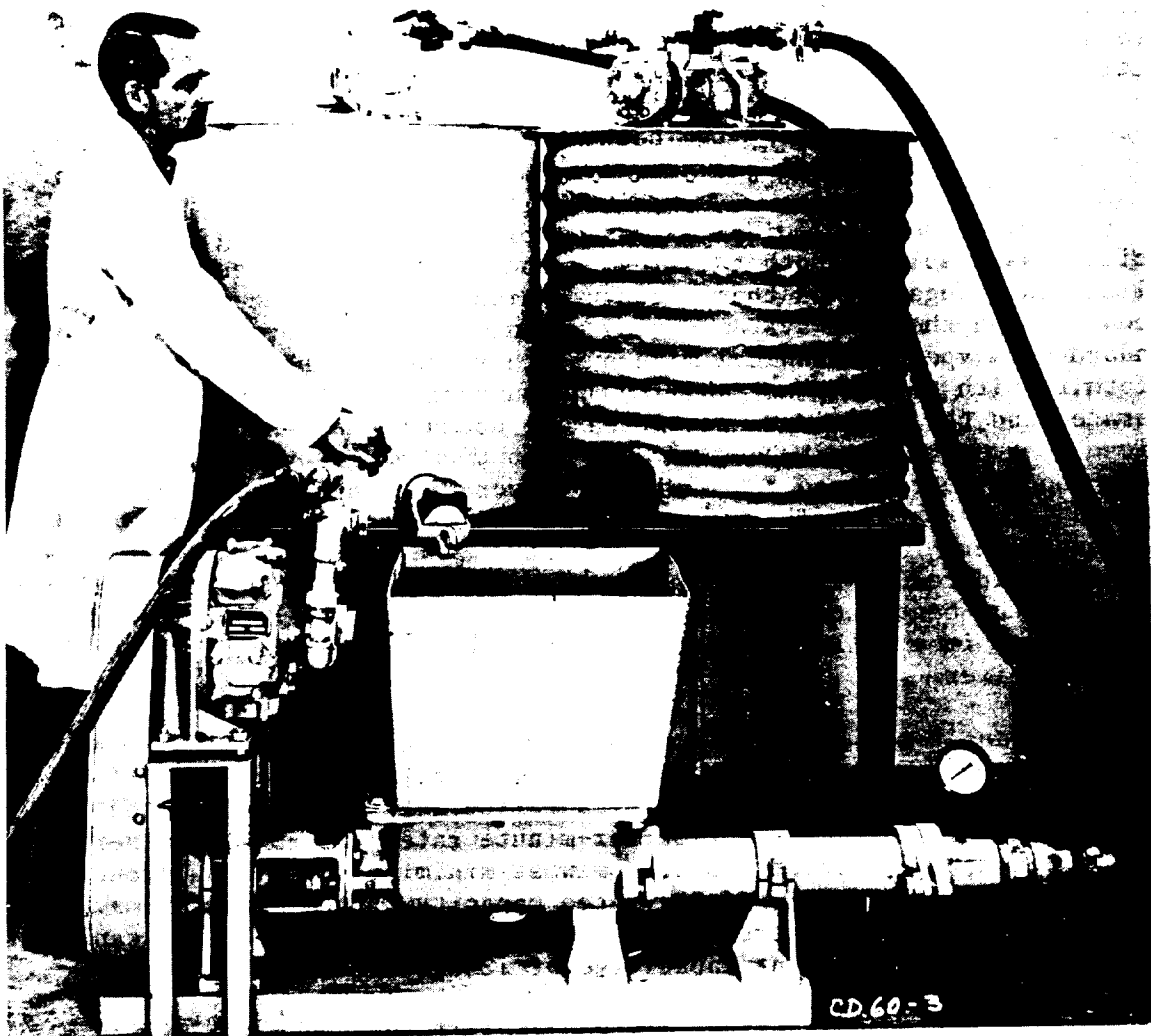

Figure 6-9. Two tub-type grout mixers and open throat progressing cavity pump

or similar type valve into a sump. These types of mixers are seldom designed to mix more than 1/2 cubic yard of grout. Four- to fifteen-cubic-foot-capacity tubs are the most convenient sizes for use in most grout applications. Outstanding features of tub mixers are that they can be easily charged, observed, and cleaned.

(2) Horizontal drum mixers, ribbon and paddle types (fig. 6-10 and 6-11). Grouting jobs that require moderate to large quantities of grout frequently utilize a horizontally positioned drum having length-to-diameter ratios that range from approximately 2:1 to 4:1 and are capable of mixing approximately 8 cubic yards of grout. The drum is placed in a fixed horizontal position with a drive shaft centered along its long axis that is supported by bearing blocks enclosed in steel hubs. Affixed to the shaft are a series of paddles placed at selected intervals and normal to the shaft, or the drum may contain a series of metal segmented or continuous spiraling strips that are positioned near the inside perimeter of the drum and supported from the shaft by a series of struts. These mixers have a charging chute at the top of one end and a discharge valve at the bottom near the other end. They are usually air-powered; however, some are driven from truck-powered takeoff shafts.

(3) High-speed colloidal mixers. Colloidal mixers (fig. 6-12) are commercially available in both the single- and double-drum types. These units utilize centrifugal pumps that circulate highly fluid grout mixtures at high speeds through the drum system during mixing. These mixers are superior to standard slow speed mechanical mixers in that they produce grout of greater uniformity with better penetrability and pumpability. Cement clusters are separated and the individual particles are often broken and rounded to a significant degree making it possible to grout tighter fractures. Colloidal mixers should be required for mixing and hydrating bentonite. Bentonite should be mixed in a separate mixer and fully hydrated before being introduced into the grout mixer. The bentonite mixer must not be contaminated with cement because it would reduce the swell properties and, thus, the grout stabilizing ability of the bentonite. Hydration of bentonite can be accomplished in less than 1 minute in a colloidal mixer as compared to approximately 24 hours in a slow speed mixer.

(4) Transit mix and skip-loaded concrete mixers. Transit and skip-loaded mixers are sometimes used as grout mixers; however, mixer efficiency is sacrificed as a result of the lack of shearing action being imparted to the mixture because of slow revolution-per-minute rates. When such mixers are used for grout, the problem can be somewhat minimized by mixing grout volumes that do not exceed one half of the rated capacity of the mixer drums. One major benefit of these mixers is the large quantity of grout that can be mixed since some units have mixing capacities of 12 cubic yards.

(5) Jet mixing units. Jet mixers generally produce less mixing efficiency than most mixing systems. These units consist of a large metal funnel mounted atop and in line with a metal water line. The dry bulk cement or dry

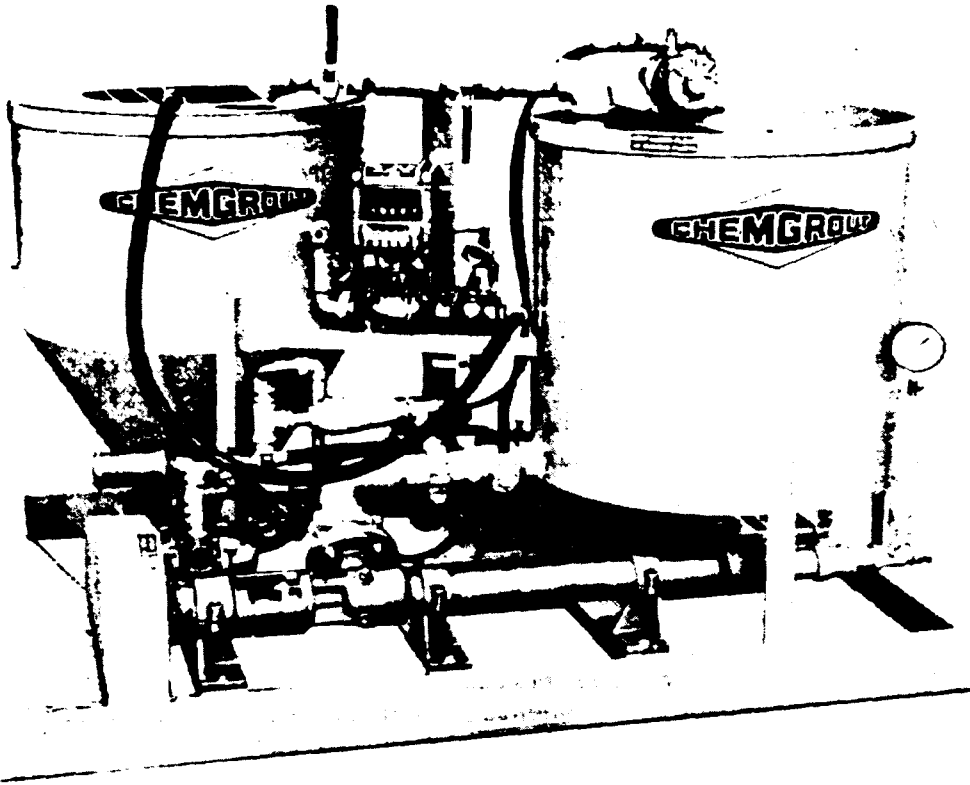

This larger version of the CG-600 is 68" wide, 102" long, and has 17 cubic feet mixing and holding tanks. Output ranges up to 20 gpm depending upon the mix. The standard discharge pump has a pressure of 225 psi and is capable of pumping sanded mixes. Higher pressure pumps (up to 1500 psi) are also available. Controls are centrally grouped for ease of operation. All drives are mechanical to minimize costly, unnecessary downtime. Cleanup is less than 10 minutes/shift.

CG-650

Type	Power	Quantity
Air	100 psi	370 cfm
Electric	230/460	54/27 amps
Gasoline	Available	
Diesel	Available	

Figure 6-12. Colloidal mixer

bulk blended grout materials are continuously metered into the funnel by means of a flapper valve. A forced stream of mixture water is continuously metered by pipe just below the orifice of the funnel which causes shearing and turbulent mixing action. The resulting mixture is jetted into a holding tank, is measured for designed weight and fluidity, and, if needed, is adjusted for corrections to cement and water metering. When the mixture is properly adjusted, the suction side of large pumps picks up and transfers the grout to a discharge pump. Large volumes of grout can rapidly be placed using this method. This unit is sometimes used to place quick-setting mixtures; however, no holding tanks are in the system. A sampling "T" for providing a degree of control is in line.

(6) Compressed-air tank mixers. Compressed-air mixers are occasionally used for accurate batching and mixing. These types of mixers may range in capacity from a few cubic feet to 500 cubic feet. Dry materials are fed to the tank through a pipe connection located at the tank side below the water level. Air and mixing water provided through vertical connections discharge into the interior of the tank. The air-mixed grout is discharged from a connection located at the base of the mixing cone.

i. Agitator Holding Tanks. To provide a high volume and continuous injection of grout, two mixers are usually set up to alternately discharge into an agitator holding tank that has a capacity at least two and preferably up to three times the capacity of the mixing system. Tub or horizontal type mixers operated at slow speeds are frequently used for agitating holding tanks. Agitator holding tanks can be similar in design to the tub-type mixers shown in figure 6-9. Volumes of grout used from the agitator holding tanks can be measured by marks at different levels in the tanks.

j. Grout Lines. Two primary arrangements of grout piping are used to supply grout from the pump to the hole. The simpler of the two, the single-line system, is used in a variety of grout placements. The system consists of a pipe or a hose or a combination of both extending from the pump discharge to the header at the hole collar. The pump speed controls the rate of grout injection. The second arrangement, which provides a circulating system, is composed of a double line, and one of the lines serves as a return line from the header to the grout pump, sump, or holding tank. This line provides for the continuous circulation of the grout through the single line and pump. The double-line system can also be used to meter a desired amount of grout down-hole by simply varying the openings of a valve on the return line without changing pump speed. Pressure is controlled by one or more valves on the control line. A circulating grout header should normally be required for foundation grouting.

(1) Hose lines most commonly used for discharge and suction are the flexible type, usually made of reinforced rubber or plastic. The inside diameter of these hoses for most grouting applications ranges from 1 to 2 inches. The larger the diameter of a given type of hose, the less the working pressure.

Hoses should be selected that have working pressures at known temperatures that will withstand the maximum pressures anticipated with an ample margin of safety. Damaged hoses should be discarded.

(2) Pipelines of black steel are sometimes used in long runs from the pump to an array of holes to be grouted. The lines should be at least one half again the diameter of the flexible lines and should not contain any sharp bends or constrictions.

k. Headers. Headers permit grout injection through downhole lines as well as provide continuous circulation at the surface. Headers may also permit grout injection through downhole lines and return up the annular space between tubing and hole. See figures 6-13 and 6-14.

l. Valves. Valves for grout lines and header systems should be the quick-opening type, easily regulated, and resistant to corrosion and abrasion. They should be capable of accurately controlling pressures in all positions. When in the full open position, valves should not present a restriction to the flow of grout. Diaphragm-type valves have proven to be effective. Pressure relief valves should be installed in grout lines as an added precaution.

m. Packers. Packers are often required in pressure grouting to confine the injection of grout to certain foundation zones, to isolate a lost circulation zone, to separate grout stages, to grout sections of slotted or perforated

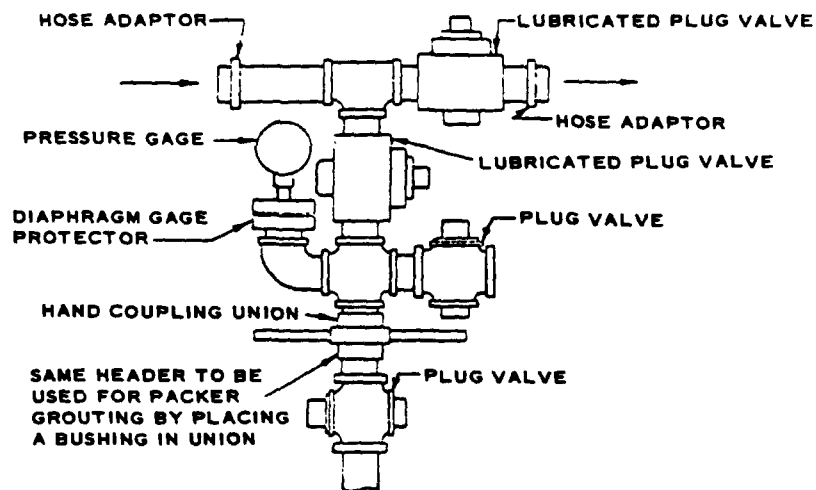

NOTE: ALL PIPE AND FITTINGS ARE 1-1/2" SIZE. PLUG VALVES TO BE USED THROUGHOUT FOR PRESSURES ABOVE 250 PSI. GROUT HOSE TO BE 1-1/2" WITH SCREW-TYPE COUPLINGS.

(Courtesy of American Society of Civil Engineers)

Figure 6-13. Direct grouting header

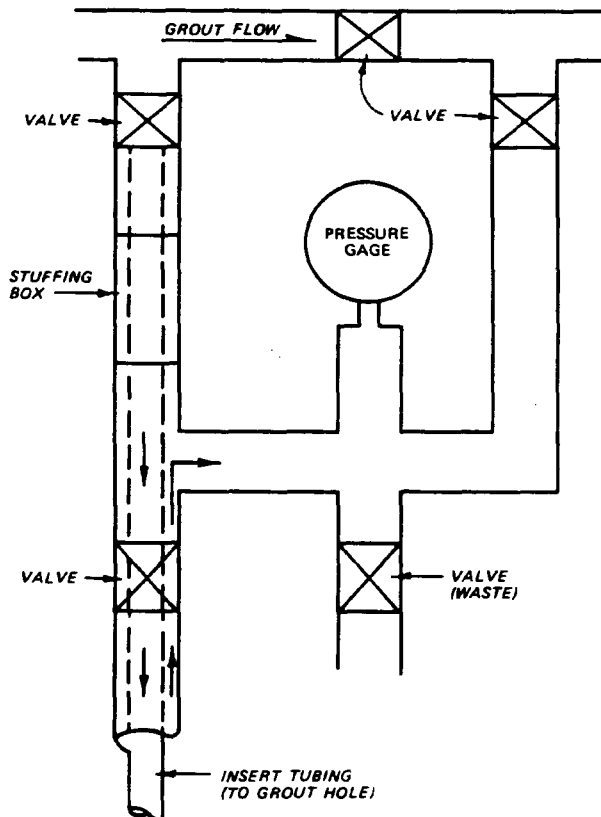

Figure 6-14. Circuit grouting header (not to scale)

casing, and to make surface connections. The three most commonly used packers are shown in figures 6-15 through 6-17.

(1) Cup leather removable packer. The cup leather removable packer is best suited for use in holes drilled in moderately hard to hard rock and where the walls of the holes are relatively smooth and of the proper dimensions. This packer is attached to a single pipe for placement downhole. When properly assembled and positioned, the packer can withstand pressures approaching 1,000 pounds per square inch.

(2) Mechanical packer. This packer is an expandable type. It is difficult to properly seat if the hole is rough or oversized and easily bypassed in fractured rock. When properly assembled, expanded, and seated in good rock, the mechanical packer can also withstand pressures of approximately 1,000 pounds per square inch. This type of packer is widely used in rock formations that vary from soft to hard.

(3) Pneumatic packer. The pneumatic or air packer can be used in

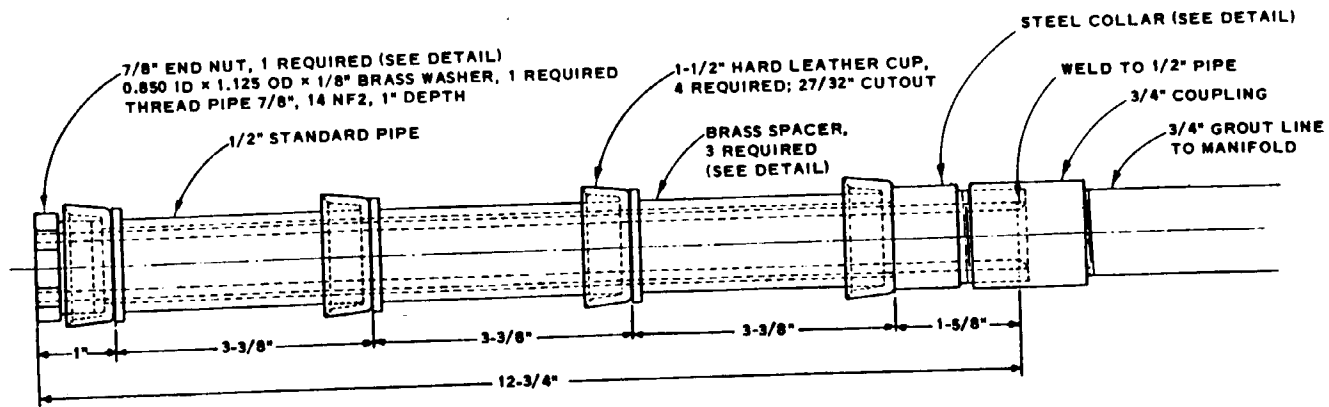

PACKER ASSEMBLY

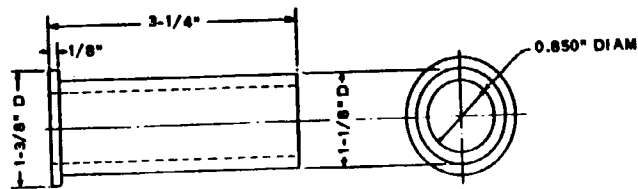

DETAIL OF PACKER SPACER

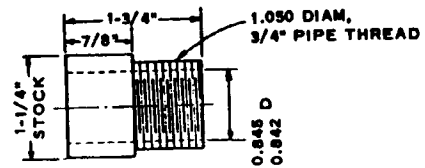

DETAIL OF COLLAR

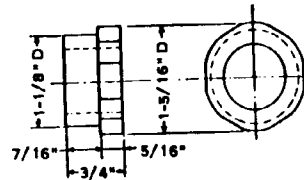

DETAIL OF END NUT

MAKE FROM STANDARD 7/8" HEXAGONAL NUT

(Courtesy of U. S. Bureau of Reclamation)

Figure 6-15. Removable grout packer

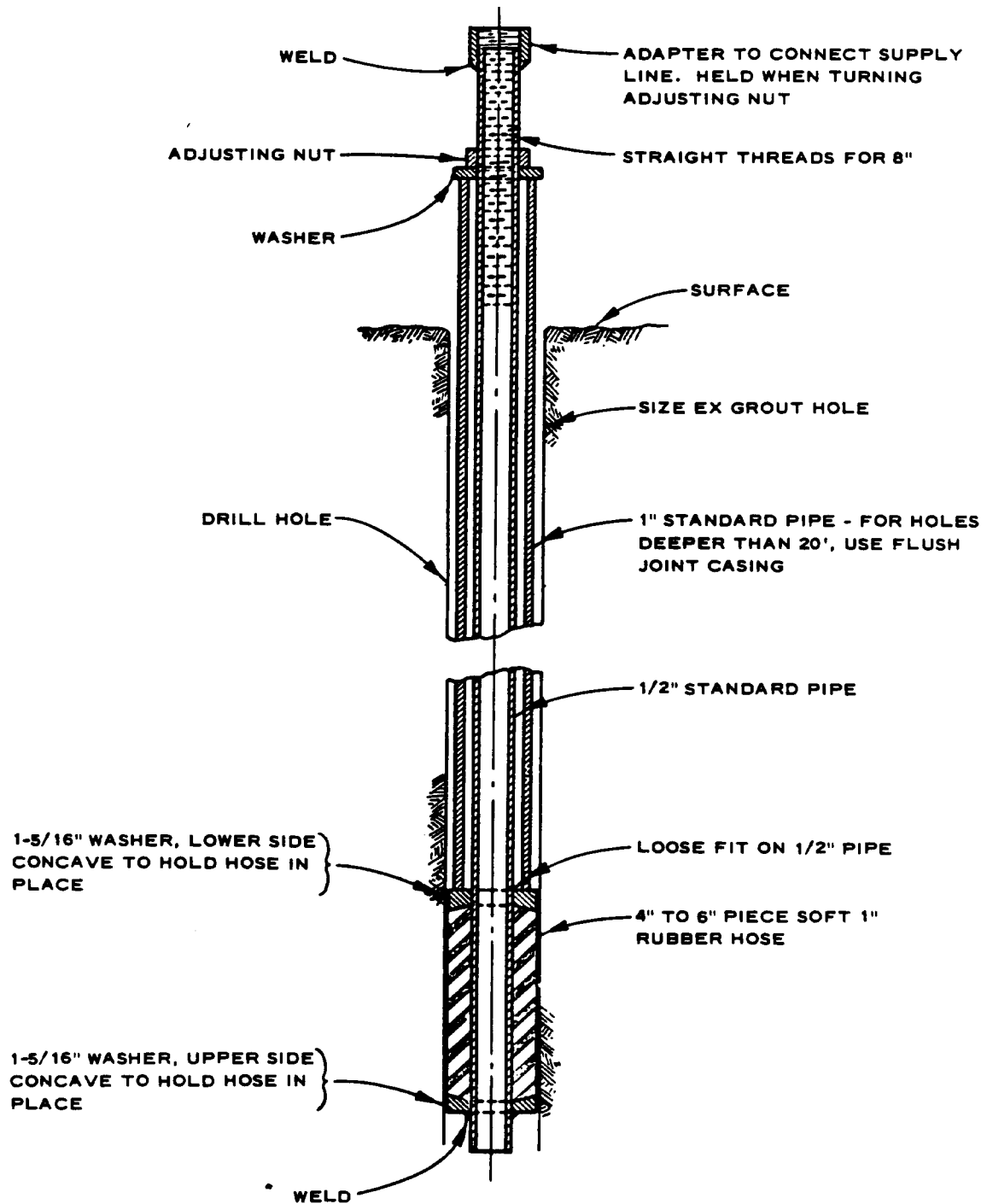

(Courtesy of U. S. Bureau of Reclamation)

Figure 6-16. Mechanical packer

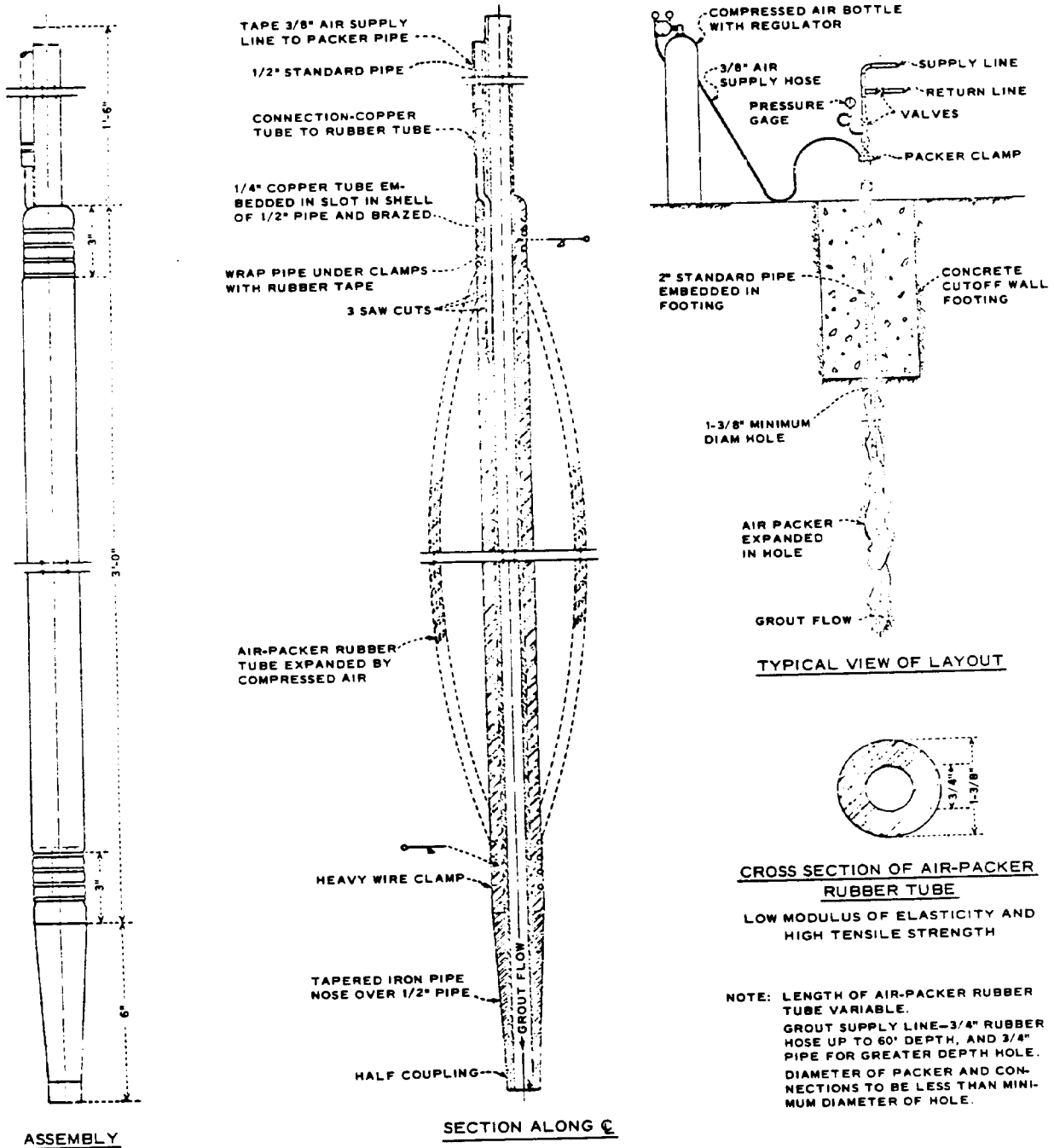

(Courtesy of U. S. Bureau of Reclamation)

Figure 6-17. Air packer

oversized holes because of its expansivity. As an example, an EM size may be seated in 3- or 4-inch-diameter hole or casing, providing that the hole condition is good. The packer is well suited for use in soft, fractured, and thin-bedded rocks. Grout injection pressure should be less than packer inflation pressure to prevent bypass of the grout.

n. Centralizers. Centralizers are sometimes required to position casing or injection pipe in the center of holes, particularly when casing or pipe is to be a part of a permanent subsurface type of installation. Assembled leaf springs with limit rings serve as centralizers and provide a uniform annulus around the casing or the pipe, which can then be properly filled with grout. The centralizers aid casing and pipe to negotiate irregularities and doglegs. Commercially available centralizers are fabricated with hinges to facilitate their attachment to casing or pipe strings (fig. 6-18).

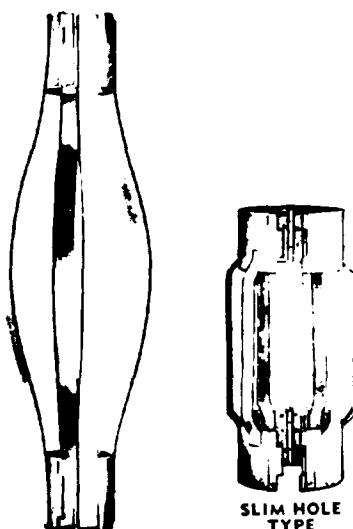
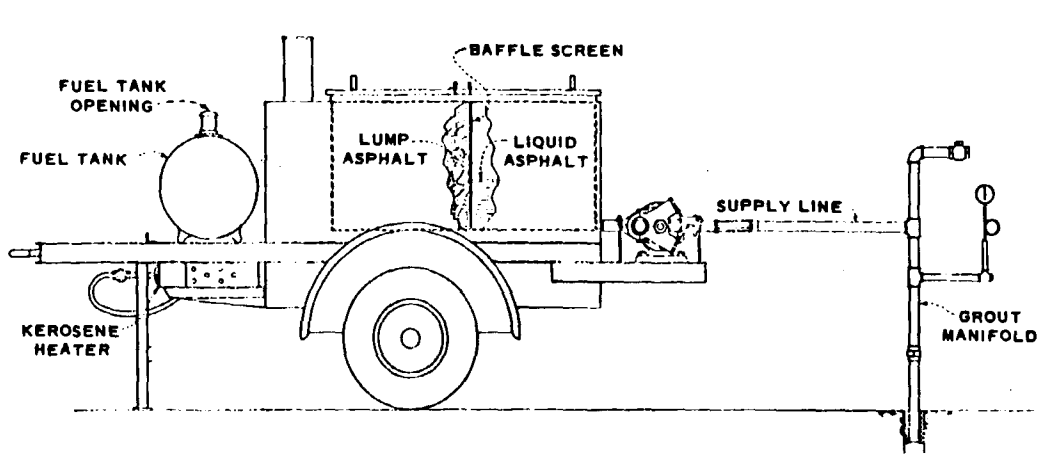

Figure 6-18. Centralizers,
Courtesy Halliburton, Inc.

o. Tube Wiping/Displacement Plugs. Tube plugs are used in special grouting applications for displacement of a measured amount of grout down a hole. A hard rubber plug with a series of rubber discs is forced down the inside of a steel tube by a fluid head acting on a steel ball seated atop the plug. The ball and plug are discharged into grout or retained in a plug catcher attached to the bottom of the drill tubing.

p. Asphalt Grouting Equipment. Portable asphalt heating kettles commonly used by contractors for pavement crack sealing, roofing coatings, and similar applications have served well in heating asphalt for grouting (fig. 6-19). Hot asphalt heating should be maintained below the flash point of the asphalt.



ASPHALT HEATER WITH GROUT CONNECTIONS

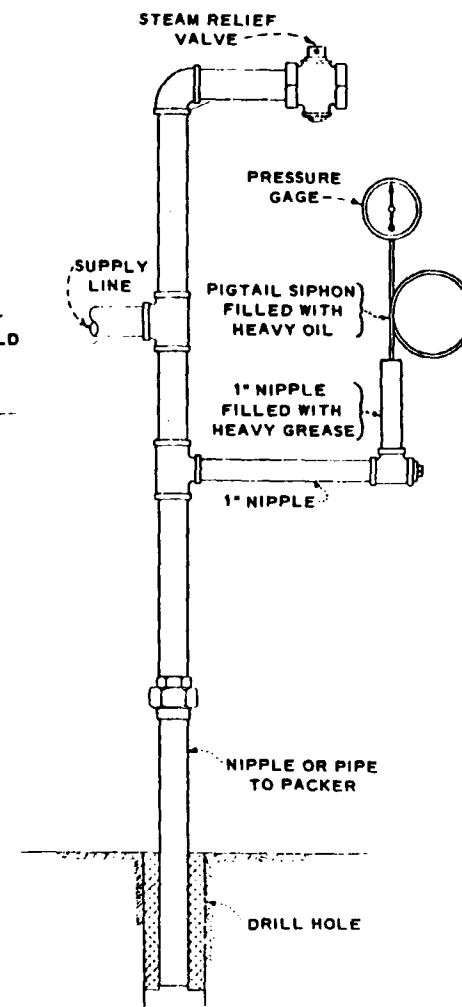

TYPICAL ASPHALT GROUTING MANIFOLD AND CONNECTIONS

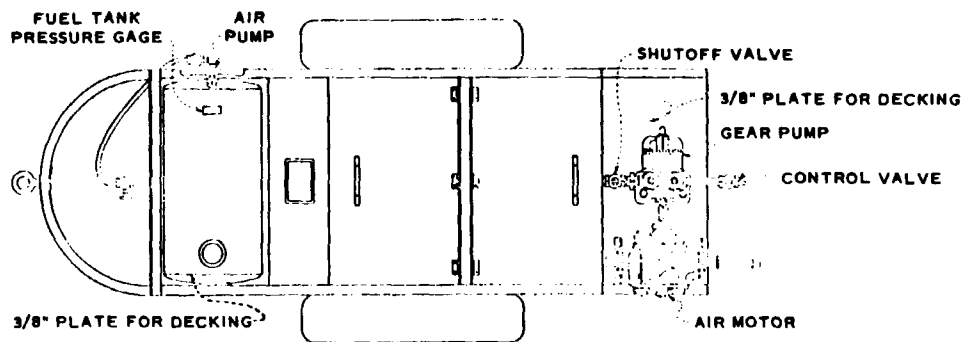

NOTE: 1-1/2" STANDARD PIPE AND FITTINGS EXCEPT AS SHOWN.

(Courtesy of U. S. Bureau of Reclamation)

Figure 6-19. Asphalt grouting equipment and connections

EM 1110-2-3506
20 Jan 84

20 Jan 84

Reciprocating pumps with ball valves, or 1-inch boiler-fed piston pumps and gear pumps, have been used to pump hot asphalt through 1- to 2-inch black iron pipe. Conventional type cement grouting equipment can be used for asphalt emulsions.

q. Chemical Grouting Equipment. Grouting equipment has been generally developed by the manufacturer to mix and place that particular chemical grout system. Conventional grouting equipment may be used for a number of processes, especially when single batching will meet the job requirements. Closely controlled proportioning systems are frequently recommended for handling two or more components of a given formulated grout. Detailed descriptions covering chemical grouting equipment are discussed in EM 1110-2-3504.

r. Large-Capacity Mixing and Pumping Systems. During the middle years of the twentieth century, an enormous surge began to take place in the growth of organizations that have developed highly specialized equipment, materials, and techniques for grouting operations, especially those operations requiring large, continuous mixing and pumping systems. One single pumping system is capable of mixing and placing approximately 35 cubic yards per hour. Pumps are capable of developing 20,000 pounds per square inch. These capabilities have mainly been developed as a result of an increasing demand to solve underground problems associated with energy sources, large foundations, deeply buried structures, and other grouting operations similar in scope and complexity. Much of the equipment used in these types of grouting operations is mobile; some systems are skid mounted and others are barge mounted. Companies specializing in large-scale grouting operations as well as oil well cementing/grouting companies are providing this type of grouting capability worldwide. Some of the major pieces of equipment and storage facilities used in large-capacity mixing and pumping systems are shown in figure 6-20.

s. Tremie Equipment. Steel sections of pipe and tubing fabricated from a few inches to as large as 6 or more inches in diameter and to lengths ranging from a few feet to desired lengths are the major items that make up a tremie system for the gravity placement of grout. The sections are usually joined loosely end to end by means of short lengths of steel-linked chain in forming a continuous and somewhat flexible pipe string. The tremie system with a gathering hopper or chute attached to the top section is positioned initially with its discharge end immediately above the point of grout placement.

t. Casing. The casing commonly used in grouting work is either steel or plastic tubing. The tubing is lowered into a borehole to prevent collapse of the hole or entry of loose rock, gas, or liquid or to prevent loss of circulation fluid into permeable formations. Casing is used to isolate zones to be grouted through perforated casing. Additional information regarding casing is presented in EM 1110-2-1907 and EM 1110-2-3504.

u. Pressure Testing Equipment. The major items of equipment normally needed to conduct pressure testing include single or straddle packers, a water

20 Jan 84

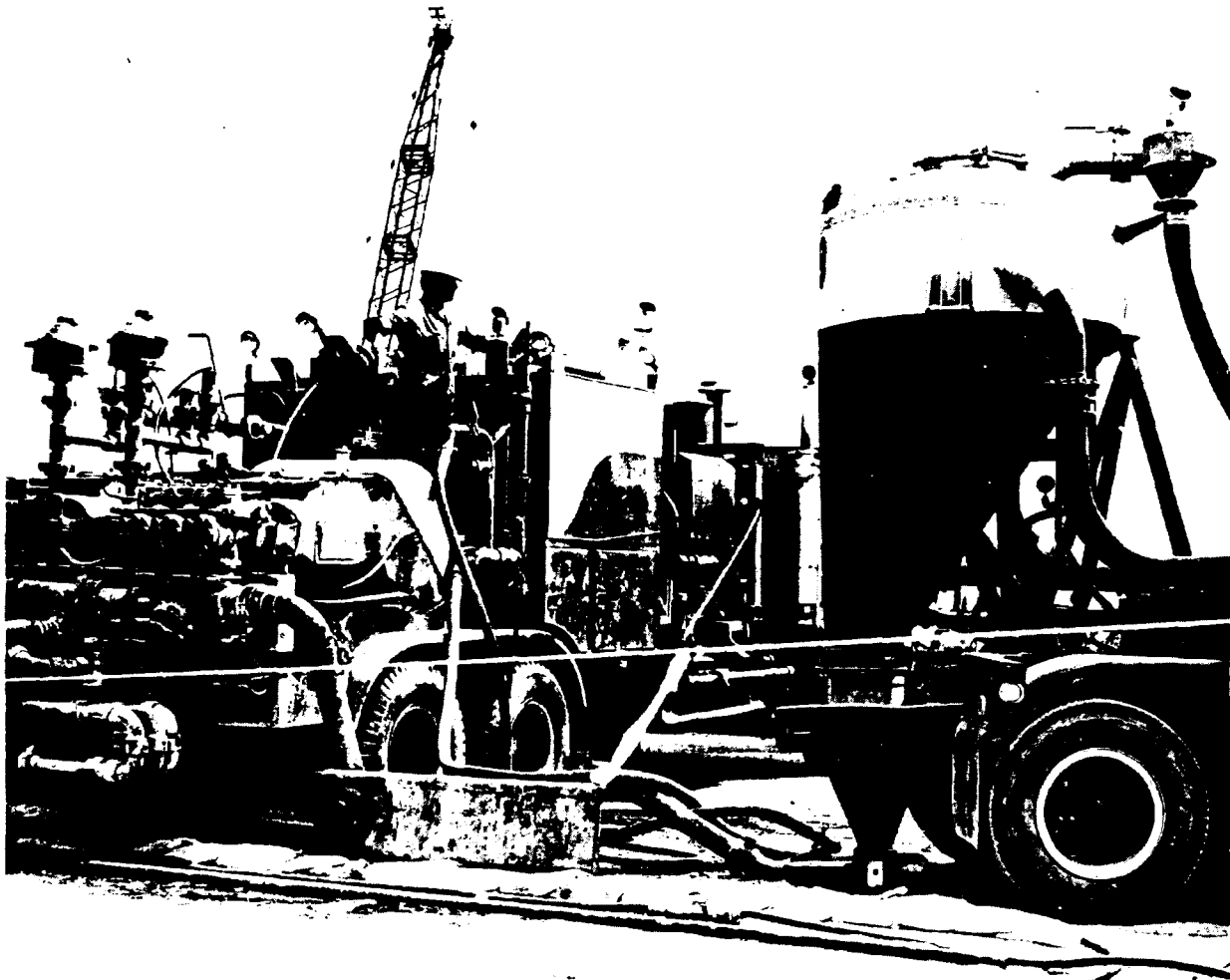

Figure 6-20. Standard twin HT-400 cementing unit fully rigged with jet mixing cone and slurry reservoir. Courtesy, Halliburton Services

meter, a nonpulsating type pump, pressure gages, a suitable pipe or base for connection to the hole collar or downhole, and a stop watch. Water meters and pressure gages should be tested for accuracy prior to use as these items provide essential numerical data for analysis.

v. Meters. An accurate and expeditious method of controlling grout water contents is by using volume-measuring water meters. These meters can be obtained with measurements in either gallons or cubic feet and can usually be read to the nearest quarter of a gallon or tenth of a cubic foot. A meter should be checked for accuracy before it is used and, if necessary, should be calibrated. Meters for measuring quantity of grout placements either may consist of something as simple as a vertical graduated stick or rod gages placed

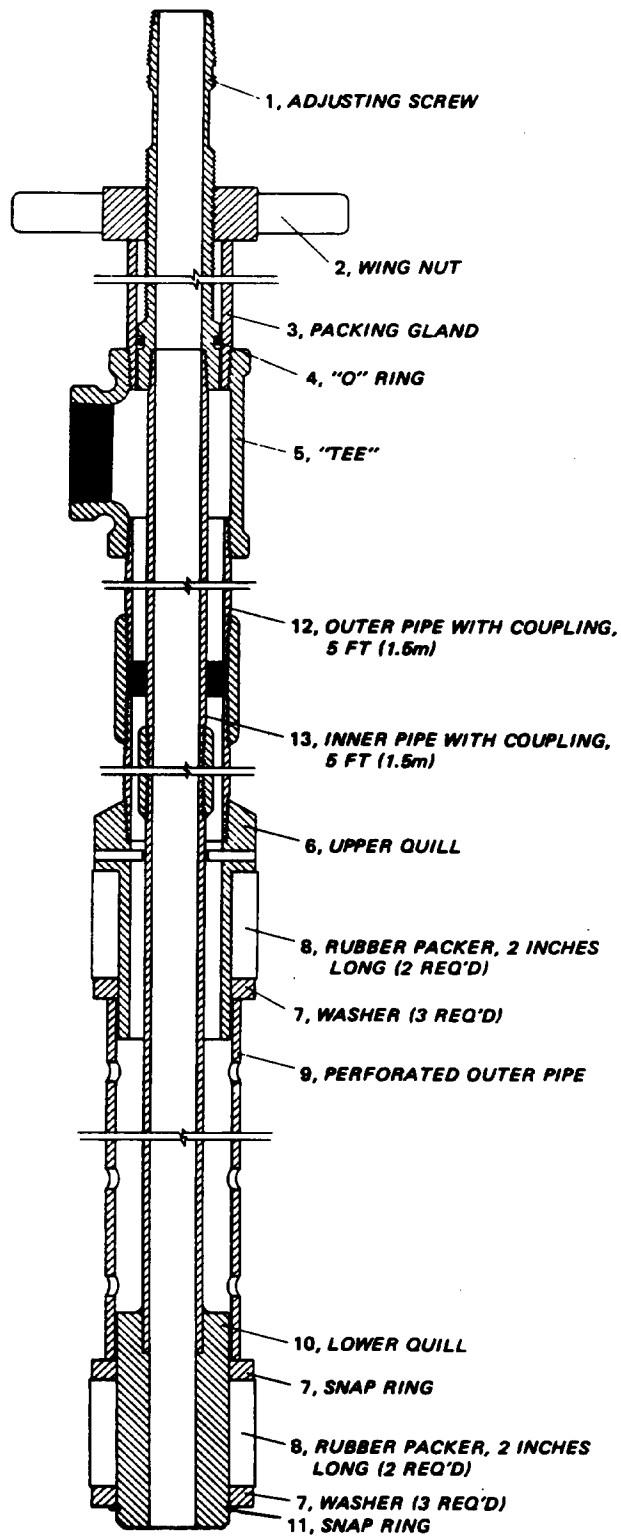

Figure 6-21. Pressure testing packer assembly

in mixers or agitator trucks, or may use calibrated spindles placed in the grout line and geared to counters or strip recorders (fig. 6-21). These meters may be designed to measure barrels, cubic feet, gallons, or fractions of these units.

w. Pressure Gages.

(1) Pressure gages are essential in virtually all types of grouting and pressure testing, and they must be reliable. Malfunctioning gages have resulted in damage to structures and rock formations as a result of excessive pressures. Gages should be tested for accuracy prior to use and periodically during the work. The moving parts of the gage should be protected from dust and grit and from direct contact with the grout.

(2) Gages that are available commercially consist of diaphragm systems to provide the necessary protection. A diaphragm glycerin-filled gage saver is shown in figure 6-22.

6-3. Special Monitoring Equipment. A structure has precise, measurable dimensions in virtually all respects; however, the foundation of the structure can only be described in general terms. The quality of grout being placed in the foundation and the location, movement, and behavior of grout in place may need constant monitoring during a grouting operation. Some of the monitoring methods in use are described below.

a. Grout Level Detection Equipment. Monitoring the progress and adequacy of subsurface grouting operations is extremely important under some circumstances; i.e., grouting voids under structures which must be completely filled with grout. Such monitoring can be accomplished by grout level detection systems that include electronic readouts from probes located in an array of satellite drill holes surrounding the grout injection hole. The probes usually consist of electrode pairs that measure capacitance or resistance of freshly placed grouts. These probes, prior to placement downhole, are calibrated in air, water, mud, diluted grout, and the designed grout. With these data available, the system can be used to determine the quality of the grout being placed, and its vertical and lateral movements. The data also provide information relative to decisions to modify mixtures during placement, such as to use a quicker or slower setting mixture, to increase or decrease density, to add lost circulation material, and to incorporate tracers. Remote recordings can be obtained on printers or oscilloscopes. One application of grout level detection equipment is presented in WES MP SL-79-23 (app A).

b. Downhole Temperature Measurements. Temperature profiles of the subsurface area to be grouted are very helpful in furnishing information on the anticipated effects of temperatures on the setting times of grouts. Thermocouples or thermistors left in place will indicate the presence of grout as a result of temperature rise caused by the hydration of the cement or the reaction of the catalyst system in chemical grouts.

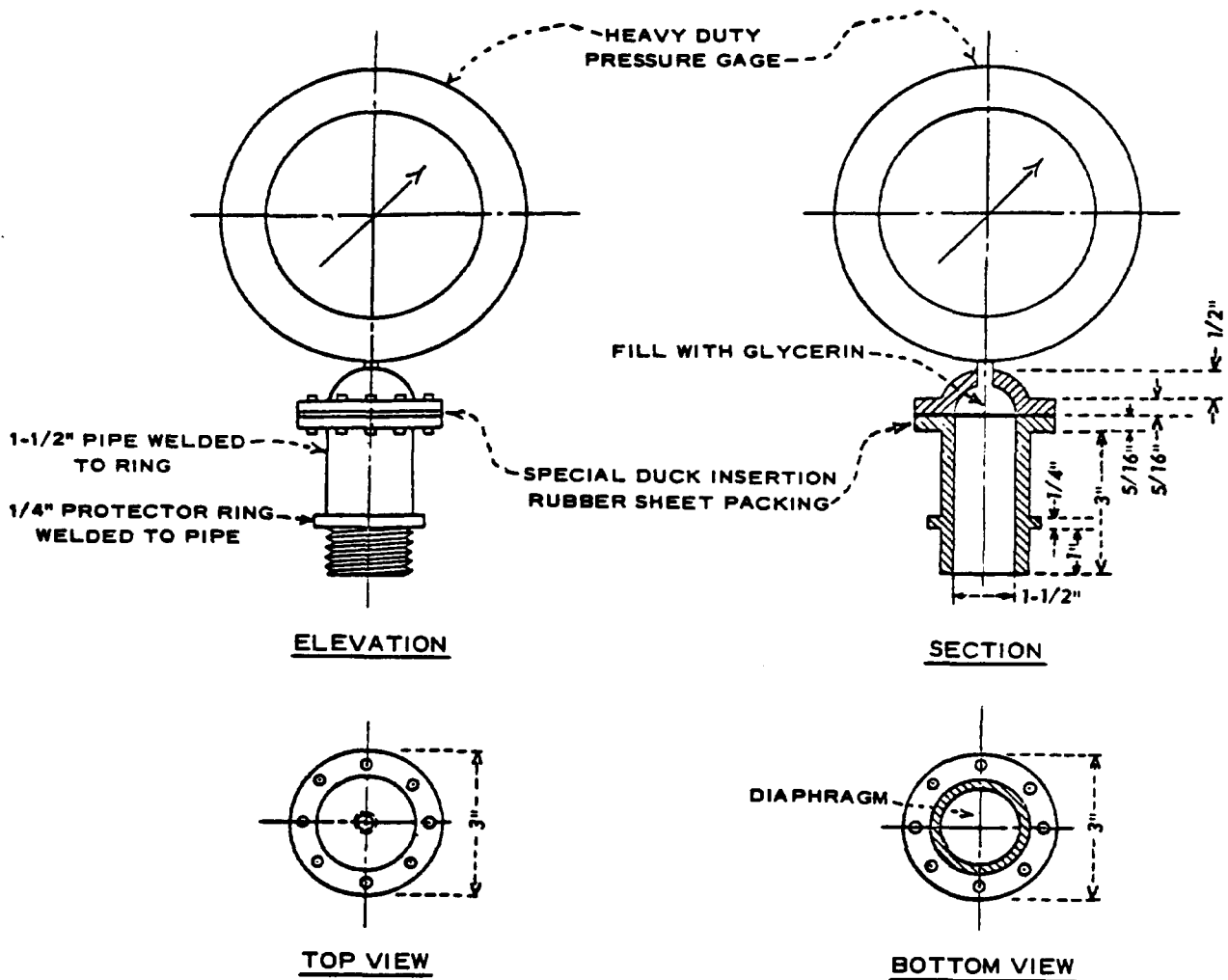

(Courtesy of U. S. Bureau of Reclamation)

Figure 6-22. Glycerin-filled gage saver

c. Downhole Sampler. A sampler that is useful in sampling grout to depths some few hundred feet downhole may be described as a small bottom-discharge bailer. It works on the same principle as the old-time water well bottom-discharge bailer, which is composed of a metal tube approximately 1 to 2 feet in length and approximately 3 inches in diameter. The bailer has one line for lowering and raising and one line for operating the valve located in the bottom.

d. Tracer Materials. Color tracers used in water and grout can be helpful in determining the extent of a groundwater or a grout communication system. Color pigments normally used in portland cement grouts as tracer materials are

basically finely ground iron and chromium oxides, which provide a wide range of distinct colors. Five to ten pounds of one of these pigments per sack of cement is usually sufficient to produce a distinct color. Other dyes include fluoresceins and rhodamines. The manufacturer of the chemical grout to be used should be contacted as to type and concentration for use in a particular product.

e. Flow Cone. The flow cone measurement may be used both in the laboratory and in the field for determining the flow of grout mixtures by measuring the time of efflux of a specified volume of grout from a standard cone. This test is used to ascertain the fluidity of grout mixtures. The method of testing is covered in CRD-C 611.

f. Slurry Scales. The unit weight of grout mixtures may be determined by using either the standard API-approved mud scale balance shown in figure 6-23 or by a unit weight container, precisely calibrated, that ranges from 0.25 to 1.0 cubic foot and has a set of scales graduated to tenths of a pound and a weighing capacity of at least 250 pounds.

g. Densimeters. Densimeters are very helpful devices that are frequently used in large scope and continuous grouting operations for measuring and controlling the densities of grout mixtures. These units are normally placed in-line and ahead of the surface recirculating system to provide a means for

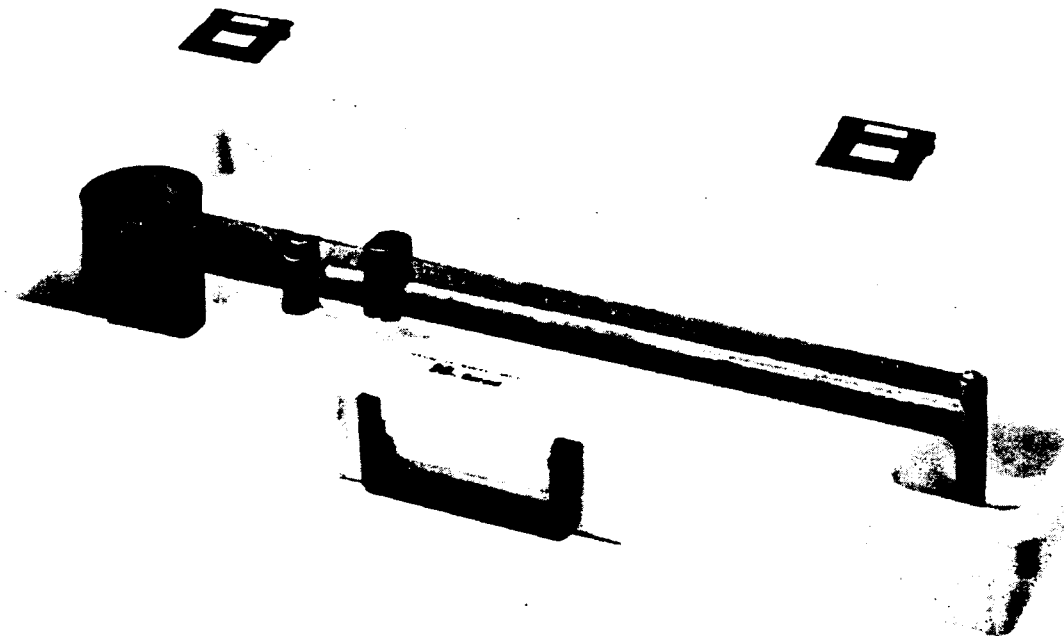

Figure 6-23. Mud balance

20 Jan 84

adjusting mixtures to designed densities. The devices operate on various principles; one such device is designed on the principle of a force-balanced U-tube; a second operates on a radioactive source. Both systems are equipped with remote continuous readouts..

h. Slump Cone. The consistency of very thick grouts may be determined by measuring the slump. The cone is a metal frustum that has a base of eight inches, a top of four inches, and a vertical height of 12 inches. The grout is placed in the cone in three equal layers, and each layer is rodded 25 times. The cone is removed vertically, and the slump of the grout is measured in inches from the top of the slump cone to the top of the grout. This method of test for slump is described in CRD-C 5.

i. Air Content Measurements. There are five methods that may be used for determining the air content of portland cement grout mixtures: gravimetric, high pressure, micrometric, pressure, and volumetric. These methods are described, respectively, in CRD-C 7, C 83, C 42, C 41, and C 8. Methods CRD-C 7, C 41, and C 8 are for freshly mixed grout and CRD-C 83-58 and C 42-83 are for hardened grout air contents, usually determined in the laboratory.

j. Time-of-Setting Apparatus. The initial and final sets of portland cement grouts are determined by the use of a mechanical device known as the Vicat apparatus. The apparatus is designed to measure with time the depth of penetration or no penetration of a blunt needle into a small cuplike receptacle containing a sample of the grout. This test can be conducted in the laboratory or field. The method of test is described in CRD-C 614.

CHAPTER 7
APPLICATION TO WATER RETENTION STRUCTURES

7-1. Concrete Dams.

a. Preparation for Grouting.

(1) Excavation for concrete structure foundations should be closely controlled to prevent damage to the rock. Final grade should be approached with great care to prevent damage by blasting and to minimize the necessity for foundation treatment. If consolidation grouting is required, it should be performed prior to final cleanup of the foundation. The cleaning and grouting of existing exploratory holes should also be performed at this time. The rock surfaces should be cleaned sufficiently so that grout surface leaks can be found and caulked.

(2) Under some conditions where open fractures exist in the foundation, pipe embedded in the fracture prior to concrete placement, and running to the gallery for future grouting, may be desirable. At least two pipes should usually be set, so that one will provide a return and serve as a telltale during grout placement. Large solution cavities should be cleaned and either backfilled with concrete, or with gravel and then grouted. Additional pipe should be run to the gallery for future grouting. Just prior to concrete placement the grout pipe and drain pipe should be set and run to the gallery gutter form.

(3) Exposed final rock surfaces that are subject to deterioration should be protected within an established exposure time limit.

b. Grouting Patterns. A typical profile and section of a main grout curtain under a sizable concrete dam is shown in figure 7-1. The notes on this figure relative to the size and the spacing of holes and to the order of operations will not apply to grouting under all concrete dams, but are generally representative of the more common practices. The extent of treatment may vary from no grouting to a multiple-line curtain and to area grouting treatment (B-holes in fig. 7-1) depending upon the particular project conditions. The curtain produced by drilling and grouting the C-holes in figure 7-1 prevents the grout from traveling too far upstream from the dam and greatly reduces the amount of seepage flow in horizontally fractured formations. Grouting under power plants and navigation lock structures is often done to effect a reduction in uplift or to facilitate unwatering operations. A grout curtain supplemented by a drainage system will normally suffice in both cases.

c. Schedule for Grouting Operations. The construction stage at which to perform foundation grouting is a matter of judgment and depends on the purpose of the grouting to be done, the foundation conditions, and the type of structure. Area grouting is generally done before concrete placement. On the other hand, curtain grouting or grouting for leakage or uplift control is

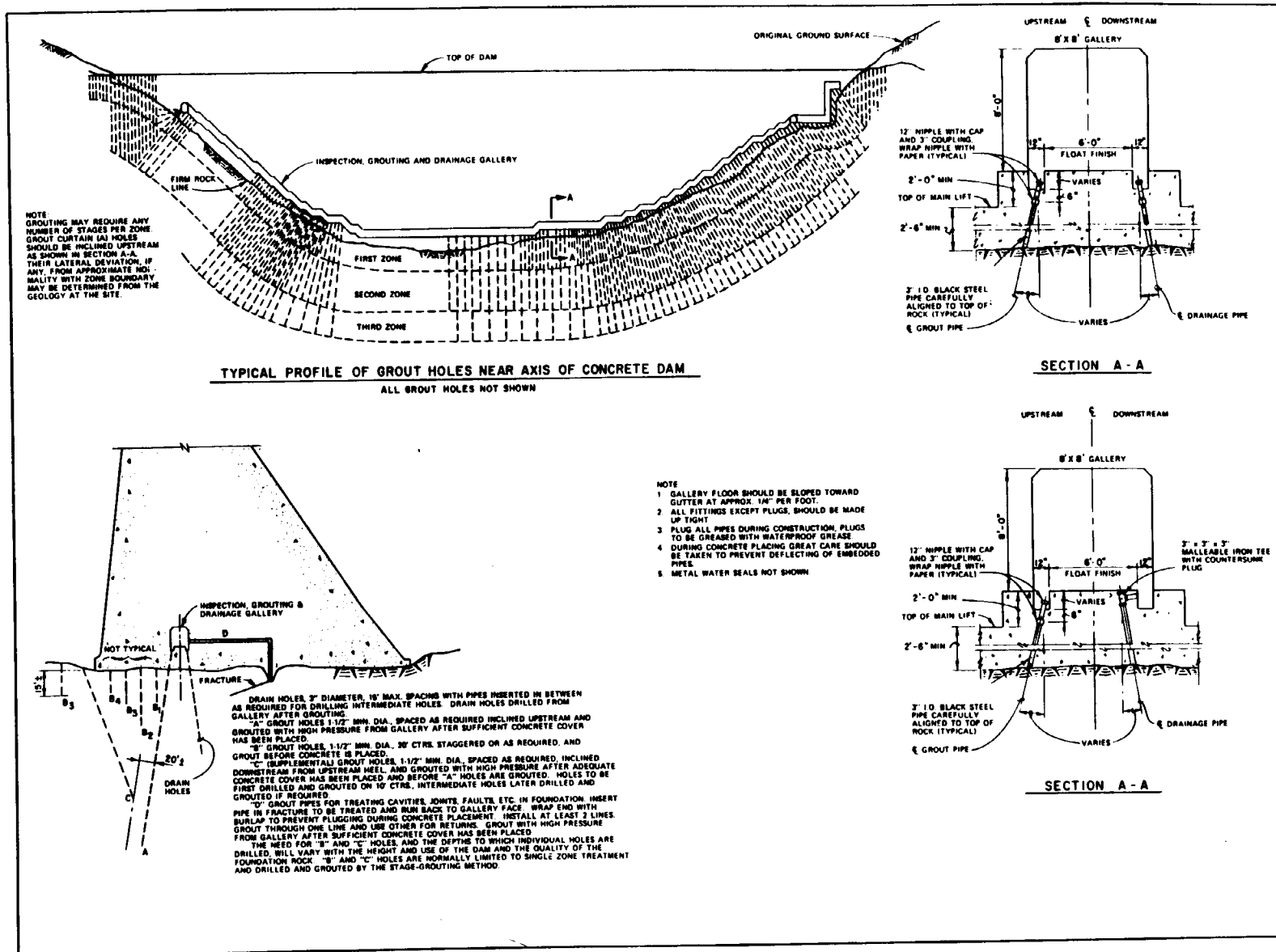

7-2

Figure 7-1. Multiple line cutoff

20 Jan 84

commonly done after concrete has been placed to a considerable height or even after the structure has been completed. This is especially true for high structures where the superimposed load allows the use of grouting pressures considerably higher than those that could be used before concrete placement. The grouting should be done, however, before any appreciable reservoir storage takes place to avoid grouting operations being performed against reservoir head or in an environment of high groundwater velocity.

d. Grouting and Drainage Galleries.

(1) Plans for the larger dams generally include grouting galleries from which holes for curtain grouting can be drilled and grouted. The galleries provide access to the hole locations and working space in which drilling and grouting can proceed without interference with or interruption from other construction activities. Galleries also provide access to locations for additional grouting, should any additional treatment be required after the project becomes operative. Access shafts to the gallery should be designed to accommodate the grouting equipment.

(2) A gutter located along the upstream wall of the gallery along the line of grout holes will (a) carry away drill water and cuttings from the drilling operations; (b) carry away wash water and waste grout from the grouting operations; (c) catch the discharge from drains that are usually located on monolith joints; and (d) permit a visual check to be made on the flow from each drain hole after the dam is in service. A gutter along the downstream gallery wall is also frequently provided and is advantageous in that (a) the drain is located closer to the gutter, resulting in a shorter cross drain easier to keep clean and (b) separate flow rates can be determined from the foundation drains, whereas the upstream gutter will collect flows from joint drains. Weirs can be installed to monitor foundation flows. The gutters should be sufficiently wide and shallow to accommodate the pipe on the greatest angle required. The floor of the gallery should be as near the rock surface as feasible to conserve on pipe or on drilling through concrete and to provide uplift relief at the lowest feasible elevation. However, the gallery floor should preferably not coincide with a lift joint. The gallery should be located near the upstream side of the dam to provide the maximum reduction in overall uplift.

(3) Galleries similar to those shown in figure 7-1 are also incorporated in many lock structures to aid grouting operations. The lock filling and emptying conduit may be used in lieu of a gallery when the lock dimensions do not allow room for a grouting gallery. In any case, a delay in grouting operations until some concrete has been placed is desirable.

(4) Failure to provide ready access for drilling of the grout holes can seriously affect the quality of the constructed grout curtain. Attempts have been made to provide access to grout holes without going to the expense of including galleries. However, the most effective means, which is always

accessible, has been to provide a gallery fairly close to the foundation elevation from which the main curtain grouting and drainage operations can be performed. The need for possible split spacing should be considered in the design of the concrete structure beneath the gallery.

e. Piping.

(1) Grouting from galleries or from intermediate concrete lift surfaces requires the drilling of holes either through embedded pipe or through the concrete with the hazard of encountering reinforcing steel in the drilling. The former procedure is preferable in that it allows the bottom of the pipe to be set so as to intersect observed fractures or other features to be grouted prior to concrete placement. Sections A-A in figure 7-1 show a satisfactory arrangement and size of piping where drilling and grouting are to be done from a gallery.

(2) Although a clearance of 1/4 inch is considered ample for diamond drilling, the use of pipe smaller than 2-1/2 inches in diameter for grout holes is inadvisable for embedment in concrete because of the possibility of bending or other damage to the pipe during the concrete placement operations. Larger diameter pipe may cause the drill rods to "whip" because of the unsupported length, which causes the bit to chatter. The decrease in velocity of the drill water during drilling operations as the water flows upward from the grout hole into the larger diameter pipe allows cuttings to accumulate at the bottom of the pipe. The cuttings may fall back into the hole when drilling is stopped and the drill water is shut off, and the cuttings have been known to bind the drill rods in the hole to the extent that rod removal is difficult. In stage grouting operations, the larger the diameter of the embedded pipe the less the chance of being able to recenter the drill bit in the hole, where a previously grouted stage must be redrilled, and, thus, the greater the likelihood that redrilling will be in rock instead of in grout. Smaller diameter pipe can be set inside previously installed larger pipe as a guide for the drilling. The larger diameter pipe also has the disadvantage of being more costly.

(3) Care should be used in positioning the guide pipes to be embedded in the concrete, because the angle or alignment of each pipe fixes the direction of the hole that will be drilled through the pipe. Small deviations in alignment will be greatly magnified in the lower reaches of the holes, especially where deep holes are to be drilled, and wide gaps will be left in the lower part of the grout curtain. The lower ends of the pipes will need to be anchored firmly in place to maintain the alignment of the pipes during concrete placement operations. Alignment may be maintained by grouting the pipe ends into the foundation rock to a depth of about 6 inches, or by anchoring the ends to rebars grouted into the foundation. The bottom of the pipe in the latter instance is not embedded in the foundation, which allows the contact to be grouted. Pipe ends are wrapped with burlap to prevent grout or concrete from entering the pipe. The top of each pipe should also be secured during concrete placement to maintain alignment.

20 Jan 84

(4) The 12-inch nipples shown in figure 7-1 and 7-2 at the tops of the grout pipes should be wrapped with building paper or other material to prevent bonding. The nipples can then be removed and the holes can be plugged after grouting has been completed if that is considered desirable.

(5) Factors involved in setting the pipe include direction, angle, and spacing of the proposed holes. Where necessary, additional split spaced holes can be drilled through the concrete. Horizontal or near horizontal holes may be required in steep abutment areas to properly grout relief joints. Holes are frequently fanned out in the abutment areas to provide complete coverage and overlap with grout holes outside the concrete structure, as shown in figure 7-1.

7-2. Earth and Rockfill Dams.

a. Grouting Patterns.

An embankment profile and sections illustrating typical grouting patterns are shown in figure 7-2. Additional guidance is given in EM 1110-2-2300.

b. Foundation Preparation for Grouting.

(1) Provisions should be made for a thorough cleanup of the rock surface to be grouted and adjacent areas on either side of the grouting operation. This cleanup allows mapping of the foundation and an evaluation of the grouting program as it progresses and facilitates observation of any surface leaks that may occur. The cleaned area also aids in ascertaining the need for special grout holes to intersect and treat prominent or unique discontinuities. It should be noted that weathered, broken, highly jointed and fractured, or horizontally bedded rock with soft seams may not be effectively treated by grouting. Wherever possible this type of material should be removed.

(2) Although surface breakouts or leaks will indicate the distribution pattern of the grout at the foundation surface, such leaks are wasteful and may not permit the development of the desired injection pressure buildup. In the interest of completely treating the critical upper surface, the following methods may be used to control surface leakage.

(a) Use of the accepted methods of rock foundation treatment discussed in paragraph 4-2b of EM 1110-2-2300 should be considered prior to grouting.

(b) Leave the foundation excavation several feet high and set the bottom of the nipples or packers at final grade. After grouting is complete, remove material to final grade, taking care not to disturb the grouted rock. This facilitates treatment of the final upper surface of the foundation and protects it from damage by grouting equipment. Construction of a temporary earth embankment along the grout curtain serves the same purpose, but may hinder washing operations and will mask the leakage patterns.

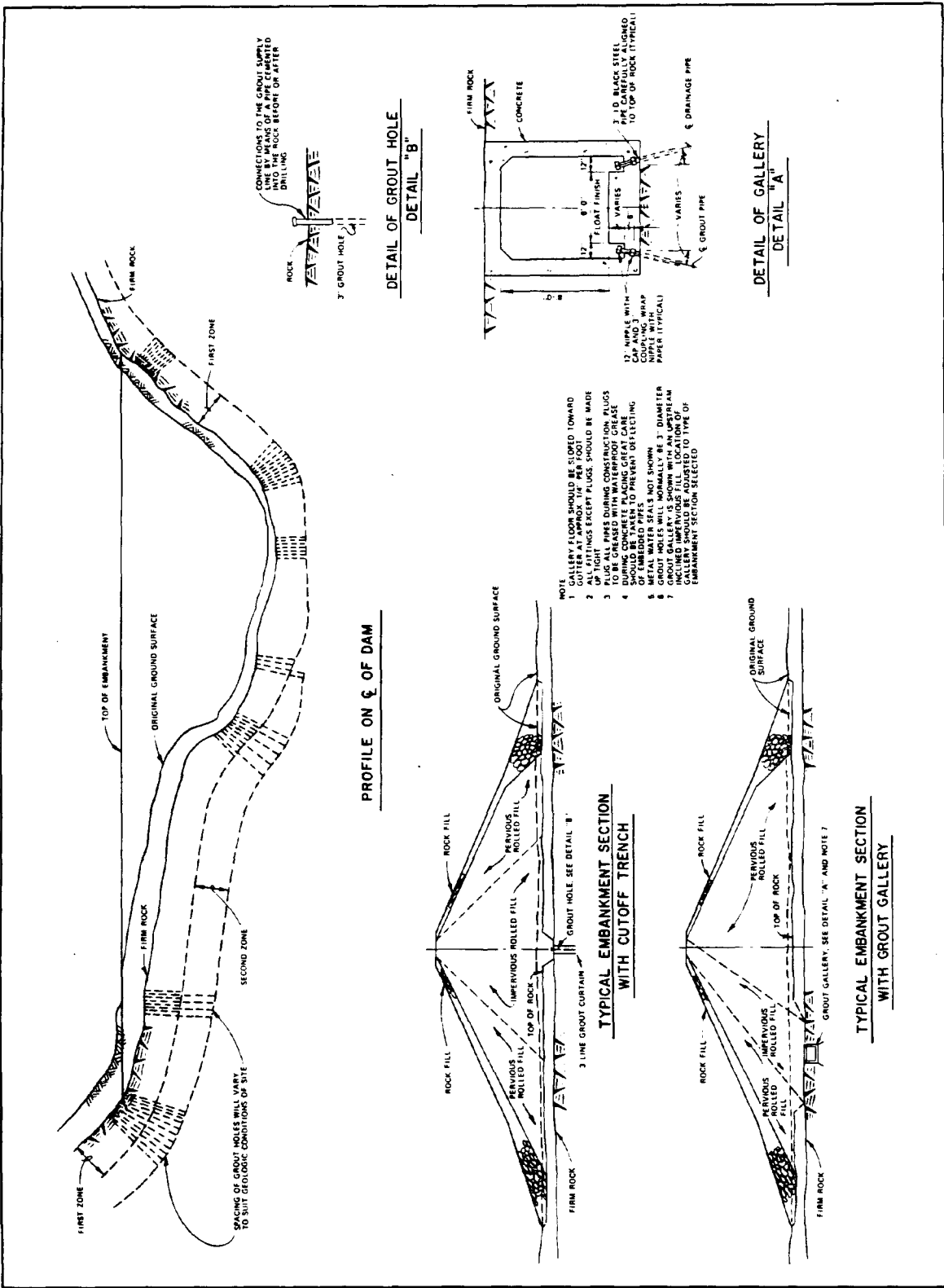

Figure 7-2. Grouting patterns

20 Jan 84

(c) Caulk the leaks in the surface of the bedrock with wooden wedges, dry pack cement grout, oakum, burlap, or other materials.

(d) Pump a thick grout into the hole until it surfaces and fills the fissure, then discontinue the pumping until the grout is set up sufficiently to plug the leak. If the effectiveness of subsequent grouting in lower zones may be questioned because of the tendency of the previous leaks to reopen and relieve grouting pressure, set a packer near the bottom of the previously grouted zone. After the final depth is grouted, grout at full pressure from the pipe connection at the collar of the hole.

(e) Dike the leak and allow the grout with added accelerator to set up.

(f) Add additional shallow surface holes to distribute grout at shallow depths.

c. Grout Hole Connectors. Grouting is usually done through pipe nipples grouted in the tops of the holes or through packers. Where rock is too soft or friable to hold them, the nipples may be embedded in concrete. If problems with nipples breaking loose are anticipated, the specifications should contain provisions for using a packer.

d. Area/Blanket/Consolidation Grouting. Grout holes usually less than 30 feet deep on a closely spaced grid pattern are often used in the upstream portion of the foundation or under the entire impervious core contact area. This pattern consolidates the critical upper surface and treats any unseen weak zones, and affords better protection of the core from piping. The operation should be accomplished prior to curtain grouting to take advantage of pretreatment of the upper zone.

e. Grouting Through Embankments. In new dam construction the grout curtain should be completed prior to construction of the embankment for the following reasons:

(1) Hydraulic fracturing or washing of the embankment may occur if fluid is used in drilling.

(2) Drilling with air below the piezometric surface creates high differential pressures in the hole, which may result in collapse of the hole or fracturing of the embankment.

(3) Washing and pressure testing are critical because of the danger of erosion at the embankment-foundation contact.

(4) No observations can be made as to grout travel or treatment of specific critical areas.

20 Jan 84

(5) The tight pattern of holes will probably not be constructed as designed because of deviations during drilling.

(6) Use of high grout pressure may heave and crack the embankment.

(7) Grout travelling downstream through the foundation may affect drainage.

(8) Grouting through an embankment invariably involves higher costs. Grouting has been done through completed dams as a remedial measure. Casing should always be used through the embankment and grouting should only be done through packers.

f. Grouting Galleries and Adits. Grouting and drainage galleries are common in concrete dams and have been used in earth- and rock-fill dams. Adits in abutments have been used for grouting and drainage on Corps dams. Adits and galleries are constructed prior to placement of the embankment as reinforced concrete structures in bedrock or as tunnels excavated in the foundation or the abutments. Grouting galleries have been used as an expedient to allow the embankment to be constructed and grouting to be done during, or following, completion of earthwork. See figure 7-2. Some possible benefits from using adits and galleries in earth- and rock-fill dams are:

(1) Construction of the embankment can be carried out independently of the grouting schedule.

(2) The advantages of grouting with the additional weight imposed on the foundation (higher grout pressures) can be realized, while most of the objection to grouting through the embankment can be eliminated.

(3) Adits are also excellent exploratory tools that give detailed data on the nature of the rock discontinuities to be treated.

(4) Galleries and adits allow access to the foundation during and after reservoir filling so that additional grouting can be planned and results evaluated from direct observations.

(5) If galleries and adits are used for drainage holes, pressure can be partially relieved immediately downstream of the grout curtain.

(6) Galleries and adits can be used to house foundation instrumentation outlets. Design of the gallery and impervious section of the dam must consider that the full reservoir head will be dissipated through the core immediately above the gallery.

g. Grout Caps. Concrete grout caps have been used for earth dams, particularly in areas of weak or highly fractured rock, to impede surface leakage and to provide anchorage for grout connections. Grout caps are constructed as

20 Jan 84

concrete trenches encompassing all grout lines, and are usually 3 to 6 feet deep, but may be large and deep enough to contain a grouting gallery for future inspection and remedial grouting. Use of a grout cap has the following advantages: (1) minimizes development of surface leaks, (2) provides a leveling course for operations, (3) trench construction ensures treatment of the upper foundation by providing a positive cutoff and added protection for the embankment, (4) creates a wider grouted area by forcing grout to travel longer horizontal distances, (5) tends to eliminate the ungrouted upper few feet, which may be experienced with nipples, and (6) eliminates problems with setting nipples (if nipples are set in concrete or drilled after completion). Disadvantages include (1) masking of breakouts, (2) rock damage during excavation for the cap, and (3) possible uplift or cracking creating seepage paths through the concrete. Caution. A grout cap will not permit a significant grout pressure increase in the upper zone of the grout curtain, and must be strong enough to handle loads from the placing and compacting of overlying fill.

h. Abutment Grouting. The same applications for general grouting apply to abutment grouting. When there is a change in orientation of holes from those of the adjacent foundation, additional grout holes should be fanned at the change in attitude or the segments of the curtain overlapped to ensure the continuity of the grout curtain. All or part of the grout curtain can be constructed from adits, usually at a higher cost but with the same potential benefits as described in e above. The surface from which grouting operations are performed can be greatly improved through use of the treatments outlined in paragraph 4-2c, of EM 1110-2-2300, before grouting.

i. Reservoir Rim Grouting. Under certain geological and project operation conditions, leakage from the reservoir may be a problem and require treatment. Loss of water through narrow ridges or through karst topography could affect the economics and safety of the project, and the regional groundwater conditions. The potential for these conditions should be identified during the exploration and design stages. Methods include mapping the reservoir, exploratory holes, a detailed groundwater survey, and pump tests to determine potential leakage. If considered necessary, rim grouting should be included as a part of the dam contract and should be designed to reduce leakage to an acceptable level. A decision to defer rim grouting until later might be made in some instances, and would be an acceptable alternative if access is assured. Monitoring in this case should be accomplished through the use of observation wells placed strategically around the rim.

j. Blasting. Special attention should be directed to limitations on blasting after grouting. It may be necessary to monitor the blasting and establish limits for each project. As a rule, grouting should be accomplished after all blasting in the area has been completed.

CHAPTER 8
APPLICATION TO TUNNELS, SHAFTS, AND CHAMBERS

8-1. General Applications: The areas of application covered in this chapter have found ever-increasing uses in civil projects. Subsurface structures requiring isolation from water and hardening for resistance to shock frequently are treated by grouting.

8-2. Purposes of Grouting. The purposes of grouting tunnels, shafts, and chambers are generally to consolidate the surrounding materials and to protect the structures from the following:

- a. Water infiltration.
- b. Chemical attack.
- c. Shocks.
- d. Instability.
- e. Radiation (waste disposal).
- f. Uneven load transmittal or distribution.

8-3. Applications.

a. Tunnel Treatment. Water infiltration or unstable conditions during driving operations or into old sections of tunnels may require pressure grouting. The grouting is usually accomplished using portland cement or chemical grouts, or combinations of both.

(1) Grout holes. Holes are oriented to best intercept known or suspected fissures, weak zones, and fractures in rock. Size of drilled holes may range from AW (48 millimeters) to NW (75.7 millimeters). A primary system of holes is initially drilled on selected spacing. Pneumatic or mechanical packers are placed near the collar of the hole. Water, sometimes dyed, is used to pressure test the area being prepared for grouting. Pressure gages are placed in-line at the hole collar and at the pump discharge head. Grout is injected and carefully monitored for take and pressures. Split-spacing may be required to accomplish additional grout injection. Grout mixtures, pressures, pumping rates, depth of grout holes, and drilling and grouting sequence of the holes are determined in the field. In flowing water conditions the use of quick-setting grouts incorporating accelerators with the possible addition of fillers, such as chopped and shredded cellophane, shredded rubber, sawdust, crushed cottonseed hulls, and high-density fines, have in some instances completely sealed or reduced the flow to acceptable levels. Chemical grouts have also been very effective due to their controlled gel time. Applications for

seepage cutoff in dam projects are described in paragraph 5-5, and additional discussion is given in EM 1110-2-2901.

(2) Equipment. Standard drilling and grouting equipment should be of the electric- or air-powered type normally used for underground work. The equipment should be sufficiently durable, compact, and light for easy transport. Telephonic communications are frequently necessary between the header and grout pump.

b. Shaft Treatment. Ring grouting is normally employed to seal a permeable, water-bearing formation or rock fissures and fractures prior to shaft sinking. The treatment is accomplished by drilling a series of angled or vertical holes from the perimeter of the planned shaft. Combinations of portland cement and chemical grouts may be employed for such applications. Before the grout is injected, pumping tests are conducted using water to indicate grout takes as well as to ascertain a range of gel times for the chemical grouts, assuming that these grouts may be pumped as easily or nearly as easily as water. After the primary ring of holes is grouted, a second and possibly a third ring may be required. Split spacing of holes may subsequently be necessary in one or more of the rings to form an adequate ring curtain. As the shaft sinking advances, additional grouting may be required from inside the shaft if the degree of permeability encountered downshaft is judged to be undesirable.

c. Liner Grouting. Liner grouting is normally undertaken following the placement of tunnel or shaft liners, which are usually constructed of concrete but may also be constructed of steel. Grouting of the space between liners and the formations in which liners are placed is referred to as backpack grouting. This grouting usually requires the use of portland cement grouts. The grout is injected from the invert of the liner for a tunnel and displaced upward. Holes drilled above the injection points provide venting as well as determine the progress of grouting and may later be used as injection points. Backpack grouting at the tunnel crown contact area requires that pressure be maintained until hardening of the grout occurs to ensure intimate contact of the grout with the crown. Expansive cement grouts are frequently used to contact grout crowns after the backpack grout has hardened. For shaft linings, a series of radial holes is drilled and grouted from the inside of the shaft. Hole spacing and sequence will vary, but usually split-spaced secondary holes will be drilled and grouted. Closely monitored low to moderate pumping pressures are used to inject grout behind liners.

d. Consolidation Grouting. Where excavation of a tunnel or chamber has loosened the surrounding rock, or caused minor movements prior to lining placement, it may be necessary to consolidate the rock and fill open joints and fractures. In these cases grout holes can be drilled through the lining to the depth of disturbance, and grouting accomplished as described in paragraph a above.

20 Jan 84

e. Permanent Drain Holes. Permanent drain holes are drilled to intercept seepage through structures to relieve uplift and hydrostatic pressures. These holes should always be drilled after the completion of all grout injections conducted in a particular area. Drain holes 3 inches in diameter will be adequate for most conditions. The spacing of drain holes can range from a few feet to as much as 20 feet. The spacing is largely based on the permeability of the areas to be drained, and close spacing is required for areas of low permeability.

CHAPTER 9
APPLICATION TO NAVIGATION STRUCTURES

9-1. General. Grouting for navigation structures is ordinarily performed prior to, or during, the original construction to improve the foundation or reduce seepage and uplift pressures. Remedial grouting under slabs or foundations may also be required after construction as well as for wall repair applications. The application of foundation grouting would be similar to that described for dams in chapter 7.

9-2. Foundation Treatment. The mass strength and permeability of the soil or rock of the foundation on which the structure is founded may require preconstruction improvement or subsequent remedial work. Treatment may be required both for permanent work as well as temporary structures such as cofferdams. These improvements may be achieved by using various types of applications involving the injection of cement or chemical grouts or both. A laboratory evaluation of the materials planned for use in the treatment is recommended, followed by onsite injection tests and core recovery from injected areas. Structures suffering foundation erosion can be grouted with the conventional equipment and materials frequently used in grouting large voids. Special consideration should be given to the ability of the grout to seek its own level, the bonding properties of the grout injected into areas of exposed piling so as not to increase the dead weight of the structure, and the rate of flow of the water in the area to be grouted. Parts of chapters 7 and 10 of this manual describe various applications for foundation improvements. EM 1110-2-3504 is a recommended reference, as well as "Consolidation Grouting at an Existing Navigation Lock," by Neff, Sager, and Griffiths.

9-3. Repairs. Wall, slab, apron, and foundation repair of navigation structures is often necessary. Special grouting applications are frequently required.

a. Vertical Concrete Walls. Cracks may develop and horizontal and vertical construction joints may become highly permeable in vertical concrete walls. Grouting methods are described in EM 1110-2-2002. Natural weathering, mainly freezing and thawing, often results in cracking and spalling; barge traffic through locks also generally results in severe abrasion not only in the upper section of guide walls but also of the main lock walls. Repairs may be made by injecting water-insensitive epoxies. Repair of large cracks may be accomplished by using fine, dry sands as a filler in epoxies. Spalled areas located on vertical walls often require forms to retain either a portland cement grout or an epoxy/sand grout. Special epoxies are formulated for use in much patching work. As a result of advanced epoxy technology, a great variety of epoxies are available for specific job requirements, such as injectivity into dry or wet cracks and bond of old concrete or grout to new grout. A method of repairing areas severely abraded by barge traffic involves placing steel armor plates over the abraded areas by anchor bolting, sealing the bottom and end edges by caulking, and injecting portland cement grout through

EM 1110-2-3506

20 Jan 84

grouting nipples that are located near the bottom of the armor plate. This grouting operation is conducted in compartmentalized sections provided between the armor plate and the concrete face. For additional information on vertical wall repairs, refer to WES TR C-78-4 and WES Translation No. 65-4 (app A).

b. Slab and Apron Crack Repair. Repair for navigation structures is conducted using epoxies and portland cement grout applications. The WES publication, "Maintenance and Repair Practices for Pavements, Facilities Engineers," is a recommended reference.

c. Filling voids under slabs and aprons and stabilizing and jacking slabs are covered in paragraph 11-3d and e.

9-4. Grout Curtain Through the Lock Area. Conditions in the foundation of locks will in many cases require the placement of a grout curtain. The method of placement of such curtains is generally the same as that for curtains placed in the foundations of concrete dams. The emplacement of these curtains is described in detail in paragraph 7-1. The grouts used in these curtains may be either portland cement, chemical, or both.

CHAPTER 10
APPLICATION TO BUILDING FOUNDATIONS

10-1. General. All buildings, regardless of type and design, must be founded on and supported by competent soil or rock or the foundation must be modified to assure adequate support. Foundations may be in need of improvement for various reasons: e.g., to increase their strength or rigidity, to prevent the erosion of subsoil by adjacent water flow, to prevent cavity formation and soil shrinkage occurring as a result of water drawdown, to prevent subsidence and cavities created as a result of solution channels in underlying limestone, to prevent unbalanced soil pressure conditions resulting from differences in elevations, and to prevent the erratic behavior of soft clays subject to changing moisture conditions. This chapter is devoted to grouting of building foundations which have been found to be in need of improvement.

10-2. Pregrouting Investigation.

a. Physical and Mechanical Properties. The physical and mechanical properties of foundations must be thoroughly investigated and well defined during the planning of grouting treatments.

b. Field and Laboratory Testing. Investigations are normally conducted under the direction and supervision of the foundation engineer responsible for the design and construction of the foundation for the building. The major field tests may include standard penetration tests, visual classification of soils, grouting tests, geophysical explorations, and groundwater monitoring. Laboratory tests will normally include classification, moisture content, density, void ratio, chemical analysis of water, and strength tests.

10-3. Soil Stabilization. A number of treatment methods have been successfully used to stabilize soil. Soil-cement and soil-asphalt mixtures are proven methods; however, their uses are limited to surface treatments. Intrusion grouting consists of mixing in-place soil and grout to form low strength soil-grout cylindrical piles. Compaction grouting consists of using very stiff consistency grout mixtures which, under closely controlled pressures, compact the soil by displacement. The grout remains a distinct mass in close contact with the compacted soil.

a. Intrusion Grouting. This type of grouting consists of mixing in-place soil and cement grout to form soil-grout cylindrical piles. This procedure requires specialized equipment which consists of a hollow tube with vanes at the lower end. These vanes are rotated slowly while being forced into the soil. This process permits either cement grout or chemical admixtures to be introduced through the tube for subsequent mixing with the soil to form a piling system.

b. Compaction Grouting. This method of soil stabilization consists of using stiff consistency cement grout mixtures which are pumped to subsurface

20 Jan 84

locations in predesigned patterns. The mixtures are placed using nonpulsating-type pumps under highly controlled pressures. The soil is stabilized by displacement. The grout remains a distinct mass in close interfacial contact with the compacted soil. Compaction grouting has been used to increase the bearing capacity of soils under slabs and spread footings, and to improve end-bearing and friction in pile foundations. Samples of the emplaced grout and compacted soil may be obtained for conducting desired laboratory tests.

c. Chemical Grouting. Chemical grouting may be used to control subsurface infiltration of water or to increase the mass strength of problem soils. The soil penetration range, by grain size, of the various chemicals is shown in figure 10-1. Distribution of the grout in foundation soils may, to a large

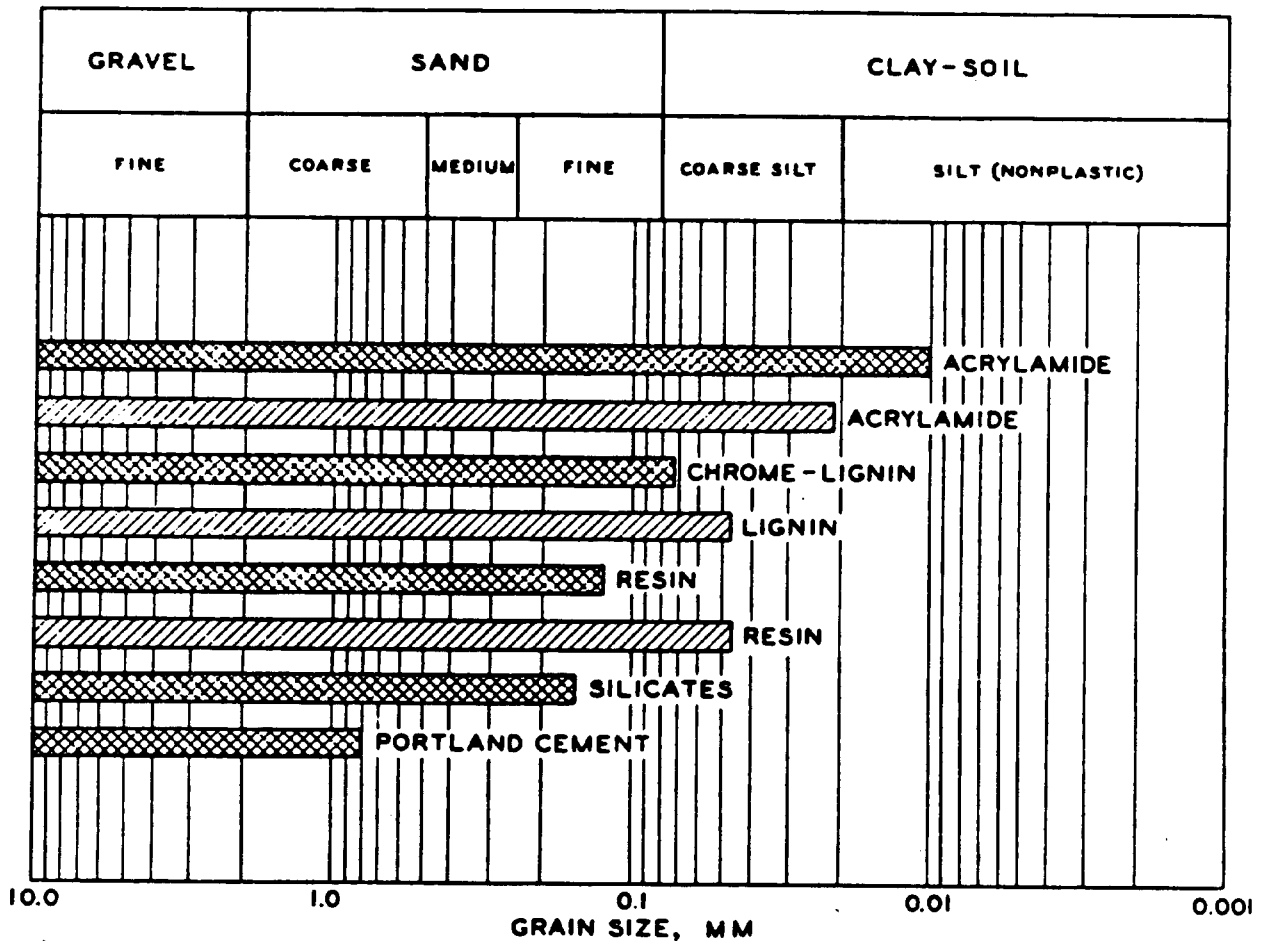

(Courtesy of American Cyanamid Co. and Halliburton Services)

Figure 10-1. Injectivity limit for grout

20 Jan 84

extent, be controlled by adjustment of the gel times. Generally, chemical grouts are considerably more expensive than the asphalt, cement, or clay grouts. Chemical grouting should be considered for those applications where their use is warranted to obtain desired results and when it is economically justified. Postgrouting field and laboratory testing programs should be conducted to determine the adequacy of the chemically grouted soil to support the foundation of the planned structures. (EM 1110-2-3504, and "Soils Engineering," R. H. Karol (app A).)

10-4. Rock Foundations. Grouting of rock foundations for buildings may be desirable in cases where the foundation rock is solutioned limestone, where it is highly fractured and broken, or where it contains open joints. The grouting will not only consolidate the rock and add to the bearing strength, but will aid in preventing piping of soils into the rock fractures and cavities. Grouting may also be used in jointed rock to consolidate the rock prior to blasting and excavating where close tolerances in excavation limits are required.

CHAPTER 11 PRECISION AND SPECIALTY GROUTING

11-1. General Statement. Precision grouting may be defined as the placement of a special type of grout in a well-defined area under a highly controlled application to meet rigid job requirements. Specialty grouting may be defined as those applications that deviate from conventional techniques. Precision and specialty grouting operations require careful selection of grout mixtures and thorough planning. The most experienced grouting personnel should be assigned such grouting tasks.

11-2. Scope. Grouting can be used in a variety of unique situations. Precision and specialty grouting may require only small amounts of grout, but the outcome may be very significant.

a. This chapter is applicable in part to concrete structures; consequently, grouting techniques, mixtures, materials, and equipment normally utilized for concrete repair can be used on these structures. EM 1110-2-2002 is a comprehensive manual covering many different types of materials, equipment, and repair techniques. This manual not only discusses the use of portland cement grouts, but also concrete, asphalt, shotcrete, drypack, preplaced aggregate concrete, epoxy resins, protective surface coatings, and joint sealers used in repair work. The manual also contains discussion of crack repair, major repairs, and surface repairs.

b. Civil projects that may include grouting as a part of original construction or for repair include highways, surfaces and underground powerhouses, large buildings, and flood control structures. Grouting may be required for repairing and/or strengthening any of the structures listed as a method of satisfying immediate and long-range project needs.

11-3. Applications.

a. Tendon Grouting. The purposes of this type of precision grouting are to provide protection to the steel tendons as well as to provide good bond between the tendons and the ducts, thereby improving the durability and load-carrying capacity of the structural member. Mixtures used in tendon grouting should contain materials that provide protection of tendons from corrosion and are virtually free of components such as chlorides and sulfides that promote stress corrosion of tensioned steel tendons. The mixture should exhibit little or no bleeding and should be shrinkage compensating. The mixture should be easily pumped and free of fine aggregate to ensure maximum penetration into small spaces between tendon strands. The grout should have prolonged pumpability time to provide for recirculation during injection. Admixtures should be used that contain water-reducing agents, controlled expansion additives, and dispersant agents and that produce a grout that is thixotropic for a limited time, shrinkage compensating, dense, and high in strength development when added to portland cement mixtures. Mixtures used for injection

20 Jan 84

into tendon ducts should have high fluidity. Mixing equipment preferably should be of the continuous colloidal or high speed shearing type, and the positive displacement, nonpulsating type of pump should be used for injection.

b. Machine Base Grouting. Civil projects sometimes include the grouting of extremely large steel plates that form the bearing base plates for generators, turbines, roller mills, compressors, rails, column plates, and a variety of production-type heavy machinery. The machine base plates are usually positioned over concrete foundations and fixed by anchor bolts. Shims are used to level base plates, usually leaving 1 to 3 inches between the plate and concrete foundation to be grouted. The space is formed on all sides to contain the grout, which is either poured or pumped beneath the plate from one side only to minimize possible entrapment of air. The grout placement is best accomplished in one continuous operation. The selection of mixtures for use under machine bases and similar placements is described in CRD-C 621 (app A). For very high strength grouts, additives such as silica fume may be considered after appropriate laboratory testing.

c. Rock Bolt Grouting. There are many types of rock bolt anchoring systems. EM 1110-1-2907 includes information on how to install and grout rock bolts.

d. Slab Stabilization. Slab stabilization is a method that utilizes grout to fill voids beneath concrete slabs to minimize impact loading damage, correct faulty drainage, and prevent pumping at transverse joints and contraction cracks. A variety of grout mixtures and mud-cement slurries are used to accomplish this. The WES publication, "Maintenance and Repair Practices for Pavements, Facilities Engineer," contains useful and detailed information on slab stabilization.

(1) Grout mixtures composed of finely graded, clean sand and cement, with admixtures if needed, provide long-term stability beneath slabs, and have recently been replacing mud-cement slurries.

(2) Mud-cement slurries tend to develop very little strength and can shrink, and prove to be unstable in wet conditions. Slab stabilization is usually conducted while old slabs are being prepared for resurfacing. Major items of equipment required are a core drill; a concrete or pug-type mortar mixer; a positive displacement, nonpulsating type grout pump; and associated equipment and accessories.

e. Slab Jacking. Slab jacking is actually an extension of slab stabilization; however, the application is somewhat more involved. Slab jacking may be described as a quick and economical method of raising a settled section to a desired elevation by pressure injecting cement grout or mud-cement mixtures under the slabs.

(1) Purpose. The purpose of slab jacking is to (a) improve the riding

20 Jan 84

qualities of the surface of the pavement, (b) prevent impact loading over the irregularities by fast-moving traffic, (c) correct faulty drainage, (d) prevent pumping at transverse joints, (e) lift or level other structures, and (f) prevent additional settlement.

(2) Mixtures. A grout mixture consisting of a finely graded, clean sand and cement, having approximately 20 percent cement and well-graded, clean, fine sand with about 30 percent or more fines passing the No. 200 sieve, can be easily pumped and will develop adequate strength. The water content of such a mixture must be one to produce a low-viscosity consistency, yet have sufficient viscosity to maintain the sand in suspension. In the case of mixtures composed only of sand, cement, and water, various types of admixtures may be added to the mixture to either accelerate, retard, or expand the grout; however, such additives should be used with extreme care and their effect on the grout studied by testing in the laboratory prior to use in the field.

(3) Equipment. The minimum major items of equipment normally required to conduct a slab jacking operation efficiently are stated in d(2) above.

(4) Application.

(a) Extreme care must be exercised during slab jacking operations to prevent pyramiding of the grout under the slab in the immediate vicinity of the injection hole. The grout should raise the slab slowly and with uniform pressure. To accomplish this, an array of holes must be drilled through the slab in a pattern that will permit the lateral flow of grout to penetrate all areas under the slab, and the jacking rate should be slow enough to permit the grout to fill all existing voids properly and completely. Only general rules can be used in determining the location of holes for grout injection. The operator learns to space holes according to the particular job at hand. Holes generally should not be placed closer than 18 inches to edges or joints. They should be at locations spaced not more than 6 feet on center so that approximately 25 to 30 square feet of slab is raised by pumping any one hole. Excessive pumping in any one location may result in cracking of the slab. A closer spacing arrangement of the holes will be required if the slab cracks. Additional holes may occasionally be required to fill voids that have no communication with each other. The diameter of the holes should be 1-1/4 to 1-1/2 inches.

(b) If the grout is pumped too quickly, the slab may be cracked by pyramiding. A thick slurry grout should be used initially for slab lifting. A thick grout should not be pumped at rates exceeding 1 cubic foot per minute. The pumping rate for low viscosity and thin grouts may be increased to as much as 3 cubic feet per minute.

(c) When jacking is done from one hole, the grout injection should continue until the grout appears in adjacent holes or the slab is raised to the proper grade. Adjacent holes may temporarily be sealed with wooden plugs,

which can readily be removed following the setting of the grout. When the grout nozzle is removed following the completion of slab jacking operations, all holes should be cleaned and filled with a stiff 1:3 cement-to-sand mortar mixture, which is tamped into place and floated to a smooth finish.

(d) Application of the slab jacking method must be carried out by competent, experienced crews. A slab-jacking crew generally consists of from 6 to 10 people.

f. Lost Circulation Grouting. During the drilling of boreholes, drilling fluid circulation may be lost to a highly fractured zone or a weak or porous formation. In the event of lost circulation, materials may be added to basic portland cement grout mixtures to block, bridge, or seal the openings in the formation. The lost circulation materials most commonly used include sands of various types and gradations, cellophane flakes of controlled sizes, ground plastic, shredded rubber, and crushed cottonseed hulls. These materials may be added to the cement slurry individually or in combinations; the latter rarely exceeds two materials.

g. Preplaced Aggregate Grouting. Preplaced aggregate grouting involves the placement of a selected type and gradation of a coarse aggregate in forms or cavities and the injection of a sanded or unsanded portland cement grout into the mass to fill the voids. This method is sometimes used for constructing "cast in place" piles, and for providing roof support for abandoned mines. Useful information in planning preplaced aggregate grouting is discussed in WES Technical Memorandum 6-380.

h. Postplaced Aggregate Grouting. The placement of grout into forms or cavities prior to the placement of the aggregate is a quick and economical application. The grout mixtures can also be proportioned with a lower water content since pumping into injection pipes is not necessary. The grout is initially introduced into the placement area and is followed by the placement of the aggregate by clamshell, end loader, or other means. Maintaining a grout level above aggregate placement is important at all times except when "topping off" nears. Means should be provided to finish and cure the surface.

i. Foam Slurry Grouting. The constituents that compose foam slurries and a range of physical properties are briefly described in paragraph 5-2c. Mixing and pumping systems generally consist of in-line metering foam generators or transit mix trucks, tub mixers, and ribbon blenders. A measured amount of foam is introduced into a measured amount of cement slurry for homogeneous mixing. The advancing cavitation-type pump is best suited for pumping foam grout. Injection lines four or five inches in diameter have been found to be satisfactory for the placement of foamed slurry grouts.

j. Saltwater Grouting. Saltwater grouting is conducted during the sinking and driving of shafts and tunnels in salt formations and behind borehole casings that either terminate in cavities excavated into salt domes, or pass

20 Jan 84

through salt formations for various purposes. Grouts developed for possible use in waste isolation in salt formations require extensive developmental work in providing a grout having a durability of extremely long life. The grout mixture used should contain approximately 3 pounds of sodium chloride (NaCl) in solution per gallon of mixture water to provide a brined, saturated mixture water that will prevent dissolution of rock salt and contact faces. Amounts of salt in excess of approximately 3 pounds per gallon tend to retard portland cement mixtures, whereas amounts less than 3 pounds per gallon may result in a degree of acceleration of the set. Salt-saturated mixture water should also be considered in grouts proposed for use in saline environments. Attapulgitic clay is used in lieu of bentonite in salt grouts.

k. High-Density Grout Placements. Structures constructed for nuclear and high-energy laser research and hazardous waste storage frequently require high-density walls, ceilings, and floors. Such construction may be accomplished by using the preplaced aggregate method; magnetite or ilmenite coarse and fine aggregates or other types of high-density aggregates are substituted for the conventional types of aggregates normally used. Particular attention must be given to forming, which must be designed to support heavy loads and to be essentially watertight.

l. Grouting Waste Disposal Wells. Extremely high durability grouts should be developed for use in plugging hazardous waste disposal wells. This application requires portland cement grouts that are expansive, impermeable, and highly resistant to chemical attack. A waste disposal well may be plugged with grout by means of conventional oil well cementing equipment or similar grouting systems. The grout may be placed in a single stage or a number of stages through the use of the drill stem and the draw-works of the drill rig. A variety of downhole tools are available for such operations. Extensive quality assurance is needed in this type of application.

m. Pile Jacketing. Bridge and causeway pilings frequently suffer extensive deterioration as a result of water erosion, scouring, and marine infestation and growth. An economical and expedient method of repairing these pilings is encasement of the pilings in a protective jacket of grout. The jackets normally consist of baglike nylon forms placed around steel reinforcing mesh that has been attached to the damaged area of the steel, concrete, or wooden piling to be jacketed. The nylon form is then filled with the grout. The grout mixture is normally proportioned using a sand filler and a grout fluidifier and may contain Type III high early-strength cement when conditions may require early setting and strength development. This application, using conventional portland cement grouting equipment, may be made both under and above water.

n. Grouting for Powerhouses and Deep-Buried Structures. Powerhouses, both above and below the surface, and deep-buried structures may require grouting. Void areas in the surrounding soil or rock adjacent to powerhouses or deep-buried structures can be grouted with well-designed grout mixtures to further enhance the stability and durability of the structures.

20 Jan 84

o. Riprap Grouting. The stabilization of riprap placements may be improved by grouting the unconsolidated riprap. Riprap grouting may be accomplished above and below water in providing slope protection for revetments, shoreline stabilization, levee facing, and similar projects. Riprap grouting applications normally consist of the gravity or pump placement of fluid sanded-cement grouts into the voids existing in riprap. The mixtures may contain up to 3 to 4 parts of sand by weight of the cement. For the steeper slopes, more viscous grout is required. The grout is usually filled to approximately 1/2 to 3/4 of the depth of the voids and, where possible, topped out by brooming and cured by conventional methods.

CHAPTER 12
PERFORMANCE OF WORK

12-1. General Considerations. Grouting may be part of a general construction contract or may be performed by separate individual contract. Grouting programs may also be accomplished by hired labor and Government-owned equipment. The type of procedure to employ is dependent upon the project complexity and completion schedule, existing economic conditions, technical and manpower considerations, organizational structure, and workload.

12-2. Contracts.

a. General Contract.

(1) Performing a grouting program under the general construction contract eliminates contractual difficulties that might arise from interference between these operations and other construction activities. Furthermore, the general contractor electing to perform the work with his own organization can use his personnel for other job operations when the drilling and grouting work is slack. The costs for shop facilities, power, general supplies, transportation, and administration will normally be less if the work is done by the general contractor rather than by separate contract.

(2) Most general contractors, however, do not have grouting equipment, and the grouting is sublet to subcontractors specializing in this type of work. A disadvantage to this type of contract is that, contractually, the Contracting Officer's Representative (COR) is removed from the subcontractor (i.e., the COR is not coordinating with the subcontractor) actually performing the grouting and it makes it more difficult to administer and maintain control of the grouting operation.

b. Separate Contract. Accomplishing a grouting program under a separate contract allows the grouting specialist to be the prime contractor, but may provide a situation whereby one contractor may interfere with the operations of another, if the grouting operations are scheduled to be done concurrently with other contract work. For a dam project, large amounts of excavation may be required prior to the grouting. However, if close coordination and cooperation are maintained with the contractors when the sequence of construction operations is being planned, an efficient separate contract grouting program may be developed.

12-3. Hired Labor. The use of hired labor to accomplish the grouting program provides greater flexibility of operations and quicker response in emergency situations than can normally be obtained by contract. This is an important consideration in such work where the extent of treatment and the procedures employed are contingent upon the conditions encountered as the work progresses. Other advantages of performing the work with hired labor are:

EM 1110-2-3506

20 Jan 84

a. The Government-owned equipment is available for use on other projects.

b. The qualifications of the workmen are known.

c. More positive control of the work can be maintained.

CHAPTER 13
FIELD PROCEDURES

13-1. General Considerations.

a. Regardless of the number of exploratory borings or other preconstruction investigations, information on the size and continuity of groutable, natural openings in rock below the surface will be relatively meager at the start of grouting operations. The presence of groutable voids can be ascertained before grouting and can be verified by grouting, but the sizes, shapes, and interconnections of the voids will be largely conjectural. The art of grouting consists mainly of being able to satisfactorily treat these relatively unknown subsurface conditions without direct observations. One of the benefits of most grouting programs is exploration. A carefully monitored and analyzed drilling and grouting program can provide significant information about a foundation. It cannot be stressed too strongly, however, that the data gathered must be correlated and analyzed to be of any benefit. The discussions of grouting practices in this manual are intended as a guide, but are not expected to replace experience.

b. Grouting procedures depend on the job, policy, objective, geology, contractor, field personnel, and individual judgment and preference. Procedures subject to variations depending on field technique include drilling, washing, pressure testing, selection and adjustment of mixes, changing grouting pressures, flushing the holes and washing the pump system during grouting, use of delays, intermittent grouting, determining the need for additional grout holes, treatment of surface leaks, and maintaining up-to-date records of drilling, grouting, and monitoring.

c. Local adjustments of the angles, orientation, and spacing of grout holes should be made as necessary. New holes should be required as replacements for holes that are prematurely plugged. When adjustments to contract requirements are made, the designers should participate in the decision. The adjustments may include changing the spacing of primary holes, changing the angles and orientation of grout holes, or increasing or decreasing the grouting program.

d. Regardless of how well conceived and designed the grouting program is, the success of the program depends upon the field techniques used and upon good judgment by field personnel. Grouting techniques may not be subject to contractor quality control and should be directed by the Corps field personnel. For this reason, an experienced geologist should be in charge of the grouting program and he should be provided with an adequate staff.

13-2. Drilling Operation.

a. Since drilling is a vital and costly part of the foundation grouting program a record of all pertinent data should be kept by the inspector during

20 Jan 84

drilling operations. Entries in chronological order should be made in field books and should include all data of interest that would assist in the identification of the physical characteristics of the formation examined and would account for all time spent in drilling. A sample core hole log sheet is shown in figure 15-5. A form for this purpose should be provided for the inspector to enter data as the work progresses. Identification of material encountered and other pertinent remarks of a geologist assigned to the project should also be included in the log. The following general information should be recorded:

- (1) The hole number.
- (2) Drilling time schedule.
- (3) Names of drillers and inspectors.
- (4) Size of hole and inclination.
- (5) Stations or coordinates of hole.
- (6) Type and identification number of bit used, and make of drilling rig.
- (7) Elevations of start and of completion of drilling.
- (8) Location and cause of core losses, such as open joints or bedding planes, blocking of bit, grinding of intensely fractured rock, soft material, and gouge.
- (9) Results of pressure tests.
- (10) Location and nature of filled or open cavities.
- (11) Sections of hole cemented, reasons for doing so, quantity of cement used, and water-cement ratio.
- (12) Water table data at beginning and end of run and specific zones of water loss and gain.

b. Comments in regard to obtaining and recording data about drill manifestations for respective columns in the log sheet are as follows:

- (1) An attempt should be made to trap the return water in a vessel of some kind and measure the amount recovered during one minute. Record meter reading on water supply line over short time intervals to determine rate at which water is pumped through the tool string. The color of the water should be recorded at intervals and at changes throughout the run.

(2) The drilling speed should be recorded as the penetration rate, i.e., the time taken to drill a run.

(3) The action of the drill rig, such as jerky, smooth, rough, or steady, should be recorded showing the limits of such action. Particular attention should be paid to the driller, as he may be drilling at a speed too fast to get a core or he may be drilling at a slow rate and wearing out soft material. The drill pressure should be recorded here.

(4) The driller's log column should show the driller's interpretation of the nature of the formation encountered as drilling progresses. The inspector should obtain the driller's opinion without coaching or any discussion that might influence his statement regarding the matter. If the inspector disagrees with the driller, the reasons for doing so should be stated in the report but nothing should be said to change the views of the driller.

c. Non-Cored Holes: In holes drilled with percussion, plug, or other non-coring bits, much of the data from drilling must be obtained from examination of the drill cuttings and fluid. Valuable information can be gathered by correlating the drill action, color of drill water, and description of the cuttings.

d. It will be desirable to have the inspector turn in a transcript of his records at the end of each shift or hole drilled. The filled out forms and the core boxes will ordinarily be turned over to a geologist to complete the analysis and make up the final log sheet.

13-3. Grouting Operations.

a. Washing Holes.

(1) Washing of grout holes immediately prior to the injection of grout is necessary to a grouting program. The purposes of the washing are to remove all drill cuttings and mud from the grout holes and to flush cuttings, sand, clay, and silt from the fractures in the rock. These materials must be removed to the maximum extent possible so that the grout can be injected and so that windows may not later be eroded in the grout curtain by the removal of silt and clay left in place in rock fractures at the time of the grout injection.

(2) Open hole washing is normally done by inserting a small-diameter wash pipe to the bottom of the hole and injecting a jet of water, sometimes in combination with air, to wash out any material in the hole. This process is mandatory in percussion-drilled holes. There will be instances with rotary-drilled holes where it may be determined that the hole is sufficiently cleaned by washing through the drill rods for several minutes after drilling of the hole is complete. In any event, it is essential to verify that the hole is open to its maximum depth and free of any obstructions just prior to an

20 Jan 84

injection of grout. This may be done by measuring hole depth with a weighted tape measure. An obstructed hole should be washed again prior to grout injection.

(3) After the open hole washing is completed, it is then necessary to pressure wash the rock formation. The rock formation is washed either through a packer or a sealed connection at the collar of the hole. All adjacent grout holes are opened prior to the pressure washing to serve as exit points for the water injected into the hole being pressure washed. Water and, in rare cases, air under pressure are injected into the hole. The washing should be continued as long as the rate of water taken continues to increase or as long as muddy water vents from adjacent holes or surface leaks. Air injected in short bursts into the water is a method used to create turbulence and enhance the erosive action of the water. Air should only be used with extreme caution, in competent rock. Reversing the direction of washing may also be helpful. Reverse washing will make reconnection to the original hole and washing out of the hole necessary for a few minutes prior to grout injection. It is important to be constantly aware that excessive pressure can damage the foundations and previously placed grout. Water pressure and air pressure should not exceed the allowable grouting pressure during pressure washing.

b. Pressure Testing.

(1) Pressure testing is performed as part of the pressure washing operation. Its purposes are to obtain an indication of the permeability of the foundation, to determine the location of permeable zones, to verify seating of the packer for pressure washing, and to evaluate the effectiveness of the pressure washing. Adjacent holes are uncapped during the test to allow venting of the water. Each grout hole must be pressure tested.

(2) The test should be initiated prior to pressure washing by injecting only water into the hole for a minimum of 10 minutes under a steady pressure. The rate of inflow should be measured each minute. After 10 minutes, and if the test indicates that passages in the formation are being opened by the water, pressure washing should be initiated.

(3) After the pressure washing is completed, the pressure test should again be performed for 10 minutes. Records of the before and after pressure tests should be kept and included in the Foundation Report.

(4) The allowable grouting pressure must not be exceeded during pressure testing. Constant supervision must be maintained before and during the pressure testing and pressure washing operations.

c. The grouting equipment should generally be arranged to provide a continuous circulation of grout throughout the system and to permit accurate pressure control regardless of how small the take might be. Fouling of the equipment and lines should be prevented by periodically flushing the system

20 Jan 84

with water and by constantly circulating the grout. Pressure relief valves should be used for pressure grouting to reduce the possibility of foundation damage from excessive pressure. If gravity pressures are required, pressure relief should be provided by an open standpipe or injection should be directly into a funnel at the top of the holes, nipple, or standpipe.

d. A common rule of thumb in determining the maximum safe pressures for poor or unknown subsurface conditions is that the pressure in pounds per square inch at any elevation should not exceed the depth of rock in feet, plus one-half the depth of overburden materials over the rock in feet. This rule was derived considering only the weight of materials over the zone being grouted. Other factors affecting the maximum safe grouting pressure include rock strength, orientation of rock discontinuities or fractures, consistency of the grout, tightness of the hole, geology, and hydrologic conditions. Higher pressures can safely be used in many cases. Figure 13-1 is a rough

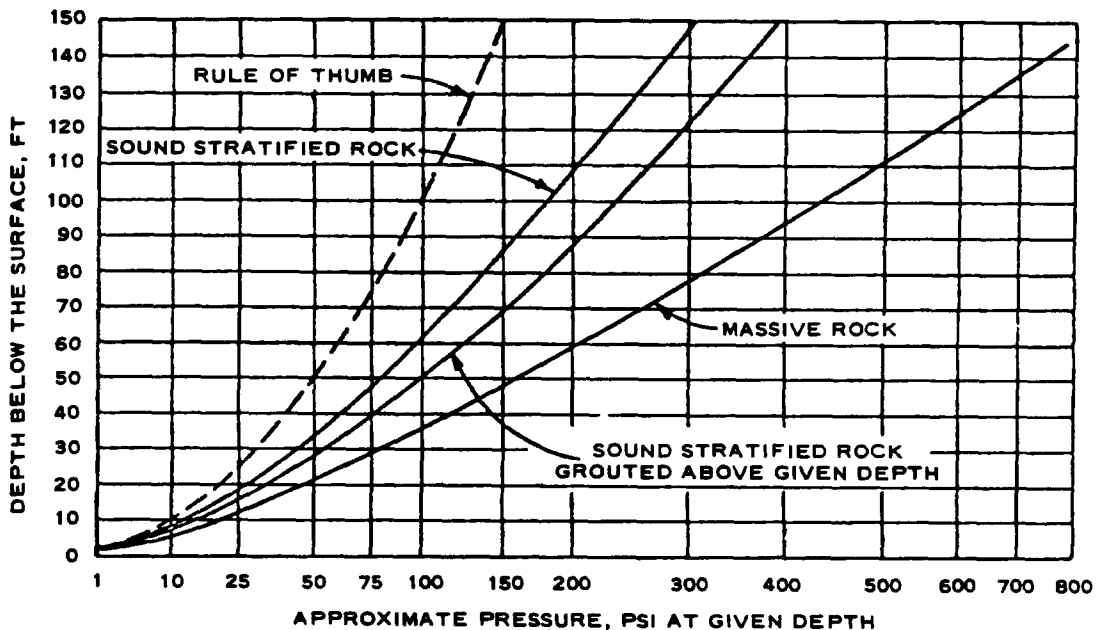

Figure 13-1. Rough guide for grouting pressures

guide for grouting pressures. The pressure exerted by the column of grout above the injection depth must be subtracted from the maximum allowable pressure to determine the maximum gage pressure at the collar of the hole. Examples of pressure computations are included in appendix C.

e. Most foundation grouting is done with grout composed of portland cement, bentonite, and water. The addition of a small percentage (2 to 4 percent) of bentonite produces beneficial results. Settlement is almost eliminated

20 Jan 84

without a significant reduction in strength or an increase in setting time. The grout is essentially nonshrinking and much superior results are achieved. Fluidizing agents may be added to reduce the viscosity of very thick grouts or for sanded mixes. Water-cement ratios are normally specified by volume of water and dry volume of cement (i.e., 1 sack of cement is considered 1 cubic foot). Figures 5-2 and 13-2 may be used for determining the cement content of various neat cement grout mixes.

f. Thin initial mixes (6:1 or thinner) are usually recommended, especially if the hole is dry or pressure tests indicate slow or small takes. Some formations that are quite pervious refuse 3:1 grout very quickly but will accept 4:1 or 5:1 grout. This justifies beginning with a thin grout even in pervious conditions. If the hole accepts a few batches of the starting mix without pressure buildup, thicker mixes are required; however, if the pressure builds up, grouting may continue with the same mix until refusal. If the rate of injection decreases and the pressure rises, the mix may need to be thinned. Figures 5-3 and 5-4 are charts that may be used in thickening and thinning grout.

g. Mixtures are usually thickened by batching a new mix in the mixer and discharging it into the sump after most of the thinner grout has been injected. If immediate thickening of the mix is required, the hole is shut off temporarily and cement is added to the sump. Mixing is accomplished by agitation of the sump and circulation through the pump and lines.

h. If the hole accepts a few more batches of the new thickened mix without pressure buildup, the next thicker mix is used. The process of thickening the grout continues until the pressure builds up, and then injection is continued. The rate of injection into the hole is slowly cut back when the pressure tends to rise until the hole refuses to take grout at the maximum pressure or meets the specified refusal criteria. As the water-cement ratio decreases, each integer change requires more cement. For example, going from 2:1 to 1:1 requires 67 percent cement. Therefore, mixes of intermediate consistency (e.g., 2.5, 1.5, or 1.25) are used after a consistency of 3.0 or 2.0 is obtained. If extremely thin (8:1 or thinner) grouts are used, a two-integer change is normally used when thickening the grout, i.e., 10:1 to 8:1 to 6:1. When sudden refusal and pressure buildup are experienced, premature plugging may have occurred. If the hole is still taking a small amount of grout, water should be pumped into it to reopen it if possible. After the water has been injected, a thinner grout mix may be required. If the hole is plugged, a new hole may be required. Other causes of sudden refusal include a blocked line, packer, or hole, a collapsed hole, or filled voids.

i. Rising pressures during grouting should be controlled so that they slowly rise in increments until the desired injection pressure is reached. If the injection rate suddenly increases with a drop in pressure when grouting at the maximum safe pressure, lifting should be suspected and appropriate precaution taken.

CUBIC FEET CEMENT CONTAINED IN FOLLOWING MIXES:

CUBIC FEET GROUT	6:1	4:1	3:1	2:1	1.5:1	1:1	.86	.75	.67
0.1					0.1	0.1	0.1	0.1	0.1
0.2			0.1	0.1	0.1	0.1	0.2	0.2	0.2
0.3		0.1	0.1	0.1	0.2	0.2	0.2	0.2	0.3
0.4	0.1	0.1	0.1	0.2	0.2	0.3	0.3	0.3	0.3
0.5	0.1	0.1	0.1	0.2	0.3	0.3	0.4	0.4	0.4
0.6	0.1	0.1	0.2	0.2	0.3	0.4	0.4	0.5	0.5
0.7	0.1	0.2	0.2	0.3	0.4	0.5	0.5	0.6	0.6
0.8	0.1	0.2	0.2	0.3	0.4	0.5	0.6	0.6	0.7
0.9	0.1	0.2	0.3	0.4	0.5	0.6	0.7	0.7	0.8
1.0	0.2	0.2	0.3	0.4	0.5	0.7	0.7	0.8	0.9
2.0	0.3	0.4	0.6	0.8	1.0	1.3	1.5	1.6	1.7
3.0	0.5	0.7	0.9	1.2	1.5	2.0	2.2	2.4	2.6
4.0	0.6	0.9	1.1	1.6	2.0	2.7	3.0	3.2	3.4
5.0	0.8	1.1	1.4	2.0	2.5	3.3	3.7	4.0	4.3
6.0	0.9	1.3	1.7	2.4	3.0	4.0	4.4	4.8	5.1
7.0	1.1	1.6	2.0	2.8	3.5	4.7	5.2	5.6	6.0
8.0	1.2	1.8	2.3	3.2	4.0	5.3	5.9	6.4	6.9
9.0	1.4	2.0	2.6	3.6	4.5	6.0	6.6	7.2	7.7
10.0	1.5	2.2	2.9	4.0	5.0	6.7	7.4	8.0	8.6
11.0	1.7	2.4	3.1	4.4	5.5	7.3	8.1	8.8	9.4
12.0	1.9	2.7	3.4	4.8	6.0	8.0	8.8	9.6	10.3
13.0	2.0	2.9	3.7	5.2	6.5	8.7	9.6	10.4	11.1
14.0	2.2	3.1	4.0	5.6	7.0	9.3	10.3	11.2	12.0
15.0	2.3	3.3	4.3	6.0	7.5	10.0	11.1	12.0	12.9
16.0	2.5	3.6	4.6	6.4	8.0	10.7	11.8	12.8	13.7
17.0	2.6	3.8	4.9	6.8	8.5	11.3	12.5	13.6	14.6
18.0	2.8	4.0	5.1	7.2	9.0	12.0	13.3	14.4	15.4
19.0	2.9	4.2	5.4	7.6	9.5	12.7	14.0	15.2	16.3
20.0	3.1	4.4	5.7	8.0	10.0	13.3	14.7	16.0	17.1
21.0	3.2	4.7	6.0	8.4	10.5	14.0	15.5	16.8	18.0
22.0	3.4	4.9	6.3	8.8	11.0	14.7	16.2	17.6	18.9
23.0	3.5	5.1	6.6	9.2	11.5	15.3	16.9	18.4	19.7
24.0	3.7	5.3	6.9	9.6	12.0	16.0	17.7	19.2	20.6
25.0	3.8	5.6	7.1	10.0	12.5	16.7	18.4	20.0	21.4
26.0	4.0	5.8	7.4	10.4	13.0	17.3	19.2	20.8	22.3
27.0	4.2	6.0	7.7	10.8	13.5	18.0	19.9	21.6	23.2

Figure 13-2. Chart for determining cement content of grout mixes

j. It is recommended that the pump system be flushed at intervals with water when thick mixes (i.e., 2.0 or thicker) are used in the grouting procedure. A few cubic feet of water should also be injected into the hole at the same time.

k. A maximum pumping rate should be established for injecting grout to restrain grout travel within reasonable limits and to have better control of the job. Three cubic feet per minute is considered a reasonable maximum pumping rate for most foundation grouting. The rate of grout injection into the hole must be controlled by the Government. The maximum rate is only used when there is no pressure buildup. As the pressure rises, the injection rate is reduced. The rate of injection may also be reduced to restrain grout travel under open-hole conditions. The specifications should clearly indicate that the rate of injection will be controlled by the Contracting Officer's Representative and will vary from the specified refusal criteria to the maximum rate based on pressures and from 0.5 cubic foot per minute to the maximum rate regardless of pressures.

l. When pressures cannot be built up using the thickest mixes allowed, or when it is desirable to prevent grout from spreading too far, delays may be used. They may last from a few minutes to several hours. The amount of grout injected per delay should be controlled to fulfill the intended purpose. If the delays are very long and thick grout is being used, the hole and pump system should be flushed before each delay. The contractor's efforts should also be allowed to be directed elsewhere during the delay. If the delays are short and the contractor is required to stand by, provisions should be made in the contract for payment for standby time. Delays of several hours are required in intermittent grouting for cavity filling. Intermediate, shorter delays during a single injection period may be required to build up the grout cone faster.

m. Upon the completion of grouting a hole, any grout left in the sump should be either wasted or thinned to the starting mix for the next hole. Grout that is not injected within 2 hours after mixing should be wasted, or sooner if the grout shows evidence of stiffening.

n. Split-spaced grout holes may be mandatory according to the contract specifications, or may be required due to grout takes. Split-spaced holes should normally be required on both sides of a hole that takes more grout than the established minimum for the job. Holes that are prematurely plugged should be replaced with new holes. Split-spacing criteria is discussed in para. 13-4c.

o. Drilling and grouting should not be permitted in the same section concurrently. After grouting of a given order of holes is completed and 24 hours has elapsed, the next order of holes may be drilled in the section as required.

p. Surveillance of the area should be made frequently during grouting to check for surface leaks and to collect monitoring data from other holes,

springs, piezometers, wells, and seeps. Records should be kept of any discolorations, changes in flow, or changes in water levels. Leaks are controlled, if necessary, by dikes or calking with materials such as oakum, wood wedges, or burlap. If the leaks are serious, an accelerator may be added to the ponded grout within a diked area and a delay may be used to allow the grout to set. If the leak cannot be stopped, grouting may be continued at reduced pressure with a thicker mix. During grouting or after grouting is completed in each reach, exploratory coreholes should be drilled and pressure tested to check the adequacy of the grouting. These borings may indicate that conditions in all or parts of the formation already grouted will require additional grouting. In such event, the equipment must be returned and additional holes should be drilled and grouted.

q. For winter grouting, all grout should be maintained at temperatures above 50°F until injected. The temperatures of mixing water should range from 50° to 100°F when added to the grout mixer. Storage of grouting materials should be at temperatures above freezing. In addition, when grouting surface rock, the surface temperature should be no colder than 40°F before and during injection and for a period of 5 days thereafter. Insulation, heated enclosures, and water heaters are frequently necessary.

r. In extremely hot weather, grout and grouting materials should be protected from direct sunlight. It is desirable to maintain the grout at temperatures below 90°F. The higher temperatures not only increase water demand and, consequently, shrinkage but also accelerate the setting time of the grout, which decreases the working time.

s. Geologic sections and profiles should be kept up to date with drilling, testing, and grouting data, and records should be made of monitoring data to evaluate the ongoing grouting program. This information should also be included in the foundation report for future reference.

t. Evaluation of grouting effectiveness must be constant and continuous during the program. It should be a joint effort between engineering and construction personnel. If problems develop, reaction should be expeditious. Flexibility must be maintained for making changes and improvements as the program progresses. Design changes of other project features are sometimes made based on knowledge of foundation conditions gained during grouting.

13-4. Completion of Grouting.

a. Grouting may be continued to absolute refusal at the maximum grouting pressure, although this is not usually done. There are two methods that are most frequently used to determine when grouting is complete. One specifies that grouting shall continue until the hole takes no grout at three-fourths of the maximum grouting pressure. The other requires that grouting continue until the hole takes grout at the rate of 1 cubic foot or less in 10 minutes measured over at least a 5-minute period. This is often modified according to

EM 1110-2-3506

20 Jan 84

the mix and/or pressure used. The second specification is more readily correlated with pressure test results than the first.

b. If there is doubt about the completeness of treatment in any zone or area, a check hole or holes should be drilled. Such holes can be drilled to recover core for examination, or they may be drilled for study by the borehole camera or television camera. However, a quicker and less expensive check can be made by drilling and pressure testing another grout hole. If tight when pressure tested with water, the rock is satisfactorily grouted; if the hole takes water, additional grouting is indicated.

c. The process of split-spacing should continue as long as there is significant reduction in take with each new series of split-spaced holes, or until takes are not considered to be significant for the particular project.

CHAPTER 14 METHODS OF ESTIMATING

14-1. General Considerations. The work involved in a drilling and grouting program can only be approximated in advance of construction. Quantities are estimated for bidding purposes, but substantial variations are common. The contract specifications and bid items should be prepared so that the estimated quantities for each of the bid items may vary substantially without affecting unit prices. However, a concerted effort must be made to estimate the quantity of drilling and of grouting materials (e.g., grout take) that will be required.

14-2. Test Grouting. For medium and large projects, probably the most reliable method for estimating grout take is to conduct a test grouting program as discussed in paragraph 3-5. The site chosen for testing should be geologically characteristic of what was found during subsurface exploration.

14-3. Grouting Records. A less reliable method for estimating quantities of grouting materials is to refer to grouting records from sites located in areas that have similar geology and rock types. This method will give a general feel for the quantities; however, it will require extensive experience and knowledge of grouting on the part of the estimator to extrapolate the data to another site. A major problem in utilizing this method is the possibility of differing approaches or philosophies of the people doing the grouting. Individual grout specialists working in similar environments may place considerably different quantities of grout, according to their various techniques, but a satisfactory grout job can be achieved in each case.

14-4. Evaluation of Exploration Borings. The evaluation of the cores from the exploration program, as well as the results of the water pressure tests, is fundamental in the initial stages of preparing a grouting estimate. Utilizing this method alone for estimating would be unreliable since it has been proven that rock formations which take water during pressure testing frequently do not take grout.

14-5. "Unit Take" Estimates. A method frequently used during preparation of detailed estimates for drilling and grouting programs is called the "unit take" method. In the procedure used for this method the area to be grouted is divided into horizontal reaches and vertical zones of varying permeability, based on site geology and pressure test results. Estimates are made of the number of primary and split-spaced holes required to complete each area and zone. Grout take in cubic feet per foot of grout hole is assigned, as well as the reduction in grout take for each split and zone. The amount of grout take in each series of split-spaced holes normally would be less than the preceding set of holes, and in multiple lines, take in each line less than a previously grouted line. Unless geologic conditions indicate otherwise, the unit take would normally decrease with depth. Each zone of each hole is assigned an estimated take in cubic feet of grout per linear foot of grout hole. A typical estimate using this method may look like the following:

Reach "A"
(Grout Take in Cubic Feet/Foot)

	<u>Depth</u>	<u>Primary</u>	<u>Secondary</u>	<u>Tertiary</u>	<u>Quaternary</u>
Line A: Zone 1	0-10	1.5	0.75	0.2	0.05
Zone 2	10-25	1.0	0.4	0.1	--
Zone 3	25-50	0.2	0.25	0.1	--
Zone 4	50-100	0.1	0.01	--	--

(Note: The above figures are for illustration only and should not be used for purposes of estimating, criteria for split spacing, or completion of grouting.)

For most major projects, all of the methods discussed above should be used and results compared to accomplish an adequate grout estimate.

14-6. Bid Items. Experience of the Corps of Engineers indicates that the items discussed in subsequent paragraphs should be considered for inclusion in any estimate or bid schedule for a drilling and grouting program. The bid items must fit the needs of the particular project. Guidance in providing for variations in estimated quantities by using subdivided items is given in ER 1180-1-1.

a. Mobilization and Demobilization. Drilling and grouting equipment must be assembled at the job site before a grouting program can be started and must be removed from the site when the work is completed regardless of the amount of work actually performed. A separate pay item or pay items for these operations, therefore, should be included in the specifications, and the contractor will be guaranteed payment whether work under the other items of the program is performed or not. Payment for the two features of work is commonly set up under one pay item with provisions for a partial payment to the contractor upon completion of the mobilization and for payment of the remainder after the grouting program is completed and the materials and equipment are removed from the site to the satisfaction of the contracting officer.

b. Environmental Protection. A separate pay item may be included in the specifications. Environment protection is defined in this manual as the retention of the environment in its natural state to the greatest possible extent during project construction.

c. Drilling Grout Holes.

(1) A minimum diameter hole is generally specified. If different diameter holes are required by the contract, separate pay items should be provided. Separate pay items may also be warranted for the various depths or angles, or where some of the drilling is to be done under special conditions,

20 Jan 84

such as from a gallery or tunnel. If it becomes necessary to drill the grout from a hole after set, through no fault of the contractor, a special payment provision for redrilling should be provided. This is usually specified as one-half of the cost of initially drilling the grout hole.

(2) The contract drawings and specifications should clearly indicate the direction, maximum angle, maximum depths, and allowable deviation therefrom.

(3) The amount of drilling should be estimated on the basis of the job as planned and shown on the drawings. The amount of drilling anticipated for each drilling item should be shown.

d. Drilling Exploratory Holes. To determine the effectiveness of the grout curtain or portions thereof during grouting operations it may be required to drill exploratory holes at key locations. Drilling of exploratory holes will be measured for payment on the basis of linear feet of holes actually drilled. If a portion of exploratory or grout hole drilling is to be done through overburden, a separate pay item should also be included for this portion (see c above).

e. Pressure Washing and Pressure Testing. Preliminary washing of the grout hole usually is included for payment as a part of the drilling operations, and a separate pay item is not necessary. Pressure washing and testing are essential parts of the grouting program and therefore should be paid for as a separate item. Quantities of pressure washing and pressure testing ordinarily are measured for payment purposes in terms of units of time required to do the work. Pressure washing and pressure testing are closely related and the operations performed are similar; therefore, payments for both operations are commonly combined in one pay item. Although the extent of pressure washing will depend on the conditions actually encountered, an approximation of the amount that will be required, as well as the amount of pressure testing expected to be done, should be made for inclusion in the estimate.

f. Grout Placement. The pay item for placing grout should cover the labor, the use of equipment, and the necessary supplies (other than grouting materials) required to mix and to inject the grout into the holes. The stage-grouting method, if it is employed, may also include cleaning grout from the holes at the completion of a grouting stage. Placing grout is frequently paid for by volume of the grouting materials (except water) to be injected, i.e., cubic feet of solids. An estimate of the quantity of grout must be made even though the actual amount is not known in advance. Payment for grout injection by the hour may be better in many cases, and would include labor and use of equipment to inject the grout into the holes. In cases where it is anticipated that extensive use may be made of very thin mixes to grout fine fractures, an alternative method would be to pay for placement of total volumes including water. This would assure that a contractor is fairly compensated for long time periods placing small amounts of cement.

20 Jan 84

g. Connections to Grout Holes. The labor required to hook up to a grout hole is independent of the effort involved in placing grout, and a separate payment may be desirable for each hookup or connection. The payment may consist of a fixed or bid price per grout hookup or connection.

h. Grout Materials. Separate pay items should be established for each of the grout materials (except water) anticipated or planned to be used. The estimated quantity of each, expressed by volume or weight, should be derived from past experience, knowledge of the geologic conditions, and from test grouting, if performed.

i. Pipe and Fittings. All pipe to be embedded in concrete or in rock through which holes will be drilled and grouted, and the fittings used in connection therewith, should be covered by one pay item regardless of the different sizes used. The quantity should be estimated on the basis of the number of pounds of pipe and fittings that will be required.

j. Drilling Drain Holes. The drilling of drain holes should be covered by separate items for each hole size. Should both drilling in the open and from galleries be required on the same job, separate items for these conditions may be desirable. The spacing and the depth of drain holes can ordinarily be predetermined with a greater degree of accuracy than can grout holes. The quantity for each item should be expressed in linear feet or meters.

CHAPTER 15
RECORDS AND REPORTS

15-1. General. Those assigned to the inspection and supervision of foundation grouting operations will need to keep an accurate record of the work as it is done, since very little evidence of accomplishment is visible after work of this nature is completed. One function of those having the overall responsibility for the prosecution of the work is to instruct the personnel who are in intimate contact with the grouting operations as to notes and data required, and when and to whom the reports are to be submitted. These notes are part of the job history and will also be required to determine the payment quantity. The sample notes shown in figures 15-1 through 15-5 are included for the purpose of illustrating the scope and character of the records.

Hole No. 23-2, Primary Sta. 23+20						Date: 6/21/62		Water table about 20'	
Zone 4						Shift: 1600-2400 hrs		Press. test: 0.5 c.m @	
75'-100'; Inc. 25°						Axis El. 564.4		Inspector: J. Jones	
						6/19/62			
Time	Mix	Cement Sacks	Grout Cu. ft	Tank Reading	Gage Pressure	Grout cu. ft/min	Cement cu. ft/hr	Remarks	
1738	4:1	3	13.5	120 cu. ft.	0			Started grouting at 1738 hrs	
1743				9.5	10	0.5		Vertical depth to Zone 4 is 68'	
1751		2	9.0		18	0.75	10.0	Add 42psi for 2:1 @ 49 psi	
1803	3:1	3	10.5		15	0.8	13.8	for 1:1. Add 38psi for	
1816		3	10.6		15-0	0.9	16.0	3:1 grout. Delay 1828 -	
1830		3	10.5		0-15	0.9	15.0	1830 hrs. Water line broken	
1842		3	10.5		20	0.95	16.4	1810 hrs. Repaired at	
1853	2:1	3	7.5		20	0.9	22.6	1828 hrs. Pressure at 0	
1901		3	7.5		20	0.9	22.5	during delay.	
1909		3	7.5		20	0.9	22.5		
1917		4	10.0		20	0.9	21.8		
1928		4	10.0		25	0.9	21.8	Checked area for leaks at 1845	
1939		4	10.0		26	0.8	19.2	" " " " " 1845	
1951.5		4	10.0		26	0.75	17.8		
2005		4	10.0		26	0.5	11.4		
2026	3:1	3	10.5		27	0.75	12.9+		
2040		3	10.5		30	0.6	10.6		
2057		3	10.5		30	0.5	9.1		
2117		3	10.5		30	0.35	6.0		
2147		2	7.0	4.5+7.0	30				
2152				10.8		0.14			
2157				10.6		0.04		Completed grouting at 2157 hrs.	
		60.0		1.5				(line pump)	
		3.5		12.1				Carried forward	
		56.5							

Figure 15-1. Sample grouting log

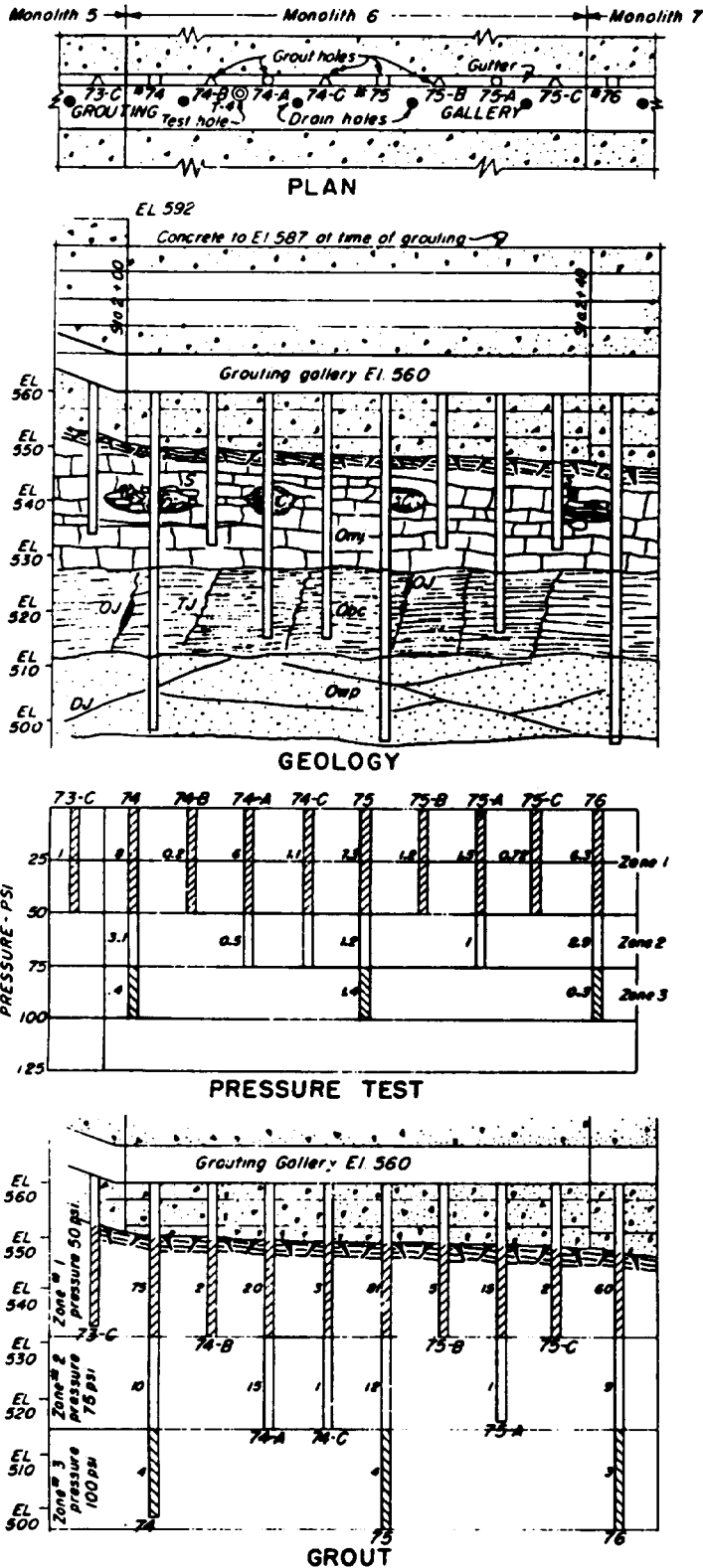

EXPLANATORY NOTES

This is a typical monolith of an "as built" plan which illustrates a method of presenting foundation grouting performance. Comments are as follows relative to the various plan and sectional views shown:

a PLAN The plan view indicates the location and purpose of all holes in a single monolith drilled during grouting operations.

Legend

- = primary hole
- = secondary hole
- △ = tertiary hole
- ⊙ = exploratory hole
- = drain hole

b GEOLOGY The section indicates the geological and physical nature of the rock and contains pertinent grouting and drilling data such as points of water loss, cavities and the location of shattered rock.

Legend

- Geological: Omj = Ordovician, Moose jaw limestone
- Obc = Ordovician, Bear claw silt - shale
- Omp = Ordovician, Wolfe paw sandstone
- Physical: C = Solution cavity
- S = Shattered zone
- TJ = Joint fracture - tight
- OJ = Joint fracture - open
- DJ = Diagonal joint

c PRESSURE TEST This is a graphical presentation of the testing and washing operation made prior to grouting. The pressure (gauge pressure as measured at the collar plus the static pressure of the fluid column,) used for each zone and the water loss in c.f.m. are shown.

d GROUT This is a graphical presentation of the grouting operation indicating the depth of zones, the pressure (actual as above) and the bags of cement injected in each zone of each hole.

Figure 15-4. Record drawings of grouting operations

Hole No. 57

DRILLING LOG		DIVISION S. A. D.		INSTALLATION Mobile District		SHEET 2 OF 10	
1. PROJECT Burwell Dam Site				10. SIZE AND TYPE OF BIT N X M			
2. LOCATION (Coordinates or Station): 10+00 - 57+85				11. DATUM FOR ELEVATION MEASUREMENT OR HSL: MSL			
3. DRILLING AGENCY U.S. Army Corps of Engineers				12. MANUFACTURER'S DESIGNATION OF DRILL: Joy HD 22			
4. HOLE NO. (As shown on drawing and No. number): 57				13. TOTAL NO. OF OVERBURDEN SAMPLES TAKEN:		13. TOTAL NO. OF OVERBURDEN SAMPLES TAKEN:	
5. NAME OF DRILLER Sam Jones				14. TOTAL NUMBER CORE BORES		14. ELEVATION ABOVE WATER	
6. DIRECTION OF HOLE <input checked="" type="checkbox"/> VERTICAL <input type="checkbox"/> INCLINED DEG. FROM VERT.				15. DATE HOLE STARTED		15. DATE HOLE COMPLETED	
7. THICKNESS OF OVERBURDEN 20.5				17. ELEVATION TOP OF HOLE 409.4		18. TOTAL CORE RECOVERY FOR BORING %	
8. DEPTH DRILLED INTO ROCK 76.6				19. SIGNATURE OF INSPECTOR John Henry			
9. TOTAL DEPTH OF HOLE 95.0							

ELEVATION	DEPTH	LEGEND	CLASSIFICATION OF MATERIALS (Description)	% CORE RECOVERY	DRILLING SAMPLE NO.	REMARKS (Drilling time, water loss, depth of weathering, etc., if significant)
388.9	20		O.B. - see sheet 1.			Top of Rock
	21		Sandstone, fine grained, thin-bedded friable, weathered brown. fracture, iron stained dips approx. 40° Shaley. Soft brown shale laminae paper thin to 1 inch thick.			Started drilling 2:10 p.m. Water level 16.4 4/16 S & H bit no. 36285 Fair cond. Drilled easily. Core in short pieces 0.1 to 0.3 foot lengths 0.2 C.L. Core loss due to grinding
	22					
	23			0.1 C.L. here.		
385.7			0.1 C.L. here.			Pull at 2:31 p.m.
	24		Shale, moderately soft, scattered sandy zones. Probably will break into poker-chip sizes when dry. Dip 3° Slightly weathered, tan.			Started drilling 2:38 p.m. W.L. 18.2 New bit - J. K. Smit no. 43612 Drill action smooth Break in core due to drilling. Pulled when encountered hard rock. 0.0 C.L. Pull at 2:56 p.m.
	25					
383.3	26		Marker No. 3 Limestone, hard dense gray. Scattered rugs up to 1 inch diam. lined with calcite. Bedding indicated by widely spaced thin dark bands. Dip 3° Scattered small chert nodules 0.5 to 1.5 inches in diameter.			Started drilling 3:04 p.m. W.L. 19.7 Drilling smooth, core in one piece. Pulled because of bit block. 0.0 C.L. Pull at 3:36 p.m.
	27					
	28					
379.8	29		Grinding on core.			
	30					

ONE FROM 1 APR 62 PREVIOUS EDITIONS MAY BE USED (EM 1110-102) PROJECT **BURWELL DAM** HOLE NO. **57**

Figure 15-5. Core log sheet

15-2. Records.

a. Figure 15-4 is presented as a suggested method of recording the grouting accomplishments on as-built drawings. The drilling depths and the zones are indicated in the geological section. The pressure test data are indicated in the section designated as "Pressure Test," and all remaining data on the grouting operations have been included in the section marked "Grout." Other methods allowing more detail and at a larger scale may be preferable.

b. Records and reports required for drilling and grouting are:

(1) Information for operational purpose. This constitutes factual data on which to base decisions regarding the effectiveness of the grouting accomplished. The information will be reviewed by designers and geologists assigned to the project in order to determine whether or not departures should be made from the basic grouting plan.

(2) Records for payment. These data are used as a basis for determining the reimbursement due the contractor. The contractor will usually present a daily abstract of work accomplished indicating the length of drilling and the number of bags of cement injected in grouting and include a list of holes for which minimum payment is expected. The inspector's reports will ordinarily be used as a check. The contractor, however, may not elect to keep any record of the work done, and payment in that case will be based entirely on the inspector's reports.

(3) Data for foundation record. These data are required for permanent job records and for use in preparation of the "as built" drawings and for inclusion in the final foundation report.

APPENDIX A
REFERENCES AND BIBLIOGRAPHY

A-1. References.

Government Publications

Department of the Army, Corps of Engineers*

Engineer Manuals

EM 1110-1-1804	Geotechnical Investigations
EM 1110-1-2907	Rock Reinforcement
EM 1110-2-1907	Soil Sampling
EM 1110-2-1908	Instrumentation of Earth and Rock Fill Dams (Ground Water and Pore Pressure Observations)
EM 1110-2-2000	Standard Practice for Concrete
EM 1110-2-2002	Maintenance and Repair of Concrete and Concrete Structures
EM 1110-2-2300	Earth and Rock-Fill Dams: General Design and Construction Considerations
EM 1110-2-2901	Tunnels and Shafts in Rock
EM 1110-2-3501	Foundation Grouting: Planning
EM 1110-2-3503	Foundation Grouting - Field Technique and Inspection
EM 1110-2-3504	Chemical Grouting

Engineer Regulations

ER 1110-2-100	Periodic Inspection and Continuing Evaluation of Completed Civil Works Structures
ER 1180-1-1	Engineer Contract Instructions

* Available from: Corps of Engineers Publication Depot, 890 South Pickett St., Alexandria, VA 22304.

EM 1110-2-3506
20 Jan 84

Department of the Army, Corps of Engineers,
Waterways Experiment Station*

Handbook for Concrete and Cement

CRD-C 5	Standard Method of Test for Slump of Portland Cement Concrete
CRD-C 7	Standard Test Method for Unit Weight, Yield, and Air Content (Gravimetric) of Concrete
CRD-C 8	Standard Test Method for Air Content of Freshly Mixed Concrete by the Volumetric Method
CRD-C 41	Standard Test Method for Air Content of Freshly Mixed Concrete by the Pressure Method
CRD-C 42	Standard Practice for Microscopical Determination of Air-Void Content and Parameters of the Air-Void System in Hardened Concrete
CRD-C 83	Method of Test for Air Content of Hardened Concrete (High-Pressure Method)
CRD-C 611	Test Method for Flow of Grout Mixtures (Flow-Cone Method)
CRD-C 612	Test Method for Water Retentivity of Grout Mixtures
CRD-C 613	Method of Test for Expansion of Grout Mixtures
CRD-C 614	Method of Test for Time of Setting of Grout Mixtures
CRD-C 619	Corps of Engineers Specification for Grout Fluidifier
CRD-C 621	Corps of Engineers Specification for Nonshrink Grout

* Available from: U. S. Army Engineer Waterways Experiment Station,
P. O. Box 631, Vicksburg, MS 39180.

20 Jan 84

Miscellaneous Paper
C-78-19

Grouting of Scoured Foundation, Old
River Low Sill Structure, Louisiana

Miscellaneous Paper
SL-79-23

Grouting Instrumentation, Old River
Low Sill Control Structure

Technical Memorandum
No. 6-380

Investigation of Suitability of Prepack
Concrete for Mass and Reinforced
Concrete Structures

Technical Memorandum
No. 6-419, Reports 1
through 5

Tests of Sanded Grouts

Report 1 Influence of Chemicals and
Mineral Fines on Pumpability

Report 2 Influence of Sand Grading and
Addition of Mineral Fines on
Pumpability

Report 3 Influence of Grading and
Specific Gravity of Manufactured
Sands on Pumpability

Report 4 Influence of Manufactured
Sands and Admixtures on Pumpability,
and Evaluation of a Concrete Mixer

Report 5 Effects of Fly Ash in Grouting
Coarse Sands and Fine Gravels

Maintenance and Repair Practices,
Facilities Engineers

Technical Report
C-78-4, Report 1

Maintenance and Preservation of Concrete
Structures, an Annotated Bibliography

Translation No. 65-4

Use of Resins for Repairing Grouting
Cracks and Waterproofing the Face of
a Dam

A-2. Bibliography.

Aastrup, A. and S. Sallstrum, "Bergeforsen - A Swedish Power Plant Built on
Non-Resistant Rock," 7th Congress on Large Dams, Rome, Question 25, Re-
port 69 (1961).

EM 1110-2-3506

20 Jan 84

Acker, R. C. and J. C. Jones, "Foundation and Abutment Treatment for Rockfill Dams," Journal, Soil Mechanics and Foundation Division, ASCE, Vol 98, No. SM 10, Paper 9309, pp 995-1015, Oct (1972).

American Society of Civil Engineers, "Purpose or Need for Grouting in the Treatment of Foundations," Proceedings, Engineering Foundation Conference, Pacific Grove, CA (1974).

American Society of Civil Engineers, "Grouting in Geotechnical Engineering," Proceedings (1982).

American Society for Testing and Materials, Philadelphia, PA, Standard Test Method for Restrained Expansion of Shrinkage Compensating Concrete, Designation: C-878-78 (1978).

Bussey, W. H., "Control of Seepage Through Foundation and Abutments of Dams," Foundation Evaluation and Treatment, Casagrande Geotechnique, Vol 11, No. 3, 1961, pp 161-182 (1961).

Cabanus, C. and R. Margre, "The Serre-Poncon Dam," Travaux, Paris, p. 43 (1958).

Cambefort, H., "The Principle and Applications of Grouting," Q. Jl. Engrg. Geol., Vol 10, pp 57-95 (1977).

Clough, G. W., Development of Design Procedures for Stabilized Soil Support Systems, U. S. Department of Commerce, PB 272 771.

Department of the Army, Corps of Engineers, Geophysical Exploration, EM 1110-1-1802.

Gelhart, High Earthfill Dam Foundation, Grouting Design and Construction Procedures, ASCE Natl. Mtg., Res Eng., New Orleans, LA, (1969).

Hernton, J. and T. Lenahan, Grouting in Soils, Vols 1 and 2, Federal Highway Administration, PB 259 043 and PB 259 044.

Jaworski, G. W., J. M. Duncan, and H. B. Seed, An Experimental Study of Hydraulic Fracturing, Report No. UCB/GT/79-02, University of California, Berkeley, CA, Oct (1949).

Jevdjevic, V. M., and B. M. Rajcevic, "Some Special Features of Designs and Constructions for Earth Dams and Rockfill Dams in Yugoslavia," Journal, 4th Congress on Large Dams, New Delhi, India, Vol 1, p. 153 (1951).

Karol, R. H., P.E., Soils and Soils Engineering, Prentice-Hall, Inc.

- Neff, T. L., J. W. Sager, and J. B. Griffiths, "Consolidation Grouting at an Existing Navigation Lock," Grouting Geotechnical Engineering, ASCE (1982).
- Sherard, J. L., et al., Earth and Rockfill Dams, John Wiley & Sons, Inc., New York (1963).
- Sinclair, B., Estimation of Grout Absorption in Fractured Rock Foundations, Published on demand by Univ. Microfilms, Intl., Ann Arbor, Michigan, and London, England (1972).
- Soil Mechanics Lecture Series: Design and Construction of Earth Structures (sponsored by Soil Mechanics and Foundation Division, Illinois Section, ASCE and Civ Eng Dept, Illinois Inst. of Tech., Chicago, IL, pp 93-115.
- Tallard, G. R. and C. Caron, Chemical Grouts for Soils, Vols 1 and 2, Federal Highway Administration, Reports FHWA-RD-77-50 and FHWA-RD-7751, June (1977).
- Thompson, T. F., "Foundation Treatment for Earth Dam," Proceedings, ASCE (1954).
- Underwood, L. B., "Engineering Classification of Shale," ASCE paper (1967).
- U. S. Army Engineer Waterways Experiment Station, CE, Bibliography on Grouting, Miscellaneous Paper C-78-8, June (1978).
- Zeigler, T. W., Determination of Rock Mass Permeability, U. S. Army Engineer Waterways Experiment Station, Technical Report S-76-2.

APPENDIX B

EXAMPLE: FIELD PROCEDURE FOR CLARENCE CANNON DAM

Example: Condition 1 Field Procedure for Clarence Cannon Dam

PRESSURE TEST RESULTS

WATER TAKE (CF14)	WATER/RATIO W/C
UP TO 4	6:1
4 - 6	5:1
6 - 7	4:1
7+	3:1

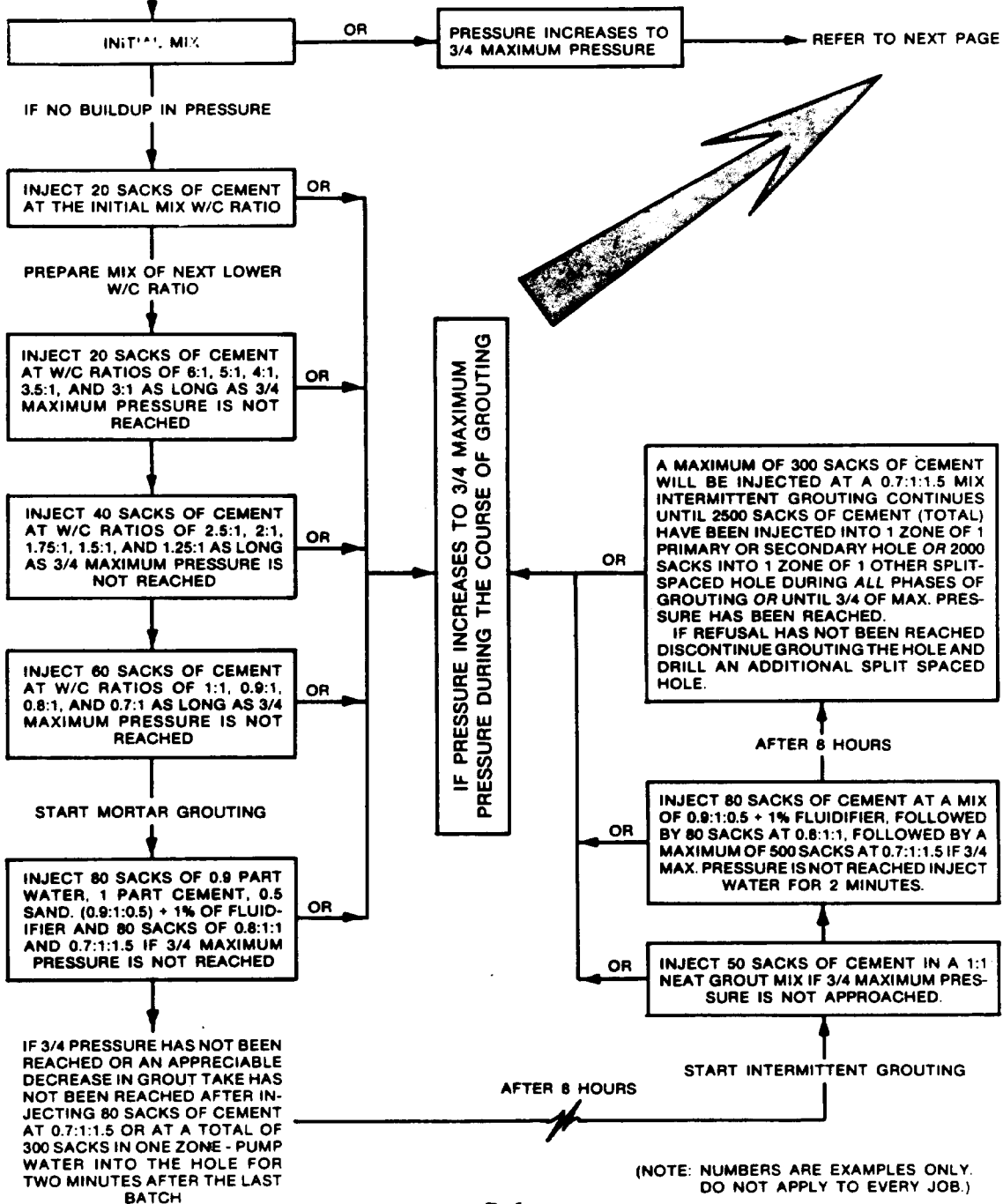

(NOTE: NUMBERS ARE EXAMPLES ONLY. DO NOT APPLY TO EVERY JOB.)

Example: Condition 2 Field Procedure for Clarence Cannon Dam

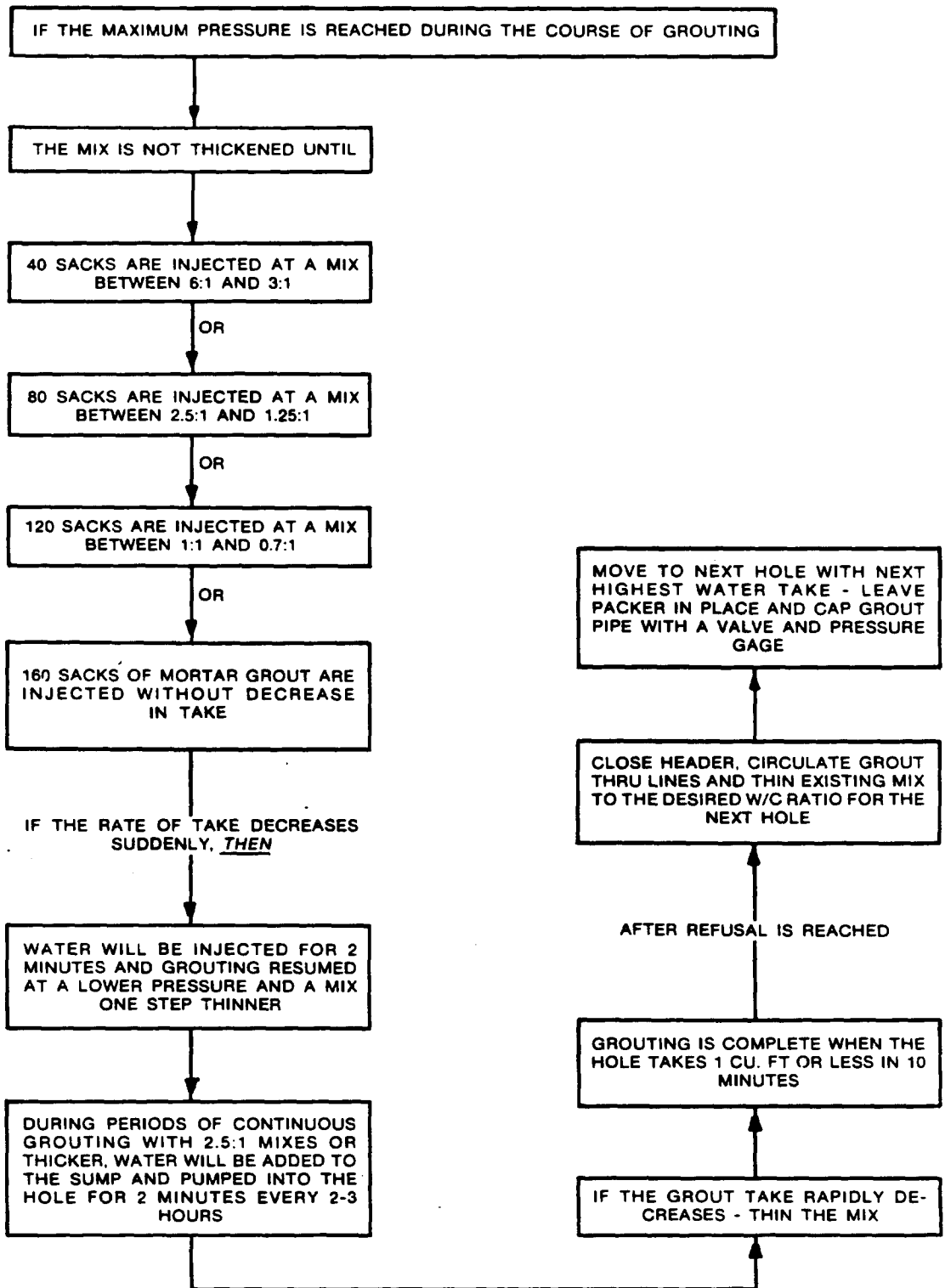

Example: Condition 3 Field Procedure for Clarence Cannon Dam

Once the rate of grout take has begun to steadily decrease, the mixture shall not be thickened further.

If there is a rapid decrease in the rate of grout take, the mixture should be thinned.

APPENDIX C

PRESSURE COMPUTATION EXAMPLES

(1) Example 1 (for a dry hole)

Problem: Compute maximum allowable gage pressure.

Given: Maximum allowable pressure is 1-1/2 pounds per square inch per foot of depth. Grout mix is neat cement grout, w/c ratio is 1.0, and packer is set at depth of 100 feet. (Note: 1-1/2 psi maximum allowable pressure is used only as an example. Actual pressures are site dependent.)

Solution: 1-1/2 cubic feet of w/c 1.0 grout weighs $62.4 + 94 = 156.4$ pounds. (Note: One 94-pound sack of cement = 1/2 cubic foot of solids.) 1 cubic foot of w/c 1.0 grout weighs $156.4/(2/3) = 104$ pounds.

Pressure per foot exerted by w/c 1.0 grout = $104/144 = 0.72$ pounds per square inch.

Maximum allowable pressure = $1.5 \times 100 = 150$ pounds per square inch.

Grout column pressure = $100 \times 0.72 = 72$ pounds per square inch.

Maximum allowable gage pressure = maximum allowable pressure minus grout column pressure = $150 - 72 = 78$ psi.

General Information:

Specific gravity of cement = 3.15 (1 bag = 94 pounds) (1 bag = 1 cubic foot)

Specific gravity of water = 1.0 (1 cubic foot water = 62.4 pounds)

Specific gravity of bentonite = 2.50

Specific gravity of fly ash = 2.50

Specific gravity of sand = $2.65 \pm$ (1 cubic foot sand \approx 100 pounds)

Volume of solids in 1 cubic foot cement \cong 0.5 cubic foot (actual is 0.479 if specific gravity is 3.15)

Volume of solids in 1 cubic foot sand \cong 0.6 cubic foot

Column of water or slurry pressure per foot = $\text{wt}/\text{ft}^3 \times 1 \text{ ft} = \text{wt}/\text{ft}^3 = \text{wt}/144 =$ pounds per square inch

for water = $62.4/144$ psi = 0.43 pounds per square inch

EM 1110-2-3506
20 Jan 84

for 1:1 grout (above water table) = $(62.4 + 94)/(1.5 \times 144)$
= 0.724 pounds per square inch

for 1:1 grout (submerged) = $(62.4 + 94)/(1.5 \times 144) - (62.4/144)$
= 0.294 pounds per square inch

(2) Example 2 (for a wethole)

Problem: Compute maximum allowable gage pressure

Given: Maximum allowable pressure is 1 pound per square inch per foot of depth. Grout mix is neat cement grout, w/c ratio is 1.0, and packer is set at depth of 100 feet.

Solution: Artesian pressure to be overcome

$$= (120 \text{ ft} \times 62.4 \text{ lb/ft}) / (144 \text{ in.}^2/\text{ft}^2) = 52 \text{ pounds per square inch}$$

Pressure exerted by grout column:

$$2\text{-}1/2 \text{ cubic feet of 2.0 grout weighs } 2 \times 62.4 + 94 \text{ pounds} = 218.8 \text{ pounds}$$

$$1 \text{ cubic foot of 2.0 grout weighs } 218.8/2.5 = 87.6 \text{ pounds}$$

$$\text{Submerged weight of 1 cubic foot of 2.0 grout weighs } 87.6 - 62.4 \\ = 25.2 \text{ pounds}$$

$$\text{Pressure/foot of submerged 2.0 grout} = 25.1/144 = 0.174 \text{ pound per square inch}$$

$$\text{Pressure of 100-foot grout column} = 17.4 \text{ pounds per square inch}$$

$$\text{Maximum allowable pressure} = 1.0 \times 100 = 100 \text{ pounds per square inch}$$

$$\text{Maximum allowable gage pressure} = \text{maximum allowable pressure} + \text{artesian pressure} - \text{grout column pressure}$$

$$\text{Maximum allowable gage pressure} = 100 + 52 - 17.4 = 134.6 \text{ pounds per square inch}$$

Figure for Example 2

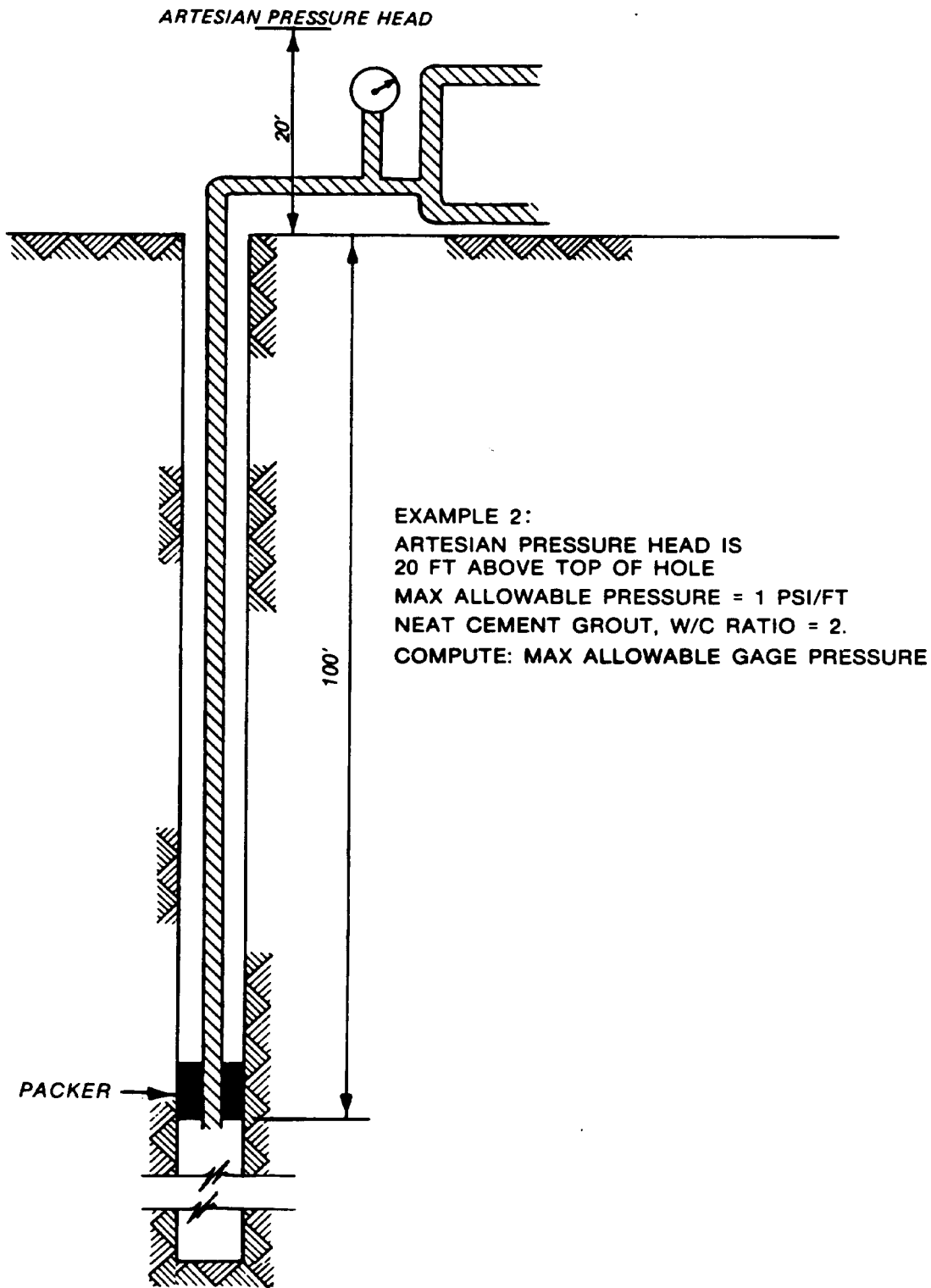

(3) Example 3 (water table situation--see figure for Example 3)

Problem: Compute maximum allowable gage pressure

Given: Maximum allowable pressure is 1-1/2 pounds per square inch per foot of depth. Grout mix is 1 part water, 1 part cement, and 3 parts sand; weight of sand is 100 pounds per cubic foot.

Solution: Weight of mix (1:1:3) = $62.4 + 94 + 3 \times 100 = 456.4$ pounds

Volume of mix = $1 + 0.5 + 3 \times 0.6 = 3.3$ cubic feet

Weight of grout/cubic feet = $456.4/3.3 = 138.3$ pounds

Pressure exerted by grout column:

Above water table: $138.3/144 \times 50$ feet = 48.0 pounds per square inch

Below water table: $[(138.3 - 62.4)/144] \times 50$ feet = 26.4 pounds per square inch

$48.0 + 26.4 = 74.4$ pounds per square inch

Maximum allowable gage pressure = maximum allowable pressure - grout column pressure

Maximum allowable gage pressure = $(1.5 \times 100) - 74.4 = 75.6$ pounds per square inch

Figure for Example 3

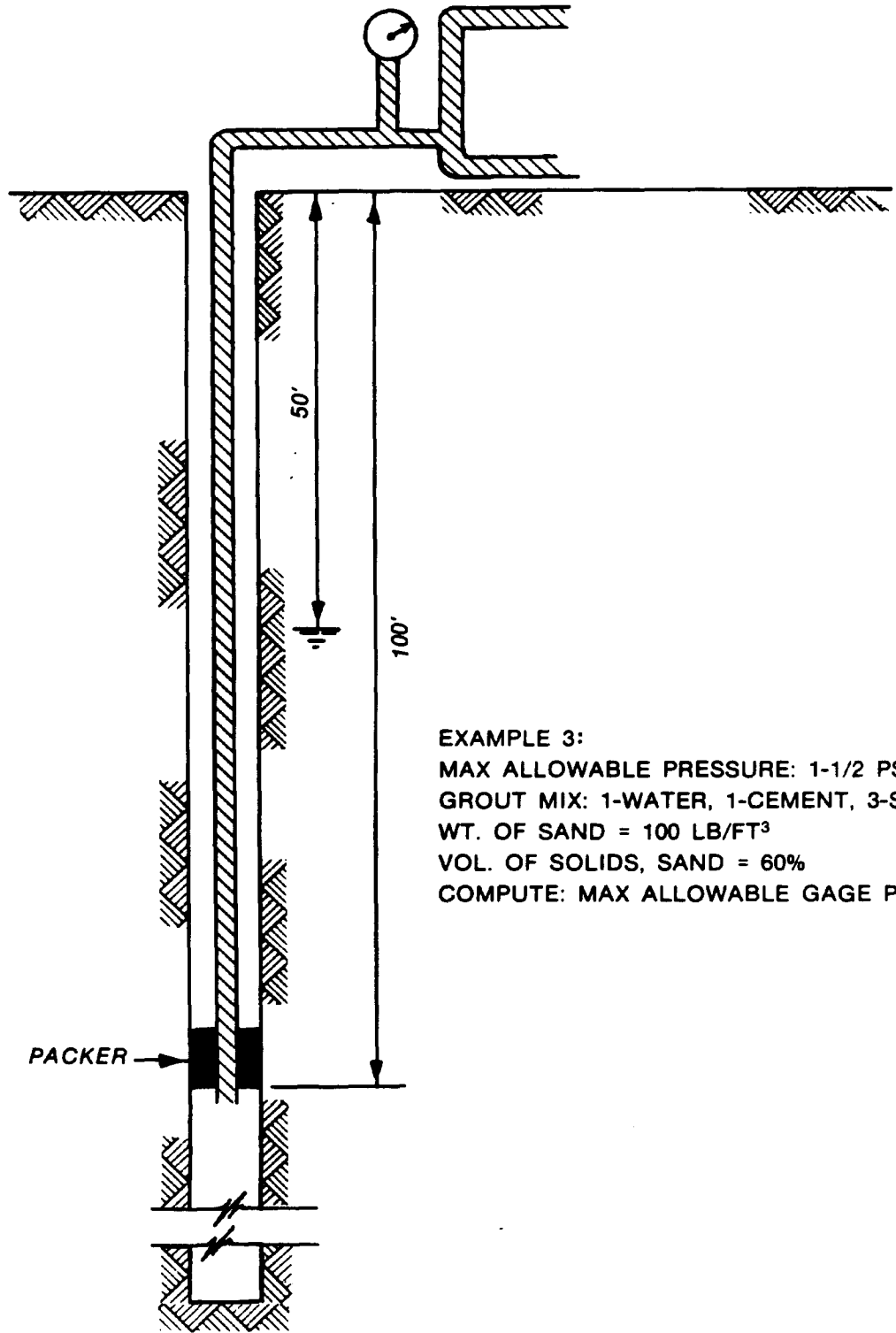

EXAMPLE 3:
MAX ALLOWABLE PRESSURE: 1-1/2 PSI/FT
GROUT MIX: 1-WATER, 1-CEMENT, 3-SAND
WT. OF SAND = 100 LB/FT³
VOL. OF SOLIDS, SAND = 60%
COMPUTE: MAX ALLOWABLE GAGE PRESSURE

(4) Example 4.

Rock is thinly bedded limestone with numerous bedding plane joints and shale partings.

Unit weight of rock $\gamma_{\text{rock}} = 162$ pounds per cubic foot

(a) What is recommended maximum grouting pressure?

Solution: $162/144 = 1.125$ pounds per square inch per foot of depth

(b) If water table is at 50 feet and the packer is set at 50 feet, what is recommended gage pressure range?

Anticipated grout mix is cement grout, and water cement ratios may vary from 6.0 to 1.0.

Solution: For 1.0 grout, gage pressure = $1.125 - (62.4 + 94)/(1.5 \times 144)$
= 0.4 pound per square inch per foot

For 6.0 grout, gage pressure = $1.125 - (6 \times 62.4 + 94)/(6.5 \times 144)$
= 0.5 pound per square inch per foot

At 50-foot depth, the range would be from 0.4×50 to 0.5×50 , or 20 to 25 pounds per square inch

20 Jan 84

APPENDIX D
PHYSICAL CHARACTERISTICS OF SANDED GROUTS

The physical data noted in Tables D-1 through D-4 and Figures D-1 and D-2 covering the investigation of sanded grout mixtures are provided from WES Technical Memorandum 6-419 to show the sand-carrying capacity of various pumpable mixtures as well as to furnish information regarding setting times and strength development with age for such mixtures. The addition to these mixtures of such additives as retarders, accelerators, water reducers, expansive agents, and air-entraining agents will modify the fluid properties as well as the hardened physical properties to meet various project requirements for new construction, remedial work, and grouting associated with research and development experiments.

Table D-1
Grout Pumpability Test Data

Parts by Weight of	Proportion by Weight			Age Grout min	Consistency Torque Degree		Line Pressure psi		Pump Speed Strokes per min		Discharge cu ft per hr		Grout Temp F	Time of Set hr		Compressive Strength psi†	
	Sand	Water	Cement		Before*	After*	Before*	After*	Before*	After*	Before*	After*		Initial	Final	7 days	28 days
<u>Cement</u>																	
	2	0.65	1	26	129	181	168	183	65	65	57	63	66	7	24	1570	3535
<u>Intrusion Aid</u>																	
0.005	2.25	0.71	1	30	134	182	141	200	63	62	59	63	70‡	7‡	24	1400	2810
0.020	2.5	0.74	1	29	133	194	155	170	68	68	58	63	70‡	7‡	23	1130	2190
<u>Methocel</u>																	
0.002	2.25	0.72	1	43	130	157	165	170	69	70	62	57	70‡	7‡	23	1270	2625
<u>Diatomite</u>																	
0.015	2.5	0.79	1	29	130	164	147	152	68	63	66	66	70‡	3‡	18	1240	2650
0.03	3	0.95	1	29	136	148	153	168	65	60	71	65	70‡	4‡	21	860	1840
0.06	3.25	1.01	1	31	134	176	147	148	67	67	68	69	70‡	3‡	19	745	1900
<u>Bentonite</u>																	
0.025	4	1.35	1	23	136	191	152	172	71	70	74	82	77	8‡	22‡	375**	670**
0.05	6	2.03	1	26	136	210	148	163	71	71	78	77	78	7‡	27‡	175††	308††
0.10	11	3.55	1	24	133	212	190	215	71	75	79	77	72	3‡	89‡	43**	63**
0.20	14	5.88	1	24	141	204	140	155	71	63	79	77	70‡	72‡	---	15	25
0.30	24	9.76	1	29	138	206	145	163	77	64	88	83	70‡	122‡	---	10	10
0.40	32	12.17	1	40	131	178	140	140	74	70	84	81	70‡	70‡	500‡	---	---

* Before or after 15-min interruption in pumping.
† All compressive strength cube tests are the average of three specimens unless indicated.
‡ Estimated.
§ Set after hour shown.
‡ Set prior to hour shown.
** Average of six specimens.
†† Average of nine specimens.

Table D-2
Grout Pumpability Test Data

Sand, % Passing 100	Proportion by Weight			Consistency				Line Pressure psi		Pump Speed Strokes per min		Discharge cu ft per hr		Grout Temp F	Time of Set hr		Per Cent Bleeding	Compressive Strength	
				Torque Degree		Flow Cone sec												7 days	28 days
				Before*	After*	Before*	After*												
0	2.00	0.63	1.0	131	154	12	12	173	193	67	60	64	60	75	4	7	1.2	1730	3505
5	2.50	0.72	1.0	137	171	12	12.5	200	200	57	61	63	62	72	4	8	1.6	1365	2805
10	2.50	0.76	1.0	138	170	12	13	150	150	57	57	63	58	71	5	8	1.7	1540	3030
15	2.75	0.82	1.0	129	168	12	12.5	160	165	65	53	68	60	73	4	8	1.7	1420	2700
20	2.75	0.82	1.0	129	171	12	12.5	160	165	61	53	64	59	75	4	18‡	2.7	1285	2485
25	3.00	0.87	1.0	133	150	12.5	13	160	160	47	42	53	50	74	4	7	3.5	1055	2120
Parts by Wt Diatomites																			
0.11	3.90	1.19	1.0	135	187	12	12.5	140	140	63	57	73	69	73	6	20‡	1.2	585	1035
0.25	5.00	1.54	1.0	141	161	11	12	133	135	73	69	81	77	74	3†	21	1.1	235	495
0.43	5.70	1.87	1.0	134	175	11	12	140	145	72	69	86	81	74	5†	24	0.7	150	485
0.67	7.10	2.37	1.0	134	203	11	12.5	135	150	75	71	87	78	75	3†	24	0.4	120	410
1.00	9.00	3.18	1.0	125	170	11	12	120	140	72	72	77	84	72	6†	19‡	0.4	55	235
Parts by Wt Fly Ash																			
0.11	3.10	0.88	1.0	134	174	12	12.5	150	160	60	53	67	60	73	6	21‡	1.5	1195	2210
0.25	3.80	1.07	1.0	131	180	12	13	160	165	55	57	65	61	74	2†	17‡	1.7	960	1720
0.43	4.30	1.16	1.0	131	172	12	12.5	165	170	55	59	68	63	72	6†	20‡	1.6	800	1270
0.67	5.40	1.35	1.0	131	179	12	12.5	155	160	60	55	67	62	74	3†	17‡	1.4	570	855
1.00	6.50	1.62	1.0	131	176	12	13	160	165	59	54	63	61	73	7†	26	1.3	435	715
Parts by Wt Fumicites																			
0.11	3.10	0.94	1.0	136	176	12	12	142	146	61	53	64	61	75	3†	17‡	1.8	1095	1965
0.25	3.80	1.11	1.0	136	171	12	13	142	140	64	55	62	61	71	6	22‡	2.3	715	1260
0.43	4.30	1.27	1.0	145	173	12.5	13	152	148	56	52	61	57	73	3†	65‡	2.3	600	1080
0.67	5.40	1.67	1.0	125	159	12	13	138	133	60	58	64	66	72	6	18	1.5	275	575
1.00	6.50	2.04	1.0	132	177	12	13	135	115	56	53	60	57	71	3†	26	1.9	170	380
Parts by Wt Loess																			
0.11	2.80	0.88	1.0	129	172	11	12	135	145	72	68	75	75	76	5†	18‡	1.3	1300	2355
0.25	3.40	1.04	1.0	140	203	12	13	155	155	69	59	74	64	72	5	20‡	1.4	845	1610
0.43	4.30	1.34	1.0	128	167	11.5	12	137	150	65	69	68	78	74	3†	17‡	1.7	400	765
0.67	5.00	1.52	1.0	135	180	11.5	12	147	152	75	66	73	74	75	3†	18‡	1.6	385	665
1.00	6.00	1.88	1.0	133	203	12	12.5	148	147	72	69	83	71	75	2†	50‡	1.2	255	410

* Before or after 15-min interruption in pumping.
† Set after hour shown.
‡ Set prior to hour shown.
§ Using a sand with a nominal 0 per cent passing the No. 100 sieve.

Table D-3
Pumping and Laboratory Test Data for All Grout Mixtures

Sand	Sand, % Passing No. 100 Sieve	Proportion by Weight			Consistency				Line Pressure psi		Pump Speed Strokes per min		Discharge cu ft per hr		Grout Temp F	Time of Set hr		Bleeding %	Compressive Strength, psi	
		Sand	Water	Cement	Torque, deg Before*	After*	Flow Cone, sec Before*	After*	Before*	After*	Before*	After*	Initial	Final		7-day	28-day			
<u>Limestone</u>																				
A	0	1.75	0.66	1.0	125	159	12.1	12.3	137	148	60	44	59	51	70	6**	17†	0.9	1795	3780
B	10	3.25	1.08	1.0	133	159	12.2	12.7	137	143	55	51	51	56	73	7**	18	1.3	660	1405
C	25	7.00	1.95	1.0	132	155	12.3	12.3	153	155	56	54	66	66	71	7**	70†	1.7	160	340
<u>Parts by Wt Fly Ash††</u>																				
A	0.11	1.90	0.73	1.0	126	150	12.0	12.4	133	135	56	50	64	59	73	6**	18†	0.9	1650	3370
A	0.25	2.50	0.80	1.0	126	155	12.0	12.2	137	142	54	55	62	59	76	5**	18†	0.8	1200	2590
A	0.43	3.20	1.08	1.0	130	157	11.8	12.3	140	142	53	51	64	59	75	5**	17	0.8	880	2095
A	0.67	3.80	1.21	1.0	129	156	12.1	12.3	140	142	54	51	62	69	78	6**	18	0.7	795	1990
A	1.00	5.00	1.58	1.0	126	145	12.0	12.3	140	143	61	56	68	65	78	7**	24	0.9	595	1385
<u>Parts by Wt Loess††</u>																				
A	0.11	1.90	0.74	1.0	131	161	11.8	12.2	140	140	59	52	64	56	77	5	19	0.8	1595	3000
A	0.25	2.50	0.92	1.0	131	162	12.1	12.7	140	143	51	45	61	56	70	7**	18†	1.0	985	1545
A	0.43	2.90	1.05	1.0	141	177	12.2	13.0	140	145	53	47	63	57	71	6-1/2	17†	0.9	735	1350
A	0.67	3.80	1.35	1.0	131	174	11.9	12.7	138	143	51	45	61	55	72	7**	23	1.1	445	845
A	1.00	4.50	1.62	1.0	129	178	11.6	12.4	140	147	55	50	65	60	77	6**	21	1.0	265	535
<u>Traprock</u>																				
<u>Sand, % Passing No. 100 Sieve</u>																				
A	0	1.75	0.68	1.0	129	146	12.0	12.3	143	143	52	49	64	62	72	5	16†	1.8	2020	4565
B	10	2.00	0.72	1.0	133	158	12.4	12.9	150	157	55	49	60	58	73	6	21†	1.6	1315	3180
C	25	2.25	0.83	1.0	130	168	12.3	12.9	155	157	53	45	64	56	75	6	17†	2.1	1265	2830
<u>Parts by Wt Fly Ash††</u>																				
A	0.11	1.94	0.73	1.0	128	150	12.2	12.7	152	152	57	53	62	58	73	4**	16†	1.5	1435	3420
A	0.25	2.50	0.90	1.0	130	149	12.3	12.7	158	157	59	54	70	67	75	7**	21†	2.2	1230	2405
A	0.43	2.90	1.03	1.0	136	151	12.3	12.6	152	153	56	54	66	65	74	6**	17†	1.6	1065	2190
A	0.67	3.80	1.24	1.0	142	163	12.3	12.9	155	158	54	52	67	64	73	7**	19	2.2	795	1770
A	1.00	4.50	1.49	1.0	132	157	12.5	12.9	153	153	56	51	69	61	74	7**	22†	1.4	710	1450

* Before or after 15-min interruption in pumping.

** Set after hour shown.

† Set prior to hour shown.

†† Using a sand with a nominal 0 per cent finer than the No. 100 sieve.

Table D-4
Pumping and Laboratory Test Data for All Grout Mixtures

Sand	Maximum Proportions by wt of Pumpable Mixtures			Consistency				Line Pressure		Pump Speed		Discharge		Grout Temp F	Time of Set		Bleeding %	Compressive Strength, psi		
	Sand	Water	Cement	Torque, deg		Flow Cone, sec		psi		Strokes per min		cu ft per hr			Initial	Final		7-day	28-day	
				Before*	After*	Before*	After*	Before*	After*	Before*	After*	Before*	After*	Before*			After*			
<u>Limestone Sand, Paddle Mixer</u>																				
Parts by wt Fly Ash**																				
B	0.11	3.00	1.03	1.0	133	144	12.4	12.6	135	140	54	50	65	63	74	5	21††	1.5	1025	1775
B	0.25	3.75	1.18	1.0	124	149	12.4	12.5	135	140	59	53	66	64	75	4	20††	1.1	800	1515
B	0.43	5.00	1.51	1.0	129	158	14.1	14.5	135	140	59	47	68	64	77	4	20††	1.7	435	925
B	0.67	6.25	1.83	1.0	124	155	14.2	14.5	135	140	57	55	72	70	78	4	20††	1.4	360	840
B	1.00	7.00	2.02	1.0	138	156	14.6	15.5	140	140	57	57	70	71	78	4	23	1.6	345	820
B	1.50	7.50	2.10	1.0	132	149	13.7	14.3	140	140	55	55	66	66	79	3	23	0.8	440	1025
Parts by wt Distomite**																				
B	0.11	4.50	1.54	1.0	136	149	12.3	12.4	135	140	63	62	72	74	73	4	19††	1.7	355	805
B	0.25	5.00	1.93	1.0	140	158	12.5	13.0	135	140	63	60	77	76	70	4	32††	1.1	200	625
B	0.43	7.25	2.44	1.0	140	172	12.8	12.5	135	140	65	65	70	70	70	4	37††	0.9	120	395
B	0.67	9.25	3.18	1.0	135	180	12.0	12.4	140	140	66	63	78	78	71	3	32††	0.7	80	330
B	1.00	12.00	4.17	1.0	135	180	11.9	12.7	138	138	66	64	80	78	74	3	82††	0.6	75	255
<u>Natural Sand, Colcrete Mixer</u>																				
Sand, % Passing No. 100 Sieve																				
A	0	2.00	0.68	1.0	132	161	12.2	13.0	150	163	64	55	74	65	88	3	9††	1.4	2095	4115
B	10	3.00	0.90	1.0	133	168	12.5	13.8	160	160	59	50	72	66	90	2	17††	1.9	1310	2625
C	25	3.50	1.00	1.0	132	165	12.5	14.0	160	160	49	45	67	62	86	2	18††	4.1	890	1910
<u>Limestone Sand, Colcrete Mixer</u>																				
B	10	3.25	1.10	1.0	133	172	12.9	13.3	160	160	61	55	71	68	86	1	17††	2.0	985	1650
<u>Traprock Sand, Colcrete Mixer</u>																				
B	10	2.00	0.82	1.0	125	168	12.0	12.7	160	160	64	61	71	71	89	4	9††	1.3	1460	2765

* Before or after 15-min interruption in pumping.
 ** Using a sand with a nominal 10 per cent passing the No. 100 sieve.
 † Set after hour shown.
 †† Set prior to hour shown.

EM 1110-2-3506
20 Jan 84

D-5

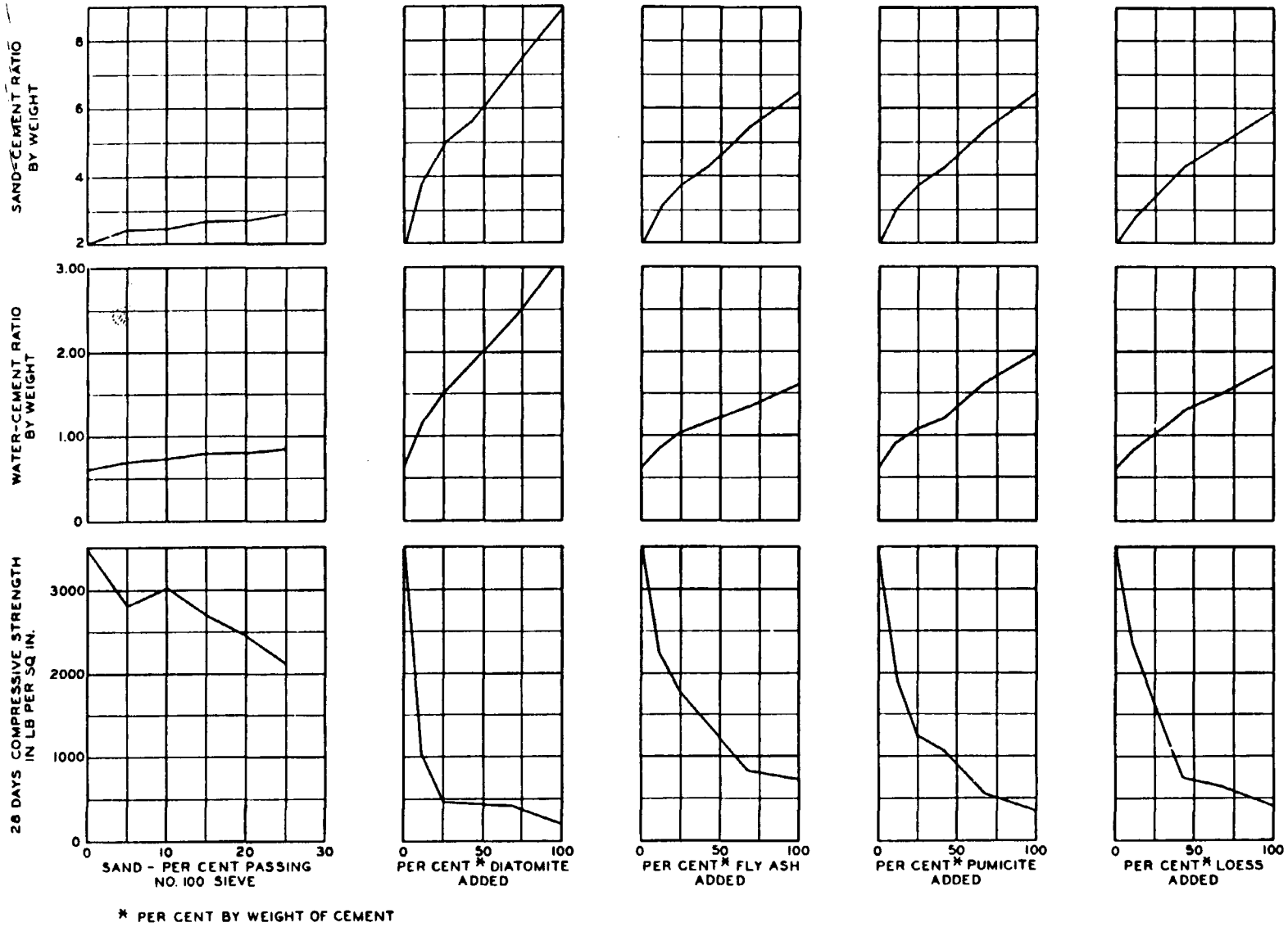

Figure D-1. Characteristics of grout mixtures

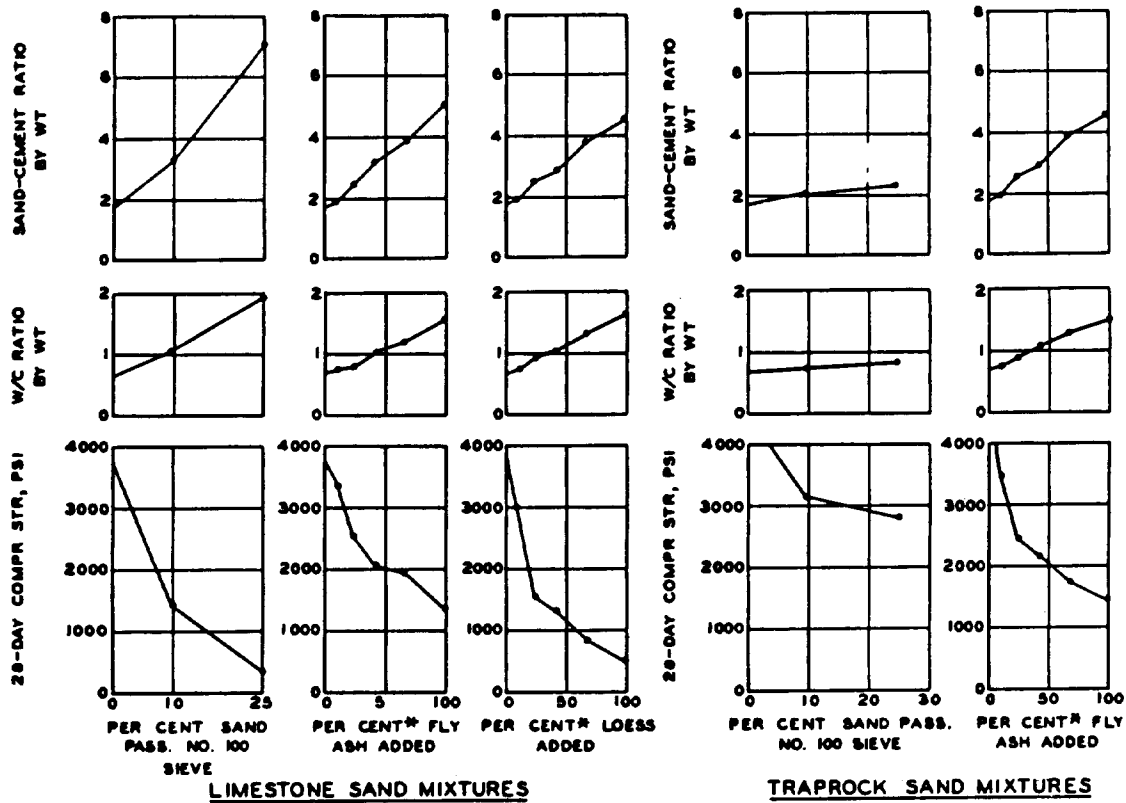

Figure D-2. Compressive strength, water-cement, and sand-cement ratios of the grout mixtures