

Chicopee, Massachusetts

Proposed Flood Control System Along Chicopee Falls

*154 Grove Street & 75 West Main Street
September 2022*

ENVIRONMENTAL ASSESSMENT



BETA

1 Springfield Street
Suite 4
Chicopee, MA 01013
413.331.5326
www.BETA-Inc.com

Proposed Flood Control System Along Chicopee Falls

Chicopee, Massachusetts

154 Grove Street & 75 West Main Street

ENVIRONMENTAL ASSESSMENT

Prepared by: **BETA GROUP, INC.**

On Behalf Of: City of Chicopee
Department of Planning and Development
274 Front Street
4th Floor City Hall Annex
Chicopee, MA 01013

Prepared for: U.S. Army Corps of Engineers, New England District

September 2022

DRAFT FINDING OF NO SIGNIFICANT IMPACT

DRAFT FINDING OF NO SIGNIFICANT IMPACT (FONSI)
CIVIL WORKS, SECTION 408 NEPA COMPLIANCE
U.S. ARMY CORPS OF ENGINEERS NEW ENGLAND DISTRICT
PROPOSED FLOOD CONTROL SYSTEM ALONG CHICOPEE FALLS
PROJECT PROPONENT: CITY OF CHICOPEE

Description of Action

An Environmental Assessment (EA) has been prepared in accordance with the National Environmental Policy Act (NEPA) of 1969 and USACE Engineering Regulation 200-2-2. This EA describes the potential environmental consequences resulting from approving, pursuant to 33 U.S.C. 408, (referred to as Section 408), modifications to the Chicopee Falls Levee in Hampden County, Chicopee, MA.

The purpose of the Project is to facilitate the establishment of a site suitable for redevelopment in support of economic improvements within the City, which will concurrently integrate numerous social and environmental benefits through redevelopment of the Site. The Project is the crucial first step in realizing these potential economic improvements in a former industrial area that has been dormant and drastically underutilized for decades. In order to develop the Site, the City will be required to fill the Site to create a separation between final grade and capped contaminated materials. This creates an opportunity to accept offsite soils with contaminant concentrations below the Reportable Concentrations presented in the Massachusetts Contingency Plan (MCP).

To meet the Project purpose and need in support of future development, the City proposes to place fill along the Chicopee Falls Levee (the Levee) on portions of the Uniroyal Parcels and the Facemate Parcel. Fill placed along the Levee within the Uniroyal Parcels will encompass approximately 7.25 acres (316,000 square feet), while fill on the Facemate Parcel will encompass approximately 1.3 acres (56,100 square feet). In total, approximately 95,980 cubic feet (3,555 cubic yards) of fill material will be required to complete the Project. The Project will also require the implementation of both construction-period and long-term stormwater management BMPs to reduce hydrostatic pressure on the Levee and mitigate alterations in runoff patterns resulting from filling and grading activities.

In addition to filling and grading activities, the City proposes to decommission the Oak Street Pumping Station and two (2) associated pipes per a USACE request, as this infrastructure is no longer required at the Site. Decommissioning activities will include demolition of the Oak Street Pumping Station, filling of the intake and discharge pipes with flowable fill, and construction of a concrete bulkhead within each pipe.

Anticipated Environmental Effects

The EA considers two (2) actions including the Proposed Action as described above, and the No Action Alternative. Both the Proposed Action and the No Action Alternative are anticipated to have little to no impact on the surrounding environment as detailed in the EA. Under the Proposed Action, any impacts to noise or traffic will be minimal, short-term, and limited to the period of active construction. Previous modeling performed for the structural integrity of the Levee following filling operations indicated no safety issues, and the updated modeling to be submitted as part of the Section 408 process is anticipated to yield the same results. Any impacts to waters of the U.S. resulting from abandonment of pipes will be temporary and is anticipated to be approved under the Section 404 Massachusetts General Permit 14:

Temporary Construction, Access, and Dewatering. Any cumulative, indirect, or secondary impacts resulting from the Proposed Action are anticipated to be negligible and will not disproportionately impact the Environmental Justice communities near the Site.

Conclusion

Based on a review of the information contained in this EA as summarized above, it is determined that the Proposed Action will not significantly affect the quality of the human environment within the meaning of Section 102(2)(c) of the National Environmental Policy Act of 1969, as amended. Therefore, the preparation of an Environmental Impact Statement is not required.

Signatory TBD

Date

TABLE OF CONTENTS

Draft Finding of No Significant Impact.....	i
1.0 Introduction	1
1.1 Purpose and Need	1
1.2 Project Location	2
1.3 Public Involvement	3
1.4 Regulatory Framework	4
2.0 Project Scope and Alternatives.....	4
2.1 Proposed Action	4
2.2 No Action Alternative	5
3.0 Affected Environment and Environmental Consequences.....	5
3.1 Affected Environment	5
3.1.1 Land Use and Zoning	5
3.1.2 Soils and Site Geology	6
3.1.3 Groundwater and Surface Water Resources.....	6
3.1.4 Jurisdictional Wetland Resources	6
3.1.5 Floodplain.....	7
3.1.6 Threatened and Endangered Species.....	7
3.1.7 Traffic and Safety.....	7
3.1.8 Noise.....	7
3.1.9 Air Quality.....	7
3.1.10 Historic and Archaeological Resources	8
3.1.11 Oil and Hazardous Materials	9
3.1.12 Socioeconomic Characteristics.....	9
3.2 Environmental Consequences	9
3.2.1 Land Use and Zoning	9
3.2.2 Soils and Site Geology	9
3.2.3 Groundwater and Surface Water Resources.....	10
3.2.4 Jurisdictional Wetlands	10
3.2.5 Floodplain.....	11
3.2.6 Threatened and Endangered Species.....	11
3.2.7 Traffic and Safety.....	11
3.2.8 Noise.....	12

3.2.9 Air Quality.....	12
3.2.10 Historic and Archaeological Resources	13
3.2.11 Oil and Hazardous Material.....	13
3.2.12 Socioeconomic Characteristics.....	14
4.0 Indirect and Secondary Effects	14
5.0 Cumulative Impacts	15
6.0 Public Notification, Distribution List and Persons Consulted	15
7.0 Compliance with Federal Environmental Statutes, Executive Orders and Executive Memoranda 16	
7.1 Federal Statutes.....	16
7.1.1 Archaeological Resources Protection Act of 1979, as amended, 16 U.S.C . 470 et seq.....	16
7.1.2 Preservation of Historic and Archeological Data Act of 1974, as amended, 16 U.S.C. 469 et seq.	16
7.1.3 American Indian Religious Freedom Act of 1978, 42 U.S.C. 1996.....	16
7.1.4 Clean Air Act, as amended, 42 U.S.C. 7401 et seq.	16
7.1.5 Clean Water Act of 1977 (Federal Water Pollution Control Act Amendments of 1972) 33 U.S.C. 1251 et seq.	16
7.1.6 Fish and Wildlife Coordination Act, as amended, 16 U.S.C. 661 et seq.	17
7.1.7 Land and Water Conservation Fund Act of 1965, as amended, 16 U.S.C. 4601 4 et seq.....	17
7.1.8 National Historic Preservation Act of 1966, as amended, 16 U.S.C. 470 et seq.	17
7.1.9 Native American Graves Protection and Repatriation Act (NAGPRA), 25 U.S.C. 3000-3013, .. U.S.C. 1170	18
7.1.10 National Environmental Policy Act of 1969, as amended, 42 U.S.C 4321 et seq.....	17
7.1.11 Rivers and Harbors Act of 1899, as amended, 33 U.S.C. 401 et seq.	17
7.1.12 Watershed Protection and Flood Prevention Act as amended, 16 U.S.C 1001 et seq.	17
7.2 Executive Orders.....	17
7.2.1 Executive Order 11593, Protection and Enhancement of the Cultural Environment, 13 May 1971.....	17
7.2.2 Executive Order 11988, Floodplain Management, 24 May 1977 amended by Executive Order 12148, 20 July 1979.....	18
7.2.3 Executive Order 11990, Protection of Wetlands, 24 May 1977.....	18
7.2.4 Executive Order 12898, Environmental Justice, 11 February 1994.	18
7.2.5 Executive Order 13007, Accommodation of Sacred Sites, 24 May 1996.....	18
7.2.6 Executive Order 13045, Protection of Children from Environmental Health Risks and Safety Risks. 21 April, 1997.	18

7.2.7 Executive Order 13061, and Amendments – Federal Support of Community Efforts Along American Heritage Rivers..... 18

7.2.8 Executive Order 13175, Consultation and Coordination with Indian Tribal Governments, 6 November 2000..... 18

7.3 Executive Memoranda..... 18

7.3.1 White House Memorandum, Government-to-Government Relations with Indian Tribes, 29 April 1994 18

8.0 Findings and Conclusions..... 19

FIGURES

- Figure 1: USGS Site Locus
- Figure 2: Aerial Site Locus
- Figure 3: Environmental Resources Map
- Figure 4: Zoning Map
- Figure 5: Soils Map
- Figure 6: Historic Resources Map
- Figure 7: FEMA FIRMette
- Figure 8: Chicopee 2020 Environmental Justice Populations Map

APPENDICES

- Appendix A: Project Plans
- Appendix B: Historic and Cultural Resources Coordination
- Appendix C: U.S. Fish and Wildlife Service Species List
- Appendix D: Stormwater Management Report

1.0 INTRODUCTION

On behalf of the City of Chicopee (the City) BETA Group, Inc. (BETA) has prepared the following Environmental Assessment (EA) narrative and associated documentation pursuant to the federal National Environmental Policy Act (NEPA) in order to secure Section 408 approval through the U.S. Army Corps of Engineers (USACE) for work proposed at the Uniroyal complex located at 154 Grove Street (the Uniroyal Parcel) and a portion of the former Facemate complex (the Facemate Parcel) located at 75 West Main Street, both in Chicopee, Massachusetts (collectively referred to as “the Site”). The City proposes to accept and place acceptable fill material at the Site to facilitate future construction and redevelopment efforts consistent with local planning efforts and municipal zoning along the Chicopee River. Specifically, fill will be placed along the Chicopee Falls Local Protection Project flood control levee (the Levee) and water intake/discharge structures and the associated pumping station along the Chicopee River will be abandoned and filled (the Project). The existing undulating topography and buried/mitigated contamination currently presents development challenges; therefore, the Project will raise the Site up to approximately eight (8) feet to create a topographically consistent development site between elevations 98 feet and 100 feet (NAVD 88).

In order to protect the environmental and the local community and economy, the Project will implement a number of best management practices (BMPs) during construction to mitigate noise, air quality degradation, and construction-period stormwater runoff. Once fill is placed and the Site is brought to final grade, long-term stormwater management BMPs will be constructed and are anticipated to be adaptable to future development requirements. As a priority Brownfields property, the Site offers a suitable location for the deposition of offsite soils with contaminant concentrations below the Reportable Concentrations specified under 310 CMR 40.0300 and 40.1600 to reduce the burden on New England landfills while supporting a crucial redevelopment effort for the City. All soil materials will be handled in accordance with the Anti-Degradation Provision of the Massachusetts Contingency Plan (MCP) at 310 CMR 40.0032(3) and are not anticipated to pose any significant risk to the future at-grade uses envisioned at the Site. The City will acquire all relevant permits and approvals to ensure compliance with the applicable regulations, including obtaining coverage under the Construction General Permit (CGP) pursuant to the National Pollutant Discharge Elimination Systems (NPDES) program, obtaining coverage under the Massachusetts General Permit pursuant to the Clean Water Act, and securing an Order of Conditions from the Chicopee Conservation Commission.

The placement of the fill material and abandonment of the pipes along the Levee, a USACE-managed structure, requires review and approval under Section 14 of the Rivers and Harbors Act of 1899 (33 U.S.C. 408 – Section 408). As a federal action, the issuance of the Section 408 approval requires the fulfillment of NEPA requirements to ensure that the proposed action will not result in negative environmental and related social and economic impacts. Based on the foregoing, and as further detailed in this EA, the Project is not anticipated to warrant an Environmental Impact Statement (EIS), as all short-term and long-term impacts to the environment will be avoided or appropriately mitigated. Accordingly, a draft Finding of No Significant Impact (FONSI) has been prepared and is attached to this EA.

1.1 PURPOSE AND NEED

The purpose of the Project is to facilitate the establishment of a site suitable for redevelopment in support of economic improvements within the City, which will concurrently integrate numerous social

and environmental benefits through redevelopment of the Site. The Project is the crucial first step in realizing these potential economic improvements in a former industrial area that has been dormant and drastically underutilized for decades. More specifically, the Project will be in support of future development that has established six (6) goals¹:

- Create mixed-use redevelopment;
- Maintain site legacy;
- Establish environmental connections;
- Establish neighborhood connections;
- Accommodate green development; and
- Demonstrate effective public-private partnerships.

The Project need has been established in light of the future redevelopment plans outlined above as well as current subsurface contamination present at the Site. In order to develop the Site, the City will be required to fill the Site to create a separation between final grade and capped contaminated materials. This creates an opportunity to accept offsite soils with contaminant concentrations below the Reportable Concentrations, which is crucial in New England due to current strains on landfill activities presented by landfill closures. As described further in this EA, existing conditions at the Site present development challenges due to undulating topography and recently demolished buildings; therefore, the fill of the Site is crucial to establishing a suitable interface between the steep embankment that comprises the Levee and the low-lying former industrial area. In addition, the abandonment of the intake/outfall pipes and an associated pumping station along the Chicopee River will be completed to fulfil a request from the U.S. Army Corps of Engineers (USACE) and prevent future withdrawals from the existing pump station infrastructure and detach the property from its historic industrial and environmentally intensive usage.

1.2 PROJECT LOCATION

As discussed in Section 1.0 above, the Site is located along the eastern bank of the Chicopee River and consists of two (2) discrete areas; the Uniroyal Parcels at the south end of the Site and the Facemate Parcel at the north end.

Uniroyal Parcels

The Uniroyal Parcels include five (5) parcels with a combined area of approximately 22.47 acres. The Uniroyal Parcels were formerly used for environmentally intensive industrial purposes including a lumber yard, a tire manufacturing plant, printing shops, machine shops, office buildings, storage facilities, and healthcare facilities. These parcels are bounded to the east, south, and north by public rights-of-way and to the west by the Levee and the Chicopee River. In 2009, the Uniroyal Parcels were acquired by the City of Chicopee and have remained vacant except for an auto repair shop located to the east along Grove Street.

The Uniroyal Parcels originally included over 24 buildings of various sizes and layouts. As of this writing, six (6) buildings remain, and the undulating topography outlines former locations of foundations and structures. As discussed later in this EA, the buildings as well as the top of the Levee are a part of the Fisk Rubber Company Complex, an Inventoried Area per the Massachusetts Cultural Resource

¹ <https://www.chicopeema.gov/562/RiverMills-at-Chicopee-Falls>

Information System (MACRIS). The buildings that remain onsite include the Oak Street Pump Station which, in conjunction with the associated intake and discharge pipes, will be decommissioned.

Remediation activities conducted at the Uniroyal Parcels have resulted in the generation of demolition wastes and other materials that have either been disposed of off-site or managed onsite as backfill materials. All backfill materials have been capped-in-place in accordance with relevant regulations.

Facemate Parcel

The Facemate Parcel includes one (1) parcel with an area of approximately 4.05 acres. The portion of the Site is also associated with industrial land uses including the production of cotton cloth. This parcel is associated with the larger Facemate complex that was acquired by the City in 2010 and reflects the subdivision of land that occurred soon thereafter. The remaining parcels associated with the Facemate complex are not subject to this EA, as no work on USACE structures will occur on those parcels. The Facemate parcel is bounded to the south by the Uniroyal Parcels, to the north by the remainder of the historic Facemate complex, to the west by the Levee and the Chicopee River, and to the east by a public right-of-way.

The Facemate Parcel originally included four (4) buildings; however, only one (1) remains after the completion of demolition activities.

Remediation activities conducted at the Facemate Parcel have resulted in the generation of demolition wastes and other materials that have either been disposed of off-site or managed onsite as backfill materials. All backfill materials have been capped-in-place in accordance with relevant regulations.

1.3 PUBLIC INVOLVEMENT

Public involvement has not been engaged for the Project as it relates to the Proposed Action at hand (i.e., the filling of the Site). It is anticipated that public involvement will occur throughout the following processes:

- Public hearings with the Chicopee Conservation Commission;
- Public hearings with the Chicopee Planning Board; and
- The 30-day comment period associated with the submission and publication of this EA.

Although not directly related to the Project subject to this EA, numerous public meetings have been held since 2010 to support the City's efforts to redevelop the Site. Public engagement efforts completed as part of that process include the following:

- Completion of community surveys to seek input on potential Site uses from the public;
- Completing a year-long community process to develop the RiverMills Vision Plan in 2011; and
- Public meeting for U.S. Environmental Protection Agency (EPA) Brownfields Cleanup Grants between 2010 and 2016.

As noted above, USACE consider comments received during the EA 30-day public notice and comment period and integrate relevant issues and concerns into the final EA. Following a final review period, the USACE will, if applicable, sign and execute the FONSI and proceed with the Proposed Action.

1.4 REGULATORY FRAMEWORK

This EA has been prepared in accordance with the National Environmental Policy Act (NEPA) and associated implementation procedures most recently updated as of June 4, 2020². The NEPA and Title 40 of the Code of Federal Regulations (CFR), Parts 1500-1508; 1515-1518 (40 CFR 1500-1508; 1515-1518) require Federal agencies to consider the potential environmental consequences of proposed actions and alternatives.

The Project Scope for NEPA review purposes is limited to the component of the Project that under the control of the USACE. Although some aspects of the future development of the Site are assessed under this EA for their potential cumulative and indirect impacts stemming from placement of fill against a USACE structure, the Project Scope strictly pertains to the placement of fill against the Levee and the work to abandon structures including intake/discharge pipes and the Oak Street Pump Station, as well as all directly associated construction activities. The exact future proposed conditions across the entire Site cannot be determined at this time and are not considered to be under the control of the USACE.

2.0 PROJECT SCOPE AND ALTERNATIVES

2.1 PROPOSED ACTION

To meet the Project purpose and need in support of future development, the City proposes to place fill along the Levee on portions of the Uniroyal Parcels and the Facemate Parcel. Fill placed along the Levee within the Uniroyal Parcels will encompass approximately 7.25 acres (316,000 square feet), while fill on the Facemate Parcel will encompass approximately 1.3 acres (56,100 square feet). In total, approximately 95,980 cubic feet (3,555 cubic yards) of fill material will be required to complete the Project. All backfilling activities will be conducted in accordance with the City's Fill Management Plan (FMP) and may result in importing the following materials to the Site:

- Naturally occurring, uncontaminated soils that do not originate from an MCP Disposal Site and are not otherwise regulated;
- Soils from MCP Disposal Sites that do not exceed applicable reportable criteria for any portion of the Site and meets the specific requirements of 310 CMR 40.0032(3);
- Soils and/or sediments that do not meet the definition of "Remediation Waste" as defined in 310 CMR 40.0006;
- Dredged sediments with no free-draining liquids;
- Uncoated and processed asphalt, brick, and concrete (ABC) rubble generated from onsite sources; and
- Street sweeping tailings from the City and other local communities.

The Project will require the implementation of both construction-period and long-term stormwater management BMPs to reduce hydrostatic pressure on the Levee and mitigate alterations in runoff patterns resulting from filling and grading activities. Construction-period stormwater management BMPs will likely consist of at-grade basin and swale conveyances to direct stormwater away from the Levee. Long-term BMPs are depicted on the Project Plans in Appendix A and include a network of linear basins interconnected by a perforated high-density polyethylene (HDPE) pipe intended to convey

² <https://ceq.doe.gov/docs/laws-regulations/federal-agency-nepa-implementing-procedures-2020-06-04.pdf>

stormwater into retrofit drainage structures to the south and ultimately to an existing outfall³ along the Chicopee River. A Stormwater Management Report is included in Appendix D and summarizes the stormwater management system design and compliance with the Massachusetts Stormwater Management Standards.

In addition to filling and grading activities, the City proposes to decommission the Oak Street Pumping Station and two (2) associated pipes per a USACE request, as this infrastructure is no longer required at the Site. Decommissioning activities will include demolition of the Oak Street Pumping Station, filling of the intake and discharge pipes with flowable fill, and construction of a concrete bulkhead within each pipe. Portions of this work will involve establishing cofferdams and dry working conditions within the Chicopee River as further detailed later in this EA.

2.2 NO ACTION ALTERNATIVE

In accordance with CEQ regulations for implementing NEPA, an evaluation of the No Action Alternative is provided herein.

Implementation of the No Action Alternative in place of the Proposed Action would result in no fill being placed on the Site adjacent to the flood control levee. For this alternative, limited backfill of low-lying areas would likely still occur, but the fill areas would be greatly reduced in size. In addition, the Oak Street Pumping Station would not be removed, and the intake and discharge pipes would not be affected. The ability of the Levee to maintain its function of flood control is anticipated to be unaffected by the No Action Alternative.

As noted above, avoiding the placement of fill along the Levee could potentially lead to other alternatives that would result in providing developable area at the Site, albeit at a much smaller scale. This would ultimately result in fewer opportunities for stormwater management, as the City would be required to create a fill area that slopes down to a wide, flat area along the Levee that would not receive treatment for stormwater runoff due to no action being taken along the Levee. In addition, the No Action Alternative would not result in the abandonment of the Oak Street Pumping Station and its associated infrastructure, and the City would continue to be responsible for operation and maintenance of the system.

The No Action Alternative would also preclude the City from accepting reusable materials as fill and therefore would not relieve any burden from local landfills in Massachusetts. Further, the City would be less likely to remove or reuse the remainder of the existing dilapidated buildings, resulting in underutilization of the property that will not provide the economic or environmental benefits of the Proposed Action.

3.0 AFFECTED ENVIRONMENT AND ENVIRONMENTAL CONSEQUENCES

3.1 AFFECTED ENVIRONMENT

3.1.1 LAND USE AND ZONING

Current land use in the vicinity of the Site is a mix of abandoned industrial, institutional, commercial and residential uses (Figure 4). The Site includes seven (7) buildings, four (4) of which are currently vacant

³ This outfall is to remain and will not be abandoned as part of the abandonment of two (2) other structures along the Levee.

and not slated for future demolition. One (1) building is currently occupied by small businesses, and two (2) buildings are slated for demolition. The closest residential properties to the Uniroyal Parcels and Facemate Parcel fill areas are located approximately 540 feet and 740 feet away, respectively.

The City of Chicopee has enacted a Zoning Ordinance (Chapter 275 of the Code of the City of Chicopee) to regulate land development in the City. Under this ordinance, the Site is located within the Industrial Zoning District and the Chicopee Mill Conversion and Commercial Center overlay district. Land in the overlay district may be used for any purpose permitted in the underlying district and is subject to the underlying district restrictions. Exercise of Mill Conversion and Commercial Center Overlay District regulations is subject to a special permit from the City Council.

3.1.2 SOILS AND SITE GEOLOGY

According to the Natural Resources Conservation Service (NRCS)'s Web Soil Survey, soils on and near the Site consist primarily of Urban land with the southern extent of the Site being mapped as Urban land-Hinckley-Windsor Association.

As part of environmental Site assessment activities, soil borings have been conducted in several locations around the Site and numerous groundwater monitoring wells have been installed. According to field observations, shallow soils (depths of approximately 0-10 feet) typically consist of silty sand and gravel with urban fill material; the urban fill primarily consists of slag and coal debris. Deeper soils (depths of 10 feet or more) typically consist of sand and gravel with varying amounts of silt.

According to the Bedrock Geologic Map of Massachusetts (Zen, 1983), the Site is located within the Connecticut Valley Belt, Hartford basin, and is underlain by the Portland Formation, mapping unit "Jp". This mapping unit is classified as reddish-brown to pale red arkose and siltstone, and grey sandstone, grey siltstone, and black shale interpreted as lake beds.

3.1.3 GROUNDWATER AND SURFACE WATER RESOURCES

According to Massachusetts Geographic Information Systems (MassGIS) data, the Site is not located in an area mapped as a high or medium yield, or EPA sole source aquifer. The Site is not located within a drinking water wellhead protection area (Zone I, Zone II, Interim Wellhead Protection Area), nor is it located within a public surface water supply protection area (Zone A, Zone B, Outstanding Resource Waters) (Figure 3). The Chicopee River abuts the western Site boundary.

Based on gauging data collected from groundwater monitoring wells, the depth to groundwater along the western portion of the Uniroyal Parcels is approximately four (4) to five (5) feet below grade. Depth to groundwater within the western portion of the Facemate Parcel is approximately ten (10) to fifteen (15) feet below grade. The groundwater flow direction in the vicinity of the Site is inferred to be to the west-southwest, towards the Chicopee River.

3.1.4 JURISDICTIONAL WETLAND RESOURCES

The Chicopee River flows in a southerly direction along the western extent of the Site and is jurisdictional up to the Ordinary High Water (OHW) mark as a water of the United States (U.S.) under Section 404 of the Clean Water Act (Section 404) (Figure 3). In addition, the following Areas Subject to Protection and Jurisdiction under the Massachusetts Protection Act (M.G.L. ch.131 s.40 – the Act) and its implementing regulations (310 CMR 10.00) are associated with the Chicopee River:

- Bank;
- Land Under Water (LUW);

- Bordering Land Subject to Flooding (BLSF);
- Riverfront Area (RA); and
- The 100-foot Buffer Zone.

BLSF at the Site is coincident with the 100-year floodplain, which is described further in Section 3.1.5.

3.1.5 FLOODPLAIN

Due to the presence of the Levee, the entirety of the Site is located upgradient of the 100-year floodplain, the extent of which is mapped at a base flood elevation (BFE) ranging from 92 feet to 94 feet (NAVD88) (Figure 7). The Chicopee River is also associated with a FEMA Regulatory Floodway.

3.1.6 THREATENED AND ENDANGERED SPECIES

According to the Official Species List obtained from the U.S. Fish and Wildlife Service (USFWS), there is no endangered or threatened species habitat located at the Site. The USFWS indicates that a candidate species, the monarch butterfly (*Danaus plexippus*), could potentially be present at the Site.

The Site is not located within any Massachusetts Natural Heritage and Endangered Species Program (NHESP)-mapped Priority Habitats or Rare Species or Estimated Habitats of Rare Wildlife (Figure 3).

3.1.7 TRAFFIC AND SAFETY

The Site is currently vacant with the exception of small businesses located in one (1) of the remaining buildings, which uses an entrance/egress point independent from the remainder of the Site. Accordingly, minimal traffic is currently generated by the Site as a whole.

The Uniroyal Parcels are directly accessible from Grove Street and Oak Street, both of which are City-owned public rights-of-way along the eastern extent of the Site. The Facemate Parcel is accessible via West Main Street, which is also a City-owned public right-of-way. Chain link fencing is currently present around the perimeter of the Site to inhibit access.

The Site is accessible from the regional highway network, most directly from the Massachusetts Turnpike (I-90) to the north of the Site. Regional highway access is also available from I-391 to the west of the Site and from I-291 to the east of the Site.

3.1.8 NOISE

The Site is located within a densely developed portion of the City with noise levels typical of an urban environment. As manufacturing activities on the Project Site are no longer active, the Project Site does not generate noise. Periodic ongoing hazardous materials assessment and cleanup activities may generate construction related noise on an intermittent basis.

The City has promulgated a Noise Control ordinance which limits noise from construction activities to the hours of 7 AM to 9 PM on weekdays (Monday through Friday).

3.1.9 AIR QUALITY

National Ambient Air Quality Standards (NAAQS) have been established for six contaminants, referred to as criteria pollutants as required by the Clean Air Act, for the following:

- Carbon monoxide (CO);
- Nitrogen dioxide (NO²);
- Ozone (O³);

Chicopee, Massachusetts

- Particulate matter (PM₁₀: diameter ≤ 10 micrometers, and PM_{2.5}: diameter ≤ 2.5 micrometers);
- Lead (Pb); and
- Sulfur dioxide (SO₂).

Areas that meet the NAAQS for a criterion pollutant are designated as “attainment” and areas where a criterion pollutant level exceeds the NAAQS are designated as “nonattainment.” O₃ nonattainment areas are categorized based on the severity of the pollution problem - marginal, moderate, serious, severe, or extreme. CO and PM₁₀ nonattainment areas are categorized as either moderate or serious.

The Site is located within a nonattainment area for O₃ and attainment for all other criteria pollutants.

The Clean Air Act Amendments (CAAA) of 1990 expands the scope and content of the act's conformity provisions in terms of their relationship to a State Implementation Plan (SIP). Under Section 176(c) of CAAA, a project is in “conformity” if it corresponds to a SIP’s purpose of eliminating or reducing the severity and number of violations of the NAAQS and achieving attainment.

The USEPA published final rules on general conformity (40 CFR Parts 51 and 93) in the Federal Register on November 30, 1993. The rules apply to federal actions in nonattainment or maintenance areas for any of the criteria pollutants. The rules specify *de minimis* emission levels for each pollutant, used to determine the applicability of conformity requirements to a project. The General Conformity Rule applies to the Proposed Action since it is located in the Hampden County 8-hour O₃ nonattainment area.

This EA follows the *Draft NEPA Guidance on Consideration of the Effects of Climate Change and Greenhouse Gas* issued by the Council of Environmental Quality (CEQ). The potential effects of proposed GHG emissions are, by nature, global and cumulative impacts, as individual sources of GHG emissions are not large enough to have an appreciable effect on climate change. As such, this EA predicts CO₂ levels as appropriate for disclosure purposes.

3.1.10 HISTORIC AND ARCHAEOLOGICAL RESOURCES

The Massachusetts Historical Commission (MHC)’s online database was reviewed to identify any historic resources within or adjacent to the Site. The MHC’s online database (MACRIS) lists the following resources:

- CHI.K – Fisk Rubber Company Complex (Inventoried Area)
- CHI.Q – Chicopee Manufacturing Company (Inventoried Area)

A Project Notification Form (PNF) was previously submitted to the MHC for the demolition of eight (8) structurally unsound buildings at the Site. The PNF was assigned MHC Project #46829 and a Memorandum of Agreement (MOA) was subsequently issued by MHC on or about April 5, 2011. Inventoried buildings identified by MHC as CHI.553, CHI.554, and CHI.555 have been demolished following the issuance of the aforementioned 2011 MOA. The following inventoried buildings remain at the Site:

- CHI.228 – Fisk Rubber Company Office – 154 Grove Street (Inventoried Building)
- CHI.556 – Fisk Rubber Company Office Building and Garage – 154 Grove Street (Inventoried Building)

A PNF specific to the Project proposed under this EA was submitted to MHC, the Board of Underwater Archaeological Resources (BUAR), and all relevant tribes on August 5, 2022. A copy of this coordination

and the 2011 MOA are included in Appendix B. No response has been received by any recipients of the PNF as of this writing.

3.1.11 OIL AND HAZARDOUS MATERIALS

Various regulated oil and/or hazardous materials (OHM) have been identified within the former buildings on the Uniroyal Parcels; the presence of these OHM pose as a risk to human health and the environment. OHM identified in the various buildings includes the following:

- Asbestos containing building materials (ACBM), such as thermal systems, insulation, floor tile, roofing materials, plaster and various mastics/adhesives;
- Lead based paint (LBP);
- Mercury containing switches, components and building materials, such as thermostats and fluorescent light bulbs;
- Pigeon guano and animal droppings; and
- Polychlorinated biphenyls (PCBs) in building materials and components, such as window caulking, fluorescent light ballasts and transformers.

The Commonwealth of Massachusetts has designated this site as part of the Brownfields Support Team Initiative; as a state-designated Brownfields Priority Project, demolition and cleanup have been ongoing since 2010. To date, 18 former industrial buildings have been demolished at the Site.

3.1.12 SOCIOECONOMIC CHARACTERISTICS

U.S. Census data for the year 2020 was reviewed to determine whether minority and/or low-income populations that may be disproportionately impacted by federal actions are present near the Site. As depicted on Figure 8, the Site is entirely located within an Environmental Justice Community associated with minority and income criteria. The Site is also located within one (1) mile of other census block groups associated with both minority and income.

3.2 ENVIRONMENTAL CONSEQUENCES

3.2.1 LAND USE AND ZONING

The scope of the Project under this EA is limited to the placement of fill soils against the Levee and the abandonment of associated drainage infrastructure; accordingly, neither the Proposed Action nor the No Action Alternative will result in impacts to land use or zoning. The Proposed Action will not change the existing use of the Site; will enable the future development of the site as envisioned by the City; and does not require review or approval by the City's Zoning Board of Appeals. Stormwater management BMPs will be installed at the Site near the Levee to reduce any likelihood of adverse effects on nearby properties attributed to stormwater runoff.

3.2.2 SOILS AND SITE GEOLOGY

The No Action Alternative will have no impact on the Site's geology or soil composition, as existing conditions will be maintained.

Structural engineering studies are required under the USACE Section 408 approval process in order to document that earthwork along the Levee will not compromise its structural integrity. The Project has been under design since the mid-2010's and a slope stability analysis was previously performed on a representative section of the levee (Station 41 + 00) and a "worst case" section (Station 13 + 30). The sections were analyzed for the three separate conditions as described in the USACE manual: rapid

drawdown (performed using the USACE 3-stage method), long-term (steady seepage during 100-year flood conditions), and normal water conditions. The results of the analysis indicated that the computed factors of safety for the proposed conditions met or exceeded the required minimum factor of safety for each of the three (3) cases. To limit the buildup of hydrostatic pressures against the landward side of the levee, stormwater basins with perforated underdrain pipes will be constructed along the landward side of the levee as depicted on Appendix A and described in Appendix D.

Due to design revisions, a structural analysis is currently being performed for the same scenarios as described above. The full results of this analysis will be submitted to USACE during the Section 408 process; however, it is anticipated that the same results as the initial analysis will be recognized. Completion of the new analysis and approval from the USACE during the Section 408 process will demonstrate that the Proposed Action will not adversely affect the soils or geology that comprise the stability of the Site and the Levee.

3.2.3 GROUNDWATER AND SURFACE WATER RESOURCES

The Site is not located within any groundwater or surface water protection areas associated with public drinking water supplies. In addition, excavation below existing grade is not proposed; therefore, groundwater is not anticipated to be encountered. Surface waters associated with the Chicopee River will be protected by the implementation of an erosion and sediment control plan during construction and until full Site stabilization is achieved, which includes use of in-water erosion and sedimentation controls during the abandonment of the two (2) pipes along the bank of the Chicopee River (Appendix A). Therefore, neither the Proposed Action nor the No Action Alternative are anticipated to have any impacts to groundwater or surface water resources.

3.2.4 JURISDICTIONAL WETLANDS

Under the No Action Alternative, there would be no temporary or permanent impacts to jurisdictional wetlands at the Site.

Under the Proposed Action, the portion of the Project associated with the filling and grading of the Site would occur entire within upland areas and would not result in temporary or permanent impacts to waters of the U.S. The Proposed Action would, however, impact Areas Subject to Protection/Jurisdiction under the Act including RA and the 100-foot Buffer Zone. Given the degraded nature of the Site under existing conditions, the Project will offer an improvement over existing conditions by better managing stormwater runoff along the Levee. This work will be subject to the filing of a Notice of Intent (NOI) with the Chicopee Conservation Commission.

The portion of the Project associated with the abandonment of the intake and outfall pipes along the Chicopee River will require temporary impacts to waters of the U.S. (i.e., the land below the OHW mark of the Chicopee River) in order to establish dry working conditions. Areas Subject to Protection under the Act that would be temporarily impacted by this portion of the Projects includes Bank and LUW. A temporary cofferdam will be installed within the Chicopee River and pumps will be used to dewater the work area. Existing sediment and debris will be removed from the pipes and disposed of offsite. In order to abandon the pipes, flowable fill will be pumped into the pipes and concrete bulkheads will be installed as permanent seals. All impacts to the Chicopee River will be temporary in nature, as the cofferdams will be removed following completion of the work and the riprap that comprises the Bank will be unaffected. Impacts are anticipated to include 1,660 square feet of temporary impacts to waters of the U.S. (streambed) and 71 square feet of temporary impacts to streambank.

This work and associated mitigation will be disclosed in the NOI submitted to the Chicopee Conservation Commission and is anticipated to receive USACE approval under the Section 404 General Permit 14: Temporary Construction, Access, and Dewatering. Therefore, no adverse impacts are jurisdictional wetlands are anticipated beyond the construction.

3.2.5 FLOODPLAIN

Under the No Action Alternative, no work would be performed within the 100-year floodplain or the Regulatory Floodway.

As described in Section 3.2.4, temporary impacts to the Chicopee River are required to abandon the two (2) pipes along the Levee; therefore, work will occur within the 100-year floodplain and the Regulatory Floodway under the Proposed Action. It is anticipated that any potential floodplain impacts will be mitigated by scheduling work outside of potential storm events and requiring the selected contractor to develop a work plan that addressed flood and inclement weather contingencies. The Proposed Action will not result in placement of any fill within the floodplain or structures within the Regulatory Floodway.

3.2.6 THREATENED AND ENDANGERED SPECIES

As noted in Section 3.1.6, there are no federally mapped endangered or threatened species at the Site, nor are there any NHESP-mapped Priority Habitats of Rare Species or Estimated Habitats of Rare Wildlife. Therefore, neither the Proposed Action or the No Action Alternative will result in any impacts to threatened or endangered species.

3.2.7 TRAFFIC AND SAFETY

Under the No Action Alternative, no changes to existing traffic patterns or general safety measures would be realized.

Temporary, construction-period impacts to traffic are anticipated under the Proposed Action. Filling operations would likely entail one (1) of two (2) scenarios:

- Trucks delivering excess soils from various locations would visit the Site approximately six (6) times per day over the course of two (2) weeks; or
- Processed materials from a local source would involve numerous (upwards of 50) trucks visiting the Site per day, albeit within a shorter timeframe.

The timeframes above assume constant material deliveries occurring which, dependent on market conditions and other uncontrollable factors, is not likely to be the case. The Project may occur over the course of up to 125 weeks, although deliveries would not be occurring constantly during that time period.

It is anticipated that routes taken by trucks would vary, thereby limiting any local congestion or traffic buildup. It is anticipated that regional and local roadway infrastructure would be able to accommodate this truck traffic. Road closures will not be required, and all trucks will be directed to specific entrance and egress points established at the Site. All vehicular operators will be required to abide by local speed limits, roadway restrictions, and other safety measures. In addition, security fencing will be maintained around the Site perimeter to prevent unpermitted access by unauthorized personnel. Therefore, it is anticipated that temporary impacts to traffic and safety will be adequately addressed.

3.2.8 NOISE

Under the No Action Alternative, there would be no change in existing ambient noise levels at or near the Site.

Under the Proposed Action, construction noise would result from activities such as construction vehicle engine noise, vehicle back up warning beepers, and stationary electric generators (if used). In accordance with the City's Noise Ordinance, these construction activities would be limited to the hours of 7 AM to 9 PM on weekdays (Monday through Friday). Given that noise impacts are anticipated to be consistent with standard construction activities occurring throughout the City, no noise modeling has been performed. No residential properties directly abut the work areas, and abiding by the City's noise ordinance is anticipated to adequately mitigate temporary, construction-period noise impacts associated with the Project.

3.2.9 AIR QUALITY

The Proposed Action was evaluated for conformance to the Air Quality Conformity requirements of the Clean Air Act. The fill placement activities, including grading, were estimated to extend over a period of 125 weeks (624 workdays). The emissions inventory included only equipment used on the Site to place and compact the imported soils and install the proposed drainage layer adjacent to the flood control levee. On-road trucks delivering soils and construction employee vehicles were not included as these are assumed to be on the road regardless of whether the Proposed Action is occurring. Emissions from on-road vehicles are included in the emissions inventory and modeling completed by the Metropolitan Planning Organization under the transportation conformity requirements of the CAAA.

The results of the analysis are presented in Table 1 below. The results indicate that emissions from the Proposed Action are de minimis. Estimated annual NO_x emissions are 15.74 tons and below the annual de minimis standard of 100 tons. Estimated annual VOC emissions are 2.22 tons below the annual de minimis standard of 50 tons.

Under the No Action Alternative, no filling of the Site with imported soils would occur and no construction vehicles would be required; therefore, no impacts to air quality were anticipated.

As no adverse impacts are anticipated from implementation of the Proposed Action, no mitigation measures are required.

Table 1. General Conformity Review and Emission Inventory

General Conformity Review and Emission Inventory for the Chicopee Falls site redevelopment Project (Worst Case Analysis)											
1	2	3	4	5	6	7	8	9	10	11	
Equipment/Engine Category	Project Emission Sources and Estimated Power						NOx Emission Estimates		VOC Emission Estimates		
	# of Engines	hp	LF	hrs/day	Days of Operation	hp-hr	NOx EF (g/hp-hr)	NOx Emissions (tons)	VOC EF (g/hp-hr)	VOC Emissions (tons)	
Rollers	1	300	1.00	10	624	1,872,000	9.200	18.98	1.300	2.68	
Dewatering Pumps	0	32	1.00	24	624	-	9.200	0.00	1.300	0.00	
Dragline	0	180	1.00	10	624	-	9.200	0.00	1.300	0.00	
Air Compressors	0	115	1.00	24	624	-	9.200	0.00	1.300	0.00	
Hyd Excavator	1	150	1.00	10	624	936,000	9.200	9.49	1.300	1.34	
Chainsaw	0	10	1.00	10	624	-	9.200	0.00	1.300	0.00	
Dozers, Crawler	1	440	1.00	10	624	2,745,600	9.200	27.84	1.300	3.93	
LDR, BH, WH 1.75CY FE Bkt	1	105	1.00	10	624	655,200	9.200	6.64	1.300	0.94	
Trucks Highway	0	330	1.00	10	624	-	9.200	0.00	1.300	0.00	
Trucks Off-Highway	0	175	1.00	10	624	-	9.200	0.00	1.300	0.00	
Total Emissions							NOx Total	62.96	VOC Total	8.90	
							Annual	15.74	Annual	2.22	
							Standard	100	Standard	50	

The change in climate conditions caused by GHG resulting from the burning of fossil fuels from construction vehicle traffic and fill placement activities associated with the Proposed Action requires that the emissions be assessed on a global scale. Consequently, given the minimal increase predicted for the Project, which is well below the CEQ meaningful assessment threshold of 25,000 metric tons per year, the proposed project would result in an insignificant impact on overall global or U.S. cumulative GHG emissions and global climate change. Therefore, no specific GHG emission mitigation measures are warranted.

3.2.10 HISTORIC AND ARCHAEOLOGICAL RESOURCES

As noted in Section 3.1.10, a PNF specific to the Project proposed under this EA was submitted to MHC, the Board of Underwater Archaeologic Resources (BUAR), and all relevant tribes on August 5, 2022. A copy of this coordination and the 2011 MOA are included in Appendix B. No response has been received by any recipients of the PNF as of this writing.

Since the demolition of structures at the Site is covered under the MOA entered by the City and MHC in 2011, it is anticipated that MHC will make a “No Adverse Effect” finding for the filling and grading activities proposed under the Proposed Action. No excavation below existing grade is proposed, and any further building demolition performed incidental to the Site filling and grading will be conducted under the provisions of the MOA. Therefore, no impacts to historic or archaeological resources are anticipated under the Proposed Action or the No Action Alternative.

3.2.11 OIL AND HAZARDOUS MATERIAL

Remediation activities have been performed for contaminants previously discovered at the Site, and the Preferred Action will not result in any additional hazardous materials with reportable levels of contaminant concentrations being imported to the Site. An FMP for imported materials with concentrations of contaminants lower than reportable levels will be followed during construction; imported soils will provide a further separation between the capped contaminants present at the Site and the new developable Site grade.

Neither the Proposed Action nor the No Action Alternative will result in the placement of regulated oil and hazardous material at the Site and will not affect ongoing Site cleanup. Furthermore, since only unregulated and/or inert materials would be permitted, no adverse environmental impacts are expected

to result as part of the Project. Should additional contaminants be discovered during backfilling operations, the contractor will be required to handle all hazardous materials per the provisions of the MCP.

3.2.12 SOCIOECONOMIC CHARACTERISTICS

As noted in Section 3.1.12, the Site is located within an Environmental Justice (EJ) community. Under the Proposed Action, the surrounding EJ community may be temporarily exposed to elevated noise levels typical of construction sites. However, all construction operations will be limited to the hours set forth by the City's Noise Ordinance and will be temporary in nature until backfilling activities are completed. Potential construction noise impacts are not considered significant and are not considered to be a disproportionate impact to the adjacent minority and low-income populations.

The No Action Alternative would not result in any short-term or long-term adverse impacts to EJ populations.

4.0 INDIRECT AND SECONDARY EFFECTS

The indirect impacts were evaluated based on the President's CEQ regulations implementing NEPA and the Code of Federal Regulations, Title 40, Section 1508.7⁴.

The portion of the Proposed Action related to Site filling will present the indirect and secondary effects of the Site being more conducive to a wider range of potential development options given that potential developers will be presented with a Site that has been graded to a relatively flat, developable area. Although future redevelopment will be subject to factors outside of the control of the development or the proponent including real estate trends and regional development directives, the Proposed Action could potentially result in a localized increase in housing density should a residential project be proposed and approved. Further, any potential commercial development may result in increased traffic due to material deliveries. In either scenario, the development would likely tie into municipal water and sewer, which will be subject to coordination with the appropriate municipal officials to ensure that the capacity of the systems are not adversely impacted. Any future indirect and secondary effects would be primarily related to traffic and construction-period noise and emissions; given the layout of the Site, no future impacts to jurisdictional wetlands or the floodplain would be anticipated under either the Proposed Action or the No Action Alternative.

Although placing fill up to and along the Levee would provide the most developable area at the Site, development of the Site is possible without the placement of fill along that portion of the Site. Therefore, the No Action Alternative would also have the potential indirect and secondary effect of a development, albeit at a smaller scale, which any associated impacts would be commensurate with.

It is not anticipated that the pipe abandonment portion of the Project will have any indirect or secondary effects under either the Proposed Action or the No Action Scenario.

⁴ Indirect impacts are defined as those impacts "...which are caused by the proposed action and are later in time or farther removed in distance but are still reasonably foreseeable. Indirect effects may include growth inducing effects and other effects related to the induced changes in the pattern of land use, population density or growth rate, and related effects on air and water and other natural systems, including ecosystems."

5.0 CUMULATIVE IMPACTS

The CEQ's NEPA regulations require assessment of the cumulative⁵ impacts of a project; this assessment is not limited solely to federal activities and projects⁶. The project area subject to this review consists of the Site as a whole, rather than just the area along the Levee under control of the USACE.

Development at the Site would likely be significantly scaled down under the No Action Alternative; therefore, no cumulative impacts are anticipated under that scenario. Should the Proposed Action be implemented, other portions of the Site not subject to this EA and the forthcoming Section 408 application may be more enticing for developers to capitalize on with additional development. The Proposed Action coupled with additional development may then have the cumulative impact of degradation of the following resources:

- Air quality;
- Traffic; and
- Noise.

Should the Proposed Action lead to an expansion of residential development, this densely settled portion of Chicopee would be subjected to additional traffic, as residents would be expected to use personal vehicles for transportation given the lack of public transportation in the immediate vicinity of the Site. While this may incrementally contribute to air quality (emissions) and noise (residential activities), those two (2) resources are likely to be impacted to a higher degree should the Proposed Action result in a series of commercial developments. In the scenario of a commercial development, consistent truck traffic would likely contribute to a rise in average ambient noise levels within the area surrounding the Site, and measures such as prohibitions on idling would be required to prevent degradation of air quality. Either scenario would also present the cumulative impact of a shift in land use, as any development would be a significant change from the current abandoned nature of the Site.

Given where the Site is situated in relation to the Levee, it is anticipated that any projects resulting from the Proposed Action would not result in any degradation of other resources including jurisdictional wetlands and floodplain.

6.0 PUBLIC NOTIFICATION, DISTRIBUTION LIST AND PERSONS CONSULTED

Persons consulted in the preparation of this EA include:

- Lee Pouliot, ASLA, Director, Chicopee Planning Department
- Susi Van Ottingen, Endangered Species Biologist, US Fish and Wildlife Service, Concord, NH
- Emily Holt, Massachusetts Natural Heritage and Endangered Species Program
- Jonathan K. Patton, Archaeological/Preservation Planner, Massachusetts Historical Commission

⁵ NEPA regulations define cumulative effects as: "the impact on the environment which results from the incremental impact of the action when added to other past, present, and reasonably foreseeable future actions regardless of what agency (Federal or non-Federal) or person undertakes such other actions. Cumulative impacts can result from individually minor but collectively significant actions taking place over a period of time."

⁶ The NEPA cumulative effects analysis is not limited to activities and includes Federal and non-Federal activities that affect the project area. The cumulative effects analysis should focus on specific categories of resources instead of the environmental effects caused by a particular action, and it requires identification of the factors that cause degradation of those resources, including those caused by actions unrelated to the proposed action (CEQ 1997).

- Ramona Peters, Tribal Historic Preservation Officer, Mashpee Wampanoag Tribe
- Tribal Historic Preservation Officer, Wampanoag Tribe of Aquinnah

7.0 COMPLIANCE WITH FEDERAL ENVIRONMENTAL STATUTES, EXECUTIVE ORDERS AND EXECUTIVE MEMORANDA

7.1 FEDERAL STATUTES

The following is a list of pertinent federal statutes that are related to the Project and documentation of the Project's compliance.

7.1.1 ARCHAEOLOGICAL RESOURCES PROTECTION ACT OF 1979, AS AMENDED, 16 U.S.C. 470 ET SEQ.

The City has submitted a PNF to MHC, BUAR, and all relevant tribes on August 5, 2022 (Appendix A). No response has been received as of this writing which, being in excess of 30 days, assumes that no adverse effects to archaeological resource will result from the Project. The Project does not propose any excavation below current-day existing grade.

7.1.2 PRESERVATION OF HISTORIC AND ARCHEOLOGICAL DATA ACT OF 1974, AS AMENDED, 16 U.S.C. 469 ET SEQ.

The City has submitted a PNF to MHC, BUAR, and all relevant tribes on August 5, 2022 (Appendix A). No response has been received as of this writing which, being in excess of 30 days, assumes that no adverse effects to historic or archaeological data will result from the Project. The existing MOA between MHC and the City addresses any Site work associated with building demolition.

7.1.3 AMERICAN INDIAN RELIGIOUS FREEDOM ACT OF 1978, 42 U.S.C. 1996.

There are no known sacred sites at the Site. Through the submission of a PNF on August 5, 2022, the following tribes were notified of the Project:

- Wampanog Tribe of Gay Head (Aquinnah);
- Stockbridge-Munsee Mohican Tribe; and
- Narraganset Tribe.

No response has been received as of this writing and it is therefore presumed that the Project will not have an impact on sacred sites.

7.1.4 CLEAN AIR ACT, AS AMENDED, 42 U.S.C. 7401 ET SEQ.

The Project has been analyzed for conformity with Section 176(c) of the Clean Air Act. It has been determined that the activities authorized by this permit will not exceed de minimis levels of direct emissions of a criteria pollutant or its precursors and are exempted by 40 CFR 93.153. The public notice of this work was made available to the US EPA as required for compliance pursuant to Sections 176c and 309 of the Clean Air Act.

7.1.5 CLEAN WATER ACT OF 1977 (FEDERAL WATER POLLUTION CONTROL ACT AMENDMENTS OF 1972) 33 U.S.C. 1251 ET SEQ.

The portion of the Project associated with the abandonment of pipes along the Levee will be performed using BMPs for water control and erosion and sediment control. All impacts to the Chicopee River are

temporary, and the Project is anticipated to receive USACE approval under the Section 404 General Permit 14: Temporary Construction, Access, and Dewatering.

7.1.6 FISH AND WILDLIFE COORDINATION ACT, AS AMENDED, 16 U.S.C. 661 ET SEQ.

There are no known endangered or threatened species at the Site; therefore, no formal submission to USFWS has been provided. It is anticipated that USFWS will be afforded opportunity to comment on the Project during the EA comment period and through interagency coordination associated with the USACE Section 408 review process.

7.1.7 LAND AND WATER CONSERVATION FUND ACT OF 1965, AS AMENDED, 16 U.S.C. 4601 4 ET SEQ.

Lincoln Grove Park is the nearest Land and Water Conservation Fund (LWCF)-funded project to the Site and will not be impacted, directly or indirectly, by the Project. Therefore, no further LWCF coordination is required.

7.1.8 NATIONAL HISTORIC PRESERVATION ACT OF 1966, AS AMENDED, 16 U.S.C. 470 ET SEQ.

A PNF was submitted as further described in Appendix A on August 5, 2022. No response has been received to date; therefore, compliance with the National Historic Preservation Act is anticipated.

7.1.9 NATIVE AMERICAN GRAVES PROTECTION AND REPATRIATION ACT (NAGPRA), 25 U.S.C. 3000-3013, 18 U.S.C. 1170

There are no known Native American Graves located at the Site, and the aforementioned tribes are in receipt of a PNF (Appendix A). Regulations implementing the Native American Graves Protection and Repatriation Act (NAGPRA) will be followed if the discovery of human remains and/or funerary items occurs during work associated with the Project.

7.1.10 NATIONAL ENVIRONMENTAL POLICY ACT OF 1969, AS AMENDED, 42 U.S.C 4321 ET SEQ.

Compliance with NEPA will be demonstrated by the submission of this EA and upon the FONSI being signed by the USACE District Engineer.

7.1.11 RIVERS AND HARBORS ACT OF 1899, AS AMENDED, 33 U.S.C. 401 ET SEQ.

The Project will result in alterations to the Levee, which is under control of the USACE and protected under Section 14 of the Rivers and Harbors Act of 1899. Upon acceptance of this EA and the FONSI, the Project will comply with NEPA and the Section 408 approval process pursuant to Section 14 of the Rivers and Harbors Act of 1899 can be completed.

7.1.12 WATERSHED PROTECTION AND FLOOD PREVENTION ACT AS AMENDED, 16 U.S.C 1001 ET SEQ.

All work associated with the filling and grading portion of the Project will occur outside of the floodplain and Regulatory Floodway, and any in-water work is temporary and will not result in the placement of fill or structures. Therefore, the Project will not alter the floodplain at the Site.

7.2 EXECUTIVE ORDERS

7.2.1 EXECUTIVE ORDER 11593, PROTECTION AND ENHANCEMENT OF THE CULTURAL ENVIRONMENT, 13 MAY 1971

It is anticipated that no response being received by MHC, BUAR, or the relevant tribes within 30 days of submission of a PNF signifies compliance (Appendix A).

7.2.2 EXECUTIVE ORDER 11988, FLOODPLAIN MANAGEMENT, 24 MAY 1977 AMENDED BY EXECUTIVE ORDER 12148, 20 JULY 1979.

All work associated with the filling and grading portion of the Project will occur outside of the floodplain and Regulatory Floodway, and any in-water work is temporary and will not result in the placement of fill or structures. Therefore, the Project will not alter the floodplain at the Site.

7.2.3 EXECUTIVE ORDER 11990, PROTECTION OF WETLANDS, 24 MAY 1977.

The portion of the Project associated with the abandonment of pipes along the Levee will be performed using BMPs for water control and erosion and sediment control. All impacts to the Chicopee River are temporary, and the Project is anticipated to receive USACE approval under the Section 404 General Permit 14: Temporary Construction, Access, and Dewatering.

7.2.4 EXECUTIVE ORDER 12898, ENVIRONMENTAL JUSTICE, 11 FEBRUARY 1994.

The Site is located within and adjacent to EJ communities. However, the act of placing fill at the Site and abandoning structures along the Levee will not result in any impacts to the surrounding populations. Although short-term noise and traffic impacts are possible, these are not disproportionate to the EJ populations and will be mitigated as discussed in this EA.

7.2.5 EXECUTIVE ORDER 13007, ACCOMMODATION OF SACRED SITES, 24 MAY 1996

Coordination with relevant tribes has been performed (Appendix A) and no response has been received to date. There are no known sacred sites located at or near the Site.

7.2.6 EXECUTIVE ORDER 13045, PROTECTION OF CHILDREN FROM ENVIRONMENTAL HEALTH RISKS AND SAFETY RISKS. 21 APRIL, 1997.

Remediation efforts have been conducted at the Site, and any imported materials will be below the reportable levels set forth by the MCP. Security fencing will also be maintained at the Site until the remediation activities, which are not a part of the Project proposed under this EA, are completed. Therefore, the Project is not anticipated to present any environmental health or safety risks to children.

7.2.7 EXECUTIVE ORDER 13061, AND AMENDMENTS – FEDERAL SUPPORT OF COMMUNITY EFFORTS ALONG AMERICAN HERITAGE RIVERS

The Project will not adversely affect the Connecticut River action plan established under the Executive Order.

7.2.8 EXECUTIVE ORDER 13175, CONSULTATION AND COORDINATION WITH INDIAN TRIBAL GOVERNMENTS, 6 NOVEMBER 2000.

Consultation has been performed for the aforementioned tribes (Appendix A) on August 5, 2022. No response has been received to date.

7.3 EXECUTIVE MEMORANDA

7.3.1 WHITE HOUSE MEMORANDUM, GOVERNMENT-TO-GOVERNMENT RELATIONS WITH INDIAN TRIBES, 29 APRIL 1994

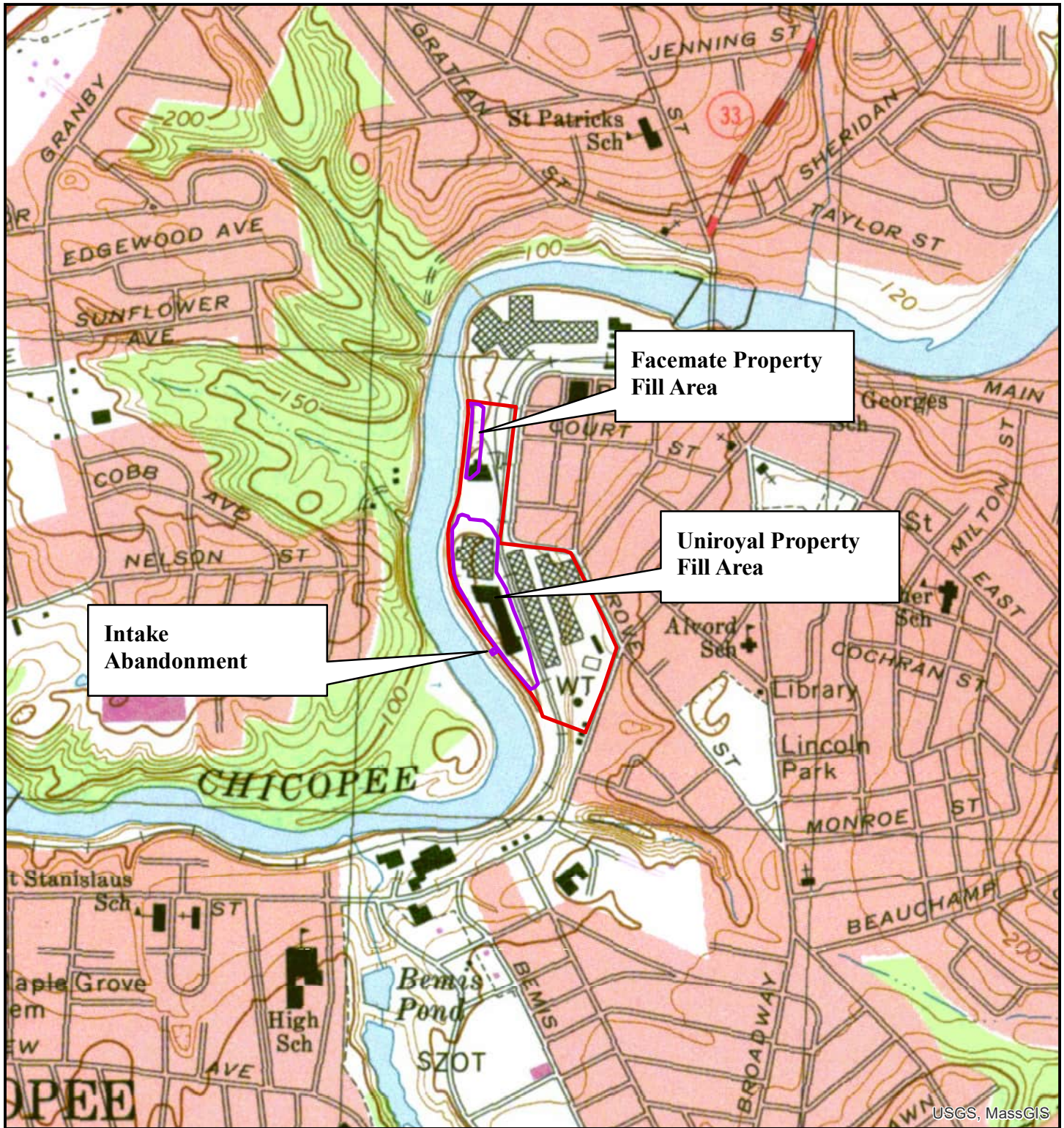
Consultation has been performed for the aforementioned tribes (Appendix A) on August 5, 2022. No response has been received to date.

8.0 FINDINGS AND CONCLUSIONS

The Project, as presented through the Proposed Action, will not have any permanent or long-term impacts to the environment. Although temporary construction-period impacts to factors such as noise and traffic are anticipated, they are relatively minor and will be mitigated as discussed in this EA. Any in-water work is anticipated to receive coverage under the USACE Massachusetts General Permit, and no permanent impacts to the floodplain or regulatory floodway will occur. Coordination related to historic and cultural resources has been performed and it is anticipated that the Proposed Action will not result in impacts to such resources.

This EA supports the attached draft FONSI and demonstrates compliance with NEPA by avoiding and mitigating impacts to the environment; therefore, it is not anticipated that an Environmental Impact Statement will be required.

FIGURES

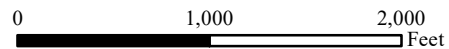
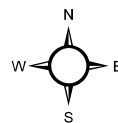


USGS, MassGIS



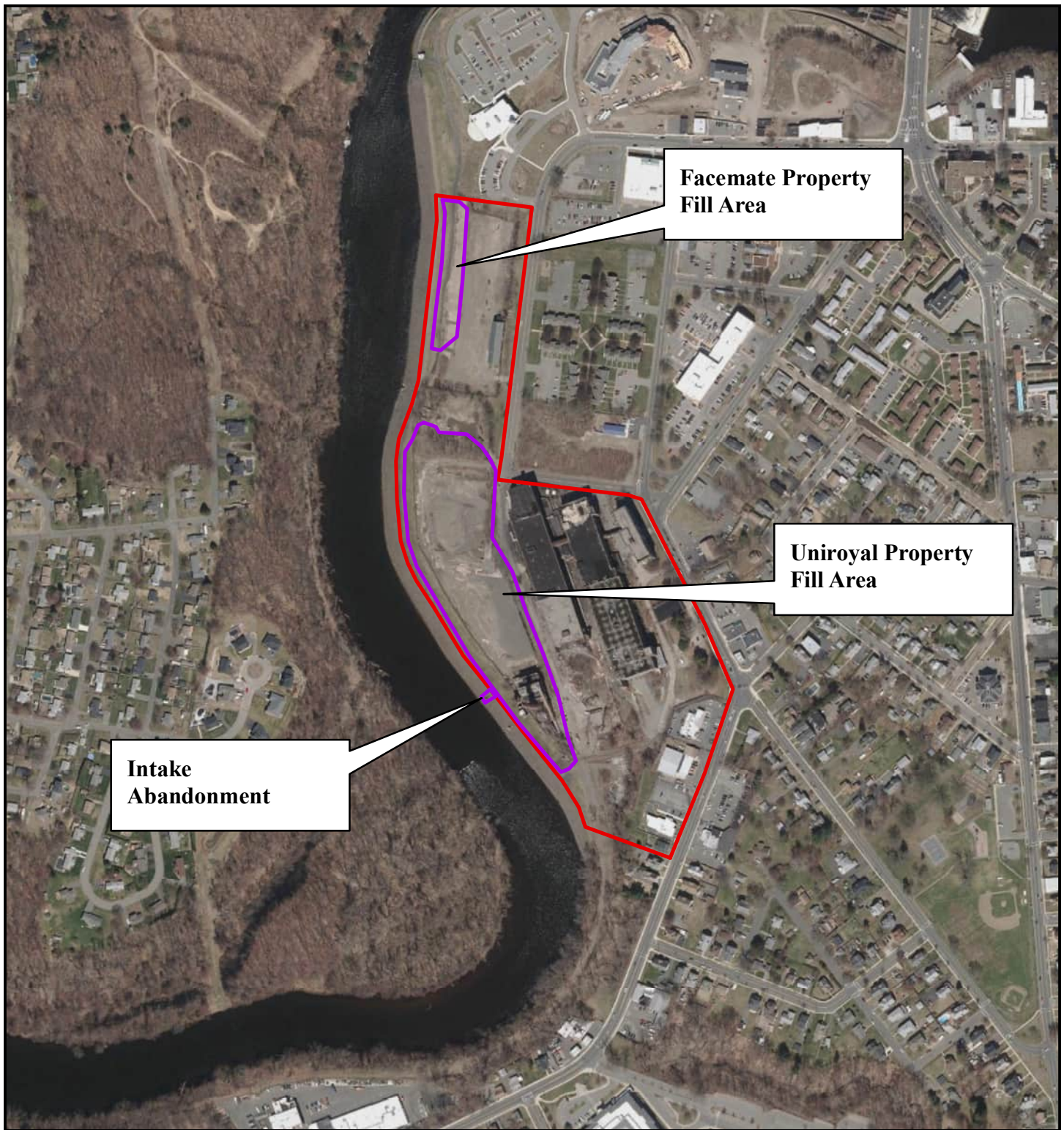
Legend

- Site Locus
- Work Area



1 inch = 1,000 feet

Figure 1
Site Locus - Topographic
Former Uniroyal & Facemate Properties
Chicopee, MA



**Intake
Abandonment**

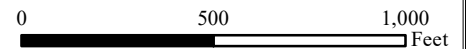
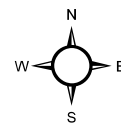
**Facemate Property
Fill Area**

**Uniroyal Property
Fill Area**



Legend

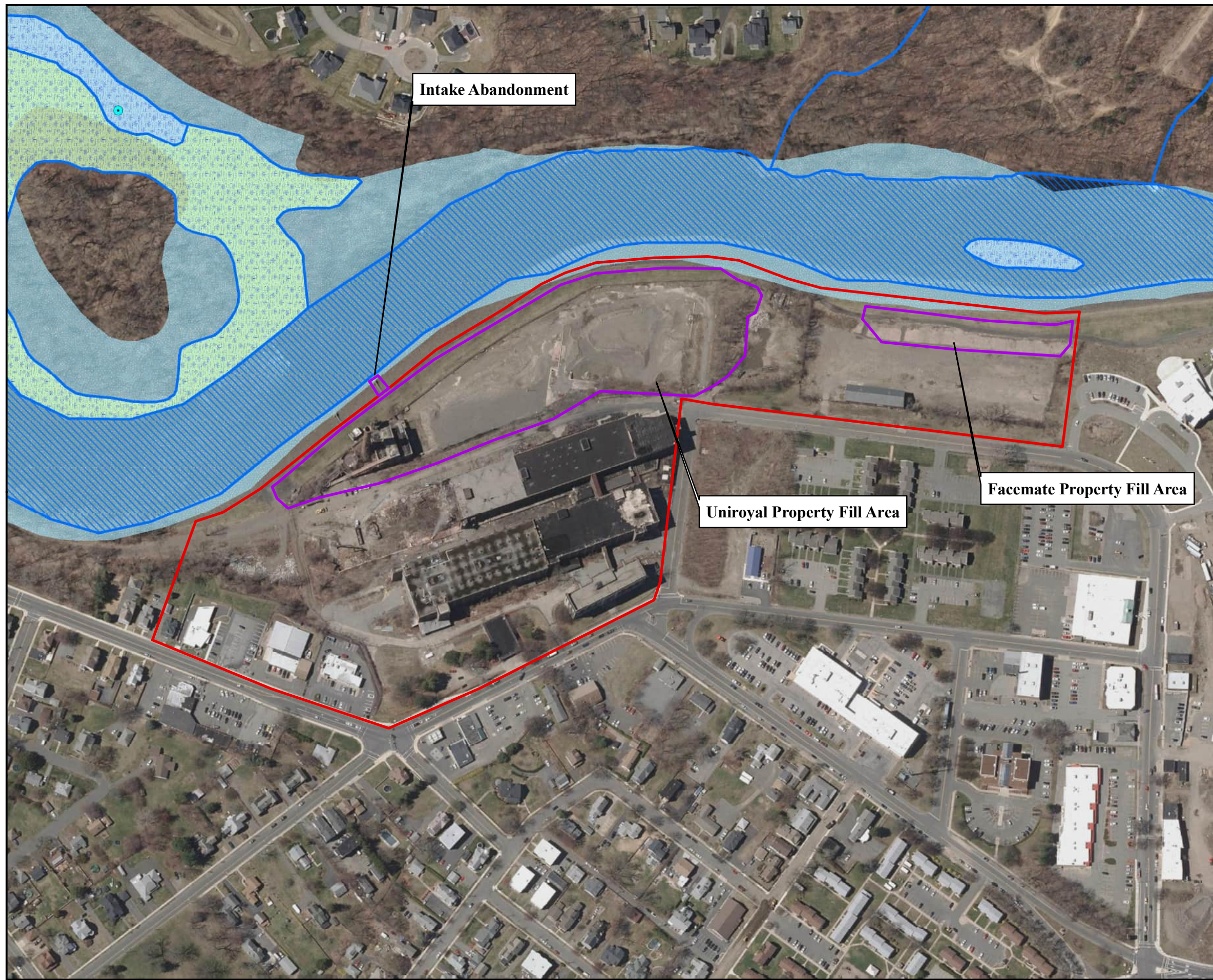
- Site Locus
- Work Area



1 inch = 500 feet

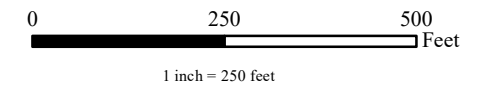
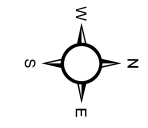
Figure 2
Site Locus - Aerial
Former Uniroyal & Facemate Properties
Chicopee, MA

Figure 3
Environmental Resources Map
Former Uniroyal & Facemate Properties
Chicopee, MA



Wetland Resources Legend

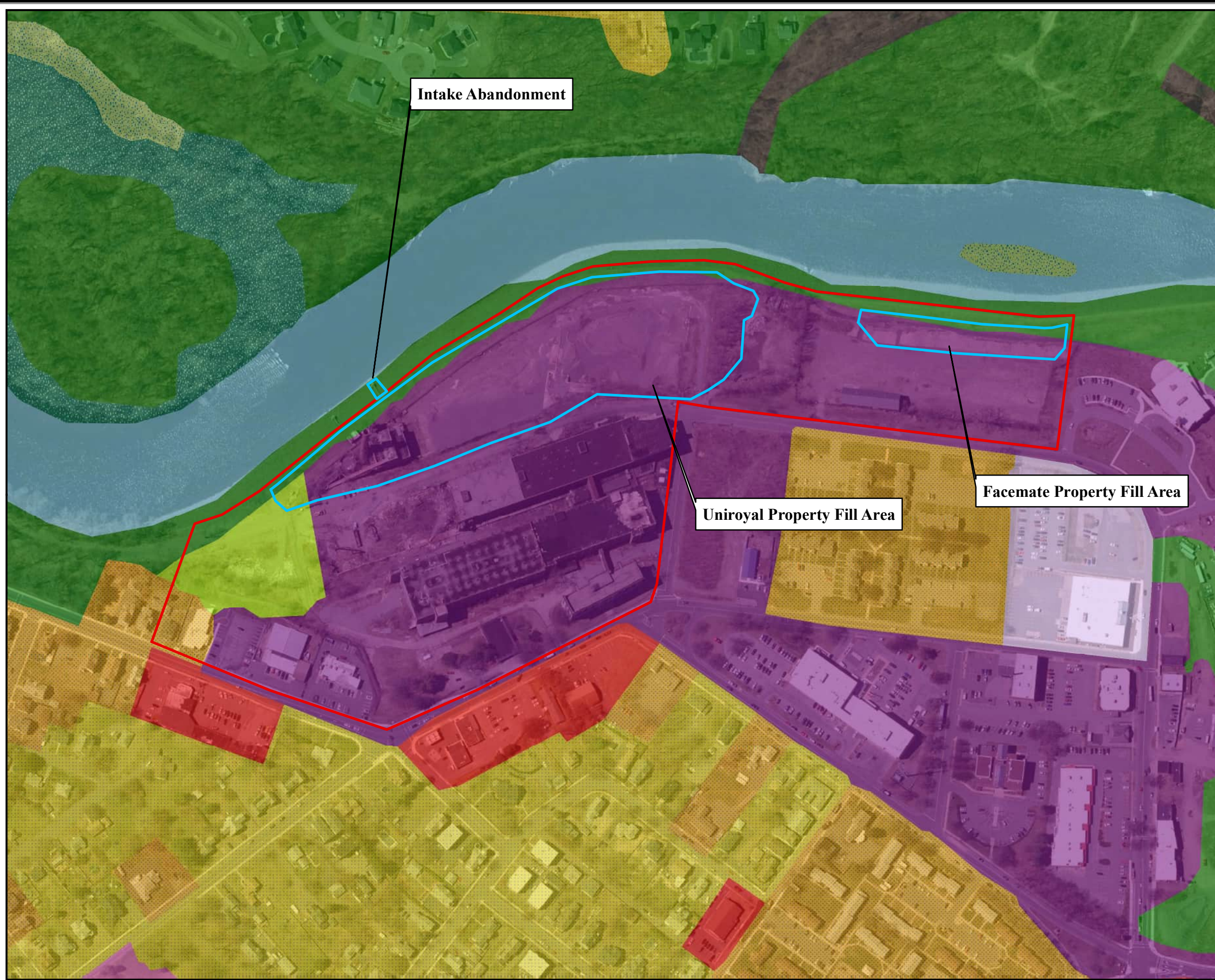
- Site Locus
- Work Area
- MassDEP Hydrologic Feature
- Marsh/Bog
- Wooded marsh
- Open Water
- NFHL 100 Year Flood Zone
- Area of Critical Environmental Concern (ACEC)
- DFW Coldwater Fisheries
- Outstanding Resource Water
- Zone A
- Zone B
- Zone C
- MassDEP IWPA
- MassDEP Zone I
- MassDEP Zone II



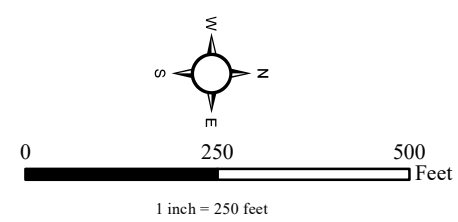
Data Source: MassGIS USGS Color Ortho Imagery (2014), MassDEP Wetlands (1:12000) (2009), NHESP Potential Vernal Pools (2000), NHESP Certified Vernal Pools, NHESP Priority Habitats of Rare Species (2008), NHESP Estimated Habitats of Rare Species (2008), Areas of Critical Environmental Concern (2009), FEMA National Flood Hazard Layer (2014).



Figure 4
Zoning Map
Former Uniroyal & Facemate Properties
Chicopee, MA



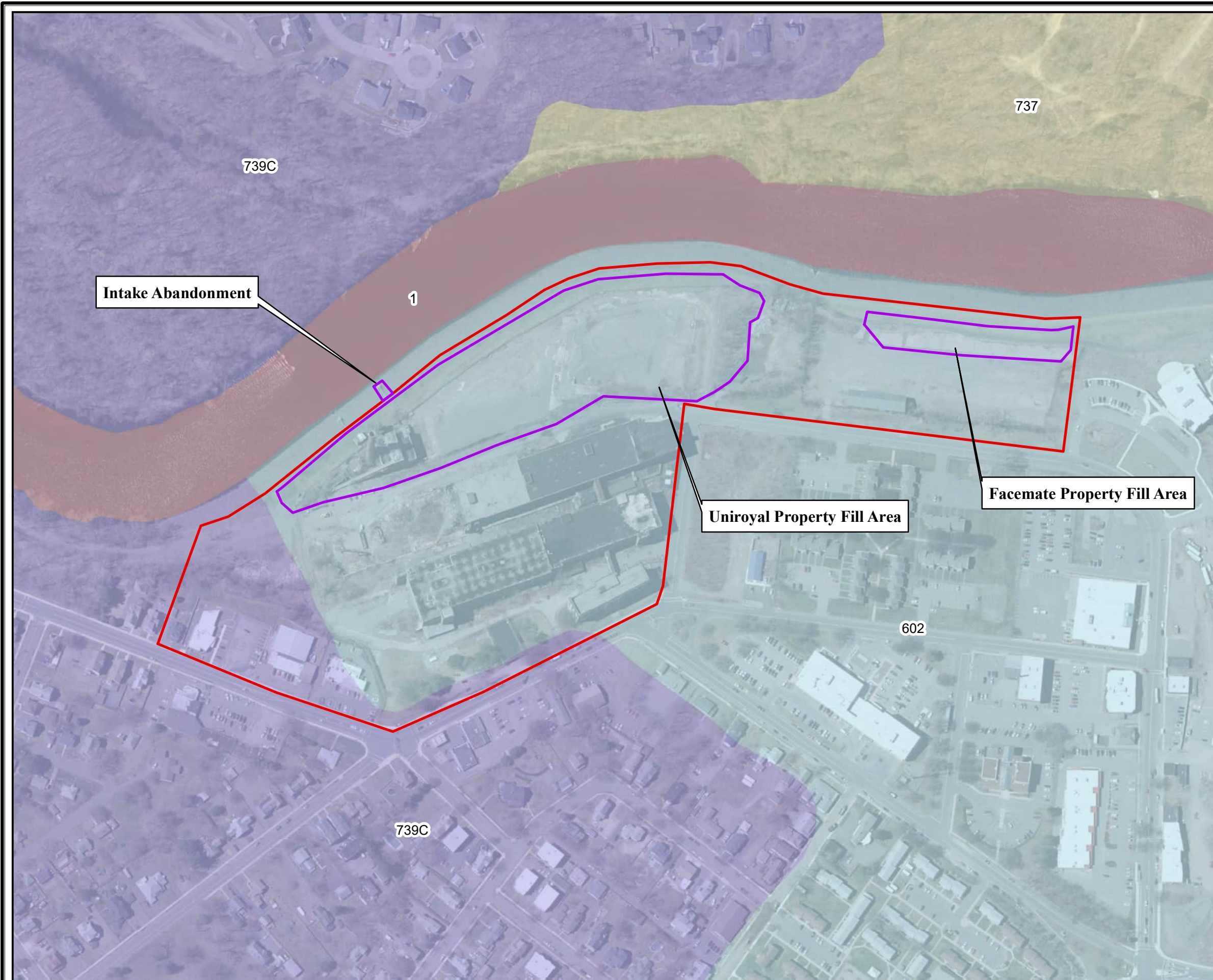
- Land Use Legend**
- Site Locus
 - Work Area
 - Forest
 - Open Land
 - Water
 - Forested Wetland
 - Non-Forested Wetland
 - Participation Recreation
 - Multi-Family Residential
 - High Density Residential
 - Urban Public/Institutional
 - Commercial
 - Industrial
 - Powerline/Utility



Data Source: MassGIS USGS Color Ortho Imagery (2014), MassDEP Wetlands (1:12000) (2009), NHESP Potential Vernal Pools (2000), NHESP Certified Vernal Pools, NHESP Priority Habitats of Rare Species (2008), NHESP Estimated Habitats of Rare Species (2008), Areas of Critical Environmental Concern (2009), FEMA National Flood Hazard Layer (2014).

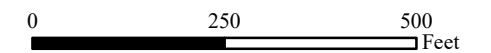
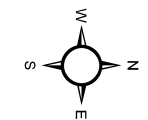


Figure 5
Soils Map
Former Uniroyal & Facemate Properties
Chicopee, MA



Soils Legend

- Site Locus
- Work Area
- 1 - Water
- 602 - Urban Land
- 737 - Terrace Escarpments
- 739C - Urban land-Hinckley-Windsor Association, 0 to 15 percent slopes



1 inch = 250 feet

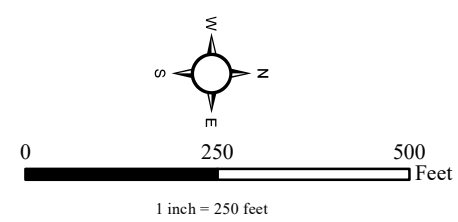
Data Source: MassGIS USGS Color Ortho Imagery (2014), MassDEP Wetlands (1:12000) (2009), NHESP Potential Vernal Pools (2000), NHESP Certified Vernal Pools, NHESP Priority Habitats of Rare Species (2008), NHESP Estimated Habitats of Rare Species (2008), Areas of Critical Environmental Concern (2009), FEMA National Flood Hazard Layer (2014).



Figure 6
Historic Resources Map
Former Uniroyal & Facemate Properties
Chicopee, MA



- Wetland Resources Legend**
- Site Locus
 - Work Area
 - Local Historic District
 - Inventoried Area
 - Inventoried Property
 - Local Historic District
 - National Register of Historic Places and Local Historic District



Data Source: MassGIS USGS Color Ortho Imagery (2014), MassDEP Wetlands (1:12000) (2009), NHESP Potential Vernal Pools (2000), NHESP Certified Vernal Pools, NHESP Priority Habitats of Rare Species (2008), NHESP Estimated Habitats of Rare Species (2008), Areas of Critical Environmental Concern (2009), FEMA National Flood Hazard Layer (2014).



National Flood Hazard Layer FIRMMette



72°35'34"W 42°9'30"N



0 250 500 1,000 1,500 2,000 Feet 1:6,000

Basemap: USGS National Map: Orthoimagery: Data refreshed October, 2020

72°34'57"W 42°9'4"N

Legend

SEE FIS REPORT FOR DETAILED LEGEND AND INDEX MAP FOR FIRM PANEL LAYOUT

SPECIAL FLOOD HAZARD AREAS		Without Base Flood Elevation (BFE) Zone A, V, A99 With BFE or Depth Zone AE, AO, AH, VE, AR Regulatory Floodway
OTHER AREAS OF FLOOD HAZARD		0.2% Annual Chance Flood Hazard, Areas of 1% annual chance flood with average depth less than one foot or with drainage areas of less than one square mile Zone X Future Conditions 1% Annual Chance Flood Hazard Zone X Area with Reduced Flood Risk due to Levee. See Notes. Zone X Area with Flood Risk due to Levee Zone D
OTHER AREAS		NO SCREEN Area of Minimal Flood Hazard Zone X Effective LOMRs Area of Undetermined Flood Hazard Zone D
GENERAL STRUCTURES		Channel, Culvert, or Storm Sewer Levee, Dike, or Floodwall
OTHER FEATURES		20.2 Cross Sections with 1% Annual Chance 17.5 Water Surface Elevation Coastal Transect Base Flood Elevation Line (BFE) Limit of Study Jurisdiction Boundary Coastal Transect Baseline Profile Baseline Hydrographic Feature
MAP PANELS		Digital Data Available No Digital Data Available Unmapped

The pin displayed on the map is an approximate point selected by the user and does not represent an authoritative property location.

This map complies with FEMA's standards for the use of digital flood maps if it is not void as described below. The basemap shown complies with FEMA's basemap accuracy standards

The flood hazard information is derived directly from the authoritative NFHL web services provided by FEMA. This map was exported on 7/11/2022 at 11:34 AM and does not reflect changes or amendments subsequent to this date and time. The NFHL and effective information may change or become superseded by new data over time.

This map image is void if the one or more of the following map elements do not appear: basemap imagery, flood zone labels, legend, scale bar, map creation date, community identifiers, FIRM panel number, and FIRM effective date. Map images for unmapped and unmodernized areas cannot be used for regulatory purposes.

Figure 8

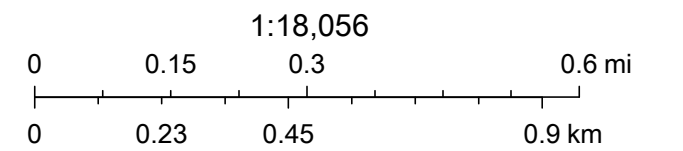
Chicopee 2020 Environmental Justice Populations



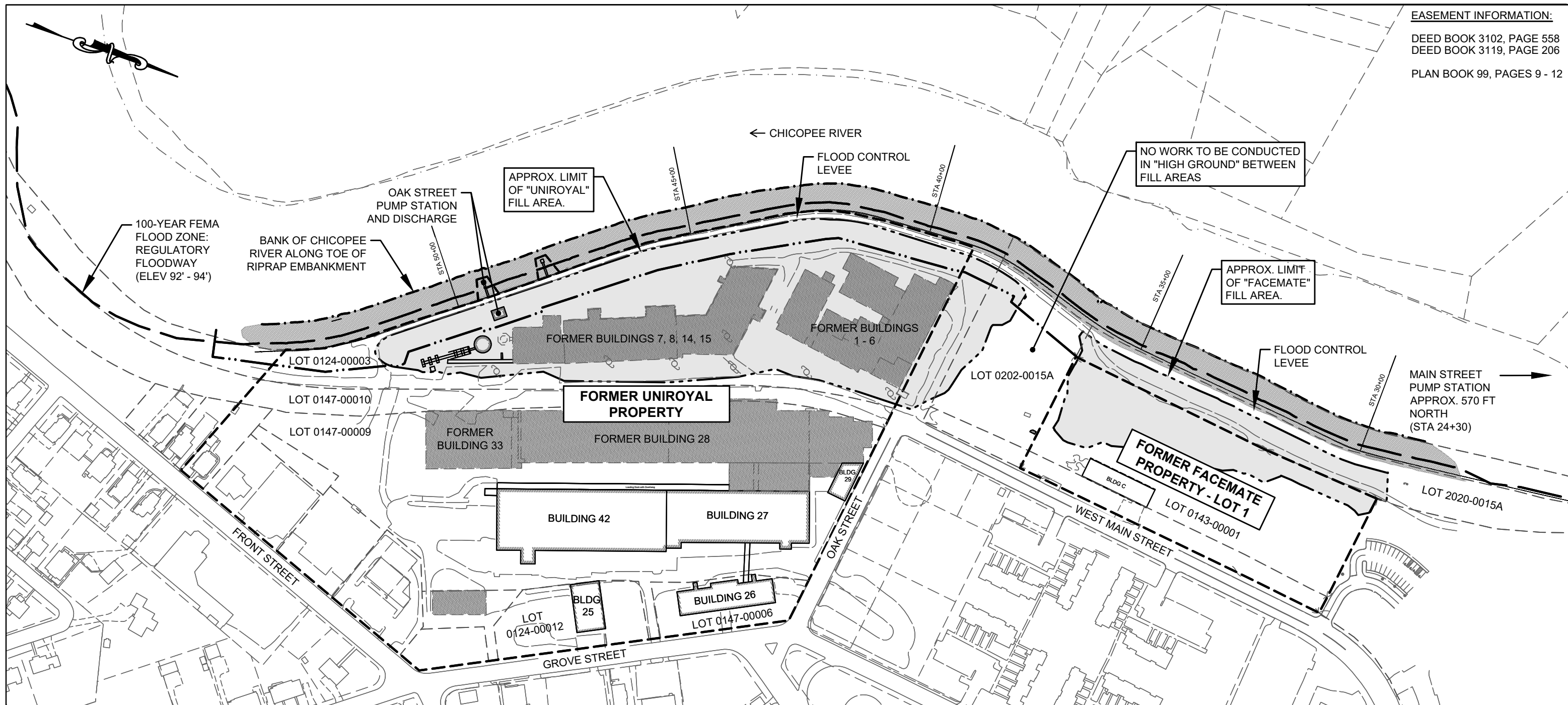
7/11/2022, 11:07:36 AM

EJ 2020 with criteria explanation

- Minority: the block group minority population is $\geq 40\%$, or the block group minority population is $\geq 25\%$ and the median household income of the municipality the block group is in is $< 150\%$ of the Massachusetts median household income
- Income: at least 25% of households have a median household income 65% or less than the state median household income
- Minority and income



APPENDIX A – Project Plans



- NOTES:**
- COORDINATES, IN FEET, ARE BASED UPON THE NORTH AMERICAN DATUM OF 1983 (NAD 83). THE VERTICAL DATUM IS REFERENCED TO THE NORTH AMERICAN VERTICAL DATUM OF 1988 (NAVD 88).
 - THE NAVD88 ELEVATIONS ARE APPROXIMATELY 0.708 FT LOWER THAN THE NGVD29 ELEVATIONS USED IN THE ORIGINAL FLOOD CONTROL DESIGN PLANS, BASED ON AN ANALYSIS PERFORMED BY CIVILVIEW, INC.
 - EXISTING CONDITIONS INFORMATION OBTAINED VIA:
 - AERIAL AND ON-THE-GROUND SURVEY COMPLETED BY CIVIL DESIGN CONSULTANTS, INC. IN DECEMBER OF 2018 AND 2019.
 - PLAN ENTITLED "CHICOPEE RIVER FLOOD CONTROL CHICOPEE FALLS" BY HERITAGE SURVEYS IN MARCH OF 2014
 - PLANIMETRIC AND TOPOGRAPH DATASET PROVIDED BY INFOTECH, INC. IN JANUARY OF 2010.
 - PLAN OF LAND COMPLETED BY DURKEE, WHITE, TOWNE, AND CHAPDELAINE IN 2012.
 - FIELD OBSERVATIONS AND ON-THE-GROUND SURVEY BY BETA GROUP, INC FROM 2016 TO 2020.



LEGEND

	EXISTING SITE BUILDING
	BUILDING DEMOLISHED AS OF AUGUST 2022
	PROPERTY LINE
	APPROX. LIMIT OF CHICOPEE RIVER
	APPROX. LIMIT OF USACE PARCEL (TRACT R8)
	PROPOSED FILL AREA
	100-YEAR FEMA FLOOD ZONE



Former Uniroyal & Facemate Properties
 USACE Permit Review Only
 154 Grove Street & 75 West Main Street
 Chicopee, MA

Figure No. 3
Overall Site Plan
 Issue Date: 9-12-2022

DESCRIPTION OF DRAINAGE SYSTEMS:

SYSTEM A: COLLECTS RUNOFF FROM UPPER PORTIONS OF SITE AND BUILDING 42 FOR DISCHARGE TO SOUTH OUTFALL. NO ALTERATIONS PROPOSED.

SYSTEM B: COLLECTS RUNOFF FROM BUILDINGS 26 AND 27 FOR DISCHARGE TO SYSTEM C. NO ALTERATIONS PROPOSED.

SYSTEM C: INTERCEPTOR DRAIN AND CATCH BASIN SYSTEM FOR COLLECTION OF RUNOFF BEHIND DIKE. CURRENTLY CONVEYED TO OAK STREET PUMP STATION FOR DISCHARGE INTO CHICOPEE RIVER. SYSTEM TO BE ALTERED. REFER TO FIGURE 12.

AREA BEHIND LEVEE TO BE BACKFILLED. REFER TO FIGURES 5 AND 6 FOR PROPOSED GRADING & DRAINAGE PLAN.

OAK STREET PUMP STATION, DISCHARGE STRUCTURE, AND INTAKE STRUCTURE TO BE DECOMMISSIONED. SEE FIGURE 12

PROP TEMP COFFERDAM. REFER TO FIGURE 12

LEVEE STA. 45+00

BANK OF CHICOPEE RIVER ALONG TOE OF RIPRAP EMBANKMENT

EXISTING UTILITY POLE WITH OVERHEAD ELECTRIC LINES TO BE REMOVED FROM FILL AREA (TYP.)

LEVEE STA. 40+00

100-YEAR FEMA FLOOD ZONE: REGULATORY FLOODWAY (ELEV 92' - 94')

EXISTING DRAINAGE STRUCTURES AND INTERCEPTOR/TOE DRAINS. SEE "SYSTEM C" DESCRIPTION.

EXISTING "SOUTH OUTFALL" TO REMAIN

LEVEE STA. 50+00

LINE ABANDONED

EXISTING DRAINAGE STRUCTURES AND PIPES. SEE "SYSTEM A" DESCRIPTION.

EXISTING DRAINAGE STRUCTURES AND PIPES. SEE "SYSTEM B" DESCRIPTION.






BLDG. 29

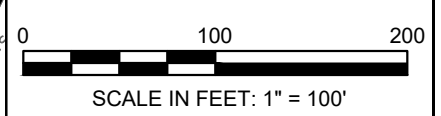
BUILDING 29 TO BE DEMOLISHED UNDER SEPARATE CONTRACT

PROPERTY OWNERSHIP
 CITY OF CHICOPEE
 BOOK 3119 PAGE 206
 BOOK 13344 PAGE 589
 BOOK 17783 PAGE 139
 BOOK 18258 PAGE 319

PLAN BOOK 99 PAGES 9-12
 PLAN BOOK 200 PAGES 54-61
 PLAN BOOK 369 PAGES 87-90

LEGEND

-  EXISTING SITE BUILDING
-  PROPERTY LINE
-  APPROX. LIMIT OF CHICOPEE RIVER
-  APPROX. LIMIT OF USACE PARCEL (TRACT R8)
-  100-YEAR FEMA FLOOD ZONE



CHICOPEE RIVER

BUILDING 42

BUILDING 27

Former Uniroyal & Facemate Properties

USACE Permit Review Only
 154 Grove Street & 75 West Main Street
 Chicopee, MA

Issue Date: 9-12-2022

Figure No. 4

**Existing Drainage Plan
 Uniroyal Property**

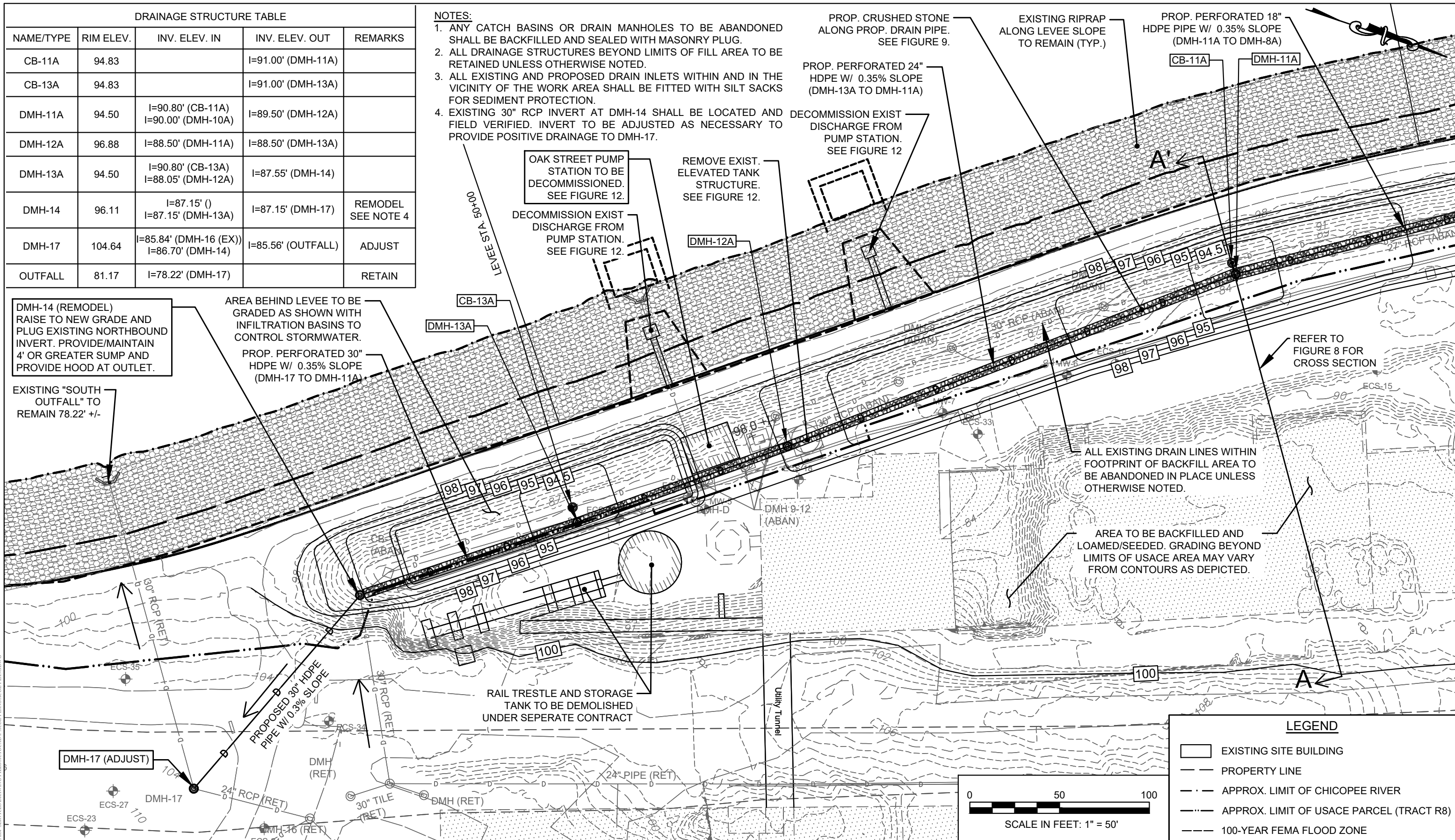


D:\STARS\3100 - CHICOPEE - UNIROYAL & FACEMATE\DRAWING FILES\154 GROVE ST. & 75 WEST MAIN ST. R8\DWG

DRAINAGE STRUCTURE TABLE				
NAME/TYPE	RIM ELEV.	INV. ELEV. IN	INV. ELEV. OUT	REMARKS
CB-11A	94.83		I=91.00' (DMH-11A)	
CB-13A	94.83		I=91.00' (DMH-13A)	
DMH-11A	94.50	I=90.80' (CB-11A) I=90.00' (DMH-10A)	I=89.50' (DMH-12A)	
DMH-12A	96.88	I=88.50' (DMH-11A)	I=88.50' (DMH-13A)	
DMH-13A	94.50	I=90.80' (CB-13A) I=88.05' (DMH-12A)	I=87.55' (DMH-14)	
DMH-14	96.11	I=87.15' () I=87.15' (DMH-13A)	I=87.15' (DMH-17)	REMODEL SEE NOTE 4
DMH-17	104.64	I=85.84' (DMH-16 (EX)) I=86.70' (DMH-14)	I=85.56' (OUTFALL)	ADJUST
OUTFALL	81.17	I=78.22' (DMH-17)		RETAIN

NOTES:

1. ANY CATCH BASINS OR DRAIN MANHOLES TO BE ABANDONED SHALL BE BACKFILLED AND SEALED WITH MASONRY PLUG.
2. ALL DRAINAGE STRUCTURES BEYOND LIMITS OF FILL AREA TO BE RETAINED UNLESS OTHERWISE NOTED.
3. ALL EXISTING AND PROPOSED DRAIN INLETS WITHIN AND IN THE VICINITY OF THE WORK AREA SHALL BE FITTED WITH SILT SACKS FOR SEDIMENT PROTECTION.
4. EXISTING 30" RCP INVERT AT DMH-14 SHALL BE LOCATED AND FIELD VERIFIED. INVERT TO BE ADJUSTED AS NECESSARY TO PROVIDE POSITIVE DRAINAGE TO DMH-17.



0:\STARS\3100 - CHICOPEE - UNIROYAL ESP SERVICES\DRAWING FILES\FIG 5\FIG 5.DWG - ACCE PLANS - RCP PLAN.DWG



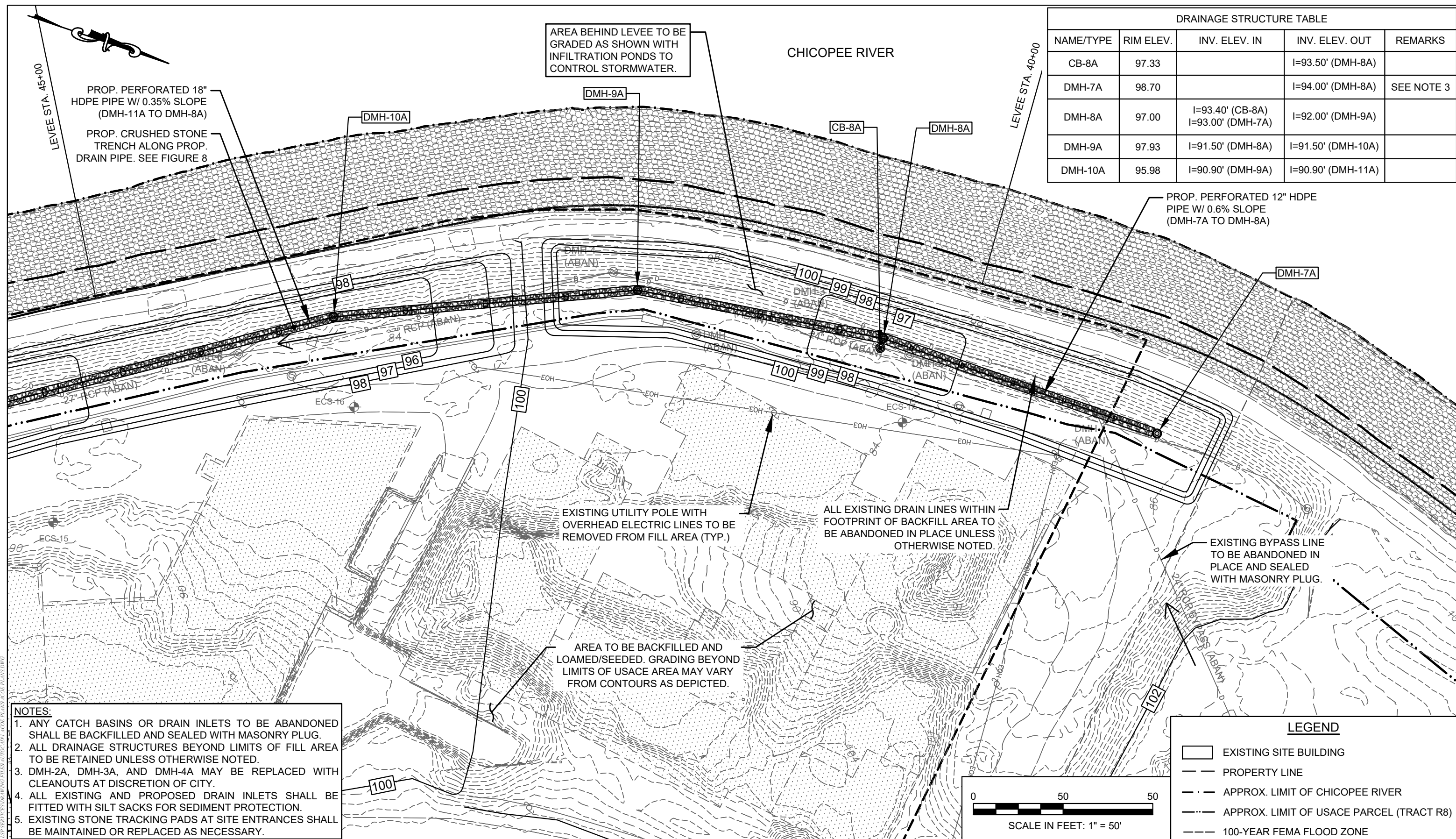
Former Uniroyal & Facemate Properties

USACE Permit Review Only
154 Grove Street & 75 West Main Street
Chicopee, MA

Issue Date: 9-12-2022

Figure No. 5

**Enlarged Grading & Drainage Plan I
Uniroyal Property**

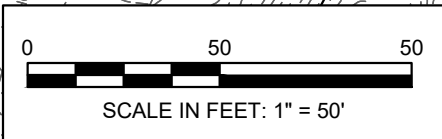


DRAINAGE STRUCTURE TABLE				
NAME/TYPE	RIM ELEV.	INV. ELEV. IN	INV. ELEV. OUT	REMARKS
CB-8A	97.33		I=93.50' (DMH-8A)	
DMH-7A	98.70		I=94.00' (DMH-8A)	SEE NOTE 3
DMH-8A	97.00	I=93.40' (CB-8A) I=93.00' (DMH-7A)	I=92.00' (DMH-9A)	
DMH-9A	97.93	I=91.50' (DMH-8A)	I=91.50' (DMH-10A)	
DMH-10A	95.98	I=90.90' (DMH-9A)	I=90.90' (DMH-11A)	

- NOTES:**
1. ANY CATCH BASINS OR DRAIN INLETS TO BE ABANDONED SHALL BE BACKFILLED AND SEALED WITH MASONRY PLUG.
 2. ALL DRAINAGE STRUCTURES BEYOND LIMITS OF FILL AREA TO BE RETAINED UNLESS OTHERWISE NOTED.
 3. DMH-2A, DMH-3A, AND DMH-4A MAY BE REPLACED WITH CLEANOUTS AT DISCRETION OF CITY.
 4. ALL EXISTING AND PROPOSED DRAIN INLETS SHALL BE FITTED WITH SILT SACKS FOR SEDIMENT PROTECTION.
 5. EXISTING STONE TRACKING PADS AT SITE ENTRANCES SHALL BE MAINTAINED OR REPLACED AS NECESSARY.

LEGEND

- EXISTING SITE BUILDING
- PROPERTY LINE
- APPROX. LIMIT OF CHICOPEE RIVER
- APPROX. LIMIT OF USACE PARCEL (TRACT R8)
- 100-YEAR FEMA FLOOD ZONE



Former Uniroyal & Facemate Properties
 USACE Permit Review Only
 154 Grove Street & 75 West Main Street
 Chicopee, MA

Figure No. 6
Enlarged Grading & Drainage Plan II
Uniroyal Property

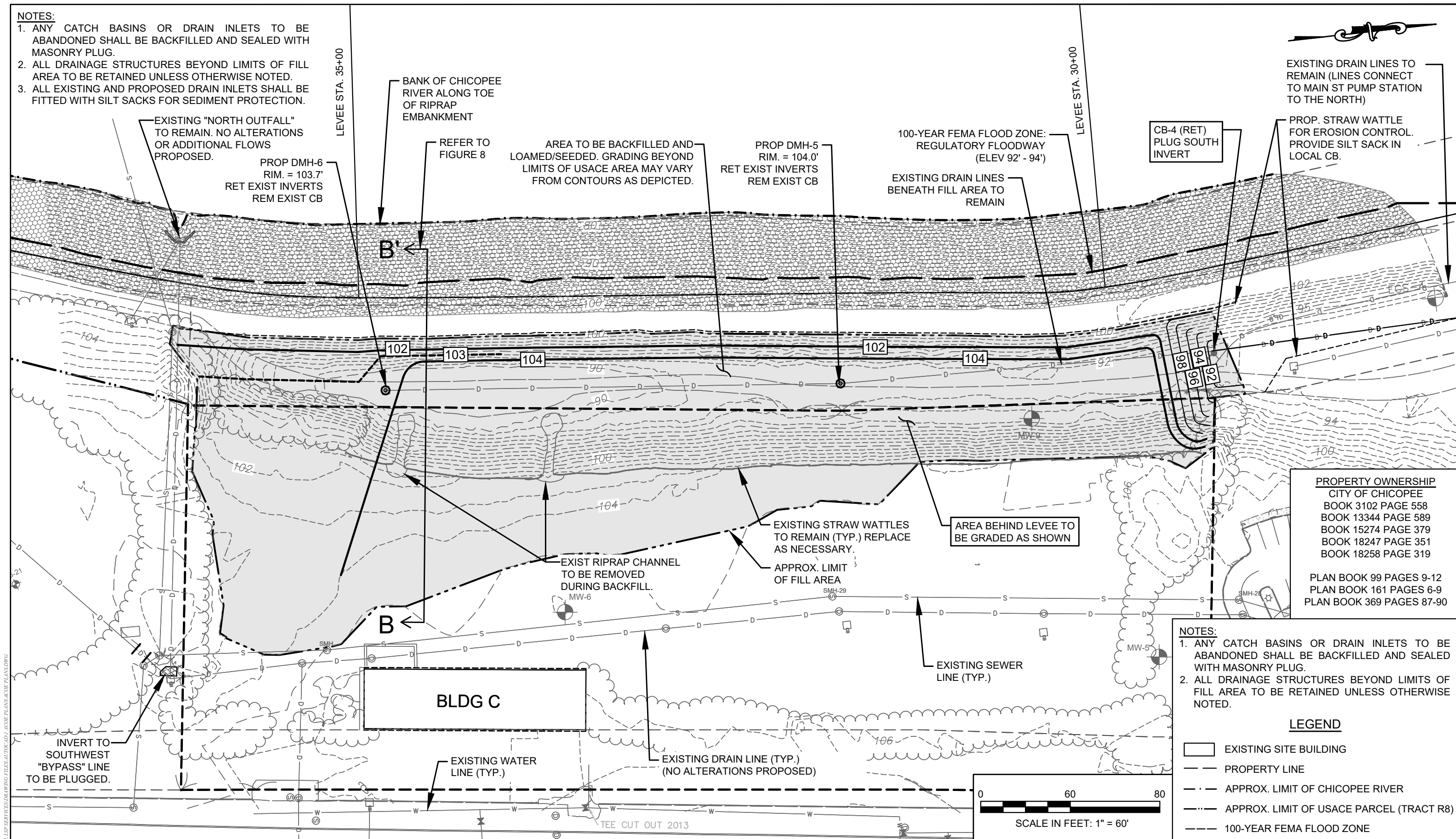


Issue Date: 9-12-2022

0:\STARS\3100 - CHICOPEE - UNIROYAL - USACE PERMIT REVIEW FILES\FIGURE 6 - ENLARGED GRADING & DRAINAGE PLAN II.DWG

NOTES:

1. ANY CATCH BASINS OR DRAIN INLETS TO BE ABANDONED SHALL BE BACKFILLED AND SEALED WITH MASONRY PLUG.
2. ALL DRAINAGE STRUCTURES BEYOND LIMITS OF FILL AREA TO BE RETAINED UNLESS OTHERWISE NOTED.
3. ALL EXISTING AND PROPOSED DRAIN INLETS SHALL BE FITTED WITH SILT SACKS FOR SEDIMENT PROTECTION.



PROPERTY OWNERSHIP
 CITY OF CHICOPEE
 BOOK 3102 PAGE 558
 BOOK 13344 PAGE 589
 BOOK 15274 PAGE 379
 BOOK 18247 PAGE 351
 BOOK 18258 PAGE 319

PLAN BOOK 99 PAGES 9-12
 PLAN BOOK 161 PAGES 6-9
 PLAN BOOK 369 PAGES 87-90

- NOTES:**
1. ANY CATCH BASINS OR DRAIN INLETS TO BE ABANDONED SHALL BE BACKFILLED AND SEALED WITH MASONRY PLUG.
 2. ALL DRAINAGE STRUCTURES BEYOND LIMITS OF FILL AREA TO BE RETAINED UNLESS OTHERWISE NOTED.

LEGEND

- EXISTING SITE BUILDING
- PROPERTY LINE
- APPROX. LIMIT OF CHICOPEE RIVER
- APPROX. LIMIT OF USACE PARCEL (TRACT R8)
- 100-YEAR FEMA FLOOD ZONE



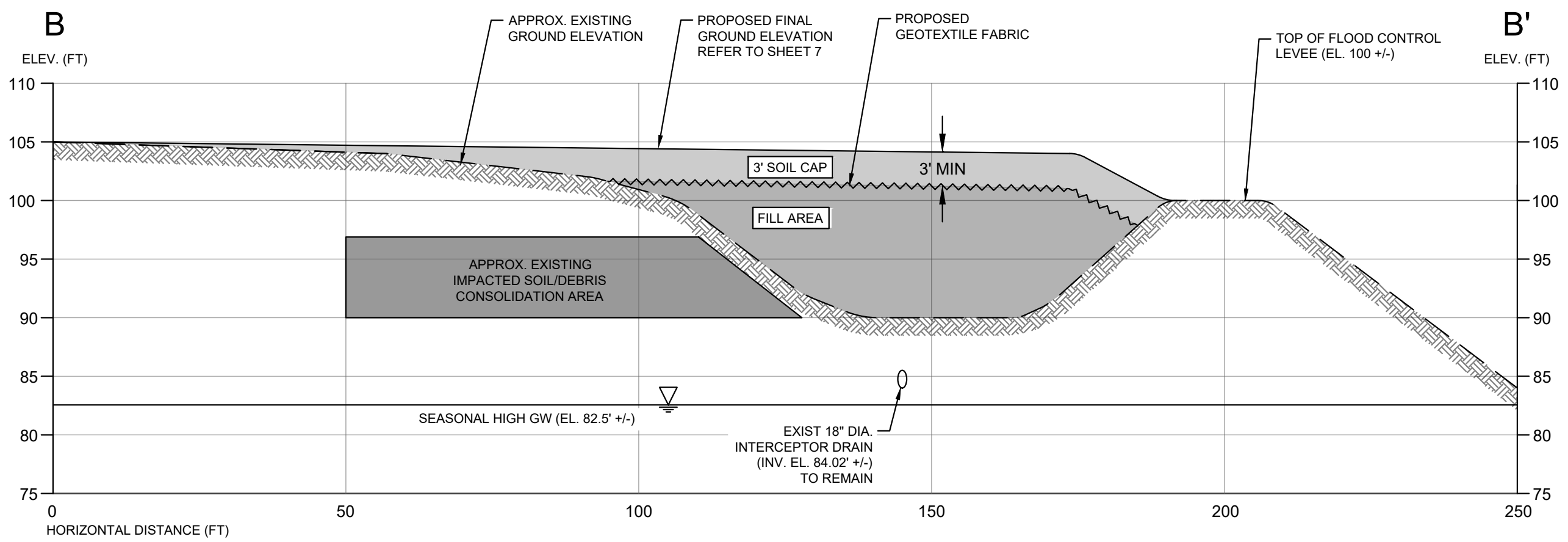
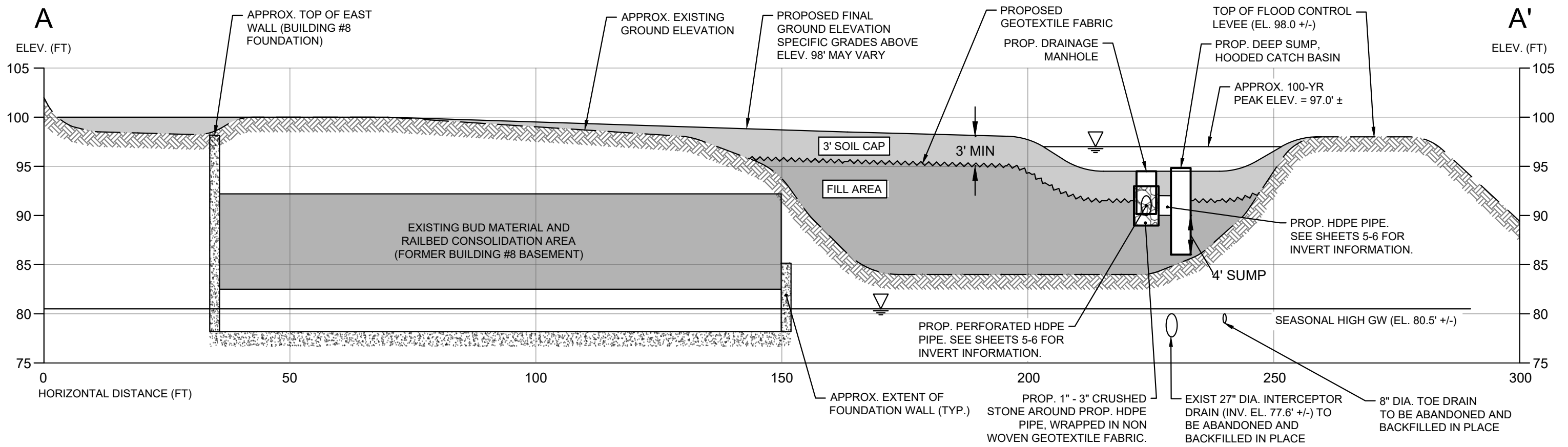
Former Unioryal & Facemate Properties

USACE Permit Review Only
 75 West Main Street
 Chicopee, MA

Issue Date: 9-12-2022

Figure No. 7

**Grading & Drainage Plan
 Facemate Property**



- NOTES:**
- COORDINATES, IN FEET, ARE BASED UPON THE NORTH AMERICAN DATUM OF 1983 (NAD 83). THE VERTICAL DATUM IS REFERENCED TO THE NORTH AMERICAN VERTICAL DATUM OF 1988 (NAVD 88).
 - EXISTING PIPE INFORMATION BASED ON PLAN TITLED "CHICOPEE RIVER FLOOD CONTROL CHICOPEE FALLS" PREPARED BY US ARMY CORPS OF ENGINEERS, DATED DECEMBER 1962. ELEVATIONS TO BE CONFIRMED DURING CONSTRUCTION.
 - REFER TO FIGURES 5 AND 7 FOR LOCATIONS OF CROSS SECTIONS.
 - PROPOSED CRUSHED STONE AND BACKFILL DESIGN SHALL BE IN ACCORDANCE WITH GEOTECHNICAL ENGINEERING REPORT PREPARED FOR THIS PROJECT OR AN EQUIVALENT DESIGN REVIEWED BY A GEOTECHNICAL ENGINEER.
- VERT. SCALE IN FEET: 1" = 10'
 HORR. SCALE IN FEET: 1" = 20'

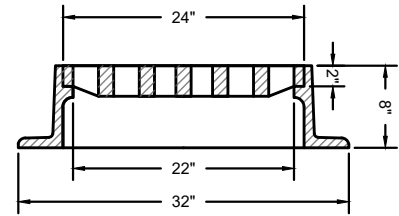


Former Uniroyal & Facemate Properties
 USACE Permit Review Only
 154 Grove Street & 75 West Main Street
 Chicopee, MA

Issue Date: 9-12-2022

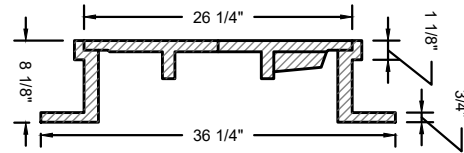
Figure No. 8

Cross Sections



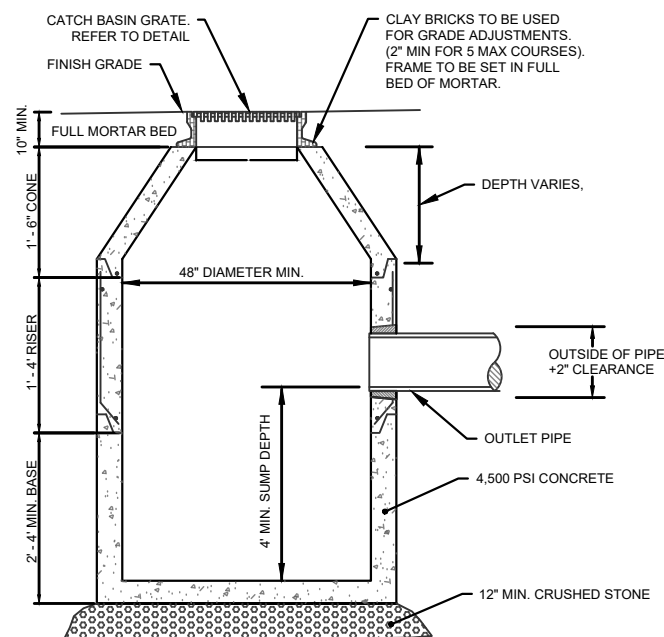
- NOTES:**
- DRAIN STRUCTURES LISTED AS "ADJ" SHALL HAVE THEIR CATCH BASIN FRAME MODIFIED, OR BE PROVIDED WITH NEW FRAME, SUCH THAT THE INLET IS FLUSH WITH THE PROPOSED GUTTER LINE.
 - CATCH BASIN FRAME AND GRATE SHALL BE IN ACCORDANCE WITH CITY OF CHICOPEE DPW STANDARD DETAILS

CATCH BASIN FRAME AND GRATE
NOT TO SCALE



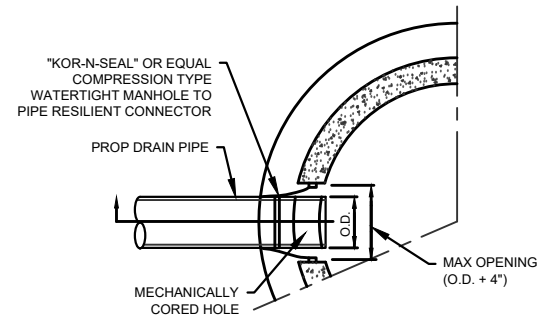
- NOTES:**
- CLAY BRICKS TO BE USED FOR GRADE ADJUSTMENTS. (2" MIN FOR 5 MAX COURSES). FRAME TO BE SET IN FULL BED OF MORTAR.
 - MANHOLE FRAME AND COVER SHALL BE IN ACCORDANCE WITH CITY OF CHICOPEE DPW STANDARD DETAILS

MANHOLE FRAME
NOT TO SCALE

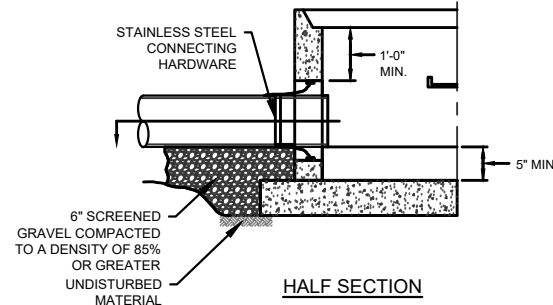


- NOTES:**
- CATCH BASIN FRAME SHALL BE IN ACCORDANCE WITH MASSDOT DRAWING E 201.6 OR APPROVED EQUAL
 - A TEST PIT SHALL BE COMPLETED IN THE VICINITY OF EACH PROPOSED DRAINAGE STRUCTURE TO IDENTIFY ANY POTENTIAL OBSTRUCTIONS.
 - ALL STRUCTURES SHALL CONFORM TO LATEST CITY OF CHICOPEE CONSTRUCTION DETAILS.

DEEP SUMP CATCH BASIN
NOT TO SCALE

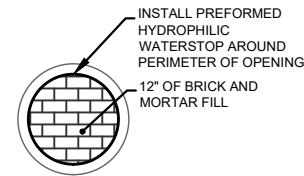


SECTIONAL PLAN



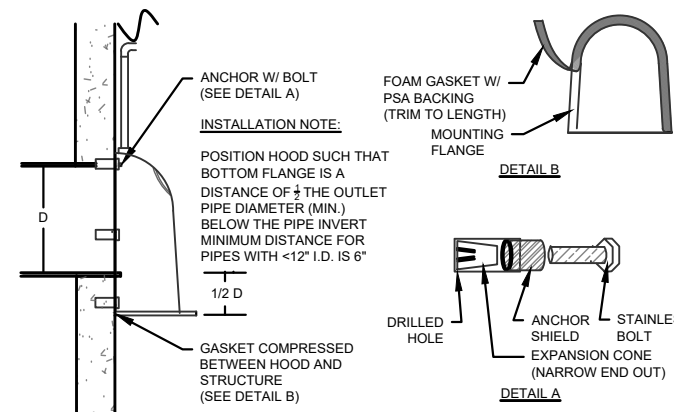
HALF SECTION

CONNECTION TO EXISTING MANHOLES
NOT TO SCALE



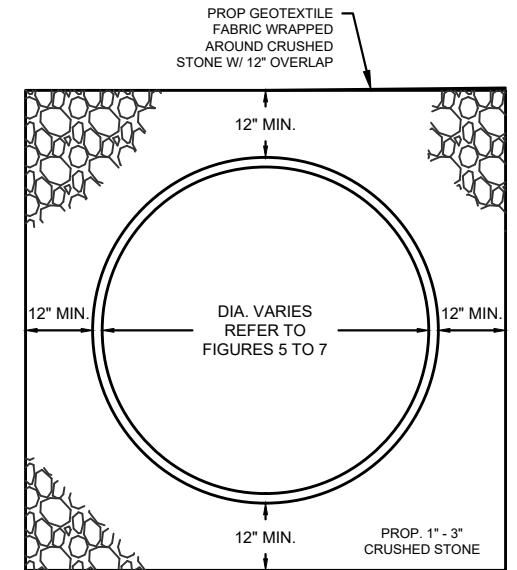
TYPICAL PIPE PLUG IN MANHOLE TO BE ABANDONED

SCALE: NTS



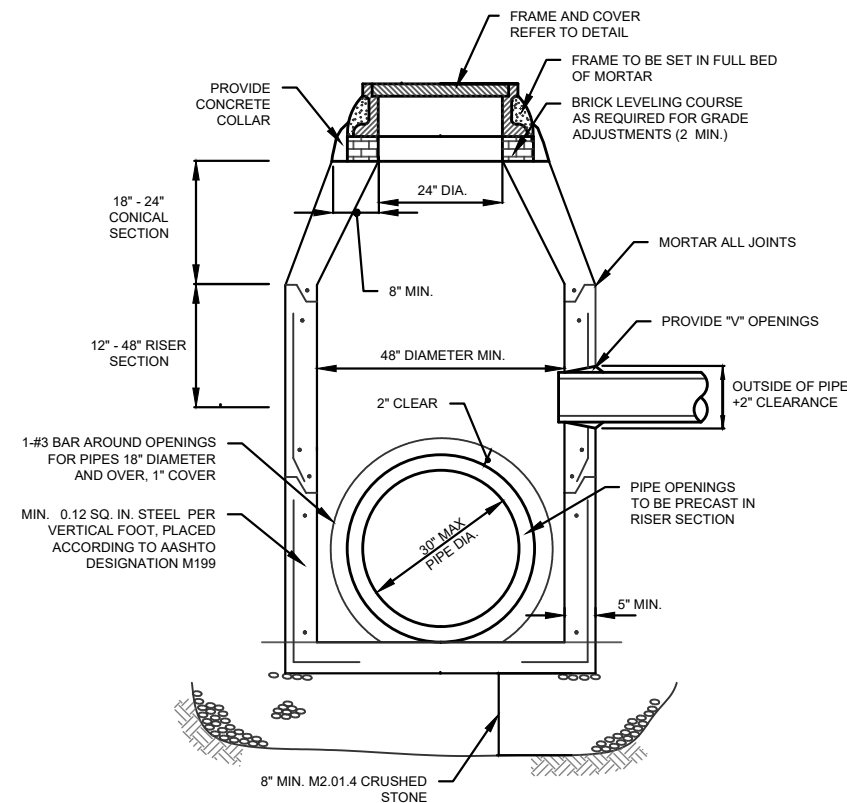
DRAINAGE STRUCTURE HOOD

NOT TO SCALE



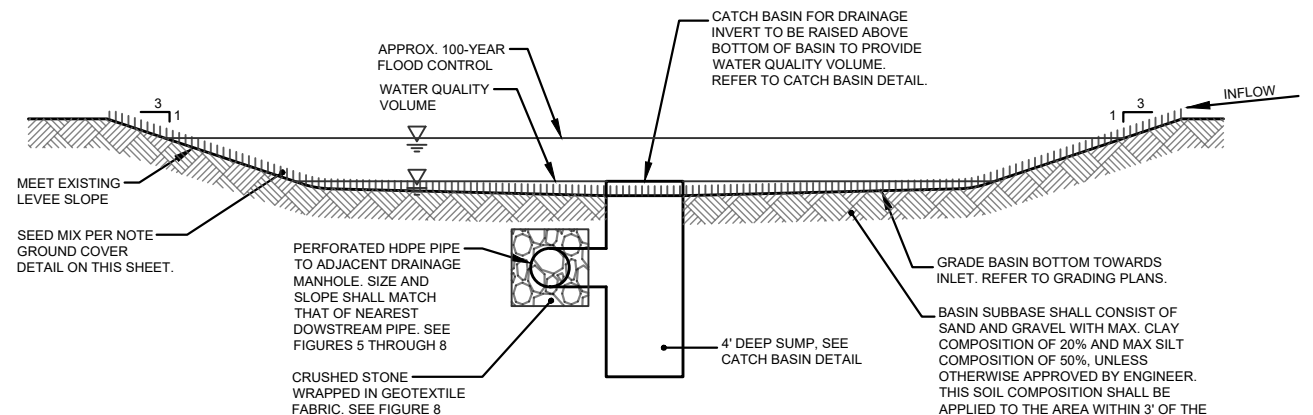
PERFORATED PIPE IN CRUSHED STONE

NOT TO SCALE



DRAINAGE MANHOLE

NOT TO SCALE

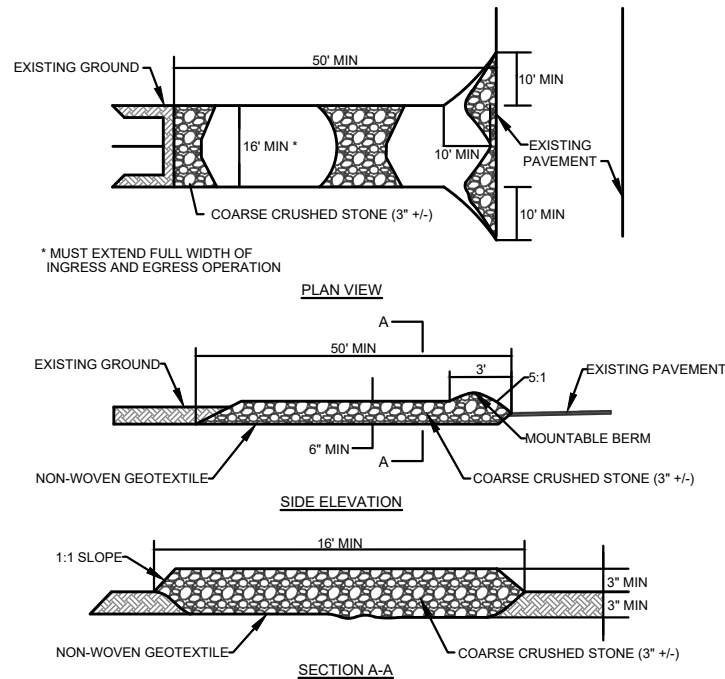


INSTALLATION NOTES:

- PRIOR TO INSTALLATION, VERIFY SOIL CONDITIONS OF PLACED BACKFILL MATERIAL TO CONFIRM ADEQUATE DRAINAGE WILL BE ACHIEVED.
- EXCAVATE/CONSTRUCT BASIN ONLY WITH LIGHT EARTH-MOVING EQUIPMENT TO AVOID EXCESSIVE COMPACTING OF SOILS BENEATH BASIN FLOOR. AVOID CONSTRUCTION IN WINTER OR DURING RAIN EVENTS TO EXTENT POSSIBLE.
- AFTER THE BASIN FLOOR IS SHAPED, PLACE SOIL ADDITIVES ON THE BASIN FLOOR TO AMEND THE SOIL, INCLUDING COMPOST (PROPERLY AGED TO KILL ANY SEED STOCK CONTAINED WITHIN) AND MIXED NATIVE SOILS FROM A OR B HORIZONS.
- SCARIFY NATIVE MATERIALS AND COMPOST INTO THE PARENT MATERIAL USING A CHISEL PLOW OR ROTARY DEVICE TO A DEPTH OF 12 INCHES.
- IMMEDIATELY AFTER BASIN IS CONSTRUCTED, STABILIZE BOTTOM AND SIDE SLOPES WITH DENSE GRASS TURF (SEE SEED MIX NOTES ON THIS SHEET).
- INSPECT BASIN REGULARLY DURING THE FIRST TWO MONTHS FOLLOWING INSTALLATION TO DETERMINE IF REMEDIAL ACTIONS (E.G. RESEEDING, IRRIGATING) ARE NECESSARY.

INFILTRATION BASIN

SCALE: NTS



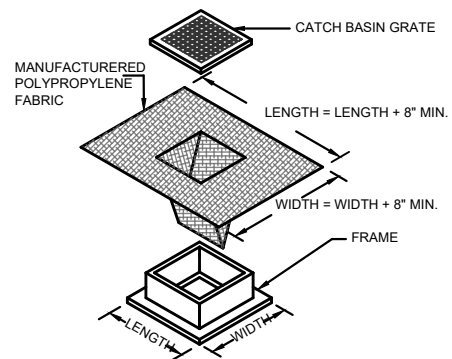
TEMPORARY CONSTRUCTION ENTRANCE NOTES

1. REMOVE ALL VEGETATION AND OTHER UNSUITABLE MATERIAL FROM THE FOUNDATION AREA, GRADE, AND CROWN FOR POSITIVE DRAINAGE. EXISTING PAVEMENT MAY REMAIN.
2. IF SLOPE TOWARDS THE PUBLIC ROAD EXCEED 2%, CONSTRUCT A 6- TO 8-INCH RIDGE WITH 3H:1V SIDE SLOPES ACROSS THE FOUNDATION APPROXIMATELY 15 FEET FROM THE EDGE OF THE PUBLIC ROAD TO DIVERT RUNOFF FROM IT.
3. INSTALL PIPE UNDER THE ENTRANCE IF NEEDED TO MAINTAIN DRAINAGE DITCHES ALONG PUBLIC ROADS.
4. PLACE STONE TO DIMENSIONS AND GRADE AS SHOWN ON PLANS. LEAVE SURFACE SLOPED FOR DRAINAGE.

MAINTENANCE

1. RESHAPE PAD AS NEEDED FOR DRAINAGE AND RUNOFF CONTROL
2. TOP DRESS WITH CLEAN STONE AS NEEDED.

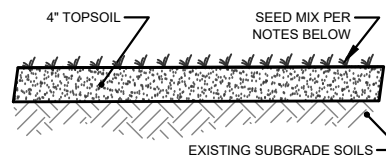
STABILIZED CONSTRUCTION ENTRANCE
SCALE: NTS



NOTES:

1. LENGTH AND WIDTH OF POLYPROPYLENE FABRIC MUST EXCEED EXISTING CATCH BASIN FRAME DIMENSIONS BY A MINIMUM OF 8\".
2. REMOVE CATCH BASIN GRATE AND INSTALL POLYPROPYLENE FABRIC OVER CATCH BASIN FRAME. REPLACE CATCH BASIN GRATE TO SECURE POLYPROPYLENE FABRIC IN PLACE.
3. CATCH BASIN EROSION CONTROL TO BE PLACED AT EXISTING AND PROPOSED ALL CATCH BASINS IN VICINITY OF WORK AREA.

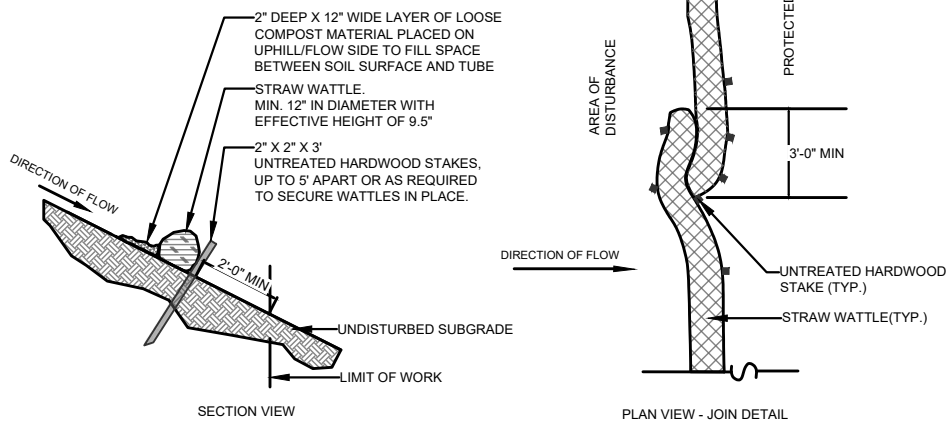
CATCH BASIN SEDIMENTATION CONTROL PROTECTION - SILT SACK
SCALE: NTS



SEED MIX NOTES:

- SEED SHALL BE LOW UPLAND MIX - FULL SUN PER MASSDOT ITEM NUMBER 765.412. OR APPROVED EQUIVALENT.
- APPLY SEED AT A RATE OF 75 LB/ACRE OR 175 LB/ACRE ON AREAS OF GREATER THAN 3:1 SLOPE
- APPLY 30LB/ACRE OF A COVER CROPS. FOR COVER CROP USE EITHER GRAIN OATS (1 JAN TO 31 JULY) OR GRAIN RYE (1 AUG TO 31 DEC).
- FERTILIZER SHALL NOT BE USED.

GROUND COVER FOR RESTORED AREAS
SCALE: NTS



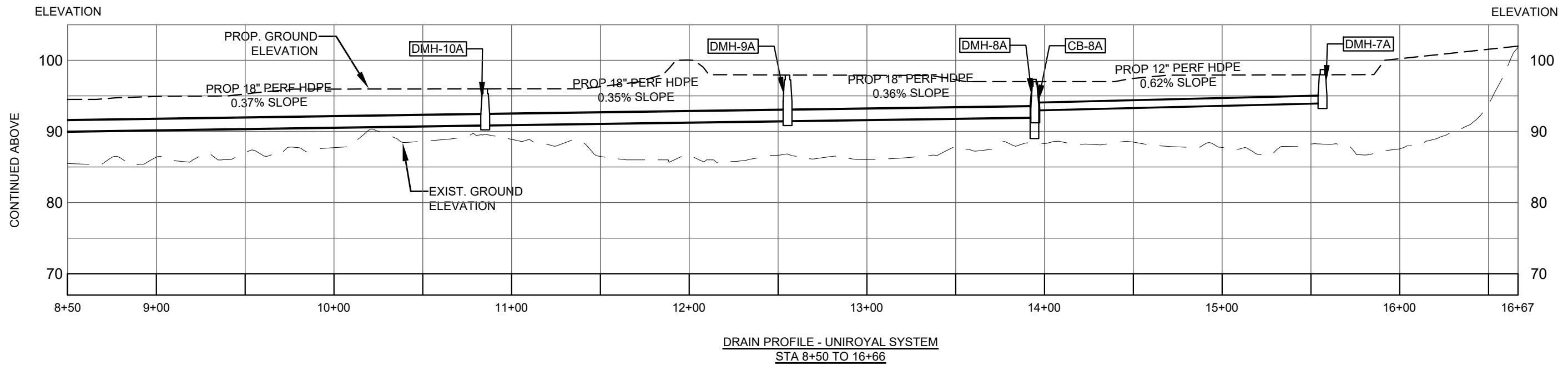
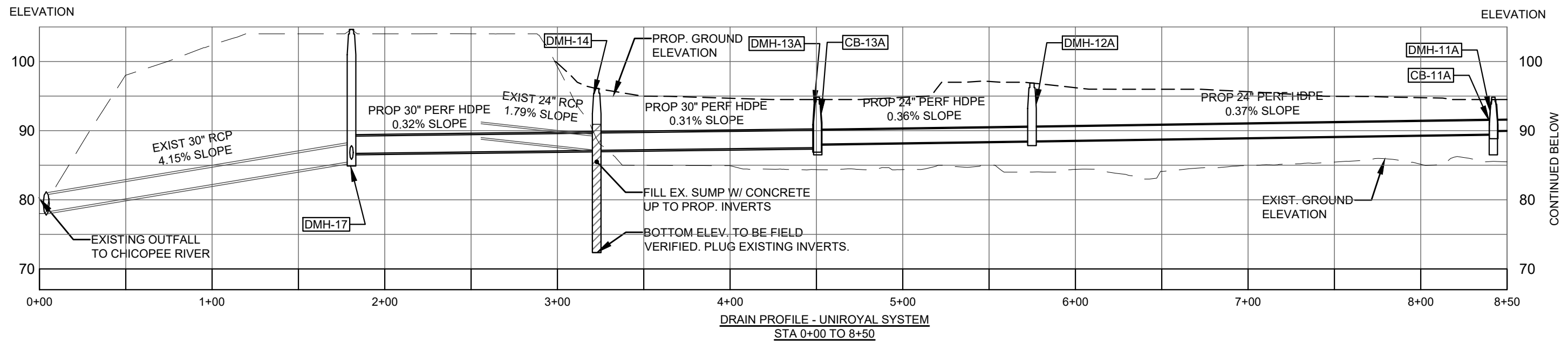
EROSION CONTROL BARRIER NOTES:

1. PROVIDE A MINIMUM DIAMETER OF 12 INCHES FOR SLOPES UP TO 50 FEET IN LENGTH WITH A SLOPE RATIO OF 3H:1V OR STEEPER. REFER TO MANUFACTURER'S RECOMMENDATIONS FOR SITUATIONS WITH LONGER OR STEEPER SLOPES.
2. INSTALL ALONG CONTOURS AND PERPENDICULAR TO SHEET OR CONCENTRATED FLOW.
3. WATTLES SHALL BE JUTE MESH OR APPROVED BIODEGRADABLE MATERIAL. ADDITIONAL WATTLES SHALL BE USED AT THE DIRECTION OF THE ENGINEER.
4. STAMP WATTLES IN PLACE TO ENSURE GOOD CONTACT WITH SOIL SURFACE. PROVIDE A 3\" MINIMUM OVERLAP AT ENDS TO JOIN IN A CONTINUOUS BARRIER AND MINIMIZE UNIMPEDED FLOW. STAKE JOINING WATTLES SNUGLY AGAINST EACH OTHER TO PREVENT UNFILTERED FLOW BETWEEN THEM.
5. SECURE ENDS WITH STAKES SPACED 18\" APART THROUGH TOPS OF TUBES.

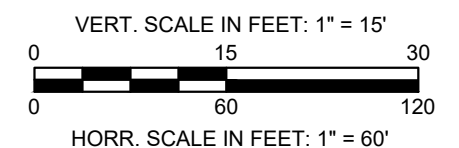
EROSION CONTROL BARRIER
SCALE: NTS

SITE PREPARATION AND EROSION CONTROL NOTES

1. THE CONSTRUCTION SEQUENCING PLAN IS FOR CONCEPTUAL PURPOSES ONLY. THE ACTUAL SEQUENCE OF WORK IMPLEMENTED FOR THIS PROJECT MAY DEVIATE FROM THIS PLAN SO LONG AS IT MEETS THE REQUIREMENTS OF THE PROJECT SITE PLANSET, PROJECT STORMWATER MANAGEMENT REPORT, CITY OF ACUSHNET REGULATIONS, AND USACE REQUIREMENTS. ADDITIONAL CONSTRUCTION ACTIVITIES MAY BE REQUIRED AT THE SITE BEYOND THOSE PRESENTED ON THIS PLAN.
2. PRIOR TO TRANSITIONING FROM ONE PHASE TO ANOTHER, AT LEAST 75% OF THE EXISTING WORK AREA SHALL BE TEMPORARILY OR PERMANENTLY STABILIZED.
3. ENGINEER WILL PROVIDE A STORMWATER POLLUTION PREVENTION PLAN (SWPPP), INCLUDING THE FILING OF A NOTICE OF INTENT WITH THE U.S. EPA TO OBTAIN A NPDES CONSTRUCTION GENERAL PERMIT (CGP) PRIOR TO THE CONTRACTOR COMMENCING WORK. THE CONTRACTOR SHALL BE RESPONSIBLE TO PERFORM INSPECTIONS, MONITORING, AND MAINTENANCE, IF WARRANTED, IN ACCORDANCE WITH THE SWPPP TO COMPLY WITH THE CGP. THE SOIL EROSION SEDIMENT CONTROL PROCEDURES AND DETAILS SHOWN AND DESCRIBED IN THE SWPPP SHALL BE STRICTLY FOLLOWED AND INSTALLED IN A MANNER TO MINIMIZE EROSION FROM DISTURBED AREAS.
4. ALL EXISTING AND PROPOSED STEEP SLOPES WITHIN THE FILL AREA (2:1 OR STEEPER, OR AS DIRECTED BY ENGINEER) TO BE STABILIZED WITH JUTE MESH EROSION CONTROL MAT OR APPROVED EQUIVALENT.
5. THE ACCESS, STAGING, AND STORAGE AREAS SHALL BE LOCATED WITHIN THE LIMITS OF THE PROJECT SITE. NO WORK, STOCKPILING OF MATERIALS, STORAGE OF EQUIPMENT, OR OTHER OPERATIONS OF THE CONTRACTOR SHALL TAKE PLACE OUTSIDE THE LIMITS OF WORK UNLESS AUTHORIZED IN WRITING BY THE ENGINEER.
6. EROSION CONTROL DEVICES SHALL BE FULLY INSTALLED PRIOR TO THE START OF ANY SITE WORK, AND SHALL BE MAINTAINED THROUGHOUT CONSTRUCTION. THESE DEVICES SHALL BE REMOVED AND LEGALLY DISPOSED OF UPON COMPLETION OF ALL WORK WHEN ALL DISTURBED AREAS ARE STABILIZED AND PERMANENT GROUND COVER IS ESTABLISHED, TO THE SATISFACTION OF THE ENGINEER AND THE TOWN. ALL EROSION CONTROL BMPs SHALL CONFORM TO US EPA, NPDES, MA DEP, AND MASSACHUSETTS EROSION AND SEDIMENTATION CONTROL GUIDELINES FOR URBAN AND SUBURBAN AREAS.
7. THE CONTRACTOR SHALL MONITOR ALL AREAS WITHIN AND AROUND THE LIMIT OF THE WORK FOR SIGNS OF EROSION, AND REPAIR/STABILIZE ANY ERODED AREAS, AS REQUIRED, UNTIL FINAL STABILIZATION CAN BE ACHIEVED.
8. THE CONTRACTOR IS RESPONSIBLE FOR MONITORING DOWNSTREAM CONDITIONS THROUGHOUT THE CONSTRUCTION PERIOD AND CLEARING ANY DEBRIS AND/OR SEDIMENT IMPEDING PROPER DRAINAGE DURING CONSTRUCTION.
9. NO SEDIMENT SHALL BE PERMITTED TO LEAVE THE SITE DURING CONSTRUCTION. IF HEAVY RAIN AND/OR UNUSUAL SITE CONDITIONS RESULT IN THE POLLUTION OF ROADWAYS, BUFFER ZONES, RESOURCE AREAS, OR ADJACENT PARCELS, CONTRACTOR SHALL NOTIFY THE ENGINEER IMMEDIATELY. CONTRACTOR SHALL CLEAN ANY DISTURBED AREAS AS SOON AS PRACTICABLE AND RESTORE THEIR ORIGINAL CONDITIONS. CLEANING AND RESTORATION WITHIN BUFFER ZONES AND RESOURCE AREAS MUST BE PERFORMED UNDER THE SUPERVISION OF A WETLAND CONSULTANT, AS COORDINATED BY ENGINEER. WORK MAY ALSO BE OBSERVED BY THE CONSERVATION COMMISSION.
10. CONTRACTOR SHALL SWEEP GROVE STREET, OAK STREET, AND WEST MAIN STREET AT THE END OF EACH WORK DAY (OR MORE FREQUENTLY AS REQUESTED BY THE CITY OR ITS AGENT) TO REMOVE SEDIMENT TRACKING CAUSED BY PROJECT-RELATED CONSTRUCTION VEHICLES.
11. SILT SACKS SHALL BE INSTALLED WITHIN ANY CATCH BASINS AND DRAIN INLETS WITHIN THE LOTS AND WITHIN THE VICINITY OF THE LIMIT OF WORK AS NECESSARY TO PREVENT SILT-LADEN RUNOFF FROM ENTERING THE CITY OR USACE STORM DRAIN SYSTEM.
12. ALL DISTURBED AREAS SHALL BE STABILIZED NO LATER THAN 14 DAYS AFTER A CONSTRUCTION ACTIVITY HAS TEMPORARILY OR PERMANENTLY CEASED ON THAT PORTION OF THE SITE.
13. ANY DISTURBED AREA EXPOSED FOR MORE THAN 7 DAYS SHALL BE STABILIZED WITH PERENNIAL RYE GRASS SEEDING OR APPROVED EQUIVALENT. ADDITIONALLY, A ROW OF STRAW WATTLES SHALL BE PLACED AND STAKED ON THE DOWNGRADIENT SIDE OF ALL SUCH AREAS. SEEDING AREAS SHALL BE RE-SEEDING AS NECESSARY TO ENSURE VEGETATION ESTABLISHMENT.
14. ALL STOCKPILES AND DISTURBED AREAS TO BE STABILIZED IF EXPOSED FOR MORE THAN 7 DAYS. ALL STOCKPILES SHALL BE SURROUNDED BY COMPOST FILTER RUBES, AND COVERED IN A MANNER THAT STORMWATER DOES NOT INFILTRATE THE MATERIAL. ALL STOCKPILES OVER 10' IN HEIGHT SHALL BE SURROUNDED BY SAFETY FENCING. NO STOCKPILE SHALL BE PLACED NORTH OF EAST OF THE PERIMETER EROSION CONTROLS.



- NOTES:**
1. REFER TO FIGURES 5 THROUGH 6 FOR DRAINAGE STRUCTURE SCHEDULE AND FIGURE 9 FOR STRUCTURE DETAILS.
 2. STRUCTURE SUMP ELEVATIONS MAY DIFFER FROM THOSE SHOWN. REFER TO DETAIL ON FIGURE 9.
 3. EXISTING 30" RCP INVERT AT DMH-14 SHALL BE LOCATED AND FIELD VERIFIED. INVERT TO BE ADJUSTED AS NECESSARY TO PROVIDE POSITIVE DRAINAGE TO DMH-17.

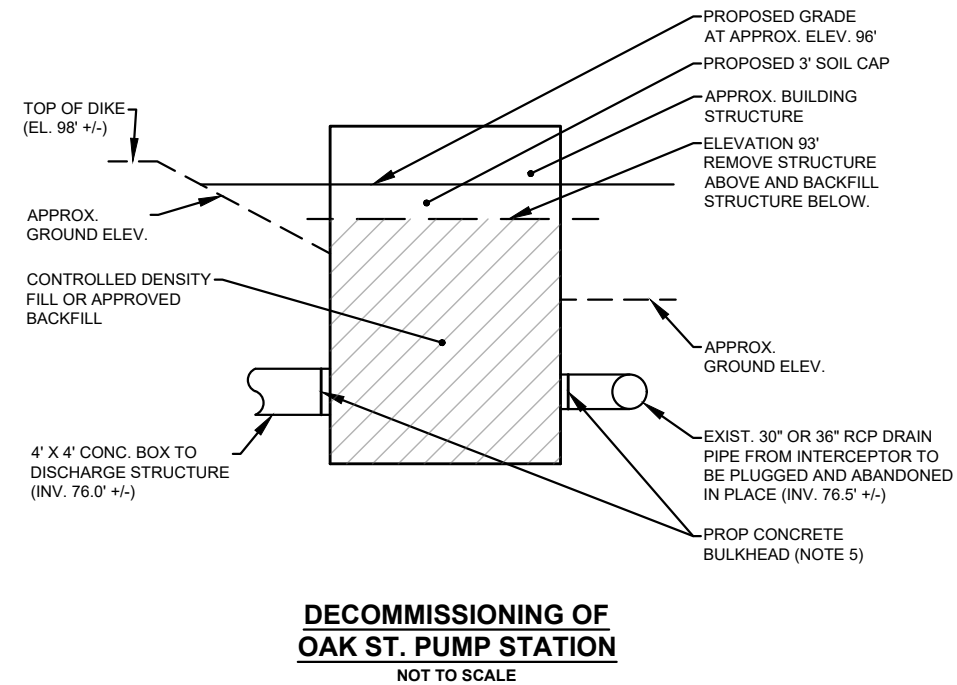
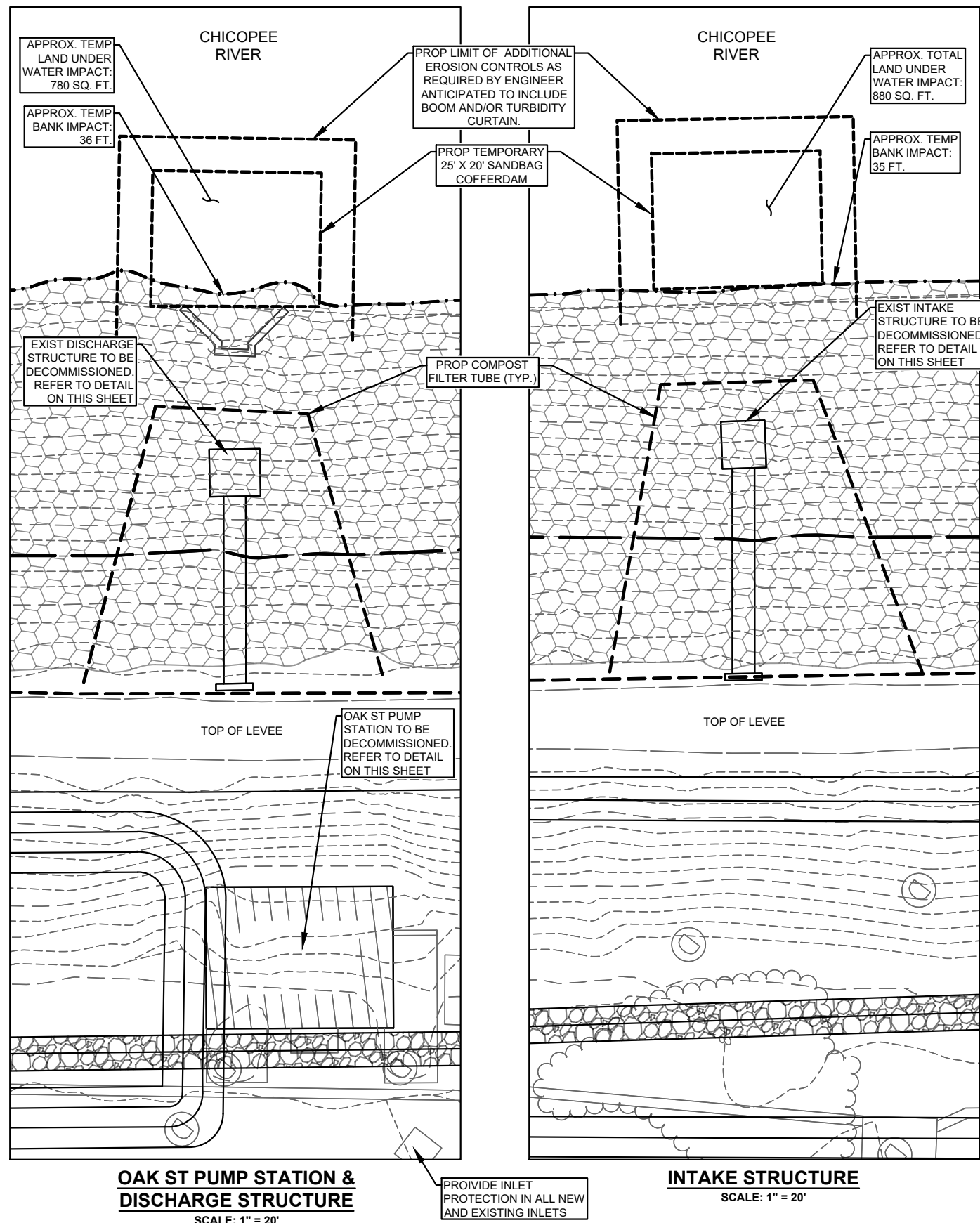


Former Uniroyal & Facemate Properties
 USACE Permit Review Only
 154 Grove Street & 75 West Main Street
 Chicopee, MA

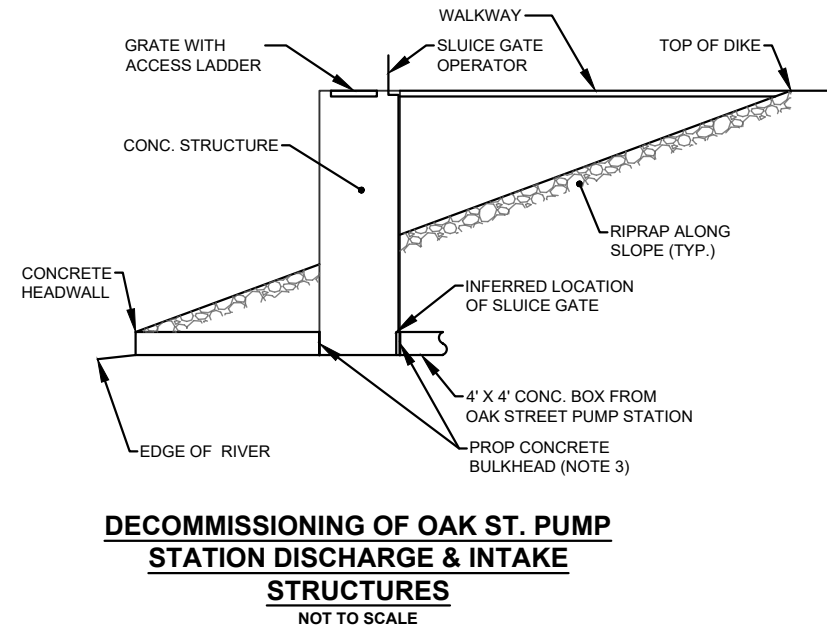
Issue Date: 9-12-2022

Figure No. 11
Drainage Profile

D:\STATIONING - CHICOPEE - UNIROYAL - SERVICES\DRAWING FILES\UTDC\017 ACDE PLANS\ACDE PLANS.DWG

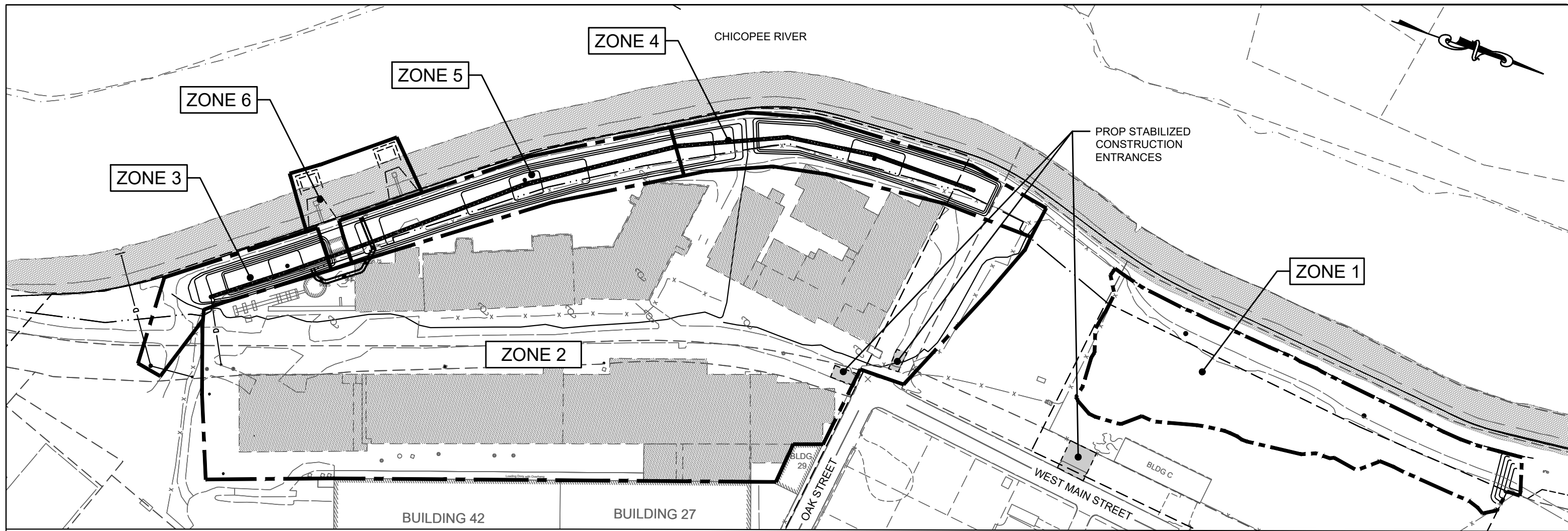


- GENERAL SEQUENCE OF WORK - PUMP STATION**
1. ENSURE EROSION CONTROLS ARE PLACED IN ALL NEARBY DRAIN INLETS.
 2. DISMANTLE AND REMOVE ALL EXISTING ELECTRICAL CONNECTIONS AND UTILITIES, INCLUDING ABOVE-GROUND TANK AND ASSOCIATED FENCING.
 3. DISMANTLE AND REMOVE ALL EQUIPMENT WITHIN THE PUMP STATION TO BE PRESERVED OR DISCARDED.
 4. DEWATER STRUCTURE AS NEEDED AND INSTALL TEMPORARY MEASURES TO PREVENT WATER FROM ENTERING STRUCTURE.
 5. INSTALL CONCRETE BULKHEAD AT ALL DISCHARGE AND INTERCEPTOR DRAIN PIPES.
 6. DEMOLISH EXISTING PUMP STATION ROOF AND BUILDING WALLS TO AT LEAST 3' BELOW PROPOSED GRADE (TO APPROX. ELEV. 93')
 7. DEMOLISH ELEVATED TANK STRUCTURE LOCATED TO THE NORTH OF THE PUMP STATION. LOWER ASSOCIATED CONCRETE FOOTINGS TO AT LEAST 3' BELOW PROPOSED GRADE.
 8. BACKFILL REMAINING PUMP STATION WITH CONTROLLED DENSITY FILL OR APPROVED BACKFILL.
 9. ABANDON REMAINING PUMP STATION STRUCTURE IN PLACE AND BACKFILL IN ACCORDANCE WITH FILL MANAGEMENT PLAN, INCLUDING LAYER OF GEOTEXTILE FABRIC AND AT LEAST 3' OF CLEAN FILL WHERE NECESSARY.
- NOTES:**
1. INTERIOR OF STRUCTURE IS APPROXIMATE ONLY BASED ON LIMITED VISUAL OBSERVATIONS AND RECORD PLANS. ACTUAL LAYOUT MAY VARY.



- GENERAL SEQUENCE OF WORK - DISCHARGE & INTAKE STRUCTURES**
1. DEWATER STRUCTURE AS NEEDED AND INSTALL TEMPORARY MEASURES TO PREVENT WATER FROM ENTERING STRUCTURE.
 2. REMOVE SLUICE GATE AND SEAL BOTTOM PORTION OF STRUCTURE WITH CONCRETE BULKHEAD TO BLOCK FLOW FROM BOTH SIDES.
 3. DISMANTLE AND REMOVE ALL EQUIPMENT FOR OPERATIONS OF SLUICE GATE.
 4. DEMOLISH WALKWAY, INTAKE STRUCTURES, AND SOUTH HEADWALL.
 5. BACKFILL THE PORTION OF PIPE THAT CROSSES BENEATH THE LEVEE WITH FLOWABLE FILL.
 6. BACKFILL LOWER PORTION OF INTAKE STRUCTURES WITH CLEAN FILL TO GRADE.
 7. PROVIDE RIPRAP OVER FOOTPRINT OF INTAKE STRUCTURE TO MATCH EXISTING SLOPE.
- NOTES:**
1. INTERIOR OF STRUCTURE IS APPROXIMATE ONLY BASED ON LIMITED VISUAL OBSERVATIONS. ACTUAL LAYOUT MAY VARY.

D:\STUDIOS\1318 - CHICOPEE - ENVIRONMENTAL SERVICES\DRAWING FILES\1318\1318-01\ACOE PLANS\ACOE PLANS.DWG



CONCEPTUAL CONSTRUCTION SEQUENCE

- PHASE 1 CAN BE CONDUCTED CONCURRENTLY WITH PHASES 2 - 7.

PHASE 0 (SITEWIDE)

- COORDINATE SCHEDULE WITH OTHER ON-SITE CONTRACTORS
- INSTALL SITEWIDE PERIMETER EROSION CONTROLS, INLET PROTECTION, AND STABILIZED CONSTRUCTION ENTRANCES.
- REVIEW GUIDELINES OF CITY FILL MANAGEMENT PLAN, INCLUDING PROCEDURE FOR ACCEPTANCE AND MANAGEMENT OF BACKFILL MATERIAL.
- ESTABLISH STOCKPILE AND STAGING AREAS.
- FIELD-LOCATE ALL EXISTING DRAINAGE STRUCTURE IN THE VICINITY OF THE FLOOD CONTROL LEVEE AND THOSE ASSOCIATED WITH BUILDING 26 & 27 ROOF DRAINAGE SYSTEM..
- RAISE EXISTING MONITORING WELLS AS DEEMED NECESSARY BY THE CITY OR ITS LICENSED SITE PROFESSIONAL.
- IDENTIFY AND RELOCATE/REMOVE ANY ITEMS THAT MAY OBSTRUCT BACKFILL OPERATIONS, SUCH AS FENCING AND UTILITY POLES. SITE SECURITY FOR UNIROYAL TO BE RESET AT DISCRETION OF CITY.

PHASE 1 (ZONE 1)

- REMOVE EXISTING RIPRAP FLOW CHANNELS FROM ZONE 1. EVALUATE EXISTING STRAW WATTLES FOR RE-USE.
- PLUG EXISTING BYPASS LINE SOUTH OF BUILDING C.
- REM EXIST CATCH BASINS AND INSTALL PROPOSED DRAIN MANHOLES.
- ADJUST CB-14 AS REQUIRED BY ENGINEER.
- CONDUCT GRADING OF ZONE 1 IN ACCORDANCE WITH FILL MANAGEMENT PLAN, INCLUDING PLACEMENT OF FILL MATERIAL, GEOTEXTILE FABRIC LAYER, AND CLEAN SOIL CAP.

PHASE 2 (ZONE 2)

- ENSURE THAT ACCESS TO PUMP STATION IS MAINTAINED THROUGHOUT PHASES 2 THROUGH 5.
- CONDUCT GRADING OF ZONE 3 IN ACCORDANCE WITH FILL MANAGEMENT PLAN, INCLUDING PLACEMENT OF FILL MATERIAL, GEOTEXTILE FABRIC LAYER, AND CLEAN SOIL CAP.
- TEMPORARILY GRADE WEST SIDE OF ZONE 2 TO MAXIMUM SLOPE OF 3:1 TO MEET EXISTING GRADES.
- ENSURE THAT DEMOLITION OF BUILDING 15 IS COMPLETED PRIOR TO START OF PHASE 4 (UNDER SEPARATE CONTRACT).
- DEMOLISH ELEVATED TANK STRUCTURE NEAR PUMP STATION.

PHASE 3 (ZONE 3)

- FILL AND/OR ABANDON EXISTING DRAINAGE STRUCTURES IN ACCORDANCE WITH SITE PLANSET.
- ADJUST DMH-14 AND DMH-17, AND INSTALL 24" HDPE BETWEEN THE TWO STRUCTURES. EVALUATE EXISTING NORTHBOUND INVERT AT DMH-14.
- BACKFILL ZONE TO THE APPROXIMATE BOTTOM ELEVATION OF THE PROPOSED INFILTRATION BASIN, EXCLUDING THE FOOTPRINT AND IMMEDIATE VICINITY OF PROPOSED DRAINAGE STRUCTURES AND DRAIN LINES.
- TEMPORARILY GRADE NORTH SIDE OF ZONE 3 TO MAXIMUM SLOPE OF 3:1 TO MEET EXISTING GRADES.
- INSTALL PROPOSED DRAINAGE STRUCTURES, DRAINAGE PIPES, AND CRUSHED STONE AROUND PERFORATED PIPE. PIPE BETWEEN DMH-13A & DMH-12A TO BE CONSTRUCTED DURING PHASE 6.
- CONSTRUCT INFILTRATION BASIN AND BACKFILL ZONE TO FINAL GRADES.

PHASE 4 (ZONE 4)

- FILL AND/OR ABANDON EXISTING DRAINAGE STRUCTURES IN ACCORDANCE WITH SITE PLANSET.
- BACKFILL ZONE TO THE APPROXIMATE BOTTOM ELEVATION OF THE PROPOSED INFILTRATION BASIN, EXCLUDING THE FOOTPRINT AND IMMEDIATE VICINITY OF PROPOSED DRAINAGE STRUCTURES AND DRAIN LINES.
- TEMPORARILY GRADE SOUTH SIDE OF ZONE 4 TO MAXIMUM SLOPE OF 3:1 TO MEET EXISTING GRADES.
- INSTALL PROPOSED DRAINAGE STRUCTURES, DRAINAGE PIPES, AND CRUSHED STONE AROUND PERFORATED PIPE. TEMPORARILY GRADE PIPE-LESS OUTLET FROM DMH-10A TO CONVEY FLOWS TO NEARBY EXISTING CATCH BASIN.
- CONSTRUCT INFILTRATION BASIN AND BACKFILL ZONE TO FINAL GRADES.

PHASE 5 (ZONE 5)

- FILL AND/OR ABANDON EXISTING DRAINAGE STRUCTURES IN ACCORDANCE WITH SITE PLANSET, EXCLUDING STRUCTURES NECESSARY FOR PUMP STATION OPERATION.
- BACKFILL ZONE TO THE APPROXIMATE BOTTOM ELEVATION OF THE PROPOSED INFILTRATION BASIN, EXCLUDING THE FOOTPRINT AND IMMEDIATE VICINITY OF PROPOSED DRAINAGE STRUCTURES AND DRAIN LINES.
- TEMPORARILY GRADE SOUTH SIDE OF ZONE 5 TO MAXIMUM SLOPE OF 3:1 TO MEET EXISTING GRADES.
- INSTALL PROPOSED DRAINAGE STRUCTURES, DRAINAGE PIPES, AND CRUSHED STONE AROUND PERFORATED PIPE. TEMPORARILY GRADE PIPE-LESS OUTLET FROM DMH-12A TO CONVEY FLOWS TO NEARBY EXISTING CATCH BASIN.
- CONSTRUCT INFILTRATION BASIN AND BACKFILL ZONE TO FINAL GRADES.

PHASE 6 (ZONE 6)

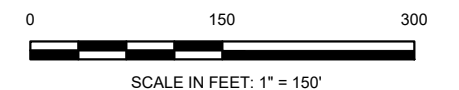
- CONSTRUCT TEMPORARY SWALE TO DIVERT STORMWATER RUNOFF AWAY FROM PUMP STATION. PROVIDE TEMPORARY PLUG FOR PIPE-LESS OUTLET FROM DMH-12A.
- COMPLETE DECOMMISSIONING OF OAK ST. PUMP STATION, DISCHARGE STRUCTURE, AND INTAKE STRUCTURE (REFER TO FIGURE 12)
- FILL AND/OR ABANDON EXISTING DRAINAGE STRUCTURES IN ACCORDANCE WITH SITE PLANSET, EXCLUDING STRUCTURES NECESSARY FOR PUMP STATION OPERATION.
- BACKFILL ZONE TO APPROX. ELEVATION 88', EXCLUDING THE FOOTPRINT AND IMMEDIATE VICINITY OF PROPOSED DRAINAGE STRUCTURES AND DRAIN LINES.
- INSTALL DRAINAGE PIPE FROM DMH-12A TO DMH-13A AND CRUSHED STONE AROUND PERFORATED PIPE.
- COMPLETE DECOMMISSIONING OF OAK ST. PUMP STATION DISCHARGE STRUCTURE.
- REMOVE TEMPORARY SWALE AND BACKFILL ZONE TO FINAL GRADES.

PHASE 7 (SITEWIDE)

- REMOVE PHASE 7 DIVERSION SWALE
- CONDUCT FINE GRADING OF ANY AREAS NOT YET FINALIZED.
- VERIFY DRAINAGE PATTERNS, ENSURING NO RUNOFF IS DIRECTED OVER THE LEVEE.
- COMPLETE SITE-WIDE PERMANENT RESTORATION (UNLESS PRECLUDED BY OTHER SITE ACTIVITIES).
- REMOVE EROSION CONTROLS ONCE FINAL STABILIZATION IS ACHIEVED, UNLESS OTHERWISE NEEDED FOR FUTURE SITEWORK.

LEGEND

- — — PROPERTY LINE
- · - · - APPROX. LIMIT OF CHICOPEE RIVER
- · - · - APPROX. LIMIT OF USACE PARCEL (TRACT R8)
- - - 100-YEAR FEMA FLOOD ZONE



D:\STAFF\BIBB - CHICOPEE - UNIROYAL - ACOE PERMIT REVIEW\FIGURE 13\FIGURE 13.DWG



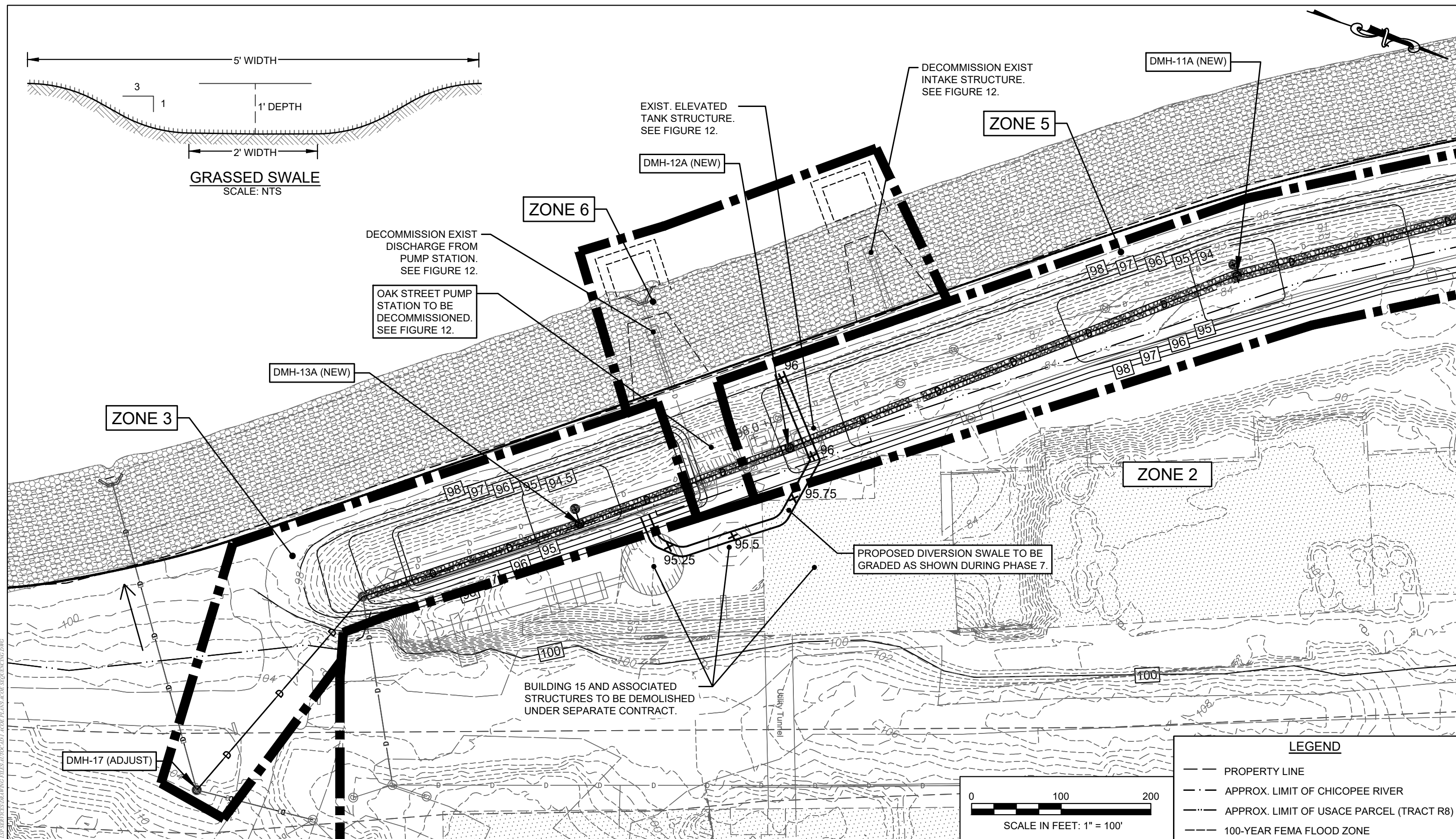
Former Uniroyal & Facemate Properties

ACOE Permit Review Only
154 Grove Street & 75 West Main Street
Chicopee, MA

Issue Date: 9-12-2022

Figure No. 13

Overall Sequencing Plan



0:510835100 - CHICOPEE - UNIROYAL & FACEMATE PROPERTIES - PHASE 7 - SEQUENCING PLAN - FOR PERMIT REVIEW ONLY



Former Uniroyal & Facemate Properties
 ACOE Permit Review Only
 154 Grove Street & 75 West Main Street
 Chicopee, MA
 Issue Date: 9-12-2022

Figure No. 14
Enlarged Sequencing Plan

APPENDIX B – Historic and Cultural Resources Coordination



August 5, 2022

Brona Simon, State Archaeologist/ SHPO
Massachusetts Historical Commission (MHC)
The Massachusetts Archives Bldg.
220 Morrissey Boulevard
Boston, MA 02125

**Re: Project Notification Form
Proposed Flood Control System Along Chicopee Falls
Chicopee, Massachusetts**

Dear Ms. Simon:

As part of an ongoing effort to establish a site suitable for redevelopment, the City of Chicopee (the City) proposes improvements to several parcels along the Chicopee River. This project is the crucial first step in realizing these potential economic improvements in a former industrial area that has been dormant and drastically underutilized for decades. The enclosed project notification information (PNF) is provided for the MHC's review as part of the Environmental Assessment being prepared for this work pursuant to the National Environmental Policy Act (NEPA).

The City plans to continue efforts to support the future redevelopment of a portion of the former Uniroyal complex located at 154 Grove Street and a portion of the former Facemate complex (A.K.A. "the Baskin Parcel") located at 75 West Main Street, both in Chicopee, Massachusetts (collectively referred to as "the Site"). The City proposes to accept and place acceptable fill material at the Site to facilitate future construction and redevelopment efforts consistent with local planning efforts and municipal zoning along the Chicopee River. Specifically, fill will be placed along the Chicopee Falls Local Protection Project flood control levee (the Levee) and a water intake structure and associated pumping station along the Chicopee River will be abandoned and filled (the Project). The existing undulating topography and buried/mitigated contamination currently presents development challenges; therefore, the Project will raise the Site up to approximately eight (8) feet to create a consistent development Site between elevations 98 feet and 100 feet (NAVD 88).

In order to protect the environment and the local community, the Project will implement a number of best management practices (BMPs) during construction to mitigate noise, air quality degradation, and construction-period stormwater runoff. Once fill is placed and the Site is brought to final grade, long-term stormwater management BMPs will be constructed and are anticipated to be adaptable to future development requirements. All stormwater management work will be performed at the new Site grade and any stormwater structures proposed for reuse will be retrofitted to the new target elevations to preclude the need for excavation.

As a priority Brownfields property, the Site offers a suitable location for the deposition of offsite soils with contaminant concentrations below the Reportable Concentrations specified under 310 CMR 40.0300 and 40.1600 to reduce the burden on New England landfills while supporting a crucial redevelopment effort for the City. All soil materials will be handled in accordance with the Anti-Degradation Provision of the Massachusetts Contingency Plan (MCP) at 310 CMR 40.0032(3) and are not anticipated to pose any significant risk to the future at-grade uses envisioned at the Site. The materials will also be handled in

compliance with the City's Fill Management Plan, which has been submitted to MassDEP. The City will acquire all relevant permits and approvals to ensure compliance with the applicable regulations, including obtaining coverage under the Construction General Permit (CGP) pursuant to the National Pollutant Discharge Elimination Systems (NPDES) program, obtaining coverage under the Massachusetts General Permit pursuant to the Clean Water Act, and securing an Order of Conditions from the Chicopee Conservation Commission.

The Massachusetts Historical Commission's online database was reviewed to identify any historic resources within or adjacent to the Project limits. The Massachusetts Historical Commission's online database (The Massachusetts Cultural Resource Information System - MACRIS) lists the following resources:

- CHI.K – Fisk Rubber Company Complex (Inventoried Area)
- CHI.Q – Chicopee Manufacturing Company (Inventoried Area)

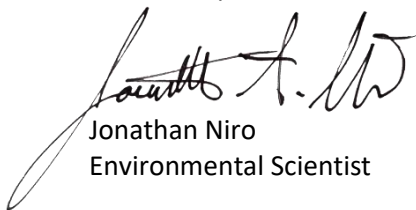
A Project Notification Form (PNF) was previously submitted to the Massachusetts Historical Commission (MHC) for the demolition of eight (8) structurally unsound buildings at the Site. The PNF was assigned MHC Project #46829 and a Memorandum of Agreement (MOA) was subsequently issued by MHC on or about April 5, 2011. Inventoried buildings identified by MHC as CHI.553, CHI.554, and CHI.555 have been demolished following the issuance of the aforementioned 2011 MOA. The following inventoried buildings remain at the Site:

- CHI.228 – Fisk Rubber Company Office – 154 Grove Street (Inventoried Building)
- CHI.556 – Fisk Rubber Company Office Building and Garage – 154 Grove Street (Inventoried Building)

The Project does not propose any impacts to CHI.228 or CHI.556.

On behalf of the City of Chicopee, BETA Group, Inc. requests that the MHC review the enclosed materials at its earliest convenience and provide any comments regarding the Project. Written comments should be submitted by email to Jonathan Niro at jniro@BETA-inc.com or by mail at 89 Shrewsbury Street (Suite 300), Worcester, Massachusetts 01604. If you have any questions concerning the enclosed Project information, please feel free to contact Jonathan Niro at the provided email address or by phone at (774)-573-9694.

Very truly yours,
BETA Group, Inc.



Jonathan Niro
Environmental Scientist

Attachments: Project Notification Form
Figure 1 – USGS Site Locus
Construction Plans
Photographic Documentation



August 5, 2022

Massachusetts Board of Underwater Archeological Resources (BUAR)
251 Causeway Street, Suite 800
Boston, MA 02114

**Re: Project Notification Form
Proposed Flood Control System Along Chicopee Falls
Chicopee, Massachusetts**

Board of Underwater Archeological Resources:

As part of an ongoing effort to establish a site suitable for redevelopment, the City of Chicopee (the City) proposes improvements to several parcels along the Chicopee River. This project is the crucial first step in realizing these potential economic improvements in a former industrial area that has been dormant and drastically underutilized for decades. The enclosed project notification information (PNF) is provided for the BUAR's review as part of the Environmental Assessment being prepared for this work pursuant to the National Environmental Policy Act (NEPA).

The City plans to continue efforts to support the future redevelopment of a portion of the former Uniroyal complex located at 154 Grove Street and a portion of the former Facemate complex (A.K.A. "the Baskin Parcel") located at 75 West Main Street, both in Chicopee, Massachusetts (collectively referred to as "the Site"). The City proposes to accept and place contaminated fill material at the Site to facilitate future construction and redevelopment efforts consistent with local planning efforts and municipal zoning along the Chicopee River. Specifically, fill will be placed along the Chicopee Falls Local Protection Project flood control levee (the Levee) and a water intake structure and associated pumping station along the Chicopee River will be abandoned and filled (the Project). The existing undulating topography and buried/mitigated contamination currently presents development challenges; therefore, the Project will raise the Site up to approximately eight (8) feet to create a consistent development Site between elevations 98 feet and 100 feet (NAVD 88).

In order to protect the environment and the local community, the Project will implement a number of best management practices (BMPs) during construction to mitigate noise, air quality degradation, and construction-period stormwater runoff. Once fill is placed and the Site is brought to final grade, long-term stormwater management BMPs will be constructed and are anticipated to be adaptable to future development requirements. All stormwater management work will be performed at the new Site grade and any stormwater structures proposed for reuse will be retrofitted to the new target elevations to preclude the need for excavation.

As a priority Brownfields property, the Site offers a suitable location for the deposition of offsite soils with contaminant concentrations below the Reportable Concentrations specified under 310 CMR 40.0300 and 40.1600 to reduce the burden on New England landfills while supporting a crucial redevelopment effort for the City. All soil materials will be handled in accordance with the Anti-Degradation Provision of the Massachusetts Contingency Plan (MCP) at 310 CMR 40.0032(3) and are not anticipated to pose any significant risk to the future at-grade uses envisioned at the Site. The materials will also be handled in compliance with the City's Fill Management Plan, which has been submitted to MassDEP. The City will acquire all relevant permits and approvals to ensure compliance with the applicable regulations, including

obtaining coverage under the Construction General Permit (CGP) pursuant to the National Pollutant Discharge Elimination Systems (NPDES) program, obtaining coverage under the Massachusetts General Permit pursuant to the Clean Water Act, and securing an Order of Conditions from the Chicopee Conservation Commission.

The Massachusetts Historical Commission's online database was reviewed to identify any historic resources within or adjacent to the Project limits. The Massachusetts Historical Commission's online database (The Massachusetts Cultural Resource Information System - MACRIS) lists the following resources:

- CHI.K – Fisk Rubber Company Complex (Inventoried Area)
- CHI.Q – Chicopee Manufacturing Company (Inventoried Area)

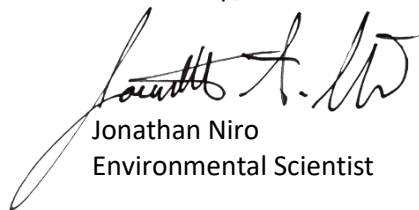
A Project Notification Form (PNF) was previously submitted to the Massachusetts Historical Commission (MHC) for the demolition of eight (8) structurally unsound buildings at the Site. The PNF was assigned MHC Project #46829 and a Memorandum of Agreement (MOA) was subsequently issued by MHC on or about April 5, 2011. Inventoried buildings identified by MHC as CHI.553, CHI.554, and CHI.555 have been demolished following the issuance of the aforementioned 2011 MOA. The following inventoried buildings remain at the Site:

- CHI.228 – Fisk Rubber Company Office – 154 Grove Street (Inventoried Building)
- CHI.556 – Fisk Rubber Company Office Building and Garage – 154 Grove Street (Inventoried Building)

The Project does not propose any impacts to CHI.228 or CHI.556.

On behalf of the City of Chicopee, BETA Group, Inc. requests that the BUAR review the enclosed materials at its earliest convenience and provide any comments regarding the Project. Written comments should be submitted by email to Jonathan Niro at jniro@BETA-inc.com or by mail at 89 Shrewsbury Street (Suite 300), Worcester, Massachusetts 01604. If you have any questions concerning the enclosed Project information, please feel free to contact Jonathan Niro at the provided email address or by phone at (774)-573-9694.

Very truly yours,
BETA Group, Inc.



Jonathan Niro
Environmental Scientist

Attachments: Project Notification Form
Figure 1 – USGS Site Locus
Construction Plans
Photographic Documentation



August 5, 2022

Tribal Historic Preservation Officer
Mashpee Wampanoag Tribe
483 Great Neck Road South
Mashpee, MA 02649

**Re: Project Notification Form
Proposed Flood Control System Along Chicopee Falls
Chicopee, Massachusetts**

Mashpee Wampanoag Tribal Historic Preservation Officer:

As part of an ongoing effort to establish a site suitable for redevelopment, the City of Chicopee (the City) proposes improvements to several parcels along the Chicopee River. This project is the crucial first step in realizing these potential economic improvements in a former industrial area that has been dormant and drastically underutilized for decades. The enclosed project notification information (PNF) is provided for the Mashpee Wampanoag Tribe Historic Preservation Officer's review as part of the Environmental Assessment being prepared for this work pursuant to the National Environmental Policy Act (NEPA).

The City plans to continue efforts to support the future redevelopment of a portion of the former Uniroyal complex located at 154 Grove Street and a portion of the former Facemate complex (A.K.A. "the Baskin Parcel") located at 75 West Main Street, both in Chicopee, Massachusetts (collectively referred to as "the Site"). The City proposes to accept and place contaminated fill material at the Site to facilitate future construction and redevelopment efforts consistent with local planning efforts and municipal zoning along the Chicopee River. Specifically, fill will be placed along the Chicopee Falls Local Protection Project flood control levee (the Levee) and a water intake structure and associated pumping station along the Chicopee River will be abandoned and filled (the Project). The existing undulating topography and buried/mitigated contamination currently presents development challenges; therefore, the Project will raise the Site up to approximately eight (8) feet to create a consistent development Site between elevations 98 feet and 100 feet (NAVD 88).

In order to protect the environment and the local community, the Project will implement a number of best management practices (BMPs) during construction to mitigate noise, air quality degradation, and construction-period stormwater runoff. Once fill is placed and the Site is brought to final grade, long-term stormwater management BMPs will be constructed and are anticipated to be adaptable to future development requirements. All stormwater management work will be performed at the new Site grade and any stormwater structures proposed for reuse will be retrofitted to the new target elevations to preclude the need for excavation.

As a priority Brownfields property, the Site offers a suitable location for the deposition of offsite soils with contaminant concentrations below the Reportable Concentrations specified under 310 CMR 40.0300 and 40.1600 to reduce the burden on New England landfills while supporting a crucial redevelopment effort for the City. All soil materials will be handled in accordance with the Anti-Degradation Provision of the Massachusetts Contingency Plan (MCP) at 310 CMR 40.0032(3) and are not anticipated to pose any significant risk to the future at-grade uses envisioned at the Site. The materials will also be handled in compliance with the City's Fill Management Plan, which has been submitted to MassDEP. The City will

acquire all relevant permits and approvals to ensure compliance with the applicable regulations, including obtaining coverage under the Construction General Permit (CGP) pursuant to the National Pollutant Discharge Elimination Systems (NPDES) program, obtaining coverage under the Massachusetts General Permit pursuant to the Clean Water Act, and securing an Order of Conditions from the Chicopee Conservation Commission.

The Massachusetts Historical Commission's online database was reviewed to identify any historic resources within or adjacent to the Project limits. The Massachusetts Historical Commission's online database (The Massachusetts Cultural Resource Information System - MACRIS) lists the following resources:

- CHI.K – Fisk Rubber Company Complex (Inventoried Area)
- CHI.Q – Chicopee Manufacturing Company (Inventoried Area)

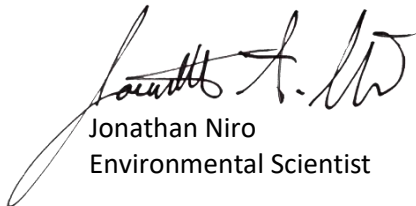
A Project Notification Form (PNF) was previously submitted to the Massachusetts Historical Commission (MHC) for the demolition of eight (8) structurally unsound buildings at the Site. The PNF was assigned MHC Project #46829 and a Memorandum of Agreement (MOA) was subsequently issued by MHC on or about April 5, 2011. Inventoried buildings identified by MHC as CHI.553, CHI.554, and CHI.555 have been demolished following the issuance of the aforementioned 2011 MOA. The following inventoried buildings remain at the Site:

- CHI.228 – Fisk Rubber Company Office – 154 Grove Street (Inventoried Building)
- CHI.556 – Fisk Rubber Company Office Building and Garage – 154 Grove Street (Inventoried Building)

The Project does not propose any impacts to CHI.228 or CHI.556.

On behalf of the City of Chicopee, BETA Group, Inc. requests that the Tribal Historic Preservation Officer review the enclosed materials at its earliest convenience and provide any comments regarding the Project. Written comments should be submitted by email to Jonathan Niro at jniro@BETA-inc.com or by mail at 89 Shrewsbury Street (Suite 300), Worcester, Massachusetts 01604. If you have any questions concerning the enclosed Project information, please feel free to contact Jonathan Niro at the provided email address or by phone at (774)-573-9694.

Very truly yours,
BETA Group, Inc.



Jonathan Niro
Environmental Scientist

Attachments: Project Notification Form
Figure 1 – USGS Site Locus
Construction Plans
Photographic Documentation



August 5, 2022

Tribal Historic Preservation Officer
Wampanoag Tribe of Gay Head (Aquinnah)
20 Black Brook Road
Aquinnah, MA 02535

**Re: Project Notification Form
Proposed Flood Control System Along Chicopee Falls
Chicopee, Massachusetts**

Wampanoag Tribe of Gay Head Historic Preservation Officer:

As part of an ongoing effort to establish a site suitable for redevelopment, the City of Chicopee (the City) proposes improvements to several parcels along the Chicopee River. This project is the crucial first step in realizing these potential economic improvements in a former industrial area that has been dormant and drastically underutilized for decades. The enclosed project notification information (PNF) is provided for the Wampanoag Tribe of Gay Head Tribal Historic Preservation Officer's review as part of the Environmental Assessment being prepared for this work pursuant to the National Environmental Policy Act (NEPA).

The City plans to continue efforts to support the future redevelopment of a portion of the former Uniroyal complex located at 154 Grove Street and a portion of the former Facemate complex (A.K.A. "the Baskin Parcel") located at 75 West Main Street, both in Chicopee, Massachusetts (collectively referred to as "the Site"). The City proposes to accept and place contaminated fill material at the Site to facilitate future construction and redevelopment efforts consistent with local planning efforts and municipal zoning along the Chicopee River. Specifically, fill will be placed along the Chicopee Falls Local Protection Project flood control levee (the Levee) and a water intake structure and associated pumping station along the Chicopee River will be abandoned and filled (the Project). The existing undulating topography and buried/mitigated contamination currently presents development challenges; therefore, the Project will raise the Site up to approximately eight (8) feet to create a consistent development Site between elevations 98 feet and 100 feet (NAVD 88).

In order to protect the environment and the local community, the Project will implement a number of best management practices (BMPs) during construction to mitigate noise, air quality degradation, and construction-period stormwater runoff. Once fill is placed and the Site is brought to final grade, long-term stormwater management BMPs will be constructed and are anticipated to be adaptable to future development requirements. All stormwater management work will be performed at the new Site grade and any stormwater structures proposed for reuse will be retrofitted to the new target elevations to preclude the need for excavation.

As a priority Brownfields property, the Site offers a suitable location for the deposition of offsite soils with contaminant concentrations below the Reportable Concentrations specified under 310 CMR 40.0300 and 40.1600 to reduce the burden on New England landfills while supporting a crucial redevelopment effort for the City. All soil materials will be handled in accordance with the Anti-Degradation Provision of the Massachusetts Contingency Plan (MCP) at 310 CMR 40.0032(3) and are not anticipated to pose any significant risk to the future at-grade uses envisioned at the Site. The materials will also be handled in

compliance with the City's Fill Management Plan, which has been submitted to MassDEP. The City will acquire all relevant permits and approvals to ensure compliance with the applicable regulations, including obtaining coverage under the Construction General Permit (CGP) pursuant to the National Pollutant Discharge Elimination Systems (NPDES) program, obtaining coverage under the Massachusetts General Permit pursuant to the Clean Water Act, and securing an Order of Conditions from the Chicopee Conservation Commission.

The Massachusetts Historical Commission's online database was reviewed to identify any historic resources within or adjacent to the Project limits. The Massachusetts Historical Commission's online database (The Massachusetts Cultural Resource Information System - MACRIS) lists the following resources:

- CHI.K – Fisk Rubber Company Complex (Inventoried Area)
- CHI.Q – Chicopee Manufacturing Company (Inventoried Area)

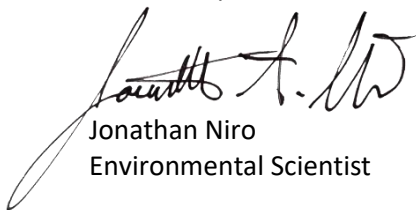
A Project Notification Form (PNF) was previously submitted to the Massachusetts Historical Commission (MHC) for the demolition of eight (8) structurally unsound buildings at the Site. The PNF was assigned MHC Project #46829 and a Memorandum of Agreement (MOA) was subsequently issued by MHC on or about April 5, 2011. Inventoried buildings identified by MHC as CHI.553, CHI.554, and CHI.555 have been demolished following the issuance of the aforementioned 2011 MOA. The following inventoried buildings remain at the Site:

- CHI.228 – Fisk Rubber Company Office – 154 Grove Street (Inventoried Building)
- CHI.556 – Fisk Rubber Company Office Building and Garage – 154 Grove Street (Inventoried Building)

The Project does not propose any impacts to CHI.228 or CHI.556.

On behalf of the City of Chicopee, BETA Group, Inc. requests that the Tribal Historic Preservation Officer review the enclosed materials at its earliest convenience and provide any comments regarding the Project. Written comments should be submitted by email to Jonathan Niro at jniro@BETA-inc.com or by mail at 89 Shrewsbury Street (Suite 300), Worcester, Massachusetts 01604. If you have any questions concerning the enclosed Project information, please feel free to contact Jonathan Niro at the provided email address or by phone at (774)-573-9694.

Very truly yours,
BETA Group, Inc.



Jonathan Niro
Environmental Scientist

Attachments: Project Notification Form
Figure 1 – USGS Site Locus
Construction Plans
Photographic Documentation



August 5, 2022

Tribal Historic Preservation Officer
Stockbridge-Munsee Mohican Tribal Historic Preservation, New York Office
65 1st Street
Troy, NY 12180

**Re: Project Notification Form
Proposed Flood Control System Along Chicopee Falls
Chicopee, Massachusetts**

Stockbridge-Munsee Mohican Tribal Historic Preservation Officer:

As part of an ongoing effort to establish a site suitable for redevelopment, the City of Chicopee (the City) proposes improvements to several parcels along the Chicopee River. This project is the crucial first step in realizing these potential economic improvements in a former industrial area that has been dormant and drastically underutilized for decades. The enclosed project notification information (PNF) is provided for the Stockbridge-Munsee Mohican Tribal Historic Preservation Officer's review as part of the Environmental Assessment being prepared for this work pursuant to the National Environmental Policy Act (NEPA).

The City plans to continue efforts to support the future redevelopment of a portion of the former Uniroyal complex located at 154 Grove Street and a portion of the former Facemate complex (A.K.A. "the Baskin Parcel") located at 75 West Main Street, both in Chicopee, Massachusetts (collectively referred to as "the Site"). The City proposes to accept and place contaminated fill material at the Site to facilitate future construction and redevelopment efforts consistent with local planning efforts and municipal zoning along the Chicopee River. Specifically, fill will be placed along the Chicopee Falls Local Protection Project flood control levee (the Levee) and a water intake structure and associated pumping station along the Chicopee River will be abandoned and filled (the Project). The existing undulating topography and buried/mitigated contamination currently presents development challenges; therefore, the Project will raise the Site up to approximately eight (8) feet to create a consistent development Site between elevations 98 feet and 100 feet (NAVD 88).

In order to protect the environment and the local community, the Project will implement a number of best management practices (BMPs) during construction to mitigate noise, air quality degradation, and construction-period stormwater runoff. Once fill is placed and the Site is brought to final grade, long-term stormwater management BMPs will be constructed and are anticipated to be adaptable to future development requirements. All stormwater management work will be performed at the new Site grade and any stormwater structures proposed for reuse will be retrofitted to the new target elevations to preclude the need for excavation.

As a priority Brownfields property, the Site offers a suitable location for the deposition of offsite soils with contaminant concentrations below the Reportable Concentrations specified under 310 CMR 40.0300 and 40.1600 to reduce the burden on New England landfills while supporting a crucial redevelopment effort for the City. All soil materials will be handled in accordance with the Anti-Degradation Provision of the Massachusetts Contingency Plan (MCP) at 310 CMR 40.0032(3) and are not anticipated to pose any significant risk to the future at-grade uses envisioned at the Site. The materials will also be handled in

compliance with the City's Fill Management Plan, which has been submitted to MassDEP. The City will acquire all relevant permits and approvals to ensure compliance with the applicable regulations, including obtaining coverage under the Construction General Permit (CGP) pursuant to the National Pollutant Discharge Elimination Systems (NPDES) program, obtaining coverage under the Massachusetts General Permit pursuant to the Clean Water Act, and securing an Order of Conditions from the Chicopee Conservation Commission.

The Massachusetts Historical Commission's online database was reviewed to identify any historic resources within or adjacent to the Project limits. The Massachusetts Historical Commission's online database (The Massachusetts Cultural Resource Information System - MACRIS) lists the following resources:

- CHI.K – Fisk Rubber Company Complex (Inventoried Area)
- CHI.Q – Chicopee Manufacturing Company (Inventoried Area)

A Project Notification Form (PNF) was previously submitted to the Massachusetts Historical Commission (MHC) for the demolition of eight (8) structurally unsound buildings at the Site. The PNF was assigned MHC Project #46829 and a Memorandum of Agreement (MOA) was subsequently issued by MHC on or about April 5, 2011. Inventoried buildings identified by MHC as CHI.553, CHI.554, and CHI.555 have been demolished following the issuance of the aforementioned 2011 MOA. The following inventoried buildings remain at the Site:

- CHI.228 – Fisk Rubber Company Office – 154 Grove Street (Inventoried Building)
- CHI.556 – Fisk Rubber Company Office Building and Garage – 154 Grove Street (Inventoried Building)

The Project does not propose any impacts to CHI.228 or CHI.556.

On behalf of the City of Chicopee, BETA Group, Inc. requests that the Tribal Historic Preservation Officer review the enclosed materials at its earliest convenience and provide any comments regarding the Project. Written comments should be submitted by email to Jonathan Niro at jniro@BETA-inc.com or by mail at 89 Shrewsbury Street (Suite 300), Worcester, Massachusetts 01604. If you have any questions concerning the enclosed Project information, please feel free to contact Jonathan Niro at the provided email address or by phone at (774)-573-9694.

Very truly yours,
BETA Group, Inc.



Jonathan Niro
Environmental Scientist

Attachments: Project Notification Form
Figure 1 – USGS Site Locus
Construction Plans
Photographic Documentation



August 5, 2022

Tribal Historic Preservation Officer
Narragansett Indian Longhouse
4425 South County Trail
Charlestown, RI 02813

**Re: Project Notification Form
Proposed Flood Control System Along Chicopee Falls
Chicopee, Massachusetts**

Narragansett Indian Longhouse Historic Preservation Officer:

As part of an ongoing effort to establish a site suitable for redevelopment, the City of Chicopee (the City) proposes improvements to several parcels along the Chicopee River. This project is the crucial first step in realizing these potential economic improvements in a former industrial area that has been dormant and drastically underutilized for decades. The enclosed project notification information (PNF) is provided for the Narragansett Indian Tribal Historic Preservation Officer's review as part of the Environmental Assessment being prepared for this work pursuant to the National Environmental Policy Act (NEPA).

The City plans to continue efforts to support the future redevelopment of a portion of the former Uniroyal complex located at 154 Grove Street and a portion of the former Facemate complex (A.K.A. "the Baskin Parcel") located at 75 West Main Street, both in Chicopee, Massachusetts (collectively referred to as "the Site"). The City proposes to accept and place contaminated fill material at the Site to facilitate future construction and redevelopment efforts consistent with local planning efforts and municipal zoning along the Chicopee River. Specifically, fill will be placed along the Chicopee Falls Local Protection Project flood control levee (the Levee) and a water intake structure and associated pumping station along the Chicopee River will be abandoned and filled (the Project). The existing undulating topography and buried/mitigated contamination currently presents development challenges; therefore, the Project will raise the Site up to approximately eight (8) feet to create a consistent development Site between elevations 98 feet and 100 feet (NAVD 88).

In order to protect the environment and the local community, the Project will implement a number of best management practices (BMPs) during construction to mitigate noise, air quality degradation, and construction-period stormwater runoff. Once fill is placed and the Site is brought to final grade, long-term stormwater management BMPs will be constructed and are anticipated to be adaptable to future development requirements. All stormwater management work will be performed at the new Site grade and any stormwater structures proposed for reuse will be retrofitted to the new target elevations to preclude the need for excavation.

As a priority Brownfields property, the Site offers a suitable location for the deposition of offsite soils with contaminant concentrations below the Reportable Concentrations specified under 310 CMR 40.0300 and 40.1600 to reduce the burden on New England landfills while supporting a crucial redevelopment effort for the City. All soil materials will be handled in accordance with the Anti-Degradation Provision of the Massachusetts Contingency Plan (MCP) at 310 CMR 40.0032(3) and are not anticipated to pose any significant risk to the future at-grade uses envisioned at the Site. The materials will also be handled in compliance with the City's Fill Management Plan, which has been submitted to MassDEP. The City will

acquire all relevant permits and approvals to ensure compliance with the applicable regulations, including obtaining coverage under the Construction General Permit (CGP) pursuant to the National Pollutant Discharge Elimination Systems (NPDES) program, obtaining coverage under the Massachusetts General Permit pursuant to the Clean Water Act, and securing an Order of Conditions from the Chicopee Conservation Commission.

The Massachusetts Historical Commission's online database was reviewed to identify any historic resources within or adjacent to the Project limits. The Massachusetts Historical Commission's online database (The Massachusetts Cultural Resource Information System - MACRIS) lists the following resources:

- CHI.K – Fisk Rubber Company Complex (Inventoried Area)
- CHI.Q – Chicopee Manufacturing Company (Inventoried Area)

A Project Notification Form (PNF) was previously submitted to the Massachusetts Historical Commission (MHC) for the demolition of eight (8) structurally unsound buildings at the Site. The PNF was assigned MHC Project #46829 and a Memorandum of Agreement (MOA) was subsequently issued by MHC on or about April 5, 2011. Inventoried buildings identified by MHC as CHI.553, CHI.554, and CHI.555 have been demolished following the issuance of the aforementioned 2011 MOA. The following inventoried buildings remain at the Site:

- CHI.228 – Fisk Rubber Company Office – 154 Grove Street (Inventoried Building)
- CHI.556 – Fisk Rubber Company Office Building and Garage – 154 Grove Street (Inventoried Building)

The Project does not propose any impacts to CHI.228 or CHI.556.

On behalf of the City of Chicopee, BETA Group, Inc. requests that the Tribal Historic Preservation Office review the enclosed materials at its earliest convenience and provide any comments regarding the Project. Written comments should be submitted by email to Jonathan Niro at jniro@BETA-inc.com or by mail at 89 Shrewsbury Street (Suite 300), Worcester, Massachusetts 01604. If you have any questions concerning the enclosed Project information, please feel free to contact Jonathan Niro at the provided email address or by phone at (774)-573-9694.

Very truly yours,
BETA Group, Inc.



Jonathan Niro
Environmental Scientist

Attachments: Project Notification Form
Figure 1 – USGS Site Locus
Construction Plans
Photographic Documentation

APPENDIX A MASSACHUSETTS HISTORICAL
COMMISSION
220 MORRISSEY
BOULEVARD BOSTON,
MASS. 02125
617-727-8470, FAX: 617-727-
5128

**PROJECT NOTIFICATION
FORM**

Project Name: Proposed Flood Control System Along Chicopee Falls

Location / Address: 154 Grove Street & 75 West Main Street

City / Town: Chicopee, Massachusetts

Project Proponent

Name: City of Chicopee

Address: 274 Front Street c/o Department of Planning and Development

City/Town/Zip/Telephone: Chicopee, Massachusetts 01013 Ph: 413-594-1516

Agency license or funding for the project (list all licenses, permits, approvals, grants or other entitlements being sought from state and federal agencies).

<u>Agency Name</u>	<u>Type of License or funding (specify)</u>
Chicopee Conservation Commission	WPA Order of Conditions
US Environmental Protection Agency/US Army Corps of Engineers	Finding of No Significant Impact – NEPA
US Army Corps of Engineers	Approval for coverage under the General Permit – Section 404
US Army Corps of Engineers	Approval for work on a flood control project – Section 408
US Environmental Protection Agency	NPDES Construction General Permit

Project Description (narrative):

The City of Chicopee plans to continue efforts to support the future redevelopment of a portion of the former Uniroyal complex located at 154 Grove Street and a portion of the former Facemate complex (A.K.A. “the Baskin Parcel”) located at 75 West Main Street, both in Chicopee, Massachusetts (collectively referred to as “the Site”). The City proposes to accept and place acceptable fill material at the Site to facilitate future construction and redevelopment efforts consistent with local planning efforts and municipal zoning along the Chicopee River. Specifically, fill will be placed along the Chicopee Falls Local Protection Project flood control levee (the Levee) and a water intake structure and associated pumping station along the Chicopee River will be abandoned and filled (the Project). The existing undulating topography and buried/mitigated contamination currently presents development challenges; therefore, the Project will raise the Site up to approximately eight (8) feet to create a consistent development Site between elevations 98 feet and 100 feet (NAVD 88).

950 CMR: OFFICE OF THE SECRETARY OF THE COMMONWEALTH

In order to protect the environment and the local community, the Project will implement a number of best management practices (BMPs) during construction to mitigate noise, air quality degradation, and construction-period stormwater runoff. Once fill is placed and the Site is brought to final grade, long-term stormwater management BMPs will be constructed and are anticipated to be adaptable to future development requirements. All stormwater management work will be performed at the new Site grade and any stormwater structures proposed for reuse will be retrofitted to the new target elevations to preclude the need for excavation.

As a priority Brownfields property, the Site offers a suitable location for the deposition of offsite soil materials with contaminant concentrations below Reportable Concentrations specified under 310 CMR 40.0300 and 40.1600 to reduce the burden on New England landfills while supporting a crucial redevelopment effort for the City. All materials will be handled in accordance with the Anti-Degradation Provision of the Massachusetts Contingency Plan (MCP) at 310 CMR 40.0032(3) and are not anticipated to pose any significant risk to the future at-grade uses expected at the Site. The materials will also be handled in compliance with the City's Fill Management Plan, which has been submitted to MassDEP. The City will acquire all relevant permits and approvals to ensure compliance with the applicable regulations, including obtaining coverage under the Construction General Permit (CGP) pursuant to the National Pollutant Discharge Elimination Systems (NPDES) program, obtaining coverage under the Massachusetts General Permit pursuant to the Clean Water Act, and securing an Order of Conditions from the Chicopee Conservation Commission.

A Project Notification Form (PNF) was previously submitted to the Massachusetts Historical Commission (MHC) for the demolition of eight (8) structurally unsound buildings at the Site. The PNF was assigned MHC Project #46829 and a Memorandum of Agreement (MOA) was entered by the City and MHC on or about April 5, 2011. The majority of the buildings subject to the 2011 PNF have been demolished as of this writing. This PNF is being submitted concurrently with ongoing National Environmental Policy Act (NEPA) coordination related to U.S. Army Corps of Engineers Section 408 approval.

Does the project include demolition? If so, specify nature of demolition and describe the building(s) which are proposed for demolition.

The Project will involve the decommissioning and demolition of the Oak Street Pump Station. Building demolition at the Site pursuant to the MOA issued by MHC has been completed with the exception of Building 15, which is to be demolished in the future under separate contract.

Does the project include rehabilitation of any existing buildings? If so, specify nature of rehabilitation and describe the building(s) which are proposed for rehabilitation.

The Project does not involve the rehabilitation of any existing buildings. The Project solely involves grading and implementation of stormwater BMPs. Any future development at the Site will be subject to a new PNF filing.

Does the project include new construction? If so, describe (attach plans and elevations if necessary).

The Project does not involve new construction, with the exception of stormwater management structures including catch basins, drainage manholes, and piping. The Project solely involves grading and implementation of stormwater BMPs. Any future development at the Site will be subject to a new PNF filing.

APPENDIX A (continued)

To the best of your knowledge, are any historic or archaeological properties known to exist within the project's area of potential impact? If so, specify.

The Project proposed work within Inventoried Areas as depicted by map data accessed through the Massachusetts Cultural Resource Information System (MACRIS) website. These properties subject to impacts by the Project include the following:

- CHI.K – Fisk Rubber Company Complex (Inventoried Area)
- CHI.Q – Chicopee Manufacturing Company (Inventoried Area)

Inventoried buildings identified by MHC as CHI.553, CHI.554, and CHI.555 have been demolished following the issuance of the aforementioned 2011 MOA. The following inventoried areas remain at the Site:

- CHI.228 – Fisk Rubber Company Office – 154 Grove Street (Inventoried Building)
- CHI.556 – Fisk Rubber Company Office Building and Garage – 154 Grove Street (Inventoried Building)

The Project does not propose any impacts to CHI.228 or CHI.556.

What is the total acreage of the project area?

Woodland	<u>0</u>	acres	Productive Resources:
Wetland	<u>0.03</u>	acres	Agriculture
Floodplain	<u>0.03</u>	acres	Forestry
Open space	<u>0</u>	acres	Mining/Extraction
Developed	<u>8.50</u>	acres	Total Project Acreage
			<u>8.53</u> acres

What is the acreage of the proposed new construction? 0 acres

The Project proposes temporary alteration to inland Waters of the US, floodplain, and developed areas.

What is the present land use of the project area?

Land use in the project area is historically industrial, consisting of several former and existing inventoried historic properties. These include the Fisk Rubber Company (CHI.K) and the Chicopee Manufacturing Company (CHI.Q) detailed above. These properties are bordered to the north by a thin strip of forested land and a levee made of modified rock fill that separates them from the Chicopee River. The River flows from north to south along the western side of the Site until its confluence with the Connecticut River.

Land use east of the Fisk Rubber Company building consists of several commercial buildings and a large area of high-density and multi-family housing. East of the Facemate Property fill area consists of other industrial properties with a large multi-family housing complex and Urban public/Institutional land at its center.

950 CMR: OFFICE OF THE SECRETARY OF THE COMMONWEALTH

Please attach a copy of the section of the USGS quadrangle map which clearly marks the project location.

See Figure 1: Site Locus – USGS Quad Map
Construction Plans
Photo Documentation

This Project Notification Form has been submitted to the MHC in compliance with 950 CMR 71.00.

Signature of Person submitting this form:  Date: August 5, 2022

Name: Jonathan Niro, Environmental Scientist, BETA Group, Inc.

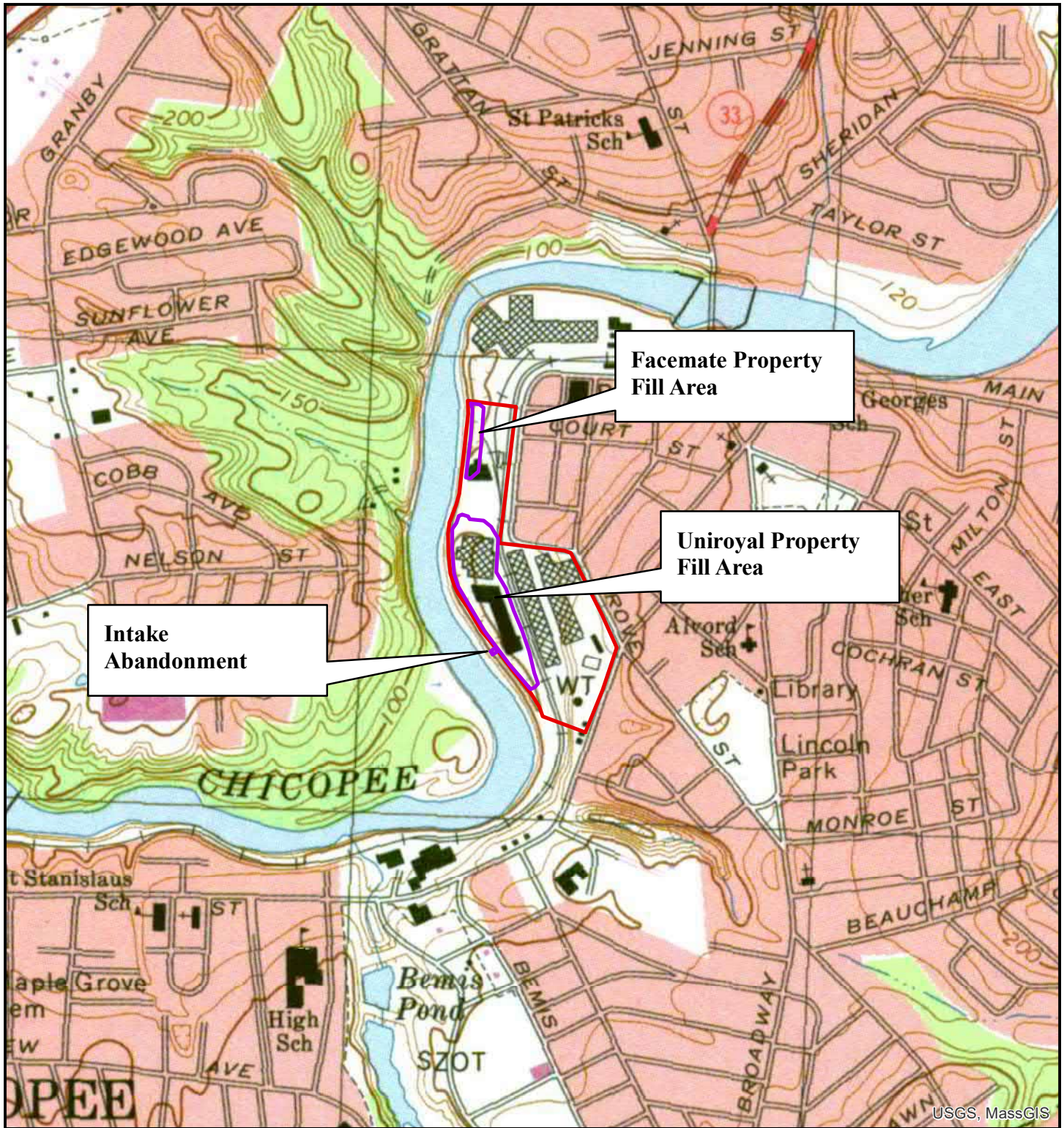
Address: 89 Shrewsbury Street, Suite 300

City/Town/Zip: Worcester, Massachusetts, 01604

Telephone: (774)-573-9694

REGULATORY AUTHORITY

950 CMR 71.00: M.G.L. c. 9, §§ 26-27C as amended by St. 1988, c. 254.

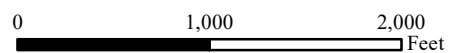
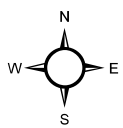


USGS, MassGIS



Legend

- Site Locus
- Work Area



1 inch = 1,000 feet

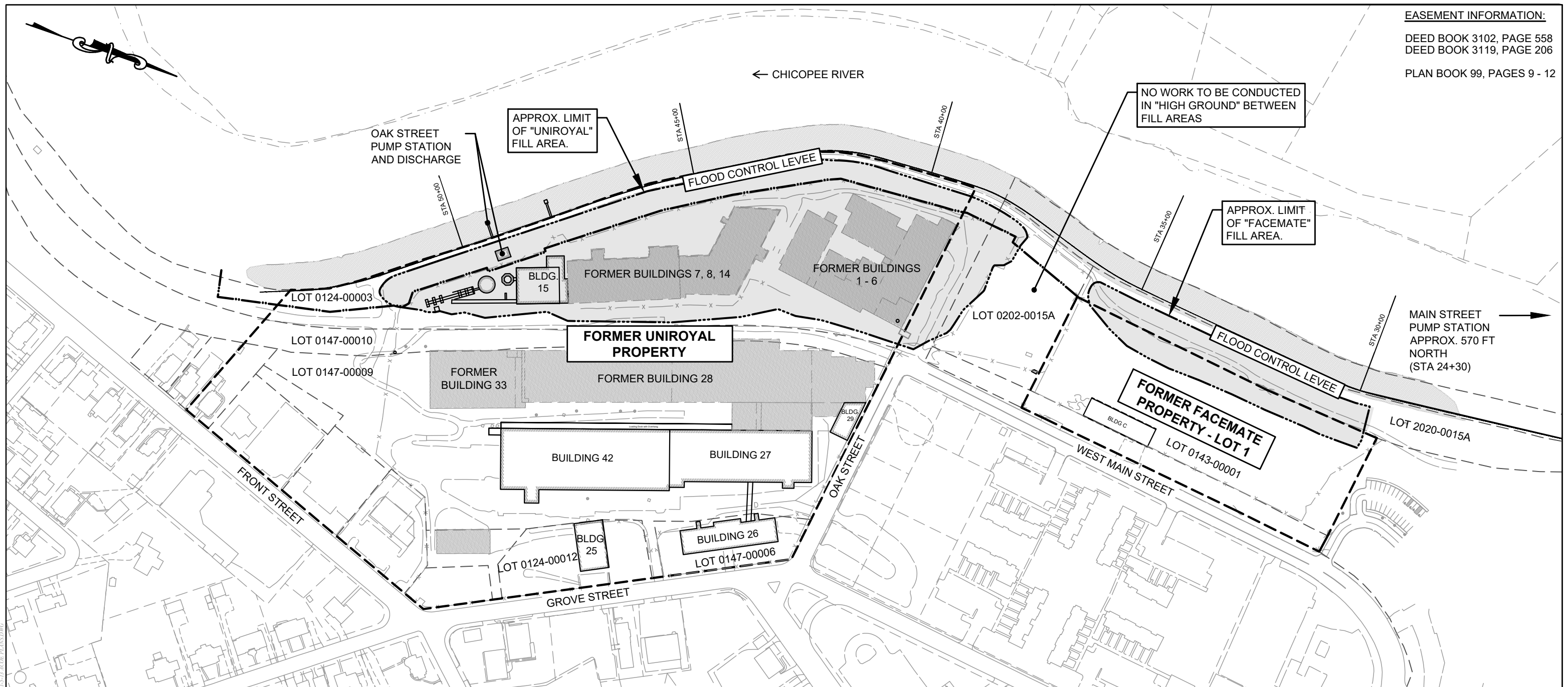
Figure 1
Site Locus - Topographic
Former Uniroyal & Facemate Properties
Chicopee, MA

Data Source: MassGIS USGS Topographic Quadrangle Images (2001)

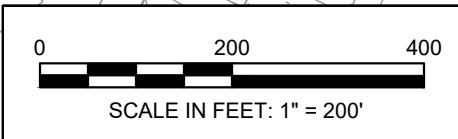
EASEMENT INFORMATION:

DEED BOOK 3102, PAGE 558
DEED BOOK 3119, PAGE 206

PLAN BOOK 99, PAGES 9 - 12



- NOTES:**
1. REFERENCE IS MADE TO THE ORIGINAL FLOOD CONTROL DESIGN PLANS ENTITLED "CHICOPEE RIVER FLOOD CONTROL - CHICOPEE FALLS" DATED APRIL, 1963, PREPARED BY GREEN ENGINEERING AFFILIATES, INC. AND THE U.S. ARMY ENGINEER DIVISION, NEW ENGLAND CORPS OF ENGINEERS.
 2. COORDINATES, IN FEET, ARE BASED UPON THE NORTH AMERICAN DATUM OF 1983 (NAD 83). THE VERTICAL DATUM IS REFERENCED TO THE NORTH AMERICAN VERTICAL DATUM OF 1988 (NAVD 88).
 3. THE NAVD88 ELEVATIONS ARE APPROXIMATELY 0.708 FT LOWER THAN THE NGVD29 ELEVATIONS USED IN THE ORIGINAL FLOOD CONTROL DESIGN PLANS, BASED ON AN ANALYSIS PERFORMED BY CIVILVIEW, INC.
 4. EXISTING CONDITIONS INFORMATION OBTAINED VIA:
 - AERIAL AND ON-THE-GROUND SURVEY COMPLETED BY CIVIL DESIGN CONSULTANTS, INC. IN DECEMBER OF 2018 AND 2019.
 - PLAN ENTITLED "CHICOPEE RIVER FLOOD CONTROL CHICOPEE FALLS" BY HERITAGE SURVEYS IN MARCH OF 2014
 - PLANIMETRIC AND TOPOGRAPH DATASET PROVIDED BY INFOTECH, INC. IN JANUARY OF 2010.
 - PLAN OF LAND COMPLETED BY DURKEE, WHITE, TOWNE, AND CHAPDELAIN IN 2012.
 - FIELD OBSERVATIONS AND ON-THE-GROUND SURVEY BY BETA GROUP, INC FROM 2016 TO 2021.



LEGEND

	EXISTING SITE BUILDING
	BUILDING DEMOLISHED AS OF JULY 2020
	PROPERTY LINE
	APPROX. LIMIT OF CHICOPEE RIVER
	APPROX. LIMIT OF ACOE PARCEL (TRACT R8)
	PROPOSED FILL AREA



Former Uniroyal & Facemate Properties
 ACOE Permit Review Only
 154 Grove Street & 75 West Main Street
 Chicopee, MA

Issue Date: 5-13-2021

Figure No. 3
Overall Site Plan

DESCRIPTION OF DRAINAGE SYSTEMS:

SYSTEM A: COLLECTS RUNOFF FROM UPPER PORTIONS OF SITE AND BUILDING 42 FOR DISCHARGE TO SOUTH OUTFALL. NO ALTERATIONS PROPOSED.

SYSTEM B: COLLECTS RUNOFF FROM BUILDINGS 26 AND 27 FOR DISCHARGE TO SYSTEM C. NO ALTERATIONS PROPOSED.

SYSTEM C: INTERCEPTOR DRAIN AND CATCH BASIN SYSTEM FOR COLLECTION OF RUNOFF BEHIND DIKE. CURRENTLY CONVEYED TO OAK STREET PUMP STATION FOR DISCHARGE INTO CHICOPEE RIVER. SYSTEM TO BE ALTERED. REFER TO FIGURE 11.

AREA BEHIND LEVEE TO BE BACKFILLED. REFER TO FIGURES 5 AND 6 FOR PROPOSED GRADING & DRAINAGE PLAN.

OAK STREET PUMP STATION AND DISCHARGE STRUCTURE TO BE DECOMMISSIONED. SEE FIGURE 11

BUILDING 15 TO BE DEMOLISHED

EXISTING UTILITY POLE WITH OVERHEAD ELECTRIC LINES TO BE REMOVED FROM FILL AREA (TYP.)

EXISTING DRAINAGE STRUCTURES AND INTERCEPTOR/TOE DRAINS. SEE "SYSTEM C" DESCRIPTION.

EXISTING "SOUTH OUTFALL" TO REMAIN

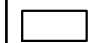

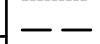
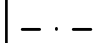
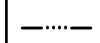
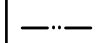
200' RIVERFRONT AREA (TYP.)

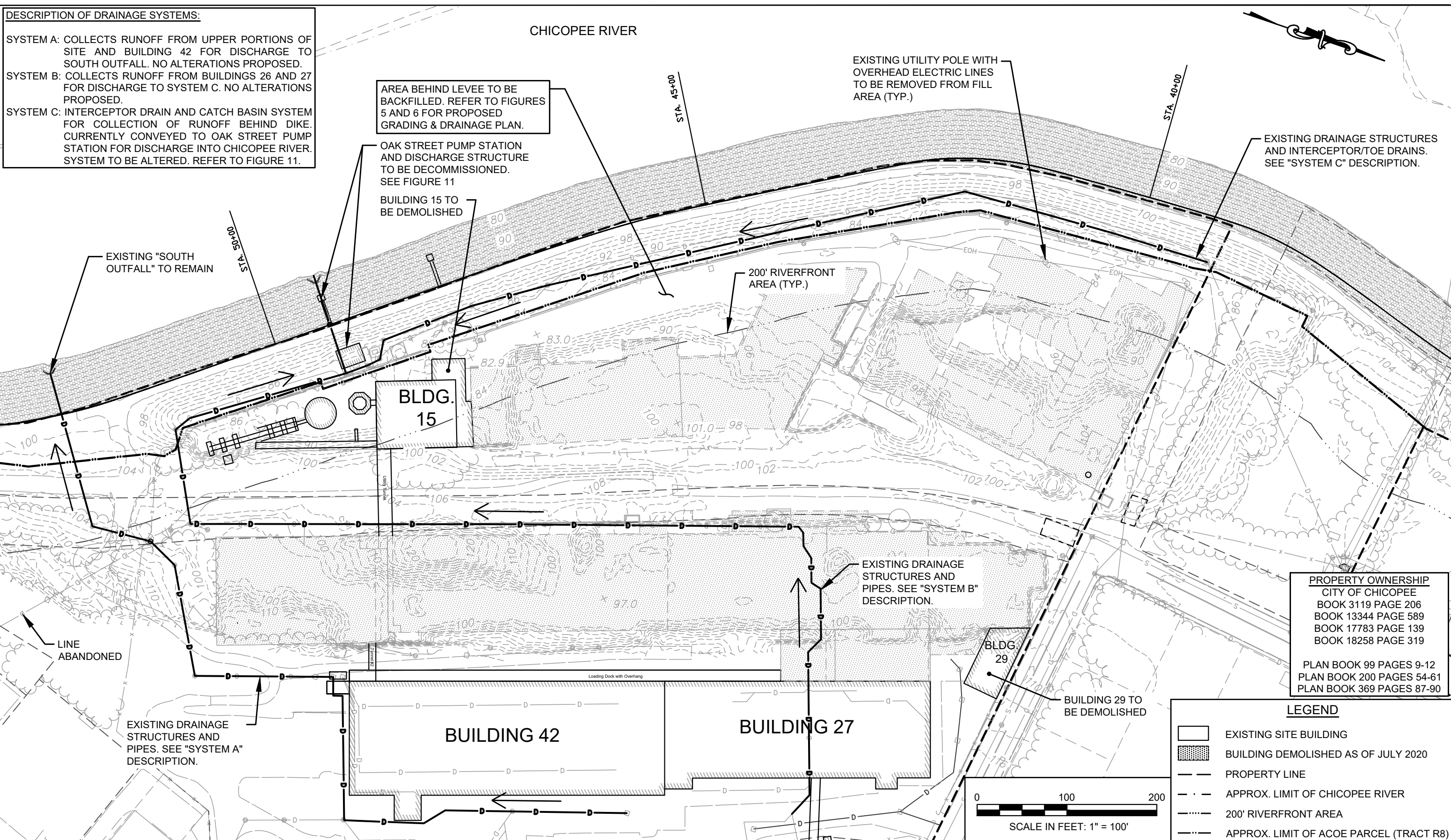
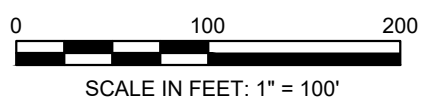
EXISTING DRAINAGE STRUCTURES AND PIPES. SEE "SYSTEM B" DESCRIPTION.

PROPERTY OWNERSHIP
 CITY OF CHICOPEE
 BOOK 3119 PAGE 206
 BOOK 13344 PAGE 589
 BOOK 17783 PAGE 139
 BOOK 18258 PAGE 319

PLAN BOOK 99 PAGES 9-12
 PLAN BOOK 200 PAGES 54-61
 PLAN BOOK 369 PAGES 87-90

LEGEND

-  EXISTING SITE BUILDING
-  BUILDING DEMOLISHED AS OF JULY 2020
-  PROPERTY LINE
-  APPROX. LIMIT OF CHICOPEE RIVER
-  200' RIVERFRONT AREA
-  APPROX. LIMIT OF ACOE PARCEL (TRACT R8)



Former Uniroyal & Facemate Properties

ACOE Permit Review Only
 154 Grove Street & 75 West Main Street
 Chicopee, MA

Issue Date: 5-13-2021

Figure No. 4

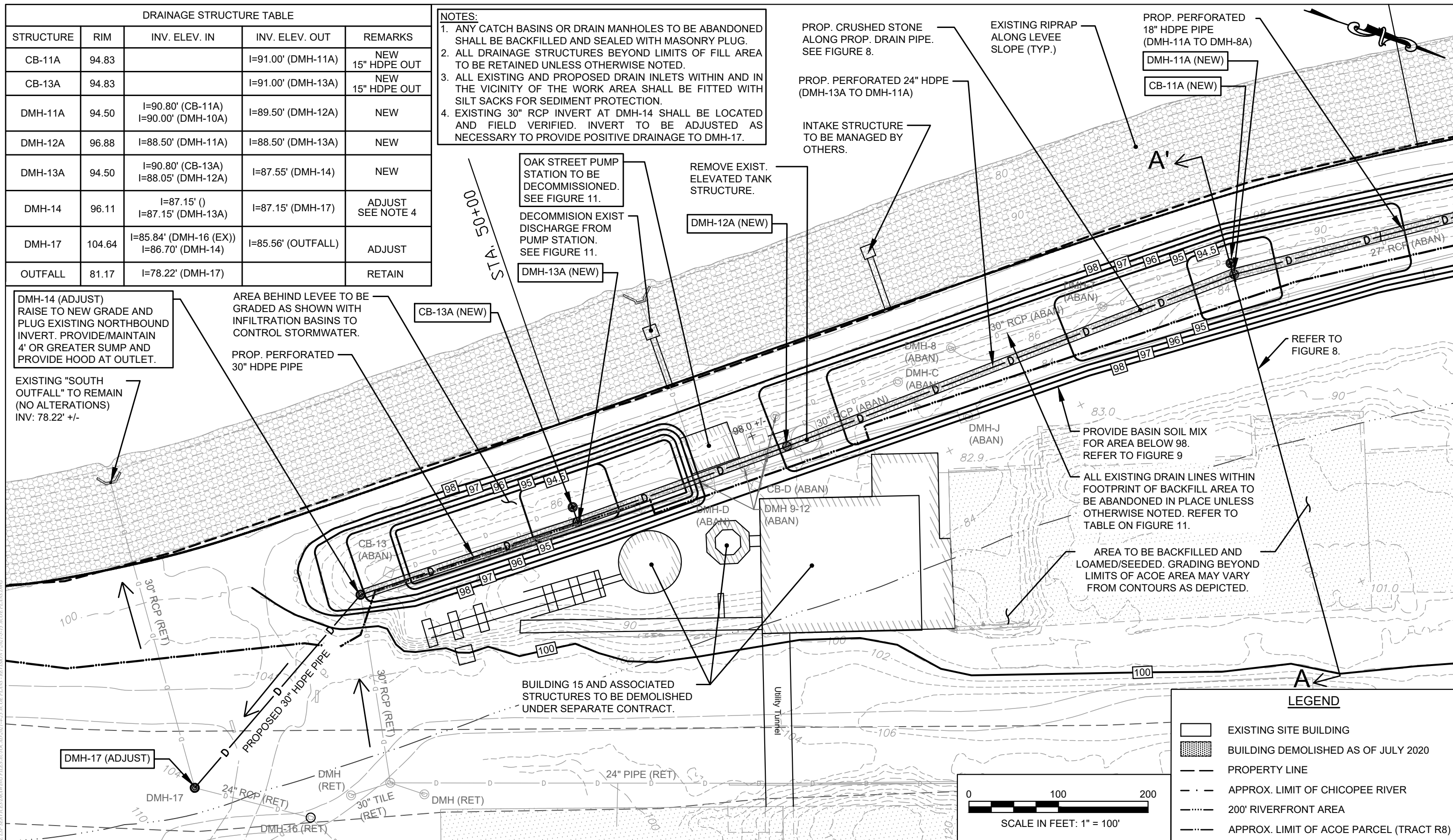
**Existing Drainage Plan
 Uniroyal Property**



C:\STARCH\300 - CHICOPEE - UNIROYAL - ACOE PERMIT REVIEW\DRAWING FILES\DWG\300-4-13-2021-ACOE PLAN - UNIROYAL\300-4-13-2021-ACOE PERMIT REVIEW.DWG

DRAINAGE STRUCTURE TABLE				
STRUCTURE	RIM	INV. ELEV. IN	INV. ELEV. OUT	REMARKS
CB-11A	94.83		I=91.00' (DMH-11A)	NEW 15" HDPE OUT
CB-13A	94.83		I=91.00' (DMH-13A)	NEW 15" HDPE OUT
DMH-11A	94.50	I=90.80' (CB-11A) I=90.00' (DMH-10A)	I=89.50' (DMH-12A)	NEW
DMH-12A	96.88	I=88.50' (DMH-11A)	I=88.50' (DMH-13A)	NEW
DMH-13A	94.50	I=90.80' (CB-13A) I=88.05' (DMH-12A)	I=87.55' (DMH-14)	NEW
DMH-14	96.11	I=87.15' () I=87.15' (DMH-13A)	I=87.15' (DMH-17)	ADJUST SEE NOTE 4
DMH-17	104.64	I=85.84' (DMH-16 (EX)) I=86.70' (DMH-14)	I=85.56' (OUTFALL)	ADJUST
OUTFALL	81.17	I=78.22' (DMH-17)		RETAIN

- NOTES:**
1. ANY CATCH BASINS OR DRAIN MANHOLES TO BE ABANDONED SHALL BE BACKFILLED AND SEALED WITH MASONRY PLUG.
 2. ALL DRAINAGE STRUCTURES BEYOND LIMITS OF FILL AREA TO BE RETAINED UNLESS OTHERWISE NOTED.
 3. ALL EXISTING AND PROPOSED DRAIN INLETS WITHIN AND IN THE VICINITY OF THE WORK AREA SHALL BE FITTED WITH SILT SACKS FOR SEDIMENT PROTECTION.
 4. EXISTING 30" RCP INVERT AT DMH-14 SHALL BE LOCATED AND FIELD VERIFIED. INVERT TO BE ADJUSTED AS NECESSARY TO PROVIDE POSITIVE DRAINAGE TO DMH-17.



DMH-14 (ADJUST)
RAISE TO NEW GRADE AND
PLUG EXISTING NORTHBOUND
INVERT. PROVIDE/MAINTAIN
4' OR GREATER SUMP AND
PROVIDE HOOD AT OUTLET.

EXISTING "SOUTH
OUTFALL" TO REMAIN
(NO ALTERATIONS)
INV: 78.22' +/-

AREA BEHIND LEVEE TO BE
GRADED AS SHOWN WITH
INFILTRATION BASINS TO
CONTROL STORMWATER.

PROP. PERFORATED
30" HDPE PIPE

OAK STREET PUMP
STATION TO BE
DECOMMISSIONED.
SEE FIGURE 11.

DECOMMISSION EXIST
DISCHARGE FROM
PUMP STATION.
SEE FIGURE 11.

REMOVE EXIST.
ELEVATED TANK
STRUCTURE.

PROP. CRUSHED STONE
ALONG PROP. DRAIN PIPE.
SEE FIGURE 8.

PROP. PERFORATED 24" HDPE
(DMH-13A TO DMH-11A)

INTAKE STRUCTURE
TO BE MANAGED BY
OTHERS.

EXISTING RIPRAP
ALONG LEVEE
SLOPE (TYP.)

PROP. PERFORATED
18" HDPE PIPE
(DMH-11A TO DMH-8A)

DMH-11A (NEW)

CB-11A (NEW)

PROVIDE BASIN SOIL MIX
FOR AREA BELOW 98.
REFER TO FIGURE 9

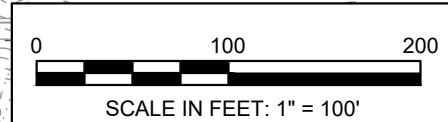
ALL EXISTING DRAIN LINES WITHIN
FOOTPRINT OF BACKFILL AREA TO
BE ABANDONED IN PLACE UNLESS
OTHERWISE NOTED. REFER TO
TABLE ON FIGURE 11.

AREA TO BE BACKFILLED AND
LOAMED/SEEDED. GRADING BEYOND
LIMITS OF ACOE AREA MAY VARY
FROM CONTOURS AS DEPICTED.

BUILDING 15 AND ASSOCIATED
STRUCTURES TO BE DEMOLISHED
UNDER SEPARATE CONTRACT.

LEGEND

- EXISTING SITE BUILDING
- BUILDING DEMOLISHED AS OF JULY 2020
- PROPERTY LINE
- APPROX. LIMIT OF CHICOPEE RIVER
- 200' RIVERFRONT AREA
- APPROX. LIMIT OF ACOE PARCEL (TRACT R8)



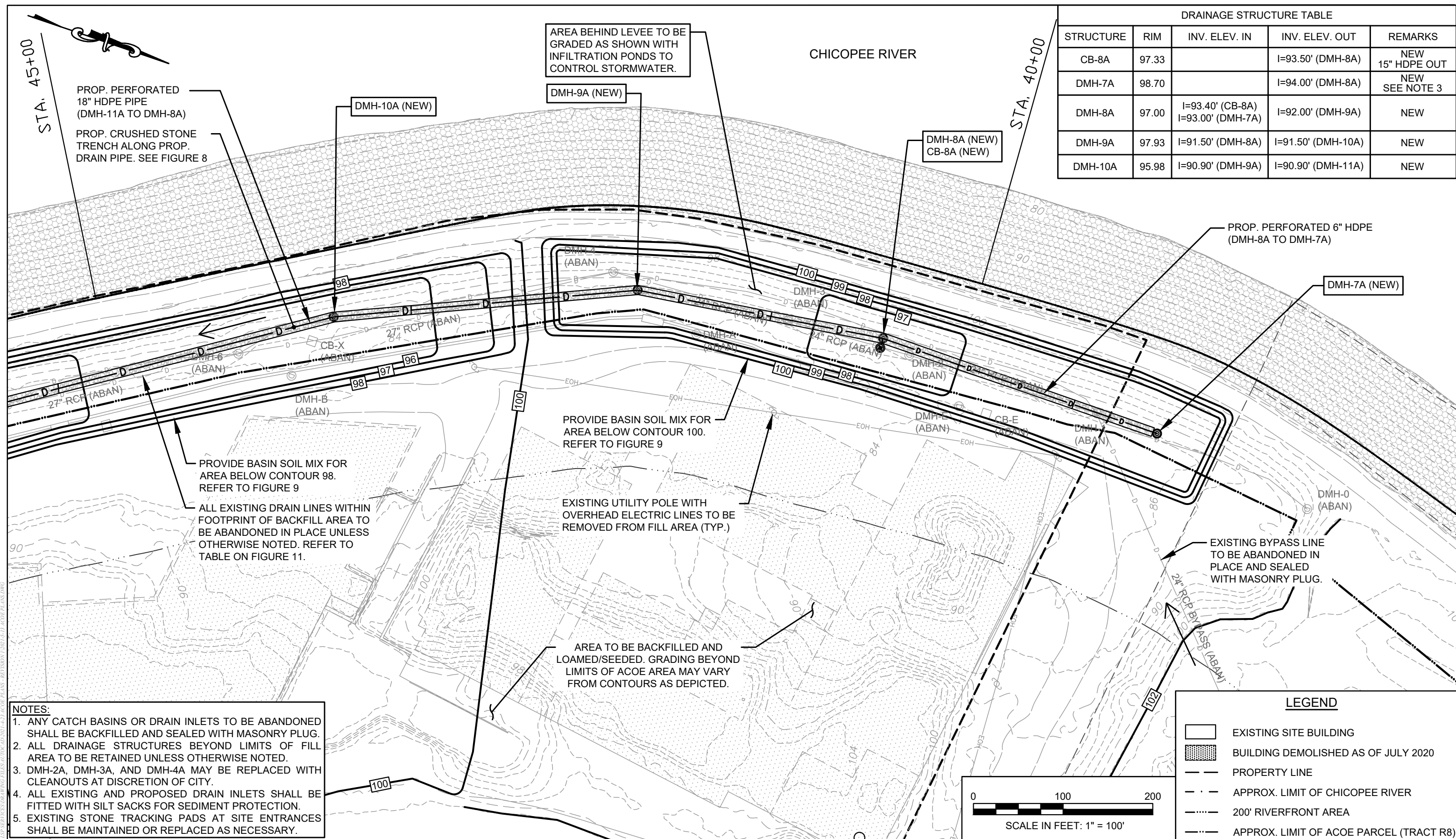
Former Uniroyal & Facemate Properties

ACOE Permit Review Only
154 Grove Street & 75 West Main Street
Chicopee, MA

Issue Date: 5-13-2021

Figure No. 5

**Enlarged Grading & Drainage Plan I
Uniroyal Property**



DRAINAGE STRUCTURE TABLE				
STRUCTURE	RIM	INV. ELEV. IN	INV. ELEV. OUT	REMARKS
CB-8A	97.33		I=93.50' (DMH-8A)	NEW 15" HDPE OUT
DMH-7A	98.70		I=94.00' (DMH-8A)	NEW SEE NOTE 3
DMH-8A	97.00	I=93.40' (CB-8A) I=93.00' (DMH-7A)	I=92.00' (DMH-9A)	NEW
DMH-9A	97.93	I=91.50' (DMH-8A)	I=91.50' (DMH-10A)	NEW
DMH-10A	95.98	I=90.90' (DMH-9A)	I=90.90' (DMH-11A)	NEW

AREA BEHIND LEVEE TO BE GRADED AS SHOWN WITH INFILTRATION PONDS TO CONTROL STORMWATER.

PROP. PERFORATED 18" HDPE PIPE (DMH-11A TO DMH-8A)
PROP. CRUSHED STONE TRENCH ALONG PROP. DRAIN PIPE. SEE FIGURE 8

PROVIDE BASIN SOIL MIX FOR AREA BELOW CONTOUR 98. REFER TO FIGURE 9
ALL EXISTING DRAIN LINES WITHIN FOOTPRINT OF BACKFILL AREA TO BE ABANDONED IN PLACE UNLESS OTHERWISE NOTED. REFER TO TABLE ON FIGURE 11.

PROVIDE BASIN SOIL MIX FOR AREA BELOW CONTOUR 100. REFER TO FIGURE 9

EXISTING UTILITY POLE WITH OVERHEAD ELECTRIC LINES TO BE REMOVED FROM FILL AREA (TYP.)

AREA TO BE BACKFILLED AND LOAMED/SEEDED. GRADING BEYOND LIMITS OF ACOE AREA MAY VARY FROM CONTOURS AS DEPICTED.

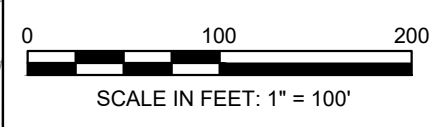
PROP. PERFORATED 6" HDPE (DMH-8A TO DMH-7A)

EXISTING BYPASS LINE TO BE ABANDONED IN PLACE AND SEALED WITH MASONRY PLUG.

- NOTES:**
1. ANY CATCH BASINS OR DRAIN INLETS TO BE ABANDONED SHALL BE BACKFILLED AND SEALED WITH MASONRY PLUG.
 2. ALL DRAINAGE STRUCTURES BEYOND LIMITS OF FILL AREA TO BE RETAINED UNLESS OTHERWISE NOTED.
 3. DMH-2A, DMH-3A, AND DMH-4A MAY BE REPLACED WITH CLEANOUTS AT DISCRETION OF CITY.
 4. ALL EXISTING AND PROPOSED DRAIN INLETS SHALL BE FITTED WITH SILT SACKS FOR SEDIMENT PROTECTION.
 5. EXISTING STONE TRACKING PADS AT SITE ENTRANCES SHALL BE MAINTAINED OR REPLACED AS NECESSARY.

LEGEND

- EXISTING SITE BUILDING
- BUILDING DEMOLISHED AS OF JULY 2020
- PROPERTY LINE
- APPROX. LIMIT OF CHICOPEE RIVER
- 200' RIVERFRONT AREA
- APPROX. LIMIT OF ACOE PARCEL (TRACT R8)



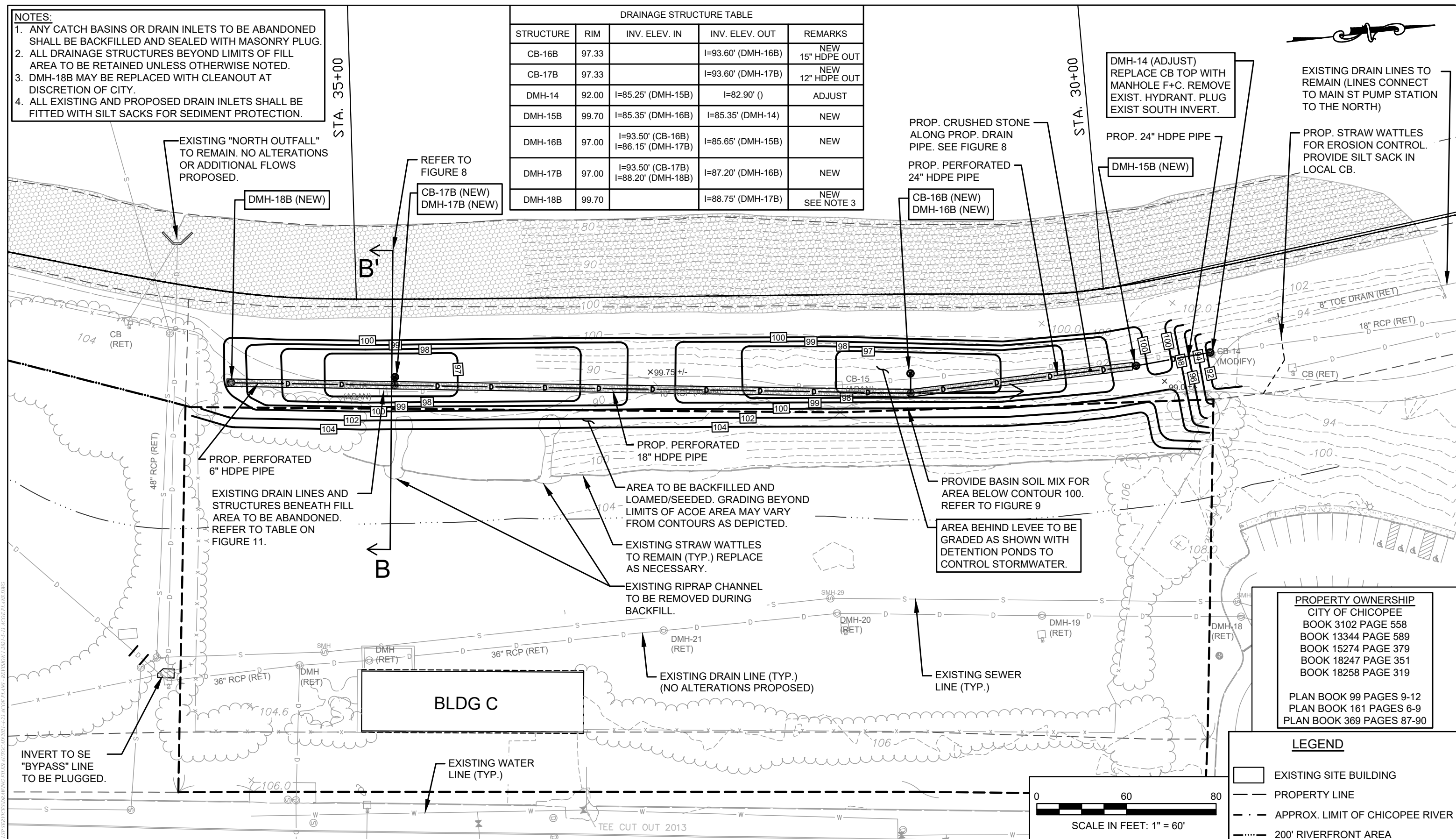
Former Uniroyal & Facemate Properties
 ACOE Permit Review Only
 154 Grove Street & 75 West Main Street
 Chicopee, MA

Issue Date: 5-13-2021

Figure No. 6
Enlarged Grading & Drainage Plan II
Uniroyal Property

- NOTES:**
1. ANY CATCH BASINS OR DRAIN INLETS TO BE ABANDONED SHALL BE BACKFILLED AND SEALED WITH MASONRY PLUG.
 2. ALL DRAINAGE STRUCTURES BEYOND LIMITS OF FILL AREA TO BE RETAINED UNLESS OTHERWISE NOTED.
 3. DMH-18B MAY BE REPLACED WITH CLEANOUT AT DISCRETION OF CITY.
 4. ALL EXISTING AND PROPOSED DRAIN INLETS SHALL BE FITTED WITH SILT SACKS FOR SEDIMENT PROTECTION.

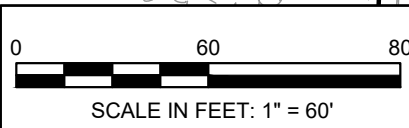
DRAINAGE STRUCTURE TABLE				
STRUCTURE	RIM	INV. ELEV. IN	INV. ELEV. OUT	REMARKS
CB-16B	97.33		I=93.60' (DMH-16B)	NEW 15" HDPE OUT
CB-17B	97.33		I=93.60' (DMH-17B)	NEW 12" HDPE OUT
DMH-14	92.00	I=85.25' (DMH-15B)	I=82.90' ()	ADJUST
DMH-15B	99.70	I=85.35' (DMH-16B)	I=85.35' (DMH-14)	NEW
DMH-16B	97.00	I=93.50' (CB-16B) I=86.15' (DMH-17B)	I=85.65' (DMH-15B)	NEW
DMH-17B	97.00	I=93.50' (CB-17B) I=88.20' (DMH-18B)	I=87.20' (DMH-16B)	NEW
DMH-18B	99.70		I=88.75' (DMH-17B)	NEW SEE NOTE 3



PROPERTY OWNERSHIP
 CITY OF CHICOPEE
 BOOK 3102 PAGE 558
 BOOK 13344 PAGE 589
 BOOK 15274 PAGE 379
 BOOK 18247 PAGE 351
 BOOK 18258 PAGE 319

 PLAN BOOK 99 PAGES 9-12
 PLAN BOOK 161 PAGES 6-9
 PLAN BOOK 369 PAGES 87-90

- LEGEND**
- EXISTING SITE BUILDING
 - PROPERTY LINE
 - APPROX. LIMIT OF CHICOPEE RIVER
 - 200' RIVERFRONT AREA

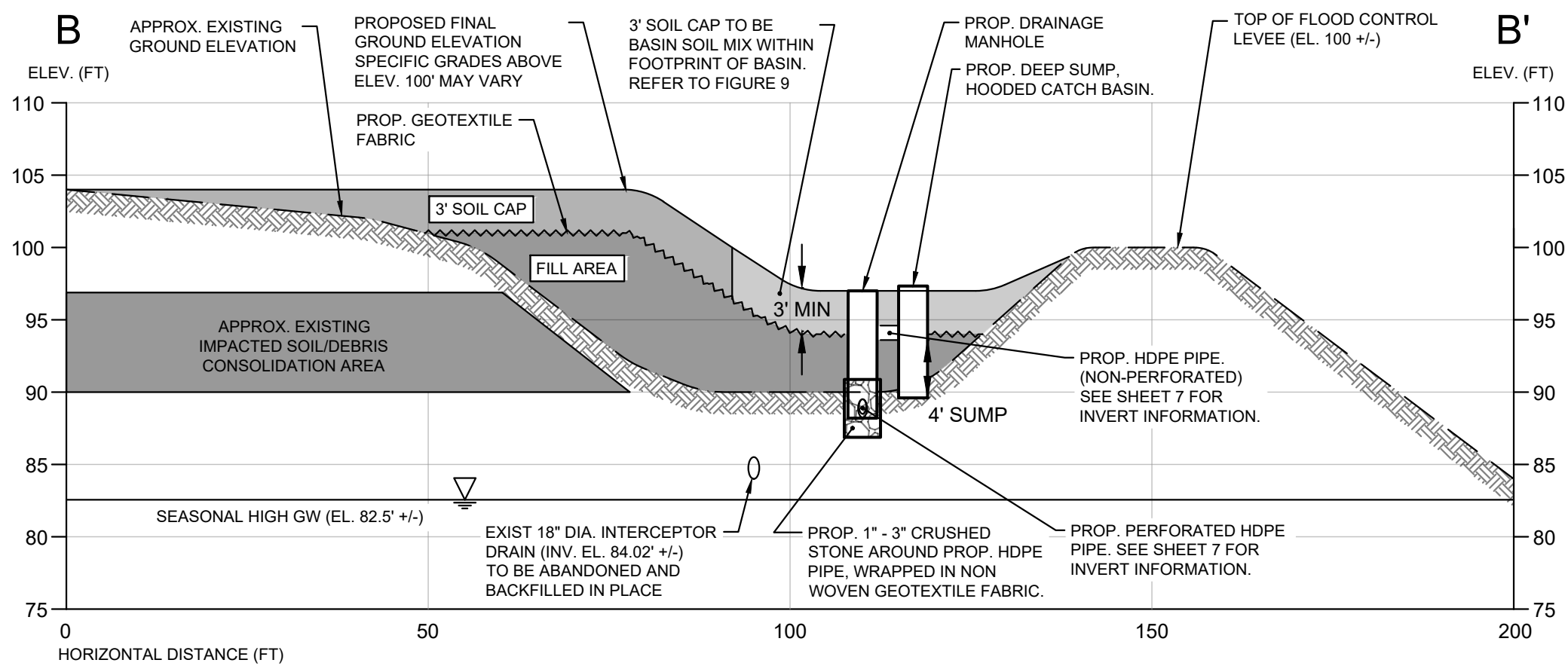
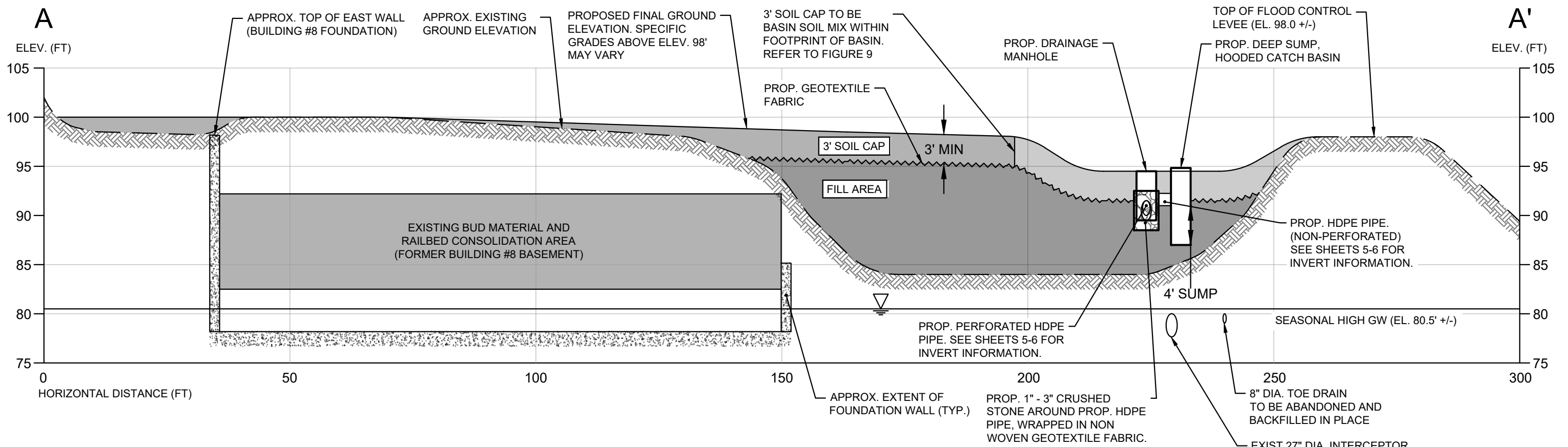


Former Uniroyal & Facemate Properties
 ACOE Permit Review Only
 75 West Main Street
 Chicopee, MA

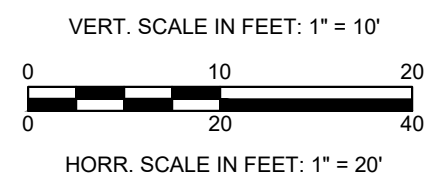


Figure No. 7
Grading & Drainage Plan
Facemate Property

Issue Date: 5-13-2021



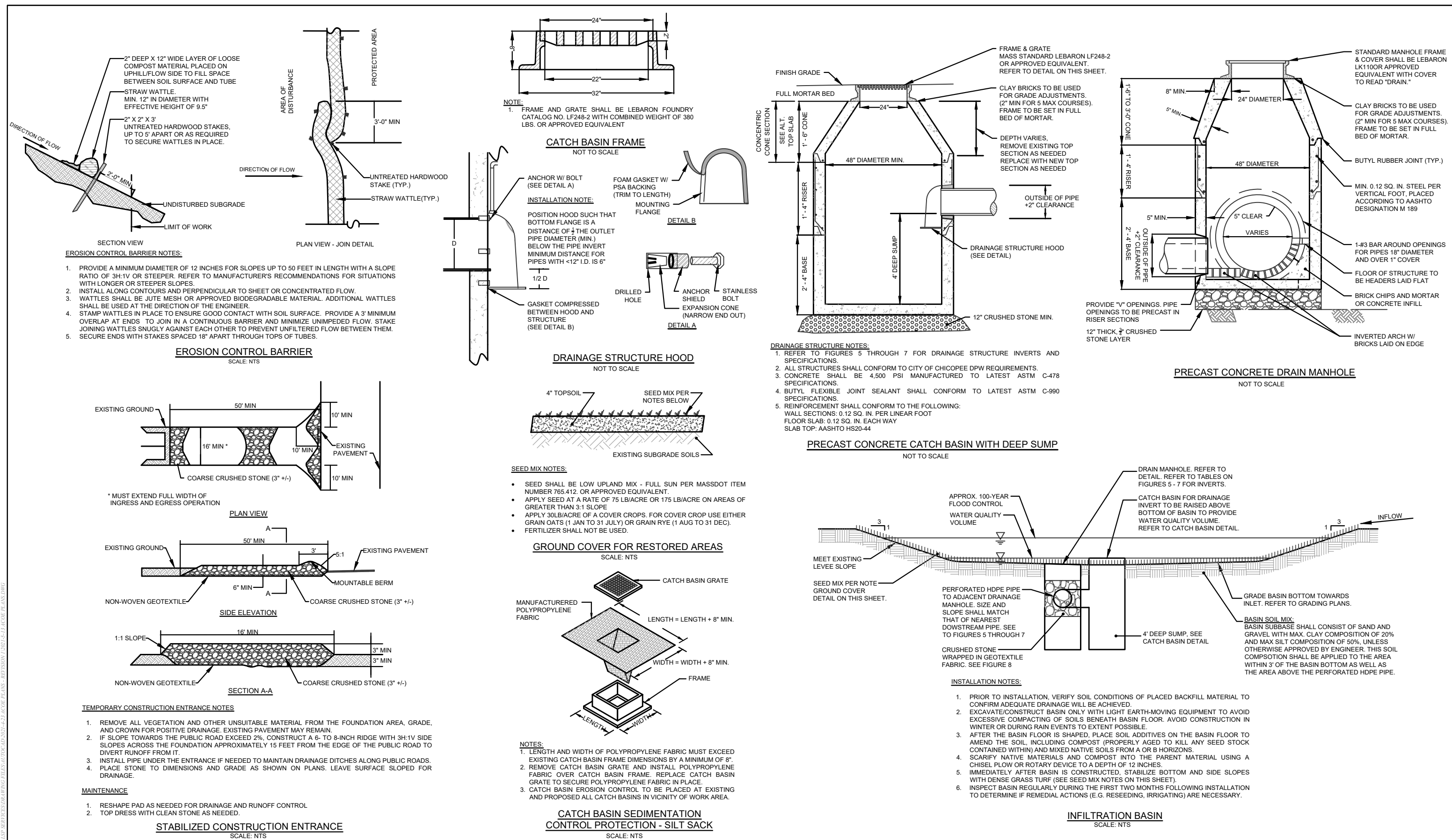
- NOTES:**
- COORDINATES, IN FEET, ARE BASED UPON THE NORTH AMERICAN DATUM OF 1983 (NAD 83). THE VERTICAL DATUM IS REFERENCED TO THE NORTH AMERICAN VERTICAL DATUM OF 1988 (NAVD 88).
 - EXISTING PIPE INFORMATION BASED ON PLAN TITLED "CHICOPEE RIVER FLOOD CONTROL CHICOPEE FALLS" PREPARED BY US ARMY CORPS OF ENGINEERS, DATED DECEMBER 1962. ELEVATIONS TO BE CONFIRMED DURING CONSTRUCTION.
 - REFER TO FIGURE 3 FOR SOURCE OF EXISTING TOPOGRAPHY DATA
 - REFER TO FIGURES 5 AND 7 FOR LOCATIONS OF CROSS SECTIONS.
 - PROPOSED CRUSHED STONE AND BACKFILL DESIGN SHALL BE IN ACCORDANCE WITH GEOTECHNICAL ENGINEERING REPORT PREPARED FOR THIS PROJECT OR AN EQUIVALENT DESIGN REVIEWED BY A GEOTECHNICAL ENGINEER.



Former Uniroyal & Facemate Properties
 ACOE Permit Review Only
 154 Grove Street & 75 West Main Street
 Chicopee, MA

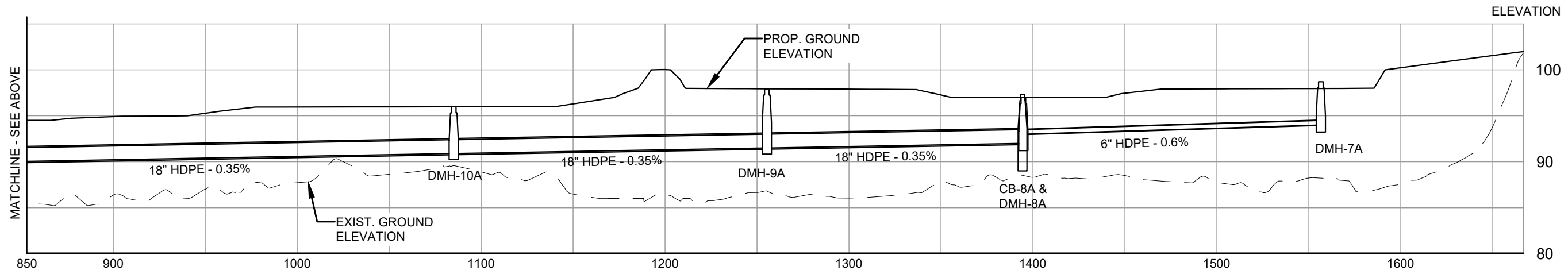
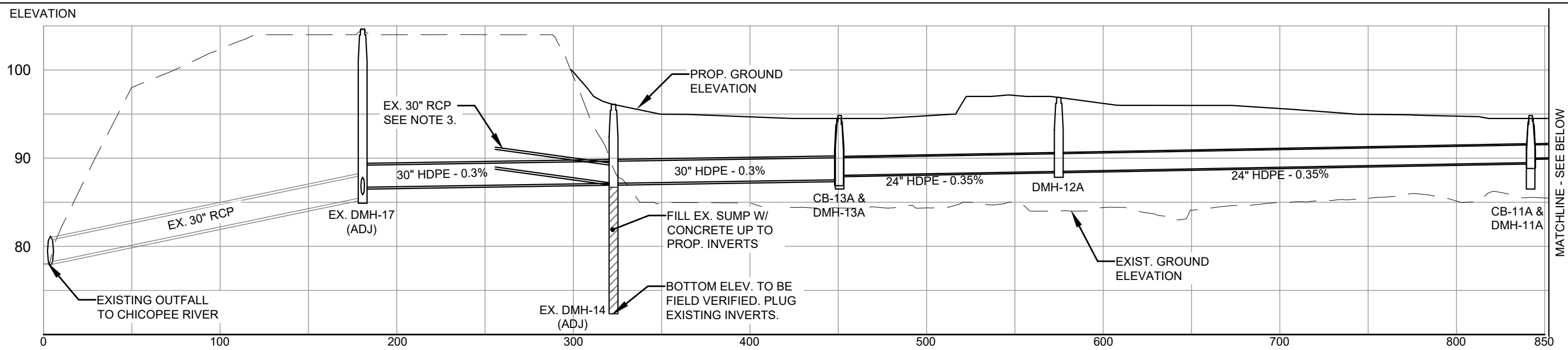
Issue Date: 5-13-2021

Figure No. 8
Cross Sections

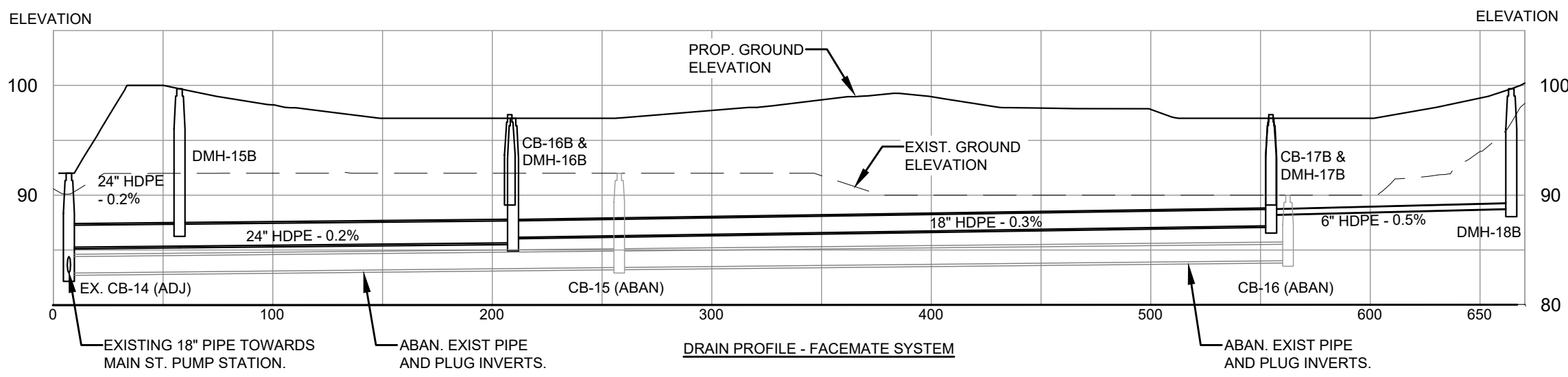


Former Uniroyal & Facemate Properties
ACOE Permit Review Only
154 Grove Street & 75 West Main Street
Chicopee, MA
Issue Date: 5-13-2021

Figure No. 9
Details

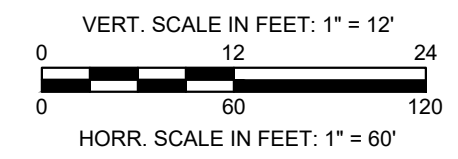


DRAIN PROFILE - UNIROYAL SYSTEM



DRAIN PROFILE - FACEMATE SYSTEM

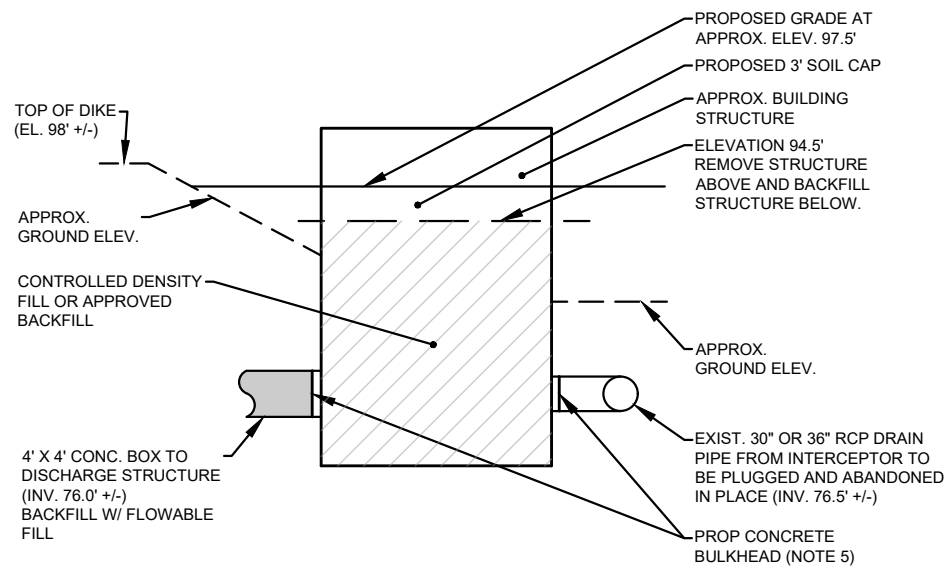
- NOTES:**
1. REFER TO FIGURES 5 THROUGH 7 FOR DRAINAGE STRUCTURE SCHEDULE AND FIGURE 9 FOR DETAILS.
 2. STRUCTURE SUMP ELEVATIONS MAY DIFFER FROM THOSE SHOWN. REFER TO DETAIL ON FIGURE 9.
 3. EXISTING 30" RCP INVERT AT DMH-14 SHALL BE LOCATED AND FIELD VERIFIED. INVERT TO BE ADJUSTED AS NECESSARY TO PROVIDE POSITIVE DRAINAGE TO DMH-17.
 4. LISTED PIPE SLOPES ARE APPROXIMATE. REFER TO INVERTS ON DRAINAGE STRUCTURE SCHEDULES.
 5. ALL PIPES SHALL BE PERFORATED UNLESS OTHERWISE NOTED IN THIS PLANSET.



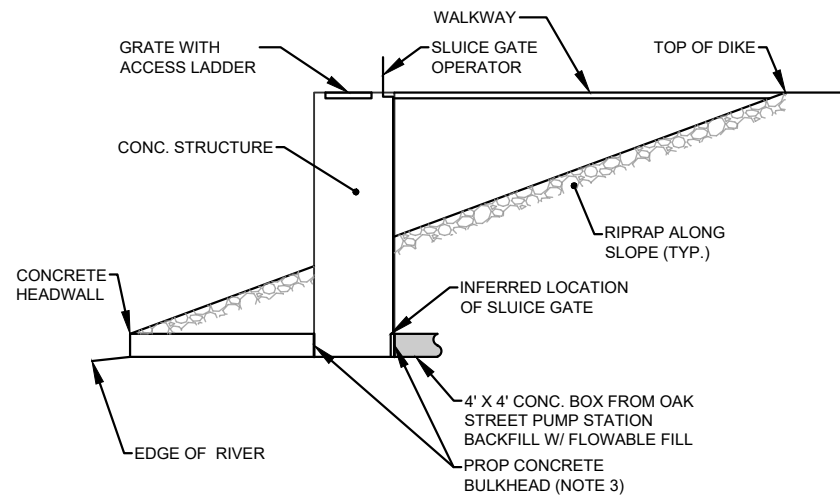
Former Uniroyal & Facemate Properties
 ACOE Permit Review Only
 154 Grove Street & 75 West Main Street
 Chicopee, MA

Issue Date: 5-13-2021

Figure No. 10
Drainage Profile



DECOMMISSIONING OF OAK ST. PUMP STATION
NOT TO SCALE



DECOMMISSIONING OF OAK ST. PUMP STATION DISCHARGE STRUCTURE
NOT TO SCALE

GENERAL SEQUENCE OF WORK - PUMP STATION

1. ENSURE EROSION CONTROLS ARE PLACED IN ALL NEARBY DRAIN INLETS.
2. DISMANTLE AND REMOVE ALL EXISTING ELECTRICAL CONNECTIONS AND UTILITIES, INCLUDING ABOVE-GROUND TANK AND ASSOCIATED FENCING.
3. DISMANTLE AND REMOVE ALL EQUIPMENT WITHIN THE PUMP STATION TO BE PRESERVED OR DISCARDED.
4. DEWATER STRUCTURE AS NEEDED AND INSTALL TEMPORARY MEASURES TO PREVENT WATER FROM ENTERING STRUCTURE.
5. INSTALL CONCRETE BULKHEAD AT ALL DISCHARGE AND INTERCEPTOR DRAIN PIPES.
6. DEMOLISH EXISTING PUMP STATION ROOF AND BUILDING WALLS TO AT LEAST 3' BELOW PROPOSED GRADE (TO APPROX. ELEV. 94.5')
7. DEMOLISH ELEVATED TANK STRUCTURE LOCATED TO THE NORTH OF THE PUMP STATION. LOWER ASSOCIATED CONCRETE FOOTINGS TO AT LEAST 3' BELOW PROPOSED GRADE.
8. BACKFILL REMAINING PUMP STATION WITH CONTROLLED DENSITY FILL OR APPROVED BACKFILL.
9. ABANDON REMAINING PUMP STATION STRUCTURE IN PLACE AND BACKFILL IN ACCORDANCE WITH FILL MANAGEMENT PLAN, INCLUDING LAYER OF GEOTEXTILE FABRIC AND AT LEAST 3' OF CLEAN FILL WHERE NECESSARY.

NOTES:

1. INTERIOR OF STRUCTURE IS APPROXIMATE ONLY BASED ON LIMITED VISUAL OBSERVATIONS AND RECORD PLANS. ACTUAL LAYOUT MAY VARY.

GENERAL SEQUENCE OF WORK - DISCHARGE STRUCTURE

1. DEWATER STRUCTURE AS NEEDED AND INSTALL TEMPORARY MEASURES TO PREVENT WATER FROM ENTERING STRUCTURE.
2. REMOVE SLUDGE GATE AND SEAL BOTTOM PORTION OF STRUCTURE WITH CONCRETE BULKHEAD TO BLOCK FLOW FROM BOTH SIDES.
3. DISMANTLE AND REMOVE ALL EQUIPMENT FOR OPERATIONS OF SLUDGE GATE.
4. DEMOLISH WALKWAY, INTAKE STRUCTURES, AND SOUTH HEADWALL.
5. BACKFILL THE PORTION OF PIPE THAT CROSSES BENEATH THE LEVEE WITH FLOWABLE FILL.
6. BACKFILL LOWER PORTION OF INTAKE STRUCTURES WITH CLEAN FILL TO GRADE.
7. PROVIDE RIPRAP OVER FOOTPRINT OF INTAKE STRUCTURE TO MATCH EXISTING SLOPE.

NOTES:

1. INTERIOR OF STRUCTURE IS APPROXIMATE ONLY BASED ON LIMITED VISUAL OBSERVATIONS. ACTUAL LAYOUT MAY VARY.

EXISTING DRAINAGE STRUCTURES - UNIROYAL				
STRUCTURE	RIM	INV. OUT.	INV. IN.	NOTES
DMH-17	104.8'	85.84' (OUTFALL)	85.84' (DMH-16)	ADJ
DMH-16	101.8'	88.48' (DMH-17)	88.48' ()	RET
DMH-14	99.07'	76.92' (CB-13)	UNKKNOWN	ADJ
CB-13	82.79'	76.87' (DMH-12)	76.87' (DMH-14)	ABAN
DMH-12	85.39'	76.5' (PUMP STA)	76.5' (CB-13)	ABAN
DMH-11	85.32	76.5' (PUMP STA)	76.5' (DMH-10)	ABAN
DMH-10	85.59	76.58 (DMH-4)	76.58 (DMH-9)	ABAN
DMH-9	87.66	76.62 (DMH-10)	76.62 (DMH-8)	ABAN
DMH-8	90.62'	76.80 (DMH-9)	76.80 (DMH-7)	ABAN
DMH-7	UNK	77.0 (DMH-8)	77.0' (DMH-6)	ABAN
DMH-6	UNK	77.88 (DMH-7)	77.88' (DMH-8)	ABAN
DMH-4	91.29'	78.25 (DMH-6)	78.5' (DMH-3)	ABAN
DMH-3	86.3'	78.65 (DMH-4)	78.65' (DMH-2)	ABAN
DMH-2	87.1'	78.8 (DMH-3)	78.8 (DMH-1)	ABAN
DMH-1	86.3'	79.02 (DMH-2)	BYPASS	ABAN
DMH-D	UNK	UNK	UNK	ABAN
CB-D	UNK	UNK	UNK	ABAN
DMH-C	UNK	UNK	UNK	ABAN
DMH-J	UNK	UNK	UNK	ABAN
DMH-B	UNK	UNK	UNK	ABAN
CB-X	UNK	UNK	UNK	ABAN
DMH-A	UNK	UNK	UNK	ABAN
DMH-E	UNK	UNK	UNK	ABAN
CB-E	UNK	UNK	UNK	ABAN
DMH-0	UNK	UNK	UNK	ABAN

EXISTING DRAINAGE STRUCTURES - FACEMATE				
STRUCTURE	RIM	INV. OUT.	INV. IN.	NOTES
CB-14	89.93'	82.9' (DMH-13)	87.5' (CB-15)	CIT TO DMH-14
CB-15	92.0'	83.4' (CB-14)	83.4' (CB-16)	ABAN
CB-16	89.30'	84.02' (CB-15)	N/A	ABAN

NOTES:

1. INVERTS ARE BASED ON AVAILABLE RECORD DATA. ACTUAL ELEVATIONS MAY VARY.
2. ADDITIONAL INVERTS AND STRUCTURES MAY EXIST BEYOND THOSE LISTED IN THESE TABLES. IT SHALL BE THE RESPONSIBILITY OF THE CONTRACTOR TO LOCATE ALL DRAINAGE STRUCTURES IN THE AREA OF WORK.
3. "UNK" REFERS TO A VALUE THAT IS NOT KNOWN.

SITE PREPARATION AND EROSION CONTROL NOTES

1. THE CONSTRUCTION SEQUENCING PLAN IS FOR CONCEPTUAL PURPOSES ONLY. THE ACTUAL SEQUENCE OF WORK IMPLEMENTED FOR THIS PROJECT MAY DEVIATE FROM THIS PLAN SO LONG AS IT MEETS THE REQUIREMENTS OF THE PROJECT SITE PLANSET, PROJECT STORMWATER MANAGEMENT REPORT, CITY REGULATIONS, AND ACOE REQUIREMENTS. ADDITIONAL CONSTRUCTION ACTIVITIES MAY BE REQUIRED AT THE SITE BEYOND THOSE PRESENTED ON THIS PLAN.
2. PRIOR TO TRANSITIONING FROM ONE PHASE TO ANOTHER, AT LEAST 75% OF THE EXISTING WORK AREA SHALL BE TEMPORARILY OR PERMANENTLY STABILIZED.
3. ENGINEER WILL PROVIDE A STORMWATER POLLUTION PREVENTION PLAN (SWPPP), INCLUDING THE FILING OF A NOTICE OF INTENT WITH THE U.S. EPA TO OBTAIN A NPDES CONSTRUCTION GENERAL PERMIT (CGP) PRIOR TO THE CONTRACTOR COMMENCING WORK. THE CONTRACTOR SHALL BE RESPONSIBLE TO PERFORM INSPECTIONS, MONITORING, AND MAINTENANCE, IF WARRANTED, IN ACCORDANCE WITH THE SWPPP TO COMPLY WITH THE CGP. THE SOIL EROSION SEDIMENT CONTROL PROCEDURES AND DETAILS SHOWN AND DESCRIBED IN THE SWPPP SHALL BE STRICTLY FOLLOWED AND INSTALLED IN A MANNER TO MINIMIZE EROSION FROM DISTURBED AREAS.
4. ALL EXISTING AND PROPOSED STEEP SLOPES WITHIN THE FILL AREA (2:1 OR STEEPER, OR AS DIRECTED BY ENGINEER) TO BE STABILIZED WITH JUTE MESH EROSION CONTROL MAT OR APPROVED EQUIVALENT.
5. ALL ACCESS, STAGING, AND STORAGE AREAS SHALL BE LOCATED WITHIN THE LIMITS OF THE PROJECT SITE. NO WORK, STOCKPILING OF MATERIALS, STORAGE OF EQUIPMENT, OR OTHER OPERATIONS OF THE CONTRACTOR SHALL TAKE PLACE OUTSIDE THE LIMITS OF WORK UNLESS AUTHORIZED IN WRITING BY THE ENGINEER.
6. EROSION CONTROL DEVICES SHALL BE FULLY INSTALLED PRIOR TO THE START OF ANY SITE WORK, AND SHALL BE MAINTAINED THROUGHOUT CONSTRUCTION. THESE DEVICES SHALL BE REMOVED AND LEGALLY DISPOSED OF UPON COMPLETION OF ALL WORK WHEN ALL DISTURBED AREAS ARE STABILIZED AND PERMANENT GROUND COVER IS ESTABLISHED, TO THE SATISFACTION OF THE ENGINEER AND THE TOWN. ALL EROSION CONTROL BMPs SHALL CONFORM TO US EPA, NPDES, MA DEP, AND MASSACHUSETTS EROSION AND SEDIMENTATION CONTROL GUIDELINES FOR URBAN AND SUBURBAN AREAS.
7. THE CONTRACTOR SHALL MONITOR ALL AREAS WITHIN AND AROUND THE LIMIT OF THE WORK FOR SIGNS OF EROSION, AND REPAIR/STABILIZE ANY ERODED AREAS, AS REQUIRED, UNTIL FINAL STABILIZATION CAN BE ACHIEVED.
8. THE CONTRACTOR IS RESPONSIBLE FOR MONITORING DOWNSTREAM CONDITIONS THROUGHOUT THE CONSTRUCTION PERIOD AND CLEARING ANY DEBRIS AND/OR SEDIMENT IMPEDING PROPER DRAINAGE DURING CONSTRUCTION.
9. NO SEDIMENT SHALL BE PERMITTED TO LEAVE THE SITE DURING CONSTRUCTION. IF HEAVY RAIN AND/OR UNUSUAL SITE CONDITIONS RESULT IN THE POLLUTION OF ROADWAYS, BUFFER ZONES, RESOURCE AREAS, OR ADJACENT PARCELS, CONTRACTOR SHALL NOTIFY THE ENGINEER IMMEDIATELY. CONTRACTOR SHALL CLEAN ANY DISTURBED AREAS AS SOON AS PRACTICABLE AND RESTORE THEIR ORIGINAL CONDITIONS. CLEANING AND RESTORATION WITHIN BUFFER ZONES AND RESOURCE AREAS MUST BE PERFORMED UNDER THE SUPERVISION OF A WETLAND CONSULTANT, AS COORDINATED BY ENGINEER. WORK MAY ALSO BE OBSERVED BY THE CONSERVATION COMMISSION.
10. CONTRACTOR SHALL SWEEP GROVE STREET, OAK STREET, AND WEST MAIN STREET AT THE END OF EACH WORK DAY (OR MORE FREQUENTLY AS REQUESTED BY THE CITY OR ITS AGENT) TO REMOVE SEDIMENT TRACKING CAUSED BY PROJECT-RELATED CONSTRUCTION VEHICLES.
11. SILT SACKS SHALL BE INSTALLED WITHIN ANY CATCH BASINS AND DRAIN INLETS WITHIN THE LOTS AND WITHIN THE VICINITY OF THE LIMIT OF WORK AS NECESSARY TO PREVENT SILT-LADEN RUNOFF FROM ENTERING THE CITY OR ACOE STORM DRAIN SYSTEM.
12. ALL DISTURBED AREAS SHALL BE STABILIZED NO LATER THAN 14 DAYS AFTER A CONSTRUCTION ACTIVITY HAS TEMPORARILY OR PERMANENTLY CEASED ON THAT PORTION OF THE SITE.
13. ANY DISTURBED AREA EXPOSED FOR MORE THAN 7 DAYS SHALL BE STABILIZED WITH PERENNIAL RYE GRASS SEEDING OR APPROVED EQUIVALENT. ADDITIONALLY, A ROW OF STRAW WATTLES SHALL BE PLACED AND STAKED ON THE DOWNGRADIENT SIDE OF ALL SUCH AREAS. SEEDED AREAS SHALL BE RE-SEEDDED AS NECESSARY TO ENSURE VEGETATION ESTABLISHMENT.
14. ALL STOCKPILES AND DISTURBED AREAS TO BE STABILIZED IF EXPOSED FOR MORE THAN 7 DAYS. ALL STOCKPILES SHALL BE SURROUNDED BY COMPOST FILTER RUBES, AND COVERED IN A MANNER THAT STORMWATER DOES NOT INFILTRATE THE MATERIAL. ALL STOCKPILES OVER 10' IN HEIGHT SHALL BE SURROUNDED BY SAFETY FENCING. NO STOCKPILE SHALL BE PLACED NORTH OF EAST OF THE PERIMETER EROSION CONTROLS.



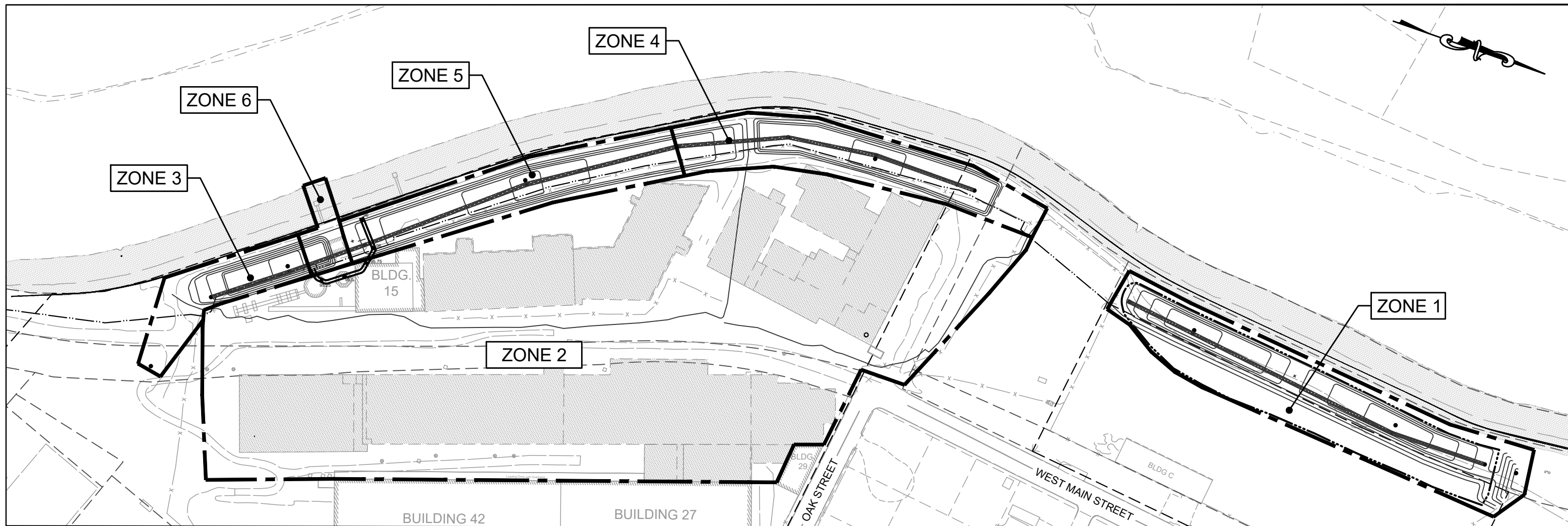
Former Uniroyal & Facemate Properties

ACOE Permit Review Only
154 Grove Street & 75 West Main Street
Chicopee, MA

Issue Date: 5-13-2021

Figure No. 11

**Oak Street Pump Station
And Construction Notes**



CONCEPTUAL CONSTRUCTION SEQUENCE

- PHASE 1 CAN BE CONDUCTED CONCURRENTLY WITH PHASES 2 - 6.
- REFER TO NOTES 1 & 2 ON FIGURE 11

PHASE 0 (SITEWIDE)

- COORDINATE SCHEDULE WITH OTHER ON-SITE CONTRACTORS
- INSTALL SITEWIDE PERIMETER EROSION CONTROLS, INLET PROTECTION, AND STABILIZED CONSTRUCTION ENTRANCES.
- REVIEW GUIDELINES OF CITY FILL MANAGEMENT PLAN, INCLUDING PROCEDURE FOR ACCEPTANCE AND MANAGEMENT OF BACKFILL MATERIAL.
- ESTABLISH STOCKPILE AND STAGING AREAS.
- FIELD-LOCATE ALL EXISTING DRAINAGE STRUCTURES IN THE VICINITY OF THE FLOOD CONTROL LEVEE AND THOSE ASSOCIATED WITH BUILDING 26 & 27 ROOF DRAINAGE SYSTEM.
- RAISE EXISTING MONITORING WELLS AS DEEMED NECESSARY BY THE CITY OR ITS LICENSED SITE PROFESSIONAL.
- IDENTIFY AND RELOCATE/REMOVE ANY ITEMS THAT MAY OBSTRUCT BACKFILL OPERATIONS, SUCH AS FENCING AND UTILITY POLES. SITE SECURITY FOR UNIROYAL TO BE RESET AT DISCRETION OF CITY.

PHASE 1 (ZONE 1)

- REMOVE EXISTING RIPRAP FLOW CHANNELS FROM ZONE 1. EVALUATE EXISTING STRAW WATTLES FOR RE-USE.
- PLUG EXISTING BYPASS LINE SOUTH OF BUILDING C.
- ABANDON AND PLUG EXISTING DRAINAGE STRUCTURES BETWEEN CB-16 AND DMH-14 IN ACCORDANCE WITH THE SITE PLANS.
 - CONTRACTOR IS RESPONSIBLE FOR DEWATERING THIS AREA UNTIL THE PROPOSED DRAINAGE SYSTEM IS FUNCTIONAL.
- INSTALL THE PROPOSED DRAINAGE STRUCTURES, DRAINAGE PIPES, AND CRUSHED STONE AROUND PERFORATED PIPE IN STAGES AS BACKFILL MATERIAL IS PLACED WITHIN THIS ZONE.
 - BACKFILL SHALL BE PLACED IN 6 INCH LIFTS TO 3 FEET BENEATH THE FINAL GRADES OF THE PROPOSED INFILTRATION BASINS.
 - 3 FEET OF BASIN SOIL MIX, WITH SEEDING, SHALL BE PLACED WITHIN THE BASINS WHICH THEN STRUCTURE CB/DMH-14 SHALL BE CONVERTED AND ADJUSTED.
- CONTINUE BACKFILLING OF THIS ZONE IN ACCORDANCE WITH FILL MANAGEMENT PLAN, INCLUDING PLACEMENT OF FILL MATERIAL, GEOTEXTILE FABRIC LAYER, AND CLEAN SOIL CAP.

PHASE 2 (ZONE 2)

- ENSURE THAT ACCESS TO PUMP STATION IS MAINTAINED THROUGHOUT DURATION OF PHASES 2 THROUGH 5.
- CONDUCT GRADING OF ZONE 2 IN ACCORDANCE WITH FILL MANAGEMENT PLAN, INCLUDING PLACEMENT OF FILL MATERIAL, GEOTEXTILE FABRIC LAYER, AND CLEAN SOIL CAP.
- TEMPORARILY GRADE WEST SIDE OF ZONE 2 TO MAXIMUM SLOPE OF 3:1 TO MEET EXISTING GRADES. PROVIDE TEMPORARY ROW OF STRAW WATTLES ALONG TOE OF SLOPE.
- ENSURE THAT DEMOLITION OF BUILDING 15 IS COMPLETED PRIOR TO START OF PHASE 3 (UNDER SEPARATE CONTRACT).
- DEMOLISH ELEVATED TANK STRUCTURE NEAR PUMP STATION.

PHASE 3 (ZONE 3)

- ABANDON AND PLUG EXISTING DRAINAGE STRUCTURES BETWEEN PUMP STATION AND DMH-14 IN ACCORDANCE WITH THE SITE PLANS.
 - CONTRACTOR IS RESPONSIBLE FOR DEWATERING THIS AREA UNTIL THE PROPOSED DRAINAGE SYSTEM IS FUNCTIONAL TO THE SOUTH OUTFALL.
- ADJUST DMH-14 AND DMH-17, AND INSTALL HDPE BETWEEN THE TWO STRUCTURES. EVALUATE EXISTING NORTHBOUND INVERT AT DMH-14.
- INSTALL THE PROPOSED DRAINAGE STRUCTURES, DRAINAGE PIPES, AND CRUSHED STONE AROUND PERFORATED PIPE IN STAGES, BETWEEN PUMP STATION AND DMH-14, AS BACKFILL MATERIAL IS PLACED WITHIN THIS ZONE. PIPE BETWEEN DMH-13A AND DMH-12A TO BE PARTIALLY CONSTRUCTED AND CAPPED DURING THIS PHASE.
 - BACKFILL SHALL BE PLACED IN 6 INCH LIFTS TO 3 FEET BENEATH THE FINAL GRADES OF THE PROPOSED INFILTRATION BASIN.
 - 3 FEET OF BASIN SOIL MIX, WITH SEEDING, SHALL BE PLACED WITHIN THE BASIN.
- CONTINUE BACKFILLING OF THIS ZONE IN ACCORDANCE WITH FILL MANAGEMENT PLAN, INCLUDING PLACEMENT OF FILL MATERIAL, GEOTEXTILE FABRIC LAYER, AND CLEAN SOIL CAP.

PHASE 4 (ZONE 4)

- ABANDON AND PLUG EXISTING DRAINAGE STRUCTURES BETWEEN DMH-7A AND DMH-6 IN ACCORDANCE WITH THE SITE PLANS.
- CONTRACTOR IS RESPONSIBLE FOR DEWATERING THIS AREA UNTIL THE PROPOSED DRAINAGE SYSTEM IS FUNCTIONAL TO DMH-12A.

- INSTALL THE PROPOSED DRAINAGE STRUCTURES, DRAINAGE PIPES, AND CRUSHED STONE AROUND PERFORATED PIPE IN STAGES, BETWEEN DMH-7A AND DMH-10A, AS BACKFILL MATERIAL IS PLACED WITHIN THIS ZONE.
 - TEMPORARILY GRADE PIPE-LESS OUTFLET FROM DMH-10A TO CONVEY FLOWS TO NEARBY EXISTING CATCH BASIN.
 - BACKFILL SHALL BE PLACED IN 6 INCH LIFTS TO 3 FEET BENEATH THE FINAL GRADES OF THE PROPOSED INFILTRATION BASIN.
 - 3 FEET OF BASIN SOIL MIX, WITH SEEDING, SHALL BE PLACED WITHIN THE BASIN.
- CONTINUE BACKFILLING OF THIS ZONE IN ACCORDANCE WITH FILL MANAGEMENT PLAN, INCLUDING PLACEMENT OF FILL MATERIAL, GEOTEXTILE FABRIC LAYER, AND CLEAN SOIL CAP.

PHASE 5 (ZONE 5)

- ABANDON AND PLUG EXISTING DRAINAGE STRUCTURES BETWEEN DMH-6 AND DMH-9 IN ACCORDANCE WITH THE SITE PLANS.
- CONTRACTOR IS RESPONSIBLE FOR DEWATERING THIS AREA UNTIL THE PROPOSED DRAINAGE SYSTEM IS FUNCTIONAL TO DMH-12A.
- INSTALL THE PROPOSED DRAINAGE STRUCTURES, DRAINAGE PIPES, AND CRUSHED STONE AROUND PERFORATED PIPE IN STAGES, BETWEEN DMH-10A AND DMH-12A, AS BACKFILL MATERIAL IS PLACED WITHIN THIS ZONE.
 - TEMPORARILY GRADE PIPE-LESS OUTFLET FROM DMH-12A TO CONVEY FLOWS TO NEARBY EXISTING CATCH BASIN.
 - BACKFILL SHALL BE PLACED IN 6 INCH LIFTS TO 3 FEET BENEATH THE FINAL GRADES OF THE PROPOSED INFILTRATION BASIN.
 - 3 FEET OF BASIN SOIL MIX, WITH SEEDING, SHALL BE PLACED WITHIN THE BASIN.
- CONTINUE BACKFILLING OF THIS ZONE IN ACCORDANCE WITH FILL MANAGEMENT PLAN, INCLUDING PLACEMENT OF FILL MATERIAL, GEOTEXTILE FABRIC LAYER, AND CLEAN SOIL CAP.

PHASE 6 (ZONE 6)

- CONSTRUCT TEMPORARY SWALE TO DIVERT STORMWATER RUNOFF AWAY FROM PUMP STATION. PROVIDE TEMPORARY PLUG FOR PIPE-LESS OUTFLET FROM DMH-12A.
- COMPLETE DECOMMISSIONING OF OAK ST. PUMP STATION (REFER TO FIGURE 11)
- ABANDON AND PLUG EXISTING DRAINAGE STRUCTURES IN ACCORDANCE WITH SITE PLANSET, EXCLUDING STRUCTURES NECESSARY FOR PUMP STATION OPERATION.
- BACKFILL ZONE TO APPROX. ELEVATION 88', EXCLUDING THE FOOTPRINT AND IMMEDIATE VICINITY OF PROPOSED DRAINAGE STRUCTURES AND DRAIN LINES.

- INSTALL REMAINING DRAINAGE PIPE BETWEEN DMH-12A AND DMH-13A AND CRUSHED STONE AROUND PERFORATED PIPE.
- COMPLETE DECOMMISSIONING OF OAK ST. PUMP STATION DISCHARGE STRUCTURE.
- BACKFILL ZONE TO FINAL GRADES.
- REMOVE TEMPORARY SWALE AND BACKFILL ZONE TO FINAL GRADES.

PHASE 7 (SITEWIDE)

- REMOVE PHASE 6 DIVERSION SWALE
- CONDUCT FINE GRADING OF ANY AREAS NOT YET FINALIZED.
- VERIFY DRAINAGE PATTERNS, ENSURING NO RUNOFF IS DIRECTED OVER THE LEVEE.
- COMPLETE SITE-WIDE PERMANENT RESTORATION (UNLESS PRECLUDED BY OTHER SITE ACTIVITIES).
- REMOVE EROSION CONTROLS ONCE FINAL STABILIZATION IS ACHIEVED, UNLESS OTHERWISE NEEDED FOR FUTURE SITework.

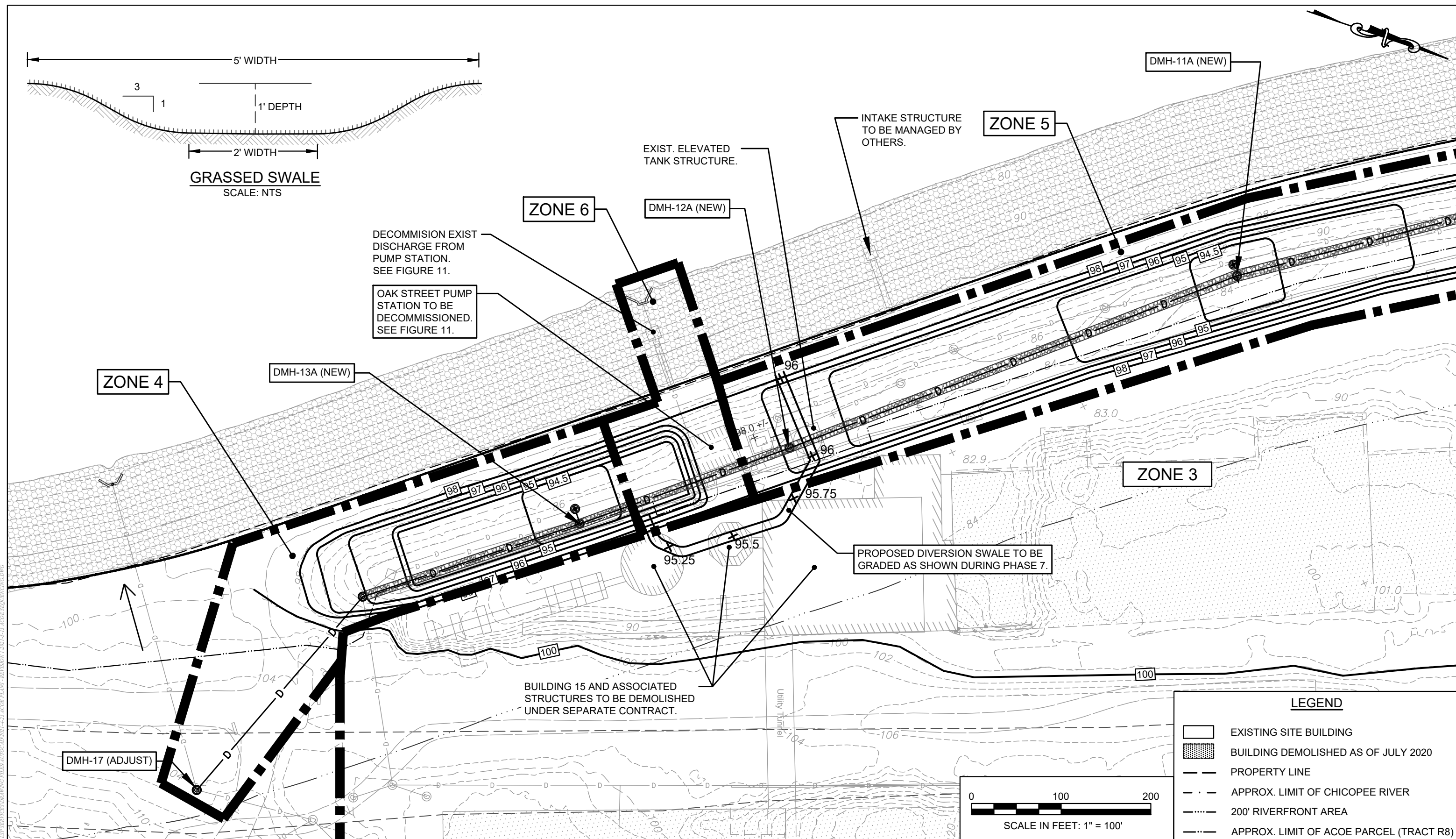
LEGEND

- EXISTING SITE BUILDING
- BUILDING DEMOLISHED AS OF JULY 2020
- PROPERTY LINE
- APPROX. LIMIT OF CHICOPEE RIVER
- APPROX. LIMIT OF ACOE PARCEL (TRACT R8)
- PROPOSED FILL AREA



Former Uniroyal & Facemate Properties
 ACOE Permit Review Only
 154 Grove Street & 75 West Main Street
 Chicopee, MA
 Issue Date: 5-13-2021

Figure No. ##
Overall Sequencing Plan



Former Uniroyal & Facemate Properties

ACOE Permit Review Only
154 Grove Street & 75 West Main Street
Chicopee, MA

Issue Date: 5-13-2021

Figure No. 13

Enlarged Sequencing Plan



C:\USERS\B001\CHICOPEE - UNIROYAL & FACEMATE\DRAWING FILES\154 GROVE ST\154 GROVE ST - BETA\154 GROVE ST - ACOE PERMIT REVIEW.DWG

Photo 1



View of the Uniroyal Property Fill Area and Intake Abandonment Area—facing north

Photo 2



View of the Fisk Rubber Company Office buildings—facing southeast

PHOTOGRAPHIC DOCUMENTATION

Proposed Site Grading Along Chicopee Falls

Chicopee, Massachusetts

Photographs Documented 05.24.2017

Photo 3



View of the Facemate Property Fill Area—facing south

Photo 4



View of the Facemate Property Fill Area along the Chicopee river—facing south

PHOTOGRAPHIC DOCUMENTATION

Proposed Site Grading Along Chicopee Falls

Chicopee, Massachusetts

Photographs Documented 05.05.2022

Photo 5



View of the existing warehouse on the Facemate Property Fill Area—facing south

Photo 6



View of the neighboring RiverMills Center—facing north

PHOTOGRAPHIC DOCUMENTATION

Proposed Site Grading Along Chicopee Falls

Chicopee, Massachusetts

Photographs Documented 05.05.2022

From: Tyler Drew
Sent: Friday, August 5, 2022 3:10 PM
To: 'david.s.robinson@mass.gov'
Cc: Jonathan Niro
Subject: Chicopee, MA – Proposed Flood Control System along Chicopee Falls – Section 106 Consultation
Attachments: BUAR Packet Compiled.pdf

Hello Mr Robinson,

BETA is submitting the enclosed project information to the Board of Underwater Archeological Resources to meet the Section 106 consultation requirements of the U. S. Army Corps of Engineers.

Please submit any written comments or concerns regarding historic or archaeological properties that may be affected by this project to Jonathan Niro, BETA Group, Inc., 89 Shrewsbury Street, Suite 300, Worcester MA 01604.

You also may send comments, questions, or requests for more information by email to me at tdrew@beta-inc.com.

Many thanks,
Tyler

Tyler Drew
Staff Scientist



BETA Group, Inc.
401.333.2382



 Be GREEN, keep it on the SCREEN

7020 3160 0000 2812 7791

U.S. Postal Service
CERTIFIED MAIL® RECEIPT

Domestic Mail Only

For delivery information, visit our website at www.usps.com®.

Dorchester, MA 02125

OFFICIAL USE

Certified Mail Fee	\$4.00
Extra Services & Fees (check box, add fee as appropriate)	\$3.75
<input type="checkbox"/> Return Receipt (hardcopy)	\$0.00
<input type="checkbox"/> Return Receipt (electronic)	\$0.00
<input type="checkbox"/> Certified Mail Restricted Delivery	\$0.00
<input type="checkbox"/> Adult Signature Required	\$0.00
<input type="checkbox"/> Adult Signature Restricted Delivery	\$0.00

Postage	\$1.92
Total Postage and Fees	\$9.17



Sent To Massachusetts Historical Commission
 Street and Apt. No., or PO Box No. 220 Morrissey Blvd
 City, State, ZIP+4® Boston, MA 02125

From: Tyler Drew
Sent: Friday, August 5, 2022 3:11 PM
To: bonney.hartley@mohican-nsn.gov
Cc: Jonathan Niro
Subject: Chicopee, MA – Proposed Flood Control System along Chicopee Falls – Section 106 Consultation
Attachments: Mohican Packet Compiled.pdf

Hello,

BETA is submitting the enclosed project information to the Tribal Historic Preservation Officer to meet the Section 106 consultation requirements of the U. S. Army Corps of Engineers.

Please submit any written comments or concerns regarding historic or archaeological properties that may be affected by this project to Jonathan Niro, BETA Group, Inc., 89 Shrewsbury Street, Suite 300, Worcester MA 01604.

You also may send comments, questions, or requests for more information by email to me at tdrew@beta-inc.com.

Many thanks,
Tyler

Tyler Drew
Staff Scientist



BETA Group, Inc.
401.333.2382



 Be GREEN, keep it on the SCREEN

From: Tyler Drew
Sent: Friday, August 5, 2022 3:10 PM
To: 'tashtesook@aol.com'
Cc: Jonathan Niro
Subject: Chicopee, MA – Proposed Flood Control System along Chicopee Falls – Section 106 Consultation
Attachments: Narragansett Packet Compiled.pdf

Hello,

BETA is submitting the enclosed project information to the Tribal Historic Preservation Officer to meet the Section 106 consultation requirements of the U. S. Army Corps of Engineers.

Please submit any written comments or concerns regarding historic or archaeological properties that may be affected by this project to Jonathan Niro, BETA Group, Inc., 89 Shrewsbury Street, Suite 300, Worcester MA 01604.

You also may send comments, questions, or requests for more information by email to me at tdrew@beta-inc.com.

Many thanks,
Tyler

Tyler Drew
Staff Scientist



BETA Group, Inc.
401.333.2382



 Be GREEN, keep it on the SCREEN

From: Tyler Drew
Sent: Friday, August 5, 2022 3:10 PM
To: bettina@wampanoagtribe.net; tcrm2@wmapanoagtribe-nsn.gov
Cc: Jonathan Niro
Subject: Chicopee, MA – Proposed Flood Control System along Chicopee Falls – Section 106 Consultation
Attachments: Wampanoag Packet Compiled.pdf

Hello Bettina,

BETA is submitting the enclosed project information to the Tribal Historic Preservation Officer to meet the Section 106 consultation requirements of the U. S. Army Corps of Engineers.

Please submit any written comments or concerns regarding historic or archaeological properties that may be affected by this project to Jonathan Niro, BETA Group, Inc., 89 Shrewsbury Street, Suite 300, Worcester MA 01604.

You also may send comments, questions, or requests for more information by email to me at tdrew@beta-inc.com.

Many thanks,
Tyler

Tyler Drew
Staff Scientist



BETA Group, Inc.
401.333.2382



 Be GREEN, keep it on the SCREEN

Memorandum of Agreement
Submitted to the Advisory Council on Historic Preservation
Pursuant to 950 CMR 71 and 36 CFR Part 800
Regarding the proposed demolition and redevelopment of the
Fisk Tire / Uniroyal site, 154 Grove Street Chicopee, Massachusetts

WHEREAS, the City of Chicopee, by and through the Office of Community Development, proposes to use Community Development Block Grant funds from the US Dept. of Housing & Urban Development to remove a public safety hazard, reduce blight and encourage appropriate development at the former Fisk Tire / Uniroyal plant at 154 Grove St. in Chicopee Falls; and

WHEREAS, the Massachusetts Historical Commission, in its capacity as the State Historic Preservation Office, has determined that the Fisk Tire / Uniroyal complex is eligible for listing on the State and National Registers of Historic Places under criterion A (industrial history); and

WHEREAS, the City of Chicopee has submitted a plan to demolish Buildings 7, 8, 15, 27, 28, 33, 42, and 43 at the Fisk Tire / Uniroyal plant due to severe structural instability; environmental contamination; and documented infeasibility for reuse; and

WHEREAS, the City of Chicopee has consulted with the Massachusetts Historical Commission pursuant to 950 CMR 71.07 and 36 CFR Part 800, regulations seeking to avoid, minimize or mitigate adverse effects on historic properties; and

WHEREAS, the City of Chicopee has determined that the proposed action will have an adverse effect through the demolition of historic properties (36 CFR 800.5(a)(2)(i) and the Massachusetts Historical Commission has concurred; and

WHEREAS, the Chicopee Historical Commission has participated in the consultation and has been invited to concur in this Memorandum of Agreement; and

WHEREAS, the parties have agreed that no feasible or prudent alternative to demolition exists that would avoid or minimize the adverse effect of the project;

NOW, THEREFORE, the City of Chicopee (City) and the Massachusetts Historical Commission (MHC) agree that the undertaking shall be implemented in accordance with the following stipulations in order to take into account the effect of the undertaking on the historic properties.

Stipulations

The City of Chicopee will ensure the following measures are carried out:

1. DEMOLITION - The City of Chicopee shall be permitted to move forward with the demolition of Buildings 7, 8, 15, 27, 28, 33, 42 and 43 (only) immediately upon execution of this Memorandum of Agreement.
2. ENCOURAGE REUSE OF BUILDINGS #25 AND #26 - The City of Chicopee shall encourage the reuse of the remaining two buildings in the complex, Building #25 and Building #26, in the request for developer interest and subsequent development proposal(s).
3. REDEVELOPMENT REVIEW - At such time the City of Chicopee is prepared to solicit requests for developer interest or development proposals for the Fisk Tire / Uniroyal site

redevelopment, the City shall provide MHC the opportunity to review and comment on the solicitation, and provide input on its stated goals and objectives for redevelopment.

4. PUBLIC COMMENT - If at any time during the implementation of the measures stipulated in this agreement, a written objection should be submitted to the City of Chicopee by the Massachusetts Historical Commission, the Chicopee Historical Commission or a member of the public, the City shall take the objection into account and may consult with the Massachusetts Historical Commission, the Chicopee Historical Commission or the objecting party as needed to resolve the objection

Execution and acceptance of this Memorandum of Agreement by an authorized representative of the City of Chicopee and the Massachusetts Historical Commission and implementation of its terms shall constitute evidence that the City has afforded MHC the opportunity to comment on the proposed project and its effect on historic properties and that the City has taken into account the effect of the undertaking on historic properties in compliance with 950 CMR 71, 24 CFR Part 58 and 36 CFR Part 800.

Massachusetts Historical Commission:

By: _____
Brona Simon, Executive Director
State Historic Preservation Officer
State Archaeologist

City Of Chicopee:

By: _____
Michael D. Bissonnette, Mayor

Approved as to Form:

By: _____
Karen Betournay, City Solicitor

Consulting Party:

By: _____
Stephen Jendrysik, Chairman
Chicopee Historical Commission

APPENDIX C – U.S. Fish and Wildlife Service Species List



United States Department of the Interior



FISH AND WILDLIFE SERVICE
New England Ecological Services Field Office
70 Commercial Street, Suite 300
Concord, NH 03301-5094
Phone: (603) 223-2541 Fax: (603) 223-0104

In Reply Refer To:
Project Code: 2022-0061559
Project Name: Uniroyal Site Filling

July 07, 2022

Subject: List of threatened and endangered species that may occur in your proposed project location or may be affected by your proposed project

To Whom It May Concern:

Please review this letter each time you request an Official Species List, we will continue to update it with additional information and links to websites may change.

About Official Species Lists

The purpose of the Act is to provide a means whereby threatened and endangered species and the ecosystems upon which they depend may be conserved. Federal and non-Federal project proponents have responsibilities under the Act to consider effects on listed species.

The enclosed species list identifies threatened, endangered, proposed, and candidate species, as well as proposed and final designated critical habitat, that may occur within the boundary of your proposed project and/or may be affected by your proposed project. The species list fulfills the requirements of the U.S. Fish and Wildlife Service (Service) under section 7(c) of the Endangered Species Act (Act) of 1973, as amended (16 U.S.C. 1531 et seq.).

New information based on updated surveys, changes in the abundance and distribution of species, changed habitat conditions, or other factors could change this list. Please note that under 50 CFR 402.12(e) of the regulations implementing section 7 of the Act, the accuracy of this species list should be verified after 90 days. The Service recommends that verification be completed by visiting the ECOS-IPaC website at regular intervals during project planning and implementation for updates to species lists and information. An updated list may be requested by returning to an existing project's page in IPaC.

Endangered Species Act Project Review

Please visit the “**New England Field Office Endangered Species Project Review and Consultation**” website for step-by-step instructions on how to consider effects on listed

species and prepare and submit a project review package if necessary:

<https://www.fws.gov/office/new-england-ecological-services/endangered-species-project-review>

NOTE Please do not use the **Consultation Package Builder** tool in IPaC except in specific situations following coordination with our office. Please follow the project review guidance on our website instead and reference your **Project Code** in all correspondence.

Northern Long-eared Bat Update - Additionally, please note that on March 23, 2022, the Service published a proposal to reclassify the northern long-eared bat (NLEB) as endangered under the Endangered Species Act. The U.S. District Court for the District of Columbia has ordered the Service to complete a new final listing determination for the NLEB by November 2022 (Case 1:15-cv-00477, March 1, 2021). The bat, currently listed as threatened, faces extinction due to the range-wide impacts of white-nose syndrome (WNS), a deadly fungal disease affecting cave-dwelling bats across the continent. The proposed reclassification, if finalized, would remove the current 4(d) rule for the NLEB, as these rules may be applied only to threatened species. Depending on the type of effects a project has on NLEB, the change in the species' status may trigger the need to re-initiate consultation for any actions that are not completed and for which the Federal action agency retains discretion once the new listing determination becomes effective (anticipated to occur by December 30, 2022). If your project may result in incidental take of NLEB after the new listing goes into effect this will first need to be addressed in an updated consultation that includes an Incidental Take Statement. If your project may require re-initiation of consultation, please contact our office for additional guidance.

Additional Info About Section 7 of the Act

Under section 7(a)(2) of the Act and its implementing regulations (50 CFR 402 et seq.), Federal agencies are required to determine whether projects may affect threatened and endangered species and/or designated critical habitat. If a Federal agency, or its non-Federal representative, determines that listed species and/or designated critical habitat may be affected by the proposed project, the agency is required to consult with the Service pursuant to 50 CFR 402. In addition, the Federal agency also may need to consider proposed species and proposed critical habitat in the consultation. 50 CFR 402.14(c)(1) specifies the information required for consultation under the Act regardless of the format of the evaluation. More information on the regulations and procedures for section 7 consultation, including the role of permit or license applicants, can be found in the "Endangered Species Consultation Handbook" at:

<https://www.fws.gov/service/section-7-consultations>

In addition to consultation requirements under Section 7(a)(2) of the ESA, please note that under sections 7(a)(1) of the Act and its implementing regulations (50 CFR 402 et seq.), Federal agencies are required to utilize their authorities to carry out programs for the conservation of threatened and endangered species. Please contact NEFO if you would like more information.

Candidate species that appear on the enclosed species list have no current protections under the

ESA. The species' occurrence on an official species list does not convey a requirement to consider impacts to this species as you would a proposed, threatened, or endangered species. The ESA does not provide for interagency consultations on candidate species under section 7, however, the Service recommends that all project proponents incorporate measures into projects to benefit candidate species and their habitats wherever possible.

Migratory Birds

In addition to responsibilities to protect threatened and endangered species under the Endangered Species Act (ESA), there are additional responsibilities under the Migratory Bird Treaty Act (MBTA) and the Bald and Golden Eagle Protection Act (BGEPA) to protect native birds from project-related impacts. Any activity, intentional or unintentional, resulting in take of migratory birds, including eagles, is prohibited unless otherwise permitted by the U.S. Fish and Wildlife Service (50 C.F.R. Sec. 10.12 and 16 U.S.C. Sec. 668(a)). For more information regarding these Acts see:

<https://www.fws.gov/program/migratory-bird-permit>

<https://www.fws.gov/library/collections/bald-and-golden-eagle-management>

Please feel free to contact us at **newengland@fws.gov** with your **Project Code** in the subject line if you need more information or assistance regarding the potential impacts to federally proposed, listed, and candidate species and federally designated and proposed critical habitat.

Attachment(s): Official Species List

Attachment(s):

- Official Species List
-

Official Species List

This list is provided pursuant to Section 7 of the Endangered Species Act, and fulfills the requirement for Federal agencies to "request of the Secretary of the Interior information whether any species which is listed or proposed to be listed may be present in the area of a proposed action".

This species list is provided by:

New England Ecological Services Field Office

70 Commercial Street, Suite 300

Concord, NH 03301-5094

(603) 223-2541

Project Summary

Project Code: 2022-0061559

Event Code: None

Project Name: Uniroyal Site Filling

Project Type: Mixed-Use Construction

Project Description: The City of Chicopee proposes to fill a low-lying, former industrial area along the Chicopee River to the elevation of the crest of the adjacent U.S. Army Corps of Engineers flood control levee to facilitate hazardous materials cleanup and future site development.

Project Location:

Approximate location of the project can be viewed in Google Maps: <https://www.google.com/maps/@42.155338900000004,-72.58720868311916,14z>



Counties: Hampden County, Massachusetts

Endangered Species Act Species

There is a total of 1 threatened, endangered, or candidate species on this species list.

Species on this list should be considered in an effects analysis for your project and could include species that exist in another geographic area. For example, certain fish may appear on the species list because a project could affect downstream species.

IPaC does not display listed species or critical habitats under the sole jurisdiction of NOAA Fisheries¹, as USFWS does not have the authority to speak on behalf of NOAA and the Department of Commerce.

See the "Critical habitats" section below for those critical habitats that lie wholly or partially within your project area under this office's jurisdiction. Please contact the designated FWS office if you have questions.

-
1. [NOAA Fisheries](#), also known as the National Marine Fisheries Service (NMFS), is an office of the National Oceanic and Atmospheric Administration within the Department of Commerce.

Insects

NAME	STATUS
Monarch Butterfly <i>Danaus plexippus</i> No critical habitat has been designated for this species. Species profile: https://ecos.fws.gov/ecp/species/9743	Candidate

Critical habitats

THERE ARE NO CRITICAL HABITATS WITHIN YOUR PROJECT AREA UNDER THIS OFFICE'S JURISDICTION.

IPaC User Contact Information

Agency: Chicopee city
Name: Jonathan Niro
Address: 89 Shrewsbury Street
Address Line 2: Suite 300
City: Worcester
State: MA
Zip: 01604
Email: jniro@beta-inc.com
Phone: 7745739694

Lead Agency Contact Information

Lead Agency: Army Corps of Engineers

APPENDIX D – Stormwater Management Report

Chicopee, MA
Former Uniroyal &
Facemate Properties
May 2021

STORMWATER MANAGEMENT REPORT

ACOE PERMIT REVIEW ONLY



BETA

1 Springfield Street
Suite 4
Chicopee, MA 01013
413.331.5326
www.BETA-Inc.com

TABLE OF CONTENTS

MassDEP Stormwater Checklist	1
1.0 Overview	9
1.1 Project Purpose	9
1.2 Contact Information	9
1.3 Project Description	9
1.4 Additional Data Sources.....	9
2.0 Existing Conditions Description.....	10
3.0 Proposed Conditions with Mitigation.....	11
4.0 Calculations and Assumptions.....	12
4.1 Objectives	12
4.2 Calculation Methods.....	12
4.3 Equations and Sources of Data Used.....	12
4.4 Points of Analysis.....	12
4.5 Calculations	13
4.6 Assumptions and Limitations	13
5.0 Summary of Results	14
6.0 Comments and Conclusions.....	15
7.0 Summary of Compliance with Ten Stormwater Management Standards.....	15
8.0 Summary of Compliance with Stormwater Management Rules.....	17
Illicit Discharge Compliance Statement.....	19

LIST OF FIGURES

Figure 1: Site Locus Map

Figure 2: Phase I Site Assessment Map

Figure 3: FEMA FIRM Map

LIST OF APPENDICES

Appendix A: Construction Period Pollution Prevention and Sediment and Erosion Control Plan

Appendix B: Long Term Operation and Maintenance Plan

Appendix C: Soils Data

Appendix D: Watershed Plans

Appendix E: Existing Conditions Calculation

Appendix F: Proposed Conditions Calculation

Appendix G: Supplemental Calculations and Rainfall Data



Checklist for Stormwater Report

A. Introduction

Important: When filling out forms on the computer, use only the tab key to move your cursor - do not use the return key.



A Stormwater Report must be submitted with the Notice of Intent permit application to document compliance with the Stormwater Management Standards. The following checklist is NOT a substitute for the Stormwater Report (which should provide more substantive and detailed information) but is offered here as a tool to help the applicant organize their Stormwater Management documentation for their Report and for the reviewer to assess this information in a consistent format. As noted in the Checklist, the Stormwater Report must contain the engineering computations and supporting information set forth in Volume 3 of the [Massachusetts Stormwater Handbook](#). The Stormwater Report must be prepared and certified by a Registered Professional Engineer (RPE) licensed in the Commonwealth.

The Stormwater Report must include:

- The Stormwater Checklist completed and stamped by a Registered Professional Engineer (see page 2) that certifies that the Stormwater Report contains all required submittals.¹ This Checklist is to be used as the cover for the completed Stormwater Report.
- Applicant/Project Name
- Project Address
- Name of Firm and Registered Professional Engineer that prepared the Report
- Long-Term Pollution Prevention Plan required by Standards 4-6
- Construction Period Pollution Prevention and Erosion and Sedimentation Control Plan required by Standard 8²
- Operation and Maintenance Plan required by Standard 9

In addition to all plans and supporting information, the Stormwater Report must include a brief narrative describing stormwater management practices, including environmentally sensitive site design and LID techniques, along with a diagram depicting runoff through the proposed BMP treatment train. Plans are required to show existing and proposed conditions, identify all wetland resource areas, NRCS soil types, critical areas, Land Uses with Higher Potential Pollutant Loads (LUHPPL), and any areas on the site where infiltration rate is greater than 2.4 inches per hour. The Plans shall identify the drainage areas for both existing and proposed conditions at a scale that enables verification of supporting calculations.

As noted in the Checklist, the Stormwater Management Report shall document compliance with each of the Stormwater Management Standards as provided in the Massachusetts Stormwater Handbook. The soils evaluation and calculations shall be done using the methodologies set forth in Volume 3 of the Massachusetts Stormwater Handbook.

To ensure that the Stormwater Report is complete, applicants are required to fill in the Stormwater Report Checklist by checking the box to indicate that the specified information has been included in the Stormwater Report. If any of the information specified in the checklist has not been submitted, the applicant must provide an explanation. The completed Stormwater Report Checklist and Certification must be submitted with the Stormwater Report.

¹ The Stormwater Report may also include the Illicit Discharge Compliance Statement required by Standard 10. If not included in the Stormwater Report, the Illicit Discharge Compliance Statement must be submitted prior to the discharge of stormwater runoff to the post-construction best management practices.

² For some complex projects, it may not be possible to include the Construction Period Erosion and Sedimentation Control Plan in the Stormwater Report. In that event, the issuing authority has the discretion to issue an Order of Conditions that approves the project and includes a condition requiring the proponent to submit the Construction Period Erosion and Sedimentation Control Plan before commencing any land disturbance activity on the site.



Checklist for Stormwater Report

B. Stormwater Checklist and Certification

The following checklist is intended to serve as a guide for applicants as to the elements that ordinarily need to be addressed in a complete Stormwater Report. The checklist is also intended to provide conservation commissions and other reviewing authorities with a summary of the components necessary for a comprehensive Stormwater Report that addresses the ten Stormwater Standards.

Note: Because stormwater requirements vary from project to project, it is possible that a complete Stormwater Report may not include information on some of the subjects specified in the Checklist. If it is determined that a specific item does not apply to the project under review, please note that the item is not applicable (N.A.) and provide the reasons for that determination.

A complete checklist must include the Certification set forth below signed by the Registered Professional Engineer who prepared the Stormwater Report.

Registered Professional Engineer's Certification

I have reviewed the Stormwater Report, including the soil evaluation, computations, Long-term Pollution Prevention Plan, the Construction Period Erosion and Sedimentation Control Plan (if included), the Long-term Post-Construction Operation and Maintenance Plan, the Illicit Discharge Compliance Statement (if included) and the plans showing the stormwater management system, and have determined that they have been prepared in accordance with the requirements of the Stormwater Management Standards as further elaborated by the Massachusetts Stormwater Handbook. I have also determined that the information presented in the Stormwater Checklist is accurate and that the information presented in the Stormwater Report accurately reflects conditions at the site as of the date of this permit application.

Registered Professional Engineer Block and Signature

Signature and Date

Checklist

Project Type: Is the application for new development, redevelopment, or a mix of new and redevelopment?

- New development
- Redevelopment
- Mix of New Development and Redevelopment



Checklist for Stormwater Report

Checklist (continued)

LID Measures: Stormwater Standards require LID measures to be considered. Document what environmentally sensitive design and LID Techniques were considered during the planning and design of the project:

- No disturbance to any Wetland Resource Areas
- Site Design Practices (e.g. clustered development, reduced frontage setbacks)
- Reduced Impervious Area (Redevelopment Only)
- Minimizing disturbance to existing trees and shrubs
- LID Site Design Credit Requested:
 - Credit 1
 - Credit 2
 - Credit 3
- Use of "country drainage" versus curb and gutter conveyance and pipe
- Bioretention Cells (includes Rain Gardens)
- Constructed Stormwater Wetlands (includes Gravel Wetlands designs)
- Treebox Filter
- Water Quality Swale
- Grass Channel
- Green Roof
- Other (describe): _____

Standard 1: No New Untreated Discharges

- No new untreated discharges
- Outlets have been designed so there is no erosion or scour to wetlands and waters of the Commonwealth
- Supporting calculations specified in Volume 3 of the Massachusetts Stormwater Handbook included.



Checklist for Stormwater Report

Checklist (continued)

Standard 2: Peak Rate Attenuation

- Standard 2 waiver requested because the project is located in land subject to coastal storm flowage and stormwater discharge is to a wetland subject to coastal flooding.
- Evaluation provided to determine whether off-site flooding increases during the 100-year 24-hour storm.
- Calculations provided to show that post-development peak discharge rates do not exceed pre-development rates for the 2-year and 10-year 24-hour storms. If evaluation shows that off-site flooding increases during the 100-year 24-hour storm, calculations are also provided to show that post-development peak discharge rates do not exceed pre-development rates for the 100-year 24-hour storm.

Standard 3: Recharge

- Soil Analysis provided.
- Required Recharge Volume calculation provided.
- Required Recharge volume reduced through use of the LID site Design Credits.
- Sizing the infiltration, BMPs is based on the following method: Check the method used.
 - Static
 - Simple Dynamic
 - Dynamic Field¹
- Runoff from all impervious areas at the site discharging to the infiltration BMP.
- Runoff from all impervious areas at the site is *not* discharging to the infiltration BMP and calculations are provided showing that the drainage area contributing runoff to the infiltration BMPs is sufficient to generate the required recharge volume.
- Recharge BMPs have been sized to infiltrate the Required Recharge Volume.
- Recharge BMPs have been sized to infiltrate the Required Recharge Volume *only* to the maximum extent practicable for the following reason:
 - Site is comprised solely of C and D soils and/or bedrock at the land surface
 - M.G.L. c. 21E sites pursuant to 310 CMR 40.0000
 - Solid Waste Landfill pursuant to 310 CMR 19.000
 - Project is otherwise subject to Stormwater Management Standards only to the maximum extent practicable.
- Calculations showing that the infiltration BMPs will drain in 72 hours are provided.
- Property includes a M.G.L. c. 21E site or a solid waste landfill and a mounding analysis is included.

¹ 80% TSS removal is required prior to discharge to infiltration BMP if Dynamic Field method is used.



Checklist for Stormwater Report

Checklist (continued)

Standard 3: Recharge (continued)

- The infiltration BMP is used to attenuate peak flows during storms greater than or equal to the 10-year 24-hour storm and separation to seasonal high groundwater is less than 4 feet and a mounding analysis is provided.
- Documentation is provided showing that infiltration BMPs do not adversely impact nearby wetland resource areas.

Standard 4: Water Quality

The Long-Term Pollution Prevention Plan typically includes the following:

- Good housekeeping practices;
 - Provisions for storing materials and waste products inside or under cover;
 - Vehicle washing controls;
 - Requirements for routine inspections and maintenance of stormwater BMPs;
 - Spill prevention and response plans;
 - Provisions for maintenance of lawns, gardens, and other landscaped areas;
 - Requirements for storage and use of fertilizers, herbicides, and pesticides;
 - Pet waste management provisions;
 - Provisions for operation and management of septic systems;
 - Provisions for solid waste management;
 - Snow disposal and plowing plans relative to Wetland Resource Areas;
 - Winter Road Salt and/or Sand Use and Storage restrictions;
 - Street sweeping schedules;
 - Provisions for prevention of illicit discharges to the stormwater management system;
 - Documentation that Stormwater BMPs are designed to provide for shutdown and containment in the event of a spill or discharges to or near critical areas or from LUHPPL;
 - Training for staff or personnel involved with implementing Long-Term Pollution Prevention Plan;
 - List of Emergency contacts for implementing Long-Term Pollution Prevention Plan.
- A Long-Term Pollution Prevention Plan is attached to Stormwater Report and is included as an attachment to the Wetlands Notice of Intent.
 - Treatment BMPs subject to the 44% TSS removal pretreatment requirement and the one inch rule for calculating the water quality volume are included, and discharge:
 - is within the Zone II or Interim Wellhead Protection Area
 - is near or to other critical areas
 - is within soils with a rapid infiltration rate (greater than 2.4 inches per hour)
 - involves runoff from land uses with higher potential pollutant loads.
 - The Required Water Quality Volume is reduced through use of the LID site Design Credits.
 - Calculations documenting that the treatment train meets the 80% TSS removal requirement and, if applicable, the 44% TSS removal pretreatment requirement, are provided.



Checklist for Stormwater Report

Checklist (continued)

Standard 4: Water Quality (continued)

- The BMP is sized (and calculations provided) based on:
 - The ½" or 1" Water Quality Volume or
 - The equivalent flow rate associated with the Water Quality Volume and documentation is provided showing that the BMP treats the required water quality volume.
- The applicant proposes to use proprietary BMPs, and documentation supporting use of proprietary BMP and proposed TSS removal rate is provided. This documentation may be in the form of the propriety BMP checklist found in Volume 2, Chapter 4 of the Massachusetts Stormwater Handbook and submitting copies of the TARP Report, STEP Report, and/or other third party studies verifying performance of the proprietary BMPs.
- A TMDL exists that indicates a need to reduce pollutants other than TSS and documentation showing that the BMPs selected are consistent with the TMDL is provided.

Standard 5: Land Uses With Higher Potential Pollutant Loads (LUHPPLs)

- The NPDES Multi-Sector General Permit covers the land use and the Stormwater Pollution Prevention Plan (SWPPP) has been included with the Stormwater Report.
- The NPDES Multi-Sector General Permit covers the land use and the SWPPP will be submitted **prior to** the discharge of stormwater to the post-construction stormwater BMPs.
- The NPDES Multi-Sector General Permit does **not** cover the land use.
- LUHPPLs are located at the site and industry specific source control and pollution prevention measures have been proposed to reduce or eliminate the exposure of LUHPPLs to rain, snow, snow melt and runoff, and been included in the long term Pollution Prevention Plan.
- All exposure has been eliminated.
- All exposure has **not** been eliminated and all BMPs selected are on MassDEP LUHPPL list.
- The LUHPPL has the potential to generate runoff with moderate to higher concentrations of oil and grease (e.g. all parking lots with >1000 vehicle trips per day) and the treatment train includes an oil grit separator, a filtering bioretention area, a sand filter or equivalent.

Standard 6: Critical Areas

- The discharge is near or to a critical area and the treatment train includes only BMPs that MassDEP has approved for stormwater discharges to or near that particular class of critical area.
- Critical areas and BMPs are identified in the Stormwater Report.



Checklist for Stormwater Report

Checklist (continued)

Standard 7: Redevelopments and Other Projects Subject to the Standards only to the maximum extent practicable

- The project is subject to the Stormwater Management Standards only to the maximum Extent Practicable as a:
 - Limited Project
 - Small Residential Projects: 5-9 single family houses or 5-9 units in a multi-family development provided there is no discharge that may potentially affect a critical area.
 - Small Residential Projects: 2-4 single family houses or 2-4 units in a multi-family development with a discharge to a critical area
 - Marina and/or boatyard provided the hull painting, service and maintenance areas are protected from exposure to rain, snow, snow melt and runoff
 - Bike Path and/or Foot Path
- Redevelopment Project
- Redevelopment portion of mix of new and redevelopment.
- Certain standards are not fully met (Standard No. 1, 8, 9, and 10 must always be fully met) and an explanation of why these standards are not met is contained in the Stormwater Report.
- The project involves redevelopment and a description of all measures that have been taken to improve existing conditions is provided in the Stormwater Report. The redevelopment checklist found in Volume 2 Chapter 3 of the Massachusetts Stormwater Handbook may be used to document that the proposed stormwater management system (a) complies with Standards 2, 3 and the pretreatment and structural BMP requirements of Standards 4-6 to the maximum extent practicable and (b) improves existing conditions.

Standard 8: Construction Period Pollution Prevention and Erosion and Sedimentation Control

A Construction Period Pollution Prevention and Erosion and Sedimentation Control Plan must include the following information:

- Narrative;
 - Construction Period Operation and Maintenance Plan;
 - Names of Persons or Entity Responsible for Plan Compliance;
 - Construction Period Pollution Prevention Measures;
 - Erosion and Sedimentation Control Plan Drawings;
 - Detail drawings and specifications for erosion control BMPs, including sizing calculations;
 - Vegetation Planning;
 - Site Development Plan;
 - Construction Sequencing Plan;
 - Sequencing of Erosion and Sedimentation Controls;
 - Operation and Maintenance of Erosion and Sedimentation Controls;
 - Inspection Schedule;
 - Maintenance Schedule;
 - Inspection and Maintenance Log Form.
- A Construction Period Pollution Prevention and Erosion and Sedimentation Control Plan containing the information set forth above has been included in the Stormwater Report.



Checklist for Stormwater Report

Checklist (continued)

Standard 8: Construction Period Pollution Prevention and Erosion and Sedimentation Control (continued)

- The project is highly complex and information is included in the Stormwater Report that explains why it is not possible to submit the Construction Period Pollution Prevention and Erosion and Sedimentation Control Plan with the application. A Construction Period Pollution Prevention and Erosion and Sedimentation Control has **not** been included in the Stormwater Report but will be submitted **before** land disturbance begins.
- The project is **not** covered by a NPDES Construction General Permit.
- The project is covered by a NPDES Construction General Permit and a copy of the SWPPP is in the Stormwater Report.
- The project is covered by a NPDES Construction General Permit but no SWPPP been submitted. The SWPPP will be submitted BEFORE land disturbance begins.

Standard 9: Operation and Maintenance Plan

- The Post Construction Operation and Maintenance Plan is included in the Stormwater Report and includes the following information:
 - Name of the stormwater management system owners;
 - Party responsible for operation and maintenance;
 - Schedule for implementation of routine and non-routine maintenance tasks;
 - Plan showing the location of all stormwater BMPs maintenance access areas;
 - Description and delineation of public safety features;
 - Estimated operation and maintenance budget; and
 - Operation and Maintenance Log Form.
- The responsible party is **not** the owner of the parcel where the BMP is located and the Stormwater Report includes the following submissions:
 - A copy of the legal instrument (deed, homeowner's association, utility trust or other legal entity) that establishes the terms of and legal responsibility for the operation and maintenance of the project site stormwater BMPs;
 - A plan and easement deed that allows site access for the legal entity to operate and maintain BMP functions.

Standard 10: Prohibition of Illicit Discharges

- The Long-Term Pollution Prevention Plan includes measures to prevent illicit discharges;
- An Illicit Discharge Compliance Statement is attached;
- NO Illicit Discharge Compliance Statement is attached but will be submitted **prior to** the discharge of any stormwater to post-construction BMPs.

1.0 OVERVIEW

1.1 PROJECT PURPOSE

Under this project, the City proposes to backfill a portion of the Chicopee Falls Local Protection Project easement and adjacent upland areas in order to facilitate future redevelopment of the former Uniroyal and Facemate properties (the "Site"). As a result of these proposed measures, existing stormwater runoff characteristics will be altered. In accordance with the Massachusetts Stormwater Handbook and best engineering practices, this Stormwater Management Report will outline the proposed modifications to the Site's stormwater management systems implemented to maintain the integrity of the Flood Control System and the Chicopee River.

1.2 CONTACT INFORMATION

City Chicopee
274 Front Street, 4th Floor City Hall Annex, Chicopee, MA 01013
Attn: Lee Pouliot, AICP, ASLA, Director of Planning & Development
Tel: (413) 594-1515

1.3 PROJECT DESCRIPTION

The project site is a portion of the former Uniroyal Site, located at 154 Grove Street, and the former Facemate Site (also known as the "Baskin Parcel") located at 75 West Main Street, both located in the City of Chicopee, MA (the "Site"). The City of Chicopee Assessor's Office identifies the properties as Lots 124-00003, 124-00012, 143-00001, 147-00006, 147-00009, 147-00010, and 202-0015A. The properties are generally zoned as Industrial with a small strip of land zoned as Residential A (Refer to Figure 1: Site Locus).

The Site is situated along the Chicopee River, bounded by the river to the west and Front Street, Grove Street, Oak Street, and West Main Street to the east. Historic use at the Site primarily included mill buildings used for various manufacturing operations since the late 1800s. Since acquisition of the lots by the City of Chicopee circa 2009, the majority of the former mill buildings have been demolished and environmental clean-up operations are currently being conducted throughout the Site. As of July 2020, seven large buildings remain at the Site, of which two (Buildings 15 and 29) are proposed to be demolished while the rest are to be retained.

This stormwater analysis has been prepared to support a fill operation along the western boundary of the Site. The fill area is a low-lying portion of the Site adjacent to an existing flood control levee. Constructed circa 1938-1942, the levee is a portion of the "Chicopee Falls Local Protection Project" and mitigates risk of flooding from the Chicopee River. The top-of-levee elevations range from 98' +/- to 100' +/- in this area. A flood control easement is present directly east of the levee, where several drainage systems are in place to control stormwater behind the levee. Catch basins, drain inlets, interceptor drains, and a toe drain collect runoff from this low-lying area and divert it to either the Main Street Pump Station (from the Facemate Property) or the Oak Street Pump Station (from the Uniroyal Property). Both pump stations discharge stormwater runoff to the Chicopee River.

1.4 ADDITIONAL DATA SOURCES

- Report entitled "Chicopee Falls Local Protection Project," Design Memoranda No. 1 through 6. Prepared by US Army Engineer Division, New England Corps of Engineers, dated December 1962.
- Letter entitled "Chicopee Levee Slope Stability" prepared by O'Reilly, Talbot, & Okun Associates (OTO), dated May 12, 2021.

2.0 EXISTING CONDITIONS DESCRIPTION

The existing Site is currently vacant, apart from Lot 124-00012 which is used as a business and “Building C” on Lot 143-0001 which is used as storage by the Chicopee Police Department. The majority of the Site’s land area beyond the vacant buildings is bare soil, grass, or limited vegetation. Former buildings have been remediated, demolished, and their footprints backfilled. Paved and unpaved driveways provide access to various portions of the Site. Miscellaneous site features include utility poles with overhead wire, a perimeter fence, and erosion controls.

Stormwater management is accomplished generally through several closed drainage systems throughout the Site, and include four primary discharge points:

- The Oak Street Pump Station, located on the southwestern portion of the Uniroyal Property
- The Main Street Pump Station, located approximately 570 ft. north of the Facemate Property.
- An outfall located at the southwestern corner of the Uniroyal Property which discharges to the Chicopee River (Hereafter referred to as the “South Outfall”)
- An outfall located on Lot 0202-0015A just south of the Facemate Property which discharges to the Chicopee River (Hereafter referred to as the “North Outfall”)

Stormwater runoff from the eastern (“Upper”) portions of the Uniroyal property are conveyed through a catch basin – manhole system and directed to the South Outfall. Stormwater runoff from the western (“Lower” and “Middle”) portions of the Uniroyal property is conveyed via overland flow to the area adjacent to the flood control levee. This stormwater is then collected either by catch basins associated with the “interceptor drain,” or an underground toe drain that collects groundwater. Both the toe drain and interceptor drain convey stormwater to the Oak Street Pump Station where it is discharged to the Chicopee River. Stormwater runoff from Uniroyal Buildings 26 and 27 is collected via a roof drain system and conveyed to the Oak Street Pump Station as well. Stormwater runoff in the northeastern portion of the Uniroyal property is conveyed via catch basin connections to the drainage system beneath Oak Street, but this area is outside the limit of work for this project.

Stormwater runoff from the Facemate property is conveyed via overland flow to the area adjacent to the flood control levee. This stormwater is then collected either by catch basins associated with the “interceptor drain,” or an underground toe drain that collects groundwater. Both the toe drain and interceptor drain convey runoff to the Main Street Pump Station, where it is discharged to the Chicopee River. Some stormwater runoff from the eastern portions of the Facemate property may also be captured by a series of catch basins that convey flow to the North Outfall. However, the Site is generally not graded towards these drain inlets and no alterations are proposed to their catchment area.

A further description of the stormwater runoff characteristics with respect to the HydroCAD model and Watershed Plans is provided in Section 4.4 below.

Topography at the Site is generally graded to the west towards the low-lying area adjacent to the flood control levee. Due to ongoing demolition and remediation work, several areas of uneven grading are present throughout the property; however long-term grading is assumed to result in these areas being backfilled and graded westward. A portion of the Site is within the 200’ Riverfront Area associated with the Chicopee River. The area west of the levee is classified as a regulatory floodway. No wetlands or other resource areas are known to exist on the property (Refer to Figures 2 and 3).

Natural Resources Conservation Service soil maps indicate soils in the project area are considered Urban land and is not designated a Hydrologic Soil Group (HSG). As a conservative measure, HSG D has been applied to the hydrologic calculations. This ensures that proposed basins are sized to reflect a worst-case scenario. Refer to Appendix C for relevant NRCS Soil Maps.

3.0 PROPOSED CONDITIONS WITH MITIGATION

This project proposes to backfill a portion of the low-lying area behind the flood control levee in order to facilitate future redevelopment of the Site. Backfill material may include contaminated soils or other materials in accordance with the City's Fill Management Plan, to be overseen by a Licensed Site Professional (LSP). Backfill material will be "Capped" with geotextile fabric and 3' of clean fill, except where deemed unnecessary by the LSP. Clean fill material will include loam and seed to establish turf for stability and erosion control.

The Oak Street Pump Station and its associated discharge pipe are proposed to be decommissioned, partially demolished, and abandoned in place. The existing interceptor and toe drains will be abandoned in place with existing inverts plugged. The abandonment of these systems is based on the results of a geotechnical analysis by OTO indicating that levee stability will be maintained without a functioning toe drain.

To manage stormwater, the interceptor drain will be replaced with several infiltration basins proposed along the western side of the properties, generally 3' – 5' below the top of the levee. These infiltration basins will retain stormwater runoff and discharge into a new catch basin to manhole drainage system. Stormwater runoff collected within the Uniroyal Property will be conveyed to the South Outfall, while that collected within the Facemate Property will be conveyed to the Main Street Pump Station. No alterations are proposed to the upgradient portions of the Uniroyal and Facemate Properties, and the existing drainage systems in these areas will continue to function. However, stormwater runoff previously conveyed to the Oak Street Pump Station will instead be directed to the new drainage system.

Proposed perforated drain pipes connecting the manholes will be located within crushed stone. These pipes and the crushed stone are intended to capture any groundwater that may build up behind the levee per geotechnical engineer recommendations. Note that a full evaluation of pre- and post-development levee stability is to be conducted under a separate report.

The proposed system also includes the abandonment of a 24" RCP "Bypass" drain pipe located between the Facemate and Uniroyal Sites. Per discussions with the City and record plans, this pipe was used to convey process water to the Uniroyal Site. At the time of this report, the pipe has not been during the preceding 19 years and it is anticipated that the North Outfall will be sufficient to discharge any flows in the Facemate drainage system.

4.0 CALCULATIONS AND ASSUMPTIONS

4.1 OBJECTIVES

The calculations presented in this report are an analysis of site hydrology and stormwater runoff, including scenarios for both Pre- and Post-Development conditions. The project is considered a redevelopment project and the objective of this analysis is to demonstrate that measures have been implemented to comply with the Massachusetts Stormwater Management Standards and City of Chicopee Stormwater requirements to the maximum extent practicable. Analysis of the Existing and Proposed Conditions is included for the one (1), two (2), ten (10), twenty-five (25), and one hundred (100) year rainfall events. A description of the project and how it relates to the ten Stormwater Management Standards is included.

4.2 CALCULATION METHODS

Stormwater runoff is analyzed using the following:

- "HydroCAD™ Stormwater Modeling System," by Applied Microcomputer Systems based upon SCS Technical Releases No. 55 and 20 for generating hydraulic calculations including peak flows and runoff volumes

4.3 EQUATIONS AND SOURCES OF DATA USED

Rainfall for the Pre-development Facemate parcel obtained via Technical Paper 40 (TP-40 Hampden County) to reflect original design calculations for the Main Street Pumping Station

1 yr. = 2.50 in. 2 yr. = 3.00 in. 10 yr. = 4.60 in. 25 yr. = 5.30 in. 100 yr. = 6.50 in.

For all other calculations, rainfall data obtained via NOAA Atlas-14, Volume 10, Version 3: Chicopee, MA

1 yr. = 2.48 in. 2 yr. = 3.12 in. 10 yr. = 5.04 in. 25 yr. = 6.23 in. 100 yr. = 8.07 in.

Refer to Appendix G for rainfall data.

4.4 POINTS OF ANALYSIS

POA1L – Into an existing Interceptor Drain, towards the Main St. Pump Station.

- Receives runoff from the Facemate property (Watershed 1S or 1Sa and 1Sb).
- In the pre-development conditions, runoff is collected in a low-lying area with drain inlets (Pond 1P).
- In the post-development conditions, runoff is collected in two new infiltration basins with catch basins (Ponds 1Pa and 1Pb) and directed through a new run of HDPE pipe (Reaches 1Ra, 1Rb, and 1R).

POA2L – Into the Chicopee River, west of the Uniroyal Property

- Receives stormwater runoff from the lower/middle Uniroyal property (Watershed 2S or 2Sa, 2Sb, and 2Sc), the Upper Uniroyal property (Watershed 3S), and Buildings 26/27 (Watershed B26, B27).
- In the pre-development conditions, stormwater from Watershed 2S is collected in a low-lying area with drain inlets (Pond 2P) then directed to the Oak Street Pump Station (POA 2La) for discharge to the Chicopee River (POA 2L). Watersheds B26 and B27 convey stormwater through roof leaders and drain pipes directly to POA 2La. Watershed 3S is collected by a closed drainage system and directed through a 30" RCP outfall (Reach 3R) to the Chicopee River (POA 2L).
- In the post-development conditions, stormwater from Watershed 2Sa, 2Sb, and 2Sc is collected in three new infiltration basins (Ponds 2Pa, 2Pb, and 2Pc) then directed through new drain pipes (Reaches 2Ra, 2Rb, 2Rc) to a new discharge pipe (Reach 2R). Stormwater runoff from B26 and B27 is also directed to Reach 2R. Stormwater from Reach 2R as well as Watershed 3S (unchanged) is directed to the existing 30" RCP outfall (Reach 3R) for discharge to the Chicopee River (POA 2L).

4.5 CALCULATIONS

Refer to Appendix D for figures showing the pre- and post- development watersheds. Refer to Appendices E and F for copies of the pre- and post-development HydroCAD calculations. Additional calculations relating to the design are provided in Appendix G.

4.6 SOIL CHARACTERISTICS

The proposed design will include the construction of infiltration basins atop a newly backfilled area. As such, the soil directly beneath the infiltration basins will be entirely new material and existing soil characteristics cannot be used to evaluate infiltration potential.

Volume 3, Chapter 1, Page 22 of the Massachusetts Stormwater Handbook identifies the "Rawl's Rates," standard infiltration rates associated with common soil classifications. These soil classifications are detailed in the USDA soil textural triangle, provided on Volume 3, Chapter 1, Page 14 of the Massachusetts Stormwater Handbook.

The design of the infiltration basins stipulates that the basin subbase will contain a maximum clay composition of 20% and a maximum silt concentration of 50%. Based on the textural triangle, this will result in a soil classification of Sandy Loam, Loamy Sand, or Sand with infiltration rates of 1.02 in/hr. or greater.

In addition, basin drawdown will primarily be accomplished via the catch basin inlet provided in each infiltration basin, rather than depending on soil infiltration.

4.7 ASSUMPTIONS AND LIMITATIONS

This stormwater analysis includes only the aforementioned backfill activities and associated alterations. It does not include any future redevelopment of the Sites which would require a separate analysis.

This analysis also includes several conservative design assumptions. Firstly, it was assumed that many upgradient areas would drain into the proposed basin areas, even though they may instead be captured by local low points or catch basins. This ensures that the design will function in the event of future, minor grading activities. Secondly, the flowpaths were considered only for the portion of the Site that will be altered, as existing grading would otherwise result in a long, sinuous flowpath that may not reflect future conditions.

5.0 SUMMARY OF RESULTS

Peak Rate of Runoff		Flow (cubic feet per second)									
		1-Year Storm		2 Year Storm		10 Year Storm		25 Year Storm		100 Year Storm	
Outlet To:		Exist	Prop	Exist	Prop	Exist	Prop	Exist	Prop	Exist	Prop
POA1	Main St. Pump Sta	5.76	3.38	6.76	4.87	9.42	7.75	10.38	9.13	11.81	10.87
POA2	Chicopee River	15.73	10.40	19.41	15.36	29.98	28.13	36.17	34.72	45.39	44.38
Project Total:		21.49	13.74	26.17	20.21	39.40	35.87	46.55	43.84	57.20	55.26

Runoff Volume		Runoff Volume (Acre-Feet)									
		1-Year Storm		2 Year Storm		10 Year Storm		25 Year Storm		100 Year Storm	
Outlet To:		Exist	Prop	Exist	Prop	Exist	Prop	Exist	Prop	Exist	Prop
POA1	Main St. Pump Sta	0.606	0.420	0.792	0.626	1.413	1.313	1.692	1.766	2.176	2.486
POA2	Chicopee River	2.417	1.699	3.302	2.466	6.056	4.987	7.798	6.636	10.513	9.251
Project Total:		3.02	2.12	4.09	3.09	7.47	6.30	9.49	8.40	12.69	11.74

*Increase in runoff volume is the result of the increased precipitation rates used in the post-development model to better reflect actual site conditions (Refer to Section 4.3). If Atlas-14 rates are used for the pre-development model, the runoff volumes for these storm events are 2.067 acre-feet and 2.816 acre-feet for the 25- and 100-year storm events, respectively.

Supplemental Calculations:

(Refer to Appendix G)

Recharge Volume Required = 0 cu. ft. (No loss of recharge as no new impervious area proposed)

Recharge Volume Provided = 0 cu. ft. (Infiltration in basins assumed to be captured by perforated pipe)

Water Quality Volume Required:

Facemate Property: 709 cu. ft.
Uniroyal Property: 2,745 cu. ft.

Water Quality Volume Provided:

Facemate Property: 1,865 cu. ft.
Uniroyal Property: 3,235 cu. ft.

Existing TSS Removal Rate = 0 %

Proposed TSS Removal Rate = 44% (Refer to Section 7.0)

6.0 COMMENTS AND CONCLUSIONS

As a result of the proposed mitigation measures, stormwater runoff will be captured, peak flows will be controlled, and water quality volume will be provided. The provided analysis has demonstrated that there will be no adverse impacts as a result of the project. The proposed stormwater management Best Management Practices have been designed to meet the DEP's Stormwater Management Policy to the maximum extent practicable. Summaries of compliance with the ten DEP Stormwater Management Standards and City of Chicopee's Stormwater Management Rules are provided in the following sections.

7.0 SUMMARY OF COMPLIANCE WITH TEN STORMWATER MANAGEMENT STANDARDS

The City of Chicopee is proposing alterations at the Former Uniroyal and Facemate Properties in Chicopee, MA. The following summary has been prepared to illustrate the project's conformance with MassDEP's Stormwater Management Standards. Note that the project is a redevelopment project and need only meet certain standards the maximum extent practicable.

Standard 1: No New Untreated Discharges

No new stormwater conveyances (e.g., outfalls) may discharge directly untreated stormwater directly to or cause erosion in wetlands or waters of the Commonwealth

No new untreated discharges to wetlands are created as part of this project. Existing site conditions currently allow runoff to flow, untreated, into the Chicopee River. The redevelopment proposes to capture and provide limited treatment of this runoff within infiltration basins and deep sump catch basins. Runoff discharged from the Uniroyal property will be conveyed to an existing outfall with outlet control protection that discharges to the Chicopee River. Runoff discharged from the Facemate property will be conveyed to the Main Street Pump Station.– project complies.

Standard 2: Peak Rate Attenuation

Stormwater management systems shall be designed so that the post-development peak discharge rates do not exceed pre-development peak discharge rates.

The proposed design results in a net decrease to impervious area to prevent an increase in peak discharge rates, and many barren areas on the Site will be revegetated. The proposed infiltration basins are designed to capture and control the release of stormwater runoff. A net decrease in peak runoff rate and runoff volume is anticipated as part of the project – project complies.

Standard 3: Recharge

Loss of annual recharge to groundwater shall be eliminated or minimized. At a minimum, the annual recharge from the post-development site shall approximate the annual recharge from pre-development conditions based on soil type.

As no new impervious areas are proposed, there will be no loss in annual recharge from the post-development site compared to pre-development conditions. The re-vegetation of existing impervious area will improve the Site's ability to infiltrate runoff. – project complies.

Standard 4: Water Quality

Stormwater management systems shall be designed to remove 80% of the average annual post-construction load of Total Suspended Solids.

In accordance with this standard, the project is required to store a "water quality volume" equal to 0.5-inches of runoff times the total impervious area of the post-development site. The catch basins within the

proposed infiltration basins have been designed to be up to 6 inches above the basin bottom to provide the required water quality volume. Appendix B includes a Long-Term Pollution Prevention Plan.

The proposed treatment train includes deep sump drainage structures to provide limited TSS removal that does not currently exist. Although infiltration basins are proposed, they have been modeled as sediment forebays in the TSS Removal Calculations as no pretreatment has been provided.

While a TSS removal of 80% has not been achieved, the post-development project site will remain vacant, and no vehicle traffic areas will discharge to the proposed BMPs. Sedimentation potential is thus limited. Future site redevelopment activities will be required to meet the 80% TSS removal requirement. – project complies to the maximum extent practicable.

Standard 5: Land Uses with Higher Potential Pollutant Loads (LUHPPLs)

Land use with high potential pollutant loads must have source control and pollution prevention measures implemented in accordance with the Massachusetts Stormwater Handbook.

The Site includes former mill buildings known to contain potentially hazardous substances. Ongoing remediation efforts may involve handling of these materials, and measures to prevent spills or exposure will be required of each remediation plan. Backfill operations under this project may include contaminated materials which will be handled in accordance with the Massachusetts Contingency Plan (MCP) and other local, state, and federal guidelines. These pollutant sources are anticipated only during the construction period, and in the long-term the project Site will not be classified as a LUHPPL. A basic Spill control and prevention plan is included in Appendix B. - project complies to the maximum extent practicable

Standard 6: Critical Areas

Stormwater discharges within the Zone II or Interim Wellhead Protection Area of a public water supply and stormwater discharges near or to any other critical area require the use of specific source control, pollution prevention measures.

The project does not propose discharges to a critical area. - project complies

Standard 7: Redevelopment

A redevelopment project is required to meet certain Stormwater Management Standards only to the maximum extent practicable.

The project is a redevelopment project under the definition of (2): "Development, rehabilitation, expansion, and phased projects on previously developed sites, provided the redevelopment results in no net increase in impervious area." Certain standards have been met only to the maximum extent practicable as noted in previous sections.

Standard 8: Construction Period Pollution Prevention and Erosion and Sediment Control

A plan to control construction related impacts, including erosion, sedimentation, and other pollutant sources during construction and land disturbance activities shall be developed and implemented.

The project will disturb greater than one acre and thus will require the development of a Stormwater Pollution Prevention Plan (SWPPP) prior to construction. Note that SWPPPs have been previously prepared and submitted for the project Sites under NDPE ID MAR1000LL and MAR1000XS. These SWPPP's may need to be updated to reflect current site conditions and proposed improvements. A Construction Period Pollution Prevention and Sediment Control Plan has been provided as Appendix A of this report.

Standard 9: Long Term Operation and Maintenance Plan

A Long-Term Operation and Maintenance Plan shall be developed and implemented to ensure that stormwater management systems function as designed.

Operations and Maintenance of Stormwater management systems will be the responsibility of the City of Chicopee. Therefore, inspection and maintenance of the stormwater management system will be in accordance with a Regulator-Approved version of the attached Operation and Maintenance Plan.

Standard 10: Prohibition of Illicit Discharges

All illicit discharges to the stormwater management system are prohibited.

There are currently no known non-stormwater illicit discharges within the project limits and new discharges are prohibited. An illicit discharge compliance statement is attached.

8.0 SUMMARY OF COMPLIANCE WITH STORMWATER MANAGEMENT RULES

The following summary has been prepared to illustrate the project's conformance with the fourteen objectives detailed in Chapter 231 of the City of Chicopee bylaw.

Objective 1: Reduce the adverse water quality impacts of stormwater and combined sewer overflow discharges to rivers, lakes, reservoirs, and streams in order to attain federal water quality standards.

Existing stormwater is currently directed to the Chicopee River and the Main Street Pump Station. The proposed design will continue to discharge to these locations. A net decrease in runoff volume and peak discharge rate is anticipated. The project has been designed to maintain the required water quality volume, and TSS removal will be improved compared to existing conditions.– project complies.

Objective 2: Prevent the Discharge of Pollutants, including hazardous chemicals into stormwater runoff.

The proposed design incorporates deep sump, hooded drainage structures and infiltration basins to minimize the risk of pollution to stormwater runoff from the Site. No hazardous chemicals are anticipated to be present at the Site during normal operation. Refer to the Illicit Discharge Compliance Statement. – project complies.

Objective 3: Minimize the volume and rate of stormwater which is discharged to rivers, streams, reservoirs, lakes, and combined sewers.

The proposed design incorporates several infiltration basins to capture, store, and control runoff coupled with a decrease in impervious area. A net decrease in peak runoff rate and volume from all watersheds up to the 100-year storm is anticipated as part of the project – project complies.

Objective 4: Prevent erosion and sedimentation form improper land development, and reduce stream channel erosion caused by increased runoff.

The proposed design incorporates basic erosion controls consisting of straw wattles, stabilized construction entrance, and inlet protection minimize sedimentation and erosion from the Site. The project will disturb greater than one acre and will require the development of a detailed Stormwater Pollution Prevention Plan (SWPPP) prior to construction. – project complies.

Objective 5: Provide for recharge of groundwater aquifers and maintain the base flow of streams.

The project proposes a reduction in impervious area. As a result, an improvement in recharge potential is anticipated. – project complies.

Objective 6: Provide stormwater facilities that are attractive, maintain the natural integrity of the environment, and are designed to protect public safety.

Proposed infiltration basins are intended to blend in with proposed topography and minimize visual impact. Basin depths are typically no greater than 4' below surrounding grades to mitigate public safety concerns – project complies.

Objective 7: Maintain or reduce predevelopment runoff characteristics after development to the extent feasible.

Both pre- and post-development runoff characteristics are directed to a low-lying area behind the flood control levee. – project complies.

Objective 8: Minimize damage to public and private property from flooding.

The proposed infiltration basins have been designed to capture the 100-year storm with a 1' freeboard. A net decrease in peak runoff rate and runoff volume is anticipated from all watersheds.– project complies.

Objective 9: To prevent pollutants from entering Chicopee's municipal separate storm sewer system (MS4).

The project does not propose any alterations near to the City's MS4 system. Inlet protection is proposed at existing catch basins near the Site. – project complies.

Objective 10: To prohibit illicit connections and unauthorized discharges to the MS4 and;

Objective 11: To require the removal of all such illicit connections.

There are currently no known non-stormwater illicit discharges within the project limits and new discharges are prohibited. Refer to attached Illicit Discharge Compliance Statement. – project complies.

Objective 12: To comply with state and federal statutes and regulations relating to stormwater discharges.

The proposed stormwater management Best Management Practices have been designed to fully meet the DEP's Stormwater Management Policy as detailed in Section 6.0. – project complies.

Objective 13: To establish the legal authority to ensure compliance through inspection, monitoring, and enforcement.

The responsible party for operation and maintenance of the stormwater design is The City of Chicopee. A long-term operation and maintenance plan is provided as Appendix B. – project complies.

Objective 14: To prevent contamination to drinking water supplies

No private drinking water wells are located within 500 feet of the Site. The Site is not within an Interim Wellhead Protection Area, Zone II, or Potentially Productive Aquifer. No risk of contamination to drinking water supplies is anticipated as part of this project. – project complies.

Illicit Discharge Compliance Statement

It is the intent of the Owner, the City of Chicopee to prevent illicit discharges to the stormwater management system, including wastewater discharges and discharges of stormwater contaminated by contact with process wastes, raw materials, toxic pollutants, hazardous substances, oil, or grease. To the extent of my knowledge, the proposed project does not create any illicit discharges and all illicit discharges are prohibited in the future.

City of Chicopee

FIGURES

3



PROJECT LOCUS

0 375 750 1,500 Feet



Former Uniroyal
and Facemate Properties

Chicopee, MA

Figure 1

Site Locus Map

MassDEP - Bureau of Waste Site Cleanup

Phase 1 Site Assessment Map: 500 feet & 0.5 Mile Radii

Site Information:

CHICOPEE, MA

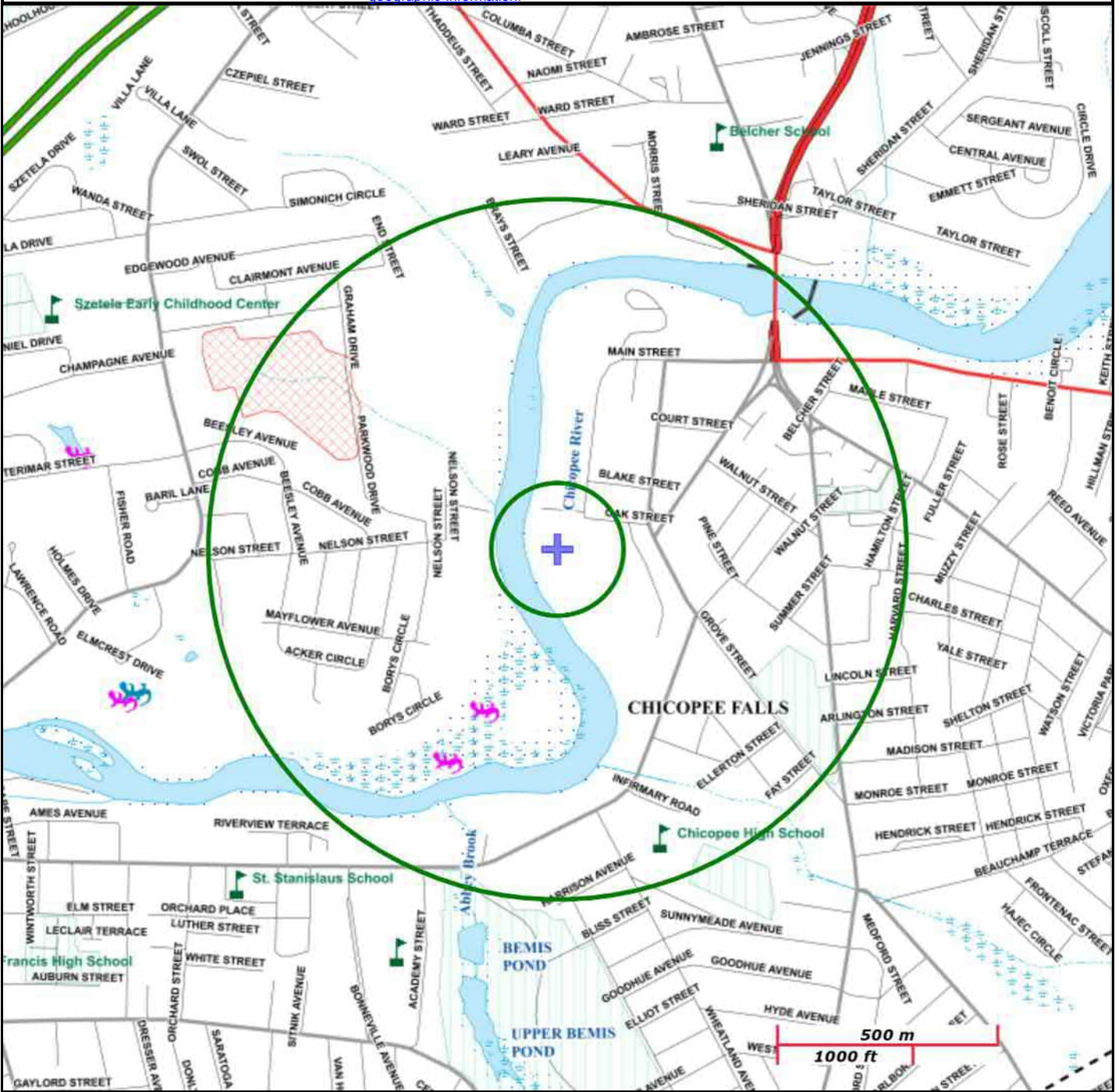
NAD83 UTM Meters:

4669758mN, 699281mE (Zone: 18)
July 17, 2020

The information shown is the best available at the date of printing. However, it may be incomplete. The responsible party and LSP are ultimately responsible for ascertaining the true conditions surrounding the site. Metadata for data layers shown on this map can be found at: <https://www.mass.gov/orgs/massgis-bureau-of-geographic-information>.



MassDEP
Commonwealth of Massachusetts
Department of Environmental Protection

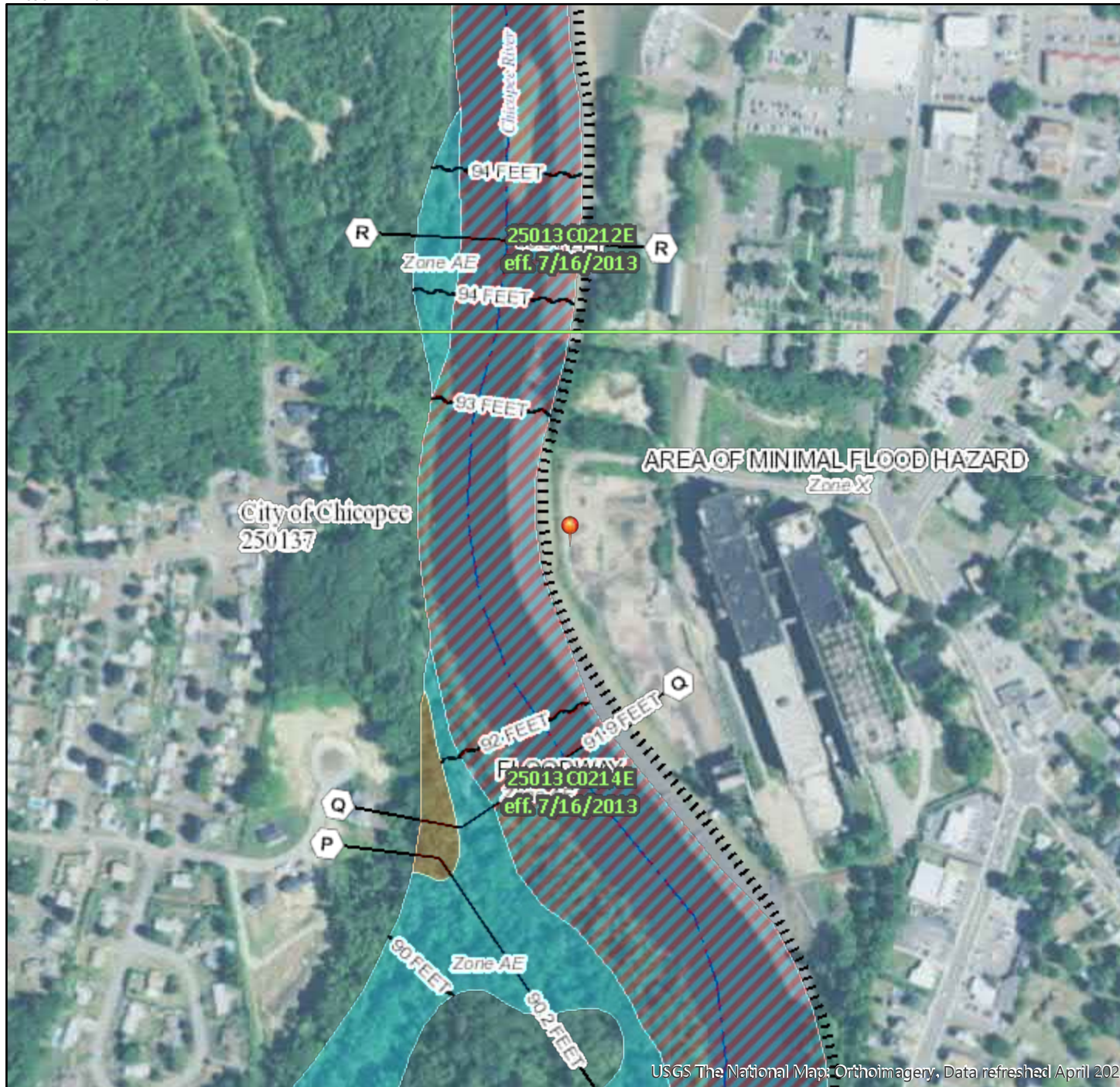


Roads: Limited Access, Divided, Other Hwy, Major Road, Minor Road, Track, Trail	PWS Protection Areas: Zone II, IWPA, Zone A			
Boundaries: Town, County, DEP Region; Train; Powerline; Pipeline; Aqueduct	Hydrography: Open Water, PWS Reservoir, Tidal Flat			
Basins: Major, PWS; Streams: Perennial, Intermittent, Man Made Shore, Dam	Wetlands: Freshwater, Saltwater, Cranberry Bog			
Aquifers: Medium Yield, High Yield, EPA Sole Source	FEMA 100yr Floodplain; Protected Open Space; ACEC			
Non Potential Drinking Water Source Area: Medium, High (Yield)	Est. Rare Wetland Wildlife Hab; Vernal Pool: Cert., Potential			
	Solid Waste Landfill; PWS: Com. GW, SW, Emerg., Non-Com.			

National Flood Hazard Layer FIRMMette



72°35'37"W 42°9'31"N



72°34'59"W 42°9'4"N

Legend

SEE FIS REPORT FOR DETAILED LEGEND AND INDEX MAP FOR FIRM PANEL LAYOUT

SPECIAL FLOOD HAZARD AREAS		Without Base Flood Elevation (BFE) Zone A, V, A99
		With BFE or Depth Zone AE, AO, AH, VE, AR
		Regulatory Floodway

OTHER AREAS OF FLOOD HAZARD		0.2% Annual Chance Flood Hazard, Areas of 1% annual chance flood with average depth less than one foot or with drainage areas of less than one square mile Zone X
		Future Conditions 1% Annual Chance Flood Hazard Zone X
		Area with Reduced Flood Risk due to Levee. See Notes. Zone X
		Area with Flood Risk due to Levee Zone D

OTHER AREAS		NO SCREEN Area of Minimal Flood Hazard Zone X
		Effective LOMRs
GENERAL STRUCTURES		Area of Undetermined Flood Hazard Zone D
		Channel, Culvert, or Storm Sewer
		Levee, Dike, or Floodwall

OTHER FEATURES		20.2 Cross Sections with 1% Annual Chance Water Surface Elevation
		17.5 Coastal Transect
		Base Flood Elevation Line (BFE)
		Limit of Study
		Jurisdiction Boundary
		Coastal Transect Baseline
		Profile Baseline
		Hydrographic Feature

MAP PANELS		Digital Data Available
		No Digital Data Available
		Unmapped
		The pin displayed on the map is an approximate point selected by the user and does not represent an authoritative property location.



This map complies with FEMA's standards for the use of digital flood maps if it is not void as described below. The basemap shown complies with FEMA's basemap accuracy standards

The flood hazard information is derived directly from the authoritative NFHL web services provided by FEMA. This map was exported on 7/17/2020 at 12:48 PM and does not reflect changes or amendments subsequent to this date and time. The NFHL and effective information may change or become superseded by new data over time.

This map image is void if the one or more of the following map elements do not appear: basemap imagery, flood zone labels, legend, scale bar, map creation date, community identifiers, FIRM panel number, and FIRM effective date. Map images for unmapped and unmodernized areas cannot be used for regulatory purposes.

***APPENDIX A – CONSTRUCTION PERIOD
POLLUTION PREVENTION AND EROSION AND
SEDIMENTATION CONTROL PLAN***

Construction Period Pollution Prevention and Erosion Control Plan

Former Uniroyal and Facemate Properties – Chicopee MA
ACOE Permit Review Only

Introduction

The anticipated area of disturbance during this project is greater than one acre; therefore, filing a notice of intent with EPA and development of a Stormwater Pollution Prevention Plan (SWPPP) is required. The following plan provides general guidance for the prevention of pollution and erosion and sedimentation during construction.

Potential Erosion and Sedimentation

Portions of the project involve soil disturbance; therefore, site preparation, scheduling, and construction practices need to be carefully planned to prevent construction debris and erosion from adversely impacting downstream resources. Although it is not always possible to avoid all impacts, the following guidelines shall be followed:

- Minimize land disturbance area and soil exposure to stormwater and wind erosion.
- Minimize time that area is disturbed.
- Avoid routing stormwater runoff or dewatering flows through disturbed areas.
- Inspect and maintain erosion controls until all soils are stabilized.
- Maintain good housekeeping practices.
- Stabilize disturbed soils as soon as possible to limit exposure.

Erosion and Sedimentation Plan

This Construction Period Pollution Prevention and Erosion and Sedimentation Control Plan have been prepared in accordance with the Department of Environmental Protection's Massachusetts Erosion and Sedimentation Guidelines for Urban and Suburban Areas.

Pre-Construction and Site Preparation

- Contractor shall install all erosion control barriers in accordance with the construction documents prior to commencing any land disturbance activity.
- Inspect and maintain erosion controls until all soils are stabilized.
- Monitor weather reports daily and stabilize/prepare site if storm event in excess of the 2-year storm is expected.

Good Housekeeping

- Avoid stockpiling of soil within 100 feet of wetland resources and wellhead protection areas. If necessary, provide sufficient erosion controls to prevent migration of sediments.
- Minimize hazardous materials stored on site. All materials stored on site shall be stored in original containers and sealed.
- Refuel construction equipment off-site.
- Any spills of hazardous materials shall be reported, contained, and removed in accordance with local, State, and Federal regulations.



Construction Period Pollution Prevention and Erosion Control Plan

Former Uniroyal and Facemate Properties – Chicopee MA
ACOE Permit Review Only

Inspection and Maintenance of Erosion Controls during Construction

Inspect erosion controls weekly and after every storm event until all soils are stabilized.

- Erosion Control Barrier: Check for sedimentation accumulation, removing sediments when they reach excessive volumes (approximately 1/3 the height of the barrier). Also remove sediments when runoff ponds for 24 or more hours to prevent potential mosquito breeding habitat. Restake/replace tubes and silt fence as necessary to maintain their effectiveness.
- Stabilized Construction Entrance: Check to observe overall integrity and effectiveness of crushed stone entrance. Reshape pad as needed for drainage and runoff control, and top dress with clean stone if needed. Remove tracked-out sediment by the end of each workday.
- Catch basin Inlet Protection: Check for sedimentation accumulation, removing sediments when they reach excessive volumes.

Plans

See proposed construction drawings for locations of all proposed erosion and sedimentation controls.

Potential Construction Site Pollutants

Pollutant-Generating Activity	Pollutants or Pollutant Constituents	Location on Site
Equipment Re-fueling	Diesel Fuel, Gasoline	Staging Area*
Leaking or Broken Hydraulic Lines	Hydraulic Oil	Building Work Areas and Laydown Area
Minor Equipment Maintenance	Diesel Fuel, Gasoline, Hydraulic Oil, Motor Oil, Anti-Freeze	Staging Area*
Applying Fertilizer	Nitrogen, Phosphorous	Newly Seeded Areas
Portable Sanitary Toilets	Bacteria, Parasites and Viruses	Staging Area*
Vehicle Accident	Diesel Fuel, Gasoline	Entire Site
Trash Containers/Dumpsters	Paper, Plastic, and Food Waste	Staging Area*

*All vehicle and equipment staging to be conducted within the central and lower areas of Site.

***APPENDIX B – LONG TERM OPERATION
AND MAINTENANCE PLAN***

Long Term Operation & Maintenance Plan Stormwater Management Systems

Former Uniroyal and Facemate Properties – Chicopee, MA
ACOE Permit Review Only

General Information

Project Name: Former Uniroyal and Facemate Properties
Project Type: Site Redevelopment
Address: 154 Grove Street & 75 West Main Street, Chicopee MA
SWMS Owner: City of Chicopee
274 Front Street, 4th Floor City Hall Annex
Chicopee, MA 01013
(413) 594-1515
Responsible Party: City of Chicopee
Contact: Lee Pouliot, AICP, ASLA
Signature: _____

This stormwater management system (SWMS) operations and maintenance plan has been prepared in accordance with the Massachusetts Department of Environmental Protection's Stormwater Management Standards.

It shall be the responsibility of the Owner to provide a revised plan indicating any change of ownership or responsible party.

Long Term Operation & Maintenance Plan Stormwater Management Systems

Former Uniroyal and Facemate Properties – Chicopee, MA
ACOE Permit Review Only

Long-Term Pollution Prevention

The following measures and good housekeeping practices shall be followed at the Site to mitigate risk of pollution.

Material Storage and Handling

- Avoid stockpiling of soil or materials within 100 feet of wetland resources and wellhead protection areas. If necessary, provide sufficient erosion controls to prevent migration of sediments.
- All materials shall be stored or disposed in accordance with all local, state, and federal regulations.
- All sand piles shall be contained and stabilized to prevent the discharge of sand to wetlands or water bodies and, where feasible, covered.
- Minimize hazardous materials stored on site. All materials stored on site shall be stored in original containers and sealed.
- All solid waste, if encountered, shall be handled and disposed of in accordance with all local, state, and federal regulations.
- No snow shall be stored within waterbodies, resource areas, wellhead protection areas, or associated buffer zones.

Stormwater BMPs

- Refer to Inspection and Maintenance Procedures
- Refer to Illicit Discharge Compliance Statement

Spill Prevention and Response

- Refuel construction equipment off-site.
- Any spills of hazardous materials shall be reported, contained, and removed in accordance with local, State, and Federal regulations.
- Review on-site equipment and activities to ensure no illicit discharges are created.

Vegetation and Landscaping

- Refer to Inspection and Maintenance Procedures
- No fertilizers, pesticides, and/or herbicides shall be used at the Site.
- No road salt or sand for ice management shall be used or stored at the Site.

Long Term Operation & Maintenance Plan Stormwater Management Systems

Former Uniroyal and Facemate Properties – Chicopee, MA
ACOE Permit Review Only

Spill Prevention Plan

Remediation activities conducted at the Uniroyal and Facemate properties may involve the handling of hazardous waste materials or other pollutant sources. The purpose of this plan is to outline the source control and pollution prevention measures to minimize the risk of pollution to stormwater runoff.

Predicted Release

Any potential spills at the Site are anticipated to be during remediation activities relating to the existing mill buildings. During these activities, materials will be handled and either re-used on-site or removed from the Site for disposal. Spills in this area could be conveyed via overland flow towards the proposed Infiltration Basins.

Oil and Pollutant Control

The proposed drainage system will include hoods at all proposed catch basins to control accidental releases of oil into the system. Regular maintenance will be required to remove and legally dispose of any captured oil.

Sorbent Materials, Spill Response Supplies, and Equipment

During the proposed work, spill response supplies shall be maintained within the staging area. These supplies shall include sorbent pads, booms, and granular material (i.e., Speedy Dry), and a shovel, all stored within a covered over-pack drum or similar container. The supplies shall be made readily available to be deployed during a fuel spill or release.

Inspections and recordkeeping of the spill response equipment supplies must be maintained as part of this plan, and training shall be conducted to inform the employees on where the equipment is located and the procedure for using the material as part of the oil spill response training curriculum.

Additional Requirements

All remediation activities conducted at the Site shall be conducted by workers licensed to do such work in the state of Massachusetts. Remediation shall be in accordance with local, state, and federal law including all required measures to prevent spread of hazardous materials.

Long Term Operation & Maintenance Plan Stormwater Management Systems

Former Uniroyal and Facemate Properties – Chicopee, MA
ACOE Permit Review Only

BMP Inspection and Maintenance Procedures

Effectiveness of Best Management Practices (BMPs) is maximized when properly maintained. The following inspections schedule and maintenance required of BMPs for this project (see attached plan) shall be as outlined and documented below.

- Catch basins (CB) and Manholes (MH): Inspect and maintain after the first several rainfall events, after all major storms, and at least once every 3 months.
 - Check grates periodically and following heavy rainfall to verify that the inlet openings are not clogged by debris. Remove debris from grate.
 - Remove all accumulated debris.
 - Clean sump if it is greater than 50% full.
 - Note condition of frames, grates, concrete bricks, and hoods. Repair or replace damaged materials.
- Infiltration Basin: Inspect and maintain basin after the first several rainfall events, after all major storms, and at least once every 6 months.
 - Remove accumulated sediment, trash, debris, leaves, and grass clippings, particularly in area of trash racks.
 - Mow the buffer area, side slopes, and basin bottom.
 - Rake basin floor and remove tree or other plant seedlings before they become established.
 - Check for ponding within basin.
 - Check for erosion along basin slopes.
 - Inspect to ensure proper functioning.
- Vegetation: Monitor establishment and health of vegetation in fill area at least once a month for the first several months, then at least once every 6 months.
 - Check vegetation growth rate, health, and stability.
 - Note presence of any failing vegetation.
 - Reseed low-growth areas as necessary.

Approximate Maintenance Budget

Inspection and maintenance for this site is estimated as follows.

1. Inspections	\$400
2. Infiltration Basins	\$300
3. Deep Sump Catch Basin	\$300
<u>Annual Total</u>	\$1,000

Public Safety and Features

1. Provide police detail for extended occupation of roadway if traffic dictates.
2. All excavations and entry into closed structures will be completed in accordance with OSHA requirements.



Long Term Operation & Maintenance Plan Stormwater Management Systems

Former Uniroyal and Facemate Properties – Chicopee, MA
ACOE Permit Review Only

BMP Inspection and Maintenance Documentation Form

Inspection No.: _____ Date: _____ Weather: _____

Date & Amount of Last Precipitation Event: _____

Inspector Name: _____ Inspection Signature: _____

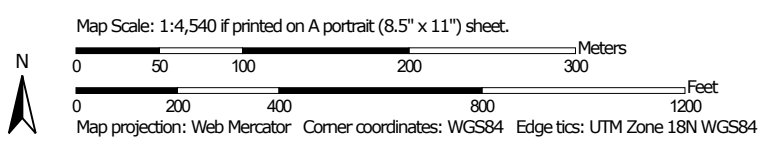
BMP	Condition/Stability	Comment & Recommendations	Date Corrected
Catch Basins			
Manholes			
Infiltration Basins			
Vegetation			
Other			
Additional Comments			

APPENDIX C – SOILS DATA

Hydrologic Soil Group—Hampden County, Massachusetts, Central Part



Soil Map may not be valid at this scale.



MAP LEGEND

Area of Interest (AOI)

 Area of Interest (AOI)

Soils

Soil Rating Polygons

 A
 A/D
 B
 B/D
 C
 C/D
 D
 Not rated or not available

Soil Rating Lines

 A
 A/D
 B
 B/D
 C
 C/D
 D
 Not rated or not available

Soil Rating Points

 A
 A/D
 B
 B/D

 C
 C/D
 D
 Not rated or not available


Water Features

 Streams and Canals

Transportation

 Rails
 Interstate Highways
 US Routes
 Major Roads
 Local Roads

Background

 Aerial Photography

MAP INFORMATION

The soil surveys that comprise your AOI were mapped at 1:25,000.

Warning: Soil Map may not be valid at this scale.

Enlargement of maps beyond the scale of mapping can cause misunderstanding of the detail of mapping and accuracy of soil line placement. The maps do not show the small areas of contrasting soils that could have been shown at a more detailed scale.

Please rely on the bar scale on each map sheet for map measurements.

Source of Map: Natural Resources Conservation Service
 Web Soil Survey URL:
 Coordinate System: Web Mercator (EPSG:3857)

Maps from the Web Soil Survey are based on the Web Mercator projection, which preserves direction and shape but distorts distance and area. A projection that preserves area, such as the Albers equal-area conic projection, should be used if more accurate calculations of distance or area are required.

This product is generated from the USDA-NRCS certified data as of the version date(s) listed below.

Soil Survey Area: Hampden County, Massachusetts, Central Part
 Survey Area Data: Version 14, Jun 9, 2020

Soil map units are labeled (as space allows) for map scales 1:50,000 or larger.

Date(s) aerial images were photographed: Aug 25, 2013—Sep 9, 2013

The orthophoto or other base map on which the soil lines were compiled and digitized probably differs from the background imagery displayed on these maps. As a result, some minor shifting of map unit boundaries may be evident.

Hydrologic Soil Group

Map unit symbol	Map unit name	Rating	Acres in AOI	Percent of AOI
1	Water		5.0	11.7%
602	Urban land		32.8	76.2%
739C	Urban land-Hinckley-Windsor association, 0 to 15 percent slopes	D	5.2	12.2%
Totals for Area of Interest			43.1	100.0%

Description

Hydrologic soil groups are based on estimates of runoff potential. Soils are assigned to one of four groups according to the rate of water infiltration when the soils are not protected by vegetation, are thoroughly wet, and receive precipitation from long-duration storms.

The soils in the United States are assigned to four groups (A, B, C, and D) and three dual classes (A/D, B/D, and C/D). The groups are defined as follows:

Group A. Soils having a high infiltration rate (low runoff potential) when thoroughly wet. These consist mainly of deep, well drained to excessively drained sands or gravelly sands. These soils have a high rate of water transmission.

Group B. Soils having a moderate infiltration rate when thoroughly wet. These consist chiefly of moderately deep or deep, moderately well drained or well drained soils that have moderately fine texture to moderately coarse texture. These soils have a moderate rate of water transmission.

Group C. Soils having a slow infiltration rate when thoroughly wet. These consist chiefly of soils having a layer that impedes the downward movement of water or soils of moderately fine texture or fine texture. These soils have a slow rate of water transmission.

Group D. Soils having a very slow infiltration rate (high runoff potential) when thoroughly wet. These consist chiefly of clays that have a high shrink-swell potential, soils that have a high water table, soils that have a claypan or clay layer at or near the surface, and soils that are shallow over nearly impervious material. These soils have a very slow rate of water transmission.

If a soil is assigned to a dual hydrologic group (A/D, B/D, or C/D), the first letter is for drained areas and the second is for undrained areas. Only the soils that in their natural condition are in group D are assigned to dual classes.

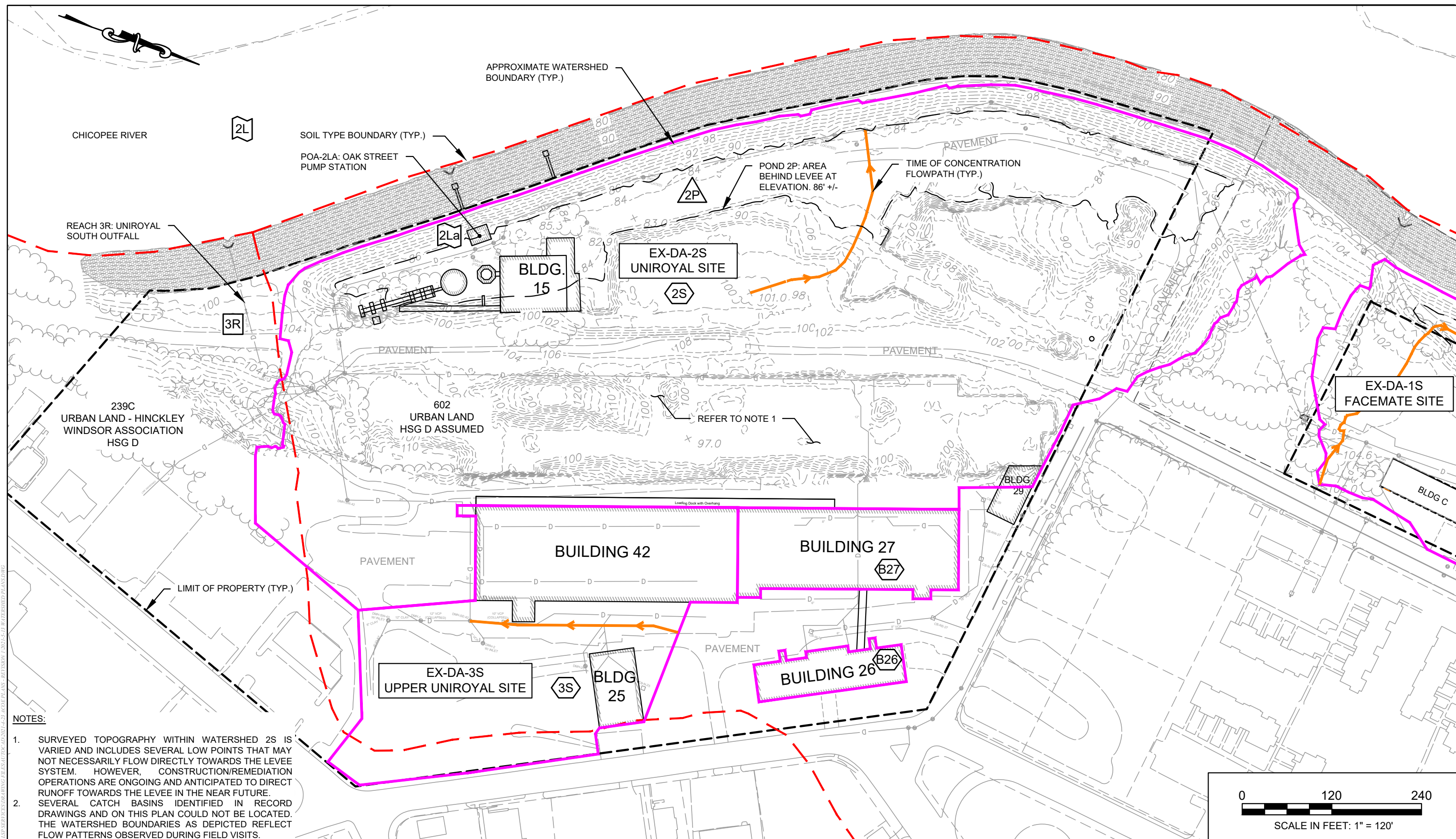
Rating Options

Aggregation Method: Dominant Condition

Component Percent Cutoff: None Specified

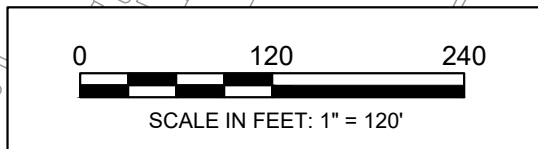
Tie-break Rule: Higher

APPENDIX D – WATERSHED PLANS



NOTES:

1. SURVEYED TOPOGRAPHY WITHIN WATERSHED 2S IS VARIED AND INCLUDES SEVERAL LOW POINTS THAT MAY NOT NECESSARILY FLOW DIRECTLY TOWARDS THE LEVEE SYSTEM. HOWEVER, CONSTRUCTION/REMEDATION OPERATIONS ARE ONGOING AND ANTICIPATED TO DIRECT RUNOFF TOWARDS THE LEVEE IN THE NEAR FUTURE.
2. SEVERAL CATCH BASINS IDENTIFIED IN RECORD DRAWINGS AND ON THIS PLAN COULD NOT BE LOCATED. THE WATERSHED BOUNDARIES AS DEPICTED REFLECT FLOW PATTERNS OBSERVED DURING FIELD VISITS.



Former Uniroyal & Facemate Properties
 ACOE Permit Review Only
 154 Grove Street & 75 West Main Street
 Chicopee, MA
 Issue Date: 5-13-2021

Watershed Plan
Existing Conditions
Uniroyal Property



CHICOPEE RIVER

SOIL TYPE BOUNDARY (TYP.)

APPROXIMATE WATERSHED BOUNDARY (TYP.)

INTERCEPTOR DRAIN TO MAIN ST. PUMP STATION

602 URBAN LAND HSG D ASSUMED

TIME OF CONCENTRATION FLOWPATH (TYP.)

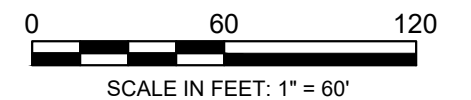
POND 1P: AREA BEHIND LEVEE AT ELEVATION 92' +/-

LIMIT OF FLOOD CONTROL PARCEL (TYP.)

EX-DA-1S FACEMATE SITE

BLDG C

LIMIT OF PROPERTY (TYP.)



03/18/2021 - CHICOPEE - UNIROYAL - FACEMATE - WATERSHED PLAN - 154 GROVE ST. & 75 WEST MAIN ST. - 154 GROVE ST. & 75 WEST MAIN ST. - 154 GROVE ST. & 75 WEST MAIN ST.



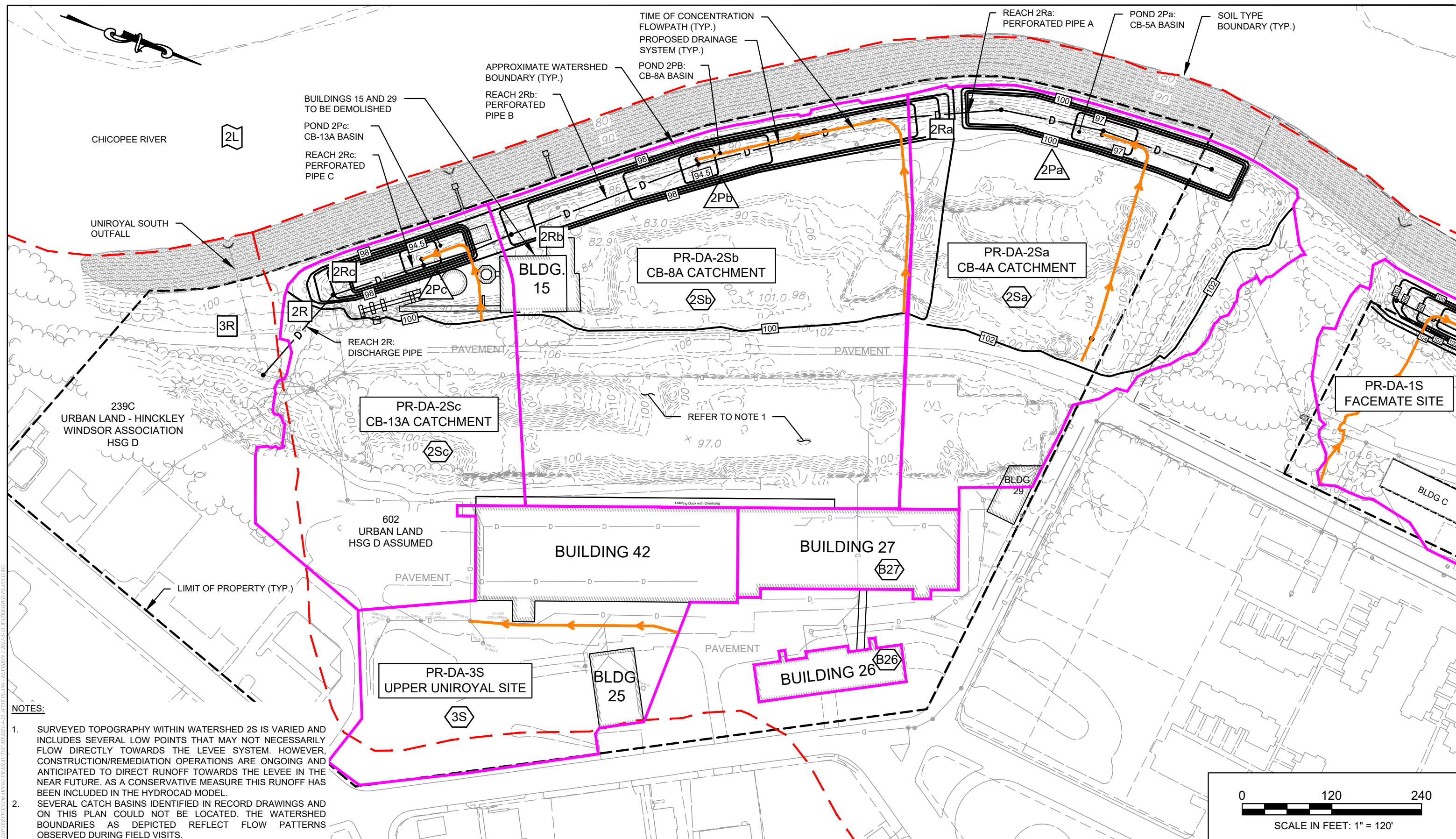
Former Uniroyal & Facemate Properties

ACOE Permit Review Only
154 Grove Street & 75 West Main Street
Chicopee, MA

Issue Date: 5-13-2021

Watershed Plan

**Existing Conditions
Facemate Property**



- NOTES:**
1. SURVEYED TOPOGRAPHY WITHIN WATERSHED 2S IS VARIED AND INCLUDES SEVERAL LOW POINTS THAT MAY NOT NECESSARILY FLOW DIRECTLY TOWARDS THE LEVEE SYSTEM. HOWEVER, CONSTRUCTION/REMEDATION OPERATIONS ARE ONGOING AND ANTICIPATED TO DIRECT RUNOFF TOWARDS THE LEVEE IN THE NEAR FUTURE. AS A CONSERVATIVE MEASURE THIS RUNOFF HAS BEEN INCLUDED IN THE HYDROCAD MODEL.
 2. SEVERAL CATCH BASINS IDENTIFIED IN RECORD DRAWINGS AND ON THIS PLAN COULD NOT BE LOCATED. THE WATERSHED BOUNDARIES AS DEPICTED REFLECT FLOW PATTERNS OBSERVED DURING FIELD VISITS.

Former Uniroyal & Facemate Properties
 ACOE Permit Review Only
 154 Grove Street & 75 West Main Street
 Chicopee, MA

Watershed Plan
Proposed Conditions
Uniroyal Property

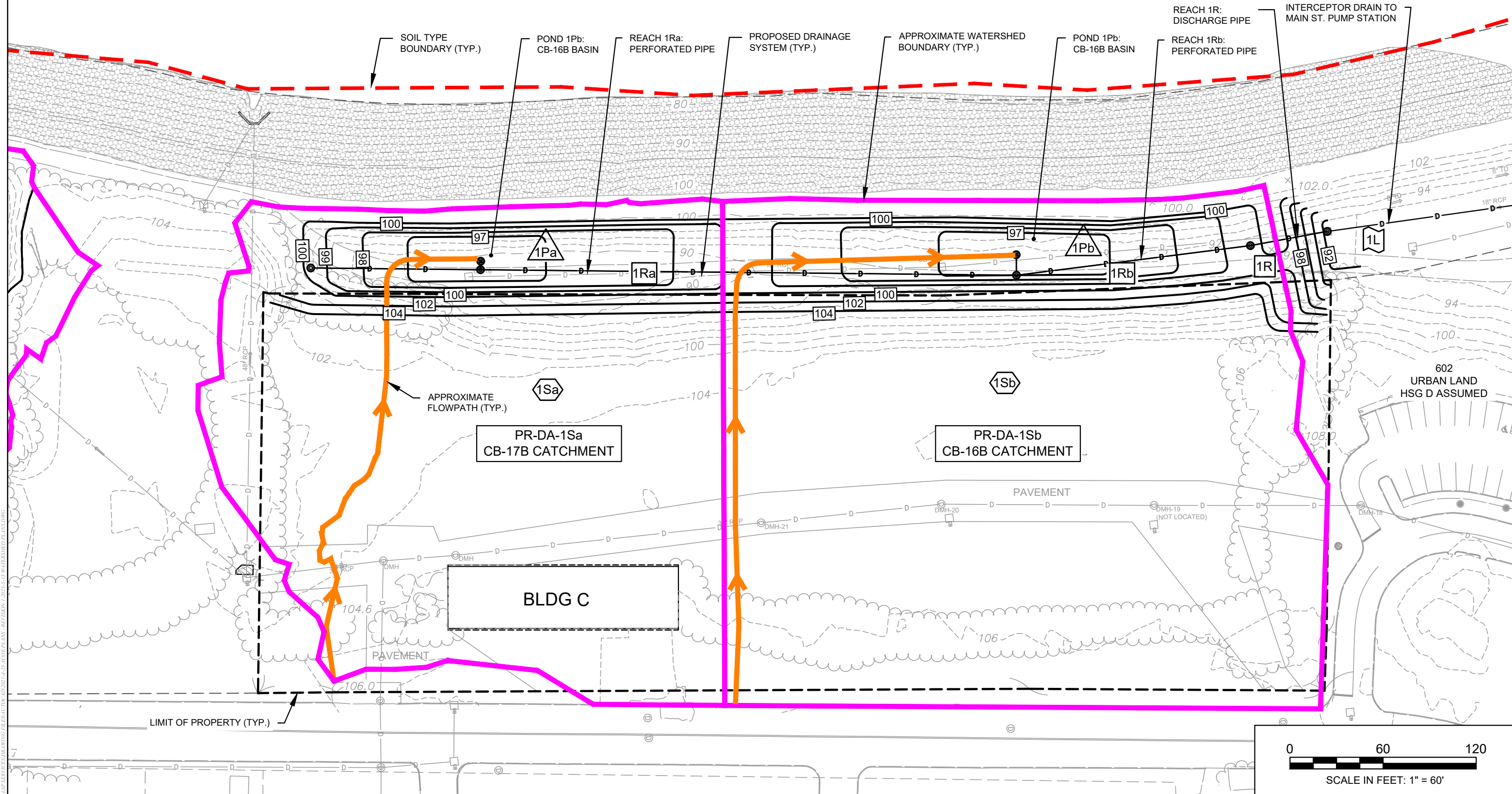
Issue Date: 5-13-2021



03/18/2021 - CHICOPÉE - UNIROYAL - FACEMATE - WATERSHED PLAN - 154 GROVE STREET & 75 WEST MAIN STREET - CHICOPÉE, MA - ACOE PERMIT REVIEW ONLY - 154 GROVE STREET & 75 WEST MAIN STREET - CHICOPÉE, MA - ACOE PERMIT REVIEW ONLY



CHICOPEE RIVER



D:\STUDIOS\GIS - CHICOPEE - ENVIRONMENTAL ENGINEERING\PROJECTS\CHICOPEE\PLANS - ACOE PERMIT REVIEW\CHICOPEE\PLANS - ACOE PERMIT REVIEW\PLANS.DWG

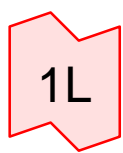


Former Uniroyal & Facemate Properties
 ACOE Permit Review Only
 154 Grove Street & 75 West Main Street
 Chicopee, MA

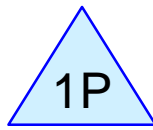
Issue Date: 5-13-2021

Watershed Plan
Proposed Conditions
Facemate Property

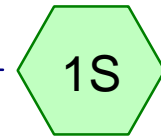
***APPENDIX E – EXISTING CONDITIONS
CALCULATIONS***



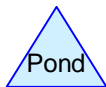
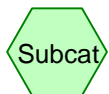
Facemate Interceptor
Drain



Area Behind Levee -
Facemate



EX-DA-1S - Facemate
Site



Routing Diagram for Existing Conditions - Facemate - TP40
Prepared by BETA Group, Inc, Printed 3/10/2021
HydroCAD® 10.00-25 s/n 10405 © 2019 HydroCAD Software Solutions LLC

Summary for Subcatchment 1S: EX-DA-1S - Facemate Site

Runoff = 8.36 cfs @ 12.09 hrs, Volume= 0.606 af, Depth= 1.45"

Runoff by SCS TR-20 method, UH=SCS, Weighted-CN, Time Span= 0.00-80.00 hrs, dt= 0.05 hrs
 Type III 24-hr 1-Year Rainfall=2.50"

Area (sf)	CN	Description
173,521	89	<50% Grass cover, Poor, HSG D
17,024	98	Paved parking, HSG D
6,237	98	Roofs, HSG D
21,109	79	Woods, Fair, HSG D
217,891	89	Weighted Average
194,630		89.32% Pervious Area
23,261		10.68% Impervious Area

Tc (min)	Length (feet)	Slope (ft/ft)	Velocity (ft/sec)	Capacity (cfs)	Description
0.6	50	0.0280	1.33		Sheet Flow, Sheet Flow Smooth surfaces n= 0.011 P2= 3.00"
3.7	190	0.0150	0.86		Shallow Concentrated Flow, Shallow Conc. 1 Short Grass Pasture Kv= 7.0 fps
0.6	86	0.1360	2.58		Shallow Concentrated Flow, Shallow Conc. 2 Short Grass Pasture Kv= 7.0 fps
1.1					Direct Entry, Minimum TC
6.0	326				Total

Summary for Pond 1P: Area Behind Levee - Facemate

Inflow Area = 5.002 ac, 10.68% Impervious, Inflow Depth = 1.45" for 1-Year event
 Inflow = 8.36 cfs @ 12.09 hrs, Volume= 0.606 af
 Outflow = 5.76 cfs @ 12.18 hrs, Volume= 0.606 af, Atten= 31%, Lag= 5.4 min
 Primary = 5.76 cfs @ 12.18 hrs, Volume= 0.606 af

Routing by Stor-Ind method, Time Span= 0.00-80.00 hrs, dt= 0.05 hrs
 Peak Elev= 90.36' @ 12.18 hrs Surf.Area= 8,424 sf Storage= 2,605 cf

Plug-Flow detention time= 9.9 min calculated for 0.606 af (100% of inflow)
 Center-of-Mass det. time= 10.0 min (831.3 - 821.3)

Volume	Invert	Avail.Storage	Storage	Description
#1	90.00'	25,050 cf		Custom Stage Data (Prismatic) Listed below (Recalc)

Elevation (feet)	Surf.Area (sq-ft)	Inc.Store (cubic-feet)	Cum.Store (cubic-feet)
90.00	6,140	0	0
92.00	18,910	25,050	25,050

Summary for Subcatchment 1S: EX-DA-1S - Facemate Site

Runoff = 10.86 cfs @ 12.09 hrs, Volume= 0.792 af, Depth= 1.90"

Runoff by SCS TR-20 method, UH=SCS, Weighted-CN, Time Span= 0.00-80.00 hrs, dt= 0.05 hrs
 Type III 24-hr 2-Year Rainfall=3.00"

Area (sf)	CN	Description
173,521	89	<50% Grass cover, Poor, HSG D
17,024	98	Paved parking, HSG D
6,237	98	Roofs, HSG D
21,109	79	Woods, Fair, HSG D
217,891	89	Weighted Average
194,630		89.32% Pervious Area
23,261		10.68% Impervious Area

Tc (min)	Length (feet)	Slope (ft/ft)	Velocity (ft/sec)	Capacity (cfs)	Description
0.6	50	0.0280	1.33		Sheet Flow, Sheet Flow Smooth surfaces n= 0.011 P2= 3.00"
3.7	190	0.0150	0.86		Shallow Concentrated Flow, Shallow Conc. 1 Short Grass Pasture Kv= 7.0 fps
0.6	86	0.1360	2.58		Shallow Concentrated Flow, Shallow Conc. 2 Short Grass Pasture Kv= 7.0 fps
1.1					Direct Entry, Minimum TC
6.0	326				Total

Summary for Pond 1P: Area Behind Levee - Facemate

Inflow Area = 5.002 ac, 10.68% Impervious, Inflow Depth = 1.90" for 2-Year event
 Inflow = 10.86 cfs @ 12.09 hrs, Volume= 0.792 af
 Outflow = 6.76 cfs @ 12.20 hrs, Volume= 0.792 af, Atten= 38%, Lag= 6.7 min
 Primary = 6.76 cfs @ 12.20 hrs, Volume= 0.792 af

Routing by Stor-Ind method, Time Span= 0.00-80.00 hrs, dt= 0.05 hrs
 Peak Elev= 90.49' @ 12.20 hrs Surf.Area= 9,286 sf Storage= 3,801 cf

Plug-Flow detention time= 9.8 min calculated for 0.791 af (100% of inflow)
 Center-of-Mass det. time= 9.9 min (823.5 - 813.7)

Volume	Invert	Avail.Storage	Storage	Description
#1	90.00'	25,050 cf		Custom Stage Data (Prismatic) Listed below (Recalc)

Elevation (feet)	Surf.Area (sq-ft)	Inc.Store (cubic-feet)	Cum.Store (cubic-feet)
90.00	6,140	0	0
92.00	18,910	25,050	25,050

Device	Routing	Invert	Outlet Devices
#1	Primary	90.00'	2.0" x 2.0" Horiz. Catch Basin X 6.00 columns X 6 rows C= 0.600 in 24.0" Grate (32% open area) Limited to weir flow at low heads
#2	Primary	90.00'	2.0" x 2.0" Horiz. Catch Basin X 6.00 columns X 6 rows C= 0.600 in 24.0" Grate (32% open area) Limited to weir flow at low heads

Primary OutFlow Max=5.74 cfs @ 12.18 hrs HW=90.35' (Free Discharge)
 1=Catch Basin (Orifice Controls 2.87 cfs @ 2.87 fps)
 2=Catch Basin (Orifice Controls 2.87 cfs @ 2.87 fps)

Summary for Link 1L: Facemate Interceptor Drain

Inflow Area = 5.002 ac, 10.68% Impervious, Inflow Depth = 1.45" for 1-Year event
 Inflow = 5.76 cfs @ 12.18 hrs, Volume= 0.606 af
 Primary = 5.76 cfs @ 12.18 hrs, Volume= 0.606 af, Atten= 0%, Lag= 0.0 min

Primary outflow = Inflow, Time Span= 0.00-80.00 hrs, dt= 0.05 hrs

Device	Routing	Invert	Outlet Devices
#1	Primary	90.00'	2.0" x 2.0" Horiz. Catch Basin X 6.00 columns X 6 rows C= 0.600 in 24.0" Grate (32% open area) Limited to weir flow at low heads
#2	Primary	90.00'	2.0" x 2.0" Horiz. Catch Basin X 6.00 columns X 6 rows C= 0.600 in 24.0" Grate (32% open area) Limited to weir flow at low heads

Primary OutFlow Max=6.75 cfs @ 12.20 hrs HW=90.49' (Free Discharge)
 1=Catch Basin (Orifice Controls 3.38 cfs @ 3.38 fps)
 2=Catch Basin (Orifice Controls 3.38 cfs @ 3.38 fps)

Summary for Link 1L: Facemate Interceptor Drain

Inflow Area = 5.002 ac, 10.68% Impervious, Inflow Depth = 1.90" for 2-Year event
 Inflow = 6.76 cfs @ 12.20 hrs, Volume= 0.792 af
 Primary = 6.76 cfs @ 12.20 hrs, Volume= 0.792 af, Atten= 0%, Lag= 0.0 min

Primary outflow = Inflow, Time Span= 0.00-80.00 hrs, dt= 0.05 hrs

Summary for Subcatchment 1S: EX-DA-1S - Facemate Site

Runoff = 18.98 cfs @ 12.09 hrs, Volume= 1.413 af, Depth= 3.39"

Runoff by SCS TR-20 method, UH=SCS, Weighted-CN, Time Span= 0.00-80.00 hrs, dt= 0.05 hrs
 Type III 24-hr 10-Year Rainfall=4.60"

Area (sf)	CN	Description
173,521	89	<50% Grass cover, Poor, HSG D
17,024	98	Paved parking, HSG D
6,237	98	Roofs, HSG D
21,109	79	Woods, Fair, HSG D
217,891	89	Weighted Average
194,630		89.32% Pervious Area
23,261		10.68% Impervious Area

Tc (min)	Length (feet)	Slope (ft/ft)	Velocity (ft/sec)	Capacity (cfs)	Description
0.6	50	0.0280	1.33		Sheet Flow, Sheet Flow Smooth surfaces n= 0.011 P2= 3.00"
3.7	190	0.0150	0.86		Shallow Concentrated Flow, Shallow Conc. 1 Short Grass Pasture Kv= 7.0 fps
0.6	86	0.1360	2.58		Shallow Concentrated Flow, Shallow Conc. 2 Short Grass Pasture Kv= 7.0 fps
1.1					Direct Entry, Minimum TC
6.0	326				Total

Summary for Pond 1P: Area Behind Levee - Facemate

Inflow Area = 5.002 ac, 10.68% Impervious, Inflow Depth = 3.39" for 10-Year event
 Inflow = 18.98 cfs @ 12.09 hrs, Volume= 1.413 af
 Outflow = 9.42 cfs @ 12.25 hrs, Volume= 1.413 af, Atten= 50%, Lag= 9.6 min
 Primary = 9.42 cfs @ 12.25 hrs, Volume= 1.413 af

Routing by Stor-Ind method, Time Span= 0.00-80.00 hrs, dt= 0.05 hrs
 Peak Elev= 90.96' @ 12.25 hrs Surf.Area= 12,250 sf Storage= 8,799 cf

Plug-Flow detention time= 10.8 min calculated for 1.412 af (100% of inflow)
 Center-of-Mass det. time= 10.8 min (808.2 - 797.3)

Volume	Invert	Avail.Storage	Storage Description
#1	90.00'	25,050 cf	Custom Stage Data (Prismatic) Listed below (Recalc)

Elevation (feet)	Surf.Area (sq-ft)	Inc.Store (cubic-feet)	Cum.Store (cubic-feet)
90.00	6,140	0	0
92.00	18,910	25,050	25,050

Summary for Subcatchment 1S: EX-DA-1S - Facemate Site

Runoff = 22.52 cfs @ 12.09 hrs, Volume= 1.692 af, Depth= 4.06"

Runoff by SCS TR-20 method, UH=SCS, Weighted-CN, Time Span= 0.00-80.00 hrs, dt= 0.05 hrs
 Type III 24-hr 25-Year Rainfall=5.30"

Area (sf)	CN	Description
173,521	89	<50% Grass cover, Poor, HSG D
17,024	98	Paved parking, HSG D
6,237	98	Roofs, HSG D
21,109	79	Woods, Fair, HSG D
217,891	89	Weighted Average
194,630		89.32% Pervious Area
23,261		10.68% Impervious Area

Tc (min)	Length (feet)	Slope (ft/ft)	Velocity (ft/sec)	Capacity (cfs)	Description
0.6	50	0.0280	1.33		Sheet Flow, Sheet Flow Smooth surfaces n= 0.011 P2= 3.00"
3.7	190	0.0150	0.86		Shallow Concentrated Flow, Shallow Conc. 1 Short Grass Pasture Kv= 7.0 fps
0.6	86	0.1360	2.58		Shallow Concentrated Flow, Shallow Conc. 2 Short Grass Pasture Kv= 7.0 fps
1.1					Direct Entry, Minimum TC
6.0	326				Total

Summary for Pond 1P: Area Behind Levee - Facemate

Inflow Area = 5.002 ac, 10.68% Impervious, Inflow Depth = 4.06" for 25-Year event
 Inflow = 22.52 cfs @ 12.09 hrs, Volume= 1.692 af
 Outflow = 10.38 cfs @ 12.27 hrs, Volume= 1.692 af, Atten= 54%, Lag= 10.8 min
 Primary = 10.38 cfs @ 12.27 hrs, Volume= 1.692 af

Routing by Stor-Ind method, Time Span= 0.00-80.00 hrs, dt= 0.05 hrs
 Peak Elev= 91.16' @ 12.27 hrs Surf.Area= 13,565 sf Storage= 11,457 cf

Plug-Flow detention time= 11.5 min calculated for 1.691 af (100% of inflow)
 Center-of-Mass det. time= 11.5 min (803.9 - 792.4)

Volume	Invert	Avail.Storage	Storage Description
#1	90.00'	25,050 cf	Custom Stage Data (Prismatic) Listed below (Recalc)

Elevation (feet)	Surf.Area (sq-ft)	Inc.Store (cubic-feet)	Cum.Store (cubic-feet)
90.00	6,140	0	0
92.00	18,910	25,050	25,050

Device	Routing	Invert	Outlet Devices
#1	Primary	90.00'	2.0" x 2.0" Horiz. Catch Basin X 6.00 columns X 6 rows C= 0.600 in 24.0" Grate (32% open area) Limited to weir flow at low heads
#2	Primary	90.00'	2.0" x 2.0" Horiz. Catch Basin X 6.00 columns X 6 rows C= 0.600 in 24.0" Grate (32% open area) Limited to weir flow at low heads

Primary OutFlow Max=9.42 cfs @ 12.25 hrs HW=90.96' (Free Discharge)
 1=Catch Basin (Orifice Controls 4.71 cfs @ 4.71 fps)
 2=Catch Basin (Orifice Controls 4.71 cfs @ 4.71 fps)

Summary for Link 1L: Facemate Interceptor Drain

Inflow Area = 5.002 ac, 10.68% Impervious, Inflow Depth = 3.39" for 10-Year event
 Inflow = 9.42 cfs @ 12.25 hrs, Volume= 1.413 af
 Primary = 9.42 cfs @ 12.25 hrs, Volume= 1.413 af, Atten= 0%, Lag= 0.0 min

Primary outflow = Inflow, Time Span= 0.00-80.00 hrs, dt= 0.05 hrs

Device	Routing	Invert	Outlet Devices
#1	Primary	90.00'	2.0" x 2.0" Horiz. Catch Basin X 6.00 columns X 6 rows C= 0.600 in 24.0" Grate (32% open area) Limited to weir flow at low heads
#2	Primary	90.00'	2.0" x 2.0" Horiz. Catch Basin X 6.00 columns X 6 rows C= 0.600 in 24.0" Grate (32% open area) Limited to weir flow at low heads

Primary OutFlow Max=10.37 cfs @ 12.27 hrs HW=91.16' (Free Discharge)
 1=Catch Basin (Orifice Controls 5.19 cfs @ 5.19 fps)
 2=Catch Basin (Orifice Controls 5.19 cfs @ 5.19 fps)

Summary for Link 1L: Facemate Interceptor Drain

Inflow Area = 5.002 ac, 10.68% Impervious, Inflow Depth = 4.06" for 25-Year event
 Inflow = 10.38 cfs @ 12.27 hrs, Volume= 1.692 af
 Primary = 10.38 cfs @ 12.27 hrs, Volume= 1.692 af, Atten= 0%, Lag= 0.0 min

Primary outflow = Inflow, Time Span= 0.00-80.00 hrs, dt= 0.05 hrs

Existing Conditions - Facemate - TP40

Type III 24-hr 100-Year Rainfall=6.50"

Prepared by BETA Group, Inc
HydroCAD® 10.00-25 s/n 10405 © 2019 HydroCAD Software Solutions LLC

Printed 3/10/2021
Page 9

Summary for Subcatchment 1S: EX-DA-1S - Facemate Site

Runoff = 28.57 cfs @ 12.09 hrs, Volume= 2.176 af, Depth= 5.22"

Runoff by SCS TR-20 method, UH=SCS, Weighted-CN, Time Span= 0.00-80.00 hrs, dt= 0.05 hrs
Type III 24-hr 100-Year Rainfall=6.50"

Area (sf)	CN	Description
173,521	89	<50% Grass cover, Poor, HSG D
17,024	98	Paved parking, HSG D
6,237	98	Roofs, HSG D
21,109	79	Woods, Fair, HSG D
217,891	89	Weighted Average
194,630		89.32% Pervious Area
23,261		10.68% Impervious Area

Tc (min)	Length (feet)	Slope (ft/ft)	Velocity (ft/sec)	Capacity (cfs)	Description
0.6	50	0.0280	1.33		Sheet Flow, Sheet Flow Smooth surfaces n= 0.011 P2= 3.00"
3.7	190	0.0150	0.86		Shallow Concentrated Flow, Shallow Conc. 1 Short Grass Pasture Kv= 7.0 fps
0.6	86	0.1360	2.58		Shallow Concentrated Flow, Shallow Conc. 2 Short Grass Pasture Kv= 7.0 fps
1.1					Direct Entry, Minimum TC
6.0	326	Total			

Summary for Pond 1P: Area Behind Levee - Facemate

Inflow Area = 5.002 ac, 10.68% Impervious, Inflow Depth = 5.22" for 100-Year event
Inflow = 28.57 cfs @ 12.09 hrs, Volume= 2.176 af
Outflow = 11.81 cfs @ 12.30 hrs, Volume= 2.176 af, Atten= 59%, Lag= 12.9 min
Primary = 11.81 cfs @ 12.30 hrs, Volume= 2.176 af

Routing by Stor-Ind method, Time Span= 0.00-80.00 hrs, dt= 0.05 hrs
Peak Elev= 91.50' @ 12.30 hrs Surf.Area= 15,747 sf Storage= 16,465 cf

Plug-Flow detention time= 12.9 min calculated for 2.175 af (100% of inflow)
Center-of-Mass det. time= 12.9 min (798.4 - 785.6)

Volume	Invert	Avail.Storage	Storage	Description
#1	90.00'	25,050 cf		Custom Stage Data (Prismatic) Listed below (Recalc)

Elevation (feet)	Surf.Area (sq-ft)	Inc.Store (cubic-feet)	Cum.Store (cubic-feet)
90.00	6,140	0	0
92.00	18,910	25,050	25,050

Existing Conditions - Facemate - TP40

Type III 24-hr 100-Year Rainfall=6.50"

Prepared by BETA Group, Inc
HydroCAD® 10.00-25 s/n 10405 © 2019 HydroCAD Software Solutions LLC

Printed 3/10/2021
Page 10

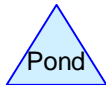
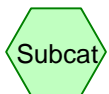
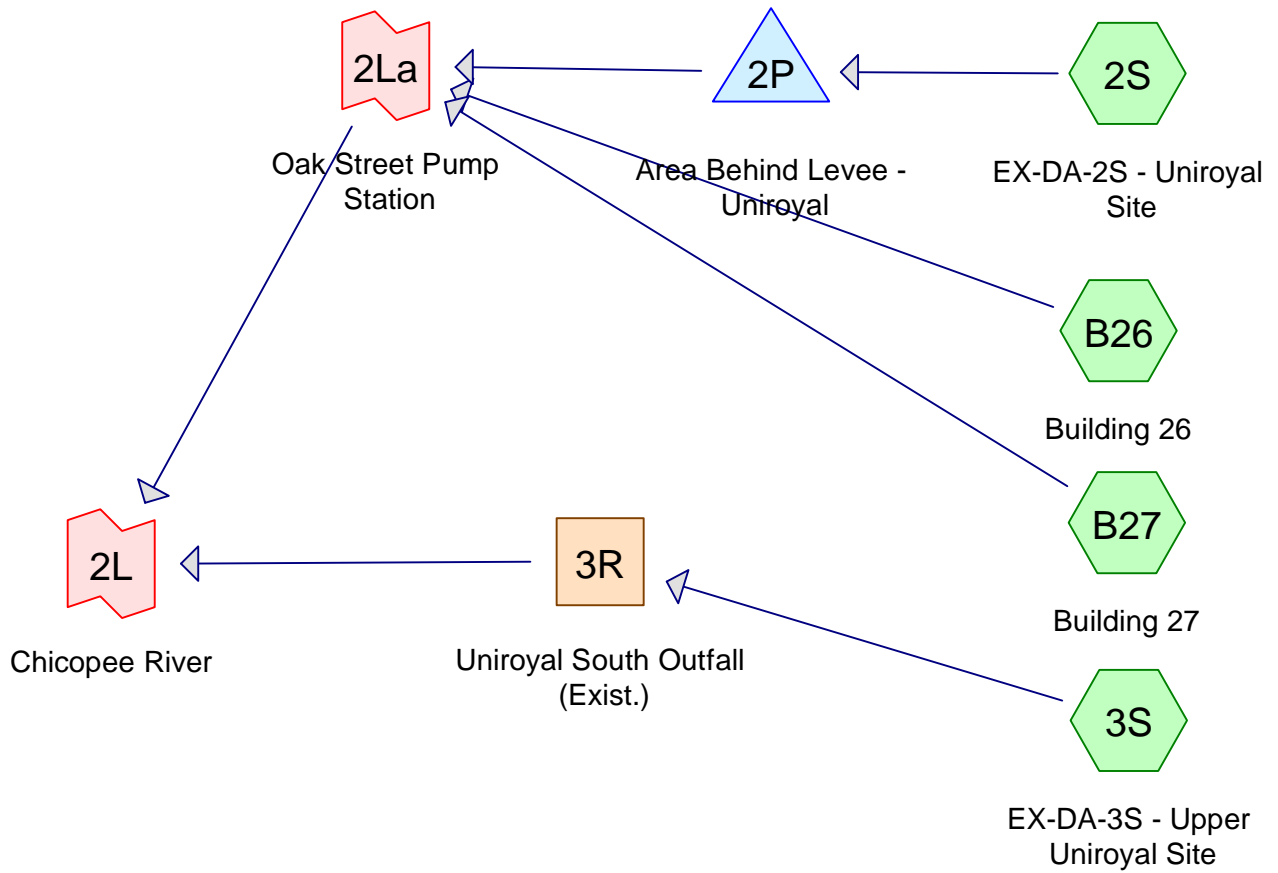
Device	Routing	Invert	Outlet Devices
#1	Primary	90.00'	2.0" x 2.0" Horiz. Catch Basin X 6.00 columns X 6 rows C= 0.600 in 24.0" Grate (32% open area) Limited to weir flow at low heads
#2	Primary	90.00'	2.0" x 2.0" Horiz. Catch Basin X 6.00 columns X 6 rows C= 0.600 in 24.0" Grate (32% open area) Limited to weir flow at low heads

Primary OutFlow Max=11.81 cfs @ 12.30 hrs HW=91.50' (Free Discharge)
1=Catch Basin (Orifice Controls 5.90 cfs @ 5.90 fps)
2=Catch Basin (Orifice Controls 5.90 cfs @ 5.90 fps)

Summary for Link 1L: Facemate Interceptor Drain

Inflow Area = 5.002 ac, 10.68% Impervious, Inflow Depth = 5.22" for 100-Year event
Inflow = 11.81 cfs @ 12.30 hrs, Volume= 2.176 af
Primary = 11.81 cfs @ 12.30 hrs, Volume= 2.176 af, Atten= 0%, Lag= 0.0 min

Primary outflow = Inflow, Time Span= 0.00-80.00 hrs, dt= 0.05 hrs



Routing Diagram for Existing Conditions - Uniroyal - Atlas 14
 Prepared by BETA Group, Inc, Printed 3/10/2021
 HydroCAD® 10.00-25 s/n 10405 © 2019 HydroCAD Software Solutions LLC

Summary for Subcatchment 2S: EX-DA-2S - Uniroyal Site

Runoff = 24.02 cfs @ 12.10 hrs, Volume= 1.759 af, Depth= 1.51"

Runoff by SCS TR-20 method, UH=SCS, Weighted-CN, Time Span= 0.00-80.00 hrs, dt= 0.05 hrs
 Type III 24-hr 1-Year Rainfall=2.48"

Area (sf)	CN	Description
496,843	89	<50% Grass cover, Poor, HSG D
67,169	98	Paved parking, HSG D
12,351	98	Roofs, HSG D
31,364	79	Woods, Fair, HSG D
607,728	90	Weighted Average
528,208		86.92% Pervious Area
79,520		13.08% Impervious Area

Tc (min)	Length (feet)	Slope (ft/ft)	Velocity (ft/sec)	Capacity (cfs)	Description
4.0	50	0.0520	0.21		
2.3	245	0.0650	1.78		Sheet Flow, Sheet Flow Grass: Short n= 0.150 P2= 3.00" Shallow Concentrated Flow, Shallow Conc. 1 Short Grass Pasture Kv= 7.0 fps
6.3	295	Total			

Summary for Subcatchment 3S: EX-DA-3S - Upper Uniroyal Site

Runoff = 6.32 cfs @ 12.09 hrs, Volume= 0.472 af, Depth= 1.85"

Runoff by SCS TR-20 method, UH=SCS, Weighted-CN, Time Span= 0.00-80.00 hrs, dt= 0.05 hrs
 Type III 24-hr 1-Year Rainfall=2.48"

Area (sf)	CN	Description
64,274	89	<50% Grass cover, Poor, HSG D
17,187	98	Paved parking, HSG D
51,767	98	Roofs, HSG D
133,228	94	Weighted Average
64,274		48.24% Pervious Area
68,954		51.76% Impervious Area

Tc (min)	Length (feet)	Slope (ft/ft)	Velocity (ft/sec)	Capacity (cfs)	Description
6.0					Direct Entry, Minimum TC

Summary for Subcatchment B26: Building 26

Runoff = 0.57 cfs @ 12.09 hrs, Volume= 0.046 af, Depth= 2.25"

Runoff by SCS TR-20 method, UH=SCS, Weighted-CN, Time Span= 0.00-80.00 hrs, dt= 0.05 hrs
 Type III 24-hr 1-Year Rainfall=2.48"

Area (sf)	CN	Description
10,635	98	Roofs, HSG D
10,635		100.00% Impervious Area

Tc (min)	Length (feet)	Slope (ft/ft)	Velocity (ft/sec)	Capacity (cfs)	Description
6.0					Direct Entry, Minimum TC

Summary for Subcatchment B27: Building 27

Runoff = 1.74 cfs @ 12.09 hrs, Volume= 0.140 af, Depth= 2.25"

Runoff by SCS TR-20 method, UH=SCS, Weighted-CN, Time Span= 0.00-80.00 hrs, dt= 0.05 hrs
 Type III 24-hr 1-Year Rainfall=2.48"

Area (sf)	CN	Description
32,552	98	Roofs, HSG D
32,552		100.00% Impervious Area

Tc (min)	Length (feet)	Slope (ft/ft)	Velocity (ft/sec)	Capacity (cfs)	Description
6.0					Direct Entry, Minimum TC

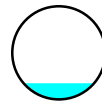
Summary for Reach 3R: Uniroyal South Outfall (Exist.)

Inflow Area = 3.058 ac, 51.76% Impervious, Inflow Depth = 1.85" for 1-Year event
 Inflow = 6.32 cfs @ 12.09 hrs, Volume= 0.472 af
 Outflow = 6.26 cfs @ 12.10 hrs, Volume= 0.472 af, Atten= 1%, Lag= 0.4 min

Routing by Stor-Ind+Trans method, Time Span= 0.00-80.00 hrs, dt= 0.05 hrs
 Max. Velocity= 11.48 fps, Min. Travel Time= 0.3 min
 Avg. Velocity = 3.80 fps, Avg. Travel Time= 0.8 min

Peak Storage= 96 cf @ 12.09 hrs
 Average Depth at Peak Storage= 0.42'
 Bank-Full Depth= 2.50' Flow Area= 4.9 sf, Capacity= 101.22 cfs

30.0" Round Pipe
 n= 0.011 Concrete pipe, straight & clean
 Length= 175.0' Slope= 0.0436 /'
 Inlet Invert= 85.85', Outlet Invert= 78.22'



Summary for Pond 2P: Area Behind Levee - Uniroyal

Inflow Area = 13.952 ac, 13.08% Impervious, Inflow Depth = 1.51" for 1-Year event
 Inflow = 24.02 cfs @ 12.10 hrs, Volume= 1.759 af
 Outflow = 8.33 cfs @ 12.40 hrs, Volume= 1.759 af, Atten= 65%, Lag= 18.1 min
 Primary = 8.33 cfs @ 12.40 hrs, Volume= 1.759 af

Routing by Stor-Ind method, Time Span= 0.00-80.00 hrs, dt= 0.05 hrs
 Peak Elev= 84.33' @ 12.40 hrs Surf.Area= 71,240 sf Storage= 22,614 cf

Plug-Flow detention time= 58.1 min calculated for 1.758 af (100% of inflow)
 Center-of-Mass det. time= 58.4 min (875.8 - 817.4)

Volume	Invert	Avail.Storage	Storage	Description
#1	84.00'	168,115 cf		Custom Stage Data (Prismatic) Listed below (Recalc)

Elevation (feet)	Surf.Area (sq-ft)	Inc.Store (cubic-feet)	Cum.Store (cubic-feet)
84.00	64,860	0	0
86.00	103,255	168,115	168,115

Device	Routing	Invert	Outlet Devices
#1	Primary	84.00'	2.0' x 2.0' Horiz. Catch Basin X 6.00 columns X 6 rows C= 0.600 in 24.0" Grate (32% open area) Limited to weir flow at low heads
#2	Primary	84.00'	2.0' x 2.0' Horiz. Catch Basin X 6.00 columns X 6 rows C= 0.600 in 24.0" Grate (32% open area) Limited to weir flow at low heads
#3	Primary	84.00'	2.0' x 2.0' Horiz. Catch Basin X 6.00 columns X 6 rows C= 0.600 in 24.0" Grate (32% open area) Limited to weir flow at low heads

Primary OutFlow Max=8.33 cfs @ 12.40 hrs HW=84.33' (Free Discharge)
 1=Catch Basin (Orifice Controls 2.78 cfs @ 2.78 fps)
 2=Catch Basin (Orifice Controls 2.78 cfs @ 2.78 fps)
 3=Catch Basin (Orifice Controls 2.78 cfs @ 2.78 fps)

Summary for Link 2L: Chicopee River

Inflow Area = 18.001 ac, 24.44% Impervious, Inflow Depth = 1.61" for 1-Year event
 Inflow = 15.73 cfs @ 12.11 hrs, Volume= 2.417 af
 Primary = 15.73 cfs @ 12.11 hrs, Volume= 2.417 af, Atten= 0%, Lag= 0.0 min

Primary outflow = Inflow, Time Span= 0.00-80.00 hrs, dt= 0.05 hrs

Summary for Link 2La: Oak Street Pump Station

Inflow Area = 14.943 ac, 18.85% Impervious, Inflow Depth = 1.56" for 1-Year event
 Inflow = 9.44 cfs @ 12.14 hrs, Volume= 1.945 af
 Primary = 9.44 cfs @ 12.14 hrs, Volume= 1.945 af, Atten= 0%, Lag= 0.0 min

Primary outflow = Inflow, Time Span= 0.00-80.00 hrs, dt= 0.05 hrs

Summary for Subcatchment 2S: EX-DA-2S - Uniroyal Site

Runoff = 32.97 cfs @ 12.09 hrs, Volume= 2.435 af, Depth= 2.09"

Runoff by SCS TR-20 method, UH=SCS, Weighted-CN, Time Span= 0.00-80.00 hrs, dt= 0.05 hrs
 Type III 24-hr 2-Year Rainfall=3.12"

Area (sf)	CN	Description
496,843	89	<50% Grass cover, Poor, HSG D
67,169	98	Paved parking, HSG D
12,351	98	Roofs, HSG D
31,364	79	Woods, Fair, HSG D
607,728	90	Weighted Average
528,208		86.92% Pervious Area
79,520		13.08% Impervious Area

Tc (min)	Length (feet)	Slope (ft/ft)	Velocity (ft/sec)	Capacity (cfs)	Description
4.0	50	0.0520	0.21		Sheet Flow, Sheet Flow Grass: Short n= 0.150 P2= 3.00"
2.3	245	0.0650	1.78		Shallow Concentrated Flow, Shallow Conc. 1 Short Grass Pasture Kv= 7.0 fps
6.3	295				Total

Summary for Subcatchment 3S: EX-DA-3S - Upper Uniroyal Site

Runoff = 8.29 cfs @ 12.09 hrs, Volume= 0.629 af, Depth= 2.47"

Runoff by SCS TR-20 method, UH=SCS, Weighted-CN, Time Span= 0.00-80.00 hrs, dt= 0.05 hrs
 Type III 24-hr 2-Year Rainfall=3.12"

Area (sf)	CN	Description
64,274	89	<50% Grass cover, Poor, HSG D
17,187	98	Paved parking, HSG D
51,767	98	Roofs, HSG D
133,228	94	Weighted Average
64,274		48.24% Pervious Area
68,954		51.76% Impervious Area

Tc (min)	Length (feet)	Slope (ft/ft)	Velocity (ft/sec)	Capacity (cfs)	Description
6.0					Direct Entry, Minimum TC

Summary for Subcatchment B26: Building 26

Runoff = 0.72 cfs @ 12.09 hrs, Volume= 0.059 af, Depth= 2.89"

Runoff by SCS TR-20 method, UH=SCS, Weighted-CN, Time Span= 0.00-80.00 hrs, dt= 0.05 hrs
 Type III 24-hr 2-Year Rainfall=3.12"

Area (sf)	CN	Description
10,635	98	Roofs, HSG D
10,635		100.00% Impervious Area

Tc (min)	Length (feet)	Slope (ft/ft)	Velocity (ft/sec)	Capacity (cfs)	Description
6.0					Direct Entry, Minimum TC

Summary for Subcatchment B27: Building 27

Runoff = 2.21 cfs @ 12.09 hrs, Volume= 0.180 af, Depth= 2.89"

Runoff by SCS TR-20 method, UH=SCS, Weighted-CN, Time Span= 0.00-80.00 hrs, dt= 0.05 hrs
 Type III 24-hr 2-Year Rainfall=3.12"

Area (sf)	CN	Description
32,552	98	Roofs, HSG D
32,552		100.00% Impervious Area

Tc (min)	Length (feet)	Slope (ft/ft)	Velocity (ft/sec)	Capacity (cfs)	Description
6.0					Direct Entry, Minimum TC

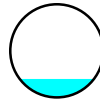
Summary for Reach 3R: Uniroyal South Outfall (Exist.)

Inflow Area = 3.058 ac, 51.76% Impervious, Inflow Depth = 2.47" for 2-Year event
 Inflow = 8.29 cfs @ 12.09 hrs, Volume= 0.629 af
 Outflow = 8.23 cfs @ 12.09 hrs, Volume= 0.629 af, Atten= 1%, Lag= 0.4 min

Routing by Stor-Ind+Trans method, Time Span= 0.00-80.00 hrs, dt= 0.05 hrs
 Max. Velocity= 12.43 fps, Min. Travel Time= 0.2 min
 Avg. Velocity = 4.08 fps, Avg. Travel Time= 0.7 min

Peak Storage= 117 cf @ 12.09 hrs
 Average Depth at Peak Storage= 0.48'
 Bank-Full Depth= 2.50' Flow Area= 4.9 sf, Capacity= 101.22 cfs

30.0" Round Pipe
 n= 0.011 Concrete pipe, straight & clean
 Length= 175.0' Slope= 0.0436'
 Inlet Invert= 85.85', Outlet Invert= 78.22'



Summary for Pond 2P: Area Behind Levee - Uniroyal

Inflow Area = 13.952 ac, 13.08% Impervious, Inflow Depth = 2.09" for 2-Year event
 Inflow = 32.97 cfs @ 12.09 hrs, Volume= 2.435 af
 Outflow = 9.91 cfs @ 12.43 hrs, Volume= 2.435 af, Atten= 70%, Lag= 20.4 min
 Primary = 9.91 cfs @ 12.43 hrs, Volume= 2.435 af

Routing by Stor-Ind method, Time Span= 0.00-80.00 hrs, dt= 0.05 hrs
 Peak Elev= 84.47' @ 12.43 hrs Surf.Area= 73,889 sf Storage= 32,626 cf

Plug-Flow detention time= 57.1 min calculated for 2.434 af (100% of inflow)
 Center-of-Mass det. time= 57.4 min (865.6 - 808.2)

Volume	Invert	Avail.Storage	Storage Description
#1	84.00'	168,115 cf	Custom Stage Data (Prismatic) Listed below (Recalc)

Elevation (feet)	Surf.Area (sq-ft)	Inc.Store (cubic-feet)	Cum.Store (cubic-feet)
84.00	64,860	0	0
86.00	103,255	168,115	168,115

Device	Routing	Invert	Outlet Devices
#1	Primary	84.00'	2.0" x 2.0" Horiz. Catch Basin X 6.00 columns X 6 rows C= 0.600 in 24.0" Grate (32% open area) Limited to weir flow at low heads
#2	Primary	84.00'	2.0" x 2.0" Horiz. Catch Basin X 6.00 columns X 6 rows C= 0.600 in 24.0" Grate (32% open area) Limited to weir flow at low heads
#3	Primary	84.00'	2.0" x 2.0" Horiz. Catch Basin X 6.00 columns X 6 rows C= 0.600 in 24.0" Grate (32% open area) Limited to weir flow at low heads

Primary OutFlow Max=9.90 cfs @ 12.43 hrs HW=84.47' (Free Discharge)
 1=Catch Basin (Orifice Controls 3.30 cfs @ 3.30 fps)
 2=Catch Basin (Orifice Controls 3.30 cfs @ 3.30 fps)
 3=Catch Basin (Orifice Controls 3.30 cfs @ 3.30 fps)

Summary for Link 2L: Chicopee River

Inflow Area = 18.001 ac, 24.44% Impervious, Inflow Depth = 2.20" for 2-Year event
 Inflow = 19.41 cfs @ 12.10 hrs, Volume= 3.302 af
 Primary = 19.41 cfs @ 12.10 hrs, Volume= 3.302 af, Atten= 0%, Lag= 0.0 min

Primary outflow = Inflow, Time Span= 0.00-80.00 hrs, dt= 0.05 hrs

Summary for Link 2La: Oak Street Pump Station

Inflow Area = 14.943 ac, 18.85% Impervious, Inflow Depth = 2.15" for 2-Year event
 Inflow = 11.23 cfs @ 12.13 hrs, Volume= 2.674 af
 Primary = 11.23 cfs @ 12.13 hrs, Volume= 2.674 af, Atten= 0%, Lag= 0.0 min

Primary outflow = Inflow, Time Span= 0.00-80.00 hrs, dt= 0.05 hrs

Summary for Subcatchment 2S: EX-DA-2S - Uniroyal Site

Runoff = 59.95 cfs @ 12.09 hrs, Volume= 4.552 af, Depth= 3.91"

Runoff by SCS TR-20 method, UH=SCS, Weighted-CN, Time Span= 0.00-80.00 hrs, dt= 0.05 hrs
 Type III 24-hr 10-Year Rainfall=5.04"

Area (sf)	CN	Description
496,843	89	<50% Grass cover, Poor, HSG D
67,169	98	Paved parking, HSG D
12,351	98	Roofs, HSG D
31,364	79	Woods, Fair, HSG D
607,728	90	Weighted Average
528,208		86.92% Pervious Area
79,520		13.08% Impervious Area

Tc (min)	Length (feet)	Slope (ft/ft)	Velocity (ft/sec)	Capacity (cfs)	Description
4.0	50	0.0520	0.21		Sheet Flow, Sheet Flow Grass: Short n= 0.150 P2= 3.00"
2.3	245	0.0650	1.78		Shallow Concentrated Flow, Shallow Conc. 1 Short Grass Pasture Kv= 7.0 fps
6.3	295	Total			

Summary for Subcatchment 3S: EX-DA-3S - Upper Uniroyal Site

Runoff = 14.15 cfs @ 12.09 hrs, Volume= 1.108 af, Depth= 4.35"

Runoff by SCS TR-20 method, UH=SCS, Weighted-CN, Time Span= 0.00-80.00 hrs, dt= 0.05 hrs
 Type III 24-hr 10-Year Rainfall=5.04"

Area (sf)	CN	Description
64,274	89	<50% Grass cover, Poor, HSG D
17,187	98	Paved parking, HSG D
51,767	98	Roofs, HSG D
133,228	94	Weighted Average
64,274		48.24% Pervious Area
68,954		51.76% Impervious Area

Tc (min)	Length (feet)	Slope (ft/ft)	Velocity (ft/sec)	Capacity (cfs)	Description
6.0					Direct Entry, Minimum TC

Summary for Subcatchment B26: Building 26

Runoff = 1.18 cfs @ 12.09 hrs, Volume= 0.098 af, Depth= 4.80"

Runoff by SCS TR-20 method, UH=SCS, Weighted-CN, Time Span= 0.00-80.00 hrs, dt= 0.05 hrs
 Type III 24-hr 10-Year Rainfall=5.04"

Area (sf)	CN	Description
10,635	98	Roofs, HSG D
10,635		100.00% Impervious Area

Tc (min)	Length (feet)	Slope (ft/ft)	Velocity (ft/sec)	Capacity (cfs)	Description
6.0					Direct Entry, Minimum TC

Summary for Subcatchment B27: Building 27

Runoff = 3.60 cfs @ 12.09 hrs, Volume= 0.299 af, Depth= 4.80"

Runoff by SCS TR-20 method, UH=SCS, Weighted-CN, Time Span= 0.00-80.00 hrs, dt= 0.05 hrs
 Type III 24-hr 10-Year Rainfall=5.04"

Area (sf)	CN	Description
32,552	98	Roofs, HSG D
32,552		100.00% Impervious Area

Tc (min)	Length (feet)	Slope (ft/ft)	Velocity (ft/sec)	Capacity (cfs)	Description
6.0					Direct Entry, Minimum TC

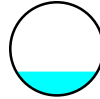
Summary for Reach 3R: Uniroyal South Outfall (Exist.)

Inflow Area = 3.058 ac, 51.76% Impervious, Inflow Depth = 4.35" for 10-Year event
 Inflow = 14.15 cfs @ 12.09 hrs, Volume= 1.108 af
 Outflow = 14.06 cfs @ 12.09 hrs, Volume= 1.108 af, Atten= 1%, Lag= 0.3 min

Routing by Stor-Ind+Trans method, Time Span= 0.00-80.00 hrs, dt= 0.05 hrs
 Max. Velocity= 14.52 fps, Min. Travel Time= 0.2 min
 Avg. Velocity = 4.74 fps, Avg. Travel Time= 0.6 min

Peak Storage= 171 cf @ 12.09 hrs
 Average Depth at Peak Storage= 0.63'
 Bank-Full Depth= 2.50' Flow Area= 4.9 sf, Capacity= 101.22 cfs

30.0" Round Pipe
 n= 0.011 Concrete pipe, straight & clean
 Length= 175.0' Slope= 0.0436 /'
 Inlet Invert= 85.85', Outlet Invert= 78.22'



Summary for Pond 2P: Area Behind Levee - Uniroyal

Inflow Area = 13.952 ac, 13.08% Impervious, Inflow Depth = 3.91" for 10-Year event
 Inflow = 59.95 cfs @ 12.09 hrs, Volume= 4.552 af
 Outflow = 13.71 cfs @ 12.50 hrs, Volume= 4.552 af, Atten= 77%, Lag= 24.3 min
 Primary = 13.71 cfs @ 12.50 hrs, Volume= 4.552 af

Routing by Stor-Ind method, Time Span= 0.00-80.00 hrs, dt= 0.05 hrs
 Peak Elev= 84.90' @ 12.50 hrs Surf.Area= 82,142 sf Storage= 66,166 cf

Plug-Flow detention time= 61.8 min calculated for 4.549 af (100% of inflow)
 Center-of-Mass det. time= 62.1 min (852.8 - 790.7)

Volume	Invert	Avail.Storage	Storage Description
#1	84.00'	168,115 cf	Custom Stage Data (Prismatic) Listed below (Recalc)

Elevation (feet)	Surf.Area (sq-ft)	Inc.Store (cubic-feet)	Cum.Store (cubic-feet)
84.00	64,860	0	0
86.00	103,255	168,115	168,115

Device	Routing	Invert	Outlet Devices
#1	Primary	84.00'	2.0" x 2.0" Horiz. Catch Basin X 6.00 columns X 6 rows C= 0.600 in 24.0" Grate (32% open area) Limited to weir flow at low heads
#2	Primary	84.00'	2.0" x 2.0" Horiz. Catch Basin X 6.00 columns X 6 rows C= 0.600 in 24.0" Grate (32% open area) Limited to weir flow at low heads
#3	Primary	84.00'	2.0" x 2.0" Horiz. Catch Basin X 6.00 columns X 6 rows C= 0.600 in 24.0" Grate (32% open area) Limited to weir flow at low heads

Primary Outflow Max=13.70 cfs @ 12.50 hrs HW=84.90' (Free Discharge)
 1=Catch Basin (Orifice Controls 4.57 cfs @ 4.57 fps)
 2=Catch Basin (Orifice Controls 4.57 cfs @ 4.57 fps)
 3=Catch Basin (Orifice Controls 4.57 cfs @ 4.57 fps)

Summary for Link 2L: Chicopee River

Inflow Area = 18.001 ac, 24.44% Impervious, Inflow Depth = 4.04" for 10-Year event
 Inflow = 29.98 cfs @ 12.10 hrs, Volume= 6.056 af
 Primary = 29.98 cfs @ 12.10 hrs, Volume= 6.056 af, Atten= 0%, Lag= 0.0 min

Primary outflow = Inflow, Time Span= 0.00-80.00 hrs, dt= 0.05 hrs

Summary for Link 2La: Oak Street Pump Station

Inflow Area = 14.943 ac, 18.85% Impervious, Inflow Depth = 3.97" for 10-Year event
 Inflow = 16.09 cfs @ 12.12 hrs, Volume= 4.948 af
 Primary = 16.09 cfs @ 12.12 hrs, Volume= 4.948 af, Atten= 0%, Lag= 0.0 min

Primary outflow = Inflow, Time Span= 0.00-80.00 hrs, dt= 0.05 hrs

Summary for Subcatchment 2S: EX-DA-2S - Uniroyal Site

Runoff = 76.54 cfs @ 12.09 hrs, Volume= 5.895 af, Depth= 5.07"

Runoff by SCS TR-20 method, UH=SCS, Weighted-CN, Time Span= 0.00-80.00 hrs, dt= 0.05 hrs
 Type III 24-hr 25-Year Rainfall=6.23"

Area (sf)	CN	Description
496,843	89	<50% Grass cover, Poor, HSG D
67,169	98	Paved parking, HSG D
12,351	98	Roofs, HSG D
31,364	79	Woods, Fair, HSG D
607,728	90	Weighted Average
528,208		86.92% Pervious Area
79,520		13.08% Impervious Area

Tc (min)	Length (feet)	Slope (ft/ft)	Velocity (ft/sec)	Capacity (cfs)	Description
4.0	50	0.0520	0.21		
2.3	245	0.0650	1.78		Sheet Flow, Sheet Flow Grass: Short n= 0.150 P2= 3.00" Shallow Concentrated Flow, Shallow Conc. 1 Short Grass Pasture Kv= 7.0 fps
6.3	295	Total			

Summary for Subcatchment 3S: EX-DA-3S - Upper Uniroyal Site

Runoff = 17.74 cfs @ 12.09 hrs, Volume= 1.408 af, Depth= 5.52"

Runoff by SCS TR-20 method, UH=SCS, Weighted-CN, Time Span= 0.00-80.00 hrs, dt= 0.05 hrs
 Type III 24-hr 25-Year Rainfall=6.23"

Area (sf)	CN	Description
64,274	89	<50% Grass cover, Poor, HSG D
17,187	98	Paved parking, HSG D
51,767	98	Roofs, HSG D
133,228	94	Weighted Average
64,274		48.24% Pervious Area
68,954		51.76% Impervious Area

Tc (min)	Length (feet)	Slope (ft/ft)	Velocity (ft/sec)	Capacity (cfs)	Description
6.0					Direct Entry, Minimum TC

Summary for Subcatchment B26: Building 26

Runoff = 1.46 cfs @ 12.09 hrs, Volume= 0.122 af, Depth= 5.99"

Runoff by SCS TR-20 method, UH=SCS, Weighted-CN, Time Span= 0.00-80.00 hrs, dt= 0.05 hrs
 Type III 24-hr 25-Year Rainfall=6.23"

Area (sf)	CN	Description
10,635	98	Roofs, HSG D
10,635		100.00% Impervious Area

Tc (min)	Length (feet)	Slope (ft/ft)	Velocity (ft/sec)	Capacity (cfs)	Description
6.0					Direct Entry, Minimum TC

Summary for Subcatchment B27: Building 27

Runoff = 4.46 cfs @ 12.09 hrs, Volume= 0.373 af, Depth= 5.99"

Runoff by SCS TR-20 method, UH=SCS, Weighted-CN, Time Span= 0.00-80.00 hrs, dt= 0.05 hrs
 Type III 24-hr 25-Year Rainfall=6.23"

Area (sf)	CN	Description
32,552	98	Roofs, HSG D
32,552		100.00% Impervious Area

Tc (min)	Length (feet)	Slope (ft/ft)	Velocity (ft/sec)	Capacity (cfs)	Description
6.0					Direct Entry, Minimum TC

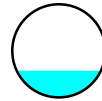
Summary for Reach 3R: Uniroyal South Outfall (Exist.)

Inflow Area = 3.058 ac, 51.76% Impervious, Inflow Depth = 5.52" for 25-Year event
 Inflow = 17.74 cfs @ 12.09 hrs, Volume= 1.408 af
 Outflow = 17.64 cfs @ 12.09 hrs, Volume= 1.408 af, Atten= 1%, Lag= 0.3 min

Routing by Stor-Ind+Trans method, Time Span= 0.00-80.00 hrs, dt= 0.05 hrs
 Max. Velocity= 15.49 fps, Min. Travel Time= 0.2 min
 Avg. Velocity = 5.07 fps, Avg. Travel Time= 0.6 min

Peak Storage= 201 cf @ 12.09 hrs
 Average Depth at Peak Storage= 0.71'
 Bank-Full Depth= 2.50' Flow Area= 4.9 sf, Capacity= 101.22 cfs

30.0" Round Pipe
 n= 0.011 Concrete pipe, straight & clean
 Length= 175.0' Slope= 0.0436'
 Inlet Invert= 85.85', Outlet Invert= 78.22'



Summary for Pond 2P: Area Behind Levee - Uniroyal

Inflow Area = 13.952 ac, 13.08% Impervious, Inflow Depth = 5.07" for 25-Year event
 Inflow = 76.54 cfs @ 12.09 hrs, Volume= 5.895 af
 Outflow = 15.59 cfs @ 12.52 hrs, Volume= 5.895 af, Atten= 80%, Lag= 25.8 min
 Primary = 15.59 cfs @ 12.52 hrs, Volume= 5.895 af

Routing by Stor-Ind method, Time Span= 0.00-80.00 hrs, dt= 0.05 hrs
 Peak Elev= 85.16' @ 12.52 hrs Surf.Area= 87,220 sf Storage= 88,569 cf

Plug-Flow detention time= 66.7 min calculated for 5.891 af (100% of inflow)
 Center-of-Mass det. time= 67.0 min (850.8 - 783.8)

Volume	Invert	Avail.Storage	Storage Description
#1	84.00'	168,115 cf	Custom Stage Data (Prismatic) Listed below (Recalc)

Elevation (feet)	Surf.Area (sq-ft)	Inc.Store (cubic-feet)	Cum.Store (cubic-feet)
84.00	64,860	0	0
86.00	103,255	168,115	168,115

Device	Routing	Invert	Outlet Devices
#1	Primary	84.00'	2.0" x 2.0" Horiz. Catch Basin X 6.00 columns X 6 rows C= 0.600 in 24.0" Grate (32% open area) Limited to weir flow at low heads
#2	Primary	84.00'	2.0" x 2.0" Horiz. Catch Basin X 6.00 columns X 6 rows C= 0.600 in 24.0" Grate (32% open area) Limited to weir flow at low heads
#3	Primary	84.00'	2.0" x 2.0" Horiz. Catch Basin X 6.00 columns X 6 rows C= 0.600 in 24.0" Grate (32% open area) Limited to weir flow at low heads

Primary Outflow Max=15.58 cfs @ 12.52 hrs HW=85.16' (Free Discharge)
 1=Catch Basin (Orifice Controls 5.19 cfs @ 5.19 fps)
 2=Catch Basin (Orifice Controls 5.19 cfs @ 5.19 fps)
 3=Catch Basin (Orifice Controls 5.19 cfs @ 5.19 fps)

Summary for Link 2L: Chicopee River

Inflow Area = 18.001 ac, 24.44% Impervious, Inflow Depth = 5.20" for 25-Year event
 Inflow = 36.17 cfs @ 12.10 hrs, Volume= 7.798 af
 Primary = 36.17 cfs @ 12.10 hrs, Volume= 7.798 af, Atten= 0%, Lag= 0.0 min

Primary outflow = Inflow, Time Span= 0.00-80.00 hrs, dt= 0.05 hrs

Summary for Link 2La: Oak Street Pump Station

Inflow Area = 14.943 ac, 18.85% Impervious, Inflow Depth = 5.13" for 25-Year event
 Inflow = 18.70 cfs @ 12.12 hrs, Volume= 6.390 af
 Primary = 18.70 cfs @ 12.12 hrs, Volume= 6.390 af, Atten= 0%, Lag= 0.0 min

Primary outflow = Inflow, Time Span= 0.00-80.00 hrs, dt= 0.05 hrs

Summary for Subcatchment 2S: EX-DA-2S - Uniroyal Site

Runoff = 101.97 cfs @ 12.09 hrs, Volume= 7.992 af, Depth= 6.87"

Runoff by SCS TR-20 method, UH=SCS, Weighted-CN, Time Span= 0.00-80.00 hrs, dt= 0.05 hrs
 Type III 24-hr 100-Year Rainfall=8.07"

Area (sf)	CN	Description
496,843	89	<50% Grass cover, Poor, HSG D
67,169	98	Paved parking, HSG D
12,351	98	Roofs, HSG D
31,364	79	Woods, Fair, HSG D
607,728	90	Weighted Average
528,208		86.92% Pervious Area
79,520		13.08% Impervious Area

Tc (min)	Length (feet)	Slope (ft/ft)	Velocity (ft/sec)	Capacity (cfs)	Description
4.0	50	0.0520	0.21		Sheet Flow, Sheet Flow Grass: Short n= 0.150 P2= 3.00"
2.3	245	0.0650	1.78		Shallow Concentrated Flow, Shallow Conc. 1 Short Grass Pasture Kv= 7.0 fps
6.3	295	Total			

Summary for Subcatchment 3S: EX-DA-3S - Upper Uniroyal Site

Runoff = 23.25 cfs @ 12.09 hrs, Volume= 1.874 af, Depth= 7.35"

Runoff by SCS TR-20 method, UH=SCS, Weighted-CN, Time Span= 0.00-80.00 hrs, dt= 0.05 hrs
 Type III 24-hr 100-Year Rainfall=8.07"

Area (sf)	CN	Description
64,274	89	<50% Grass cover, Poor, HSG D
17,187	98	Paved parking, HSG D
51,767	98	Roofs, HSG D
133,228	94	Weighted Average
64,274		48.24% Pervious Area
68,954		51.76% Impervious Area

Tc (min)	Length (feet)	Slope (ft/ft)	Velocity (ft/sec)	Capacity (cfs)	Description
6.0					Direct Entry, Minimum TC

Summary for Subcatchment B26: Building 26

Runoff = 1.89 cfs @ 12.09 hrs, Volume= 0.159 af, Depth= 7.83"

Runoff by SCS TR-20 method, UH=SCS, Weighted-CN, Time Span= 0.00-80.00 hrs, dt= 0.05 hrs
 Type III 24-hr 100-Year Rainfall=8.07"

Area (sf)	CN	Description
10,635	98	Roofs, HSG D
10,635		100.00% Impervious Area

Tc (min)	Length (feet)	Slope (ft/ft)	Velocity (ft/sec)	Capacity (cfs)	Description
6.0					Direct Entry, Minimum TC

Summary for Subcatchment B27: Building 27

Runoff = 5.78 cfs @ 12.09 hrs, Volume= 0.488 af, Depth= 7.83"

Runoff by SCS TR-20 method, UH=SCS, Weighted-CN, Time Span= 0.00-80.00 hrs, dt= 0.05 hrs
 Type III 24-hr 100-Year Rainfall=8.07"

Area (sf)	CN	Description
32,552	98	Roofs, HSG D
32,552		100.00% Impervious Area

Tc (min)	Length (feet)	Slope (ft/ft)	Velocity (ft/sec)	Capacity (cfs)	Description
6.0					Direct Entry, Minimum TC

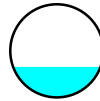
Summary for Reach 3R: Uniroyal South Outfall (Exist.)

Inflow Area = 3.058 ac, 51.76% Impervious, Inflow Depth = 7.35" for 100-Year event
 Inflow = 23.25 cfs @ 12.09 hrs, Volume= 1.874 af
 Outflow = 23.12 cfs @ 12.09 hrs, Volume= 1.874 af, Atten= 1%, Lag= 0.3 min

Routing by Stor-Ind+Trans method, Time Span= 0.00-80.00 hrs, dt= 0.05 hrs
 Max. Velocity= 16.72 fps, Min. Travel Time= 0.2 min
 Avg. Velocity = 5.49 fps, Avg. Travel Time= 0.5 min

Peak Storage= 243 cf @ 12.09 hrs
 Average Depth at Peak Storage= 0.82'
 Bank-Full Depth= 2.50' Flow Area= 4.9 sf, Capacity= 101.22 cfs

30.0" Round Pipe
 n= 0.011 Concrete pipe, straight & clean
 Length= 175.0' Slope= 0.0436'
 Inlet Invert= 85.85', Outlet Invert= 78.22'



Summary for Pond 2P: Area Behind Levee - Uniroyal

Inflow Area = 13.952 ac, 13.08% Impervious, Inflow Depth = 6.87" for 100-Year event
 Inflow = 101.97 cfs @ 12.09 hrs, Volume= 7.992 af
 Outflow = 18.06 cfs @ 12.55 hrs, Volume= 7.992 af, Atten= 82%, Lag= 27.7 min
 Primary = 18.06 cfs @ 12.55 hrs, Volume= 7.992 af

Routing by Stor-Ind method, Time Span= 0.00-80.00 hrs, dt= 0.05 hrs
 Peak Elev= 85.56' @ 12.55 hrs Surf.Area= 94,872 sf Storage= 124,854 cf

Plug-Flow detention time= 75.2 min calculated for 7.987 af (100% of inflow)
 Center-of-Mass det. time= 75.4 min (851.3 - 775.9)

Volume	Invert	Avail.Storage	Storage Description
#1	84.00'	168,115 cf	Custom Stage Data (Prismatic) Listed below (Recalc)

Elevation (feet)	Surf.Area (sq-ft)	Inc.Store (cubic-feet)	Cum.Store (cubic-feet)
84.00	64,860	0	0
86.00	103,255	168,115	168,115

Device	Routing	Invert	Outlet Devices
#1	Primary	84.00'	2.0" x 2.0" Horiz. Catch Basin X 6.00 columns X 6 rows C= 0.600 in 24.0" Grate (32% open area) Limited to weir flow at low heads
#2	Primary	84.00'	2.0" x 2.0" Horiz. Catch Basin X 6.00 columns X 6 rows C= 0.600 in 24.0" Grate (32% open area) Limited to weir flow at low heads
#3	Primary	84.00'	2.0" x 2.0" Horiz. Catch Basin X 6.00 columns X 6 rows C= 0.600 in 24.0" Grate (32% open area) Limited to weir flow at low heads

Primary Outflow Max=18.06 cfs @ 12.55 hrs HW=85.56' (Free Discharge)
 1=Catch Basin (Orifice Controls 6.02 cfs @ 6.02 fps)
 2=Catch Basin (Orifice Controls 6.02 cfs @ 6.02 fps)
 3=Catch Basin (Orifice Controls 6.02 cfs @ 6.02 fps)

Summary for Link 2L: Chicopee River

Inflow Area = 18.001 ac, 24.44% Impervious, Inflow Depth = 7.01" for 100-Year event
 Inflow = 45.39 cfs @ 12.10 hrs, Volume= 10.513 af
 Primary = 45.39 cfs @ 12.10 hrs, Volume= 10.513 af, Atten= 0%, Lag= 0.0 min

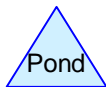
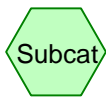
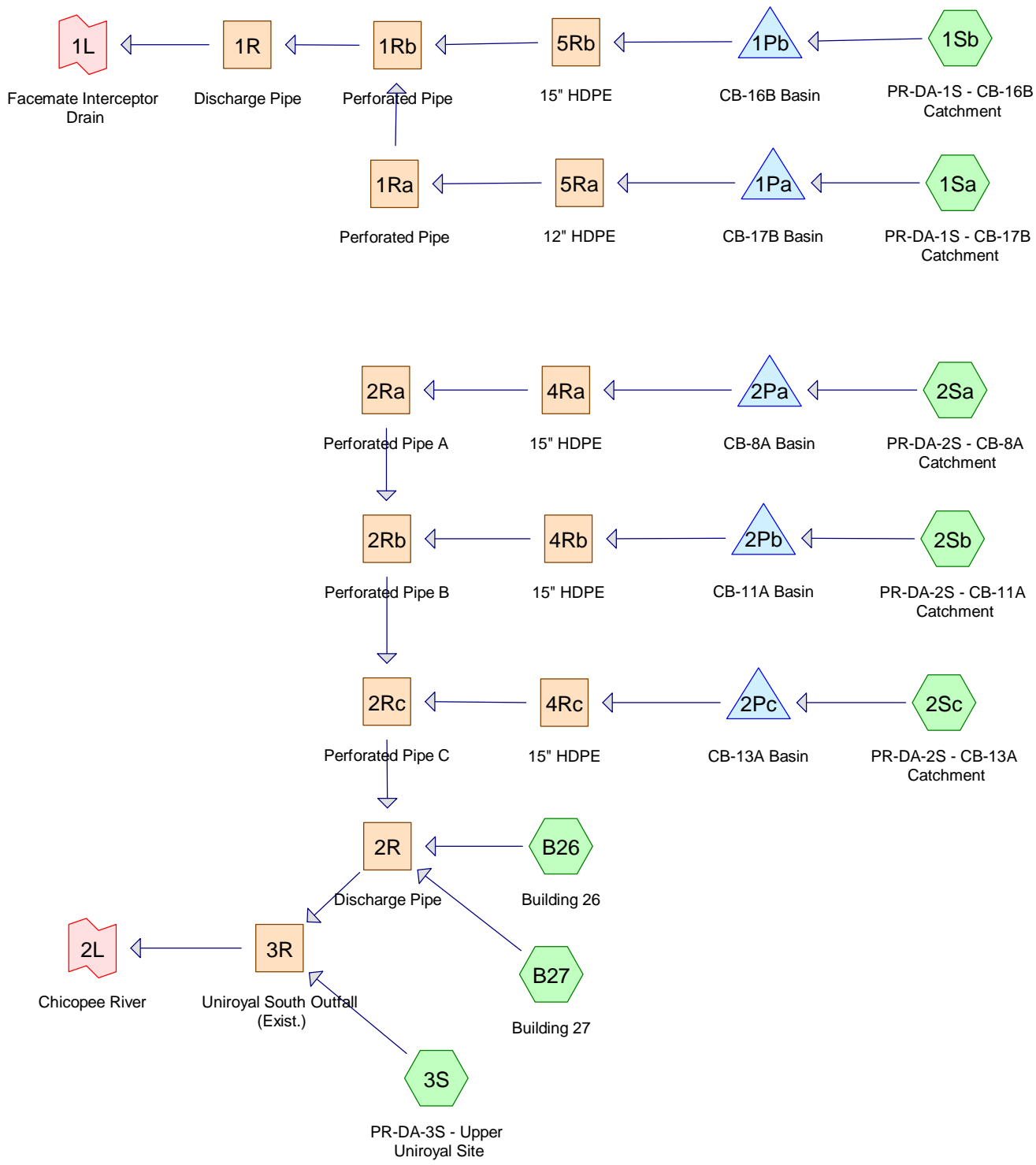
Primary outflow = Inflow, Time Span= 0.00-80.00 hrs, dt= 0.05 hrs

Summary for Link 2La: Oak Street Pump Station

Inflow Area = 14.943 ac, 18.85% Impervious, Inflow Depth = 6.94" for 100-Year event
 Inflow = 22.43 cfs @ 12.11 hrs, Volume= 8.639 af
 Primary = 22.43 cfs @ 12.11 hrs, Volume= 8.639 af, Atten= 0%, Lag= 0.0 min

Primary outflow = Inflow, Time Span= 0.00-80.00 hrs, dt= 0.05 hrs

***APPENDIX F – PROPOSED CONDITIONS
CALCULATIONS***



Routing Diagram for Proposed Conditions - Uniroyal and Facemate - Atlas 14

Prepared by BETA Group, Inc., Printed 5/18/2021

HydroCAD® 10.00-25 s/n 10405 © 2019 HydroCAD Software Solutions LLC

Summary for Subcatchment 1Sa: PR-DA-1S - CB-17B Catchment

Runoff = 2.69 cfs @ 12.10 hrs, Volume= 0.197 af, Depth= 1.04"

Runoff by SCS TR-20 method, UH=SCS, Weighted-CN, Time Span= 0.00-80.00 hrs, dt= 0.05 hrs
 Type III 24-hr 1-Year Rainfall=2.48"

Area (sf)	CN	Description			
74,164	80	>75% Grass cover, Good, HSG D			
6,867	98	Paved parking, HSG D			
6,237	98	Roofs, HSG D			
2,569	98	Water Surface, HSG D			
9,314	79	Woods, Fair, HSG D			
99,151	83	Weighted Average			
83,478		84.19% Pervious Area			
15,674		15.81% Impervious Area			
Tc (min)	Length (feet)	Slope (ft/ft)	Velocity (ft/sec)	Capacity (cfs)	Description
0.6	50	0.0280	1.33		Sheet Flow, Sheet Flow Smooth surfaces n= 0.011 P2= 3.00"
2.6	190	0.0150	1.22		Shallow Concentrated Flow, Shallow Conc. 1 Nearly Bare & Untilled Kv= 10.0 fps
0.7	96	0.0490	2.21		Shallow Concentrated Flow, Shallow Conc. 2 Nearly Bare & Untilled Kv= 10.0 fps
2.1					Direct Entry, Minimum TC
6.0	336				Total

Summary for Subcatchment 1Sb: PR-DA-1S - CB-16B Catchment

Runoff = 3.01 cfs @ 12.10 hrs, Volume= 0.222 af, Depth= 0.98"

Runoff by SCS TR-20 method, UH=SCS, Weighted-CN, Time Span= 0.00-80.00 hrs, dt= 0.05 hrs
 Type III 24-hr 1-Year Rainfall=2.48"

Area (sf)	CN	Description			
93,694	80	>75% Grass cover, Good, HSG D			
10,157	98	Paved parking, HSG D			
2,498	98	Water Surface, HSG D			
11,795	79	Woods, Fair, HSG D			
118,144	82	Weighted Average			
105,489		89.29% Pervious Area			
12,655		10.71% Impervious Area			
Tc (min)	Length (feet)	Slope (ft/ft)	Velocity (ft/sec)	Capacity (cfs)	Description
6.0					Direct Entry, Minimum TC

Summary for Subcatchment 2Sc: PR-DA-2S - CB-13A Catchment

Runoff = 4.22 cfs @ 12.10 hrs, Volume= 0.309 af, Depth= 1.10"

Runoff by SCS TR-20 method, UH=SCS, Weighted-CN, Time Span= 0.00-80.00 hrs, dt= 0.05 hrs
 Type III 24-hr 1-Year Rainfall=2.48"

Area (sf)	CN	Description			
108,361	80	>75% Grass cover, Good, HSG D			
30,845	98	Paved parking, HSG D			
1,607	98	Water Surface, HSG D			
5,822	79	Woods, Fair, HSG D			
146,635	84	Weighted Average			
114,183		77.87% Pervious Area			
32,452		22.13% Impervious Area			
Tc (min)	Length (feet)	Slope (ft/ft)	Velocity (ft/sec)	Capacity (cfs)	Description
5.6	50	0.0220	0.15		Sheet Flow, Sheet Flow Grass: Short n= 0.150 P2= 3.00"
0.3	40	0.0220	2.22		Shallow Concentrated Flow, Shallow Conc. Grassed Waterway Kv= 15.0 fps
0.1					Direct Entry, Minimum TC
6.0	90				Total

Summary for Subcatchment 3S: PR-DA-3S - Upper Uniroyal Site

Runoff = 5.30 cfs @ 12.09 hrs, Volume= 0.386 af, Depth= 1.51"

Runoff by SCS TR-20 method, UH=SCS, Weighted-CN, Time Span= 0.00-80.00 hrs, dt= 0.05 hrs
 Type III 24-hr 1-Year Rainfall=2.48"

Area (sf)	CN	Description			
8,648	89	<50% Grass cover, Poor, HSG D			
55,625	80	>75% Grass cover, Good, HSG D			
17,187	98	Paved parking, HSG D			
51,767	98	Roofs, HSG D			
133,228	90	Weighted Average			
64,274		48.24% Pervious Area			
68,954		51.76% Impervious Area			
Tc (min)	Length (feet)	Slope (ft/ft)	Velocity (ft/sec)	Capacity (cfs)	Description
6.0					Direct Entry, Minimum TC

Summary for Subcatchment 2Sa: PR-DA-2S - CB-8A Catchment

Runoff = 3.63 cfs @ 12.17 hrs, Volume= 0.326 af, Depth= 0.93"

Runoff by SCS TR-20 method, UH=SCS, Weighted-CN, Time Span= 0.00-80.00 hrs, dt= 0.05 hrs
 Type III 24-hr 1-Year Rainfall=2.48"

Area (sf)	CN	Description			
165,088	80	>75% Grass cover, Good, HSG D			
5,904	98	Paved parking, HSG D			
1,265	98	Roofs, HSG D			
3,083	98	Water Surface, HSG D			
8,216	79	Woods, Fair, HSG D			
183,555	81	Weighted Average			
173,304		94.42% Pervious Area			
10,251		5.58% Impervious Area			
Tc (min)	Length (feet)	Slope (ft/ft)	Velocity (ft/sec)	Capacity (cfs)	Description
8.8	50	0.0070	0.09		Sheet Flow, Sheet Flow Grass: Short n= 0.150 P2= 3.00"
3.1	235	0.0070	1.25		Shallow Concentrated Flow, Shallow Conc. 1 Grassed Waterway Kv= 15.0 fps
11.9	285				Total

Summary for Subcatchment 2Sb: PR-DA-2S - CB-11A Catchment

Runoff = 5.81 cfs @ 12.15 hrs, Volume= 0.493 af, Depth= 0.93"

Runoff by SCS TR-20 method, UH=SCS, Weighted-CN, Time Span= 0.00-80.00 hrs, dt= 0.05 hrs
 Type III 24-hr 1-Year Rainfall=2.48"

Area (sf)	CN	Description			
265,478	80	>75% Grass cover, Good, HSG D			
10,628	98	Paved parking, HSG D			
1,422	98	Water Surface, HSG D			
277,528	81	Weighted Average			
265,478		95.66% Pervious Area			
12,050		4.34% Impervious Area			
Tc (min)	Length (feet)	Slope (ft/ft)	Velocity (ft/sec)	Capacity (cfs)	Description
8.0	50	0.0090	0.10		Sheet Flow, Sheet Flow Grass: Short n= 0.150 P2= 3.00"
2.0	175	0.0090	1.42		Shallow Concentrated Flow, Shallow Conc. 1 Grassed Waterway Kv= 15.0 fps
10.0	225				Total

Summary for Subcatchment B26: Building 26

Runoff = 0.57 cfs @ 12.09 hrs, Volume= 0.046 af, Depth= 2.25"

Runoff by SCS TR-20 method, UH=SCS, Weighted-CN, Time Span= 0.00-80.00 hrs, dt= 0.05 hrs
 Type III 24-hr 1-Year Rainfall=2.48"

Area (sf)	CN	Description			
10,635	98	Roofs, HSG D			
10,635		100.00% Impervious Area			
Tc (min)	Length (feet)	Slope (ft/ft)	Velocity (ft/sec)	Capacity (cfs)	Description
6.0					Direct Entry, Minimum TC

Summary for Subcatchment B27: Building 27

Runoff = 1.74 cfs @ 12.09 hrs, Volume= 0.140 af, Depth= 2.25"

Runoff by SCS TR-20 method, UH=SCS, Weighted-CN, Time Span= 0.00-80.00 hrs, dt= 0.05 hrs
 Type III 24-hr 1-Year Rainfall=2.48"

Area (sf)	CN	Description			
32,552	98	Roofs, HSG D			
32,552		100.00% Impervious Area			
Tc (min)	Length (feet)	Slope (ft/ft)	Velocity (ft/sec)	Capacity (cfs)	Description
6.0					Direct Entry, Minimum TC

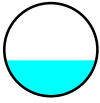
Summary for Reach 1R: Discharge Pipe

Inflow Area = 4.988 ac, 13.04% Impervious, Inflow Depth = 1.01" for 1-Year event
 Inflow = 3.43 cfs @ 12.27 hrs, Volume= 0.420 af
 Outflow = 3.38 cfs @ 12.28 hrs, Volume= 0.420 af, Atten= 1%, Lag= 0.5 min

Routing by Stor-Ind+Trans method, Time Span= 0.00-80.00 hrs, dt= 0.05 hrs
 Max. Velocity= 3.08 fps, Min. Travel Time= 0.3 min
 Avg. Velocity= 1.23 fps, Avg. Travel Time= 0.7 min

Peak Storage= 56 cf @ 12.27 hrs
 Average Depth at Peak Storage= 0.77'
 Bank-Full Depth= 2.00' Flow Area= 3.1 sf, Capacity= 10.96 cfs

24.0" Round Pipe
 n= 0.012
 Length= 50.0' Slope= 0.0020 '
 Inlet Invert= 85.35', Outlet Invert= 85.25'



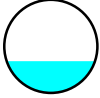
Summary for Reach 1Ra: Perforated Pipe

Inflow Area = 2.276 ac, 15.81% Impervious, Inflow Depth = 1.04" for 1-Year event
 Inflow = 1.54 cfs @ 12.24 hrs, Volume= 0.197 af
 Outflow = 1.53 cfs @ 12.30 hrs, Volume= 0.197 af, Atten= 1%, Lag= 3.9 min

Routing by Stor-Ind+Trans method, Time Span= 0.00-80.00 hrs, dt= 0.05 hrs
 Max. Velocity= 2.92 fps, Min. Travel Time= 2.0 min
 Avg. Velocity = 1.19 fps, Avg. Travel Time= 4.9 min

Peak Storage= 184 cf @ 12.26 hrs
 Average Depth at Peak Storage= 0.51'
 Bank-Full Depth= 1.50' Flow Area= 1.8 sf, Capacity= 6.23 cfs

18.0" Round Pipe
 n= 0.012
 Length= 350.0' Slope= 0.0030 '/
 Inlet Invert= 87.20', Outlet Invert= 86.15'



Summary for Reach 1Rb: Perforated Pipe

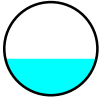
Inflow Area = 4.988 ac, 13.04% Impervious, Inflow Depth = 1.01" for 1-Year event
 Inflow = 3.44 cfs @ 12.24 hrs, Volume= 0.420 af
 Outflow = 3.43 cfs @ 12.27 hrs, Volume= 0.420 af, Atten= 0%, Lag= 1.7 min

Routing by Stor-Ind+Trans method, Time Span= 0.00-80.00 hrs, dt= 0.05 hrs
 Max. Velocity= 3.09 fps, Min. Travel Time= 0.8 min
 Avg. Velocity = 1.23 fps, Avg. Travel Time= 2.0 min

Peak Storage= 167 cf @ 12.25 hrs
 Average Depth at Peak Storage= 0.77'
 Bank-Full Depth= 2.00' Flow Area= 3.1 sf, Capacity= 10.96 cfs

24.0" Round Pipe
 n= 0.012
 Length= 150.0' Slope= 0.0020 '/
 Inlet Invert= 85.65', Outlet Invert= 85.35'

18.0" Round Pipe
 n= 0.012
 Length= 555.0' Slope= 0.0036 '/
 Inlet Invert= 92.00', Outlet Invert= 90.00'



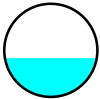
Summary for Reach 2Rb: Perforated Pipe B

Inflow Area = 10.585 ac, 4.84% Impervious, Inflow Depth = 0.93" for 1-Year event
 Inflow = 5.33 cfs @ 12.46 hrs, Volume= 0.819 af
 Outflow = 5.29 cfs @ 12.51 hrs, Volume= 0.819 af, Atten= 1%, Lag= 3.0 min

Routing by Stor-Ind+Trans method, Time Span= 0.00-80.00 hrs, dt= 0.05 hrs / 3
 Max. Velocity= 4.33 fps, Min. Travel Time= 1.5 min
 Avg. Velocity = 1.77 fps, Avg. Travel Time= 3.7 min

Peak Storage= 484 cf @ 12.47 hrs
 Average Depth at Peak Storage= 0.83'
 Bank-Full Depth= 2.00' Flow Area= 3.1 sf, Capacity= 14.85 cfs

24.0" Round Pipe
 n= 0.012
 Length= 395.0' Slope= 0.0037 '/
 Inlet Invert= 89.50', Outlet Invert= 88.05'

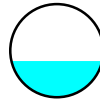


Summary for Reach 2Rc: Perforated Pipe C

Inflow Area = 13.951 ac, 9.01% Impervious, Inflow Depth = 0.97" for 1-Year event
 Inflow = 7.38 cfs @ 12.44 hrs, Volume= 1.127 af
 Outflow = 7.34 cfs @ 12.45 hrs, Volume= 1.128 af, Atten= 0%, Lag= 0.8 min

Routing by Stor-Ind+Trans method, Time Span= 0.00-80.00 hrs, dt= 0.05 hrs / 3
 Max. Velocity= 4.38 fps, Min. Travel Time= 0.5 min
 Avg. Velocity = 1.74 fps, Avg. Travel Time= 1.2 min

Peak Storage= 218 cf @ 12.44 hrs
 Average Depth at Peak Storage= 0.94'
 Bank-Full Depth= 2.50' Flow Area= 4.9 sf, Capacity= 24.65 cfs



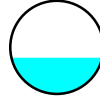
Summary for Reach 2R: Discharge Pipe

Inflow Area = 14.943 ac, 15.05% Impervious, Inflow Depth = 1.05" for 1-Year event
 Inflow = 7.96 cfs @ 12.43 hrs, Volume= 1.313 af
 Outflow = 7.92 cfs @ 12.44 hrs, Volume= 1.314 af, Atten= 0%, Lag= 0.8 min

Routing by Stor-Ind+Trans method, Time Span= 0.00-80.00 hrs, dt= 0.05 hrs / 2
 Max. Velocity= 4.55 fps, Min. Travel Time= 0.5 min
 Avg. Velocity = 1.59 fps, Avg. Travel Time= 1.5 min

Peak Storage= 245 cf @ 12.44 hrs
 Average Depth at Peak Storage= 0.96'
 Bank-Full Depth= 2.50' Flow Area= 4.9 sf, Capacity= 25.19 cfs

30.0" Round Pipe
 n= 0.012
 Length= 140.0' Slope= 0.0032 '/
 Inlet Invert= 87.15', Outlet Invert= 86.70'



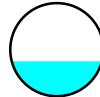
Summary for Reach 2Ra: Perforated Pipe A

Inflow Area = 4.214 ac, 5.58% Impervious, Inflow Depth = 0.93" for 1-Year event
 Inflow = 2.23 cfs @ 12.39 hrs, Volume= 0.326 af
 Outflow = 2.20 cfs @ 12.47 hrs, Volume= 0.326 af, Atten= 1%, Lag= 5.0 min

Routing by Stor-Ind+Trans method, Time Span= 0.00-80.00 hrs, dt= 0.05 hrs / 3
 Max. Velocity= 3.44 fps, Min. Travel Time= 2.7 min
 Avg. Velocity = 1.46 fps, Avg. Travel Time= 6.3 min

Peak Storage= 354 cf @ 12.43 hrs
 Average Depth at Peak Storage= 0.58'
 Bank-Full Depth= 1.50' Flow Area= 1.8 sf, Capacity= 6.83 cfs

30.0" Round Pipe
 n= 0.012
 Length= 130.0' Slope= 0.0031 '/
 Inlet Invert= 87.55', Outlet Invert= 87.15'



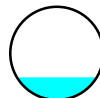
Summary for Reach 3R: Uniroyal South Outfall (Exist.)

Inflow Area = 18.001 ac, 21.28% Impervious, Inflow Depth = 1.13" for 1-Year event
 Inflow = 10.75 cfs @ 12.12 hrs, Volume= 1.699 af
 Outflow = 10.40 cfs @ 12.13 hrs, Volume= 1.699 af, Atten= 3%, Lag= 0.5 min

Routing by Stor-Ind+Trans method, Time Span= 0.00-80.00 hrs, dt= 0.05 hrs / 2
 Max. Velocity= 11.82 fps, Min. Travel Time= 0.2 min
 Avg. Velocity = 4.10 fps, Avg. Travel Time= 0.7 min

Peak Storage= 157 cf @ 12.12 hrs
 Average Depth at Peak Storage= 0.60'
 Bank-Full Depth= 2.50' Flow Area= 4.9 sf, Capacity= 85.65 cfs

30.0" Round Pipe
 n= 0.013
 Length= 175.0' Slope= 0.0436 '/
 Inlet Invert= 85.85', Outlet Invert= 78.22'



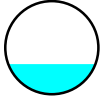
Summary for Reach 4Ra: 15" HDPE

Inflow Area = 4.214 ac, 5.58% Impervious, Inflow Depth = 0.93" for 1-Year event
 Inflow = 2.23 cfs @ 12.39 hrs, Volume= 0.326 af
 Outflow = 2.23 cfs @ 12.39 hrs, Volume= 0.326 af, Atten= 0%, Lag= 0.1 min

Routing by Stor-Ind+Trans method, Time Span= 0.00-80.00 hrs, dt= 0.05 hrs
 Max. Velocity= 6.51 fps, Min. Travel Time= 0.0 min
 Avg. Velocity = 2.86 fps, Avg. Travel Time= 0.0 min

Peak Storage= 2 cf @ 12.39 hrs
 Average Depth at Peak Storage= 0.40'
 Bank-Full Depth= 1.25' Flow Area= 1.2 sf, Capacity= 9.90 cfs

15.0" Round Pipe
 n= 0.012
 Length= 5.0' Slope= 0.0200 '/
 Inlet Invert= 93.50', Outlet Invert= 93.40'



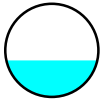
Summary for Reach 4Rb: 15" HDPE

Inflow Area = 6.371 ac, 4.34% Impervious, Inflow Depth = 0.93" for 1-Year event
 Inflow = 3.17 cfs @ 12.38 hrs, Volume= 0.493 af
 Outflow = 3.17 cfs @ 12.37 hrs, Volume= 0.493 af, Atten= 0%, Lag= 0.0 min

Routing by Stor-Ind+Trans method, Time Span= 0.00-80.00 hrs, dt= 0.05 hrs
 Max. Velocity= 7.17 fps, Min. Travel Time= 0.0 min
 Avg. Velocity= 2.99 fps, Avg. Travel Time= 0.1 min

Peak Storage= 4 cf @ 12.37 hrs
 Average Depth at Peak Storage= 0.49'
 Bank-Full Depth= 1.25' Flow Area= 1.2 sf, Capacity= 9.90 cfs

15.0" Round Pipe
 n= 0.012
 Length= 10.0' Slope= 0.0200 '/
 Inlet Invert= 91.00', Outlet Invert= 90.80'



Summary for Reach 4Rc: 15" HDPE

Inflow Area = 3.366 ac, 22.13% Impervious, Inflow Depth = 1.10" for 1-Year event
 Inflow = 2.62 cfs @ 12.21 hrs, Volume= 0.309 af
 Outflow = 2.62 cfs @ 12.21 hrs, Volume= 0.309 af, Atten= 0%, Lag= 0.0 min

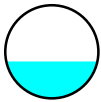
Summary for Reach 5Rb: 15" HDPE

Inflow Area = 2.712 ac, 10.71% Impervious, Inflow Depth = 0.98" for 1-Year event
 Inflow = 2.02 cfs @ 12.21 hrs, Volume= 0.222 af
 Outflow = 2.01 cfs @ 12.21 hrs, Volume= 0.222 af, Atten= 0%, Lag= 0.1 min

Routing by Stor-Ind+Trans method, Time Span= 0.00-80.00 hrs, dt= 0.05 hrs
 Max. Velocity= 4.48 fps, Min. Travel Time= 0.0 min
 Avg. Velocity= 1.80 fps, Avg. Travel Time= 0.1 min

Peak Storage= 6 cf @ 12.21 hrs
 Average Depth at Peak Storage= 0.49'
 Bank-Full Depth= 1.25' Flow Area= 1.2 sf, Capacity= 6.14 cfs

15.0" Round Pipe
 n= 0.012
 Length= 13.0' Slope= 0.0077 '/
 Inlet Invert= 93.60', Outlet Invert= 93.50'



Summary for Pond 1Pa: CB-17B Basin

Inflow Area = 2.276 ac, 15.81% Impervious, Inflow Depth = 1.04" for 1-Year event
 Inflow = 2.69 cfs @ 12.10 hrs, Volume= 0.197 af
 Outflow = 1.54 cfs @ 12.23 hrs, Volume= 0.197 af, Atten= 43%, Lag= 8.3 min
 Primary = 1.54 cfs @ 12.23 hrs, Volume= 0.197 af

Routing by Stor-Ind method, Time Span= 0.00-80.00 hrs, dt= 0.05 hrs
 Peak Elev= 97.51' @ 12.23 hrs Surf.Area= 4,853 sf Storage= 1,881 cf

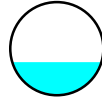
Plug-Flow detention time= 80.9 min calculated for 0.197 af (100% of inflow)
 Center-of-Mass det. time= 81.0 min (926.6 - 845.7)

Volume	Invert	Avail.Storage	Storage Description
#1	97.00'	25,350 cf	Custom Stage Data (Prismatic) Listed below (Recalc)
Elevation (feet)	Surf.Area (sq-ft)	Inc.Store (cubic-feet)	Cum.Store (cubic-feet)
97.00	2,500	0	0
98.00	7,100	4,800	4,800
99.00	10,500	8,800	13,600
100.00	13,000	11,750	25,350

Routing by Stor-Ind+Trans method, Time Span= 0.00-80.00 hrs, dt= 0.05 hrs
 Max. Velocity= 6.81 fps, Min. Travel Time= 0.0 min
 Avg. Velocity= 2.63 fps, Avg. Travel Time= 0.1 min

Peak Storage= 4 cf @ 12.21 hrs
 Average Depth at Peak Storage= 0.44'
 Bank-Full Depth= 1.25' Flow Area= 1.2 sf, Capacity= 9.90 cfs

15.0" Round Pipe
 n= 0.012
 Length= 10.0' Slope= 0.0200 '/
 Inlet Invert= 91.00', Outlet Invert= 90.80'



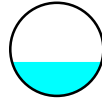
Summary for Reach 5Ra: 12" HDPE

Inflow Area = 2.276 ac, 15.81% Impervious, Inflow Depth = 1.04" for 1-Year event
 Inflow = 1.54 cfs @ 12.23 hrs, Volume= 0.197 af
 Outflow = 1.54 cfs @ 12.24 hrs, Volume= 0.197 af, Atten= 0%, Lag= 0.2 min

Routing by Stor-Ind+Trans method, Time Span= 0.00-80.00 hrs, dt= 0.05 hrs
 Max. Velocity= 5.98 fps, Min. Travel Time= 0.0 min
 Avg. Velocity= 2.50 fps, Avg. Travel Time= 0.0 min

Peak Storage= 1 cf @ 12.24 hrs
 Average Depth at Peak Storage= 0.36'
 Bank-Full Depth= 1.00' Flow Area= 0.8 sf, Capacity= 5.46 cfs

12.0" Round Pipe
 n= 0.012
 Length= 5.0' Slope= 0.0200 '/
 Inlet Invert= 93.60', Outlet Invert= 93.50'



Device	Routing	Invert	Outlet Devices
#1	Primary	97.33'	2.0" x 2.0" Horiz. Catch Basin X 5.00 columns X 5 rows C= 0.600 in 24.0" x 24.0" Grate (17% open area) Limited to weir flow at low heads
#2	Primary	97.00'	1.020 in/hr Exfiltration over Surface area Conductivity to Groundwater Elevation = 82.50'

Primary OutFlow Max=1.54 cfs @ 12.23 hrs HW=97.51' (Free Discharge)
 1=Catch Basin (Orifice Controls 1.42 cfs @ 2.05 fps)
 2=Exfiltration (Controls 0.12 cfs)

Summary for Pond 1Pb: CB-16B Basin

Inflow Area = 2.712 ac, 10.71% Impervious, Inflow Depth = 0.98" for 1-Year event
 Inflow = 3.01 cfs @ 12.10 hrs, Volume= 0.222 af
 Outflow = 2.02 cfs @ 12.21 hrs, Volume= 0.222 af, Atten= 33%, Lag= 6.5 min
 Primary = 2.02 cfs @ 12.21 hrs, Volume= 0.222 af

Routing by Stor-Ind method, Time Span= 0.00-80.00 hrs, dt= 0.05 hrs
 Peak Elev= 97.50' @ 12.21 hrs Surf.Area= 5,052 sf Storage= 2,014 cf

Plug-Flow detention time= 83.0 min calculated for 0.222 af (100% of inflow)
 Center-of-Mass det. time= 83.0 min (932.4 - 849.4)

Volume	Invert	Avail.Storage	Storage Description
#1	97.00'	27,653 cf	Custom Stage Data (Prismatic) Listed below (Recalc)
Elevation (feet)	Surf.Area (sq-ft)	Inc.Store (cubic-feet)	Cum.Store (cubic-feet)
97.00	2,945	0	0
98.00	7,130	5,038	5,038
99.00	11,400	9,265	14,303
100.00	15,300	13,350	27,653

Device	Routing	Invert	Outlet Devices
#1	Primary	97.33'	2.0" x 2.0" Horiz. Catch Basin X 6.00 columns X 6 rows C= 0.600 in 24.0" x 24.0" Grate (25% open area) Limited to weir flow at low heads
#2	Primary	97.00'	1.020 in/hr Exfiltration over Surface area Conductivity to Groundwater Elevation = 82.50'

Primary OutFlow Max=2.00 cfs @ 12.21 hrs HW=97.50' (Free Discharge)
 1=Catch Basin (Weir Controls 1.88 cfs @ 1.36 fps)
 2=Exfiltration (Controls 0.12 cfs)

Summary for Pond 2Pa: CB-8A Basin

Inflow Area = 4.214 ac, 5.58% Impervious, Inflow Depth = 0.93" for 1-Year event
 Inflow = 3.63 cfs @ 12.17 hrs, Volume= 0.326 af
 Outflow = 2.23 cfs @ 12.39 hrs, Volume= 0.326 af, Atten= 39%, Lag= 12.9 min
 Primary = 2.23 cfs @ 12.39 hrs, Volume= 0.326 af

Routing by Stor-Ind method, Time Span= 0.00-80.00 hrs, dt= 0.05 hrs
 Peak Elev= 97.51' @ 12.39 hrs Surf.Area= 9,837 sf Storage= 3,270 cf

Plug-Flow detention time= 78.8 min calculated for 0.326 af (100% of inflow)
 Center-of-Mass det. time= 78.8 min (937.4 - 858.6)

Volume	Invert	Avail.Storage	Storage Description
#1	97.00'	47,780 cf	Custom Stage Data (Prismatic) Listed below (Recalc)

Elevation (feet)	Surf.Area (sq-ft)	Inc.Store (cubic-feet)	Cum.Store (cubic-feet)
97.00	3,000	0	0
98.00	16,420	9,710	9,710
99.00	19,000	17,710	27,420
100.00	21,720	20,360	47,780

Device	Routing	Invert	Outlet Devices
#1	Primary	97.33'	2.0" x 2.0" Horiz. Catch Basin X 6.00 columns X 6 rows C= 0.600 in 24.0" x 24.0" Grate (25% open area) Limited to weir flow at low heads
#2	Primary	97.00'	1.020 in/hr Exfiltration over Surface area Conductivity to Groundwater Elevation = 80.0'

Primary OutFlow Max=2.22 cfs @ 12.39 hrs HW=97.51' (Free Discharge)
 1=Catch Basin (Weir Controls 1.98 cfs @ 1.38 fps)
 2=Exfiltration (Controls 0.24 cfs)

Summary for Pond 2Pb: CB-11A Basin

Inflow Area = 6.371 ac, 4.34% Impervious, Inflow Depth = 0.93" for 1-Year event
 Inflow = 5.81 cfs @ 12.15 hrs, Volume= 0.493 af
 Outflow = 3.17 cfs @ 12.38 hrs, Volume= 0.493 af, Atten= 45%, Lag= 13.8 min
 Primary = 3.17 cfs @ 12.38 hrs, Volume= 0.493 af

Routing by Stor-Ind method, Time Span= 0.00-80.00 hrs, dt= 0.05 hrs
 Peak Elev= 95.19' @ 12.38 hrs Surf.Area= 11,022 sf Storage= 4,250 cf

Plug-Flow detention time= 56.7 min calculated for 0.493 af (100% of inflow)
 Center-of-Mass det. time= 56.6 min (913.4 - 856.8)

Volume	Invert	Avail.Storage	Storage Description
#1	94.50'	78,798 cf	Custom Stage Data (Prismatic) Listed below (Recalc)

Primary OutFlow Max=2.62 cfs @ 12.21 hrs HW=95.09' (Free Discharge)
 1=Catch Basin (Orifice Controls 2.46 cfs @ 2.46 fps)
 2=Exfiltration (Controls 0.16 cfs)

Summary for Link 1L: Facemate Interceptor Drain

Inflow Area = 4.988 ac, 13.04% Impervious, Inflow Depth = 1.01" for 1-Year event
 Inflow = 3.38 cfs @ 12.28 hrs, Volume= 0.420 af
 Primary = 3.38 cfs @ 12.28 hrs, Volume= 0.420 af, Atten= 0%, Lag= 0.0 min

Primary outflow = Inflow, Time Span= 0.00-80.00 hrs, dt= 0.05 hrs

Summary for Link 2L: Chicopee River

Inflow Area = 18.001 ac, 21.28% Impervious, Inflow Depth = 1.13" for 1-Year event
 Inflow = 10.40 cfs @ 12.13 hrs, Volume= 1.699 af
 Primary = 10.40 cfs @ 12.13 hrs, Volume= 1.699 af, Atten= 0%, Lag= 0.0 min

Primary outflow = Inflow, Time Span= 0.00-80.00 hrs, dt= 0.05 hrs

Elevation (feet)	Surf.Area (sq-ft)	Inc.Store (cubic-feet)	Cum.Store (cubic-feet)
94.50	1,720	0	0
95.00	7,950	2,418	2,418
96.00	23,855	15,903	18,320
97.00	30,550	27,203	45,523
98.00	36,000	33,275	78,798

Device	Routing	Invert	Outlet Devices
#1	Primary	94.83'	2.0" x 2.0" Horiz. Catch Basin X 6.00 columns X 6 rows C= 0.600 in 24.0" x 24.0" Grate (25% open area) Limited to weir flow at low heads
#2	Primary	94.50'	1.020 in/hr Exfiltration over Surface area Conductivity to Groundwater Elevation = 80.50'

Primary OutFlow Max=3.17 cfs @ 12.38 hrs HW=95.19' (Free Discharge)
 1=Catch Basin (Orifice Controls 2.90 cfs @ 2.90 fps)
 2=Exfiltration (Controls 0.27 cfs)

Summary for Pond 2Pc: CB-13A Basin

Inflow Area = 3.366 ac, 22.13% Impervious, Inflow Depth = 1.10" for 1-Year event
 Inflow = 4.22 cfs @ 12.10 hrs, Volume= 0.309 af
 Outflow = 2.62 cfs @ 12.21 hrs, Volume= 0.309 af, Atten= 38%, Lag= 7.0 min
 Primary = 2.62 cfs @ 12.21 hrs, Volume= 0.309 af

Routing by Stor-Ind method, Time Span= 0.00-80.00 hrs, dt= 0.05 hrs
 Peak Elev= 95.09' @ 12.21 hrs Surf.Area= 6,482 sf Storage= 2,557 cf

Plug-Flow detention time= 61.4 min calculated for 0.309 af (100% of inflow)
 Center-of-Mass det. time= 61.3 min (903.2 - 841.9)

Volume	Invert	Avail.Storage	Storage Description
#1	94.50'	31,216 cf	Custom Stage Data (Prismatic) Listed below (Recalc)

Elevation (feet)	Surf.Area (sq-ft)	Inc.Store (cubic-feet)	Cum.Store (cubic-feet)
94.50	1,580	0	0
95.00	6,285	1,966	1,966
96.00	8,420	7,353	9,319
97.00	10,550	9,485	18,804
98.00	14,275	12,413	31,216

Device	Routing	Invert	Outlet Devices
#1	Primary	94.83'	2.0" x 2.0" Horiz. Catch Basin X 6.00 columns X 6 rows C= 0.600 in 24.0" x 24.0" Grate (25% open area) Limited to weir flow at low heads
#2	Primary	94.50'	1.020 in/hr Exfiltration over Surface area Conductivity to Groundwater Elevation = 80.50'

Summary for Subcatchment 1Sa: PR-DA-1S - CB-17B Catchment

Runoff = 4.03 cfs @ 12.09 hrs, Volume= 0.293 af, Depth= 1.54"

Runoff by SCS TR-20 method, UH=SCS, Weighted-CN, Time Span= 0.00-80.00 hrs, dt= 0.05 hrs
 Type III 24-hr 2-Year Rainfall=3.12"

Area (sf)	CN	Description			
74,164	80	>75% Grass cover, Good, HSG D			
6,867	98	Paved parking, HSG D			
6,237	98	Roofs, HSG D			
2,569	98	Water Surface, HSG D			
9,314	79	Woods, Fair, HSG D			
99,151	83	Weighted Average			
83,478		84.19% Pervious Area			
15,674		15.81% Impervious Area			
Tc (min)	Length (feet)	Slope (ft/ft)	Velocity (ft/sec)	Capacity (cfs)	Description
0.6	50	0.0280	1.33		Sheet Flow, Sheet Flow Smooth surfaces n= 0.011 P2= 3.00"
2.6	190	0.0150	1.22		Shallow Concentrated Flow, Shallow Conc. 1 Nearly Bare & Untilled K _v = 10.0 fps
0.7	96	0.0490	2.21		Shallow Concentrated Flow, Shallow Conc. 2 Nearly Bare & Untilled K _v = 10.0 fps
2.1					Direct Entry, Minimum TC
6.0	336	Total			

Summary for Subcatchment 1Sb: PR-DA-1S - CB-16B Catchment

Runoff = 4.58 cfs @ 12.09 hrs, Volume= 0.333 af, Depth= 1.47"

Runoff by SCS TR-20 method, UH=SCS, Weighted-CN, Time Span= 0.00-80.00 hrs, dt= 0.05 hrs
 Type III 24-hr 2-Year Rainfall=3.12"

Area (sf)	CN	Description			
93,694	80	>75% Grass cover, Good, HSG D			
10,157	98	Paved parking, HSG D			
2,498	98	Water Surface, HSG D			
11,795	79	Woods, Fair, HSG D			
118,144	82	Weighted Average			
105,489		89.29% Pervious Area			
12,655		10.71% Impervious Area			
Tc (min)	Length (feet)	Slope (ft/ft)	Velocity (ft/sec)	Capacity (cfs)	Description
6.0					Direct Entry, Minimum TC

Summary for Subcatchment 2Sa: PR-DA-2S - CB-8A Catchment

Runoff = 5.63 cfs @ 12.17 hrs, Volume= 0.494 af, Depth= 1.41"

Runoff by SCS TR-20 method, UH=SCS, Weighted-CN, Time Span= 0.00-80.00 hrs, dt= 0.05 hrs
 Type III 24-hr 2-Year Rainfall=3.12"

Area (sf)	CN	Description
165,088	80	>75% Grass cover, Good, HSG D
5,904	98	Paved parking, HSG D
1,265	98	Roofs, HSG D
3,083	98	Water Surface, HSG D
8,216	79	Woods, Fair, HSG D
183,555	81	Weighted Average
173,304		94.42% Pervious Area
10,251		5.58% Impervious Area

Tc (min)	Length (feet)	Slope (ft/ft)	Velocity (ft/sec)	Capacity (cfs)	Description
8.8	50	0.0070	0.09		Sheet Flow, Sheet Flow Grass: Short n= 0.150 P2= 3.00"
3.1	235	0.0070	1.25		Shallow Concentrated Flow, Shallow Conc. 1 Grassed Waterway Kv= 15.0 fps
11.9	285				Total

Summary for Subcatchment 2Sb: PR-DA-2S - CB-11A Catchment

Runoff = 8.99 cfs @ 12.15 hrs, Volume= 0.747 af, Depth= 1.41"

Runoff by SCS TR-20 method, UH=SCS, Weighted-CN, Time Span= 0.00-80.00 hrs, dt= 0.05 hrs
 Type III 24-hr 2-Year Rainfall=3.12"

Area (sf)	CN	Description
265,478	80	>75% Grass cover, Good, HSG D
10,628	98	Paved parking, HSG D
1,422	98	Water Surface, HSG D
277,528	81	Weighted Average
265,478		95.66% Pervious Area
12,050		4.34% Impervious Area

Tc (min)	Length (feet)	Slope (ft/ft)	Velocity (ft/sec)	Capacity (cfs)	Description
8.0	50	0.0090	0.10		Sheet Flow, Sheet Flow Grass: Short n= 0.150 P2= 3.00"
2.0	175	0.0090	1.42		Shallow Concentrated Flow, Shallow Conc. 1 Grassed Waterway Kv= 15.0 fps
10.0	225				Total

Summary for Subcatchment B26: Building 26

Runoff = 0.72 cfs @ 12.09 hrs, Volume= 0.059 af, Depth= 2.89"

Runoff by SCS TR-20 method, UH=SCS, Weighted-CN, Time Span= 0.00-80.00 hrs, dt= 0.05 hrs
 Type III 24-hr 2-Year Rainfall=3.12"

Area (sf)	CN	Description
10,635	98	Roofs, HSG D
10,635		100.00% Impervious Area

Tc (min)	Length (feet)	Slope (ft/ft)	Velocity (ft/sec)	Capacity (cfs)	Description
6.0					Direct Entry, Minimum TC

Summary for Subcatchment B27: Building 27

Runoff = 2.21 cfs @ 12.09 hrs, Volume= 0.180 af, Depth= 2.89"

Runoff by SCS TR-20 method, UH=SCS, Weighted-CN, Time Span= 0.00-80.00 hrs, dt= 0.05 hrs
 Type III 24-hr 2-Year Rainfall=3.12"

Area (sf)	CN	Description
32,552	98	Roofs, HSG D
32,552		100.00% Impervious Area

Tc (min)	Length (feet)	Slope (ft/ft)	Velocity (ft/sec)	Capacity (cfs)	Description
6.0					Direct Entry, Minimum TC

Summary for Reach 1R: Discharge Pipe

Inflow Area = 4.988 ac, 13.04% Impervious, Inflow Depth = 1.51" for 2-Year event
 Inflow = 4.87 cfs @ 12.28 hrs, Volume= 0.626 af
 Outflow = 4.87 cfs @ 12.29 hrs, Volume= 0.626 af, Atten= 0%, Lag= 0.5 min

Routing by Stor-Ind+Trans method, Time Span= 0.00-80.00 hrs, dt= 0.05 hrs
 Max. Velocity= 3.39 fps, Min. Travel Time= 0.2 min
 Avg. Velocity = 1.30 fps, Avg. Travel Time= 0.6 min

Peak Storage= 72 cf @ 12.28 hrs
 Average Depth at Peak Storage= 0.93'
 Bank-Full Depth= 2.00' Flow Area= 3.1 sf, Capacity= 10.96 cfs

24.0" Round Pipe
 n= 0.012
 Length= 50.0' Slope= 0.0020 /'
 Inlet Invert= 85.35', Outlet Invert= 85.25'

Summary for Subcatchment 2Sc: PR-DA-2S - CB-13A Catchment

Runoff = 6.25 cfs @ 12.09 hrs, Volume= 0.453 af, Depth= 1.62"

Runoff by SCS TR-20 method, UH=SCS, Weighted-CN, Time Span= 0.00-80.00 hrs, dt= 0.05 hrs
 Type III 24-hr 2-Year Rainfall=3.12"

Area (sf)	CN	Description
108,361	80	>75% Grass cover, Good, HSG D
30,845	98	Paved parking, HSG D
1,607	98	Water Surface, HSG D
5,822	79	Woods, Fair, HSG D
146,635	84	Weighted Average
114,183		77.87% Pervious Area
32,452		22.13% Impervious Area

Tc (min)	Length (feet)	Slope (ft/ft)	Velocity (ft/sec)	Capacity (cfs)	Description
5.6	50	0.0220	0.15		Sheet Flow, Sheet Flow Grass: Short n= 0.150 P2= 3.00"
0.3	40	0.0220	2.22		Shallow Concentrated Flow, Shallow Conc. Grassed Waterway Kv= 15.0 fps
0.1					Direct Entry, Minimum TC
6.0	90				Total

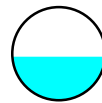
Summary for Subcatchment 3S: PR-DA-3S - Upper Uniroyal Site

Runoff = 7.28 cfs @ 12.09 hrs, Volume= 0.534 af, Depth= 2.09"

Runoff by SCS TR-20 method, UH=SCS, Weighted-CN, Time Span= 0.00-80.00 hrs, dt= 0.05 hrs
 Type III 24-hr 2-Year Rainfall=3.12"

Area (sf)	CN	Description
8,648	89	<50% Grass cover, Poor, HSG D
55,625	80	>75% Grass cover, Good, HSG D
17,187	98	Paved parking, HSG D
51,767	98	Roofs, HSG D
133,228	90	Weighted Average
64,274		48.24% Pervious Area
68,954		51.76% Impervious Area

Tc (min)	Length (feet)	Slope (ft/ft)	Velocity (ft/sec)	Capacity (cfs)	Description
6.0					Direct Entry, Minimum TC



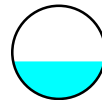
Summary for Reach 1Ra: Perforated Pipe

Inflow Area = 2.276 ac, 15.81% Impervious, Inflow Depth = 1.54" for 2-Year event
 Inflow = 2.11 cfs @ 12.26 hrs, Volume= 0.293 af
 Outflow = 2.11 cfs @ 12.31 hrs, Volume= 0.293 af, Atten= 0%, Lag= 3.5 min

Routing by Stor-Ind+Trans method, Time Span= 0.00-80.00 hrs, dt= 0.05 hrs
 Max. Velocity= 3.18 fps, Min. Travel Time= 1.8 min
 Avg. Velocity = 1.26 fps, Avg. Travel Time= 4.6 min

Peak Storage= 232 cf @ 12.28 hrs
 Average Depth at Peak Storage= 0.60'
 Bank-Full Depth= 1.50' Flow Area= 1.8 sf, Capacity= 6.23 cfs

18.0" Round Pipe
 n= 0.012
 Length= 350.0' Slope= 0.0030 /'
 Inlet Invert= 87.20', Outlet Invert= 86.15'



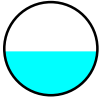
Summary for Reach 1Rb: Perforated Pipe

Inflow Area = 4.988 ac, 13.04% Impervious, Inflow Depth = 1.51" for 2-Year event
 Inflow = 4.88 cfs @ 12.26 hrs, Volume= 0.626 af
 Outflow = 4.87 cfs @ 12.28 hrs, Volume= 0.626 af, Atten= 0%, Lag= 1.2 min

Routing by Stor-Ind+Trans method, Time Span= 0.00-80.00 hrs, dt= 0.05 hrs
 Max. Velocity= 3.39 fps, Min. Travel Time= 0.7 min
 Avg. Velocity = 1.30 fps, Avg. Travel Time= 1.9 min

Peak Storage= 216 cf @ 12.27 hrs
 Average Depth at Peak Storage= 0.94'
 Bank-Full Depth= 2.00' Flow Area= 3.1 sf, Capacity= 10.96 cfs

24.0" Round Pipe
 n= 0.012
 Length= 150.0' Slope= 0.0020 /'
 Inlet Invert= 85.65', Outlet Invert= 85.35'



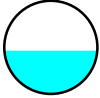
Summary for Reach 2R: Discharge Pipe

Inflow Area = 14.943 ac, 15.05% Impervious, Inflow Depth = 1.55" for 2-Year event
 Inflow = 10.97 cfs @ 12.39 hrs, Volume= 1.932 af
 Outflow = 10.95 cfs @ 12.41 hrs, Volume= 1.932 af, Atten= 0%, Lag= 1.0 min

Routing by Stor-Ind+Trans method, Time Span= 0.00-80.00 hrs, dt= 0.05 hrs / 2
 Max. Velocity= 4.95 fps, Min. Travel Time= 0.5 min
 Avg. Velocity= 1.72 fps, Avg. Travel Time= 1.4 min

Peak Storage= 310 cf @ 12.40 hrs
 Average Depth at Peak Storage= 1.15'
 Bank-Full Depth= 2.50' Flow Area= 4.9 sf, Capacity= 25.19 cfs

30.0" Round Pipe
 n= 0.012
 Length= 140.0' Slope= 0.0032 '/
 Inlet Invert= 87.15', Outlet Invert= 86.70'



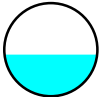
Summary for Reach 2Ra: Perforated Pipe A

Inflow Area = 4.214 ac, 5.58% Impervious, Inflow Depth = 1.41" for 2-Year event
 Inflow = 3.06 cfs @ 12.42 hrs, Volume= 0.494 af
 Outflow = 3.05 cfs @ 12.49 hrs, Volume= 0.494 af, Atten= 0%, Lag= 4.6 min

Routing by Stor-Ind+Trans method, Time Span= 0.00-80.00 hrs, dt= 0.05 hrs / 3
 Max. Velocity= 3.76 fps, Min. Travel Time= 2.5 min
 Avg. Velocity= 1.55 fps, Avg. Travel Time= 6.0 min

Peak Storage= 451 cf @ 12.45 hrs
 Average Depth at Peak Storage= 0.70'
 Bank-Full Depth= 1.50' Flow Area= 1.8 sf, Capacity= 6.83 cfs

30.0" Round Pipe
 n= 0.012
 Length= 130.0' Slope= 0.0031 '/
 Inlet Invert= 87.55', Outlet Invert= 87.15'



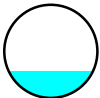
Summary for Reach 3R: Uniroyal South Outfall (Exist.)

Inflow Area = 18.001 ac, 21.28% Impervious, Inflow Depth = 1.64" for 2-Year event
 Inflow = 15.57 cfs @ 12.11 hrs, Volume= 2.466 af
 Outflow = 15.36 cfs @ 12.11 hrs, Volume= 2.466 af, Atten= 1%, Lag= 0.3 min

Routing by Stor-Ind+Trans method, Time Span= 0.00-80.00 hrs, dt= 0.05 hrs / 2
 Max. Velocity= 13.22 fps, Min. Travel Time= 0.2 min
 Avg. Velocity= 4.46 fps, Avg. Travel Time= 0.7 min

Peak Storage= 204 cf @ 12.11 hrs
 Average Depth at Peak Storage= 0.72'
 Bank-Full Depth= 2.50' Flow Area= 4.9 sf, Capacity= 85.65 cfs

30.0" Round Pipe
 n= 0.013
 Length= 175.0' Slope= 0.0436 '/
 Inlet Invert= 85.85', Outlet Invert= 78.22'

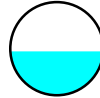


Summary for Reach 4Ra: 15" HDPE

Inflow Area = 4.214 ac, 5.58% Impervious, Inflow Depth = 1.41" for 2-Year event
 Inflow = 3.06 cfs @ 12.42 hrs, Volume= 0.494 af
 Outflow = 3.06 cfs @ 12.42 hrs, Volume= 0.494 af, Atten= 0%, Lag= 0.0 min

Routing by Stor-Ind+Trans method, Time Span= 0.00-80.00 hrs, dt= 0.05 hrs
 Max. Velocity= 7.11 fps, Min. Travel Time= 0.0 min
 Avg. Velocity= 3.04 fps, Avg. Travel Time= 0.0 min

18.0" Round Pipe
 n= 0.012
 Length= 555.0' Slope= 0.0036 '/
 Inlet Invert= 92.00', Outlet Invert= 90.00'



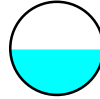
Summary for Reach 2Rb: Perforated Pipe B

Inflow Area = 10.585 ac, 4.84% Impervious, Inflow Depth = 1.41" for 2-Year event
 Inflow = 7.11 cfs @ 12.47 hrs, Volume= 1.241 af
 Outflow = 7.10 cfs @ 12.51 hrs, Volume= 1.241 af, Atten= 0%, Lag= 2.7 min

Routing by Stor-Ind+Trans method, Time Span= 0.00-80.00 hrs, dt= 0.05 hrs / 3
 Max. Velocity= 4.67 fps, Min. Travel Time= 1.4 min
 Avg. Velocity= 1.91 fps, Avg. Travel Time= 3.4 min

Peak Storage= 600 cf @ 12.49 hrs
 Average Depth at Peak Storage= 0.97'
 Bank-Full Depth= 2.00' Flow Area= 3.1 sf, Capacity= 14.85 cfs

24.0" Round Pipe
 n= 0.012
 Length= 395.0' Slope= 0.0037 '/
 Inlet Invert= 89.50', Outlet Invert= 88.05'



Summary for Reach 2Rc: Perforated Pipe C

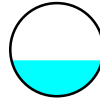
Inflow Area = 13.951 ac, 9.01% Impervious, Inflow Depth = 1.46" for 2-Year event
 Inflow = 10.13 cfs @ 12.43 hrs, Volume= 1.694 af
 Outflow = 10.12 cfs @ 12.44 hrs, Volume= 1.694 af, Atten= 0%, Lag= 0.9 min

Routing by Stor-Ind+Trans method, Time Span= 0.00-80.00 hrs, dt= 0.05 hrs / 3
 Max. Velocity= 4.77 fps, Min. Travel Time= 0.5 min
 Avg. Velocity= 1.87 fps, Avg. Travel Time= 1.2 min

Peak Storage= 276 cf @ 12.43 hrs
 Average Depth at Peak Storage= 1.12'
 Bank-Full Depth= 2.50' Flow Area= 4.9 sf, Capacity= 24.65 cfs

Peak Storage= 2 cf @ 12.42 hrs
 Average Depth at Peak Storage= 0.48'
 Bank-Full Depth= 1.25' Flow Area= 1.2 sf, Capacity= 9.90 cfs

15.0" Round Pipe
 n= 0.012
 Length= 5.0' Slope= 0.0200 '/
 Inlet Invert= 93.50', Outlet Invert= 93.40'



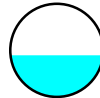
Summary for Reach 4Rb: 15" HDPE

Inflow Area = 6.371 ac, 4.34% Impervious, Inflow Depth = 1.41" for 2-Year event
 Inflow = 4.07 cfs @ 12.44 hrs, Volume= 0.747 af
 Outflow = 4.07 cfs @ 12.44 hrs, Volume= 0.747 af, Atten= 0%, Lag= 0.2 min

Routing by Stor-Ind+Trans method, Time Span= 0.00-80.00 hrs, dt= 0.05 hrs
 Max. Velocity= 7.67 fps, Min. Travel Time= 0.0 min
 Avg. Velocity= 3.22 fps, Avg. Travel Time= 0.1 min

Peak Storage= 5 cf @ 12.44 hrs
 Average Depth at Peak Storage= 0.56'
 Bank-Full Depth= 1.25' Flow Area= 1.2 sf, Capacity= 9.90 cfs

15.0" Round Pipe
 n= 0.012
 Length= 10.0' Slope= 0.0200 '/
 Inlet Invert= 91.00', Outlet Invert= 90.80'



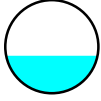
Summary for Reach 4Rc: 15" HDPE

Inflow Area = 3.366 ac, 22.13% Impervious, Inflow Depth = 1.62" for 2-Year event
 Inflow = 3.36 cfs @ 12.24 hrs, Volume= 0.453 af
 Outflow = 3.37 cfs @ 12.25 hrs, Volume= 0.453 af, Atten= 0%, Lag= 0.1 min

Routing by Stor-Ind+Trans method, Time Span= 0.00-80.00 hrs, dt= 0.05 hrs
 Max. Velocity= 7.29 fps, Min. Travel Time= 0.0 min
 Avg. Velocity = 2.79 fps, Avg. Travel Time= 0.1 min

Peak Storage= 5 cf @ 12.24 hrs
 Average Depth at Peak Storage= 0.50'
 Bank-Full Depth= 1.25' Flow Area= 1.2 sf, Capacity= 9.90 cfs

15.0" Round Pipe
 n= 0.012
 Length= 10.0' Slope= 0.0200 '/'
 Inlet Invert= 91.00', Outlet Invert= 90.80'



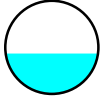
Summary for Reach 5Ra: 12" HDPE

Inflow Area = 2.276 ac, 15.81% Impervious, Inflow Depth = 1.54" for 2-Year event
 Inflow = 2.11 cfs @ 12.26 hrs, Volume= 0.293 af
 Outflow = 2.11 cfs @ 12.26 hrs, Volume= 0.293 af, Atten= 0%, Lag= 0.0 min

Routing by Stor-Ind+Trans method, Time Span= 0.00-80.00 hrs, dt= 0.05 hrs
 Max. Velocity= 6.51 fps, Min. Travel Time= 0.0 min
 Avg. Velocity = 2.65 fps, Avg. Travel Time= 0.0 min

Peak Storage= 2 cf @ 12.25 hrs
 Average Depth at Peak Storage= 0.43'
 Bank-Full Depth= 1.00' Flow Area= 0.8 sf, Capacity= 5.46 cfs

12.0" Round Pipe
 n= 0.012
 Length= 5.0' Slope= 0.0200 '/'
 Inlet Invert= 93.60', Outlet Invert= 93.50'



Device	Routing	Invert	Outlet Devices
#1	Primary	97.33'	2.0" x 2.0" Horiz. Catch Basin X 5.00 columns X 5 rows C= 0.600 in 24.0" x 24.0" Grate (17% open area) Limited to weir flow at low heads
#2	Primary	97.00'	1.020 in/hr Exfiltration over Surface area Conductivity to Groundwater Elevation = 82.50'

Primary OutFlow Max=2.11 cfs @ 12.26 hrs HW=97.68' (Free Discharge)
 1=Catch Basin (Orifice Controls 1.97 cfs @ 2.84 fps)
 2=Exfiltration (Controls 0.14 cfs)

Summary for Pond 1Pb: CB-16B Basin

Inflow Area = 2.712 ac, 10.71% Impervious, Inflow Depth = 1.47" for 2-Year event
 Inflow = 4.58 cfs @ 12.09 hrs, Volume= 0.333 af
 Outflow = 2.84 cfs @ 12.21 hrs, Volume= 0.333 af, Atten= 38%, Lag= 7.0 min
 Primary = 2.84 cfs @ 12.21 hrs, Volume= 0.333 af

Routing by Stor-Ind method, Time Span= 0.00-80.00 hrs, dt= 0.05 hrs
 Peak Elev= 97.65' @ 12.21 hrs Surf.Area= 5,648 sf Storage= 2,776 cf

Plug-Flow detention time= 69.0 min calculated for 0.333 af (100% of inflow)
 Center-of-Mass det. time= 69.1 min (906.6 - 837.5)

Volume	Invert	Avail.Storage	Storage Description
#1	97.00'	27,653 cf	Custom Stage Data (Prismatic) Listed below (Recalc)
Elevation (feet)	Surf.Area (sq-ft)	Inc.Store (cubic-feet)	Cum.Store (cubic-feet)
97.00	2,945	0	0
98.00	7,130	5,038	5,038
99.00	11,400	9,265	14,303
100.00	15,300	13,350	27,653

Device	Routing	Invert	Outlet Devices
#1	Primary	97.33'	2.0" x 2.0" Horiz. Catch Basin X 6.00 columns X 6 rows C= 0.600 in 24.0" x 24.0" Grate (25% open area) Limited to weir flow at low heads
#2	Primary	97.00'	1.020 in/hr Exfiltration over Surface area Conductivity to Groundwater Elevation = 82.50'

Primary OutFlow Max=2.84 cfs @ 12.21 hrs HW=97.64' (Free Discharge)
 1=Catch Basin (Orifice Controls 2.70 cfs @ 2.70 fps)
 2=Exfiltration (Controls 0.14 cfs)

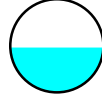
Summary for Reach 5Rb: 15" HDPE

Inflow Area = 2.712 ac, 10.71% Impervious, Inflow Depth = 1.47" for 2-Year event
 Inflow = 4.03 cfs @ 12.21 hrs, Volume= 0.333 af
 Outflow = 2.85 cfs @ 12.21 hrs, Volume= 0.333 af, Atten= 0%, Lag= 0.0 min

Routing by Stor-Ind+Trans method, Time Span= 0.00-80.00 hrs, dt= 0.05 hrs
 Max. Velocity= 4.91 fps, Min. Travel Time= 0.0 min
 Avg. Velocity = 1.90 fps, Avg. Travel Time= 0.1 min

Peak Storage= 8 cf @ 12.21 hrs
 Average Depth at Peak Storage= 0.60'
 Bank-Full Depth= 1.25' Flow Area= 1.2 sf, Capacity= 6.14 cfs

15.0" Round Pipe
 n= 0.012
 Length= 13.0' Slope= 0.0077 '/'
 Inlet Invert= 93.60', Outlet Invert= 93.50'



Summary for Pond 1Pa: CB-17B Basin

Inflow Area = 2.276 ac, 15.81% Impervious, Inflow Depth = 1.54" for 2-Year event
 Inflow = 4.03 cfs @ 12.09 hrs, Volume= 0.293 af
 Outflow = 2.11 cfs @ 12.26 hrs, Volume= 0.293 af, Atten= 48%, Lag= 9.7 min
 Primary = 2.11 cfs @ 12.26 hrs, Volume= 0.293 af

Routing by Stor-Ind method, Time Span= 0.00-80.00 hrs, dt= 0.05 hrs
 Peak Elev= 97.68' @ 12.26 hrs Surf.Area= 5,624 sf Storage= 2,758 cf

Plug-Flow detention time= 69.0 min calculated for 0.293 af (100% of inflow)
 Center-of-Mass det. time= 69.1 min (903.2 - 834.1)

Volume	Invert	Avail.Storage	Storage Description
#1	97.00'	25,350 cf	Custom Stage Data (Prismatic) Listed below (Recalc)
Elevation (feet)	Surf.Area (sq-ft)	Inc.Store (cubic-feet)	Cum.Store (cubic-feet)
97.00	2,500	0	0
98.00	7,100	4,800	4,800
99.00	10,500	8,800	13,600
100.00	13,000	11,750	25,350

Summary for Pond 2Pa: CB-8A Basin

Inflow Area = 4.214 ac, 5.58% Impervious, Inflow Depth = 1.41" for 2-Year event
 Inflow = 5.63 cfs @ 12.17 hrs, Volume= 0.494 af
 Outflow = 3.06 cfs @ 12.42 hrs, Volume= 0.494 af, Atten= 46%, Lag= 14.9 min
 Primary = 3.06 cfs @ 12.42 hrs, Volume= 0.494 af

Routing by Stor-Ind method, Time Span= 0.00-80.00 hrs, dt= 0.05 hrs
 Peak Elev= 97.66' @ 12.42 hrs Surf.Area= 11,885 sf Storage= 4,928 cf

Plug-Flow detention time= 67.5 min calculated for 0.494 af (100% of inflow)
 Center-of-Mass det. time= 67.4 min (913.7 - 846.3)

Volume	Invert	Avail.Storage	Storage Description
#1	97.00'	47,780 cf	Custom Stage Data (Prismatic) Listed below (Recalc)
Elevation (feet)	Surf.Area (sq-ft)	Inc.Store (cubic-feet)	Cum.Store (cubic-feet)
97.00	3,000	0	0
98.00	16,420	9,710	9,710
99.00	19,000	17,710	27,420
100.00	21,720	20,360	47,780

Device	Routing	Invert	Outlet Devices
#1	Primary	97.33'	2.0" x 2.0" Horiz. Catch Basin X 6.00 columns X 6 rows C= 0.600 in 24.0" x 24.0" Grate (25% open area) Limited to weir flow at low heads
#2	Primary	97.00'	1.020 in/hr Exfiltration over Surface area Conductivity to Groundwater Elevation = 80.00'

Primary OutFlow Max=3.06 cfs @ 12.42 hrs HW=97.66' (Free Discharge)
 1=Catch Basin (Orifice Controls 2.77 cfs @ 2.77 fps)
 2=Exfiltration (Controls 0.29 cfs)

Summary for Pond 2Pb: CB-11A Basin

Inflow Area = 6.371 ac, 4.34% Impervious, Inflow Depth = 1.41" for 2-Year event
 Inflow = 8.99 cfs @ 12.15 hrs, Volume= 0.747 af
 Outflow = 4.07 cfs @ 12.44 hrs, Volume= 0.747 af, Atten= 55%, Lag= 17.2 min
 Primary = 4.07 cfs @ 12.44 hrs, Volume= 0.747 af

Routing by Stor-Ind method, Time Span= 0.00-80.00 hrs, dt= 0.05 hrs
 Peak Elev= 95.42' @ 12.44 hrs Surf.Area= 14,680 sf Storage= 7,206 cf

Plug-Flow detention time= 47.1 min calculated for 0.746 af (100% of inflow)
 Center-of-Mass det. time= 47.2 min (891.7 - 844.5)

Volume	Invert	Avail.Storage	Storage Description
#1	94.50'	78,798 cf	Custom Stage Data (Prismatic) Listed below (Recalc)

Elevation (feet)	Surf.Area (sq-ft)	Inc.Store (cubic-feet)	Cum.Store (cubic-feet)
94.50	1,720	0	0
95.00	7,950	2,418	2,418
96.00	23,855	15,903	18,320
97.00	30,550	27,203	45,523
98.00	36,000	33,275	78,798

Device	Routing	Invert	Outlet Devices
#1	Primary	94.83'	2.0" x 2.0" Horiz. Catch Basin X 6.00 columns X 6 rows C= 0.600 in 24.0" x 24.0" Grate (25% open area) Limited to weir flow at low heads
#2	Primary	94.50'	1.020 in/hr Exfiltration over Surface area Conductivity to Groundwater Elevation = 80.50'

Primary OutFlow Max=4.06 cfs @ 12.44 hrs HW=95.42' (Free Discharge)
 1=Catch Basin (Orifice Controls 3.71 cfs @ 3.71 fps)
 2=Exfiltration (Controls 0.36 cfs)

Summary for Pond 2Pc: CB-13A Basin

Inflow Area = 3.366 ac, 22.13% Impervious, Inflow Depth = 1.62' for 2-Year event
 Inflow = 6.25 cfs @ 12.09 hrs, Volume= 0.453 af
 Outflow = 3.36 cfs @ 12.24 hrs, Volume= 0.453 af, Atten= 46%, Lag= 9.0 min
 Primary = 3.36 cfs @ 12.24 hrs, Volume= 0.453 af

Routing by Stor-Ind method, Time Span= 0.00-80.00 hrs, dt= 0.05 hrs
 Peak Elev= 95.27' @ 12.24 hrs Surf.Area= 6,863 sf Storage= 3,746 cf

Plug-Flow detention time= 52.1 min calculated for 0.453 af (100% of inflow)
 Center-of-Mass det. time= 52.2 min (883.0 - 830.7)

Volume	Invert	Avail.Storage	Storage Description
#1	94.50'	31,216 cf	Custom Stage Data (Prismatic) Listed below (Recalc)

Elevation (feet)	Surf.Area (sq-ft)	Inc.Store (cubic-feet)	Cum.Store (cubic-feet)
94.50	1,580	0	0
95.00	6,285	1,966	1,966
96.00	8,420	7,353	9,319
97.00	10,550	9,485	18,804
98.00	14,275	12,413	31,216

Device	Routing	Invert	Outlet Devices
#1	Primary	94.83'	2.0" x 2.0" Horiz. Catch Basin X 6.00 columns X 6 rows C= 0.600 in 24.0" x 24.0" Grate (25% open area) Limited to weir flow at low heads
#2	Primary	94.50'	1.020 in/hr Exfiltration over Surface area Conductivity to Groundwater Elevation = 80.50'

Summary for Subcatchment 1Sa: PR-DA-1S - CB-17B Catchment

Runoff = 8.35 cfs @ 12.09 hrs, Volume= 0.609 af, Depth= 3.21"

Runoff by SCS TR-20 method, UH=SCS, Weighted-CN, Time Span= 0.00-80.00 hrs, dt= 0.05 hrs
 Type III 24-hr 10-Year Rainfall=5.04"

Area (sf)	CN	Description
74,164	80	>75% Grass cover, Good, HSG D
6,867	98	Paved parking, HSG D
6,237	98	Roofs, HSG D
2,569	98	Water Surface, HSG D
9,314	79	Woods, Fair, HSG D
99,151	83	Weighted Average
83,478	84	19% Pervious Area
15,674	15.81%	Impervious Area

Tc (min)	Length (feet)	Slope (ft/ft)	Velocity (ft/sec)	Capacity (cfs)	Description
0.6	50	0.0280	1.33		Sheet Flow, Sheet Flow Smooth surfaces n= 0.011 P2= 3.00"
2.6	190	0.0150	1.22		Shallow Concentrated Flow, Shallow Conc. 1 Nearly Bare & Untilled Kv= 10.0 fps
0.7	96	0.0490	2.21		Shallow Concentrated Flow, Shallow Conc. 2 Nearly Bare & Untilled Kv= 10.0 fps
2.1					Direct Entry, Minimum TC
6.0	336	Total			

Summary for Subcatchment 1Sb: PR-DA-1S - CB-16B Catchment

Runoff = 9.67 cfs @ 12.09 hrs, Volume= 0.704 af, Depth= 3.11"

Runoff by SCS TR-20 method, UH=SCS, Weighted-CN, Time Span= 0.00-80.00 hrs, dt= 0.05 hrs
 Type III 24-hr 10-Year Rainfall=5.04"

Area (sf)	CN	Description
93,694	80	>75% Grass cover, Good, HSG D
10,157	98	Paved parking, HSG D
2,498	98	Water Surface, HSG D
11,795	79	Woods, Fair, HSG D
118,144	82	Weighted Average
105,489	89.29%	Pervious Area
12,655	10.71%	Impervious Area

Tc (min)	Length (feet)	Slope (ft/ft)	Velocity (ft/sec)	Capacity (cfs)	Description
6.0					Direct Entry, Minimum TC

Primary OutFlow Max=3.36 cfs @ 12.24 hrs HW=95.27' (Free Discharge)
 1=Catch Basin (Orifice Controls 3.19 cfs @ 3.19 fps)
 2=Exfiltration (Controls 0.17 cfs)

Summary for Link 1L: Facemate Interceptor Drain

Inflow Area = 4.988 ac, 13.04% Impervious, Inflow Depth = 1.51' for 2-Year event
 Inflow = 4.87 cfs @ 12.29 hrs, Volume= 0.626 af
 Primary = 4.87 cfs @ 12.29 hrs, Volume= 0.626 af, Atten= 0%, Lag= 0.0 min

Primary outflow = Inflow, Time Span= 0.00-80.00 hrs, dt= 0.05 hrs

Summary for Link 2L: Chicopee River

Inflow Area = 18.001 ac, 21.28% Impervious, Inflow Depth = 1.64' for 2-Year event
 Inflow = 15.36 cfs @ 12.11 hrs, Volume= 2.466 af
 Primary = 15.36 cfs @ 12.11 hrs, Volume= 2.466 af, Atten= 0%, Lag= 0.0 min

Primary outflow = Inflow, Time Span= 0.00-80.00 hrs, dt= 0.05 hrs

Summary for Subcatchment 2Sa: PR-DA-2S - CB-8A Catchment

Runoff = 12.21 cfs @ 12.17 hrs, Volume= 1.061 af, Depth= 3.02"

Runoff by SCS TR-20 method, UH=SCS, Weighted-CN, Time Span= 0.00-80.00 hrs, dt= 0.05 hrs
 Type III 24-hr 10-Year Rainfall=5.04"

Area (sf)	CN	Description
165,088	80	>75% Grass cover, Good, HSG D
5,904	98	Paved parking, HSG D
1,265	98	Roofs, HSG D
3,083	98	Water Surface, HSG D
8,216	79	Woods, Fair, HSG D
183,555	81	Weighted Average
173,304	94.42%	Pervious Area
10,251	5.58%	Impervious Area

Tc (min)	Length (feet)	Slope (ft/ft)	Velocity (ft/sec)	Capacity (cfs)	Description
8.8	50	0.0070	0.09		Sheet Flow, Sheet Flow Grass: Short n= 0.150 P2= 3.00"
3.1	235	0.0070	1.25		Shallow Concentrated Flow, Shallow Conc. 1 Grassed Waterway Kv= 15.0 fps
11.9	285	Total			

Summary for Subcatchment 2Sb: PR-DA-2S - CB-11A Catchment

Runoff = 19.46 cfs @ 12.14 hrs, Volume= 1.604 af, Depth= 3.02"

Runoff by SCS TR-20 method, UH=SCS, Weighted-CN, Time Span= 0.00-80.00 hrs, dt= 0.05 hrs
 Type III 24-hr 10-Year Rainfall=5.04"

Area (sf)	CN	Description
265,478	80	>75% Grass cover, Good, HSG D
10,628	98	Paved parking, HSG D
1,422	98	Water Surface, HSG D
277,528	81	Weighted Average
265,478	95.66%	Pervious Area
12,050	4.34%	Impervious Area

Tc (min)	Length (feet)	Slope (ft/ft)	Velocity (ft/sec)	Capacity (cfs)	Description
8.0	50	0.0090	0.10		Sheet Flow, Sheet Flow Grass: Short n= 0.150 P2= 3.00"
2.0	175	0.0090	1.42		Shallow Concentrated Flow, Shallow Conc. 1 Grassed Waterway Kv= 15.0 fps
10.0	225	Total			

Summary for Subcatchment 2Sc: PR-DA-2S - CB-13A Catchment

Runoff = 12.68 cfs @ 12.09 hrs, Volume= 0.928 af, Depth= 3.31"

Runoff by SCS TR-20 method, UH=SCS, Weighted-CN, Time Span= 0.00-80.00 hrs, dt= 0.05 hrs
 Type III 24-hr 10-Year Rainfall=5.04"

Area (sf)	CN	Description
108,361	80	>75% Grass cover, Good, HSG D
30,845	98	Paved parking, HSG D
1,607	98	Water Surface, HSG D
5,822	79	Woods, Fair, HSG D
146,635	84	Weighted Average
114,183		77.87% Pervious Area
32,452		22.13% Impervious Area

Tc (min)	Length (feet)	Slope (ft/ft)	Velocity (ft/sec)	Capacity (cfs)	Description
5.6	50	0.0220	0.15		Sheet Flow, Sheet Flow Grass: Short n= 0.150 P2= 3.00"
0.3	40	0.0220	2.22		Shallow Concentrated Flow, Shallow Conc. Grassed Waterway Kv= 15.0 fps
0.1					Direct Entry, Minimum TC
6.0	90	Total			

Summary for Subcatchment 3S: PR-DA-3S - Upper Uniroyal Site

Runoff = 13.23 cfs @ 12.09 hrs, Volume= 0.998 af, Depth= 3.91"

Runoff by SCS TR-20 method, UH=SCS, Weighted-CN, Time Span= 0.00-80.00 hrs, dt= 0.05 hrs
 Type III 24-hr 10-Year Rainfall=5.04"

Area (sf)	CN	Description
8,648	89	<50% Grass cover, Poor, HSG D
55,625	80	>75% Grass cover, Good, HSG D
17,187	98	Paved parking, HSG D
51,767	98	Roofs, HSG D
133,228	90	Weighted Average
64,274		48.24% Pervious Area
68,954		51.76% Impervious Area

Tc (min)	Length (feet)	Slope (ft/ft)	Velocity (ft/sec)	Capacity (cfs)	Description
6.0					Direct Entry, Minimum TC

Summary for Subcatchment B26: Building 26

Runoff = 1.18 cfs @ 12.09 hrs, Volume= 0.098 af, Depth= 4.80"

Runoff by SCS TR-20 method, UH=SCS, Weighted-CN, Time Span= 0.00-80.00 hrs, dt= 0.05 hrs
 Type III 24-hr 10-Year Rainfall=5.04"

Area (sf)	CN	Description
10,635	98	Roofs, HSG D
10,635		100.00% Impervious Area

Tc (min)	Length (feet)	Slope (ft/ft)	Velocity (ft/sec)	Capacity (cfs)	Description
6.0					Direct Entry, Minimum TC

Summary for Subcatchment B27: Building 27

Runoff = 3.60 cfs @ 12.09 hrs, Volume= 0.299 af, Depth= 4.80"

Runoff by SCS TR-20 method, UH=SCS, Weighted-CN, Time Span= 0.00-80.00 hrs, dt= 0.05 hrs
 Type III 24-hr 10-Year Rainfall=5.04"

Area (sf)	CN	Description
32,552	98	Roofs, HSG D
32,552		100.00% Impervious Area

Tc (min)	Length (feet)	Slope (ft/ft)	Velocity (ft/sec)	Capacity (cfs)	Description
6.0					Direct Entry, Minimum TC

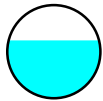
Summary for Reach 1R: Discharge Pipe

Inflow Area = 4.988 ac, 13.04% Impervious, Inflow Depth = 3.16" for 10-Year event
 Inflow = 7.76 cfs @ 12.34 hrs, Volume= 1.313 af
 Outflow = 7.75 cfs @ 12.35 hrs, Volume= 1.313 af, Atten= 0%, Lag= 0.5 min

Routing by Stor-Ind+Trans method, Time Span= 0.00-80.00 hrs, dt= 0.05 hrs
 Max. Velocity= 3.78 fps, Min. Travel Time= 0.2 min
 Avg. Velocity = 1.48 fps, Avg. Travel Time= 0.6 min

Peak Storage= 103 cf @ 12.35 hrs
 Average Depth at Peak Storage= 1.24'
 Bank-Full Depth= 2.00' Flow Area= 3.1 sf, Capacity= 10.96 cfs

24.0" Round Pipe
 n= 0.012
 Length= 50.0' Slope= 0.0020 /'
 Inlet Invert= 85.35', Outlet Invert= 85.25'



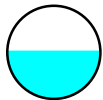
Summary for Reach 1Ra: Perforated Pipe

Inflow Area = 2.276 ac, 15.81% Impervious, Inflow Depth = 3.21" for 10-Year event
 Inflow = 3.28 cfs @ 12.34 hrs, Volume= 0.609 af
 Outflow = 3.28 cfs @ 12.39 hrs, Volume= 0.609 af, Atten= 0%, Lag= 2.9 min

Routing by Stor-Ind+Trans method, Time Span= 0.00-80.00 hrs, dt= 0.05 hrs
 Max. Velocity= 3.57 fps, Min. Travel Time= 1.6 min
 Avg. Velocity = 1.43 fps, Avg. Travel Time= 4.1 min

Peak Storage= 322 cf @ 12.36 hrs
 Average Depth at Peak Storage= 0.77'
 Bank-Full Depth= 1.50' Flow Area= 1.8 sf, Capacity= 6.23 cfs

18.0" Round Pipe
 n= 0.012
 Length= 350.0' Slope= 0.0030 /'
 Inlet Invert= 87.20', Outlet Invert= 86.15'



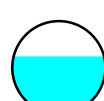
Summary for Reach 1Rb: Perforated Pipe

Inflow Area = 4.988 ac, 13.04% Impervious, Inflow Depth = 3.16" for 10-Year event
 Inflow = 7.77 cfs @ 12.32 hrs, Volume= 1.313 af
 Outflow = 7.76 cfs @ 12.34 hrs, Volume= 1.313 af, Atten= 0%, Lag= 1.4 min

Routing by Stor-Ind+Trans method, Time Span= 0.00-80.00 hrs, dt= 0.05 hrs
 Max. Velocity= 3.78 fps, Min. Travel Time= 0.7 min
 Avg. Velocity = 1.48 fps, Avg. Travel Time= 1.7 min

Peak Storage= 308 cf @ 12.33 hrs
 Average Depth at Peak Storage= 1.24'
 Bank-Full Depth= 2.00' Flow Area= 3.1 sf, Capacity= 10.96 cfs

24.0" Round Pipe
 n= 0.012
 Length= 150.0' Slope= 0.0020 /'
 Inlet Invert= 85.65', Outlet Invert= 85.35'



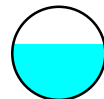
Summary for Reach 2R: Discharge Pipe

Inflow Area = 14.943 ac, 15.05% Impervious, Inflow Depth = 3.20" for 10-Year event
 Inflow = 16.83 cfs @ 12.40 hrs, Volume= 3.989 af
 Outflow = 16.82 cfs @ 12.41 hrs, Volume= 3.989 af, Atten= 0%, Lag= 0.8 min

Routing by Stor-Ind+Trans method, Time Span= 0.00-80.00 hrs, dt= 0.05 hrs / 2
 Max. Velocity= 5.50 fps, Min. Travel Time= 0.4 min
 Avg. Velocity = 2.06 fps, Avg. Travel Time= 1.1 min

Peak Storage= 428 cf @ 12.40 hrs
 Average Depth at Peak Storage= 1.49'
 Bank-Full Depth= 2.50' Flow Area= 4.9 sf, Capacity= 25.19 cfs

30.0" Round Pipe
 n= 0.012
 Length= 140.0' Slope= 0.0032 /'
 Inlet Invert= 87.15', Outlet Invert= 86.70'



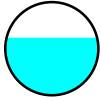
Summary for Reach 2Ra: Perforated Pipe A

Inflow Area = 4.214 ac, 5.58% Impervious, Inflow Depth = 3.02" for 10-Year event
 Inflow = 4.77 cfs @ 12.51 hrs, Volume= 1.061 af
 Outflow = 4.76 cfs @ 12.58 hrs, Volume= 1.061 af, Atten= 0%, Lag= 4.0 min

Routing by Stor-Ind+Trans method, Time Span= 0.00-80.00 hrs, dt= 0.05 hrs / 3
 Max. Velocity= 4.18 fps, Min. Travel Time= 2.2 min
 Avg. Velocity = 1.77 fps, Avg. Travel Time= 5.2 min

Peak Storage= 633 cf @ 12.54 hrs
 Average Depth at Peak Storage= 0.92'
 Bank-Full Depth= 1.50' Flow Area= 1.8 sf, Capacity= 6.83 cfs

18.0" Round Pipe
 n= 0.012
 Length= 555.0' Slope= 0.0036 '/
 Inlet Invert= 92.00', Outlet Invert= 90.00'



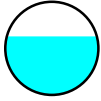
Summary for Reach 2Rb: Perforated Pipe B

Inflow Area = 10.585 ac, 4.84% Impervious, Inflow Depth = 3.02" for 10-Year event
 Inflow = 10.68 cfs @ 12.56 hrs, Volume= 2.665 af
 Outflow = 10.67 cfs @ 12.60 hrs, Volume= 2.665 af, Atten= 0%, Lag= 2.4 min

Routing by Stor-Ind+Trans method, Time Span= 0.00-80.00 hrs, dt= 0.05 hrs / 3
 Max. Velocity= 5.14 fps, Min. Travel Time= 1.3 min
 Avg. Velocity= 2.22 fps, Avg. Travel Time= 3.0 min

Peak Storage= 820 cf @ 12.57 hrs
 Average Depth at Peak Storage= 1.26'
 Bank-Full Depth= 2.00' Flow Area= 3.1 sf, Capacity= 14.85 cfs

24.0" Round Pipe
 n= 0.012
 Length= 395.0' Slope= 0.0037 '/
 Inlet Invert= 89.50', Outlet Invert= 88.05'



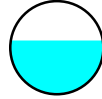
Summary for Reach 2Rc: Perforated Pipe C

Inflow Area = 13.951 ac, 9.01% Impervious, Inflow Depth = 3.09" for 10-Year event
 Inflow = 15.59 cfs @ 12.49 hrs, Volume= 3.592 af
 Outflow = 15.58 cfs @ 12.50 hrs, Volume= 3.592 af, Atten= 0%, Lag= 0.8 min

Routing by Stor-Ind+Trans method, Time Span= 0.00-80.00 hrs, dt= 0.05 hrs / 3
 Max. Velocity= 5.31 fps, Min. Travel Time= 0.4 min
 Avg. Velocity= 2.17 fps, Avg. Travel Time= 1.0 min

Peak Storage= 381 cf @ 12.49 hrs
 Average Depth at Peak Storage= 1.44'
 Bank-Full Depth= 2.50' Flow Area= 4.9 sf, Capacity= 24.65 cfs

30.0" Round Pipe
 n= 0.012
 Length= 130.0' Slope= 0.0031 '/
 Inlet Invert= 87.55', Outlet Invert= 87.15'



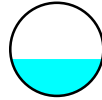
Summary for Reach 3R: Uniroyal South Outfall (Exist.)

Inflow Area = 18.001 ac, 21.28% Impervious, Inflow Depth = 3.32" for 10-Year event
 Inflow = 28.43 cfs @ 12.10 hrs, Volume= 4.987 af
 Outflow = 28.13 cfs @ 12.11 hrs, Volume= 4.987 af, Atten= 1%, Lag= 0.2 min

Routing by Stor-Ind+Trans method, Time Span= 0.00-80.00 hrs, dt= 0.05 hrs / 2
 Max. Velocity= 15.65 fps, Min. Travel Time= 0.2 min
 Avg. Velocity= 5.32 fps, Avg. Travel Time= 0.5 min

Peak Storage= 316 cf @ 12.10 hrs
 Average Depth at Peak Storage= 0.99'
 Bank-Full Depth= 2.50' Flow Area= 4.9 sf, Capacity= 85.65 cfs

30.0" Round Pipe
 n= 0.013
 Length= 175.0' Slope= 0.0436 '/
 Inlet Invert= 85.85', Outlet Invert= 78.22'



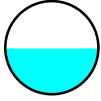
Summary for Reach 4Ra: 15" HDPE

Inflow Area = 4.214 ac, 5.58% Impervious, Inflow Depth = 3.02" for 10-Year event
 Inflow = 4.77 cfs @ 12.51 hrs, Volume= 1.061 af
 Outflow = 4.77 cfs @ 12.51 hrs, Volume= 1.061 af, Atten= 0%, Lag= 0.0 min

Routing by Stor-Ind+Trans method, Time Span= 0.00-80.00 hrs, dt= 0.05 hrs
 Max. Velocity= 7.99 fps, Min. Travel Time= 0.0 min
 Avg. Velocity= 3.47 fps, Avg. Travel Time= 0.0 min

Peak Storage= 3 cf @ 12.51 hrs
 Average Depth at Peak Storage= 0.61'
 Bank-Full Depth= 1.25' Flow Area= 1.2 sf, Capacity= 9.90 cfs

15.0" Round Pipe
 n= 0.012
 Length= 5.0' Slope= 0.0200 '/
 Inlet Invert= 93.50', Outlet Invert= 93.40'



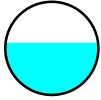
Summary for Reach 4Rb: 15" HDPE

Inflow Area = 6.371 ac, 4.34% Impervious, Inflow Depth = 3.02" for 10-Year event
 Inflow = 5.92 cfs @ 12.53 hrs, Volume= 1.604 af
 Outflow = 5.92 cfs @ 12.53 hrs, Volume= 1.604 af, Atten= 0%, Lag= 0.0 min

Routing by Stor-Ind+Trans method, Time Span= 0.00-80.00 hrs, dt= 0.05 hrs
 Max. Velocity= 8.42 fps, Min. Travel Time= 0.0 min
 Avg. Velocity= 3.80 fps, Avg. Travel Time= 0.0 min

Peak Storage= 7 cf @ 12.53 hrs
 Average Depth at Peak Storage= 0.70'
 Bank-Full Depth= 1.25' Flow Area= 1.2 sf, Capacity= 9.90 cfs

15.0" Round Pipe
 n= 0.012
 Length= 10.0' Slope= 0.0200 '/
 Inlet Invert= 91.00', Outlet Invert= 90.80'



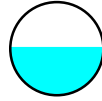
Summary for Reach 4Rc: 15" HDPE

Inflow Area = 3.366 ac, 22.13% Impervious, Inflow Depth = 3.31" for 10-Year event
 Inflow = 5.21 cfs @ 12.32 hrs, Volume= 0.928 af
 Outflow = 5.21 cfs @ 12.32 hrs, Volume= 0.928 af, Atten= 0%, Lag= 0.1 min

Routing by Stor-Ind+Trans method, Time Span= 0.00-80.00 hrs, dt= 0.05 hrs
 Max. Velocity= 8.17 fps, Min. Travel Time= 0.0 min
 Avg. Velocity= 3.22 fps, Avg. Travel Time= 0.1 min

Peak Storage= 6 cf @ 12.32 hrs
 Average Depth at Peak Storage= 0.64'
 Bank-Full Depth= 1.25' Flow Area= 1.2 sf, Capacity= 9.90 cfs

15.0" Round Pipe
 n= 0.012
 Length= 10.0' Slope= 0.0200 '/
 Inlet Invert= 91.00', Outlet Invert= 90.80'



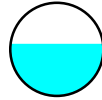
Summary for Reach 5Ra: 12" HDPE

Inflow Area = 2.276 ac, 15.81% Impervious, Inflow Depth = 3.21" for 10-Year event
 Inflow = 3.28 cfs @ 12.34 hrs, Volume= 0.609 af
 Outflow = 3.28 cfs @ 12.34 hrs, Volume= 0.609 af, Atten= 0%, Lag= 0.0 min

Routing by Stor-Ind+Trans method, Time Span= 0.00-80.00 hrs, dt= 0.05 hrs
 Max. Velocity= 7.27 fps, Min. Travel Time= 0.0 min
 Avg. Velocity= 3.00 fps, Avg. Travel Time= 0.0 min

Peak Storage= 2 cf @ 12.34 hrs
 Average Depth at Peak Storage= 0.56'
 Bank-Full Depth= 1.00' Flow Area= 0.8 sf, Capacity= 5.46 cfs

12.0" Round Pipe
 n= 0.012
 Length= 5.0' Slope= 0.0200 '/
 Inlet Invert= 93.60', Outlet Invert= 93.50'



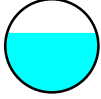
Summary for Reach 5Rb: 15" HDPE

Inflow Area = 2.712 ac, 10.71% Impervious, Inflow Depth = 3.11" for 10-Year event
 Inflow = 4.52 cfs @ 12.28 hrs, Volume= 0.704 af
 Outflow = 4.52 cfs @ 12.28 hrs, Volume= 0.704 af, Atten= 0%, Lag= 0.2 min

Routing by Stor-Ind+Trans method, Time Span= 0.00-80.00 hrs, dt= 0.05 hrs
 Max. Velocity= 5.47 fps, Min. Travel Time= 0.0 min
 Avg. Velocity = 2.15 fps, Avg. Travel Time= 0.1 min

Peak Storage= 11 cf @ 12.28 hrs
 Average Depth at Peak Storage= 0.80'
 Bank-Full Depth= 1.25' Flow Area= 1.2 sf, Capacity= 6.14 cfs

15.0" Round Pipe
 n= 0.012
 Length= 13.0' Slope= 0.00777 '
 Inlet Invert= 93.60', Outlet Invert= 93.50'



Summary for Pond 1Pa: CB-17B Basin

Inflow Area = 2.276 ac, 15.81% Impervious, Inflow Depth = 3.21" for 10-Year event
 Inflow = 8.35 cfs @ 12.09 hrs, Volume= 0.609 af
 Outflow = 3.28 cfs @ 12.34 hrs, Volume= 0.609 af, Atten= 61%, Lag= 14.9 min
 Primary = 3.28 cfs @ 12.34 hrs, Volume= 0.609 af

Routing by Stor-Ind method, Time Span= 0.00-80.00 hrs, dt= 0.05 hrs
 Peak Elev= 98.19' @ 12.34 hrs Surf.Area= 7,729 sf Storage= 6,172 cf

Plug-Flow detention time= 51.1 min calculated for 0.609 af (100% of inflow)
 Center-of-Mass det. time= 51.2 min (864.3 - 813.1)

Volume	Invert	Avail.Storage	Storage Description
#1	97.00'	25,350 cf	Custom Stage Data (Prismatic) Listed below (Recalc)
Elevation (feet)	Surf.Area (sq-ft)	Inc.Store (cubic-feet)	Cum.Store (cubic-feet)
97.00	2,500	0	0
98.00	7,100	4,800	4,800
99.00	10,500	8,800	13,600
100.00	13,000	11,750	25,350

Summary for Pond 2Pa: CB-8A Basin

Inflow Area = 4.214 ac, 5.58% Impervious, Inflow Depth = 3.02" for 10-Year event
 Inflow = 12.21 cfs @ 12.17 hrs, Volume= 1.061 af
 Outflow = 4.77 cfs @ 12.51 hrs, Volume= 1.061 af, Atten= 61%, Lag= 20.5 min
 Primary = 4.77 cfs @ 12.51 hrs, Volume= 1.061 af

Routing by Stor-Ind method, Time Span= 0.00-80.00 hrs, dt= 0.05 hrs
 Peak Elev= 98.15' @ 12.51 hrs Surf.Area= 16,802 sf Storage= 12,172 cf

Plug-Flow detention time= 54.0 min calculated for 1.061 af (100% of inflow)
 Center-of-Mass det. time= 53.9 min (878.1 - 824.2)

Volume	Invert	Avail.Storage	Storage Description
#1	97.00'	47,780 cf	Custom Stage Data (Prismatic) Listed below (Recalc)
Elevation (feet)	Surf.Area (sq-ft)	Inc.Store (cubic-feet)	Cum.Store (cubic-feet)
97.00	3,000	0	0
98.00	16,420	9,710	9,710
99.00	19,000	17,710	27,420
100.00	21,720	20,360	47,780

Device	Routing	Invert	Outlet Devices
#1	Primary	97.33'	2.0" x 2.0" Horiz. Catch Basin X 6.00 columns X 6 rows C= 0.600 in 24.0" x 24.0" Grate (25% open area) Limited to weir flow at low heads
#2	Primary	97.00'	1.020 in/hr Exfiltration over Surface area Conductivity to Groundwater Elevation = 80.00'

Primary OutFlow Max=4.77 cfs @ 12.51 hrs HW=98.15' (Free Discharge)
 1=Catch Basin (Orifice Controls 4.35 cfs @ 4.35 fps)
 2=Exfiltration (Controls 0.41 cfs)

Summary for Pond 2Pb: CB-11A Basin

Inflow Area = 6.371 ac, 4.34% Impervious, Inflow Depth = 3.02" for 10-Year event
 Inflow = 19.46 cfs @ 12.14 hrs, Volume= 1.604 af
 Outflow = 5.92 cfs @ 12.53 hrs, Volume= 1.604 af, Atten= 70%, Lag= 23.4 min
 Primary = 5.92 cfs @ 12.53 hrs, Volume= 1.604 af

Routing by Stor-Ind method, Time Span= 0.00-80.00 hrs, dt= 0.05 hrs
 Peak Elev= 96.05' @ 12.53 hrs Surf.Area= 24,189 sf Storage= 19,517 cf

Plug-Flow detention time= 43.5 min calculated for 1.604 af (100% of inflow)
 Center-of-Mass det. time= 43.3 min (865.8 - 822.4)

Volume	Invert	Avail.Storage	Storage Description
#1	94.50'	78,798 cf	Custom Stage Data (Prismatic) Listed below (Recalc)

Device	Routing	Invert	Outlet Devices
#1	Primary	97.33'	2.0" x 2.0" Horiz. Catch Basin X 5.00 columns X 5 rows C= 0.600 in 24.0" x 24.0" Grate (17% open area) Limited to weir flow at low heads
#2	Primary	97.00'	1.020 in/hr Exfiltration over Surface area Conductivity to Groundwater Elevation = 82.50'

Primary OutFlow Max=3.28 cfs @ 12.34 hrs HW=98.18' (Free Discharge)
 1=Catch Basin (Orifice Controls 3.09 cfs @ 4.45 fps)
 2=Exfiltration (Controls 0.19 cfs)

Summary for Pond 1Pb: CB-16B Basin

Inflow Area = 2.712 ac, 10.71% Impervious, Inflow Depth = 3.11" for 10-Year event
 Inflow = 9.67 cfs @ 12.09 hrs, Volume= 0.704 af
 Outflow = 4.52 cfs @ 12.28 hrs, Volume= 0.704 af, Atten= 53%, Lag= 11.1 min
 Primary = 4.52 cfs @ 12.28 hrs, Volume= 0.704 af

Routing by Stor-Ind method, Time Span= 0.00-80.00 hrs, dt= 0.05 hrs
 Peak Elev= 98.14' @ 12.28 hrs Surf.Area= 7,713 sf Storage= 6,050 cf

Plug-Flow detention time= 47.2 min calculated for 0.704 af (100% of inflow)
 Center-of-Mass det. time= 47.0 min (863.0 - 816.0)

Volume	Invert	Avail.Storage	Storage Description
#1	97.00'	27,653 cf	Custom Stage Data (Prismatic) Listed below (Recalc)
Elevation (feet)	Surf.Area (sq-ft)	Inc.Store (cubic-feet)	Cum.Store (cubic-feet)
97.00	2,945	0	0
98.00	7,130	5,038	5,038
99.00	11,400	9,265	14,303
100.00	15,300	13,350	27,653

Device	Routing	Invert	Outlet Devices
#1	Primary	97.33'	2.0" x 2.0" Horiz. Catch Basin X 6.00 columns X 6 rows C= 0.600 in 24.0" x 24.0" Grate (25% open area) Limited to weir flow at low heads
#2	Primary	97.00'	1.020 in/hr Exfiltration over Surface area Conductivity to Groundwater Elevation = 82.50'

Primary OutFlow Max=4.51 cfs @ 12.28 hrs HW=98.13' (Free Discharge)
 1=Catch Basin (Orifice Controls 4.32 cfs @ 4.32 fps)
 2=Exfiltration (Controls 0.19 cfs)

Elevation (feet)	Surf.Area (sq-ft)	Inc.Store (cubic-feet)	Cum.Store (cubic-feet)
94.50	1,720	0	0
95.00	7,950	2,418	2,418
96.00	23,855	15,903	18,320
97.00	30,550	27,203	45,523
98.00	36,000	33,275	78,798

Device	Routing	Invert	Outlet Devices
#1	Primary	94.83'	2.0" x 2.0" Horiz. Catch Basin X 6.00 columns X 6 rows C= 0.600 in 24.0" x 24.0" Grate (25% open area) Limited to weir flow at low heads
#2	Primary	94.50'	1.020 in/hr Exfiltration over Surface area Conductivity to Groundwater Elevation = 80.50'

Primary OutFlow Max=5.92 cfs @ 12.53 hrs HW=96.05' (Free Discharge)
 1=Catch Basin (Orifice Controls 5.32 cfs @ 5.32 fps)
 2=Exfiltration (Controls 0.60 cfs)

Summary for Pond 2Pc: CB-13A Basin

Inflow Area = 3.366 ac, 22.13% Impervious, Inflow Depth = 3.31" for 10-Year event
 Inflow = 12.68 cfs @ 12.09 hrs, Volume= 0.928 af
 Outflow = 5.21 cfs @ 12.32 hrs, Volume= 0.928 af, Atten= 59%, Lag= 13.8 min
 Primary = 5.21 cfs @ 12.32 hrs, Volume= 0.928 af

Routing by Stor-Ind method, Time Span= 0.00-80.00 hrs, dt= 0.05 hrs
 Peak Elev= 95.91' @ 12.32 hrs Surf.Area= 8,228 sf Storage= 8,572 cf

Plug-Flow detention time= 38.4 min calculated for 0.927 af (100% of inflow)
 Center-of-Mass det. time= 38.5 min (848.7 - 810.2)

Volume	Invert	Avail.Storage	Storage Description
#1	94.50'	31,216 cf	Custom Stage Data (Prismatic) Listed below (Recalc)
Elevation (feet)	Surf.Area (sq-ft)	Inc.Store (cubic-feet)	Cum.Store (cubic-feet)
94.50	1,580	0	0
95.00	6,285	1,966	1,966
96.00	8,420	7,353	9,319
97.00	10,550	9,485	18,804
98.00	14,275	12,413	31,216

Device	Routing	Invert	Outlet Devices
#1	Primary	94.83'	2.0" x 2.0" Horiz. Catch Basin X 6.00 columns X 6 rows C= 0.600 in 24.0" x 24.0" Grate (25% open area) Limited to weir flow at low heads
#2	Primary	94.50'	1.020 in/hr Exfiltration over Surface area Conductivity to Groundwater Elevation = 80.50'

Primary OutFlow Max=5.21 cfs @ 12.32 hrs HW=95.91' (Free Discharge)
 1=Catch Basin (Orifice Controls 5.00 cfs @ 5.00 fps)
 2=Exfiltration (Controls 0.21 cfs)

Summary for Link 1L: Facemate Interceptor Drain

Inflow Area = 4.988 ac, 13.04% Impervious, Inflow Depth = 3.16" for 10-Year event
 Inflow = 7.75 cfs @ 12.35 hrs, Volume= 1.313 af
 Primary = 7.75 cfs @ 12.35 hrs, Volume= 1.313 af, Atten= 0%, Lag= 0.0 min

Primary outflow = Inflow, Time Span= 0.00-80.00 hrs, dt= 0.05 hrs

Summary for Link 2L: Chicopee River

Inflow Area = 18.001 ac, 21.28% Impervious, Inflow Depth = 3.32" for 10-Year event
 Inflow = 28.13 cfs @ 12.11 hrs, Volume= 4.987 af
 Primary = 28.13 cfs @ 12.11 hrs, Volume= 4.987 af, Atten= 0%, Lag= 0.0 min

Primary outflow = Inflow, Time Span= 0.00-80.00 hrs, dt= 0.05 hrs

Summary for Subcatchment 1Sa: PR-DA-1S - CB-17B Catchment

Runoff = 11.09 cfs @ 12.09 hrs, Volume= 0.817 af, Depth= 4.31"

Runoff by SCS TR-20 method, UH=SCS, Weighted-CN, Time Span= 0.00-80.00 hrs, dt= 0.05 hrs
 Type III 24-hr 25-Year Rainfall=6.23"

Area (sf)	CN	Description			
74,164	80	>75% Grass cover, Good, HSG D			
6,867	98	Paved parking, HSG D			
6,237	98	Roofs, HSG D			
2,569	98	Water Surface, HSG D			
9,314	79	Woods, Fair, HSG D			
99,151	83	Weighted Average			
83,478		84.19% Pervious Area			
15,674		15.81% Impervious Area			
Tc (min)	Length (feet)	Slope (ft/ft)	Velocity (ft/sec)	Capacity (cfs)	Description
0.6	50	0.0280	1.33		Sheet Flow, Sheet Flow Smooth surfaces n= 0.011 P2= 3.00"
2.6	190	0.0150	1.22		Shallow Concentrated Flow, Shallow Conc. 1 Nearly Bare & Untilled Kv= 10.0 fps
0.7	96	0.0490	2.21		Shallow Concentrated Flow, Shallow Conc. 2 Nearly Bare & Untilled Kv= 10.0 fps
2.1					Direct Entry, Minimum TC
6.0	336	Total			

Summary for Subcatchment 1Sb: PR-DA-1S - CB-16B Catchment

Runoff = 12.93 cfs @ 12.09 hrs, Volume= 0.949 af, Depth= 4.20"

Runoff by SCS TR-20 method, UH=SCS, Weighted-CN, Time Span= 0.00-80.00 hrs, dt= 0.05 hrs
 Type III 24-hr 25-Year Rainfall=6.23"

Area (sf)	CN	Description			
93,694	80	>75% Grass cover, Good, HSG D			
10,157	98	Paved parking, HSG D			
2,498	98	Water Surface, HSG D			
11,795	79	Woods, Fair, HSG D			
118,144	82	Weighted Average			
105,489		89.29% Pervious Area			
12,655		10.71% Impervious Area			
Tc (min)	Length (feet)	Slope (ft/ft)	Velocity (ft/sec)	Capacity (cfs)	Description
6.0					Direct Entry, Minimum TC

Summary for Subcatchment 2Sa: PR-DA-2S - CB-8A Catchment

Runoff = 16.47 cfs @ 12.16 hrs, Volume= 1.438 af, Depth= 4.09"

Runoff by SCS TR-20 method, UH=SCS, Weighted-CN, Time Span= 0.00-80.00 hrs, dt= 0.05 hrs
 Type III 24-hr 25-Year Rainfall=6.23"

Area (sf)	CN	Description			
165,088	80	>75% Grass cover, Good, HSG D			
5,904	98	Paved parking, HSG D			
1,265	98	Roofs, HSG D			
3,083	98	Water Surface, HSG D			
8,216	79	Woods, Fair, HSG D			
183,555	81	Weighted Average			
173,304		94.42% Pervious Area			
10,251		5.58% Impervious Area			
Tc (min)	Length (feet)	Slope (ft/ft)	Velocity (ft/sec)	Capacity (cfs)	Description
8.8	50	0.0070	0.09		Sheet Flow, Sheet Flow Grass: Short n= 0.150 P2= 3.00"
3.1	235	0.0070	1.25		Shallow Concentrated Flow, Shallow Conc. 1 Grassed Waterway Kv= 15.0 fps
11.9	285	Total			

Summary for Subcatchment 2Sb: PR-DA-2S - CB-11A Catchment

Runoff = 26.22 cfs @ 12.14 hrs, Volume= 2.174 af, Depth= 4.09"

Runoff by SCS TR-20 method, UH=SCS, Weighted-CN, Time Span= 0.00-80.00 hrs, dt= 0.05 hrs
 Type III 24-hr 25-Year Rainfall=6.23"

Area (sf)	CN	Description			
265,478	80	>75% Grass cover, Good, HSG D			
10,628	98	Paved parking, HSG D			
1,422	98	Water Surface, HSG D			
277,528	81	Weighted Average			
265,478		95.66% Pervious Area			
12,050		4.34% Impervious Area			
Tc (min)	Length (feet)	Slope (ft/ft)	Velocity (ft/sec)	Capacity (cfs)	Description
8.0	50	0.0090	0.10		Sheet Flow, Sheet Flow Grass: Short n= 0.150 P2= 3.00"
2.0	175	0.0090	1.42		Shallow Concentrated Flow, Shallow Conc. 1 Grassed Waterway Kv= 15.0 fps
10.0	225	Total			

Summary for Subcatchment 2Sc: PR-DA-2S - CB-13A Catchment

Runoff = 16.74 cfs @ 12.09 hrs, Volume= 1.238 af, Depth= 4.41"

Runoff by SCS TR-20 method, UH=SCS, Weighted-CN, Time Span= 0.00-80.00 hrs, dt= 0.05 hrs
 Type III 24-hr 25-Year Rainfall=6.23"

Area (sf)	CN	Description			
108,361	80	>75% Grass cover, Good, HSG D			
30,845	98	Paved parking, HSG D			
1,607	98	Water Surface, HSG D			
5,822	79	Woods, Fair, HSG D			
146,635	84	Weighted Average			
114,183		77.87% Pervious Area			
32,452		22.13% Impervious Area			
Tc (min)	Length (feet)	Slope (ft/ft)	Velocity (ft/sec)	Capacity (cfs)	Description
5.6	50	0.0220	0.15		Sheet Flow, Sheet Flow Grass: Short n= 0.150 P2= 3.00"
0.3	40	0.0220	2.22		Shallow Concentrated Flow, Shallow Conc. Grassed Waterway Kv= 15.0 fps
0.1					Direct Entry, Minimum TC
6.0	90	Total			

Summary for Subcatchment 3S: PR-DA-3S - Upper Uniroyal Site

Runoff = 16.89 cfs @ 12.09 hrs, Volume= 1.292 af, Depth= 5.07"

Runoff by SCS TR-20 method, UH=SCS, Weighted-CN, Time Span= 0.00-80.00 hrs, dt= 0.05 hrs
 Type III 24-hr 25-Year Rainfall=6.23"

Area (sf)	CN	Description			
8,648	89	<50% Grass cover, Poor, HSG D			
55,625	80	>75% Grass cover, Good, HSG D			
17,187	98	Paved parking, HSG D			
51,767	98	Roofs, HSG D			
133,228	90	Weighted Average			
64,274		48.24% Pervious Area			
68,954		51.76% Impervious Area			
Tc (min)	Length (feet)	Slope (ft/ft)	Velocity (ft/sec)	Capacity (cfs)	Description
6.0					Direct Entry, Minimum TC

Summary for Subcatchment B26: Building 26

Runoff = 1.46 cfs @ 12.09 hrs, Volume= 0.122 af, Depth= 5.99"

Runoff by SCS TR-20 method, UH=SCS, Weighted-CN, Time Span= 0.00-80.00 hrs, dt= 0.05 hrs
 Type III 24-hr 25-Year Rainfall=6.23"

Area (sf)	CN	Description
10,635	98	Roofs, HSG D
10,635		100.00% Impervious Area

Tc (min)	Length (feet)	Slope (ft/ft)	Velocity (ft/sec)	Capacity (cfs)	Description
6.0					Direct Entry, Minimum TC

Summary for Subcatchment B27: Building 27

Runoff = 4.46 cfs @ 12.09 hrs, Volume= 0.373 af, Depth= 5.99"

Runoff by SCS TR-20 method, UH=SCS, Weighted-CN, Time Span= 0.00-80.00 hrs, dt= 0.05 hrs
 Type III 24-hr 25-Year Rainfall=6.23"

Area (sf)	CN	Description
32,552	98	Roofs, HSG D
32,552		100.00% Impervious Area

Tc (min)	Length (feet)	Slope (ft/ft)	Velocity (ft/sec)	Capacity (cfs)	Description
6.0					Direct Entry, Minimum TC

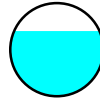
Summary for Reach 1R: Discharge Pipe

Inflow Area = 4.988 ac, 13.04% Impervious, Inflow Depth = 4.25" for 25-Year event
 Inflow = 9.13 cfs @ 12.38 hrs, Volume= 1.766 af
 Outflow = 9.13 cfs @ 12.39 hrs, Volume= 1.766 af, Atten= 0%, Lag= 0.4 min

Routing by Stor-Ind+Trans method, Time Span= 0.00-80.00 hrs, dt= 0.05 hrs
 Max. Velocity= 3.90 fps, Min. Travel Time= 0.2 min
 Avg. Velocity = 1.58 fps, Avg. Travel Time= 0.5 min

Peak Storage= 117 cf @ 12.38 hrs
 Average Depth at Peak Storage= 1.39'
 Bank-Full Depth= 2.00' Flow Area= 3.1 sf, Capacity= 10.96 cfs

24.0" Round Pipe
 n= 0.012
 Length= 50.0' Slope= 0.0020 '/'
 Inlet Invert= 85.35', Outlet Invert= 85.25'



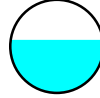
Summary for Reach 1Ra: Perforated Pipe

Inflow Area = 2.276 ac, 15.81% Impervious, Inflow Depth = 4.31" for 25-Year event
 Inflow = 3.84 cfs @ 12.38 hrs, Volume= 0.817 af
 Outflow = 3.84 cfs @ 12.43 hrs, Volume= 0.817 af, Atten= 0%, Lag= 2.8 min

Routing by Stor-Ind+Trans method, Time Span= 0.00-80.00 hrs, dt= 0.05 hrs
 Max. Velocity= 3.71 fps, Min. Travel Time= 1.6 min
 Avg. Velocity = 1.52 fps, Avg. Travel Time= 3.8 min

Peak Storage= 362 cf @ 12.40 hrs
 Average Depth at Peak Storage= 0.85'
 Bank-Full Depth= 1.50' Flow Area= 1.8 sf, Capacity= 6.23 cfs

18.0" Round Pipe
 n= 0.012
 Length= 350.0' Slope= 0.0030 '/'
 Inlet Invert= 87.20', Outlet Invert= 86.15'



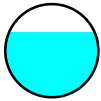
Summary for Reach 1Rb: Perforated Pipe

Inflow Area = 4.988 ac, 13.04% Impervious, Inflow Depth = 4.25" for 25-Year event
 Inflow = 9.13 cfs @ 12.36 hrs, Volume= 1.766 af
 Outflow = 9.13 cfs @ 12.38 hrs, Volume= 1.766 af, Atten= 0%, Lag= 1.1 min

Routing by Stor-Ind+Trans method, Time Span= 0.00-80.00 hrs, dt= 0.05 hrs
 Max. Velocity= 3.90 fps, Min. Travel Time= 0.6 min
 Avg. Velocity = 1.58 fps, Avg. Travel Time= 1.6 min

Peak Storage= 351 cf @ 12.37 hrs
 Average Depth at Peak Storage= 1.40'
 Bank-Full Depth= 2.00' Flow Area= 3.1 sf, Capacity= 10.96 cfs

24.0" Round Pipe
 n= 0.012
 Length= 150.0' Slope= 0.0020 '/'
 Inlet Invert= 85.65', Outlet Invert= 85.35'



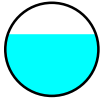
Summary for Reach 2R: Discharge Pipe

Inflow Area = 14.943 ac, 15.05% Impervious, Inflow Depth = 4.29" for 25-Year event
 Inflow = 19.57 cfs @ 12.40 hrs, Volume= 5.344 af
 Outflow = 19.55 cfs @ 12.42 hrs, Volume= 5.344 af, Atten= 0%, Lag= 0.8 min

Routing by Stor-Ind+Trans method, Time Span= 0.00-80.00 hrs, dt= 0.05 hrs / 2
 Max. Velocity= 5.67 fps, Min. Travel Time= 0.4 min
 Avg. Velocity = 2.23 fps, Avg. Travel Time= 1.0 min

Peak Storage= 483 cf @ 12.41 hrs
 Average Depth at Peak Storage= 1.66'
 Bank-Full Depth= 2.50' Flow Area= 4.9 sf, Capacity= 25.19 cfs

30.0" Round Pipe
 n= 0.012
 Length= 140.0' Slope= 0.0032 '/'
 Inlet Invert= 87.15', Outlet Invert= 86.70'



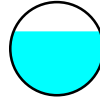
Summary for Reach 2Ra: Perforated Pipe A

Inflow Area = 4.214 ac, 5.58% Impervious, Inflow Depth = 4.09" for 25-Year event
 Inflow = 5.57 cfs @ 12.54 hrs, Volume= 1.438 af
 Outflow = 5.56 cfs @ 12.61 hrs, Volume= 1.438 af, Atten= 0%, Lag= 4.0 min

Routing by Stor-Ind+Trans method, Time Span= 0.00-80.00 hrs, dt= 0.05 hrs / 3
 Max. Velocity= 4.31 fps, Min. Travel Time= 2.1 min
 Avg. Velocity = 1.90 fps, Avg. Travel Time= 4.9 min

Peak Storage= 716 cf @ 12.57 hrs
 Average Depth at Peak Storage= 1.03'
 Bank-Full Depth= 1.50' Flow Area= 1.8 sf, Capacity= 6.83 cfs

18.0" Round Pipe
 n= 0.012
 Length= 555.0' Slope= 0.0036 '/'
 Inlet Invert= 92.00', Outlet Invert= 90.00'



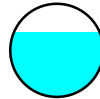
Summary for Reach 2Rb: Perforated Pipe B

Inflow Area = 10.585 ac, 4.84% Impervious, Inflow Depth = 4.09" for 25-Year event
 Inflow = 12.29 cfs @ 12.59 hrs, Volume= 3.611 af
 Outflow = 12.28 cfs @ 12.63 hrs, Volume= 3.611 af, Atten= 0%, Lag= 2.4 min

Routing by Stor-Ind+Trans method, Time Span= 0.00-80.00 hrs, dt= 0.05 hrs / 3
 Max. Velocity= 5.28 fps, Min. Travel Time= 1.2 min
 Avg. Velocity = 2.37 fps, Avg. Travel Time= 2.8 min

Peak Storage= 919 cf @ 12.61 hrs
 Average Depth at Peak Storage= 1.39'
 Bank-Full Depth= 2.00' Flow Area= 3.1 sf, Capacity= 14.85 cfs

24.0" Round Pipe
 n= 0.012
 Length= 395.0' Slope= 0.0037 '/'
 Inlet Invert= 89.50', Outlet Invert= 88.05'



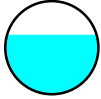
Summary for Reach 2Rc: Perforated Pipe C

Inflow Area = 13.951 ac, 9.01% Impervious, Inflow Depth = 4.17" for 25-Year event
 Inflow = 18.14 cfs @ 12.52 hrs, Volume= 4.849 af
 Outflow = 18.13 cfs @ 12.54 hrs, Volume= 4.849 af, Atten= 0%, Lag= 0.8 min

Routing by Stor-Ind+Trans method, Time Span= 0.00-80.00 hrs, dt= 0.05 hrs / 3
 Max. Velocity= 5.49 fps, Min. Travel Time= 0.4 min
 Avg. Velocity = 2.31 fps, Avg. Travel Time= 0.9 min

Peak Storage= 429 cf @ 12.53 hrs
 Average Depth at Peak Storage= 1.59'
 Bank-Full Depth= 2.50' Flow Area= 4.9 sf, Capacity= 24.65 cfs

30.0" Round Pipe
 n= 0.012
 Length= 130.0' Slope= 0.0031 '/
 Inlet Invert= 87.55', Outlet Invert= 87.15'



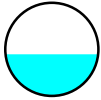
Summary for Reach 3R: Uniroyal South Outfall (Exist.)

Inflow Area = 18.001 ac, 21.28% Impervious, Inflow Depth = 4.42" for 25-Year event
 Inflow = 35.08 cfs @ 12.10 hrs, Volume= 6.636 af
 Outflow = 34.72 cfs @ 12.10 hrs, Volume= 6.636 af, Atten= 1%, Lag= 0.2 min

Routing by Stor-Ind+Trans method, Time Span= 0.00-80.00 hrs, dt= 0.05 hrs / 2
 Max. Velocity= 16.56 fps, Min. Travel Time= 0.2 min
 Avg. Velocity = 5.78 fps, Avg. Travel Time= 0.5 min

Peak Storage= 369 cf @ 12.10 hrs
 Average Depth at Peak Storage= 1.11'
 Bank-Full Depth= 2.50' Flow Area= 4.9 sf, Capacity= 85.65 cfs

30.0" Round Pipe
 n= 0.013
 Length= 175.0' Slope= 0.0436 '/
 Inlet Invert= 85.85', Outlet Invert= 78.22'



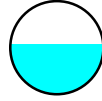
Summary for Reach 4Ra: 15" HDPE

Inflow Area = 4.214 ac, 5.58% Impervious, Inflow Depth = 4.09" for 25-Year event
 Inflow = 5.57 cfs @ 12.54 hrs, Volume= 1.438 af
 Outflow = 5.57 cfs @ 12.54 hrs, Volume= 1.438 af, Atten= 0%, Lag= 0.0 min

Routing by Stor-Ind+Trans method, Time Span= 0.00-80.00 hrs, dt= 0.05 hrs
 Max. Velocity= 8.30 fps, Min. Travel Time= 0.0 min
 Avg. Velocity = 3.70 fps, Avg. Travel Time= 0.0 min

Peak Storage= 3 cf @ 12.54 hrs
 Average Depth at Peak Storage= 0.67'
 Bank-Full Depth= 1.25' Flow Area= 1.2 sf, Capacity= 9.90 cfs

15.0" Round Pipe
 n= 0.012
 Length= 5.0' Slope= 0.0200 '/
 Inlet Invert= 93.50', Outlet Invert= 93.40'



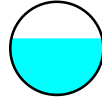
Summary for Reach 4Rb: 15" HDPE

Inflow Area = 6.371 ac, 4.34% Impervious, Inflow Depth = 4.09" for 25-Year event
 Inflow = 6.74 cfs @ 12.57 hrs, Volume= 2.174 af
 Outflow = 6.74 cfs @ 12.57 hrs, Volume= 2.174 af, Atten= 0%, Lag= 0.0 min

Routing by Stor-Ind+Trans method, Time Span= 0.00-80.00 hrs, dt= 0.05 hrs
 Max. Velocity= 8.67 fps, Min. Travel Time= 0.0 min
 Avg. Velocity = 4.08 fps, Avg. Travel Time= 0.0 min

Peak Storage= 8 cf @ 12.57 hrs
 Average Depth at Peak Storage= 0.76'
 Bank-Full Depth= 1.25' Flow Area= 1.2 sf, Capacity= 9.90 cfs

15.0" Round Pipe
 n= 0.012
 Length= 10.0' Slope= 0.0200 '/
 Inlet Invert= 91.00', Outlet Invert= 90.80'



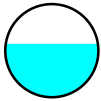
Summary for Reach 4Rc: 15" HDPE

Inflow Area = 3.366 ac, 22.13% Impervious, Inflow Depth = 4.41" for 25-Year event
 Inflow = 6.14 cfs @ 12.36 hrs, Volume= 1.238 af
 Outflow = 6.14 cfs @ 12.36 hrs, Volume= 1.238 af, Atten= 0%, Lag= 0.0 min

Routing by Stor-Ind+Trans method, Time Span= 0.00-80.00 hrs, dt= 0.05 hrs
 Max. Velocity= 8.50 fps, Min. Travel Time= 0.0 min
 Avg. Velocity = 3.44 fps, Avg. Travel Time= 0.0 min

Peak Storage= 7 cf @ 12.36 hrs
 Average Depth at Peak Storage= 0.71'
 Bank-Full Depth= 1.25' Flow Area= 1.2 sf, Capacity= 9.90 cfs

15.0" Round Pipe
 n= 0.012
 Length= 10.0' Slope= 0.0200 '/
 Inlet Invert= 91.00', Outlet Invert= 90.80'



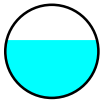
Summary for Reach 5Ra: 12" HDPE

Inflow Area = 2.276 ac, 15.81% Impervious, Inflow Depth = 4.31" for 25-Year event
 Inflow = 3.84 cfs @ 12.38 hrs, Volume= 0.817 af
 Outflow = 3.84 cfs @ 12.38 hrs, Volume= 0.817 af, Atten= 0%, Lag= 0.1 min

Routing by Stor-Ind+Trans method, Time Span= 0.00-80.00 hrs, dt= 0.05 hrs
 Max. Velocity= 7.53 fps, Min. Travel Time= 0.0 min
 Avg. Velocity = 3.19 fps, Avg. Travel Time= 0.0 min

Peak Storage= 3 cf @ 12.38 hrs
 Average Depth at Peak Storage= 0.62'
 Bank-Full Depth= 1.00' Flow Area= 0.8 sf, Capacity= 5.46 cfs

12.0" Round Pipe
 n= 0.012
 Length= 5.0' Slope= 0.0200 '/
 Inlet Invert= 93.60', Outlet Invert= 93.50'



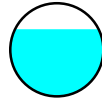
Summary for Reach 5Rb: 15" HDPE

Inflow Area = 2.712 ac, 10.71% Impervious, Inflow Depth = 4.20" for 25-Year event
 Inflow = 5.33 cfs @ 12.32 hrs, Volume= 0.949 af
 Outflow = 5.33 cfs @ 12.32 hrs, Volume= 0.949 af, Atten= 0%, Lag= 0.0 min

Routing by Stor-Ind+Trans method, Time Span= 0.00-80.00 hrs, dt= 0.05 hrs
 Max. Velocity= 5.63 fps, Min. Travel Time= 0.0 min
 Avg. Velocity = 2.30 fps, Avg. Travel Time= 0.1 min

Peak Storage= 12 cf @ 12.32 hrs
 Average Depth at Peak Storage= 0.90'
 Bank-Full Depth= 1.25' Flow Area= 1.2 sf, Capacity= 6.14 cfs

15.0" Round Pipe
 n= 0.012
 Length= 13.0' Slope= 0.0077 '/
 Inlet Invert= 93.60', Outlet Invert= 93.50'



Summary for Pond 1Pa: CB-17B Basin

Inflow Area = 2.276 ac, 15.81% Impervious, Inflow Depth = 4.31" for 25-Year event
 Inflow = 11.09 cfs @ 12.09 hrs, Volume= 0.817 af
 Outflow = 3.84 cfs @ 12.38 hrs, Volume= 0.817 af, Atten= 65%, Lag= 17.3 min
 Primary = 3.84 cfs @ 12.38 hrs, Volume= 0.817 af

Routing by Stor-Ind method, Time Span= 0.00-80.00 hrs, dt= 0.05 hrs
 Peak Elev= 98.50' @ 12.38 hrs Surf.Area= 8,803 sf Storage= 8,762 cf

Plug-Flow detention time= 46.2 min calculated for 0.816 af (100% of inflow)
 Center-of-Mass det. time= 46.4 min (851.2 - 804.8)

Volume #1	Invert	Avail.Storage	Storage Description
	97.00'	25,350 cf	Custom Stage Data (Prismatic) Listed below (Recalc)
Elevation (feet)	Surf.Area (sq-ft)	Inc.Store (cubic-feet)	Cum.Store (cubic-feet)
97.00	2,500	0	0
98.00	7,100	4,800	4,800
99.00	10,500	8,800	13,600
100.00	13,000	11,750	25,350

Device	Routing	Invert	Outlet Devices
#1	Primary	97.33'	2.0" x 2.0" Horiz. Catch Basin X 5.00 columns X 5 rows C= 0.600 in 24.0" x 24.0" Grate (17% open area) Limited to weir flow at low heads
#2	Primary	97.00'	1.020 in/hr Exfiltration over Surface area Conductivity to Groundwater Elevation = 82.50'

Primary OutFlow Max=3.84 cfs @ 12.38 hrs HW=98.50' (Free Discharge)
 1=Catch Basin (Orifice Controls 3.62 cfs @ 5.21 fps)
 2=Exfiltration (Controls 0.22 cfs)

Summary for Pond 1Pb: CB-16B Basin

Inflow Area = 2,712 ac, 10.71% Impervious, Inflow Depth = 4.20' for 25-Year event
 Inflow = 12.93 cfs @ 12.09 hrs, Volume= 0.949 af
 Outflow = 5.33 cfs @ 12.32 hrs, Volume= 0.949 af, Atten= 59%, Lag= 13.6 min
 Primary = 5.33 cfs @ 12.32 hrs, Volume= 0.949 af

Routing by Stor-Ind method, Time Span= 0.00-80.00 hrs, dt= 0.05 hrs
 Peak Elev= 98.45' @ 12.32 hrs Surf.Area= 9,060 sf Storage= 8,696 cf

Plug-Flow detention time= 41.1 min calculated for 0.949 af (100% of inflow)
 Center-of-Mass det. time= 41.3 min (848.7 - 807.5)

Volume	Invert	Avail.Storage	Storage Description
#1	97.00'	27,653 cf	Custom Stage Data (Prismatic) Listed below (Recalc)
Elevation (feet)	Surf.Area (sq-ft)	Inc.Store (cubic-feet)	Cum.Store (cubic-feet)
97.00	2,945	0	0
98.00	7,130	5,038	5,038
99.00	11,400	9,265	14,303
100.00	15,300	13,350	27,653

Device	Routing	Invert	Outlet Devices
#1	Primary	97.33'	2.0" x 2.0" Horiz. Catch Basin X 6.00 columns X 6 rows C= 0.600 in 24.0" x 24.0" Grate (25% open area) Limited to weir flow at low heads
#2	Primary	97.00'	1.020 in/hr Exfiltration over Surface area Conductivity to Groundwater Elevation = 82.50'

Primary OutFlow Max=5.32 cfs @ 12.32 hrs HW=98.45' (Free Discharge)
 1=Catch Basin (Orifice Controls 5.10 cfs @ 5.10 fps)
 2=Exfiltration (Controls 0.23 cfs)

Summary for Pond 2Pa: CB-8A Basin

Inflow Area = 4,214 ac, 5.58% Impervious, Inflow Depth = 4.09' for 25-Year event
 Inflow = 16.47 cfs @ 12.16 hrs, Volume= 1.438 af
 Outflow = 5.57 cfs @ 12.54 hrs, Volume= 1.438 af, Atten= 66%, Lag= 22.7 min
 Primary = 5.57 cfs @ 12.54 hrs, Volume= 1.438 af

Routing by Stor-Ind method, Time Span= 0.00-80.00 hrs, dt= 0.05 hrs
 Peak Elev= 98.46' @ 12.54 hrs Surf.Area= 17,617 sf Storage= 17,609 cf

Plug-Flow detention time= 51.5 min calculated for 1.437 af (100% of inflow)
 Center-of-Mass det. time= 51.6 min (867.1 - 815.5)

Volume	Invert	Avail.Storage	Storage Description
#1	97.00'	47,780 cf	Custom Stage Data (Prismatic) Listed below (Recalc)
Elevation (feet)	Surf.Area (sq-ft)	Inc.Store (cubic-feet)	Cum.Store (cubic-feet)
97.00	3,000	0	0
98.00	16,420	9,710	9,710
99.00	19,000	17,710	27,420
100.00	21,720	20,360	47,780

Device	Routing	Invert	Outlet Devices
#1	Primary	97.33'	2.0" x 2.0" Horiz. Catch Basin X 6.00 columns X 6 rows C= 0.600 in 24.0" x 24.0" Grate (25% open area) Limited to weir flow at low heads
#2	Primary	97.00'	1.020 in/hr Exfiltration over Surface area Conductivity to Groundwater Elevation = 80.00'

Primary OutFlow Max=5.57 cfs @ 12.54 hrs HW=98.46' (Free Discharge)
 1=Catch Basin (Orifice Controls 5.13 cfs @ 5.13 fps)
 2=Exfiltration (Controls 0.44 cfs)

Summary for Pond 2Pb: CB-11A Basin

Inflow Area = 6,371 ac, 4.34% Impervious, Inflow Depth = 4.09' for 25-Year event
 Inflow = 26.22 cfs @ 12.14 hrs, Volume= 2.174 af
 Outflow = 6.74 cfs @ 12.57 hrs, Volume= 2.174 af, Atten= 74%, Lag= 25.6 min
 Primary = 6.74 cfs @ 12.57 hrs, Volume= 2.174 af

Routing by Stor-Ind method, Time Span= 0.00-80.00 hrs, dt= 0.05 hrs
 Peak Elev= 96.42' @ 12.57 hrs Surf.Area= 26,637 sf Storage= 28,812 cf

Plug-Flow detention time= 47.3 min calculated for 2.172 af (100% of inflow)
 Center-of-Mass det. time= 47.4 min (861.2 - 813.8)

Volume	Invert	Avail.Storage	Storage Description
#1	94.50'	78,798 cf	Custom Stage Data (Prismatic) Listed below (Recalc)

Elevation (feet)	Surf.Area (sq-ft)	Inc.Store (cubic-feet)	Cum.Store (cubic-feet)
94.50	1,720	0	0
95.00	7,950	2,418	2,418
96.00	23,855	15,903	18,320
97.00	30,550	27,203	45,523
98.00	36,000	33,275	78,798

Device	Routing	Invert	Outlet Devices
#1	Primary	94.83'	2.0" x 2.0" Horiz. Catch Basin X 6.00 columns X 6 rows C= 0.600 in 24.0" x 24.0" Grate (25% open area) Limited to weir flow at low heads
#2	Primary	94.50'	1.020 in/hr Exfiltration over Surface area Conductivity to Groundwater Elevation = 80.50'

Primary OutFlow Max=6.74 cfs @ 12.57 hrs HW=96.41' (Free Discharge)
 1=Catch Basin (Orifice Controls 6.06 cfs @ 6.06 fps)
 2=Exfiltration (Controls 0.67 cfs)

Summary for Pond 2Pc: CB-13A Basin

Inflow Area = 3,366 ac, 22.13% Impervious, Inflow Depth = 4.41' for 25-Year event
 Inflow = 16.74 cfs @ 12.09 hrs, Volume= 1.238 af
 Outflow = 6.14 cfs @ 12.36 hrs, Volume= 1.238 af, Atten= 63%, Lag= 16.0 min
 Primary = 6.14 cfs @ 12.36 hrs, Volume= 1.238 af

Routing by Stor-Ind method, Time Span= 0.00-80.00 hrs, dt= 0.05 hrs
 Peak Elev= 96.34' @ 12.36 hrs Surf.Area= 9,134 sf Storage= 12,260 cf

Plug-Flow detention time= 35.7 min calculated for 1.237 af (100% of inflow)
 Center-of-Mass det. time= 35.9 min (837.9 - 802.1)

Volume	Invert	Avail.Storage	Storage Description
#1	94.50'	31,216 cf	Custom Stage Data (Prismatic) Listed below (Recalc)
Elevation (feet)	Surf.Area (sq-ft)	Inc.Store (cubic-feet)	Cum.Store (cubic-feet)
94.50	1,580	0	0
95.00	6,285	1,966	1,966
96.00	8,420	7,353	9,319
97.00	10,550	9,485	18,804
98.00	14,275	12,413	31,216

Device	Routing	Invert	Outlet Devices
#1	Primary	94.83'	2.0" x 2.0" Horiz. Catch Basin X 6.00 columns X 6 rows C= 0.600 in 24.0" x 24.0" Grate (25% open area) Limited to weir flow at low heads
#2	Primary	94.50'	1.020 in/hr Exfiltration over Surface area Conductivity to Groundwater Elevation = 80.50'

Primary OutFlow Max=6.14 cfs @ 12.36 hrs HW=96.33' (Free Discharge)
 1=Catch Basin (Orifice Controls 5.91 cfs @ 5.91 fps)
 2=Exfiltration (Controls 0.24 cfs)

Summary for Link 1L: Facemate Interceptor Drain

Inflow Area = 4,988 ac, 13.04% Impervious, Inflow Depth = 4.25' for 25-Year event
 Inflow = 9.13 cfs @ 12.39 hrs, Volume= 1.766 af
 Primary = 9.13 cfs @ 12.39 hrs, Volume= 1.766 af, Atten= 0%, Lag= 0.0 min

Primary outflow = Inflow, Time Span= 0.00-80.00 hrs, dt= 0.05 hrs

Summary for Link 2L: Chicopee River

Inflow Area = 18,001 ac, 21.28% Impervious, Inflow Depth = 4.42' for 25-Year event
 Inflow = 34.72 cfs @ 12.10 hrs, Volume= 6.636 af
 Primary = 34.72 cfs @ 12.10 hrs, Volume= 6.636 af, Atten= 0%, Lag= 0.0 min

Primary outflow = Inflow, Time Span= 0.00-80.00 hrs, dt= 0.05 hrs

Summary for Subcatchment 1Sa: PR-DA-1S - CB-17B Catchment

Runoff = 15.34 cfs @ 12.09 hrs, Volume= 1.146 af, Depth= 6.04"

Runoff by SCS TR-20 method, UH=SCS, Weighted-CN, Time Span= 0.00-80.00 hrs, dt= 0.05 hrs
 Type III 24-hr 100-Year Rainfall=8.07"

Area (sf)	CN	Description			
74,164	80	>75% Grass cover, Good, HSG D			
6,867	98	Paved parking, HSG D			
6,237	98	Roofs, HSG D			
2,569	98	Water Surface, HSG D			
9,314	79	Woods, Fair, HSG D			
99,151	83	Weighted Average			
83,478		84.19% Pervious Area			
15,674		15.81% Impervious Area			
Tc (min)	Length (feet)	Slope (ft/ft)	Velocity (ft/sec)	Capacity (cfs)	Description
0.6	50	0.0280	1.33		Sheet Flow, Sheet Flow Smooth surfaces n= 0.011 P2= 3.00"
2.6	190	0.0150	1.22		Shallow Concentrated Flow, Shallow Conc. 1 Nearly Bare & Untilled Kv= 10.0 fps
0.7	96	0.0490	2.21		Shallow Concentrated Flow, Shallow Conc. 2 Nearly Bare & Untilled Kv= 10.0 fps
2.1					Direct Entry, Minimum TC
6.0	336				Total

Summary for Subcatchment 1Sb: PR-DA-1S - CB-16B Catchment

Runoff = 18.00 cfs @ 12.09 hrs, Volume= 1.339 af, Depth= 5.93"

Runoff by SCS TR-20 method, UH=SCS, Weighted-CN, Time Span= 0.00-80.00 hrs, dt= 0.05 hrs
 Type III 24-hr 100-Year Rainfall=8.07"

Area (sf)	CN	Description			
93,694	80	>75% Grass cover, Good, HSG D			
10,157	98	Paved parking, HSG D			
2,498	98	Water Surface, HSG D			
11,795	79	Woods, Fair, HSG D			
118,144	82	Weighted Average			
105,489		89.29% Pervious Area			
12,655		10.71% Impervious Area			
Tc (min)	Length (feet)	Slope (ft/ft)	Velocity (ft/sec)	Capacity (cfs)	Description
6.0					Direct Entry, Minimum TC

Summary for Subcatchment 2Sc: PR-DA-2S - CB-13A Catchment

Runoff = 23.02 cfs @ 12.09 hrs, Volume= 1.729 af, Depth= 6.16"

Runoff by SCS TR-20 method, UH=SCS, Weighted-CN, Time Span= 0.00-80.00 hrs, dt= 0.05 hrs
 Type III 24-hr 100-Year Rainfall=8.07"

Area (sf)	CN	Description			
108,361	80	>75% Grass cover, Good, HSG D			
30,845	98	Paved parking, HSG D			
1,607	98	Water Surface, HSG D			
5,822	79	Woods, Fair, HSG D			
146,635	84	Weighted Average			
114,183		77.87% Pervious Area			
32,452		22.13% Impervious Area			
Tc (min)	Length (feet)	Slope (ft/ft)	Velocity (ft/sec)	Capacity (cfs)	Description
5.6	50	0.0220	0.15		Sheet Flow, Sheet Flow Grass: Short n= 0.150 P2= 3.00"
0.3	40	0.0220	2.22		Shallow Concentrated Flow, Shallow Conc. Grassed Waterway Kv= 15.0 fps
0.1					Direct Entry, Minimum TC
6.0	90				Total

Summary for Subcatchment 3S: PR-DA-3S - Upper Uniroyal Site

Runoff = 22.50 cfs @ 12.09 hrs, Volume= 1.752 af, Depth= 6.87"

Runoff by SCS TR-20 method, UH=SCS, Weighted-CN, Time Span= 0.00-80.00 hrs, dt= 0.05 hrs
 Type III 24-hr 100-Year Rainfall=8.07"

Area (sf)	CN	Description			
8,648	89	<50% Grass cover, Poor, HSG D			
55,625	80	>75% Grass cover, Good, HSG D			
17,187	98	Paved parking, HSG D			
51,767	98	Roofs, HSG D			
133,228	90	Weighted Average			
64,274		48.24% Pervious Area			
68,954		51.76% Impervious Area			
Tc (min)	Length (feet)	Slope (ft/ft)	Velocity (ft/sec)	Capacity (cfs)	Description
6.0					Direct Entry, Minimum TC

Summary for Subcatchment 2Sa: PR-DA-2S - CB-8A Catchment

Runoff = 23.11 cfs @ 12.16 hrs, Volume= 2.040 af, Depth= 5.81"

Runoff by SCS TR-20 method, UH=SCS, Weighted-CN, Time Span= 0.00-80.00 hrs, dt= 0.05 hrs
 Type III 24-hr 100-Year Rainfall=8.07"

Area (sf)	CN	Description			
165,088	80	>75% Grass cover, Good, HSG D			
5,904	98	Paved parking, HSG D			
1,265	98	Roofs, HSG D			
3,083	98	Water Surface, HSG D			
8,216	79	Woods, Fair, HSG D			
183,555	81	Weighted Average			
173,304		94.42% Pervious Area			
10,251		5.58% Impervious Area			
Tc (min)	Length (feet)	Slope (ft/ft)	Velocity (ft/sec)	Capacity (cfs)	Description
8.8	50	0.0070	0.09		Sheet Flow, Sheet Flow Grass: Short n= 0.150 P2= 3.00"
3.1	235	0.0070	1.25		Shallow Concentrated Flow, Shallow Conc. 1 Grassed Waterway Kv= 15.0 fps
11.9	285				Total

Summary for Subcatchment 2Sb: PR-DA-2S - CB-11A Catchment

Runoff = 36.75 cfs @ 12.14 hrs, Volume= 3.084 af, Depth= 5.81"

Runoff by SCS TR-20 method, UH=SCS, Weighted-CN, Time Span= 0.00-80.00 hrs, dt= 0.05 hrs
 Type III 24-hr 100-Year Rainfall=8.07"

Area (sf)	CN	Description			
265,478	80	>75% Grass cover, Good, HSG D			
10,628	98	Paved parking, HSG D			
1,422	98	Water Surface, HSG D			
277,528	81	Weighted Average			
265,478		95.66% Pervious Area			
12,050		4.34% Impervious Area			
Tc (min)	Length (feet)	Slope (ft/ft)	Velocity (ft/sec)	Capacity (cfs)	Description
8.0	50	0.0090	0.10		Sheet Flow, Sheet Flow Grass: Short n= 0.150 P2= 3.00"
2.0	175	0.0090	1.42		Shallow Concentrated Flow, Shallow Conc. 1 Grassed Waterway Kv= 15.0 fps
10.0	225				Total

Summary for Subcatchment B26: Building 26

Runoff = 1.89 cfs @ 12.09 hrs, Volume= 0.159 af, Depth= 7.83"

Runoff by SCS TR-20 method, UH=SCS, Weighted-CN, Time Span= 0.00-80.00 hrs, dt= 0.05 hrs
 Type III 24-hr 100-Year Rainfall=8.07"

Area (sf)	CN	Description			
10,635	98	Roofs, HSG D			
10,635		100.00% Impervious Area			
Tc (min)	Length (feet)	Slope (ft/ft)	Velocity (ft/sec)	Capacity (cfs)	Description
6.0					Direct Entry, Minimum TC

Summary for Subcatchment B27: Building 27

Runoff = 5.78 cfs @ 12.09 hrs, Volume= 0.488 af, Depth= 7.83"

Runoff by SCS TR-20 method, UH=SCS, Weighted-CN, Time Span= 0.00-80.00 hrs, dt= 0.05 hrs
 Type III 24-hr 100-Year Rainfall=8.07"

Area (sf)	CN	Description			
32,552	98	Roofs, HSG D			
32,552		100.00% Impervious Area			
Tc (min)	Length (feet)	Slope (ft/ft)	Velocity (ft/sec)	Capacity (cfs)	Description
6.0					Direct Entry, Minimum TC

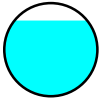
Summary for Reach 1R: Discharge Pipe

Inflow Area = 4.988 ac, 13.04% Impervious, Inflow Depth = 5.98" for 100-Year event
 Inflow = 10.88 cfs @ 12.43 hrs, Volume= 2.486 af
 Outflow = 10.87 cfs @ 12.44 hrs, Volume= 2.486 af, Atten= 0%, Lag= 0.4 min

Routing by Stor-Ind+Trans method, Time Span= 0.00-80.00 hrs, dt= 0.05 hrs
 Max. Velocity= 3.98 fps, Min. Travel Time= 0.2 min
 Avg. Velocity= 1.70 fps, Avg. Travel Time= 0.5 min

Peak Storage= 137 cf @ 12.43 hrs
 Average Depth at Peak Storage= 1.63'
 Bank-Full Depth= 2.00' Flow Area= 3.1 sf, Capacity= 10.96 cfs

24.0" Round Pipe
 n= 0.012
 Length= 50.0' Slope= 0.0020 '
 Inlet Invert= 85.35', Outlet Invert= 85.25'



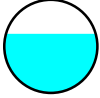
Summary for Reach 1Ra: Perforated Pipe

Inflow Area = 2.276 ac, 15.81% Impervious, Inflow Depth = 6.04" for 100-Year event
Inflow = 4.55 cfs @ 12.42 hrs, Volume= 1.146 af
Outflow = 4.55 cfs @ 12.47 hrs, Volume= 1.146 af, Atten= 0%, Lag= 2.7 min

Routing by Stor-Ind+Trans method, Time Span= 0.00-80.00 hrs, dt= 0.05 hrs
Max. Velocity= 3.85 fps, Min. Travel Time= 1.5 min
Avg. Velocity = 1.64 fps, Avg. Travel Time= 3.5 min

Peak Storage= 414 cf @ 12.44 hrs
Average Depth at Peak Storage= 0.95'
Bank-Full Depth= 1.50' Flow Area= 1.8 sf, Capacity= 6.23 cfs

18.0" Round Pipe
n= 0.012
Length= 350.0' Slope= 0.0030 '/
Inlet Invert= 87.20', Outlet Invert= 86.15'



Summary for Reach 1Rb: Perforated Pipe

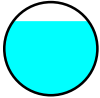
Inflow Area = 4.988 ac, 13.04% Impervious, Inflow Depth = 5.98" for 100-Year event
Inflow = 10.88 cfs @ 12.41 hrs, Volume= 2.486 af
Outflow = 10.88 cfs @ 12.43 hrs, Volume= 2.486 af, Atten= 0%, Lag= 1.3 min

Routing by Stor-Ind+Trans method, Time Span= 0.00-80.00 hrs, dt= 0.05 hrs
Max. Velocity= 3.98 fps, Min. Travel Time= 0.6 min
Avg. Velocity = 1.71 fps, Avg. Travel Time= 1.5 min

Peak Storage= 410 cf @ 12.42 hrs
Average Depth at Peak Storage= 1.63'
Bank-Full Depth= 2.00' Flow Area= 3.1 sf, Capacity= 10.96 cfs

24.0" Round Pipe
n= 0.012
Length= 150.0' Slope= 0.0020 '/
Inlet Invert= 85.65', Outlet Invert= 85.35'

18.0" Round Pipe
n= 0.012
Length= 555.0' Slope= 0.0036 '/
Inlet Invert= 92.00', Outlet Invert= 90.00'



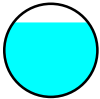
Summary for Reach 2Rb: Perforated Pipe B

Inflow Area = 10.585 ac, 4.84% Impervious, Inflow Depth = 5.81" for 100-Year event
Inflow = 14.46 cfs @ 12.64 hrs, Volume= 5.123 af
Outflow = 14.45 cfs @ 12.68 hrs, Volume= 5.123 af, Atten= 0%, Lag= 2.5 min

Routing by Stor-Ind+Trans method, Time Span= 0.00-80.00 hrs, dt= 0.05 hrs / 3
Max. Velocity= 5.39 fps, Min. Travel Time= 1.2 min
Avg. Velocity = 2.57 fps, Avg. Travel Time= 2.6 min

Peak Storage= 1,060 cf @ 12.66 hrs
Average Depth at Peak Storage= 1.59'
Bank-Full Depth= 2.00' Flow Area= 3.1 sf, Capacity= 14.85 cfs

24.0" Round Pipe
n= 0.012
Length= 395.0' Slope= 0.0037 '/
Inlet Invert= 89.50', Outlet Invert= 88.05'

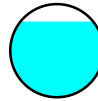


Summary for Reach 2Rc: Perforated Pipe C

Inflow Area = 13.951 ac, 9.01% Impervious, Inflow Depth = 5.89" for 100-Year event
Inflow = 21.52 cfs @ 12.57 hrs, Volume= 6.852 af
Outflow = 21.50 cfs @ 12.58 hrs, Volume= 6.852 af, Atten= 0%, Lag= 0.8 min

Routing by Stor-Ind+Trans method, Time Span= 0.00-80.00 hrs, dt= 0.05 hrs / 3
Max. Velocity= 5.66 fps, Min. Travel Time= 0.4 min
Avg. Velocity = 2.52 fps, Avg. Travel Time= 0.9 min

Peak Storage= 494 cf @ 12.57 hrs
Average Depth at Peak Storage= 1.81'
Bank-Full Depth= 2.50' Flow Area= 4.9 sf, Capacity= 24.65 cfs



Summary for Reach 2R: Discharge Pipe

Inflow Area = 14.943 ac, 15.05% Impervious, Inflow Depth = 6.02" for 100-Year event
Inflow = 23.23 cfs @ 12.41 hrs, Volume= 7.499 af
Outflow = 23.21 cfs @ 12.42 hrs, Volume= 7.499 af, Atten= 0%, Lag= 0.8 min

Routing by Stor-Ind+Trans method, Time Span= 0.00-80.00 hrs, dt= 0.05 hrs / 2
Max. Velocity= 5.82 fps, Min. Travel Time= 0.4 min
Avg. Velocity = 2.46 fps, Avg. Travel Time= 0.9 min

Peak Storage= 558 cf @ 12.41 hrs
Average Depth at Peak Storage= 1.89'
Bank-Full Depth= 2.50' Flow Area= 4.9 sf, Capacity= 25.19 cfs

30.0" Round Pipe
n= 0.012
Length= 140.0' Slope= 0.0032 '/
Inlet Invert= 87.15', Outlet Invert= 86.70'



Summary for Reach 2Ra: Perforated Pipe A

Inflow Area = 4.214 ac, 5.58% Impervious, Inflow Depth = 5.81" for 100-Year event
Inflow = 6.65 cfs @ 12.58 hrs, Volume= 2.040 af
Outflow = 6.64 cfs @ 12.65 hrs, Volume= 2.040 af, Atten= 0%, Lag= 4.4 min

Routing by Stor-Ind+Trans method, Time Span= 0.00-80.00 hrs, dt= 0.05 hrs / 3
Max. Velocity= 4.40 fps, Min. Travel Time= 2.1 min
Avg. Velocity = 2.05 fps, Avg. Travel Time= 4.5 min

Peak Storage= 837 cf @ 12.62 hrs
Average Depth at Peak Storage= 1.19'
Bank-Full Depth= 1.50' Flow Area= 1.8 sf, Capacity= 6.83 cfs

30.0" Round Pipe
n= 0.012
Length= 130.0' Slope= 0.0031 '/
Inlet Invert= 87.55', Outlet Invert= 87.15'



Summary for Reach 3R: Uniroyal South Outfall (Exist.)

Inflow Area = 18.001 ac, 21.28% Impervious, Inflow Depth = 6.17" for 100-Year event
Inflow = 44.81 cfs @ 12.10 hrs, Volume= 9.251 af
Outflow = 44.38 cfs @ 12.10 hrs, Volume= 9.251 af, Atten= 1%, Lag= 0.2 min

Routing by Stor-Ind+Trans method, Time Span= 0.00-80.00 hrs, dt= 0.05 hrs / 2
Max. Velocity= 17.62 fps, Min. Travel Time= 0.2 min
Avg. Velocity = 6.39 fps, Avg. Travel Time= 0.5 min

Peak Storage= 443 cf @ 12.10 hrs
Average Depth at Peak Storage= 1.28'
Bank-Full Depth= 2.50' Flow Area= 4.9 sf, Capacity= 85.65 cfs

30.0" Round Pipe
n= 0.013
Length= 175.0' Slope= 0.0436 '/
Inlet Invert= 85.85', Outlet Invert= 78.22'



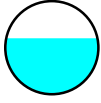
Summary for Reach 4Ra: 15" HDPE

Inflow Area = 4.214 ac, 5.58% Impervious, Inflow Depth = 5.81" for 100-Year event
Inflow = 6.65 cfs @ 12.58 hrs, Volume= 2.040 af
Outflow = 6.65 cfs @ 12.58 hrs, Volume= 2.040 af, Atten= 0%, Lag= 0.0 min

Routing by Stor-Ind+Trans method, Time Span= 0.00-80.00 hrs, dt= 0.05 hrs
Max. Velocity= 8.65 fps, Min. Travel Time= 0.0 min
Avg. Velocity = 4.00 fps, Avg. Travel Time= 0.0 min

Peak Storage= 4 cf @ 12.58 hrs
 Average Depth at Peak Storage= 0.75'
 Bank-Full Depth= 1.25' Flow Area= 1.2 sf, Capacity= 9.90 cfs

15.0" Round Pipe
 n= 0.012
 Length= 5.0' Slope= 0.0200 '/
 Inlet Invert= 93.50', Outlet Invert= 93.40'



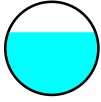
Summary for Reach 4Rb: 15" HDPE

Inflow Area = 6.371 ac, 4.34% Impervious, Inflow Depth = 5.81" for 100-Year event
 Inflow = 7.83 cfs @ 12.61 hrs, Volume= 3.084 af
 Outflow = 7.83 cfs @ 12.61 hrs, Volume= 3.084 af, Atten= 0%, Lag= 0.0 min

Routing by Stor-Ind+Trans method, Time Span= 0.00-80.00 hrs, dt= 0.05 hrs
 Max. Velocity= 8.94 fps, Min. Travel Time= 0.0 min
 Avg. Velocity= 4.44 fps, Avg. Travel Time= 0.0 min

Peak Storage= 9 cf @ 12.61 hrs
 Average Depth at Peak Storage= 0.84'
 Bank-Full Depth= 1.25' Flow Area= 1.2 sf, Capacity= 9.90 cfs

15.0" Round Pipe
 n= 0.012
 Length= 10.0' Slope= 0.0200 '/
 Inlet Invert= 91.00', Outlet Invert= 90.80'



Summary for Reach 4Rc: 15" HDPE

Inflow Area = 3.366 ac, 22.13% Impervious, Inflow Depth = 6.16" for 100-Year event
 Inflow = 7.34 cfs @ 12.40 hrs, Volume= 1.729 af
 Outflow = 7.34 cfs @ 12.40 hrs, Volume= 1.729 af, Atten= 0%, Lag= 0.0 min

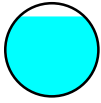
Summary for Reach 5Rb: 15" HDPE

Inflow Area = 2.712 ac, 10.71% Impervious, Inflow Depth = 5.93" for 100-Year event
 Inflow = 6.36 cfs @ 12.37 hrs, Volume= 1.339 af
 Outflow = 6.36 cfs @ 12.37 hrs, Volume= 1.339 af, Atten= 0%, Lag= 0.2 min

Routing by Stor-Ind+Trans method, Time Span= 0.00-80.00 hrs, dt= 0.05 hrs
 Max. Velocity= 5.70 fps, Min. Travel Time= 0.0 min
 Avg. Velocity= 2.48 fps, Avg. Travel Time= 0.1 min

Peak Storage= 15 cf @ 12.37 hrs
 Average Depth at Peak Storage= 1.07'
 Bank-Full Depth= 1.25' Flow Area= 1.2 sf, Capacity= 6.14 cfs

15.0" Round Pipe
 n= 0.012
 Length= 13.0' Slope= 0.0077 '/
 Inlet Invert= 93.60', Outlet Invert= 93.50'



Summary for Pond 1Pa: CB-17B Basin

Inflow Area = 2.276 ac, 15.81% Impervious, Inflow Depth = 6.04" for 100-Year event
 Inflow = 15.34 cfs @ 12.09 hrs, Volume= 1.146 af
 Outflow = 4.55 cfs @ 12.42 hrs, Volume= 1.146 af, Atten= 70%, Lag= 20.0 min
 Primary = 4.55 cfs @ 12.42 hrs, Volume= 1.146 af

Routing by Stor-Ind method, Time Span= 0.00-80.00 hrs, dt= 0.05 hrs
 Peak Elev= 98.97' @ 12.42 hrs Surf.Area= 10,404 sf Storage= 13,304 cf

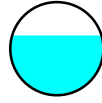
Plug-Flow detention time= 44.2 min calculated for 1.146 af (100% of inflow)
 Center-of-Mass det. time= 44.1 min (839.4 - 795.3)

Volume	Invert	Avail.Storage	Storage Description
#1	97.00'	25,350 cf	Custom Stage Data (Prismatic) Listed below (Recalc)
Elevation (feet)	Surf.Area (sq-ft)	Inc.Store (cubic-feet)	Cum.Store (cubic-feet)
97.00	2,500	0	0
98.00	7,100	4,800	4,800
99.00	10,500	8,800	13,600
100.00	13,000	11,750	25,350

Routing by Stor-Ind+Trans method, Time Span= 0.00-80.00 hrs, dt= 0.05 hrs
 Max. Velocity= 8.83 fps, Min. Travel Time= 0.0 min
 Avg. Velocity= 3.72 fps, Avg. Travel Time= 0.0 min

Peak Storage= 8 cf @ 12.40 hrs
 Average Depth at Peak Storage= 0.80'
 Bank-Full Depth= 1.25' Flow Area= 1.2 sf, Capacity= 9.90 cfs

15.0" Round Pipe
 n= 0.012
 Length= 10.0' Slope= 0.0200 '/
 Inlet Invert= 91.00', Outlet Invert= 90.80'



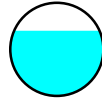
Summary for Reach 5Ra: 12" HDPE

Inflow Area = 2.276 ac, 15.81% Impervious, Inflow Depth = 6.04" for 100-Year event
 Inflow = 4.55 cfs @ 12.42 hrs, Volume= 1.146 af
 Outflow = 4.55 cfs @ 12.42 hrs, Volume= 1.146 af, Atten= 0%, Lag= 0.1 min

Routing by Stor-Ind+Trans method, Time Span= 0.00-80.00 hrs, dt= 0.05 hrs
 Max. Velocity= 7.78 fps, Min. Travel Time= 0.0 min
 Avg. Velocity= 3.44 fps, Avg. Travel Time= 0.0 min

Peak Storage= 3 cf @ 12.42 hrs
 Average Depth at Peak Storage= 0.70'
 Bank-Full Depth= 1.00' Flow Area= 0.8 sf, Capacity= 5.46 cfs

12.0" Round Pipe
 n= 0.012
 Length= 5.0' Slope= 0.0200 '/
 Inlet Invert= 93.60', Outlet Invert= 93.50'



Device	Routing	Invert	Outlet Devices
#1	Primary	97.33'	2.0" x 2.0" Horiz. Catch Basin X 5.00 columns X 5 rows C= 0.600 in 24.0" x 24.0" Grate (17% open area) Limited to weir flow at low heads
#2	Primary	97.00'	1.020 in/hr Exfiltration over Surface area Conductivity to Groundwater Elevation = 82.50'

Primary OutFlow Max=4.55 cfs @ 12.42 hrs HW=98.97' (Free Discharge)
 1=Catch Basin (Orifice Controls 4.28 cfs @ 6.17 fps)
 2=Exfiltration (Controls 0.27 cfs)

Summary for Pond 1Pb: CB-16B Basin

Inflow Area = 2.712 ac, 10.71% Impervious, Inflow Depth = 5.93" for 100-Year event
 Inflow = 18.00 cfs @ 12.09 hrs, Volume= 1.339 af
 Outflow = 6.36 cfs @ 12.37 hrs, Volume= 1.339 af, Atten= 65%, Lag= 16.6 min
 Primary = 6.36 cfs @ 12.37 hrs, Volume= 1.339 af

Routing by Stor-Ind method, Time Span= 0.00-80.00 hrs, dt= 0.05 hrs
 Peak Elev= 98.92' @ 12.37 hrs Surf.Area= 11,067 sf Storage= 13,425 cf

Plug-Flow detention time= 37.4 min calculated for 1.339 af (100% of inflow)
 Center-of-Mass det. time= 37.6 min (835.4 - 797.8)

Volume	Invert	Avail.Storage	Storage Description
#1	97.00'	27,653 cf	Custom Stage Data (Prismatic) Listed below (Recalc)
Elevation (feet)	Surf.Area (sq-ft)	Inc.Store (cubic-feet)	Cum.Store (cubic-feet)
97.00	2,945	0	0
98.00	7,130	5,038	5,038
99.00	11,400	9,265	14,303
100.00	15,300	13,350	27,653

Device	Routing	Invert	Outlet Devices
#1	Primary	97.33'	2.0" x 2.0" Horiz. Catch Basin X 6.00 columns X 6 rows C= 0.600 in 24.0" x 24.0" Grate (25% open area) Limited to weir flow at low heads
#2	Primary	97.00'	1.020 in/hr Exfiltration over Surface area Conductivity to Groundwater Elevation = 82.50'

Primary OutFlow Max=6.35 cfs @ 12.37 hrs HW=98.92' (Free Discharge)
 1=Catch Basin (Orifice Controls 6.07 cfs @ 6.07 fps)
 2=Exfiltration (Controls 0.28 cfs)

Summary for Pond 2Pa: CB-8A Basin

Inflow Area = 4.214 ac, 5.58% Impervious, Inflow Depth = 5.81" for 100-Year event
 Inflow = 23.11 cfs @ 12.16 hrs, Volume= 2,040 af
 Outflow = 6.65 cfs @ 12.58 hrs, Volume= 2,040 af, Atten= 71%, Lag= 25.0 min
 Primary = 6.65 cfs @ 12.58 hrs, Volume= 2,040 af

Routing by Stor-Ind method, Time Span= 0.00-80.00 hrs, dt= 0.05 hrs
 Peak Elev= 98.97' @ 12.58 hrs Surf.Area= 18,921 sf Storage= 26,838 cf

Plug-Flow detention time= 52.5 min calculated for 2.038 af (100% of inflow)
 Center-of-Mass det. time= 52.6 min (858.3 - 805.7)

Volume	Invert	Avail.Storage	Storage Description
#1	97.00'	47,780 cf	Custom Stage Data (Prismatic) Listed below (Recalc)

Elevation (feet)	Surf.Area (sq-ft)	Inc.Store (cubic-feet)	Cum.Store (cubic-feet)
97.00	3,000	0	0
98.00	16,420	9,710	9,710
99.00	19,000	17,710	27,420
100.00	21,720	20,360	47,780

Device	Routing	Invert	Outlet Devices
#1	Primary	97.33'	2.0" x 2.0" Horiz. Catch Basin X 6.00 columns X 6 rows C= 0.600 in 24.0" x 24.0" Grate (25% open area) Limited to weir flow at low heads
#2	Primary	97.00'	1.020 in/hr Exfiltration over Surface area Conductivity to Groundwater Elevation = 80.00'

Primary OutFlow Max=6.65 cfs @ 12.58 hrs HW=98.97' (Free Discharge)
 1=Catch Basin (Orifice Controls 6.16 cfs @ 6.16 fps)
 2=Exfiltration (Controls 0.48 cfs)

Summary for Pond 2Pb: CB-11A Basin

Inflow Area = 6.371 ac, 4.34% Impervious, Inflow Depth = 5.81" for 100-Year event
 Inflow = 36.75 cfs @ 12.14 hrs, Volume= 3,084 af
 Outflow = 7.83 cfs @ 12.61 hrs, Volume= 3,084 af, Atten= 79%, Lag= 28.2 min
 Primary = 7.83 cfs @ 12.61 hrs, Volume= 3,084 af

Routing by Stor-Ind method, Time Span= 0.00-80.00 hrs, dt= 0.05 hrs
 Peak Elev= 96.97' @ 12.61 hrs Surf.Area= 30,344 sf Storage= 44,584 cf

Plug-Flow detention time= 56.8 min calculated for 3.084 af (100% of inflow)
 Center-of-Mass det. time= 56.6 min (860.6 - 803.9)

Volume	Invert	Avail.Storage	Storage Description
#1	94.50'	78,798 cf	Custom Stage Data (Prismatic) Listed below (Recalc)

Elevation (feet)	Surf.Area (sq-ft)	Inc.Store (cubic-feet)	Cum.Store (cubic-feet)
94.50	1,720	0	0
95.00	7,950	2,418	2,418
96.00	23,855	15,903	18,320
97.00	30,550	27,203	45,523
98.00	36,000	33,275	78,798

Device	Routing	Invert	Outlet Devices
#1	Primary	94.83'	2.0" x 2.0" Horiz. Catch Basin X 6.00 columns X 6 rows C= 0.600 in 24.0" x 24.0" Grate (25% open area) Limited to weir flow at low heads
#2	Primary	94.50'	1.020 in/hr Exfiltration over Surface area Conductivity to Groundwater Elevation = 80.50'

Primary OutFlow Max=7.83 cfs @ 12.61 hrs HW=96.97' (Free Discharge)
 1=Catch Basin (Orifice Controls 7.04 cfs @ 7.04 fps)
 2=Exfiltration (Controls 0.79 cfs)

Summary for Pond 2Pc: CB-13A Basin

Inflow Area = 3.366 ac, 22.13% Impervious, Inflow Depth = 6.16" for 100-Year event
 Inflow = 23.02 cfs @ 12.09 hrs, Volume= 1,729 af
 Outflow = 7.34 cfs @ 12.40 hrs, Volume= 1,729 af, Atten= 68%, Lag= 18.6 min
 Primary = 7.34 cfs @ 12.40 hrs, Volume= 1,729 af

Routing by Stor-Ind method, Time Span= 0.00-80.00 hrs, dt= 0.05 hrs
 Peak Elev= 96.98' @ 12.40 hrs Surf.Area= 10,512 sf Storage= 18,618 cf

Plug-Flow detention time= 34.9 min calculated for 1.728 af (100% of inflow)
 Center-of-Mass det. time= 35.1 min (827.8 - 792.8)

Volume	Invert	Avail.Storage	Storage Description
#1	94.50'	31,216 cf	Custom Stage Data (Prismatic) Listed below (Recalc)

Elevation (feet)	Surf.Area (sq-ft)	Inc.Store (cubic-feet)	Cum.Store (cubic-feet)
94.50	1,580	0	0
95.00	6,285	1,966	1,966
96.00	8,420	7,353	9,319
97.00	10,550	9,485	18,804
98.00	14,275	12,413	31,216

Device	Routing	Invert	Outlet Devices
#1	Primary	94.83'	2.0" x 2.0" Horiz. Catch Basin X 6.00 columns X 6 rows C= 0.600 in 24.0" x 24.0" Grate (25% open area) Limited to weir flow at low heads
#2	Primary	94.50'	1.020 in/hr Exfiltration over Surface area Conductivity to Groundwater Elevation = 80.50'

Primary OutFlow Max=7.34 cfs @ 12.40 hrs HW=96.98' (Free Discharge)
 1=Catch Basin (Orifice Controls 7.06 cfs @ 7.06 fps)
 2=Exfiltration (Controls 0.28 cfs)

Summary for Link 1L: Facemate Interceptor Drain

Inflow Area = 4.988 ac, 13.04% Impervious, Inflow Depth = 5.98" for 100-Year event
 Inflow = 10.87 cfs @ 12.44 hrs, Volume= 2,486 af
 Primary = 10.87 cfs @ 12.44 hrs, Volume= 2,486 af, Atten= 0%, Lag= 0.0 min

Primary outflow = Inflow, Time Span= 0.00-80.00 hrs, dt= 0.05 hrs

Summary for Link 2L: Chicopee River

Inflow Area = 18.001 ac, 21.28% Impervious, Inflow Depth = 6.17" for 100-Year event
 Inflow = 44.38 cfs @ 12.10 hrs, Volume= 9,251 af
 Primary = 44.38 cfs @ 12.10 hrs, Volume= 9,251 af, Atten= 0%, Lag= 0.0 min

Primary outflow = Inflow, Time Span= 0.00-80.00 hrs, dt= 0.05 hrs

***APPENDIX G – SUPPLEMENTAL
CALCULATIONS***



1 Springfield Street
Suite 4
Chicopee, MA 01013
413.331.5326
www.BETA-Inc.com

JOB Uniroyal & Facemate ACOE

NO. 5100

CALC SLB

DATE 05/13/21

DESC Recharge and Water Quality Volume

SHEET 1 OF 2

Facemate System

Post-Development Impervious Area = **23261** sq. ft.
 Pre-Development Impervious Area = **23261** sq. ft.
 Net New Impervious Area = **0** sq. ft.
 Post-Development Roof Area = **6240** sq. ft.

Required Recharge Volume

Recharge Volume (R_V) Required = New Impervious Area x Runoff Depth (from HSG)

R_V (Urban Land*) = **0.00** sf. x **0.10** in x 0.083 ft/in = **0** cu. ft.

R_V Required = **0 cu. ft.**

Provided Recharge Volume

*Infiltration provided within basins anticipated to be collected via underdrain
 Therefore, no recharge volume provided.*

Required Water Quality Volume

Water Quality Volume (WQ_V) Required = Impervious Area x Runoff Depth (Excluding roof area)

WQ_V Required = **17,021** sf. x **0.5** in x 0.083 ft/in = **709** cu. ft.

WQ_V Required = **709 cu. ft.**

Provided Volumes

Volume Provided : Storage Volume below Lowest Invert

	Basin - CB-16B		Basin - CB-17B	
Invert Elev.	97.33	ft	97.33	ft
Storage Volume @ Invert	910	cu. ft.	955	cu. ft.
Bottom Surface Area (A_s)	2,945	sq. ft.	2,500	sq. ft.

Refer to HydroCAD model for determinaiton of storage volume

WQ_V Provided = **1,865 cu. ft.**

Time to Empty - Drawdown Time

Time to Drawdown = Volume below outlet / Infiltration Rate x Surface Area

Basin 1: T_D = **910 cf. / 0.0142** ft/hr x **2945** sq. ft. = **21.8 hrs**

Basin 2: T_D = **955 cf. / 0.0142** ft/hr x **2,500** sq. ft. = **26.9 hrs**

* Hydrologic Soil Goup (HSG) D assumed for urban land

**0.34 ft/day (0.17 in/hr) inf. rate based on Mass Stormwater Handbook

Uniroyal System

Post-Development Impervious Area* =	160783 sq. ft.
Pre-Development Impervious Area* =	191661
Net New Impervious Area =	-30878 sq. ft.
Post-Development Roof Area* =	94954 sq. ft.

Note: Areas do not include impervipus portions of Watershed 3S, which is beyond the limits of work

Required Recharge Volume

Recharge Volume (R_V) Required = New Impervious Area x Runoff Depth (from HSG)

R_V (Urban Land*) = **-30878** sf. x **0.10** in x 0.083 ft/in = **-257.32** cu. ft.

R_V Required = **-257 cu. ft.**

Provided Recharge Volume

*Infiltration provided within basins anticipated to be collected via underdrain
Therefore, no recharge volume provided.*

Required Water Quality Volume

Water Quality Volume (WQ_V) Required = Impervious Area x Runoff Depth (Excluding roof area)

WQ_V Required = **65,829** sf. x **0.5** in x 0.083 ft/in = **2743** cu. ft.

WQ_V Required = **2743 cu. ft.**

Provided Volumes

Volume Provided : Storage Volume below Lowest Invert

	Basin - CB-8A	Basin - CB-11A	Basin - CB-13A
Invert Elev.	97.33 ft	94.83 ft	94.83 ft
Storage Volume @ Invert	1,460 cu. ft.	945 cu. ft.	830 cu. ft.
Bottom Surface Area (A_s)	3000 sq. ft.	1720 sq. ft.	1580 sq. ft.

Refer to HydroCAD model for determinaiton of storage volume

WQ_V Provided = **3,235 cu. ft.**

Time to Empty - Drawdown Time

Time to Drawdown = Volume below outlet / Infiltration Rate x Surface Area

Basin 1: T_D =	1,460 cf. /	0.0142 ft/hr* x	3000 sq. ft. =	34.3 hrs
Basin 2: T_D =	945 cf. /	0.0142 ft/hr* x	1,720 sq. ft. =	38.8 hrs
Basin 3: T_D =	830 cf. /	0.0142 ft/hr* x	1,580 sq. ft. =	37.1 hrs

* Hydrologic Soil Goup (HSG) D assumed for urban land

**0.34 ft/day (0.17 in/hr) inf. rate based on Mass Stormwater Handbook

Capacities of Outlet Pipes
Project: Uniroyal & Facemate ACOE
Town: Chicopee, MA

Date: 5/13/2021
Job No. 5100
Calc. by: SLB

Facemate Drainage System

Mannings Formula

$$Q = VA = (1.49/n)(A)(r_H)^{4/3}(S)^{1/2}$$

n = roughness coefficient

A = cross section area

S = slope

r_H = hydraulic radius = A/P

P = wetted perimeter

Pipe - CB-17B to CB-16B (1RA)

$$Q=VA=(1.49/n)(A)(r_H)^{4/3}(S)^{1/2}$$

n = 0.012

A = 1.77 sf.

S = 0.0016 ft/ft

18 in HDPE

r_H 0.375

P 4.71

$Q_{FULL} = 4.56$ cfs

100-yr flow 4.55 cfs

$V_{FULL} = 2.58$

OK

Pipe - CB-16B to DM-14 (1R & 1RB)

$$Q=VA=(1.49/n)(A)(r_H)^{4/3}(S)^{1/2}$$

n = 0.012

A = 3.14 sf.

S = 0.0020 ft/ft

24 in HDPE

r_H 0.5

P 6.28

$Q_{FULL} = 10.99$ cfs

100-yr flow 10.88 cfs

$V_{FULL} = 3.50$

OK

Capacities of Outlet Pipes
 Project: Uniroyal & Facemate ACOE
 Town: Chicopee, MA

Date: 5/13/2021
 Job No. 5100
 Calc. by: SLB

Uniroyal Drainage System

Pipe - CB-8A Basin to CB-11A Basin (2Ra)

$$Q=VA=(1.49/n)(A)(r_H)^{4/3}(S)^{1/2} \quad \underline{18} \text{ in HDPE}$$

$$n = 0.012 \quad r_H = 0.375$$

$$A = 1.77 \text{ sf.} \quad P = 4.71$$

$$S = \underline{0.0035} \text{ ft/ft}$$

$$Q_{FULL} = \underline{6.75} \text{ cfs} \quad V_{FULL} = 3.82$$

$$100\text{-yr flow} = \underline{6.64} \text{ cfs} \quad \text{OK}$$

Pipe - CB-11A Basin to CB-13A Basin (2Rb)

$$Q=VA=(1.49/n)(A)(r_H)^{4/3}(S)^{1/2} \quad \underline{24} \text{ in HDPE}$$

$$n = 0.012 \quad r_H = 0.5$$

$$A = 3.14 \text{ sf.} \quad P = 6.28$$

$$S = \underline{0.0035} \text{ ft/ft}$$

$$Q_{FULL} = \underline{14.54} \text{ cfs} \quad V_{FULL} = 4.63$$

$$100\text{-yr flow} = \underline{14.45} \text{ cfs} \quad \text{OK}$$

Pipe - CB-13A Basin to DMH-14 (2Rc)

$$Q=VA=(1.49/n)(A)(r_H)^{4/3}(S)^{1/2} \quad \underline{30} \text{ in HDPE}$$

$$n = 0.012 \quad r_H = 0.625$$

$$A = 4.91 \text{ sf.} \quad P = 7.85$$

$$S = \underline{0.0025} \text{ ft/ft}$$

$$Q_{FULL} = \underline{22.28} \text{ cfs} \quad V_{FULL} = 4.54$$

$$100\text{-yr flow} = \underline{21.50} \text{ cfs} \quad \text{OK}$$

Pipe - DMH-14A to DMH-17 (2R)

$$Q=VA=(1.49/n)(A)(r_H)^{4/3}(S)^{1/2} \quad \underline{30} \text{ in HDPE}$$

$$n = 0.012 \quad r_H = 0.625$$

$$A = 4.91 \text{ sf.} \quad P = 7.85$$

$$S = \underline{0.0032} \text{ ft/ft}$$

$$Q_{FULL} = \underline{25.20} \text{ cfs} \quad V_{FULL} = 5.13$$

$$100\text{-yr flow} = \underline{23.2} \text{ cfs} \quad \text{OK}$$

Capacities of Outlet Pipes
 Project: Uniroyal & Facemate ACOE
 Town: Chicopee, MA

Date: 5/13/2021
 Job No. 5100
 Calc. by: SLB

Find Min Slope to Provide Self Cleaning Velocities (2.0 ft/s)

$Q=VA=(1.49/n)(A)(r_H)^{4/3}(S)^{1/2}$ 15 in HDPE
 HALF FULL n = 0.012 r_H = 0.313
 A = 0.61 sf. P = 1.96
 S = 0.0012 ft/ft

HALF FULL Q_{FULL} = 1.22 cfs V_{FULL} = 1.98 OK

$Q=VA=(1.49/n)(A)(r_H)^{4/3}(S)^{1/2}$ 18 in HDPE
 HALF FULL n = 0.012 r_H = 0.375
 A = 0.88 sf. P = 2.36
 S = 0.001 ft/ft

HALF FULL Q_{FULL} = 1.80 cfs V_{FULL} = 2.04 OK

$Q=VA=(1.49/n)(A)(r_H)^{4/3}(S)^{1/2}$ 24 in HDPE
 HALF FULL n = 0.012 r_H = 0.500
 A = 1.57 sf. P = 3.14
 S = 0.0007 ft/ft

HALF FULL Q_{FULL} = 3.25 cfs V_{FULL} = 2.07 OK

$Q=VA=(1.49/n)(A)(r_H)^{4/3}(S)^{1/2}$ 30 in HDPE
 HALF FULL n = 0.012 r_H = 0.625
 A = 2.45 sf. P = 3.93
 S = 0.0005 ft/ft

HALF FULL Q_{FULL} = 4.98 cfs V_{FULL} = 2.03 OK

INSTRUCTIONS:

1. In BMP Column, click on Blue Cell to Activate Drop Down Menu
2. Select BMP from Drop Down Menu
3. After BMP is selected, TSS Removal and other Columns are automatically completed.

Version 1, Automated: Mar. 4, 2008

Location: Stormwater Basins (Facemate and Uniroyal)

	B	C	D	E	F
	BMP ¹	TSS Removal Rate ¹	Starting TSS Load*	Amount Removed (C*D)	Remaining Load (D-E)
TSS Removal Calculation Worksheet	Sediment Forebay	0.25	1.00	0.25	0.75
	Deep Sump and Hooded Catch Basin	0.25	0.75	0.19	0.56
		0.00	0.56	0.00	0.56
		0.00	0.56	0.00	0.56
		0.00	0.56	0.00	0.56

Total TSS Removal = 44%

Separate Form Needs to be Completed for Each Outlet or BMP Train

Project: Facemate and Uniroyal ACOE
 Prepared By: SLB
 Date: 5/13/2021

*Equals remaining load from previous BMP (E) which enters the BMP

Non-automated TSS Calculation Sheet must be used if Proprietary BMP Proposed
 1. From MassDEP Stormwater Handbook Vol. 1



NOAA Atlas 14, Volume 10, Version 3
Location name: Chicopee, Massachusetts, USA*
Latitude: 42.1547°, Longitude: -72.5856°
Elevation: 130.77 ft**



* source: ESRI Maps
 ** source: USGS

POINT PRECIPITATION FREQUENCY ESTIMATES

Sanja Perica, Sandra Pavlovic, Michael St. Laurent, Carl Trypaluk, Dale Unruh, Orlan Wilhite

NOAA, National Weather Service, Silver Spring, Maryland

[PF_tabular](#) | [PF_graphical](#) | [Maps & aerials](#)

PF tabular

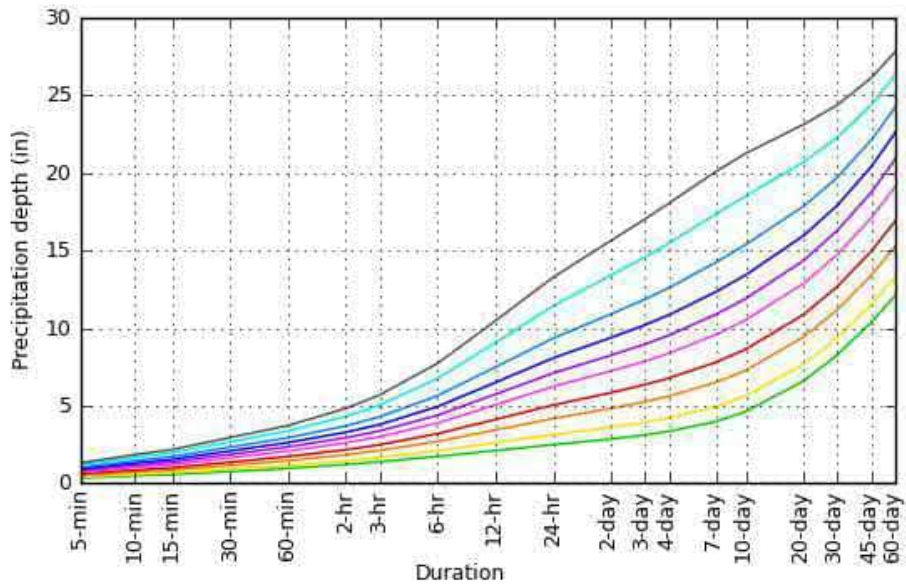
PDS-based point precipitation frequency estimates with 90% confidence intervals (in inches)¹										
Duration	Average recurrence interval (years)									
	1	2	5	10	25	50	100	200	500	1000
5-min	0.333 (0.257-0.427)	0.400 (0.308-0.514)	0.510 (0.391-0.657)	0.601 (0.459-0.779)	0.726 (0.537-0.986)	0.821 (0.596-1.14)	0.919 (0.648-1.33)	1.03 (0.689-1.53)	1.18 (0.763-1.82)	1.30 (0.823-2.05)
10-min	0.472 (0.364-0.605)	0.567 (0.437-0.728)	0.722 (0.554-0.931)	0.851 (0.650-1.10)	1.03 (0.761-1.40)	1.16 (0.843-1.62)	1.30 (0.918-1.88)	1.46 (0.977-2.16)	1.67 (1.08-2.58)	1.84 (1.17-2.91)
15-min	0.555 (0.428-0.712)	0.667 (0.514-0.856)	0.850 (0.652-1.10)	1.00 (0.764-1.30)	1.21 (0.895-1.64)	1.37 (0.993-1.90)	1.53 (1.08-2.21)	1.71 (1.15-2.54)	1.97 (1.27-3.03)	2.17 (1.37-3.42)
30-min	0.751 (0.579-0.963)	0.903 (0.695-1.16)	1.15 (0.883-1.48)	1.36 (1.04-1.76)	1.64 (1.21-2.23)	1.85 (1.35-2.58)	2.08 (1.46-3.00)	2.32 (1.56-3.45)	2.66 (1.73-4.11)	2.94 (1.86-4.64)
60-min	0.947 (0.730-1.21)	1.14 (0.877-1.46)	1.45 (1.11-1.87)	1.71 (1.31-2.22)	2.07 (1.53-2.81)	2.34 (1.70-3.25)	2.62 (1.85-3.78)	2.93 (1.97-4.35)	3.36 (2.18-5.19)	3.71 (2.35-5.86)
2-hr	1.21 (0.940-1.54)	1.45 (1.12-1.84)	1.83 (1.42-2.34)	2.15 (1.66-2.77)	2.60 (1.94-3.51)	2.93 (2.15-4.06)	3.28 (2.34-4.74)	3.69 (2.49-5.45)	4.30 (2.79-6.60)	4.82 (3.06-7.55)
3-hr	1.38 (1.08-1.75)	1.66 (1.30-2.10)	2.11 (1.64-2.67)	2.48 (1.92-3.17)	2.99 (2.25-4.03)	3.37 (2.49-4.66)	3.78 (2.72-5.47)	4.28 (2.89-6.30)	5.04 (3.28-7.70)	5.69 (3.62-8.89)
6-hr	1.72 (1.36-2.16)	2.09 (1.65-2.62)	2.69 (2.11-3.39)	3.19 (2.49-4.04)	3.88 (2.95-5.20)	4.38 (3.27-6.05)	4.94 (3.60-7.16)	5.64 (3.83-8.25)	6.75 (4.41-10.3)	7.72 (4.93-12.0)
12-hr	2.10 (1.68-2.61)	2.61 (2.07-3.24)	3.43 (2.72-4.28)	4.11 (3.24-5.16)	5.05 (3.87-6.74)	5.73 (4.32-7.88)	6.49 (4.79-9.40)	7.48 (5.10-10.9)	9.07 (5.93-13.7)	10.5 (6.70-16.2)
24-hr	2.48 (2.00-3.05)	3.12 (2.51-3.84)	4.17 (3.34-5.15)	5.04 (4.01-6.27)	6.23 (4.82-8.27)	7.10 (5.40-9.71)	8.07 (6.01-11.6)	9.35 (6.40-13.5)	11.4 (7.51-17.2)	13.3 (8.52-20.4)
2-day	2.85 (2.31-3.47)	3.60 (2.92-4.39)	4.82 (3.89-5.91)	5.84 (4.69-7.20)	7.23 (5.65-9.53)	8.25 (6.32-11.2)	9.39 (7.05-13.5)	10.9 (7.50-15.7)	13.4 (8.84-20.0)	15.6 (10.1-23.9)
3-day	3.11 (2.54-3.77)	3.93 (3.20-4.76)	5.25 (4.27-6.40)	6.35 (5.13-7.79)	7.87 (6.17-10.3)	8.96 (6.91-12.1)	10.2 (7.69-14.6)	11.9 (8.17-17.0)	14.6 (9.63-21.7)	17.0 (11.0-25.9)
4-day	3.35 (2.74-4.04)	4.21 (3.44-5.08)	5.61 (4.58-6.81)	6.77 (5.49-8.28)	8.38 (6.59-10.9)	9.54 (7.37-12.9)	10.9 (8.20-15.5)	12.6 (8.70-18.0)	15.5 (10.2-23.0)	18.1 (11.7-27.4)
7-day	3.98 (3.29-4.76)	4.93 (4.07-5.92)	6.50 (5.34-7.83)	7.79 (6.37-9.46)	9.58 (7.58-12.4)	10.9 (8.44-14.5)	12.3 (9.33-17.4)	14.2 (9.88-20.2)	17.3 (11.5-25.6)	20.1 (13.0-30.3)
10-day	4.61 (3.83-5.49)	5.62 (4.66-6.70)	7.27 (6.00-8.71)	8.63 (7.09-10.4)	10.5 (8.35-13.5)	11.9 (9.24-15.8)	13.4 (10.1-18.8)	15.4 (10.7-21.7)	18.5 (12.3-27.2)	21.3 (13.8-32.0)
20-day	6.59 (5.53-7.79)	7.67 (6.42-9.07)	9.42 (7.86-11.2)	10.9 (9.01-13.0)	12.9 (10.3-16.3)	14.4 (11.2-18.7)	16.0 (12.0-21.8)	17.9 (12.5-25.0)	20.7 (13.9-30.2)	23.1 (15.0-34.6)
30-day	8.27 (6.98-9.72)	9.38 (7.90-11.0)	11.2 (9.38-13.2)	12.7 (10.6-15.1)	14.7 (11.8-18.4)	16.3 (12.7-20.9)	17.9 (13.4-24.0)	19.7 (13.9-27.4)	22.3 (15.0-32.3)	24.4 (15.9-36.3)
45-day	10.4 (8.80-12.1)	11.5 (9.76-13.5)	13.4 (11.3-15.7)	15.0 (12.5-17.7)	17.1 (13.7-21.2)	18.8 (14.6-23.8)	20.4 (15.3-27.0)	22.1 (15.7-30.6)	24.4 (16.4-35.2)	26.1 (17.1-38.8)
60-day	12.1 (10.3-14.1)	13.3 (11.3-15.5)	15.3 (12.9-17.9)	16.9 (14.2-19.9)	19.1 (15.4-23.6)	20.9 (16.3-26.4)	22.6 (16.9-29.6)	24.2 (17.2-33.4)	26.3 (17.8-37.9)	27.8 (18.2-41.2)

¹ Precipitation frequency (PF) estimates in this table are based on frequency analysis of partial duration series (PDS). Numbers in parenthesis are PF estimates at lower and upper bounds of the 90% confidence interval. The probability that precipitation frequency estimates (for a given duration and average recurrence interval) will be greater than the upper bound (or less than the lower bound) is 5%. Estimates at upper bounds are not checked against probable maximum precipitation (PMP) estimates and may be higher than currently valid PMP values. Please refer to NOAA Atlas 14 document for more information.

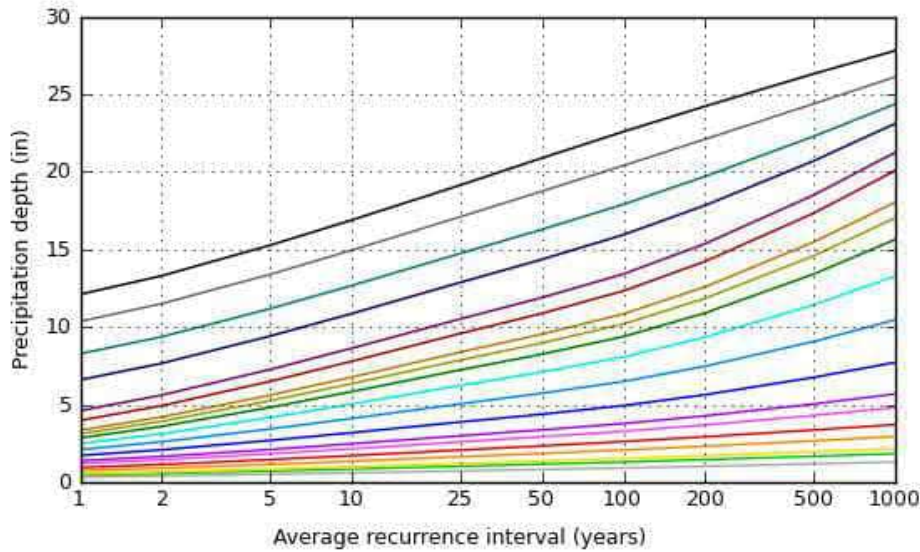
[Back to Top](#)

PF graphical

PDS-based depth-duration-frequency (DDF) curves
 Latitude: 42.1547°, Longitude: -72.5856°



Average recurrence interval (years)
1
2
5
10
25
50
100
200
500
1000



Duration
5-min
10-min
15-min
30-min
60-min
2-hr
3-hr
6-hr
12-hr
24-hr
2-day
3-day
4-day
7-day
10-day
20-day
30-day
45-day
60-day

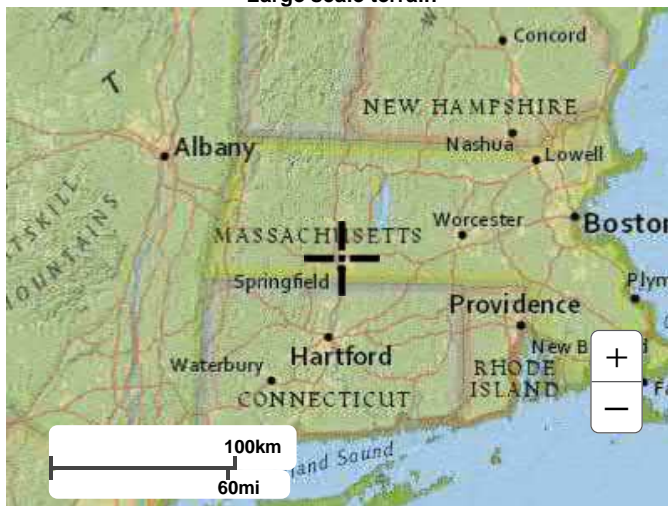
[Back to Top](#)

Maps & aerials

Small scale terrain



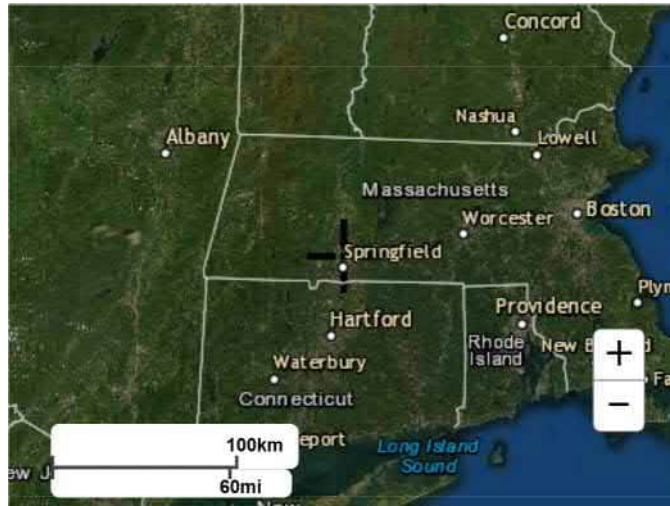
Large scale terrain



Large scale map



Large scale aerial

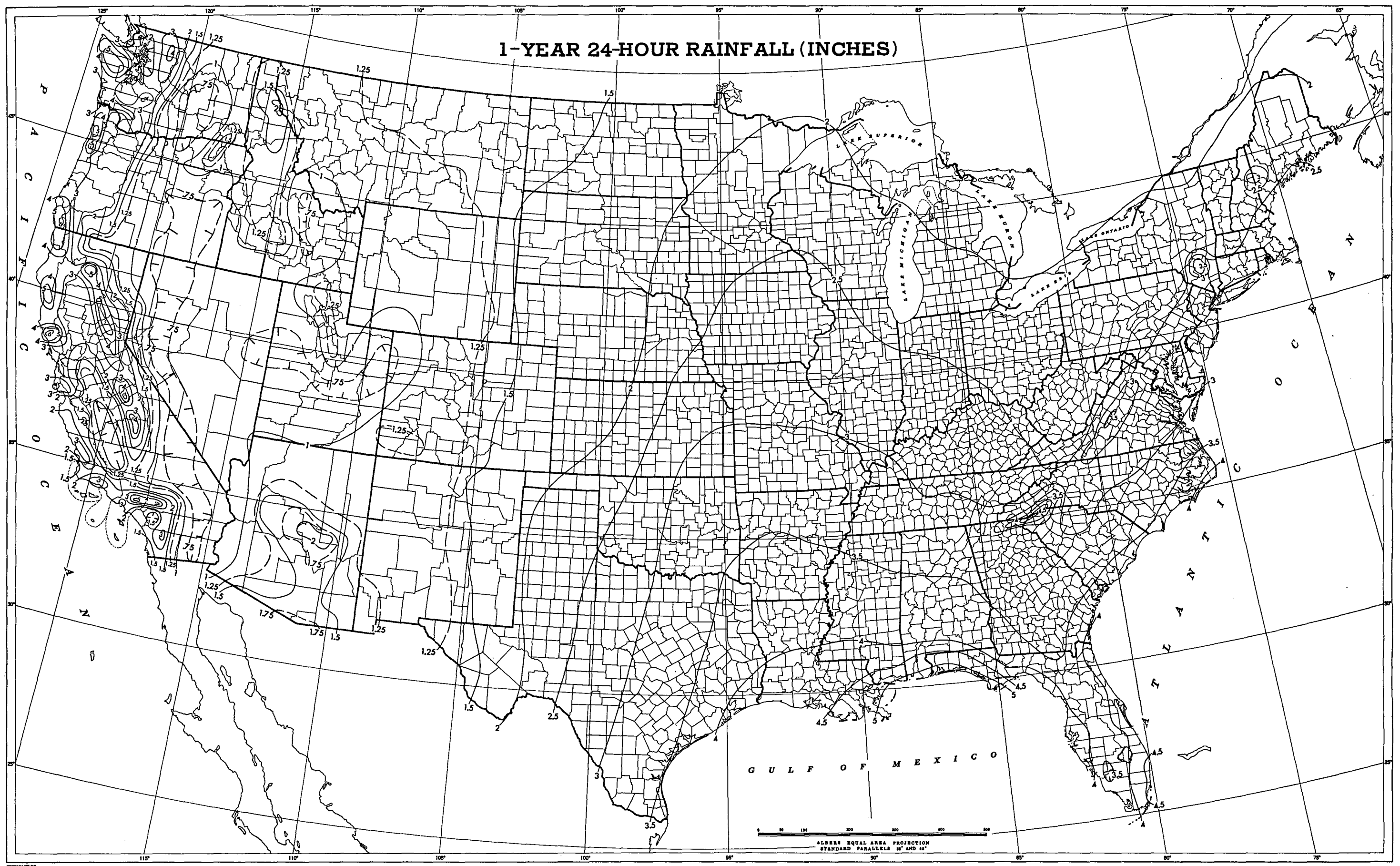


[Back to Top](#)

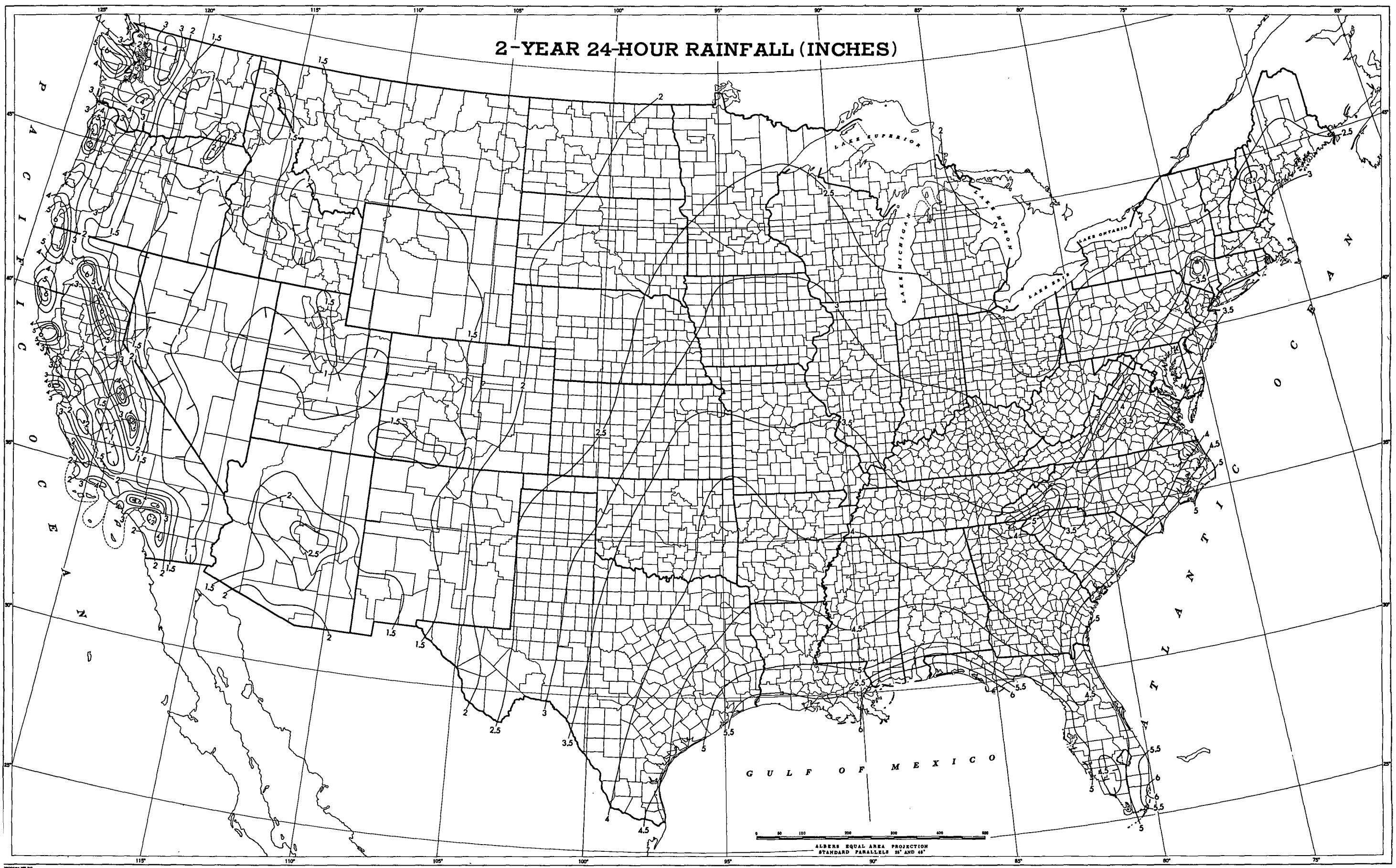
[US Department of Commerce](#)
[National Oceanic and Atmospheric Administration](#)
[National Weather Service](#)
[National Water Center](#)
1325 East West Highway
Silver Spring, MD 20910
Questions?: HDSC.Questions@noaa.gov

[Disclaimer](#)

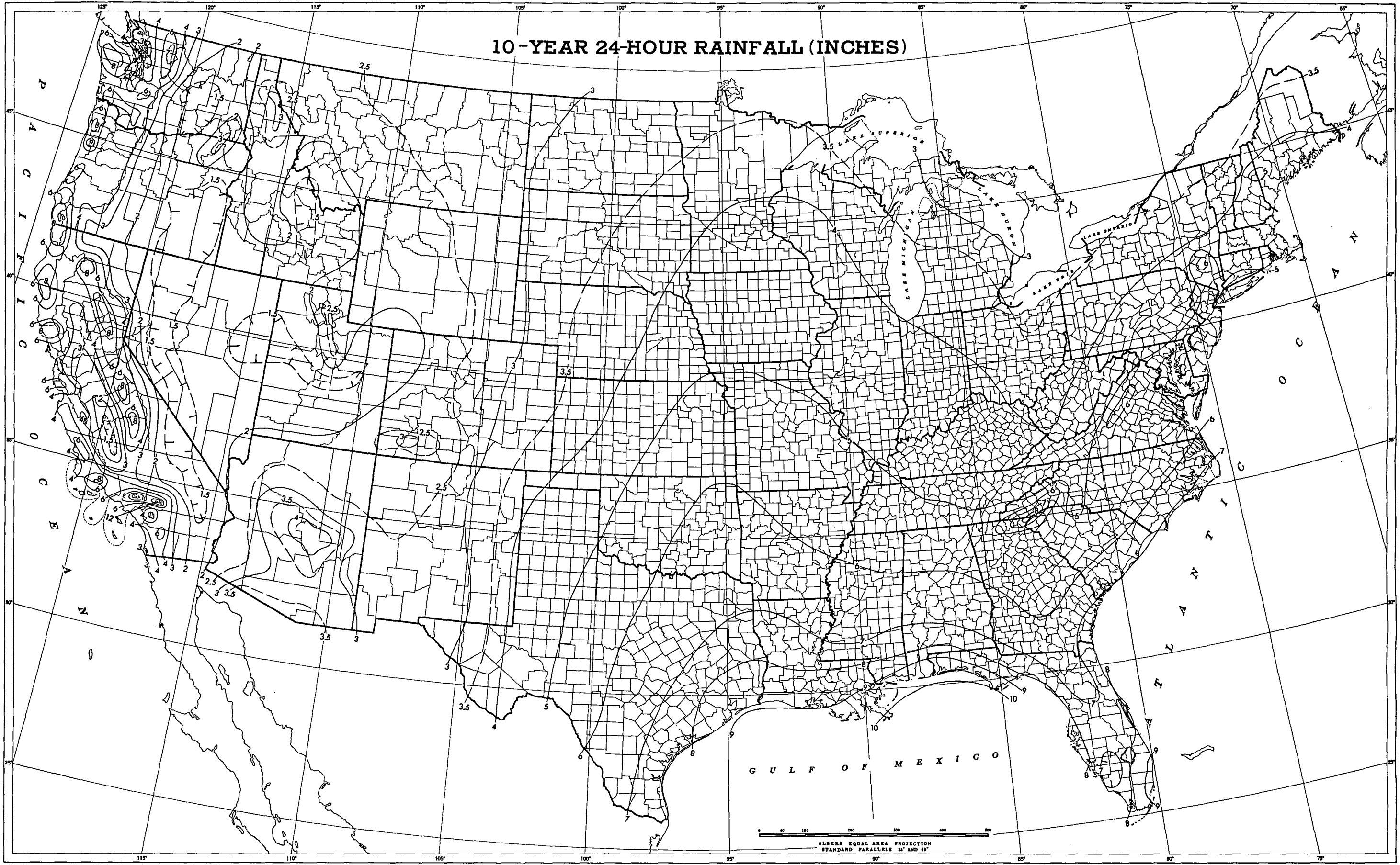
1-YEAR 24-HOUR RAINFALL (INCHES)



2-YEAR 24-HOUR RAINFALL (INCHES)

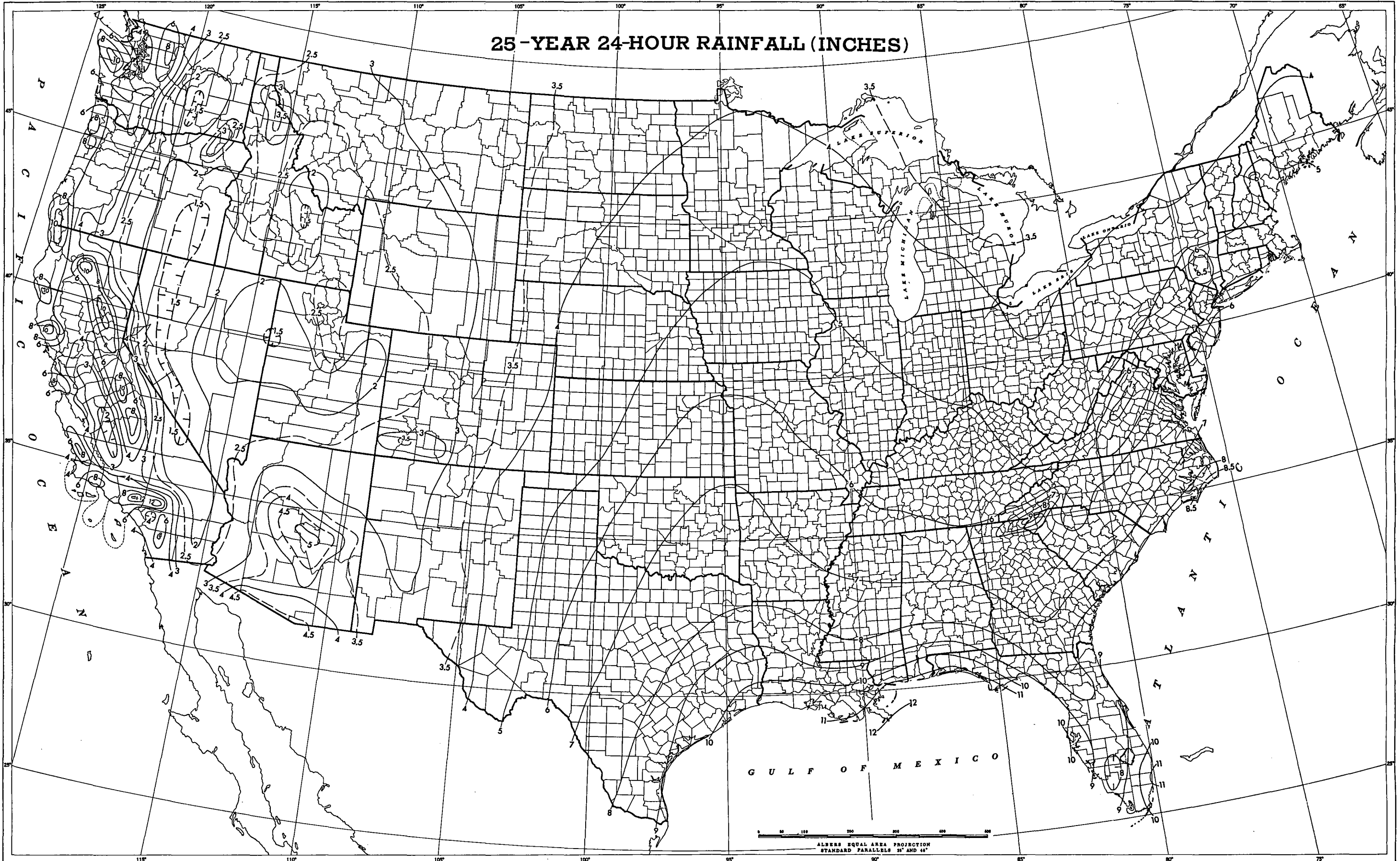


10-YEAR 24-HOUR RAINFALL (INCHES)

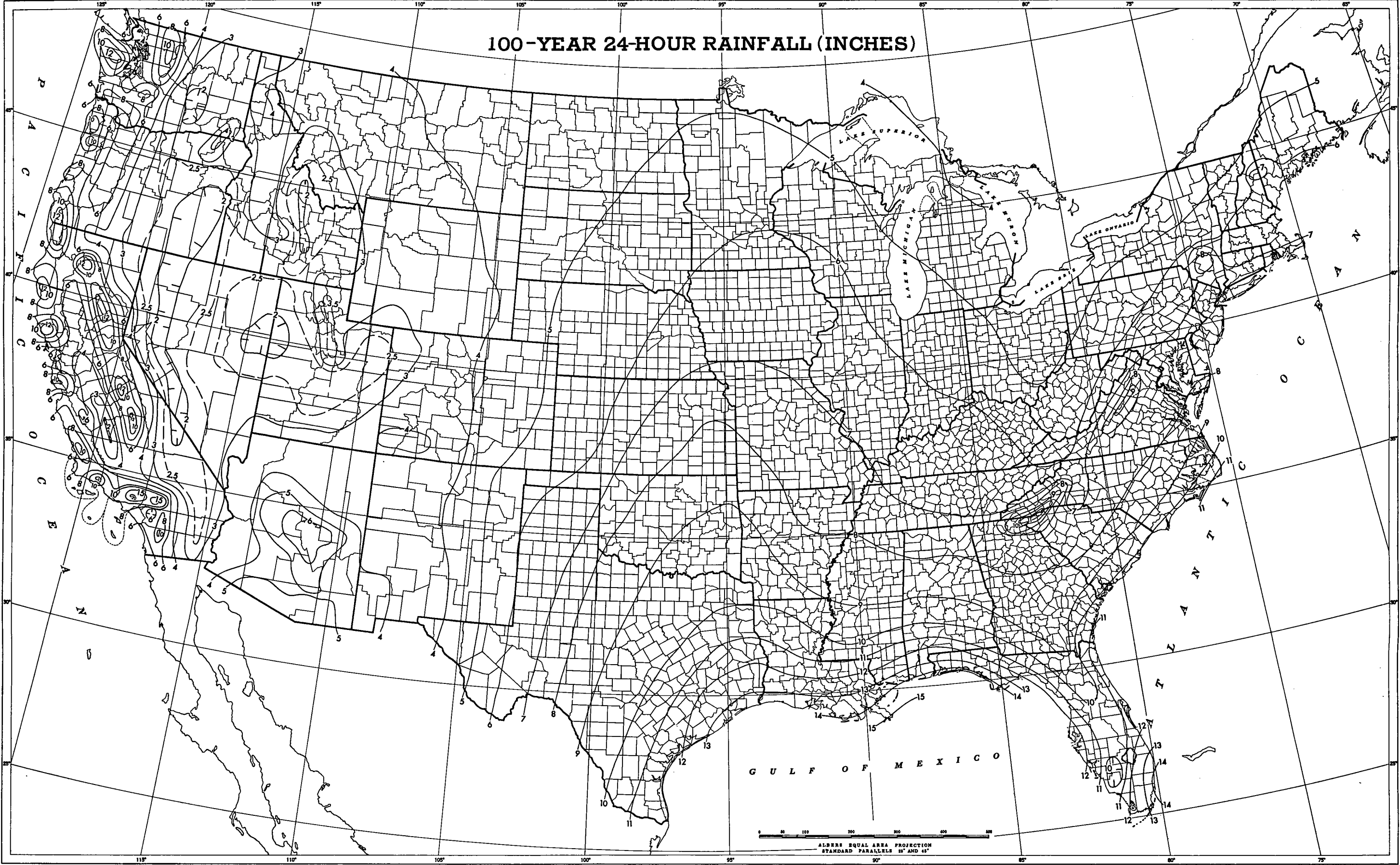


0 50 100 200 300 400 500
ALBERS EQUAL AREA PROJECTION
STANDARD PARALLELS 15° AND 45°

25-YEAR 24-HOUR RAINFALL (INCHES)



100-YEAR 24-HOUR RAINFALL (INCHES)



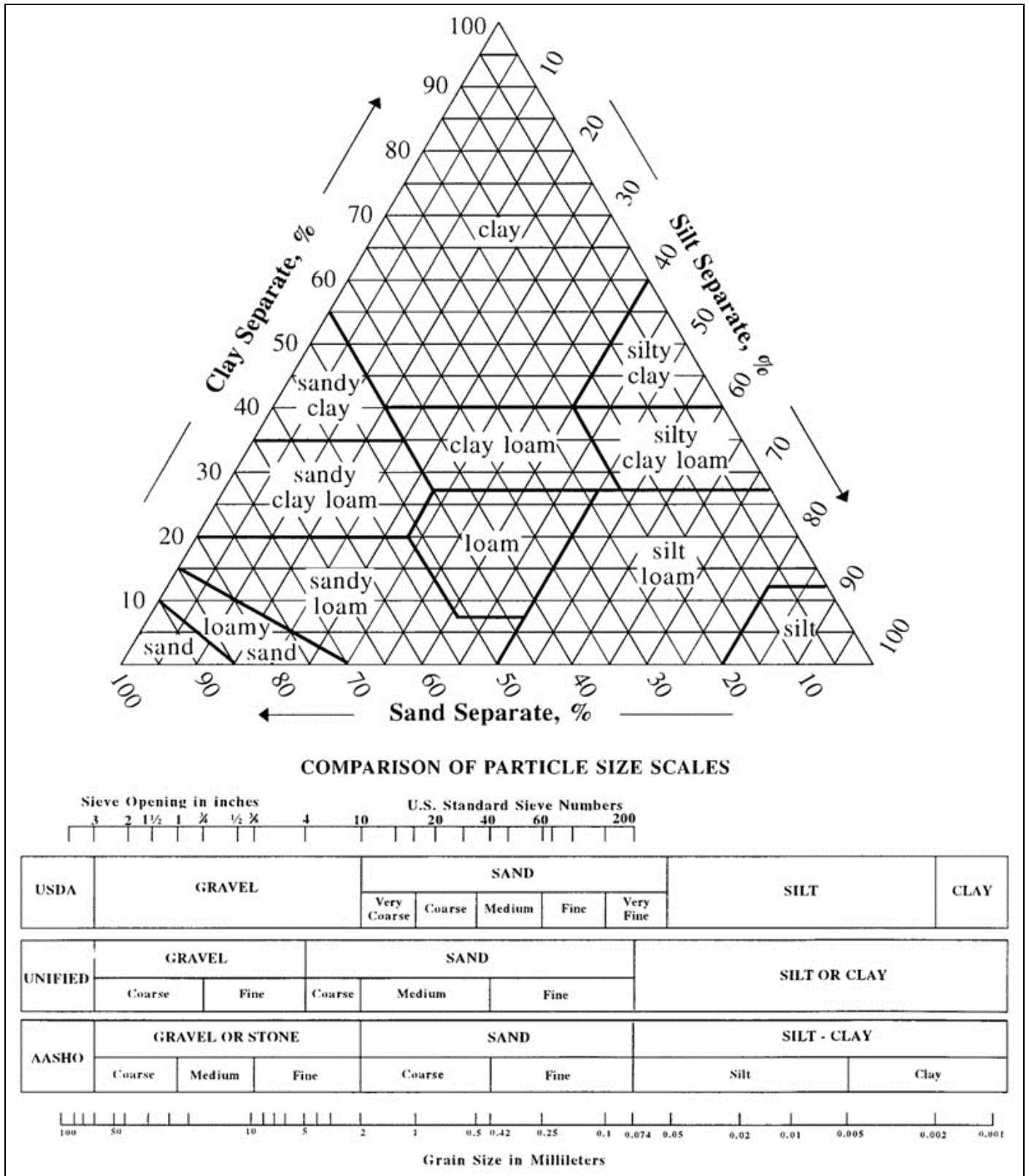


Figure 2.3.2: USDA, NRCS, 2007 National Soil Survey Handbook, Part 618, Exhibit 8, <http://soils.usda.gov/technical/handbook/contents/part618ex.html#ex8>

Table 2.3.3. 1982 Rawls Rates¹⁸

Texture Class	NRCS Hydrologic Soil Group (HSG)	Infiltration Rate Inches/Hour
Sand	A	8.27
Loamy Sand	A	2.41
Sandy Loam	B	1.02
Loam	B	0.52
Silt Loam	C	0.27
Sandy Clay Loam	C	0.17
Clay Loam	D	0.09
Silty Clay Loam	D	0.06
Sandy Clay	D	0.05
Silty Clay	D	0.04
Clay	D	0.02

¹⁸ Rawls, Brakensiek and Saxton, 1982



BETA

1 Springfield Street
Suite 4
Chicopee, MA 01013
413.331.5326
www.BETA-Inc.com