

Taunton, Massachusetts

Main Lift Pumping Station Improvements

Contract No. S-2022-2, CWSRF No. 6832

March 31, 2022

Bidding Requirements, Bond Forms, Contract Agreement, Conditions of the Contract and Technical Specifications

Bid Package #1 – General Bid

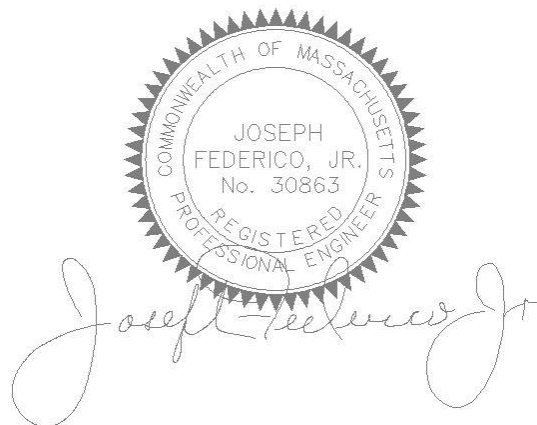

Professional Registration No.: 30863



www.BETA-Inc.com

(THIS PAGE INTENTIONALLY LEFT BLANK)

INDEX OF CONTENTS

BIDDING REQUIREMENTS AND CONTRACT FORMS

<u>Document</u>	<u>Title</u>	<u>Page to Page</u>
00100	Invitation to Bid	00100-1 to 00100-3
00200	Instruction To Bidders	00200-1 to 00200-4
00300	Bid Form	00300-1 to 00300-6
00500	Contract Agreement	00500-1 to 00500-88

DIVISION 1 GENERAL REQUIREMENTS

<u>Document</u>	<u>Title</u>	<u>Page to Page</u>
01010	Summary of Work	01010-1 to 01010-4
01020	Allowances	01020-1 to 10120-2
01025	Measurement & Payment	01025-1 to 01025-5
01026	Schedule of Values	01026-1
01035	Modification Procedure	01035-1 to 01035-2
01040	Coordination	01040-1
01045	Cutting, Coring and Patching	01045-1 to 01045-3
01050	Field Engineering	01050-1 to 01050-2
01060	Regulatory Requirements (Massachusetts)	01060-1 to 01060-2
01067	State of Massachusetts and Federal Requirements	01067-1 to 01067-end
01069	Health and Safety Requirements	01069-1 to 01069-3
01090	Reference Standards	01090-1 to 01090-5
01170	Environmental Protection	01170-1 to 01170-5
01200	Project Meetings	01200-1
01300	Submittals	01300-1 to 01300-3
01310	Construction Progress Schedule	01310-1 to 01310-4
01400	Quality Control	01400-1 to 01400-2
01410	Testing Laboratory Services	01410-1 to 01410-2
01510	Temporary Utilities	01510-1 to 01510-2
01525	Temporary Enclosures	01525-1
01560	Temporary Controls	01560-1 to 01560-3
01570	Traffic Regulations	01570-1 to 01570-2
01590	Field Office	01590-1 to 01590-2
01600	Materials and Equipment	01600-1 to 01600-2
01631	Use of Other than First Named Manufacturers	01631-1 to 01631-2
01665	Service of Manufacturer's Representatives	01655-1 to 01655-7
01680	Equipment Checkout, Certifications, and Testing	01680-1 to 01680-5
01700	Contract Closeout	01700-1 to 01700-4
01710	Start-Up	01710-1 to 01710-3
01730	Operation and Maintenance Manuals	01730-1 to 01730-3
01740	Warranties	01740-1 to 01740-2
01750	Spare Parts	01750-1 to 01750-2

01751	Lubricants	01750-1
01800	Maintenance	01800-1 to 01800-2
01810	Maintenance of Plant Operation and Sequence of Construction	01810-1 to 01810-4

DIVISION 2
SITE WORK

<u>Document</u>	<u>Title</u>	<u>Page to Page</u>
02050	Demolition	02050-1 to 02050-3
02080	Management of Contaminated Materials	02080-1 to 02080-8
02100	Site Preparation	02100-1 to 02100-4
02140	Dewatering	02140-1 to 02140-6
02160	Excavation Support	02160-1 to 02160-10
02200	Earth Excavation, Backfill, Fill and Grading	02200-1 to 02200-10
02210	Rock Excavation	02210-1 to 02210-3
02215	Aggregate Materials	02215-1 to 02215-3
02220	Riprap	02220-1 to 02220-3
02224MA	Controlled Density Fill (Massachusetts)	02224-1 to 02224-4
02272	Geotextile Materials	02272-1 to 02272-4
02277	Straw Wattles	02277-1 to 02277-2
02500MA	Pavement	02500-1 to 02500-6
02618	Ductile Iron Pipe and Fittings for Buried Service	02618-1 to 02618-11
02629	Underground Utility Marking Tape	02629-1 to 02629-2
02642	Water Service Connections	02642-1 to 02642-4
02769	Disposal of Materials	02769-1 to 02769-2
02831	Chain Link Fence and Gates	02831-1 to 02831-7
02930	Loaming and Seeding	02930-1 to 02930-3

DIVISION 3
CONCRETE

<u>Document</u>	<u>Title</u>	<u>Page to Page</u>
03100	Concrete Formwork	03100-1 to 03100-6
03200	Concrete Reinforcement	03200-1 to 03200-7
03250	Expansion Construction and Control Joints	03250-1 to 03250-8
03300	Cast-In-Place Concrete	03300-1 to 03300-11
03320	Concrete Sealant	03320-1 to 03320-4
03604	Non-Shrink Construction Grout	03604-1 to 03604-3

DIVISION 4
MASONRY

<u>Document</u>	<u>Title</u>	<u>Page to Page</u>
04100	Mortar and Masonry Grout	04100-1 to 04100-4
04200	Unit Masonry	04200-1 to 04200-19
04230	Reinforced Unit Masonry	04320-1 to 04320-4
04930	Masonry and Stucco Cleaning	04930-1 to 04930-3

DIVISION 5
METALS

<u>Document</u>	<u>Title</u>	<u>Page to Page</u>
05120	Structural Steel Framing	05120-1 to 05120-11
05500	Metal Fabrications	05500-1 to 05500-16
05510	Aluminum Stairs and Ladders	05510-1 to 05510-5
05520	Aluminum Handrails and Railings	05520-1 to 05520-4
05530	Metal Grating	05530-1 to 05521-5

DIVISION 6
ROUGH CARPENTRY

<u>Document</u>	<u>Title</u>	<u>Page to Page</u>
06100	Rough Carpentry	06100-1 to 06100-5
06402	Interior Architectural Woodwork	06402-1 to 06402-5

DIVISION 7
THERMAL AND MOISTURE PROTECTION

<u>Document</u>	<u>Title</u>	<u>Page to Page</u>
07130	Waterproofing	07130-1 to 07130-4
07180	Traffic Coatings	07180-1 to 07180-7
07210	Thermal Insulation	07210-1 to 07210-5
07270	Air Barriers	07270-1 to 07270-11
07530	Single Ply Membrane Roofing	07530-1 to 07530-12
07620	Sheet Metal Flashing and Trim	07620-1 to 07620-7
07841	Penetration Fire Stopping	07841-1 to 07841-7
07844	Fire Resistive Joint Systems	07844-1 to 07844-7
07920	Joint Sealants	07920-1 to 07920-9

DIVISION 8
DOORS AND WINDOWS

<u>Document</u>	<u>Title</u>	<u>Page to Page</u>
08101	Fiberglass Doors and Frames	08111-1 to 08111-3
08311	Access Doors and Frames	08311-1 to 08311-5
08511	Aluminum Windows	08511-1 to 08511-9
08800	Glazing	08800-1 to 08800-5

DIVISION 9
FINISHES

<u>Document</u>	<u>Title</u>	<u>Page to Page</u>
09211	Gypsum Board Assemblies	09211-1 to 09211-13
09651	Resilient Wall Base and Accessories	09651-1 to 09651-3
09900	Painting and Coating	09900-1 to 09900-16

DIVISION 10
SPECIALTIES

<u>Document</u>	<u>Title</u>	<u>Page to Page</u>
10140	Signage	10140-1 to 10140-4
10280	Toilet Accessories	10280-1 to 10280-3
10410	Emergency Access and Information Cabinets	10410-1 to 10410-3
10440	Fire Protection Specialties	10440-1 to 10440-3

DIVISION 11
EQUIPMENT

<u>Document</u>	<u>Title</u>	<u>Page to Page</u>
11282	Stainless Steel Sluice Gate and Appurtenances	11282-1 to 11282-16
11310	Sewage Pump and Appurtenances	11310-1 to 11310-13
11330	Large Bubble Mixing system	11330-1 to 11330-6

DIVISION 12

<u>Document</u>	<u>Title</u>	<u>Page to Page</u>
12481	Entrance floor Mats	12481-1 to 12481-2

DIVISION 13
SPECIAL CONSTRUCTION

<u>Document</u>	<u>Title</u>	<u>Page to Page</u>
13300	Instrumentation and Controls	17300-1 to 17300-53

DIVISION 14
CONVEYING SYSTEMS

<u>Document</u>	<u>Title</u>	<u>Page to Page</u>
14600	Hoisting Equipment	14600-1 to 14600-5

DIVISION 15
MECHANICAL

<u>Document</u>	<u>Title</u>	<u>Page to Page</u>
15050	Pipe Penetrations	15050-1 to 15050-2
15060	Process Piping	15060-1 to 15060-14
15070	Ductile Iron Pipe and Fittings	15070-1 to 15070-10
15100	Valves, Gates, and Appurtenances	15100-1 to 15100-14

15130	Gauges	15150-1 to 15150-3
15140	Pipe Hangers and Supports	15140-1 to 15140-10
15400	Plumbing	15400-1 to 15400-20
15500	Heating Ventilation and Air Conditioning	15500-1 to 15500-37

DIVISION 16
ELECTRICAL

<u>Document</u>	<u>Title</u>	<u>Page to Page</u>
16000	Basic Electrical Requirements	16000-1 to 16000-11
16060	Grounding Systems	16060-1 to 16060-4
16080	Underground Systems	16080-1 to 16080-3
16085	Miscellaneous Equipment	16085-1 to 16085-11
16120	Wires And Cables	16120-1 to 16120-4
16130	Raceways and Fittings	16130-1 to 16130-8
16442	Panelboards	16442-1 to 16442-4
16495	Variable Frequency Drives	16495-1 to 16495-6
16500	Lighting Systems	16500-1 to 16500-4
16612	Engine Generator	16612-1 to 16612-12
16720	Security Alarm Systems	16720-1 to 16720-8

APPENDICES

APPENDIX 1	Geotechnical Report
APPENDIX 2	Conservation Commission Order of Conditions
APPENDIX 3	Limited subsurface Investigation Report
APPENDIX 4	Taunton WWTF Industrial Pre-treatment Discharge Limits
APPENDIX 5	Supplemental Environmental Information

DIVISION 00

(THIS PAGE INTENTIONALLY LEFT BLANK)

SECTION 00100

INVITATION TO BID

CITY OF TAUNTON, MA MAIN LIFT PUMPING STATION IMPROVEMENTS CONTRACT S-2022-2 CWSRF NO. 6832

On behalf of the City of Taunton, MA (“City” or “Owner”), Veolia Water North America-Northeast, LLC (“Veolia” or “Company”) is seeking bids for **Main Lift Pumping Station Improvements, project**. Veolia has prequalified firms interested in submitting bids for this project. Only prequalified firms will be permitted to submit bids.

Schedule of Events:

	Event / Activity	Action Required	Deadline
1	Veolia distributes Bidding Documents		March 31, 2022
2	Bidders Submit Questions	Submit questions to Carl Hendrickson carl.hendrickson@veolia.com NOTE: Veolia will provide answers to questions and distribute to all participating bidders	April 18, 2022
3	Submission of Bids	Send your Bids to Veolia via email: carl.hendrickson@veolia.com	4:00pm EDT April 28, 2022

Sealed Bids for the construction of the Main Lift Pumping Station Improvements project shall be sent to Carl Hendrickson, via electronic mail, at carl.hendrickson@veolia.com. All bids must be received by 4:00 PM, April 28, 2022 in Portable Document Format (PDF).

The following documents must be included with the Bid Form:

- Appendix A1 - Certification Statement
- Appendix B - Diesel Retrofit Program - Statement of Intent to Comply
- Bid Bond

The subject line of the email submittal should read:

BID - Taunton Main Lift Pumping Station Improvements, CWSRF 6832.

The work in this Contract includes, but is not limited to:

Bid Package #1 – General

Bid Package #1 consists of all work not included in Packages #2-#3, including:

- Installation of influent sewer connection and site improvements
- New pumps, piping, electrical and instrumentation associated with a new dry pit / wet pit sewage pumping station (pumps to be purchased under Bid Package #3)
- New standby generator and plumbing, heating and ventilation systems.
- New above grade masonry block structure with brick facade
- Startup of new equipment, demonstration of control strategies, and activation of new pumping station
- Electrical work as shown in the contract documents - Electrical drawings and Specifications Division 16
- Install instrumentation and control panels furnished under Division 13 and Division 11

Bid Package #2 – Instrumentation and Control Procurement

- Furnish and program Instrumentation and control equipment as shown in the Contract Documents – Instrumentation drawings and Specifications Division 17

Bid Package #3 – Sewage Pumps Procurement

- Furnish dry pit submersible pumps and appurtenances for wastewater pumping as specified in Specification Section 11310.

Additional tasks and details for the work are specified in the Contract Documents, and provided in the Construction Agreement, Exhibit A - Scope of Work.

The Subcontractor shall complete all work required under the Contract within 455 calendar days after the date of the Notice of Award. Work performed beyond the completion date will be subjected to liquidated damages in the amount specified herein.

A pre-bid conference will not be scheduled. Subcontractors can schedule site visits by contacting Carl Hendrickson at (617) 999-8716. Veolia will transmit to all prospective Bidders of record such Addenda as Veolia considers necessary in response to questions. Oral statements may not be relied upon and will not be binding or legally effective.

A .pdf copy of the Contract Documents for the Work may be obtained from the office of Veolia by contacting Carl Hendrickson at (617) 999-8716, carl.hendrickson@veolia.com. Hard copies will not be provided. The Contract Documents may be examined during normal business hours from 7:00 a.m. to 3:30 p.m. at the following location:

Taunton Wastewater Treatment Facility
825 West Water Street
Taunton, MA 02780

This Contract to be awarded as the result of this Advertisement for Bids is funded in part through the Massachusetts Department of Environmental Protection, Bureau of Resource Protection, by loans from the Massachusetts Water Pollution Abatement Trust. This Contract will be subject to the Department of Environmental Protection regulations contained in 310 CMR 44.00, "DEP Selection, Approval and Regulation of Water Pollution Abatement Projects Receiving Financial Assistance from the State Revolving Fund" in effect on the date of issuance of the assistance award (DEP Project Approval Certificate) by the Department.

The Project requires compliance with the Massachusetts Department of Environmental Protection Diesel Retrofit Program (MDRP) by use of engine emission controls that are EPA certified, or their equivalent, on all diesel powered non-road construction equipment used at the job site. Bidders must submit a signed and dated Statement of Intent to Comply as part of their Bid Proposal Document. The Statement of Intent to Comply is attached as Appendix B to the Agreement.

Failure to comply with these DEP requirements may be deemed to render a proposal nonresponsive. No waiver of any provision of these DEP requirements will be granted unless approved by the Department of Environmental Protection.

As Security, each Bid must be accompanied by a Bid Bond having as surety thereto, such Surety Company or Companies as are authorized to do business in the State of Massachusetts of an amount not less than five (5) percent of the Bid. No bid will be accepted unless accompanied by the required bid deposit.

For the successful Bidder a Performance Bond and a Payment Bond, each in the amount of 100 percent of the Contract Price, will be required in the form described in Exhibit J to the Agreement. All such bonds shall be issued by eligible sureties listed in the current US Department of Treasury Circular 570, qualified to do business under the laws of the Commonwealth of Massachusetts and satisfactory to the Owner.

Bidders shall not include Federal Excise Taxes or State of Massachusetts Sales Taxes from which Public Building Projects are exempt.

No Bidder may withdraw its Bid within 30 days (Saturdays, Sundays and legal holidays excluded) after the actual date of the Bid Opening.

Veolia reserves the right to accept any Bid, waive any informalities or minor defects, or reject any or all Bids, if in its sole judgment it is in the best interest of Veolia to do so. Veolia does not discriminate on the basis of sex, race, age, physical disability, religion or national origin.

Disadvantaged Business Enterprise (DBE) goals are applicable to the total dollars paid to the construction contract. The goals for this project are a minimum of **6.60% percent D/MBE participation and 6.40% percent D/WBE participation by certified DBEs**. The two low bidders shall submit completed DBE forms (EEO-DEP-190C, EEO-DEP-191C and the DBE Certification of United States Citizenship form) by the close of business on the third business day after bid opening. Failure to comply with the requirements of this paragraph may be deemed to render a proposal non-responsive. No waiver of any provision of this section will be granted unless approved by the Department of Environmental Protection (MassDEP).

Minimum Wage Rates as determined by the Commissioner of Department of Workforce Development under the provision of the Massachusetts General Laws, Chapter 149, Sections 26 to 27D, as amended, apply to this project. It is the responsibility of the contractor, before bid opening, to request if necessary, any additional information on Minimum Wage Rates for those trades people who may be employed for the proposed work under this contract. Federal Minimum Wage Rates as determined by the United States Department of Labor under the Davis-Bacon Act also apply to this project.

Veolia reserves the right to waive any informality in or to reject any or all Bids if deemed to be in its best interest.

All questions shall be directed in writing via e-mail to Veolia: Attn: Carl Hendrickson, carl.hendrickson@veolia.com

(THIS PAGE INTENTIONALLY LEFT BLANK)

SECTION 00200

INSTRUCTIONS TO BIDDERS

ARTICLE 1. INVESTIGATION OF BIDDERS

1.1 The investigation of a Bidder will seek to determine whether available equipment and financial resources are adequate to assure Veolia that the Goods and Services will be delivered in accordance with the terms of the Agreement.

1.2 In evaluating Bids, Veolia will consider the qualifications of only those Bidders whose Bids are in compliance with the prescribed requirements.

1.3 Veolia reserves the right to reject any Bid if the evidence submitted by, or the investigation of, such Bidder fails to satisfy Veolia that such Bidder is properly qualified to carry out the obligations of the Procurement Documents and to complete the Goods and Services contemplated therein.

ARTICLE 2. COPIES OF PROCUREMENT DOCUMENTS

2.1 Complete sets of Procurement Documents shall be used in preparing Bids; neither Veolia nor Engineer assume any responsibility for errors or misinterpretations resulting from the use of incomplete sets of Procurement Documents.

2.2 Veolia and Engineer in making copies of Procurement Documents available do so only for the purpose of obtaining Bids on the Work and do not confer a license or grant for any other use.

ARTICLE 3. EXAMINATION OF PROCUREMENT DOCUMENTS

3.1 Before submitting a Bid, each Bidder must (a) examine the Procurement Documents thoroughly, (b) become familiar with Federal, State and local laws, ordinances, rules and regulations that may in any manner affect cost, progress or performance of the Work; and (c) study and carefully correlate Bidder's observations with the requirements of the Procurement Documents.

3.2 The submission of a Bid will constitute an incontrovertible representation that the Bidder has complied with every requirement of this Article 3 and that the Procurement Documents are sufficient in scope and detail to indicate and convey understanding of all terms and conditions for providing the Goods and Services.

ARTICLE 4. INTERPRETATIONS

4.1 All questions about the meaning or intent of the Procurement Documents shall be received **via e-mail** by Veolia, Attn: Carl Hendrickson at (617) 999-8716, carl.hendrickson@veolia.com at least ten days before the date herein set for the opening of bids.

4.2 Written clarifications or interpretations will be issued by Addenda not later than five days before the bid opening date. Only questions answered by formal written Addenda will be binding. Oral and other clarifications or interpretations will be without legal effect. Addenda will be e-mailed to all parties recorded as having received the Procurement Documents.

4.3 Bidders are responsible for determining that they have received all Addenda issued.

ARTICLE 5. PRE-BID CONFERENCE

5.1 A pre-bid conference will not be scheduled. Subcontractors can schedule site visits by contacting Carl Hendrickson at (617) 999-8716, carl.hendrickson@veolia.com. Veolia will transmit to all prospective Bidders of record such Addenda as Veolia considers necessary in response to questions. Oral statements may not be relied upon and will not be binding or legally effective.

ARTICLE 6. BID FORM

6.1 Each Bid shall be submitted on the Bid Form on the pages appended to the Procurement Documents. One such copy of the Bid Form shall be removed and submitted separately. All blank spaces must be filled in.

6.2 Bid Forms shall be completed in ink or by typewriter. The Bid price of each item on the form shall be stated in words, and figures. Discrepancies between words and figures will be resolved in favor of words. Discrepancies between the indicated sum of any column of figures and the correct sum thereof will be resolved in favor of the correct sum.

6.3 Firm bids are required. Conditional bids will not be considered.

6.4 Bids by corporations shall be executed in the corporate name by the president or a vice-president (or other corporate officer accompanied by evidence of authority to sign) and the corporate seal shall be affixed and attested by the secretary or an assistant secretary. The corporate address and state of incorporation shall be shown below the signature.

6.5 Bids by Limited Liability Companies shall be executed in the Limited Liability name by the Manager (or other Limited Liability Company officer/representative accompanied by evidence of authority to sign.) The Limited Liability Company address and state where the Limited Liability Company was formed shall be shown below the signature.

6.6 Bids by partnerships shall be executed in the partnership name and signed by a partner, whose title shall appear under the signature. The official address of the partnership shall be shown below the signature.

6.7 All names shall be typed or printed below the signature.

6.8 The Bid shall contain an acknowledgement of receipt of all Addenda (the numbers of which shall be filled in on the Bid Form).

6.9 The address to which communications regarding the Bid are to be directed shall be shown.

6.10 One copy of each Bid shall be submitted via e-mail.

ARTICLE 7. RECEIPT OF BIDS

7.1 Bids will be received at the time and place indicated in the Invitation to Bid.

7.2 Veolia may consider informal any Bid not prepared and submitted in accordance with the provisions hereof.

7.3 Bidders are cautioned that it is the responsibility of each individual bidder to assure that their bid is in the possession of the responsible official or the designated alternate prior to the stated time and at the place of the Bid Opening. Owner is not responsible for bids delayed by e-mail services, of any nature.

ARTICLE 8. MODIFICATION AND WITHDRAWAL OF BIDS

8.1 Bids may be modified only by an appropriate document duly executed (in the manner that a Bid must be executed) and delivered to the place where Bids are to be submitted at any time prior to the opening of Bids.

8.2 Bids may be withdrawn prior to the scheduled time (or authorized postponement thereof) for the opening of Bids.

8.3 Any Bid received after the time and date specified shall not be considered. No Bid may be withdrawn for a period of thirty days, excluding Saturdays, Sundays, and legal holidays, after the actual date of the opening of the Bids.

ARTICLE 9. AWARD OF CONTRACT

9.1 The Contract will be awarded to the lowest responsible and eligible Bidder (Successful Bidder). Such a Bidder shall possess the skill, ability, and integrity necessary for the faithful performance of the work. The term "lowest responsible and eligible Bidder" as used herein shall mean the Bidder whose Bid is the lowest of those Bidders possessing the skill, ability, and integrity necessary to the faithful performance of the Work.

9.2 Veolia reserves the right to reject any and all Bids, to waive any and all informalities if it is in Veolia's best interest to do so, and the right to disregard all nonconforming, non-responsive or conditional Bids.

9.3 If the Contract is to be awarded, Veolia will give the Successful Bidder an agreement within sixty days, excluding Saturdays, Sundays, and legal holidays.

9.4 The Owner may elect to increase the scope of work by selecting, in order, any of the add alternates listed in the Bid Form, such that no single alternate will be considered unless every alternate preceding it on the list has been added to the Base Bid.

9.5 Bidders to be considered responsive shall submit bids on all add alternates listed in the Bid Form. The low bidder will be determined by comparison of the Base Bid and any alternates selected by the Owner.

9.6 A Bid which includes for any item a Bid Price that is abnormally low or high may be rejected as unbalanced.

ARTICLE 10. SALES TAX

10.1 The goods and services to be provided under this Contract are exempt from the Sales and Use Taxes of the State of Massachusetts.

ARTICLE 11. COMMONWEALTH OF MASSACHUSETTS REQUIREMENTS

11.1 Applicable provisions of Massachusetts General Laws and Regulations and/or the United States Code and Code of Federal Regulations govern this Contract and any provision in violation of the foregoing shall be deemed null, void and of no effect. Where conflict between Code of Federal Regulations and State Laws and Regulations exist, the more stringent requirement shall apply. Note that the City of Taunton has special legislation for contracts associated with water and wastewater treatment facilities.

11.2 Minimum Wage Rates as determined by the Commissioner of Department of Workforce Development under the provision of the Massachusetts General Laws, Chapter 149, Sections 26 to 27D, as amended, apply to this project. It is the responsibility of the contractor, before bid opening, to request if necessary, any additional information on Minimum Wage Rates for those trades people who may be employed for the proposed work under this contract. Federal Minimum Wage Rates as determined by the United States Department of Labor under the Davis-Bacon Act also apply to this project. See Appendix G to the Agreement.

11.3 The contractor guarantees that the Work and Services to be performed under the Contract, and all workmanship, materials and equipment performed, furnished, used or installed in the construction of the same shall be free from defects and flaws, and shall be performed and furnished in strict accordance with the Drawings, Specifications, and other contract documents, that the strength of all parts of all manufactured equipment shall be adequate and as specified and that the performance test requirements of the Contract shall be fulfilled. This guarantee shall be for a period of one year from and after the date of completion and acceptance of the Work as stated in the final estimate. If part of the Work is accepted in accordance with that subsection of this AGREEMENT titled "Partial Acceptance", the guarantee for that part of the Work shall be for a period of one year from the date fixed for such acceptance.

If at any time within the said period of guarantee any part of the Work requires repairing, correction or replacement, the Owner may notify the contractor in writing to make the required repairs, correction or replacements. If the Contractor neglects to commence making such repairs, corrections or replacements to the satisfaction of the Owner within seven (7) days from the date of receipt of such notice, or having commenced fails to prosecute such Work with diligence, the Owner may employ other persons to make said repairs, correction or replacements, and charge the costs, including compensation for additional professional services, to the Contractor."

11.4 This project is subject to the Safety and Health Regulations of the U.S. Department of Labor set forth in Title 29 CFR, Part 1926 and to all subsequent amendments, and to any applicable Massachusetts regulations. Contractors shall be familiar with the requirements of these regulations.

11.5 This project is subject to the requirements of the Department of Environmental Protection's Diesel Retrofit Program. Bidders must submit a signed and dated Statement of Intent to Comply form as part of their bid proposal documents.

11.6 This project is subject to the American Iron and Steel requirements of P.L. 113-76, the Consolidated Appropriations Act of 2014. See Appendix I to the Agreement.

11.7 Whenever it is written that an equipment manufacturer must have a specified period of experience with his product, equipment which does not meet the specified experience period can be considered if the equipment supplier or manufacturer is willing to provide an "Efficiency Guarantee Bond" or cash deposit for the duration of the specified time period which will guarantee replacement of that equipment in the event of failure

SECTION 00300

BID FORM

THIS BID IS SUBMITTED TO: Veolia Water North America - Northeast, LLC

PROJECT IDENTIFICATION: City of Taunton, MA
Main Lift Pumping Station Improvements
Contract S-2022-2, CWSRF 6832

- A. The undersigned declares that the only persons or parties interested in this Bid as principals are as stated; that the Bid is made without any collusion with other persons, firms, or corporations; that all the Procurement Documents as prepared by Veolia Water North America - Northeast, LLC, 53 State Street, 14th Floor, Boston, MA, 02109 and dated DATE have been carefully examined; that the undersigned is fully informed in regard to all conditions pertaining to the work and the place where it is to be delivered, and from them the undersigned makes this Bid. These prices shall cover all expenses incurred in providing the Goods and Services required under the Procurement Documents, of which this Bid Form is a part.
- B. The time period for holding bids, where Federal approval is not required is 30 days, Saturdays, Sundays and legal holidays excluded, after the opening of bids and where Federal approval is required, the time period for holding bids is 30 days, Saturdays, Sundays and holidays excluded after Federal approval.
- C. If unsigned copies of the Construction Agreement are delivered to the undersigned within sixty days, excluding Saturdays, Sundays, and legal holidays, after the actual date of the opening of the Bids, the undersigned will within three days, excluding Saturdays, Sundays, and legal holidays, after the date of receipt of such notification, execute and return all copies of the Construction Agreement to Veolia.
- D. The undersigned hereby agrees to fully complete the Main Lift Pumping Station Improvements in accordance with the terms stated in the Agreement.
- E. The undersigned acknowledges receipt of addenda:

Addendum No. _____, dated _____

Addendum No. _____, dated _____

Addendum No. _____, dated _____

- F. The undersigned agrees that, if they are selected as Contractor, they will within five days, Saturdays, Sundays and legal holidays excluded, after presentation thereof by the Company (Veolia), execute a contract in accordance with the terms of this bid and furnish a performance bond in the amount of 100% of the total contract price and also a labor and materials or payment bond in the amount of 100% of the total contract price, each of a surety company qualified to do business under the laws of the Commonwealth and satisfactory to the Company and each in the sum of the contract price, the premiums for which are to be paid by the Contractor and are included in the contract price.
- G. The Subcontractor shall complete all work required under the Contract within 455 days of the issuance of a Notice to Proceed. Work performed beyond the completion date will be subjected to liquidated damages in the amount specified herein.
- H. Liquidated damages specified in this contract are \$1,000 per day for each calendar day beyond the contract completion date that work remains uncompleted.
- I. The time period for holding bids, where Federal approval is not required is 30 days, Saturdays, Sundays and legal holidays excluded, after the opening of bids and where Federal approval is required, the time period for holding bids is 30 days, Saturdays, Sundays and holidays excluded after Federal approval.
- J. Pursuant to M.G.L.c.62C, s49A I certify under the penalties of perjury that I, to my best knowledge and belief, have filed all state tax returns and paid all State Taxes required under law.
- K. The undersigned bidder hereby certifies he/she will comply with the specific affirmative action steps contained in the EEO/AA provisions of this Contract, including compliance with the Disadvantaged

Business Enterprise provisions as required under these contract provisions. The contractor receiving the award of the contract shall incorporate the EEO/AA provisions of this contract into all subcontracts and purchase orders so that such provisions will be binding upon each subcontractor or vendor.

- L. The undersigned further certifies under penalty of perjury that the said undersigned is not presently debarred from doing public construction work in the Commonwealth under the provisions of Section Twenty-Nine F of Chapter Twenty-Nine, or any other applicable debarment provisions of any other Chapter of the General Laws or any rule or regulation promulgated thereunder; and is not presently debarred, suspended, proposed for debarment, declared ineligible, or voluntarily excluded from covered transactions by any Federal department or agency.
- M. Bidders must fully comply with Subpart C of 2 CFR Part 180 and 2 CFR Part 1532, entitled responsibilities of Participants Regarding transactions (Doing Business with Other Persons). Contractors, subcontractors, or suppliers that appear on the Excluded Parties List System at www.usgovxml.com/dataservice.aspx?ds=EPLS are not eligible for award of any contracts funded by the Massachusetts State Revolving Fund.
- N. Bidders must fully comply with the Diesel Retrofit Program. See Appendix B to the Agreement.
- O. In accordance with the above understanding, the undersigned proposes to furnish all Goods and Services, and complete the Work in its entirety in the manner and under the conditions required at the prices listed as follows:

BASE BID

Item Number	Estimated Quantity	Brief Description: unit or lump-sum price bid in both words and figures.	<u>Total in Figures</u>
1	1 LS	Main Lift Pumping Station Improvements, all work excluding , Bid Package 2 (Instrumentation and Control), Bid Package 3 (Sewage Pumps), and bid items 2A-2D, & 3	<p>_____dollars</p> <p>and _____cents (\$ _____) \$ _____</p>
2A	1 LS	Management of Soil/Fill and Contaminated Materials, per Lump Sum,	<p>_____dollars</p> <p>and _____cents (\$ _____) \$ _____</p>
2B	600 TON	Remove & Dispose of Re-use Facility Soil , per ton,	<p>_____dollars</p> <p>and _____cents (\$ _____) \$ _____</p>
2C	100 TON	Remove & Dispose of In-State Landfill Material, , per ton,	<p>_____dollars</p> <p>and _____cents (\$ _____) \$ _____</p>

2D	100 TON	Remove & Dispose of Out-of-State Landfill Material, , per ton, _____dollars and _____cents (\$ _____) \$ _____
3	\$25,000 Allowance	Utility Service Allowance, , per Allowance, _____dollars and _____cents (\$ _____) \$ _____

TOTAL OF MAIN LIFT PUMP STATION IMPROVEMENTS BID PACKAGE #1 BASE BID:

In Figures: \$ _____

In Words: _____

_____ Dollars

and _____ Cents

Amounts shall be shown in both words and figures, where indicated. In case of discrepancy, the amount shown in words will govern.

The above prices shall include all labor, materials, delivery, overhead, profit, insurance, and incidentals required to complete the Work.

P. The names and residences of all persons and parties interested in the foregoing Bid as principals are as follows:

(Give first and last names in full.)

Q. Notice of acceptance should be e-mailed or delivered to the undersigned Bidder at the following address:

(Name of Bidder)

(Title)

(Business Address)

(City and State)

Date

Note: If the Bidder is a corporation, indicate State of incorporation under signature, and affix corporate seal; if a limited liability company, indicate State of formation under signature; if a partnership, give full names and residential addresses, if different from business address.

STATEMENT OF INTENT TO COMPLY

This form must be signed and submitted by the bidder as part of the bid.

Local Governmental Unit City of Taunton, MA *SRF Project No.* 6832

Contract No. S-2022-2 *Contact Title* Main Lift Pump Station Improvements

Bidder

The undersigned, on behalf of the above-named Bidder, agrees that, if awarded the Contract:

- 1. the Bidder shall comply with the Department of Environmental Protection's ("DEP") Diesel Retrofit Program by ensuring that all diesel powered non-road construction equipment and vehicles greater than 50 brake horsepower which will be used in the performance of the work under the Contract are equipped or retrofitted with a pollution control device in accordance with the Diesel Retrofit Program Standard;*
- 2. the Bidder shall require all Subcontractors to comply with MassDEP's Diesel Retrofit Program by ensuring all diesel powered non-road construction equipment and vehicles greater than 50 brake horsepower which will be used in the performance of the work under the Contract are equipped or retrofitted with a pollution control device in accordance with the Diesel Retrofit Program Standard; and*
- 3. The Bidder shall submit and shall require each Subcontractor to submit a Diesel Retrofit Program Contractor Certification (form attached) with a Diesel Retrofit List to DEP (NAME and ADDRESS) and the Bidder within 10 days of the bidder being notified that it has been awarded the Contract. The Bidder shall require each Subcontractor to update such Certification and List within 2 days of using additional Diesel Construction Equipment on the project under the Contract.*

(Signature of Bidder's Authorized Representative)

(Date)

BIDDER CERTIFICATIONS

Pursuant to M.G.L. Ch. 62C, s49A, I certify under the penalties of perjury that I, to my best knowledge and belief, have filed all state tax returns and paid all State Taxes Required under law.

The undersigned hereby certifies that he is able to furnish labor that can work in harmony with all other elements of labor employed or to be employed in the work.

The undersigned bidder hereby certifies he/she will comply with the specific affirmative action steps contained in the Equal Employment Opportunity/Affirmative Action (EEO/AA) provisions of this Contract, including compliance with the Disadvantaged Business Enterprise provisions as required under these contract provisions. The contractor receiving the award of the contract shall incorporate the EEO/AA provisions of this contract into all subcontracts and purchase orders so that such provisions will be binding upon each subcontractor or vendor.

The undersigned certifies under penalties of perjury that this bid is in all respects bonafide, fair and made without collusion or fraud with any other person. As use in this paragraph the "person" shall mean any natural person, joint venture, partnership, corporation or other business or legal entity.

The undersigned further certifies under penalty of perjury that the said undersigned is not presently debarred from doing public construction work in the Commonwealth of Massachusetts under the provisions of Section Twenty-Nine F of Chapter Twenty-Nine, or any other applicable debarment provisions of any other Chapter of the General Laws or any rule or regulations promulgated thereunder; and is not presently debarred, suspended, proposed for debarment, declared ineligible, or voluntarily excluded from covered transactions by any Federal department or agency.

(Date)

(Name of General Bidder)

(Federal Employer Identification No.)

By: _____

(Signature)

(Title & Name of person signing bid)

(Business Address)

(City, State, Zip)

SECTION 00500

CONSTRUCTION AGREEMENT

Between

Veolia Water North America - Northeast, LLC

and

Subcontractor

Located in: Taunton, MA

Project: Main Lift Pumping Station Improvements

Contract S-2022-2, CWSRF 6832

Date:

CONSTRUCTION AGREEMENT

THIS CONSTRUCTION AGREEMENT ("Agreement") is made and entered into as of _____, 2022 ("Effective Date") by and between Veolia Water North America - Northeast, LLC, a Delaware corporation (hereinafter "Company") whose address is 53 State Street, 14th Floor, Boston, MA 02127, and Subcontractor (hereinafter "Subcontractor"), whose address is Street, City (Town), State ZIP, (each a "Party" and collectively the "Parties"),

WHEREAS, in consideration of the mutual promises herein contained, Company and Subcontractor agree, promise, and obligate themselves as follows:

1. Subcontractor promises to provide the services described in Exhibit A, Scope of Work, (hereinafter the "Work") in accordance with the Agreement. The Work is provided to support Company's obligations to Taunton, MA (hereinafter "Client") in conjunction with Company's performance at the City of Taunton Main Lift Pumping Station Improvements (hereinafter the "Project") and its agreement with the Client (the "Prime Contract").
2. Company promises to pay Subcontractor for full, accurate, and timely performance of the Work and compensation as provided in Exhibit C and as set forth below in the Contract Documents.
3. This Agreement constitutes the entire understanding between the Parties, and cancels and supersedes all prior negotiations, representations, understandings and agreements, except that the indemnification obligations contained in any prior agreements shall survive the execution of this Agreement and consists of a) this Agreement; and b) its Exhibits (collectively referred to as "Contract Documents") incorporated and referenced as follows:
 - Notice of Award
 - Addenda _____ to _____
 - Bid Form
 - Exhibit A - Scope of Work (Note: Drawings and Specifications have been provided by Company and are not attached to this Agreement.)
 - Exhibit B - General Terms and Conditions
 - Exhibit C - Compensation
 - Exhibit C.1 - Interim Waiver and Release of Liens and Claims upon Payment
 - Exhibit C.2 - Unconditional Final Waiver and Release of Liens
 - Exhibit D - Insurance Requirements
 - Exhibit E - Insurance Supplement
 - Exhibit F - Additional / Special Terms - Illustrative Schedule
 - Exhibit G - Terms and Conditions for Hazardous or Contaminated Non-Hazardous Waste
 - Exhibit H - IT Security Requirements
 - Exhibit I - Anti-Corruption Compliance
 - Exhibit J - Bonding / Letters of Credit requirements

In the event of an inconsistency between provisions of the Agreement, the inconsistency shall be resolved by giving precedence as follows: 1) this Agreement, 2) Exhibit F Additional/Special Terms, 3) Exhibit B General Terms and Conditions, 4) Exhibit A Scope of Work, and 5) any remaining Contract Documents.

4. The Effective Date set forth above is the date as to which all Contract Documents have reference for purposes of coordination of their meaning and effect. Any work commenced and any payments made pursuant to an award or letter of intent prior to the execution date hereof shall be deemed to have been done and paid after the Effective Date and governed by the terms of this Agreement.

IN WITNESS WHEREOF, the Parties hereto have caused this Agreement to be signed by their respective authorized representatives, effective as of the date indicated above.

Veolia Water North America - Northeast, LLC:	Subcontractor:
By:	By:
Title:	Title:
Typed Name:	Typed Name:
Date:	Date:

EXHIBIT A
SCOPE OF WORK

1 DESCRIPTION

Except as otherwise expressly provided herein, Subcontractor shall provide all labor, supervision, material, supplies, equipment, inspections, and any other incidentals required to perform the Work as described in this Scope of Work for the Project. The Work is generally described as follows:

**Main Lift Pumping Station Improvements
CWSRF 6832**

2 PERFORMANCE PERIOD / SCHEDULE

Time is of the essence in the performance of this Work. Subcontractor shall make whatever adjustments in working hours, manpower, equipment, etc. deemed necessary to complete the Work in accordance with the terms of the Agreement and the specific schedule requirements hereof.

The Time for Completion of this Agreement is 455 calendar days. The Subcontractor shall prepare a Project schedule.

Liquidated damages specified in this contract are \$1,000 per day for each calendar day beyond the contract completion date that work remains uncompleted.

3 REPORTING REQUIREMENTS

The Subcontractor shall prepare daily reports and a monthly progress report providing significant progress completed that month summarized in bullet points and also providing percent of project complete.

4 DATA REQUIREMENTS

INTENTIONALLY LEFT BLANK

5 SPECIAL EQUIPMENT WARRANTIES

Subcontractor warrants that the goods and equipment ("Equipment") shall be free from liens and defects in title, design, material, workmanship, and performance, and shall conform and perform in all respects to the terms of this Order, the specifications and applicable drawings and shall be new and of the best quality. If, any time prior to the earlier of one (1) year from the date of actual productive use of the Equipment or from completion of performance of the services, it appears the Equipment or services do not conform to these warranties or the specifications, and Company so notifies the Subcontractor, Subcontractor shall promptly correct such nonconformity and take all other action to remedy the results of any defect or nonconformity to the satisfaction of the Company, at Subcontractor's sole expense, failing which Company may reject or revoke acceptance and cover, or Company may perform Subcontractor's work and correct such defects at Subcontractor's expense. These rights shall survive acceptance and the warranty shall inure to the benefit of and be enforceable by Company and its customer.

6 COMPANY FURNISHED ITEMS

With respect to the Company Furnished Products identified below, Subcontractor shall fulfill the described responsibilities:

- Bid Package #2 – Instrumentation and Control
- Bid Package #3 – Sewage Pumps

Subcontractor's Responsibilities:

Review Company provided shop drawings.
Inspect for completeness or damage, jointly with Company.
Handle, store, install and finish products.
Repair or replace products/items damaged after receipt.
Arrange for manufacturer's inspections, service, start-up services and training.

7 WORKING HOURS

The Work to be performed is located at 690 West Water Street, Taunton, MA ("Project Site") and the working hours are 7:00 A.M. to 3:30 P.M. Monday through Friday. Subcontractor shall coordinate with designated Veolia staff for deviations to this requirement.

8 COMMONWEALTH OF MASSACHUSETTS PROVISIONS

- A. Note that the City of Taunton has special legislation for contracts associated with water treatment facilities. This legislation amends the MGL.
- B. The Contractor agrees that it will fully comply with Subpart C of 2 CFR Part 180 and 2 CFR Part 1532, entitled Responsibilities of Participants Regarding Transactions (Doing Business with Other Persons). The Contractor shall not award any subcontracts or purchase any materials from suppliers that appear on the Excluded Parties List System. The Contractor shall include this requirement in each subcontract and require it to be included in all subcontracts regardless of tier. The Contractor shall maintain reasonable records to demonstrate compliance with these requirements.
- C. The fair share goals for disadvantaged business enterprise (DBE) participation for this contract are a minimum of 6.60% percent Disadvantaged Minority Business Enterprise (D/MBE) participation and 6.40% percent Disadvantaged Women Business Enterprise (D/WBE) participation, applicable to the total dollar amount paid for the construction contract. The Contractor shall take all affirmative steps necessary to achieve this goal, and shall provide reports documenting the portion of contract and subcontract dollars paid to DBEs, and its efforts to achieve the goals, with each invoice submitted or at such greater intervals as specified by the (municipality). The contractor shall require similar reports from its subcontractors.
- D. During the performance of this contract, the contractor agrees as follows:
 - a. The contractor will not discriminate against any employee or applicant for employment because of race, color, religion, sex, or national origin. The contractor will take affirmative action to ensure that applicants are employed, and that employees are treated during employment, without regard to their race, color, religion, sex or national origin. Such action shall include, but not be limited to the following: employment, upgrading, demotion, or transfer; recruitment or recruitment advertising; layoff or termination; rates of pay or other forms of compensation; and selection for training, including apprenticeship. The contractor agrees to post in conspicuous places, available to employees and applicants for employment, notices to be provided by the contracting officer setting forth the provisions of this nondiscrimination clause.
 - b. The contractor will, in all solicitations or advancements for employees placed by or on behalf of the contractor, state that all qualified applicants will receive consideration for employment without regard to race, color, religion, sex or national origin.
 - c. The contractor will send to each labor union or representative of workers with which he has a collective bargaining agreement or other contract or understanding, a notice, to be provided by the agency contracting officer, advising the labor union or workers' representative of the contractor's commitments under Section 202 of Executive Order No. 11246 of September 24, 1965, and shall post copies of the notice in conspicuous places available to employees and applicants for employment.
 - d. The contractor will comply with all provisions of Executive Order No. 11246 of Sept. 24, 1965, and of the rules, regulations, and relevant orders of the Secretary of Labor.
 - e. The contractor will furnish all information and reports required by Executive Order No. 11246 of September 24, 1965, and by the rules, regulations, and orders of the Secretary of Labor, or pursuant thereto, and will permit access to his books, records, and accounts by the

contracting agency and the Secretary of Labor for purposes of investigation to ascertain compliance with such rules, regulations, and orders. Comp., p. 684, EO 12086 of Oct. 5, 1978, 43 FR 46501, 3 CFR, 1978 Comp., p. 230

- f. In the event of the contractor's noncompliance with the nondiscrimination clauses of this contract or with any of such rules, regulations, or orders, this contract may be cancelled, terminated, or suspended in whole or in part and the contractor may be declared ineligible for further Government contracts in accordance with procedures authorized in Executive Order No. 11246 of Sept. 24, 1965, and such other sanctions may be imposed and remedies invoked as provided in Executive Order No. 11246 of September 24, 1965, or by rule, regulation, or order of the Secretary of Labor, or as otherwise provided by law.
 - g. The contractor will include the provisions of paragraphs (1) through (7) in every subcontract or purchase order unless exempted by rules, regulations, or orders of the Secretary of Labor issued pursuant to Section 204 of Executive Order No. 11246 of September 24, 1965, so that such provisions will be binding upon each subcontractor or vendor. The contractor will take such action with respect to any subcontract or purchase order as may be directed by the Secretary of Labor as a means of enforcing such provisions including sanctions for noncompliance: Provided, however, that in the event the contractor becomes involved in, or is threatened with, litigation with a subcontractor or vendor as a result of such direction, the contractor may request the United States to enter into such litigation to protect the interests of the United States." [Sec. 202 amended by EO 11375 of Oct. 13, 1967, 32 FR 14303, 3 CFR, 1966-1970
- E. The contractor shall not participate in or cooperate with an international boycott, as defined in Section 999 (b)(3) and (4) of the Internal Revenue code 1986, as amended, or engage in conduct declared to be unlawful by Section 2 of Chapter 151E of the Massachusetts General Laws.
- F. Pursuant to M.G.L. c.44, s31C, I certify that an appropriation has been made in the total amount of the contract.
- G. The Contractor acknowledges to and for the benefit of the City of Taunton and the Commonwealth of Massachusetts (the "State") that it understands the goods and services under this Agreement are being funded with monies made available by the Clean Water State Revolving Fund and/or Drinking Water State Revolving Fund that have statutory requirements commonly known as "American Iron and Steel;" that requires all of the iron and steel products used in the project to be produced in the United States ("American Iron and Steel Requirement") including iron and steel products provided by the Contractor pursuant to this Agreement. The Contractor hereby represents and warrants to and for the benefit of the Purchaser and the State that (a)the Contractor has reviewed and understands the American Iron and Steel Requirement, (b) all of the iron and steel products used in the project will be and/or have been produced in the United States in a manner that complies with the American Iron and Steel Requirement, unless a waiver of the requirement is approved, and (c) the Contractor will provide any further verified information, certification or assurance of compliance with this paragraph, or information necessary to support a waiver of the American Iron and Steel Requirement, as may be requested by the Purchaser or the State. Notwithstanding any other provision of this Agreement, any failure to comply with this paragraph by the Contractor shall permit the Purchaser or State to recover as damages against the Contractor any loss, expense, or cost (including without limitation attorney's fees)incurred by the Purchaser or State resulting from any such failure (including without limitation any impairment or loss of funding, whether in whole or in part, from the State or any damages owed to the State by the Purchaser). While the Contractor has no direct contractual privity with the State, as a lender to the Purchaser for the funding of its project, the Purchaser and the Contractor agree that the State is a third-party beneficiary and neither this paragraph (nor any other provision of this Agreement necessary to give this paragraph force or effect) shall be amended or waived without the prior written consent of the State.
- H. All construction contracts are subject to the Davis Bacon wage rate requirements and must include the provisions found in Appendix G in the contract. The Davis Bacon Act Requirements are included.
- I. The Contractor agrees that it will fully comply with Subpart C of 2 CFR Part 180 and 2 CFR Part 1532, entitled Responsibilities of Participants Regarding Transactions (Doing Business with Other Persons). The Contractor shall not award any subcontracts or purchase any materials from suppliers that appear on the Excluded Parties List System. The Contractor shall include this requirement in each subcontract and require it to be included in all subcontracts regardless of tier. The Contractor shall maintain reasonable records to demonstrate compliance with these requirements.

J. M.G.L statutes:

M.G.L c.30 s 39F Payment to Subcontractor
c.30 s 39I Deviation from Plans and Specifications
c.30 s 39J No Arbitrary Decisions are Final
c.30 s 39L Construction Work by Foreign Corporations
c.30 s 39N Differing Site Conditions
c.30 s 39O Equitable Adjustments for Delays
c.30 s 39P Decision on Interpretation of Specifications
c.30 s 39R Contractor's Records
c.149 s 34 Limitations on Hours of Work
c.82 s 40 Excavations; Notice; Penalties

Section 39F.

- a. Every contract awarded pursuant to sections forty-four A to L, inclusive, of chapter one hundred and forty-nine shall contain the following subparagraphs (a) through (i) and every contract awarded pursuant to section thirty-nine M of chapter thirty shall contain the following subparagraphs (a) through (h) and in each case those subparagraphs shall be binding between the general contractor and each subcontractor.
 - a. Forthwith after the general contractor receives payment on account of a periodic estimate, the general contractor shall pay to each subcontractor the amount paid for the labor performed and the materials furnished by that subcontractor, less any amount specified in any court proceedings barring such payment and also less any amount claimed due from the subcontractor by the general contractor.
 - b. Not later than the sixty-fifth day after each subcontractor substantially completes his work in accordance with the plans and specifications, the entire balance due under the subcontract less amounts retained by the awarding authority as the estimated cost of completing the incomplete and unsatisfactory items of work, shall be due the subcontractor; and the awarding authority shall pay that amount to the general contractor. The general contractor shall forthwith pay to the subcontractor the full amount received from the awarding authority less any amount specified in any court proceedings barring such payment and also less any amount claimed due from the subcontractor by the general contractor.
 - c. Each payment made by the awarding authority to the general contractor pursuant to subparagraphs (a) and (b) of this paragraph for the labor performed and the materials furnished by a subcontractor shall be made to the general contractor for the account of that subcontractor; and the awarding authority shall take reasonable steps to compel the general contractor to make each such payment to each such subcontractor. If the awarding authority has received a demand for direct payment from a subcontractor for any amount which has already been included in a payment to the general contractor or which is to be included in a payment to the general contractor for payment to the subcontractor as provided in subparagraphs (a) and (b), the awarding authority shall act upon the demand as provided in this section.
 - d. If, within seventy days after the subcontractor has substantially completed the subcontract work, the subcontractor has not received from the general contractor the balance due under the subcontract including any amount due for extra labor and materials furnished to the general contractor, less any amount retained by the awarding authority as the estimated cost of completing the incomplete and unsatisfactory items of work, the subcontractor may demand direct payment of that balance from the awarding authority. The demand shall be by a sworn statement delivered to or sent by certified mail to the awarding authority, and a copy shall be delivered to or sent by certified mail to the general contractor at the same time. The demand shall contain a detailed breakdown of the balance due under the subcontract and also a statement of the status of completion of the subcontract work. Any demand made after substantial completion of the subcontract work shall be valid even if delivered or mailed prior to the seventieth day after the subcontractor has substantially completed the subcontract work. Within ten days after the subcontractor

has delivered or so mailed the demand to the awarding authority and delivered or so mailed a copy to the general contractor, the general contractor may reply to the demand. The reply shall be by a sworn statement delivered to or sent by certified mail to the awarding authority and a copy shall be delivered to or sent by certified mail to the subcontractor at the same time. The reply shall contain a detailed breakdown of the balance due under the subcontract including any amount due for extra labor and materials furnished to the general contractor and of the amount due for each claim made by the general contractor against the subcontractor.

- e. Within fifteen days after receipt of the demand by the awarding authority, but in no event prior to the seventieth day after substantial completion of the subcontract work, the awarding authority shall make direct payment to the subcontractor of the balance due under the subcontract including any amount due for extra labor and materials furnished to the general contractor, less any amount (i) retained by the awarding authority as the estimated cost of completing the incomplete or unsatisfactory items of work, (ii) specified in any court proceedings barring such payment, or (iii) disputed by the general contractor in the sworn reply; provided, that the awarding authority shall not deduct from a direct payment any amount as provided in part (iii) if the reply is not sworn to, or for which the sworn reply does not contain the detailed breakdown required by subparagraph (d). The awarding authority shall make further direct payments to the subcontractor forthwith after the removal of the basis for deductions from direct payments made as provided in parts (i) and (ii) of this subparagraph.
 - f. The awarding authority shall forthwith deposit the amount deducted from a direct payment as provided in part (iii) of subparagraph (e) in an interest-bearing joint account in the names of the general contractor and the subcontractor in a bank in Massachusetts selected by the awarding authority or agreed upon by the general contractor and the subcontractor and shall notify the general contractor and the subcontractor of the date of the deposit and the bank receiving the deposit. The bank shall pay the amount in the account, including accrued interest, as provided in an agreement between the general contractor and the subcontractor or as determined by decree of a court of competent jurisdiction.
 - g. All direct payments and all deductions from demands for direct payments deposited in an interest-bearing account or accounts in a bank pursuant to subparagraph (f) shall be made out of amounts payable to the general contractor at the time of receipt of a demand for direct payment from a subcontractor and out of amounts which later become payable to the general contractor and in the order of receipt of such demands from subcontractors. All direct payments shall discharge the obligation of the awarding authority to the general contractor to the extent of such payment.
 - h. The awarding authority shall deduct from payments to a general contractor amounts which, together with the deposits in interest-bearing accounts pursuant to subparagraph (f), are sufficient to satisfy all unpaid balances of demands for direct payment received from subcontractors. All such amounts shall be earmarked for such direct payments, and the subcontractors shall have a right in such deductions prior to any claims against such amounts by creditors of the general contractor.
 - i. If the subcontractor does not receive payment as provided in subparagraph (a) or if the general contractor does not submit a periodic estimate for the value of the labor or materials performed or furnished by the subcontractor and the subcontractor does not receive payment for same when due less the deductions provided for in subparagraph (a), the subcontractor may demand direct payment by following the procedure in subparagraph (d) and the general contractor may file a sworn reply as provided in that same subparagraph. A demand made after the first day of the month following that for which the subcontractor performed or furnished the labor and materials for which the subcontractor seeks payment shall be valid even if delivered or mailed prior to the time payment was due on a periodic estimate from the general contractor. Thereafter the awarding authority shall proceed as provided in subparagraph (e), (f), (g) and (h).
- b. Any assignment by a subcontractor of the rights under this section to a surety company furnishing a bond under the provisions of section twenty-nine of chapter one hundred forty-

nine shall be invalid. The assignment and subrogation rights of the surety to amounts included in a demand for direct payment which are in the possession of the awarding authority or which are on deposit pursuant to subparagraph (f) of paragraph (1) shall be subordinate to the rights of all subcontractors who are entitled to be paid under this section and who have not been paid in full.

- c. "Subcontractor" as used in this section (i) for contracts awarded as provided in sections forty-four A to forty-four H, inclusive, of chapter one hundred forty-nine shall mean a person who files a sub-bid and receives a subcontract as a result of that filed sub-bid or who is approved by the awarding authority in writing as a person performing labor or both performing labor and furnishing materials pursuant to a contract with the general contractor, (ii) for contracts awarded as provided in paragraph (a) of section thirty-nine M of chapter thirty shall mean a person approved by the awarding authority in writing as a person performing labor or both performing labor and furnishing materials pursuant to a contract with the general contractor, and (iii) for contracts with the commonwealth not awarded as provided in forty-four A to forty-four H, inclusive, of chapter one hundred forty-nine shall also mean a person contracting with the general contractor to supply materials used or employed in a public works project for a price in excess of five thousand dollars.
- d. A general contractor or a subcontractor shall enforce a claim to any portion of the amount of a demand for direct payment deposited as provided in subparagraph (f) of paragraph 1 by a petition in equity in the superior court against the other and the bank shall not be a necessary party. A subcontractor shall enforce a claim for direct payment or a right to require a deposit as provided in subparagraph (f) of paragraph 1 by a petition in equity in the superior court against the awarding authority and the general contractor shall not be a necessary party. Upon motion of any party the court shall advance for speedy trial any petition filed as provided in this paragraph. Sections fifty-nine and fifty-nine B of chapter two hundred thirty-one shall apply to such petitions. The court shall enter all interlocutory decree upon which execution shall issue for any part of a claim found due pursuant to sections fifty-nine and fifty-nine B and, upon motion of any party, shall advance for speedy trial the petition to collect the remainder of the claim. Any party aggrieved by such interlocutory decree shall have the right to appeal there from as from a final decree. The court shall not consolidate for trial the petition of any subcontractor with the petition of one or more subcontractors or the same general contract unless the court finds that a substantial portion of the evidence of the same events during the course of construction (other than the fact that the claims sought to be consolidated arise under the same general contract) is applicable to the petitions sought to be consolidated and that such consolidation will prevent unnecessary duplication of evidence. A decree in any such proceeding shall not include interest on the disputed amount deposited in excess of the interest carried for the period of any such deposit. No person except a subcontractor filing a demand for direct payment for which no funds due the general contractor are available for direct payment shall have a right to file a petition in court of equity against the awarding authority claiming a demand for direct payment is premature and such subcontractor must file the petition before the awarding authority has made a direct payment to the subcontractor and has made a deposit of the disputed portion as provided in part (iii) of subparagraph (e) and in subparagraph (f) of paragraph (1).
- e. In any petition to collect any claim for which a subcontractor has filed a demand for direct payment the court shall, upon motion of the general contractor, reduce by the amount of any deposit of a disputed amount by the awarding authority as provided in part (iii) of subparagraph (e) and in subparagraph (f) of paragraph (1) any amount held under a trustee writ or pursuant to a restraining order or injunction.

Section 39N. Every contract subject to section forty-four A of the chapter one hundred and forty-nine or subject to section thirty-nine M chapter thirty shall contain the following paragraph in its entirety and an awarding authority may adopt reasonable rules or regulations in conformity with that paragraph concerning, the filing investigation and settlement of such claims if, during the progress of the work, the contractor or the awarding authority discovers that the actual subsurface or latent physical conditions encountered at the site differ substantially or materially from those shown on the plans or indicated in the contract documents either the contractor or the contracting authority may request an equitable adjustment in the contract price of the contract applying to work affected by the

differing site conditions. A request for such an adjustment shall be in writing and shall be delivered by the party making such claim to the other party as soon as possible after such conditions are discovered. Upon receipt of such a claim from a contractor, or upon its own initiative, the contracting authority shall make an investigation of such physical conditions, and, if they differ substantially or materially from those shown on the plans or indicated in the contract documents or from those ordinarily encountered and generally recognized as inherent in work of the character provided for in the plans and contract documents and are of such a nature as to cause an increase or decrease in the cost of performance of the work or a change in the construction methods required for the performance of the work which results in an increase or decrease in the cost of the work, the contracting authority shall make an equitable adjustment in the contract price and the contract shall be modified in writing accordingly.

Section 39O. Every contract subject to the provisions of section thirty-nine M of this chapter or subject to section forty-four A of chapter one hundred forty-nine shall contain the following provisions (a) and (b) in their entirety and, in the event a suspension, delay, interruption or failure to act of the awarding authority increases the cost of performance to any subcontractor, that subcontractor shall have the same rights against the general contractor for payment for an increase in the cost of his performance as provisions (a) and (b) give the general contractor against the awarding authority, but nothing in provisions (a) and (b) shall in any way change, modify or alter any other rights which the general contractor or the subcontractor may have against each other.

- a. The awarding authority may order the general contractor in writing to suspend, delay, or interrupt all or any part of the work for such period of time as may determine to be appropriate for the convenience of the awarding authority; provided however, that if there is a suspension, delay or interruption for fifteen days or more or due to a failure of the awarding authority to act within the time specified in this contract, the awarding authority shall make an adjustment in the contract price for any increase in the cost of performance of this contract but shall not include any profit to the general contractor on such increase; and provided further, that the awarding authority shall not make any adjustment in the contract price under this provision for any suspension, delay, interruption or failure to act to the extent that such is due to any cause for which this contract provides for an equitable adjustment of the contract price under any other contract provisions.
- b. The general contractor must submit the amount of a claim under provision (a) to the awarding authority in writing as soon as practicable after the end of the suspension, delay, interruption or failure to act and, in any event, not later than the date of final payment under this contract and, except for costs due to a suspension order, the awarding authority shall not approve any costs in the claim incurred more than twenty days before the general contractor notified the awarding authority in writing of the act or failure to act involved in the claim.

K. Appendices:

1. Appendix A1 - Certification Statement
2. Appendix B - Diesel Retrofit Program
3. Appendix E - Disadvantaged Business Enterprises
4. Appendix F - DIVISION OF MUNICIPAL SERVICES POLICIES
5. Appendix G - Davis Bacon Act Requirements
6. Appendix I - American Iron and Steel Requirements

9 GENERAL REQUIREMENTS

A. Main Lift Pump Station Improvements

Bid Package #1 – General

Bid Package #1 consists of all work not included in Packages #2-#3, including:

- Installation of influent sewer connection and site improvements
- New pumps, piping, electrical and instrumentation associated with a new dry pit / wet pit sewage pumping station
- New standby generator and plumbing, heating and ventilation systems.
- New above grade masonry block structure with brick facade
- Startup of new equipment, demonstration of control strategies, and activation of new pumping station

- Electrical work as shown in the contract documents - Electrical drawings and Specifications Division 16
- Install instrumentation and control panels furnished under Division 13 and Division 11

Bid Package #2 – Instrumentation and Control Procurement

- Furnish and program Instrumentation and control equipment as shown in the Contract Documents – Instrumentation drawings and Specifications Division 13

Bid Package #3 – Sewage Pumps Procurement

- Furnish dry pit submersible pumps and appurtenances for wastewater pumping as specified in Specification Section 11310.
- Safety Requirements:
 - The Subcontractor is to meet and review the Veolia safety plan for this facility prior to initiating work and shall submit a site-specific safety plan. The minimum PPE requirements are Steel toed boots, ANSI approved hard hats, and ANSI approved safety glasses.
 - Certain tasks may require additional personnel protective equipment - such as a respirator, hearing protection, fall protection, tyvek suits. Prior to performing these tasks - a job site safety analysis must be facilitated.

CERTIFICATION STATEMENT

Pursuant to M.G.L. c.44, s31C, I certify that an appropriation has been made in the total amount of the contract.

City of Taunton, Massachusetts
City Auditor

Contract Approved As To Form:

City of Taunton Massachusetts
City Solicitor

DIESEL RETROFIT PROGRAM CONTRACTOR CERTIFICATION

Each Contractor and its Subcontractor(s) must sign and email this form to the DEP DMS project engineer, within 10 days after the contractor is awarded.

Local Governmental Unit: City of Taunton SRF Project No.: 6832

Contract No.: S-2022-2 Contact Title: Main Lift Pump Station Improvements

Contractor: _____

I, _____, an authorized signatory for
(Authorized Representative)

(Contractor)

whose principal place of business is at _____ do hereby certify that any and all diesel powered non-road construction equipment and vehicles greater than 50 brake horsepower which will be used in the performance of the work under the Contract (hereinafter "Diesel Construction Equipment") have pollution control devices, such as oxidation catalysts or particulate filters, installed on the exhaust system side of the diesel combustion engine equipment in accordance with the Diesel Retrofit Program Standard.

I am submitting on behalf of _____ a list of all said Diesel Construction
(Contractor)
Equipment, labeled "Diesel Retrofit List," that will be used in connection with this Contract by

_____. I hereby certify that the information on the attached Diesel Retrofit List is correct and accurate as of the date of signature. The List includes the following information for each piece of Diesel Construction Equipment:

1. Equipment type, make, model;
2. Vehicle Identification Number or VIN;
3. Engine model and year of manufacture;
4. Engine HP rating;
5. Emission Control Device ("ECD") type (Diesel Oxidation Catalyst or Diesel Particulate Filter);
6. ECD make, model, and manufacturer;
7. ECD EPA or CARB Verification Number or manufacturer's certification that the DOC or DPF meets or exceeds emission reductions provided by similar emission control technology verified by EPA or CARB;
8. ECD installation date;
9. Type of fuel to be used; and
10. Whether the equipment is owned or rented.

Contractor shall notify DEP within 48 hours of any new Diesel Construction Equipment brought onto the Contract site. Contractor shall maintain detailed records of all Diesel Construction Equipment used at the Contract site, including the dates and duration times the Diesel Construction Equipment is used at the Contract site. Contractor shall make such records available for inspection by DEP. Contractor shall ensure that the emissions control technology for each piece of Diesel Construction Equipment is operated, maintained, and serviced as recommended by the manufacturer. Contractor shall retrofit prior to the end of the Contract any Diesel Construction Equipment no longer exempt from meeting the Diesel Construction Equipment Standard under exemption 3 (because it had an engine that met the EPA particulate matter (PM) Tier emission standards currently in effect at the start of the Contract for non-road diesel engines for the applicable engine power group and such emissions standards were superseded during the Contract).

I acknowledge that this certificate is being furnished as a requirement under this Contract and is subject to applicable State and federal laws, both criminal and civil. Signed under pains and penalty of perjury on

this date _____.

Signature: _____

Printed Name: _____

Title: _____

DISADVANTAGED BUSINESS ENTERPRISE PARTICIPATION
MASSACHUSETTS DEPARTMENT OF ENVIRONMENTAL PROTECTION
DIVISION OF MUNICIPAL SERVICES

THE REVOLVING FUND LOAN PROGRAM – SCHEDULE OF SUBCONTRACTOR PARTICIPATION

Unit _____
_____ / _____
Number _____

Environmental Protection Agency (EPA) requires that all SRF borrowers develop and maintain a list of all MBE/WBE and non MBE/WBE subcontractors on the project. Completed and returned to MassDEP within 90 days of award of the contract.

Point of Contact Mailing Address Telephone Number E-Mail Address MBE WBE DBE Subcontract Value

DISADVANTAGED BUSINESS ENTERPRISE PARTICIPATION
MASSACHUSETTS DEPARTMENT OF ENVIRONMENTAL PROTECTION
DIVISION OF MUNICIPAL SERVICES

SCHEDULE OF PARTICIPATION FOR SRF CONSTRUCTION

Project Title: _____ **Project Location:** _____

Disadvantaged Minority Business Enterprise Participation in the SRF Loan Work

	Name & Address of D/MBE	Nature of Participation	Dollar Value of Participation
1.			
2.			
3.			
Total D/MBE Commitment:			
= (Total D/MBE Commitment) / (Bid Price)			%

Disadvantaged Women Business Enterprise Participation in the SRF Loan Work

	Name & Address of D/WBE	Nature of Participation	Dollar Value of Participation
1.			
2.			
3.			
Total D/WBE Commitment:			
= (Total D/WBE Commitment) / (Bid Price)			%

The Bidder agrees to furnish implementation reports as required by MassDEP to indicate the D/MBEs and D/WBE(s) which it has used or intends to use. Breach of this commitment constitutes a breach of the contract.

Name of Bidder: _____

Date: _____ By: _____
Signature

NOTE: Participation of a DBE may be counted in only their certified category; the same dollar participation cannot be used in computing the percentage of D/MBE participation and again of D/WBE participation.

LETTER OF INTENT FOR SRF CONSTRUCTION

This form is to be completed by the D/MBE and D/WBE and must be submitted by the Bidder no later than close of business on the third business day after notification by the LGU. A separate form must be completed for each D/MBE and D/WBE involved in the project.

Project Title: _____ Project Location: _____

TO: _____
(Name of Bidder)

FROM: _____
(Please Indicate Status D/MBE or D/WBE)

° I/we intend to perform work in connection with the above project as (check one):

- | | |
|---|--|
| <input type="checkbox"/> An individual | <input type="checkbox"/> A partnership |
| <input type="checkbox"/> A corporation | <input type="checkbox"/> A joint venture with: _____ |
| <input type="checkbox"/> Other (explain): _____ | |

° It is understood that if you are awarded the contract, you intend to enter into an agreement to perform the activity described below for the prices indicated.

DBE PARTICIPATION

Description of Activity	Date of Project Commencement	\$ Amount	% Bid Price
		\$	%

° The undersigned certify that they will enter into a formal agreement upon execution of the contract for the above referenced project.

BIDDER

DBE

(Authorized Original Signature)

Date

(Authorized Original Signature)

Date

ADDRESS:

ADDRESS:

TELEPHONE #:

TELEPHONE #:

FEIN:

FEIN:

EMAIL ADDRESS:

EMAIL ADDRESS:

ORIGINALS:

- ° Compliance Mgr. City/Town Project Location
- ° DEP Program Manager for DEP's AAO Director

* Attach a copy of current (within 2 years) DBE Certification

DBE CERTIFICATION OF UNITED STATES CITIZENSHIP

For the SRF program, under the EPA Disadvantage Business Enterprise (DBE) Rule, a DBE must be owned or controlled by a socially and economically disadvantaged person that is also a citizen of the United States (See 40 CFR 33.202). "Ownership" is defined at 13 CFR 124.105 and "control" is defined at 13 CFR 124.106. DBEs are certified for the SRF program through the Supplier Diversity Office using the federal Department of Transportation (DOT) DBE rules. EPA allows the use of DBEs certified under the DOT rules as long as they are also United States citizens. To ensure compliance with the EPA rule, MassDEP must verify United States citizenship through the completion of the following form for each DBE used on the project.

SRF Project Number _____

Contract Number _____

Contract Title _____

DBE Subcontractor _____

The undersigned, on behalf of the above named DBE subcontractor, hereby certifies that the DBE firm is either owned or controlled by a person or persons that are citizens of the United States.

Printed Name and Title of DBE Signatory

DBE Signature

Date

DISADVANTAGED BUSINESS ENTERPRISE
PROGRAM DBE SUBCONTRACTOR PARTICIPATION
FORM

The United States Environmental Protection Agency (EPA) requires that this form be provided to all subcontractors on the project. At the option of the subcontractor, this form may be filled out and submitted directly to the EPA DBE Coordinator.

NAME OF SUBCONTRACTOR

PROJECT NAME

ADDRESS

CONTRACT NO.

TELEPHONE NO.

E-MAIL ADDRESS

PRIME CONTRACTOR NAME:

Please use the space below to report any concerns regarding the above EPA-funded project (e.g., reason for termination by prime contractor, late payment, etc.).

CONTRACT ITEM NO.	ITEM OF WORK OR DESCRIPTION OF SERVICES RECEIVED FROM THE PRIME CONTRACTOR	AMOUNT SUBCONTRACTOR WAS PAID BY PRIME CONTRACTOR
----------------------	---	--

Subcontractor Signature

Title/Date

Upon exhausting all known sources and making every possible effort to meet the minimum requirements for DBE participation, the Bidder may seek relief either partially or entirely from these requirements by submitting a completed waiver package by the close of business on the third business day after notification by the LGU. Failure to comply with this process shall be cause to reject the bid thereby rendering the Bidder not eligible for award of the contract.

General Information

Project Title: _____ Project Location: _____
Bid Opening (time/date) _____
Bidder: _____
Mailing Address: _____
Contact Person: _____ Telephone No. _____

Minimum Requirements

The bidder must demonstrate that good faith efforts were undertaken to comply with the percentage goals as specified. The firm seeking relief must show that such efforts were taken appropriately in advance of the time set for opening bid proposals to allow adequate time for response(s) by submitting the following:

- A. A detailed record of the effort made to contact and negotiate with disadvantaged minority and/or woman owned businesses, including:
 - 1. names, addresses, telephone numbers and contact dates of all such companies contacted;
 - 2. copies of written notice(s) which were sent to DBE potential subcontractors prior to bid opening;
 - 3. a detailed statement as to why each subcontractor contacted (i) was not willing to do the job or (ii) was not qualified to perform the work as solicited; and
 - 4. in the case(s) where a negotiated price could not be reached the bidder should detail what efforts were made to reach an agreement on a competitive price.
 - 5. copies of advertisements, dated not less than ten (10) days prior to bid opening, as appearing in general publications, trade-oriented publications, and applicable minority/women-focused media detailing the opportunities for participation;

- B. MassDEP may require the bidder to produce such additional information as it deems appropriate.
- C. No later than fifteen (15) days after submission of all required information and documentation, MassDEP shall make a determination, in writing, whether the waiver request is granted and shall provide that determination to the bidder and Awarding Authority. If the waiver request is denied, the facts upon which a denial is based will be set forth in writing.

CERTIFICATION

The undersigned herewith certifies that the above information and appropriate attachments are true and accurate to the best of my knowledge and that I have been authorized to act on behalf of the bidder in this matter.

(authorized original signature)

DATE

DEPARTMENT OF ENVIRONMENTAL PROTECTION
BUREAU OF WATER RESOURCES
DIVISION OF MUNICIPAL SERVICES POLICIES

The Division of Municipal Services (DMS) has established the following policies for all Division financially-assisted projects.

POLICY MEMORANDUM NO. PM-1

EASEMENTS AND RIGHTS OF WAY

Prior to the approval of financial assistance for construction, the owner shall obtain and shall thereafter retain, a fee simple or such estate or interest in the site of construction and rights of access as will assure undisturbed use and possession for the purpose of construction and operation for the estimated life of the project. The Division may refuse to approve financial assistance until it has received from the owner sufficient assurances that such interests have been obtained. Unless the Division otherwise notifies the owner, the certificate (under pains and penalties of perjury) of the owner's legal representative shall constitute such sufficient assurance.

Additional cost which result from interruptions of construction or extensions of contract time caused by the owner's failure to obtain the necessary interests in land shall be ineligible for financial assistance, and all such additional costs shall be borne by the owner.

POLICY MEMORANDUM NO. PM-2

PERMITS

The owner shall be responsible for identifying and obtaining all federal, state, local and railroad permits required by the nature and location of construction, including but not limited to building construction permits and permits for street and highway cuts and openings, and all such permits shall be listed in a separate permits section of the contract documents. To the extent possible, such permits shall be obtained by the owner prior to the solicitation of bids for construction, and copies of all permits so obtained shall be included in the said permits section. The status of the application for each permit, including the permit conditions, and costs, not obtained prior to the solicitation of bids shall also be indicated in the contract documents permits section. The Division may refuse to approve financial assistance for construction unless and until it has received from the owner sufficient assurances that all necessary permits have been or will be obtained prior to the commencement of construction.

DEP-DMS-PM Page 1 of 21

DEP-DMS-F Page 1 of 24

pspkg 2020-03-09

Policy Memorandum No. PM-2 – Permits (Con't)

The contractor shall be responsible for obtaining all permits required of his equipment, work force, or particular operations (such as blasting) in the performance of the contract and not otherwise specified in the two preceding paragraphs as to be obtained by the owner. These permit fees shall be paid by the contractor.

The owner shall be responsible for the payment of all other permit fees required by the construction.

The following permits shall not be eligible for financial participation by the Department of Environmental Protection (DEP).

- Permits and insurance for construction in railroads' rights of way;
- Building permits;
- Permits for opening public streets and other public or municipal rights of way;
- Permits for the use of explosives;
- Permits for the disposal of waste materials;
- Permits and fees for connecting to municipal utilities.

Permits required by extraordinary circumstances and not specifically excluded from eligibility above may be eligible for DEP participation. For such permits to be so eligible, the owner or his representative must notify the DEP project engineer in advance of obtaining such permit and receive from the engineer specific agreement that such permit will be eligible for DEP participation. Eligibility for such participation will not be made retroactively.

Additional costs which result from interruptions of construction or extensions of contract time resulting from the owner's or the contractor's failure to obtain the necessary permits may be ineligible for participation.

POLICY MEMORANDUM NO. PM-3

FIELD CONTROLS

The Owner shall be responsible for indicating on the contract drawings all easement limits and all property and other control lines for locating the principal component parts of the work together with those elevations and bench marks used in the design of the work, all hereinafter referred to as "field controls". Where easement and property limits have not previously been established in the field, the owner shall be responsible for establishment of such limits. From the information provided by the Owner, unless otherwise specified, the Contractor shall develop and make all layouts required for construction, such as slope stakes, batter boards, stakes for pipe locations and other working points, lines, elevations and cut sheets.

Whenever he has reason to believe that an error exists or whenever he is otherwise unable to locate the field controls, the contractor shall promptly notify the owner and the owner's engineer of such error with appropriate documentation.

DEP-DMS-PM Page 2 of 21

DEP-DMS-F Page 2 of 24

POLICY MEMORANDUM NO. PM-4**RECORD DRAWINGS**

The Owner shall be responsible for the preparation of all record drawings required by this contract. This responsibility may be delegated to the Owner's representative. The responsibility for preparation of record drawings shall not be delegated or transferred to the contractor. They may use the contractor's and sub-contractor's certified AS BUILT drawings along with their own marked up set in the preparation of the Record Drawings.

Division approved contract drawings shall be revised upon completion of the contract to reflect any changes made and/or final quantities, as appropriate.

POLICY MEMORANDUM NO. PM-5**PLAN SCALE**

Unless otherwise approved in advance by the Division, the horizontal scale for construction plans for non-structural facilities shall be 1" = 40'. A larger horizontal scale shall be used where appropriate to show sufficient detail to construct the project. The vertical scale for construction plans for non-structural facilities shall be 1" = 4'. Based on the best information available at the time of their preparation, the location of underground utilities and support structures for overhead utilities shall be shown on the plans.

Unless otherwise exempted in advance by the Division, construction plans shall be updated whenever the date of the advertisement for bids for the construction of such facilities is more than one year after the date of approval by the Division or EPA; and in the case of approval by both such agencies, the later approval date shall be used in determining the need for update.

The consulting engineer shall receive adequate compensation for updating plans and specifications, and such additional cost shall be eligible for assistance to the extent not otherwise prohibited by USEPA and Division regulations and program guidance.

All revision, or review without need for revision, shall be noted and dated on the plans prior to advertisement of the project for bid.

POLICY MEMORANDUM NO. PM-6**BORINGS LOGS**

All soil borings shall be taken as close as practicable to the construction line, and the location of all such borings shall be clearly indicated on the contract drawings. The plan view shall show the location and boring number of each boring. The profile view shall show the location, elevation, and depth of each soil boring, the location of each change in soil stratum, the groundwater level, and the average of blow counts at each five foot interval. As a minimum, boring logs to be submitted with the plans and specifications shall show the name of the company taking the borings, the soil classification, the number of blows per foot of penetration, the groundwater elevation, and the date on which the borings were taken.

As part of the submission of plans and specification for approval, the owner's representative shall include written justification for the lesser frequency and depth of borings where their interval is more than approximately 300' or their depth is less than 50% below depth of pipe invert.

POLICY MEMORANDUM NO. PM-7

BREAKDOWN OF BID ITEMS

The following items shall, where applicable, be listed separately in the bid documents.

- 1. Mobilization
- 2. Pavement
 - a. Municipal
 - i. temporary
 - ii. permanent
 - b. State
 - i. temporary
 - ii. permanent
- 3. Concrete cradle or encasement
(to be identified where applicable)
- 4. Rock-Excavation
- 5. Wood or steel sheeting left in place
- 6. Excavation of unsuitable materials below grade.
- 7. Select and/or borrow material
- 8. Dewatering
- 9. Special Dewatering (coffer dam)

Mobilization costs are the costs of initiating the contract, exclusive of the cost of materials. Payment for mobilization shall be a lump sum at the price bid for this item in the proposal and shall be payable when the contractor is operational on the site. For purposes of this policy, “operational” shall mean the substantial commencement of work on site.

The lump sum price bid for mobilization shall not exceed five per centum (5%) of the total amount of the bid.

POLICY MEMORANDUM NO. PM-8

PAVEMENT

All roads and trenches therein shall be refilled and repaved in accordance with specifications provided by the owner in the contract documents. Please note that this policy may be excludable on federally assisted projects where bid alternative items may be required (i.e. trench width vs. full width pavement). You are advised to seek project specific clarification.

Loan eligibility shall be limited to the following:

- A. Where the depth of the pipe invert is 0 to 8’, the maximum pavement widths which shall be eligible for financial assistance are as follows:

<u>Nominal Pipe Diameter</u>	<u>Maximum Eligible Widths</u>	
	<u>Initial Pavement</u>	<u>Permanent Trench</u>
0-24”	6’-6”	8’-6”

Where the nominal pipe diameter is greater than 24” the maximum eligible width for initial re-paving shall be the nominal diameter of the pipe plus four (4) feet, and for permanent trench re-paving the maximum eligible width shall be the nominal pipe diameter plus six (6) feet.

- B. For each additional four (4) feet (or fraction thereof) of pipe invert depth, add three feet to the eligible width limits stated in paragraph A.

At the design phase of a project the owner has the option to elect either Initial Pavement with Option I (Permanent Trench replacement) or Initial with Option II (curb to curb over initial)

Initial Pavement

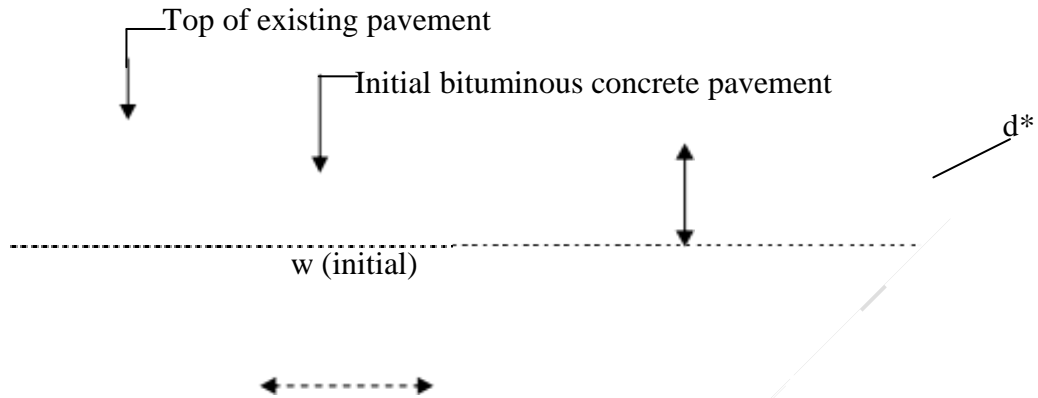

d* = depth of existing pavement to a maximum of 3 inches (see general notes #3)
w = maximum eligible Initial pavement width as described in paragraphs “A” & “B” on page DEP-DMS-CG’s-P4.

OPTION I Permanent Trench Pavement

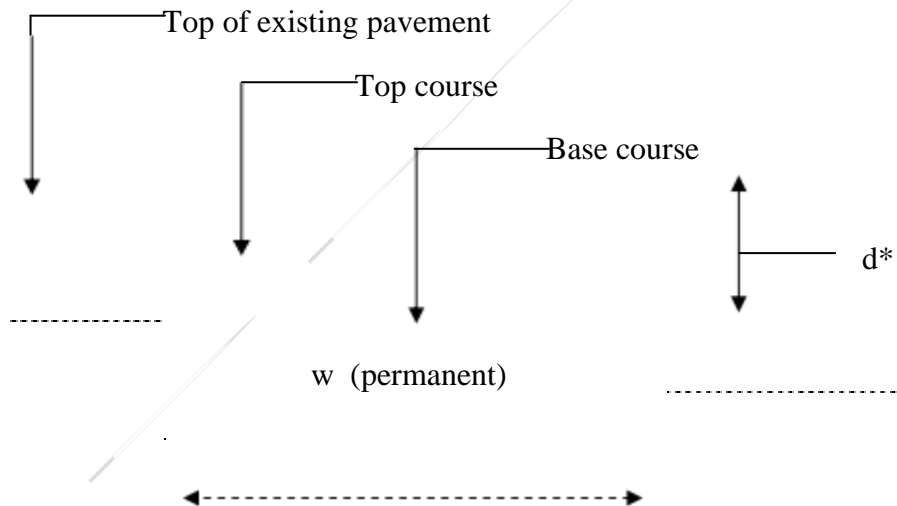

d* = depth of existing pavement trench to a maximum of 3 inches (see general notes #3)
w = maximum eligible permanent pavement width as described in paragraphs “A” & “B”.
equals initial width plus 2 feet and includes:

- Cutting edges for the permanent trench
- Removal of initial patch plus two feet of existing pavement
- Fine grading/compacting gravel
- Placement of Permanent Trench pavement in two courses.

OPTION II Curb to Curb Pavement (overlay pavement for roadways up to 28 feet)

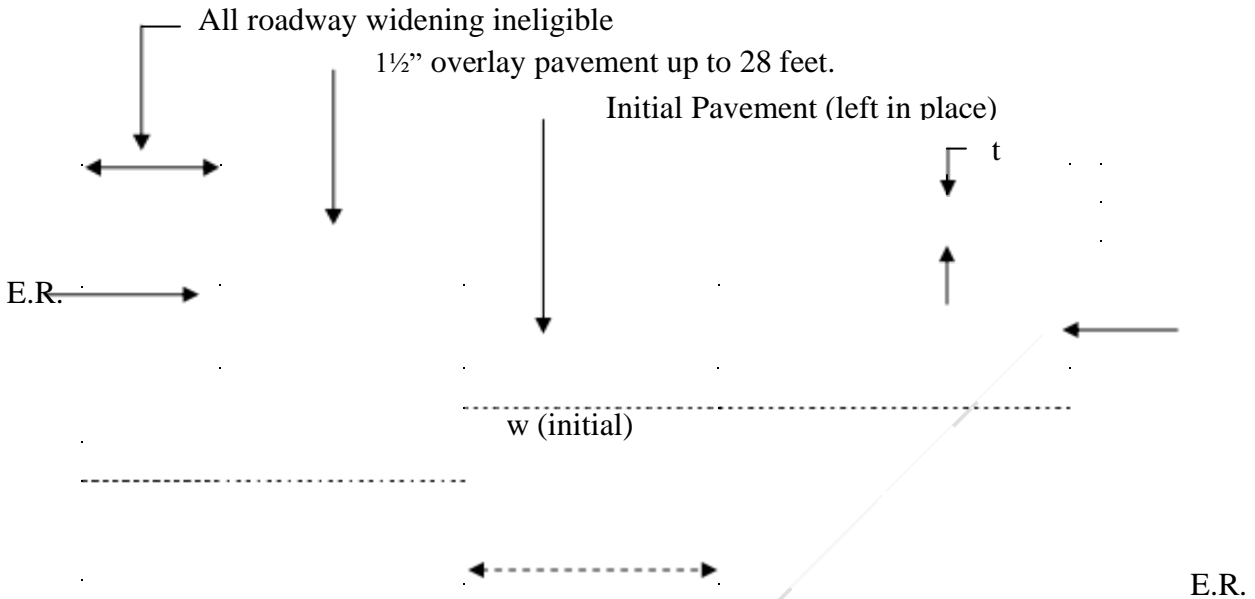

E.R.= edge of existing paved roadway

t = one and one half inch (1 1/2") overlay of bituminous concrete pavement

GENERAL NOTES:

1. Repavement of settled areas and crown restoration within the trench limits shall be the responsibility of the contractor.
2. Leveling outside the trench limits shall be the responsibility of the owner.
3. Sewer trench re-fill and pavement re-paving on public ways under the jurisdiction of the Massachusetts Department of Public Works, the Metropolitan District Commission, or other such agency shall be in accordance with permit(s) issued therefore by that Department or Commission, as the case may be.
4. The Division will consider requests for increase in the participating pay limits defined in paragraphs A and B, when such increases are, in the Division's opinion, reasonable. Such requests should be documented in writing and submitted to the Division in a timely manner.
5. Projects which deviate from the above options are required to seek Division review and approval.

POLICY MEMORANDUM NO. PM-9 PIPE TESTING

Monthly payment estimates shall be prepared in accordance with contract documents. All pipe shall be tested in accordance with the contract documents and sound engineering practice. If, after 60 days following submission of a monthly payment estimate for pipe items, the pipe for which payment is requested has not been successfully tested, the owner may withhold up to 10% of the amount requested for such pipe items until the pipe has been so tested. However, in the case of a major (pipe diameter 24 inches or greater) interceptor pipe installation, sums retained by the owner pursuant to this policy memorandum shall not exceed two per centum (2%) of the costs of such pipe items.

POLICY MEMORANDUM NO. PM-10

CHANGE ORDERS

Executed change orders submitted to the Division for review and processing for financial assistance must be prepared on the attached Change Order Forms (PM-10, Attachment 1, pages A-1 & A-2) with a duplicate copy, calculation sheet(s) (PM-10, Attachment 2), and all other supporting documentation necessary for evaluation. Failure to comply with these instructions will result in delays in processing the change order and/or limited financial assistance.

M.G.L. c.44, s.31C requires that the auditor, accountant, or other municipal officer having similar duties must certify that adequate funding in an amount sufficient to cover the total cost of the change order has been made. Change orders will not be processed or approved until this certification is made on the face of the Change Order Form (PM-10 Attachment 1).

Payment of Change Orders:

Payment of all change orders shall be in accordance with the relevant provisions of Massachusetts General laws, Chapter 30, Section 39G for non-building construction and Section 39K for building construction.

Payment of change orders shall be made in accordance with one of the following three methods:

- A. Existing unit prices as set forth in the contract; or
- B. Agreed upon lump sum or unit prices; or
- C. Time and materials

A. Payment for work for which there is a unit price in the contract:

Where the contract contains a unit price for work and the Engineer orders a change for work of the same kind as other work contained in the contract and is performed under similar physical conditions, the contractor may accept full and final payment at the contract unit price(s) for the acceptable quantities.

B. Payment for work or materials for which no price is contained in the contract:

If the Engineer directs, the contractor shall submit promptly in writing to the Engineer and offer to do the required work on a lump sum or unit price basis, as specified by the Engineer. The stated price, either lump sum or unit price, shall be divided so as to show that it is the sum of:

- (1) The estimated cost of labor, plus
- (2) Direct Labor Cost, plus
- (3) Material and Freight Costs, plus
- (4) Equipment Costs, plus
- (5) An amount not to exceed 20% of the sum of items (1) through (4) for overhead and profit, plus (if applicable),
- (6) In the case of work done by a subcontractor an amount not to exceed 7 ½ %, for the general contractor of the sum of items (1) through (4) for his overhead and profit, less, if applicable,
- (7) Credits for work deleted from the contract.

C. Payment for work on a time and materials basis:

Unless an agreed lump sum and/or unit price is obtained from above and is so stated in the change price, the contractor shall accept as full payment for which no other agreement is contained in contract, and amount equal to:

- (1) The estimated cost of Labor, plus
- (2) Direct Labor Cost, plus
- (3) Material and Freight Costs, plus
- (4) Equipment Costs, plus
- (5) An amount not to exceed 20% of the sum of items (1) through (4) for overhead and profit, plus (if applicable),
- (6) In the case of work done by a subcontractor an amount not to exceed 7 ½ %, for the general contractor of the sum of items (1) through (4) for his overhead and profit, less, if applicable,
- (7) Credits for work deleted from the contract.

Explanation of items (1) through (7) as outlined in “B” and “C”:

- (1) Labor – Only those workers employed on the project who are doing the extra work, including the foreman in charge, are allowable. General foremen, superintendents, or other supervisory personnel are considered to be included in the overhead markup as provided in items (5) and/or (6). Hourly labor rates in excess of those as listed in the contract wage rates (Federal or State, whichever applies) require documentation. As a minimum, an explanation and the appropriate copy of the certified payroll are required.

(2) Direct Labor Costs - These costs are limited to those which are required in the contract document. Coverage in excess of the contract provisions, secured by the contractor/subcontractor(s) at his option, are ineligible for financial assistance. The following list of typical direct labor charges is provided for your assistance and is in no way intended to be complete or all encompassing:

- Workman’s Compensation
- Federal/State: Social Security Tax and Unemployment Tax;
- Health, Welfare and Pension Benefits; (this cost is included in the wage rates appearing in the Mass. Wage Rates of the contract specifications)

- Liability Insurance: Bodily Injury;
 Excess Umbrella;
 Property damage;
 Public Liability

- Blasters Insurance)
)
 - Builders Risk Insurance)
)
 - Experience Modification Insurance)
)
 - Surcharges)
)
- If applied to any required direct labor costs.

Following the Notice of Intent to Award, the Owner shall require the Low Bidder to submit the percentage to be used for the Direct Labor Cost markup, along with the breakdown of how it is calculated (this number shall be required and submitted to MassDEP before and Authorization to Award is issued by DMS). This documented direct labor cost may be adjusted upon the submission of new documentation which demonstrates both how and why it has changed.

(3) Material and Freight – Only those materials required as a result of the change order and reasonable freight charges for delivery of same are allowable.

Policy Memorandum No. PM-10 – Change Orders (Con't)

(4) Equipment – Only the equipment required as a result of the change order is allowable. Equipment rental rates shall be governed by the current Nielson/Dataquest Rental Rate bluebook for Construction Equipment (the “Bluebook”). In determining the rental rate the following shall apply:

- (a) For equipment already on the project – the monthly prorated rental rate by the hourly use shall be applicable;
- (b) For equipment not on the project the daily rate, the weekly rate, or monthly rate will prevail, whichever will prove to be most cost effective. Small tools and manual equipment are examples of costs not allowable under this item. These costs are considered to be included in the overhead markup as provided in items (5) and/or (6) (1 month (normal use) = 176 hours)

(5) & (6) Overhead and Profit – All other costs not previously mentioned are considered to be included in this item, be it for the general contractor or subcontractor(s).

(7) Credits – Work deleted, material and equipment removed from the contractor, stored and/or returned shall be credited to the cost of the change order, less costs.

The Contractor shall furnish itemized statements of the cost of the work ordered and shall give the Engineer access to all accounts, bills and vouchers relating thereto; and unless the Contractor shall furnish such itemized statements, and access to all accounts, bills and vouchers, he shall not be entitled to payment for any items of extra work for which such information is sought by the Engineer. Deviations from any of the above will be reviewed for financial assistance on a case-by-case basis.

The change order will be prepared in such manner as to clearly separate Eligible and Ineligible Costs.

CHANGE ORDER FORM

PM-10 Attachment 1 Page 1 of 2

SRF Number _____
Public Entity _____
Contract Number _____
Change Order Number _____

Contract Amount (As Bid) \$ _____

Net Change in Contract Price (this change order) \$ _____

Total Adjusted Contract Price (including this and all other change orders) \$ _____

This change order extends the time to complete the work by _____ calendar days.

The extended completion date is _____

This change order checked by _____
(Chief) Resident Engineer Date

This change order is requested by: _____

This change order is recommended by: _____

Consultant Engineer P.E. Number Date

The undersigned agree to the terms of the change order.

Contractor Date

Owner Date

Certification of Appropriation under M.G.L. c.44, §31C: Adequate funding in an amount sufficient to cover the total cost of this change order is available.

By: _____
Certification Officer (Auditor, accountant, treasurer) Date

Do not write below: this space reserved for STATE AGENCY APPROVAL

DEP/DMS spkg 2020-03-09

CHANGE ORDER FORM (Continued)

PM-10 Attachment 1

Page 2 of 2

Public Entity _____

SRF No: _____ Contract No. _____ Change Order No. _____

Contract Title: _____

Owner's Name: _____

Owner's Address: _____

Contractor's Name: _____

Contractor's Address: _____

Description of Change

Reason for Change

DEP-DMS-PM Page 12 of 21

DEP-DMS-F Page 12 of 24

CALCULATION SHEET

(1)	Labor			
	Foreman	10 hrs @ \$10.00/hr.	\$	100.00
	Engineer	10 hrs @ 8.50/hr		85.00
	Operator	10 hrs @ 9.50/hr		95.00
	Laborers	24 hrs @ 7.00/hr		<u>168.00</u>
				\$448.00
(2)	Direct Labor Cost (use the agreed upon Direct Labor Cost)			
*	(30)% of \$448			
*	(Used for example purposes only)			134.00
(3)	Materials & Freight			
	150 l.f. of 12" pipe @ \$2.00/l.f.		\$	300.00
	15 v.f. precast SMH			1,700.00
	Freight (slip # _____ Enclosed)			<u>25.00</u>
				2,025.00
(4)	Equipment			
	1 Backhoe	10 hrs @ \$80.00/hr	\$	800.00
	1 Truck-crane	10 hrs @ \$100.00/hr		<u>1,000.00</u>
				1,800.00
		Total (Items 1 through 4)		<u>4,407.00</u>
(5)	20% markup for Overhead, Profit			
	20% of \$4,407			881.00
(6)	7 ½% markup for general contractor (if subcontractor is involved)			
	7 ½% of \$4,407			331.00
(7)	Credits (deductibles)			
				<u>- 323.00</u>
		Total Cost	\$	5,296.00

Reminder: Provide support documentation as necessary i.e. vouchers, correspondence, Calculation, photographs, reports

POLICY MEMORANDUM NO. PM-11

UTILITY RELOCATION

The construction of treatment facilities, sewers, pumping stations, force mains and appurtenant work can cause the relocation of utilities. Costly relocation can sometimes be minimized by early communication and cooperation of the representatives of the municipality (owner) and the utilities.

Every possible effort should be made by the owner and each utility to establish the location of existing utilities in the vicinity of the proposed construction. The owner or its consulting engineer should make every reasonable effort to design the proposed construction so that relocation of existing utilities is minimized whenever possible. If the proposed construction is in an area of many existing utilities or in an otherwise critical area, the utilities are encouraged to mark the location of their existing utilities at the site during the design phase of the project.

During the design phase of the project, the municipality should provide timely notice to all utilities known or thought to have facilities in or proximate to the site of such future construction.

POLICY MEMORANDUM NO. PM-12

**REFUNDABLE DEPOSITS FOR
PLANS AND SPECIFICATIONS**

For each set of project plans and specifications provided, the owner may require a deposit in form of cash or other appropriate security, in an amount sufficient to cover the costs of production of such plans and specifications.

Upon return of the plans and specifications to the owner within a reasonable time and in good condition, such deposit shall be refunded.

Actual mailing costs, if any, shall be borne by the party requesting such plans and specifications.

POLICY MEMORANDUM NO. PM-13

BID OPENING PROCEDURES

As a minimum, bid documents shall be reviewed/inspected for conformance to the following bid opening procedure in the order presented below. Failure to comply with any of these steps shall render the bid non-responsive and upon determination of such non-responsiveness, such bid shall be rejected immediately, set aside, and shall receive no further consideration.

Bid Opening Procedure

Step #1. **Timeliness** – The bid must be filed at the place and within the time specified therefore in the invitation to bid, and no bid shall be accepted after such time. The time at which a bid is filed should be time/date stamped or otherwise prominently noted on the bid;

Policy Memorandum No. PM-13 – Bid Opening Procedures (Con't)

Step #2. Bid Security – Properly executed bid security, in the amount and terms specified in the invitation to bid (equal to 5% of Base Bid or Highest Possible Amount considering all alternatives) shall be placed in a seal envelope and attached to the outside of the envelope containing the bid at the time of its submission;

A. Bid Bond

The Bid bond must be dated On or Before the Bid Date;
Issued by a Bonding Company Licensed in Massachusetts;
Accompanied by a Current Power of Attorney;
Signed by Surety;

B. Check

The Check must be a Certified, Cashiers or Bank Treasurer's;
Dated On or Before the Bid Date;

Step #3. Bid Signature – The bid and all accompanying documents so required shall be signed by the bidder or its authorized representative before submission;

Step #4. Addenda – All addenda shall be sent certified mail, return receipt requested, by the owner to all individuals and organizations which have received plans and specifications and shall be mailed not later than five days prior to the date established for submission of bids. All bidders shall include with their bids written acknowledgement of receipt of all addenda, which acknowledgement may be on a form provided therefore by the owner.

Alternates – Any Alternates shall be acknowledged.

Step #5. Written Dollar Amounts – The total dollar amount of each bid shall be read, and the three lowest bids shall be selected for further consideration. The remaining bids shall then be set aside. The three apparent low bids shall be read to determine whether the unit price for each line item of each bid has been written therein in words. If it has not, such bid shall be rejected and shall receive no further consideration. ***Bid amounts shall be consistent (words vs. numbers) and if words and numbers differ, the words govern.*** This procedure shall then be repeated with the next apparent low bid until three are acceptable which have all the unit prices written in words, at which time the lowest bid shall be announced as the apparent low bidder, and the bid opening procedure shall be closed.

The Division recommends that this policy memorandum be included in all contract specifications and that the owner's evaluator(s) use the attached form (PM-13 Attachment 1) for bid opening procedures.

The Contractor's Bid Opening Checklist also attached hereto, is for use by each contractor to assure that his bid conforms with this policy memorandum. It is recommended that the checklist (PM-13 Attachment 2) be included in information for bidders, or at the end of the bid proposal, or in some other prominent part of the bid specifications

FORM FOR BID OPENING PROCEDURES
(to be completed by the owner's evaluator(s))

CONTRACT NO.: _____

DATE: _____

CONTRACT NAME: _____

BID OPENING TIME: _____

All non-responsive bids shall be rejected forthwith by the awarding authority upon determination of such bids' non-responsiveness at the time bids are opened and read. Failure to comply with any one of the requirements shall render the bid non-responsive, and upon determination of such non-responsiveness such bid shall be rejected and receive no further consideration.

	BIDDER	A = Acceptable			N-R = Non-Responsive (explain reasons on supplemental sheet & attach)		COMPLIANCE (CIRCLE ONE)		
		1. TIMELINESS	2. BID SECURITY	3. SIGNATURE	4. ADDENDA ALTERNATIVES	5. DOLLAR AMOUNTS	WRITTEN	YES	NO
1		_____	_____	_____	_____	_____	_____	YES	NO
2		_____	_____	_____	_____	_____	_____	YES	NO
3		_____	_____	_____	_____	_____	_____	YES	NO
4		_____	_____	_____	_____	_____	_____	YES	NO
5		_____	_____	_____	_____	_____	_____	YES	NO
6		_____	_____	_____	_____	_____	_____	YES	NO
7		_____	_____	_____	_____	_____	_____	YES	NO
8		_____	_____	_____	_____	_____	_____	YES	NO
9		_____	_____	_____	_____	_____	_____	YES	NO
10		_____	_____	_____	_____	_____	_____	YES	NO
11		_____	_____	_____	_____	_____	_____	YES	NO
12		_____	_____	_____	_____	_____	_____	YES	NO

Evaluator(s)

POLICY MEMORANDUM NO. PM-14

PAYMENT FOR ROCK EXCAVATION

There shall be in the contract documents a separate pay item for rock excavation. For such purposes, “rock” shall mean igneous, sedimentary, metamorphic, and conglomerate rock, which for excavation must be drilled, blasted, broken, or ripped by power tools. Boulders and concrete structures one cubic yard or greater, however removed, are included within this definition of rock for payment purposes. At the option of the owner or his representative a separate pay item for boulders, concrete structures, or concrete road base may be used.

<u>Depth From Ground Surface</u> <u>To Invert Pipe</u>	<u>Pay Width</u> <u>(Nominal Pipe Diameter)</u>	
* 0 – 12’	0-24”	Over 24”
* Over 12’ – 20’	5’0”	D+3’0”
	7’0”	D+5’

Engineer’s plans and specifications shall establish pay limits below pipe and structures.

- See PM-14 Attachment 1 (typical cross section)

Payment width for depths over twenty feet (20’) shall be determined on a case-by-case basis consistent with the foregoing chart.

The pay limit for rock removal outside proposed manholes shall commence one foot (1’) outside the widest dimension of the structure of shall be the maximum connecting trench width, whichever is greater.

Payment depth for rock which is encountered in a trench shall be no less than three feet (3’) when removal can be accomplished only by drilling and blasting or by use of jack (air or hydraulic) hammers.

Payment for rock removed, using the same or equal equipment as utilized for normal trench excavation, shall be limited to the actual depth removed within the limits established by the contract documents.

Boulders encountered within the pay limits of excavation, whose volume is one cubic yard or greater, part of which extends outside said limits shall be paid in accordance with the actual volume excavated.

CG-14 ROCK EXCAVATION

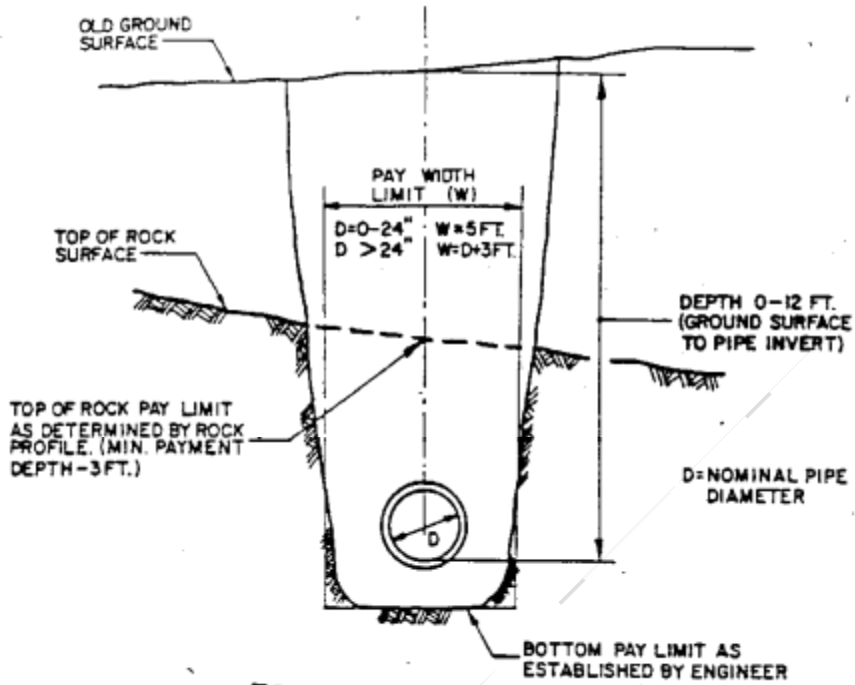

FOR DEPTH 0 TO 12 FEET

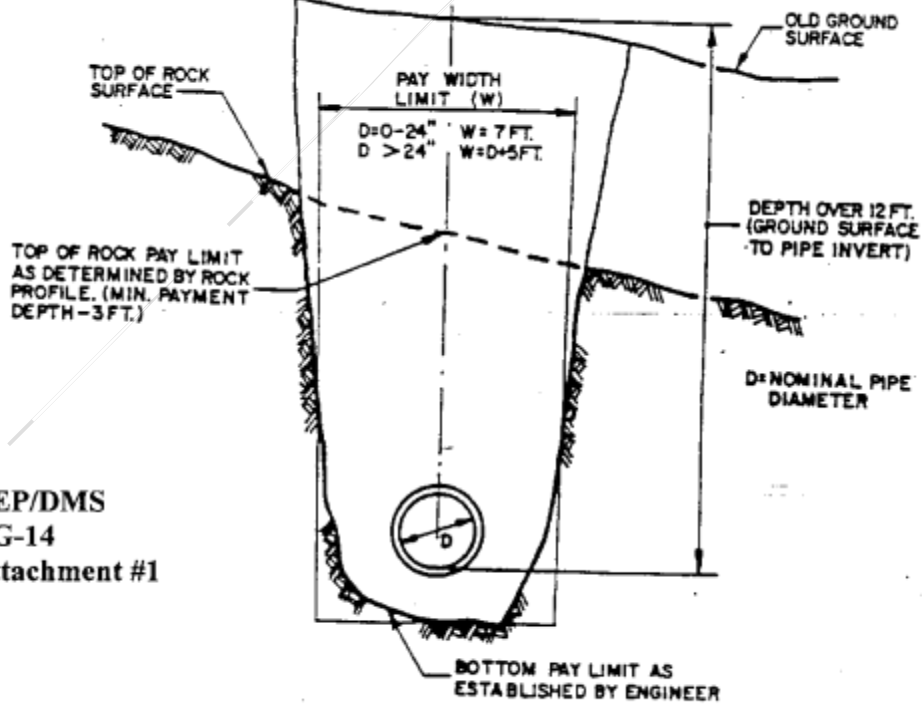

FOR DEPTH OVER 12 FEET AND UP TO 20 FEET

DEP/DMS
CG-14
Attachment #1

POLICY MEMORANDUM NO. PM-15

TRAFFIC POLICE

The reasonable costs for police details required for traffic control on a construction project which receives financial assistance shall be considered as an eligible administrative cost. A police detail item shall not be included as a bid item in the contract documents.

“Police” as used in this memorandum includes local, county, capital, state, regular and auxiliary police.

Owner’s Responsibility

It shall be the owner’s responsibility to submit in writing the hourly rate of pay to be established for detailed traffic police and each change in rate during the course of the project. It is the owner’s responsibility to arrange, document and pay for such police details. The owner or its representative shall meet with the police chief or other officer in charge of police detail duty to review contract needs. The owner shall maintain a daily record of the following:

- a. Officer’s name
- b. Hours worked
- c. Location of assignment
- d. Hourly rate

POLICY MEMORANDUM NO. PM-16

**DOCUMENTATION REQUIRED TO
SUBSTANTIATE CONTRACT QUANTITIES**

<u>Unit</u>	<u>Documentation required</u>
Acres (A)	Location, station, offset and calculations. Location = Street right-of-way, etc; Station = Point on Baseline; Offset = Distance left or right of Baseline
Cubic Yard (C.Y.)	Location, stations, widths, depths, calculations and Cross sections as necessary
Each (Ea.)	Location, station, and offset.
Gallon (Gal.)	Location, stations, calculations (if appropriate) and delivery slips.
Hour (Hr.)	Hours and location.
Linear Feet (L.F.)	Location, stations, and offsets.
Month (Mo.)	Location, period of time and calculations if applicable.

1000 Foot Board Measure (MFBM)	Location, stations, offset, elevations, grade, and calculations. Attach invoices where applicable.
Pound (Lb.)	Locations, stations, and calculations (if applicable). Attach Delivery weight slips.
Square Feet (S.F.)	Locations, stations and calculations
Square Yard (S.Y.)	Locations, stations and calculations
Ton	Locations, stations and calculations (if applicable). Attach Delivery weight slips.
Vertical Feet (V.F.)	Locations, stations, elevations, and offsets.

Note:

1. All of the above, that apply must be submitted with a final payment request or change order as applicable.
2. Where in place measurement is not possible or practical, delivery slips may be used to substantiate quantities. 3. Change orders – See PM-10 in which some of the above may be applicable in justifying materials, equipment and labor.
4. When necessary, itemized quantities must be separated into eligible and non-eligible units with separate calculations to justify eligible costs.
5. Overruns and underruns of any specific item shall be explained with an appropriate sentence or paragraph.
6. On all quantities, units of payment shall be maintained at the project site and shall be updated daily so that upon field inspection by the C.O.E., EPA or DMS, the quantities paid to date can be substantiated.
7. In the case of unforeseen conditions, photos should be submitted with the applicable item in addition to the recommended documentation.
8. Documentation of units of payment shall be clearly legible and cross referenced to the applicable sheets of the record drawings.
9. For record drawings policy, please see PM-4.

DMS Policies 1 through 16 Approved By:

Steven J. McCurdy
Division of Municipal Services

DEP-DMS-PM Page 21 of 21

DEP-DMS-F Page 21 of 24

DWS POLICY 88-02
DEPARTMENT OF ENVIRONMENTAL PROTECTION
POLICY FOR REVIEW OF SEWER LINE/WATER SUPPLY PROTECTION

The Department of Environmental Protection seeks to protect existing and potential water supplies from the potentially negative effects of leaking sewer lines through the adoption of a Department policy on this subject.

The following restrictions will apply to new sewer construction statewide:

Gravel Packed Wells

- ~ Within the 400 foot radius protective distance around gravel packed wells, all sewer lines and appurtenances are prohibited, unless they are necessary to eliminate existing and/or potential sources of pollution to the well.

Tubular Wells

- ~ Within the 250 foot radius protective distance around tubular wells, all sewer lines and appurtenances are prohibited, unless they are necessary to eliminate existing and/or potential sources of pollution to the well.

Gravel Packed and Tubular Wells

- ~ Within a minimum radius of 2,640 feet or unless otherwise documented by an appropriate study specifically defining the area of influence and approved by the Division of Water Supply, all sewer lines and appurtenances will be designed and constructed for maximum water tightness.
- Force Mains or Pressure Sewers: shall be tested at 150% above maximum operating pressure or 150 p.s.i. whichever is greater. Testing shall conform to the requirements of the American Water works Association (AWWA) standard c 600.
- Gravity Sewers: shall be tested by approved methods which will achieve test results for infiltration or exfiltration of less than 100 gallons/inch diameter/mile/24 hours.
- Manholes: shall be installed with watertight covers with locking or bolted and gasketed assemblies. Testing for infiltration/exfiltration shall conform to the same standards as the maximum allowed for pipes in the manhole as required for gravity sewers, indicated above.
- Satisfactory test results for Force Mains, Manholes and Gravity Sewers shall be performed prior to the expiration of the contractor's one year guarantee period.
- All pumping stations within this zone shall have standby power high water alarms telemetered to an appropriated location that is manned at all times. An emergency contingency plan must be developed by the owner and approved by the BWR.
- A minimum of Class B bedding as defined by WPCF-MOP9 must be used for all piping.
- Service connections (laterals and house connections) shall be rigidly inspected by the appropriate municipal official. Certified inspection reports shall be submitted to the BWR.

Bedrock Wells

The above requirements are the same for bedrock wells, with the Department reserving the right to require more stringent controls on a case-by-case basis.

Surface Water Supplies

- ~ Within 100 feet of all surface water supplies and tributaries all sewer lines and appurtenances are prohibited except as required to cross tributaries or to eliminate existing or potential pollution to the water supply. In the latter case, watertight construction methods shall be use.
- ~ Tributary stream crossings shall employ watertight construction methods of sewer lines and manholes. Watertight construction must extend 100 feet to either side of the stream.
- ~ Within 1,000 feet of surface water supplies and tributaries, all pumping stations shall have standby power and high water alarms telemetered to an appropriate location that is manned at all times. An emergency contingency plan must be developed by the owner of the wastewater treatment facility and submitted to the BWR for approval.
- ~ Beyond 1,000 feet and within the watershed of surface water supplies the Department may in specific circumstances after review, require additional controls.

Potential Public Water Supplies

The above requirements also apply to potential public water supplies.

Baseline Data Requirements

Two (2) copies of an appropriately scaled map(s) shall be submitted to the Department which details the proposed sewers and/or appurtenances and also includes the following:

- (1) the location of all nearby existing or potential surface water supplies, tributaries thereto, and watershed boundaries;
- (2) the location of existing and potential public and municipal potable groundwater supply wells.

The Department reserves the right to impose more restrictive measures than those contained in this policy as deemed appropriate.

Definitions

- Appurtenances – all attachments to sewer lines necessary for the transport and operation and maintenance of sewer lines, including manholes, pumping station, siphons, etc.
- Area of influence – that area of an aquifer which contributes water to a well under the most severe recharge and pumping condition that can be realistically anticipated (i.e. pumping at the safe yield of the well for 180 days without any natural recharge occurring). It is bounded by the groundwater divides which result from pumping the well and by the contact of the edge of the aquifer with less permeable materials such as till and bedrock. At some locations, streams and lakes may form recharge boundaries.
- Potential public water supply – areas designated by communities for water supply purposes where land has been set aside and Department approved pump tests conducted and surface water supplies as defined below.
- Surface Water Supply – Waters classified as Class A by the DWPC.
- Public Water Supply Systems – as defined in 310 CMR 22.02 (DEP Drinking Water Regulations).
- Class B Bedding – as defined in WPCF Manual of Practice No. 9.

APPROVED: (Signature on File)

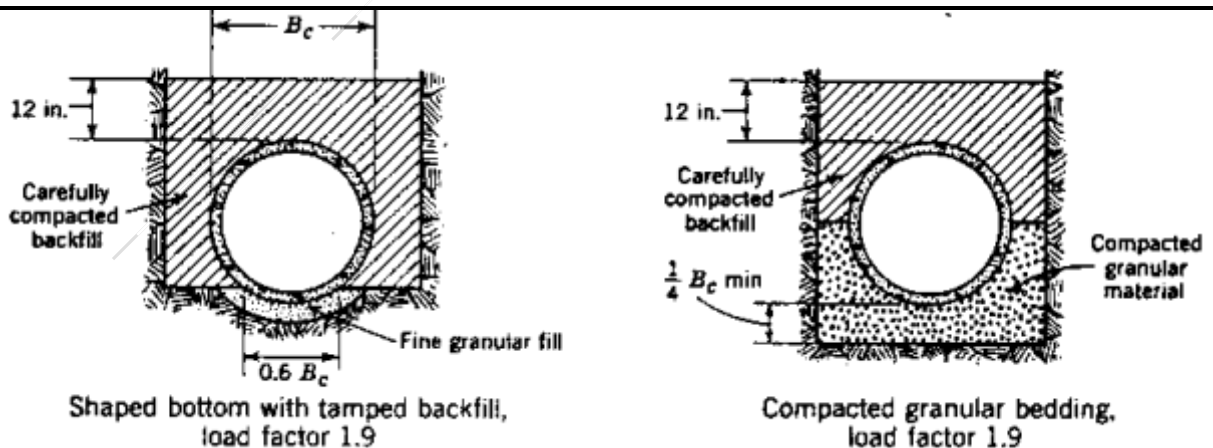

Class B---First-Class Bedding – Class B bedding may be achieved by either of two construction methods:

- a. Shaped Bottom with Tamped Backfill. The bottom of the trench excavation shall be

shaped to conform to a cylindrical surface with a radius at least 2 in. (5 cm) greater than the radius to the outside of the pipe and with a width sufficient to allow six-tenths of the width of the pipe barrel to be bedded in fine granular fill placed in the shaped excavation.

Carefully compacted backfill shall be placed at

the sides of the pipe to a thickness of at least 12 in. (30 cm) above the top of the pipe.

Shaped trench bottoms are difficult to achieve under current construction conditions.

- b. **Compacted Granular Bedding with Tamped Backfill.** The pipe shall be bedded in compacted granular material placed on a flat trench bottom. The granular bedding shall have a minimum thickness of one-fourth the outside pipe diameter and shall extend halfway up the pipe barrel at the sides. The remainder of the side fills and a minimum depth of 12 in. (30 cm) over the top of the pipe shall be filled with carefully compacted material.

APPENDIX G
Davis Bacon Act Requirements

All construction projects are subject to the Davis Bacon wage rate requirements and must include the appropriate sections of the following document in its entirety in the contract documents.

The vast majority of SRF projects will be bid by Governmental Entities (i.e., Cities, Towns, Authorities, Water Districts, Wastewater Districts). These projects must include the following language in construction contracts:

I.3. Contract and Subcontract Provisions

I.4. Contract Provisions for Contracts in Excess of \$100,000 (if applicable)

I.5. Compliance Verification

This language may be found on pages DB-3-DB-11.

In certain cases, SRF projects may be bid by non-Governmental Entities (i.e., private water companies, private PWSs, etc.). These projects must include the following language in construction contracts:

II.3. Contract and Subcontract Provisions

II.4. Contract Provisions for Contracts in Excess of \$100,000 (if applicable)

II.5. Compliance Verification

This language may be found on pages DB-11-DB-21

Preamble

With respect to the Clean Water and Safe Drinking Water State revolving Funds, EPA provides capitalization grants to each State which in turn provides subgrants or loans to eligible entities within the State. Typically, the subrecipients are municipal or other local governmental entities that manage the funds. For these types of recipients, the provisions set forth under Roman Numeral I, below, shall apply. Although EPA and the State remain responsible for ensuring subrecipients' compliance with the wage rate requirements set forth herein, those subrecipients shall have the primary responsibility to maintain payroll records as described in Section 3(ii)(A), below and for compliance as described in Section I-5.

Occasionally, the subrecipient may be a private for profit or not for profit entity. For these types of recipients, the provisions set forth in Roman Numeral II, below, shall apply. Although EPA and the State remain responsible for ensuring subrecipients' compliance with the wage rate requirements set forth herein, those subrecipients shall have the primary responsibility to maintain payroll records as described in Section II-3(ii)(A), below and for compliance as described in Section II-5.

I. Requirements For Subrecipients That Are Governmental Entities:

The following terms and conditions specify how recipients will assist EPA in meeting its Davis-Bacon (DB) responsibilities when DB applies to EPA awards of financial assistance with respect to State recipients and subrecipients that are governmental entities. If a subrecipient has

questions regarding when DB applies, obtaining the correct DB wage determinations, DB provisions, or compliance monitoring, it may contact the State recipient. If a State recipient needs guidance, the recipient may contact Valerie Marshall at EPA Region 1 (617-918-1674) for guidance. The recipient or subrecipient may also obtain additional guidance from DOL's web site at <https://www.dol.gov/whd/govcontracts/dbra.htm>

1. Applicability of the Davis- Bacon (DB) prevailing wage requirements.

DB prevailing wage requirements apply to the construction, alteration, and repair of treatment works carried out in whole or in part with assistance made available by a State water pollution control revolving fund and to any construction project carried out in whole or in part by assistance made available by a drinking water treatment revolving loan fund. If a subrecipient encounters a unique situation at a site that presents uncertainties regarding DB applicability, the subrecipient must discuss the situation with the recipient State before authorizing work on that site.

2. Obtaining Wage Determinations.

(a) Subrecipients shall obtain the wage determination for the locality in which a covered activity subject to DB will take place prior to issuing requests for bids, proposals, quotes or other methods for soliciting contracts (solicitation) for activities subject to DB. These wage determinations shall be incorporated into solicitations and any subsequent contracts. Prime contracts must contain a provision requiring that subcontractors follow the wage determination incorporated into the prime contract.

(i) While the solicitation remains open, the subrecipient shall monitor www.wdol.gov weekly to ensure that the wage determination contained in the solicitation remains current. The subrecipients shall amend the solicitation if DOL issues a modification more than 10 days prior to the closing date (i.e. bid opening) for the solicitation. If DOL modifies or supersedes the applicable wage determination less than 10 days prior to the closing date, the subrecipients may request a finding from the State recipient that there is not a reasonable time to notify interested contractors of the modification of the wage determination. The State recipient will provide a report of its findings to the subrecipient.

(ii) If the subrecipient does not award the contract within 90 days of the closure of the solicitation, any modifications or supersedes DOL makes to the wage determination contained in the solicitation shall be effective unless the State recipient, at the request of the subrecipient, obtains an extension of the 90 day period from DOL pursuant to 29 CFR 1.6(c)(3)(iv). The subrecipient shall monitor www.wdol.gov on a weekly basis if it does not award the contract within 90 days of closure of the solicitation to ensure that wage determinations contained in the solicitation remain current.

(b) If the subrecipient carries out activity subject to DB by issuing a task order, work assignment or similar instrument to an existing contractor (ordering instrument) rather than by publishing a solicitation, the subrecipient shall insert the appropriate DOL wage determination from www.wdol.gov into the ordering instrument.

(c) Subrecipients shall review all subcontracts subject to DB entered into by prime contractors to verify that the prime contractor has required its subcontractors to include the applicable wage determinations.

(d) As provided in 29 CFR 1.6(f), DOL may issue a revised wage determination applicable to a subrecipient's contract after the award of a contract or the issuance of an ordering instrument if DOL determines that the subrecipient has failed to incorporate a wage determination or has used a wage determination that clearly does not apply to the contract or ordering instrument. If this occurs, the subrecipient shall either terminate the contract or ordering instrument and issue a revised solicitation or ordering instrument or incorporate DOL's wage determination retroactive to the beginning of the contract or ordering instrument by change order. The subrecipient's contractor must be compensated for any increases in wages resulting from the use of DOL's revised wage determination.

3. Contract and Subcontract provisions.

(a) The Recipient shall insure that the subrecipient(s) shall insert in full in any contract in excess of \$2,000 which is entered into for the actual construction, alteration and/or repair, including painting and decorating, of a treatment work under the CWSRF or a construction project under the DWSRF financed in whole or in part from Federal funds or in accordance with guarantees of a Federal agency or financed from funds obtained by pledge of any contract of a Federal agency to make a loan, grant or annual contribution (except where a different meaning is expressly indicated), and which is subject to the labor standards provisions of any of the acts listed in § 5.1 or the FY 2012 Appropriations Act, the following clauses:

(1) Minimum wages.

(i) All laborers and mechanics employed or working upon the site of the work will be paid unconditionally and not less often than once a week, and without subsequent deduction or rebate on any account (except such payroll deductions as are permitted by regulations issued by the Secretary of Labor under the Copeland Act (29 CFR part 3)), the full amount of wages and bona fide fringe benefits (or cash equivalents thereof) due at time of payment computed at rates not less than those contained in the wage determination of the Secretary of Labor which is attached hereto and made a part hereof, regardless of any contractual relationship which may be alleged to exist between the contractor and such laborers and mechanics.

Contributions made or costs reasonably anticipated for bona fide fringe benefits under section 1(b)(2) of the Davis-Bacon Act on behalf of laborers or mechanics are considered wages paid to such laborers or mechanics, subject to the provisions of paragraph (a)(1)(iv) of this section; also, regular contributions made or costs incurred for more than a weekly period (but not less often than quarterly) under plans, funds, or programs which cover the particular weekly period, are deemed to be constructively made or incurred during such weekly period. Such laborers and mechanics shall be paid the appropriate wage rate and fringe benefits on the wage determination for the classification of work actually performed, without regard to skill, except as provided in §5.5(a)(4). Laborers or mechanics performing work in more than one classification may be compensated at the rate specified for each classification for the time actually worked therein:

Provided, that the employer's payroll records accurately set forth the time spent in each classification in which work is performed. The wage determination (including any additional classification and wage rates conformed under paragraph (a)(1)(ii) of this section) and the Davis-Bacon poster (WH-1321) shall be posted at all times by the contractor and its subcontractors at the site of the work in a prominent and accessible place where it can be easily seen by the workers. Subrecipients may obtain wage determinations from the U.S. Department of Labor's web site, www.dol.gov.

(ii)(A) The subrecipient(s), on behalf of EPA, shall require that any class of laborers or mechanics, including helpers, which is not listed in the wage determination and which is to be employed under the contract shall be classified in conformance with the wage determination. The State award official shall approve a request for an additional classification and wage rate and fringe benefits therefore only when the following criteria have been met:

- (1) The work to be performed by the classification requested is not performed by a classification in the wage determination; and
- (2) The classification is utilized in the area by the construction industry; and
- (3) The proposed wage rate, including any bona fide fringe benefits, bears a reasonable relationship to the wage rates contained in the wage determination.

(B) If the contractor and the laborers and mechanics to be employed in the classification (if known), or their representatives, and the subrecipient(s) agree on the classification and wage rate (including the amount designated for fringe benefits where appropriate), documentation of the action taken and the request, including the local wage determination shall be sent by the subrecipient (s) to the State award official. The State award official will transmit the request, to the Administrator of the Wage and Hour Division, Employment Standards Administration, U.S. Department of Labor, Washington, DC 20210 and to the EPA DB Regional Coordinator concurrently. The Administrator, or an authorized representative, will approve, modify, or disapprove every additional classification request within 30 days of receipt and so advise the State award official or will notify the State award official within the 30-day period that additional time is necessary.

(C) In the event the contractor, the laborers or mechanics to be employed in the classification or their representatives, and the subrecipient(s) do not agree on the proposed classification and wage rate (including the amount designated for fringe benefits, where appropriate), the award official shall refer the request and the local wage determination, including the views of all interested parties and the recommendation of the State award official, to the Administrator for determination. The request shall be sent to the EPA DB Regional Coordinator concurrently. The Administrator, or an authorized representative, will issue a determination within 30 days of receipt of the request and so advise the contracting officer or will notify the contracting officer within the 30-day period that additional time is necessary.

(D) The wage rate (including fringe benefits where appropriate) determined pursuant to paragraphs (a)(1)(ii)(B) or (C) of this section, shall be paid to all workers performing work in the classification under this contract from the first day on which work is performed in the classification.

(iii) Whenever the minimum wage rate prescribed in the contract for a class of laborers or mechanics includes a fringe benefit which is not expressed as an hourly rate, the contractor shall either pay the benefit as stated in the wage determination or shall pay another bona fide fringe benefit or an hourly cash equivalent thereof.

(iv) If the contractor does not make payments to a trustee or other third person, the contractor may consider as part of the wages of any laborer or mechanic the amount of any costs reasonably anticipated in providing bona fide fringe benefits under a plan or program, Provided, That the Secretary of Labor has found, upon the written request of the contractor, that the applicable standards of the Davis-Bacon Act have been met. The Secretary of Labor may require the contractor to set aside in a separate account assets for the meeting of obligations under the plan or program.

(2) Withholding. The subrecipient(s), shall upon written request of the EPA Award Official or an authorized representative of the Department of Labor, withhold or cause to be withheld from the contractor under this contract or any other Federal contract with the same prime contractor, or any other federally-assisted contract subject to Davis-Bacon prevailing wage requirements, which is held by the same prime contractor, so much of the accrued payments or advances as may be considered necessary to pay laborers and mechanics, including apprentices, trainees, and helpers, employed by the contractor or any subcontractor the full amount of wages required by the contract. In the event of failure to pay any laborer or mechanic, including any apprentice, trainee, or helper, employed or working on the site of the work, all or part of the wages required by the contract, the (Agency) may, after written notice to the contractor, sponsor, applicant, or owner, take such action as may be necessary to cause the suspension of any further payment, advance, or guarantee of funds until such violations have ceased.

(3) Payrolls and basic records.

(i) Payrolls and basic records relating thereto shall be maintained by the contractor during the course of the work and preserved for a period of three years thereafter for all laborers and mechanics working at the site of the work. Such records shall contain the name, address, and social security number of each such worker, his or her correct classification, hourly rates of wages paid (including rates of contributions or costs anticipated for bona fide fringe benefits or cash equivalents thereof of the types described in section 1(b)(2)(B) of the Davis-Bacon Act), daily and weekly number of hours worked, deductions made and actual wages paid. Whenever the Secretary of Labor has found under 29 CFR 5.5(a)(1)(iv) that the wages of any laborer or mechanic include the amount of any costs reasonably anticipated in providing benefits under a plan or program described in section 1(b)(2)(B) of the Davis-Bacon Act, the contractor shall maintain records which show that the commitment to provide such benefits is enforceable, that the plan or program is financially responsible, and that the plan or program has been communicated in writing to the laborers or mechanics affected, and records which show the costs anticipated or the actual cost incurred in providing such benefits. Contractors employing apprentices or trainees under approved programs shall maintain written evidence of the registration of apprenticeship programs and certification of trainee programs, the registration of the apprentices and trainees, and the ratios and wage rates prescribed in the applicable programs.

(ii)(A) The contractor shall submit weekly, for each week in which any contract work is performed, a copy of all payrolls to the subrecipient, that is, the entity that receives the sub-grant or loan from the State capitalization grant recipient. Such documentation shall be available on request of the State recipient or EPA. As to each payroll copy received, the subrecipient shall provide written confirmation in a form satisfactory to the State indicating whether or not the project is in compliance with the requirements of 29 CFR 5.5(a)(1) based on the most recent payroll copies for the specified week. The payrolls shall set out accurately and completely all of the information required to be maintained under 29 CFR 5.5(a)(3)(i), except that full social security numbers and home addresses shall not be included on the weekly payrolls. Instead the payrolls shall only need to include an individually identifying number for each employee (e.g., the last four digits of the employee's social security number). The required weekly payroll information may be submitted in any form desired. Optional Form WH-347 is available for this purpose from the Wage and Hour Division Web site at <https://www.dol.gov/whd/forms/wh347.pdf> or its successor site. The prime contractor is responsible for the submission of copies of payrolls by all subcontractors. Contractors and subcontractors shall maintain the full social security number and current address of each covered worker, and shall provide them upon request to the subrecipient(s) for transmission to the State or EPA if requested by EPA, the State, the contractor, or the Wage and Hour Division of the Department of Labor for purposes of an investigation or audit of compliance with prevailing wage requirements. It is not a violation of this section for a prime contractor to require a subcontractor to provide addresses and social security numbers to the prime contractor for its own records, without weekly submission to the subrecipient(s).

(B) Each payroll submitted shall be accompanied by a "Statement of Compliance," signed by the contractor or subcontractor or his or her agent who pays or supervises the payment of the persons employed under the contract and shall certify the following:

(1) That the payroll for the payroll period contains the information required to be provided under § 5.5 (a)(3)(ii) of Regulations, 29 CFR part 5, the appropriate information is being maintained under § 5.5 (a)(3)(i) of Regulations, 29 CFR part 5, and that such information is correct and complete;

(2) That each laborer or mechanic (including each helper, apprentice, and trainee) employed on the contract during the payroll period has been paid the full weekly wages earned, without rebate, either directly or indirectly, and that no deductions have been made either directly or indirectly from the full wages earned, other than permissible deductions as set forth in Regulations, 29 CFR part 3;

(3) That each laborer or mechanic has been paid not less than the applicable wage rates and fringe benefits or cash equivalents for the classification of work performed, as specified in the applicable wage determination incorporated into the contract.

(C) The weekly submission of a properly executed certification set forth on the reverse side of Optional Form WH-347 shall satisfy the requirement for submission of the "Statement of Compliance" required by paragraph (a)(3)(ii)(B) of this section.

(D) The falsification of any of the above certifications may subject the contractor or subcontractor to civil or criminal prosecution under section 1001 of title 18 and section 231 of title 31 of the United States Code.

(iii) The contractor or subcontractor shall make the records required under paragraph (a)(3)(i) of this section available for inspection, copying, or transcription by authorized representatives of the State, EPA or the Department of Labor, and shall permit such representatives to interview employees during working hours on the job. If the contractor or subcontractor fails to submit the required records or to make them available, the Federal agency or State may, after written notice to the contractor, sponsor, applicant, or owner, take such action as may be necessary to cause the suspension of any further payment, advance, or guarantee of funds. Furthermore, failure to submit the required records upon request or to make such records available may be grounds for debarment action pursuant to 29 CFR 5.12.

(4) Apprentices and trainees--

(i) Apprentices. Apprentices will be permitted to work at less than the predetermined rate for the work they performed when they are employed pursuant to and individually registered in a bona fide apprenticeship program registered with the U.S. Department of Labor, Employment and Training Administration, Office of Apprenticeship Training, Employer and Labor Services, or with a State Apprenticeship Agency recognized by the Office, or if a person is employed in his or her first 90 days of probationary employment as an apprentice in such an apprenticeship program, who is not individually registered in the program, but who has been certified by the Office of Apprenticeship Training, Employer and Labor Services or a State Apprenticeship Agency (where appropriate) to be eligible for probationary employment as an apprentice. The allowable ratio of apprentices to journeymen on the job site in any craft classification shall not be greater than the ratio permitted to the contractor as to the entire work force under the registered program. Any worker listed on a payroll at an apprentice wage rate, who is not registered or otherwise employed as stated above, shall be paid not less than the applicable wage rate on the wage determination for the classification of work actually performed. In addition, any apprentice performing work on the job site in excess of the ratio permitted under the registered program shall be paid not less than the applicable wage rate on the wage determination for the work actually performed. Where a contractor is performing construction on a project in a locality other than that in which its program is registered, the ratios and wage rates (expressed in percentages of the journeyman's hourly rate) specified in the contractor's or subcontractor's registered program shall be observed. Every apprentice must be paid at not less than the rate specified in the registered program for the apprentice's level of progress, expressed as a percentage of the journeymen hourly rate specified in the applicable wage determination. Apprentices shall be paid fringe benefits in accordance with the provisions of the apprenticeship program. If the apprenticeship program does not specify fringe benefits, apprentices must be paid the full amount of fringe benefits listed on the wage determination for the applicable classification. If the Administrator determines that a different practice prevails for the applicable apprentice classification, fringes shall be paid in accordance with that determination. In the event the Office of Apprenticeship Training, Employer and Labor Services, or a State Apprenticeship Agency recognized by the Office, withdraws approval of an apprenticeship program, the contractor will no longer be permitted to utilize apprentices at less than the applicable predetermined rate for the work performed until an acceptable program is approved.

(ii) Trainees. Except as provided in 29 CFR 5.16, trainees will not be permitted to work at less than the predetermined rate for the work performed unless they are employed pursuant to and individually registered in a program which has received prior approval, evidenced by formal certification by the U.S. Department of Labor, Employment and Training Administration. The ratio of trainees to journeymen on the job site shall not be greater than permitted under the plan approved by the Employment and Training Administration. Every trainee must be paid at not less than the rate specified in the approved program for the trainee's level of progress, expressed as a percentage of the journeyman hourly rate specified in the applicable wage determination. Trainees shall be paid fringe benefits in accordance with the provisions of the trainee program. If the trainee program does not mention fringe benefits, trainees shall be paid the full amount of fringe benefits listed on the wage determination unless the Administrator of the Wage and Hour Division determines that there is an apprenticeship program associated with the corresponding journeyman wage rate on the wage determination which provides for less than full fringe benefits for apprentices. Any employee listed on the payroll at a trainee rate who is not registered and participating in a training plan approved by the Employment and Training Administration shall be paid not less than the applicable wage rate on the wage determination for the classification of work actually performed. In addition, any trainee performing work on the job site in excess of the ratio permitted under the registered program shall be paid not less than the applicable wage rate on the wage determination for the work actually performed. In the event the Employment and Training Administration withdraws approval of a training program, the contractor will no longer be permitted to utilize trainees at less than the applicable predetermined rate for the work performed until an acceptable program is approved.

(iii) Equal employment opportunity. The utilization of apprentices, trainees and journeymen under this part shall be in conformity with the equal employment opportunity requirements of Executive Order 11246, as amended, and 29 CFR part 30.

- (5) Compliance with Copeland Act requirements. The contractor shall comply with the requirements of 29 CFR part 3, which are incorporated by reference in this contract.
- (6) Subcontracts. The contractor or subcontractor shall insert in any subcontracts the clauses contained in 29 CFR 5.5(a)(1) through (10) and such other clauses as the EPA determines may be appropriate, and also a clause requiring the subcontractors to include these clauses in any lower tier subcontracts. The prime contractor shall be responsible for the compliance by any subcontractor or lower tier subcontractor with all the contract clauses in 29 CFR 5.5.
- (7) Contract termination; debarment. A breach of the contract clauses in 29 CFR 5.5 may be grounds for termination of the contract, and for debarment as a contractor and a subcontractor as provided in 29 CFR 5.12.
- (8) Compliance with Davis-Bacon and Related Act requirements. All rulings and interpretations of the Davis-Bacon and Related Acts contained in 29 CFR parts 1, 3, and 5 are herein incorporated by reference in this contract.
- (9) Disputes concerning labor standards. Disputes arising out of the labor standards provisions of this contract shall not be subject to the general disputes clause of this contract. Such disputes shall be resolved in accordance with the procedures of the Department of Labor set forth in 29

CFR parts 5, 6, and 7. Disputes within the meaning of this clause include disputes between the contractor (or any of its subcontractors) and Subrecipient(s), State, EPA, the U.S. Department of Labor, or the employees or their representatives.

(10) Certification of eligibility.

(i) By entering into this contract, the contractor certifies that neither it (nor he or she) nor any person or firm who has an interest in the contractor's firm is a person or firm ineligible to be awarded Government contracts by virtue of section 3(a) of the Davis-Bacon Act or 29 CFR 5.12(a)(1).

(ii) No part of this contract shall be subcontracted to any person or firm ineligible for award of a Government contract by virtue of section 3(a) of the Davis-Bacon Act or 29 CFR 5.12(a)(1).

(iii) The penalty for making false statements is prescribed in the U.S. Criminal Code, 18 U.S.C. 1001.

4. Contract Provision for Contracts in Excess of \$100,000.

(a) Contract Work Hours and Safety Standards Act. The subrecipient shall insert the following clauses set forth in paragraphs (a)(1), (2), (3), and (4) of this section in full in any contract in an amount in excess of \$100,000 and subject to the overtime provisions of the Contract Work Hours and Safety Standards Act. These clauses shall be inserted in addition to the clauses required by Item 3, above or 29 CFR 4.6. As used in this paragraph, the terms laborers and mechanics include watchmen and guards.

(1) Overtime requirements. No contractor or subcontractor contracting for any part of the contract work which may require or involve the employment of laborers or mechanics shall require or permit any such laborer or mechanic in any workweek in which he or she is employed on such work to work in excess of forty hours in such workweek unless such laborer or mechanic receives compensation at a rate not less than one and one-half times the basic rate of pay for all hours worked in excess of forty hours in such workweek.

(2) Violation; liability for unpaid wages; liquidated damages. In the event of any violation of the clause set forth in paragraph (a)(1) of this section the contractor and any subcontractor responsible therefore shall be liable for the unpaid wages. In addition, such contractor and subcontractor shall be liable to the United States (in the case of work done under contract for the District of Columbia or a territory, to such District or to such territory), for liquidated damages. Such liquidated damages shall be computed with respect to each individual laborer or mechanic, including watchmen and guards, employed in violation of the clause set forth in paragraph (a)(1) of this section, in the sum of \$10 for each calendar day on which such individual was required or permitted to work in excess of the standard workweek of forty hours without payment of the overtime wages required by the clause set forth in paragraph (a)(1) of this section.

(3) Withholding for unpaid wages and liquidated damages. The subrecipient, upon written request of the EPA Award Official or an authorized representative of the Department of Labor, shall withhold or cause to be withheld, from any moneys payable on account of work performed by the contractor or subcontractor under any such contract or any other

Federal contract with the same prime contractor, or any other federally-assisted contract subject to the Contract Work Hours and Safety Standards Act, which is held by the same prime contractor, such sums as may be determined to be necessary to satisfy any liabilities of such contractor or subcontractor for unpaid wages and liquidated damages as provided in the clause set forth in paragraph (b)(2) of this section.

(4) Subcontracts. The contractor or subcontractor shall insert in any subcontracts the clauses set forth in paragraph (a)(1) through (4) of this section and also a clause requiring the subcontractors to include these clauses in any lower tier subcontracts. The prime contractor shall be responsible for compliance by any subcontractor or lower tier subcontractor with the clauses set forth in paragraphs (a)(1) through (4) of this section.

(b) In addition to the clauses contained in Item 3, above, in any contract subject only to the Contract Work Hours and Safety Standards Act and not to any of the other statutes cited in 29 CFR 5.1, the Subrecipient shall insert a clause requiring that the contractor or subcontractor shall maintain payrolls and basic payroll records during the course of the work and shall preserve them for a period of three years from the completion of the contract for all laborers and mechanics, including guards and watchmen, working on the contract. Such records shall contain the name and address of each such employee, social security number, correct classifications, hourly rates of wages paid, daily and weekly number of hours worked, deductions made, and actual wages paid. Further, the Subrecipient shall insert in any such contract a clause providing that the records to be maintained under this paragraph shall be made available by the contractor or subcontractor for inspection, copying, or transcription by authorized representatives of the (write the name of agency) and the Department of Labor, and the contractor or subcontractor will permit such representatives to interview employees during working hours on the job.

5. Compliance Verification

(a) The subrecipient shall periodically interview a sufficient number of employees entitled to DB prevailing wages (covered employees) to verify that contractors or subcontractors are paying the appropriate wage rates. As provided in 29 CFR 5.6(a)(6), all interviews must be conducted in confidence. The subrecipient must use Standard Form 1445 (SF 1445) or equivalent documentation to memorialize the interviews. Copies of the SF 1445 are available from EPA on request.

(b) The subrecipient shall establish and follow an interview schedule based on its assessment of the risks of noncompliance with DB posed by contractors or subcontractors and the duration of the contract or subcontract. At a minimum, the subrecipient should conduct interviews with a representative group of covered employees within two weeks of each contractor or subcontractor's submission of its initial weekly payroll data and two weeks prior to the estimated completion date for the contract or subcontract. Subrecipients must conduct more frequent interviews if the initial interviews or other information indicates that there is a risk that the contractor or subcontractor is not complying with DB. Subrecipients shall immediately conduct necessary interviews in response to an alleged violation of the prevailing wage requirements. All interviews shall be conducted in confidence.

(c) The subrecipient shall periodically conduct spot checks of a representative sample of weekly payroll data to verify that contractors or subcontractors are paying the appropriate wage rates. The subrecipient shall establish and follow a spot check schedule based on its

assessment of the risks of noncompliance with DB posed by contractors or subcontractors and the duration of the contract or subcontract. At a minimum, if practicable, the subrecipient should spot check payroll data within two weeks of each contractor or subcontractor's submission of its initial payroll data and two weeks prior to the completion date the contract or subcontract. Subrecipients must conduct more frequent spot checks if the initial spot check or other information indicates that there is a risk that the contractor or subcontractor is not complying with DB. In addition, during the examinations the subrecipient shall verify evidence of fringe benefit plans and payments thereunder by contractors and subcontractors who claim credit for fringe benefit contributions.

(d) The subrecipient shall periodically review contractors and subcontractors use of apprentices and trainees to verify registration and certification with respect to apprenticeship and training programs approved by either the U.S Department of Labor or a state, as appropriate, and that contractors and subcontractors are not using disproportionate numbers of, laborers, trainees and apprentices. These reviews shall be conducted in accordance with the schedules for spot checks and interviews described in Item 5(b) and (c) above.

(e) Subrecipients must immediately report potential violations of the DB prevailing wage requirements to the EPA DB contact listed above and to the appropriate DOL Wage and Hour District Office listed at https://www.dol.gov/whd/whd_district_offices.pdf.

II. Requirements For Subrecipients That Are Not Governmental Entities

The following terms and conditions specify how recipients will assist EPA in meeting its DB responsibilities when DB applies to EPA awards of financial assistance with respect to subrecipients that are not governmental entities. If a subrecipient has questions regarding when DB applies, obtaining the correct DB wage determinations, DB provisions, or compliance monitoring, it may contact the State recipient for guidance. If a State recipient needs guidance, the recipient may contact Valerie Marshall at EPA Region 1 (617-918-1674) for guidance. The recipient or subrecipient may also obtain additional guidance from DOL's web site at <https://www.dol.gov/whd/govcontracts/dbra.htm>

Under these terms and conditions, the subrecipient must submit its proposed DB wage determinations to the State recipient for approval prior to including the wage determination in any solicitation, contract task orders, work assignments, or similar instruments to existing contractors.

1. Applicability of the Davis- Bacon (DB) prevailing wage requirements.

DB prevailing wage requirements apply to the construction, alteration, and repair of treatment works carried out in whole or in part with assistance made available by a State water pollution control revolving fund and to any construction project carried out in whole or in part by assistance made available by a drinking water treatment revolving loan fund. If a subrecipient encounters a unique situation at a site that presents uncertainties regarding DB applicability, the subrecipient must discuss the situation with the recipient State before authorizing work on that site.

2. Obtaining Wage Determinations.

(a) Subrecipients must obtain proposed wage determinations for specific localities at www.wdol.gov. After the Subrecipient obtains its proposed wage determination, it must submit the wage determination to (insert contact information for State recipient DB point of contact for wage determination) for approval prior to inserting the wage determination into a solicitation, contract or issuing task orders, work assignments or similar instruments to existing contractors (ordering instruments unless subsequently directed otherwise by the State recipient Award Official).

(b) Subrecipients shall obtain the wage determination for the locality in which a covered activity subject to DB will take place prior to issuing requests for bids, proposals, quotes or other methods for soliciting contracts (solicitation) for activities subject to DB. These wage determinations shall be incorporated into solicitations and any subsequent contracts. Prime contracts must contain a provision requiring that subcontractors follow the wage determination incorporated into the prime contract.

(i) While the solicitation remains open, the subrecipient shall monitor www.wdol.gov on a weekly basis to ensure that the wage determination contained in the solicitation remains current. The subrecipients shall amend the solicitation if DOL issues a modification more than 10 days prior to the closing date (i.e. bid opening) for the solicitation. If DOL modifies or supersedes the applicable wage determination less than 10 days prior to the closing date, the subrecipients may request a finding from the State recipient that there is not a reasonable time to notify interested contractors of the modification of the wage determination. The State recipient will provide a report of its findings to the subrecipient.

(ii) If the subrecipient does not award the contract within 90 days of the closure of the solicitation, any modifications or supersedes DOL makes to the wage determination contained in the solicitation shall be effective unless the State recipient, at the request of the subrecipient, obtains an extension of the 90 day period from DOL pursuant to 29 CFR 1.6(c)(3)(iv). The subrecipient shall monitor www.wdol.gov on a weekly basis if it does not award the contract within 90 days of closure of the solicitation to ensure that wage determinations contained in the solicitation remain current.

(c) If the subrecipient carries out activity subject to DB by issuing a task order, work assignment or similar instrument to an existing contractor (ordering instrument) rather than by publishing a solicitation, the subrecipient shall insert the appropriate DOL wage determination from www.wdol.gov into the ordering instrument.

(d) Subrecipients shall review all subcontracts subject to DB entered into by prime contractors to verify that the prime contractor has required its subcontractors to include the applicable wage determinations.

(e) As provided in 29 CFR 1.6(f), DOL may issue a revised wage determination applicable to a subrecipient's contract after the award of a contract or the issuance of an ordering instrument if DOL determines that the subrecipient has failed to incorporate a wage determination or has used a wage determination that clearly does not apply to the contract or ordering instrument. If this occurs, the subrecipient shall either terminate the contract or ordering instrument and issue a revised solicitation or ordering instrument or incorporate DOL's wage determination retroactive to the beginning of the contract or ordering instrument by change order. The subrecipient's contractor must be compensated for any increases in wages resulting from the use of DOL's revised wage determination.

3. Contract and Subcontract provisions.

(a) The Recipient shall insure that the subrecipient(s) shall insert in full in any contract in excess of \$2,000 which is entered into for the actual construction, alteration and/or repair, including painting and decorating, of a treatment work under the CWSRF or a construction project under the DWSRF financed in whole or in part from Federal funds or in accordance with guarantees of a Federal agency or financed from funds obtained by pledge of any contract of a Federal agency to make a loan, grant or annual contribution (except where a different meaning is expressly indicated), and which is subject to the labor standards provisions of any of the acts listed in § 5.1 or the FY 2011 Full-Year Continuing Appropriation, the following clauses:

(1) Minimum wages.

(i) All laborers and mechanics employed or working upon the site of the work, will be paid unconditionally and not less often than once a week, and without subsequent deduction or rebate on any account (except such payroll deductions as are permitted by regulations issued by the Secretary of Labor under the Copeland Act (29 CFR part 3)), the full amount of wages and bona fide fringe benefits (or cash equivalents thereof) due at time of payment computed at rates not less than those contained in the wage determination of the Secretary of Labor which is attached hereto and made a part hereof, regardless of any contractual relationship which may be alleged to exist between the contractor and such laborers and mechanics. Contributions made or costs reasonably anticipated for bona fide fringe benefits under section 1(b)(2) of the Davis-Bacon Act on behalf of laborers or mechanics are considered wages paid to such laborers or mechanics, subject to the provisions of paragraph (a)(1)(iv) of this section; also, regular contributions made or costs incurred for more than a weekly period (but not less often than quarterly) under plans, funds, or programs which cover the particular weekly period, are deemed to be constructively made or incurred during such weekly period. Such laborers and mechanics shall be paid the appropriate wage rate and fringe benefits on the wage determination for the classification of work actually performed, without regard to skill, except as provided in §5.5(a)(4). Laborers or mechanics performing work in more than one classification may be compensated at the rate specified for each classification for the time actually worked therein: Provided, that the employer's payroll records accurately set forth the time spent in each classification in which work is performed. The wage determination (including any additional classification and wage rates conformed under paragraph (a)(1)(ii) of this section) and the Davis-Bacon poster (WH-1321) shall be posted at all times by the contractor and its subcontractors at the site of the work in a prominent and accessible place where it can be easily seen by the workers. Subrecipients may obtain wage determinations from the U.S. Department of Labor's web site, www.dol.gov.

(ii)(A) The subrecipient(s), on behalf of EPA, shall require that any class of laborers or mechanics, including helpers, which is not listed in the wage determination and which is to be employed under the contract shall be classified in conformance with the wage determination. The State award official shall approve a request for an additional classification and wage rate and fringe benefits therefore only when the following criteria have been met:

(1) The work to be performed by the classification requested is not performed by a classification in the wage determination; and

(2) The classification is utilized in the area by the construction industry; and

(3) The proposed wage rate, including any bona fide fringe benefits, bears a reasonable relationship to the wage rates contained in the wage determination.

(B) If the contractor and the laborers and mechanics to be employed in the classification (if known), or their representatives, and the subrecipient(s) agree on the classification and wage rate (including the amount designated for fringe benefits where appropriate), documentation of the action taken and the request, including the local wage determination shall be sent by the subrecipient(s) to the State award official. The State award official will transmit the report, to the Administrator of the Wage and Hour Division, Employment Standards Administration, U.S. Department of Labor, Washington, DC 20210 and to the EPA DB Regional Coordinator concurrently. The Administrator, or an authorized representative, will approve, modify, or disapprove every additional classification request within 30 days of receipt and so advise the State award official or will notify the State award official within the 30-day period that additional time is necessary.

(C) In the event the contractor, the laborers or mechanics to be employed in the classification or their representatives, and the and the subrecipient(s) do not agree on the proposed classification and wage rate (including the amount designated for fringe benefits, where appropriate), the award official shall refer the request, and the local wage determination, including the views of all interested parties and the recommendation of the State award official, to the Administrator for determination. The request shall be sent to the EPA Regional Coordinator concurrently. The Administrator, or an authorized representative, will issue a determination within 30 days of receipt of the request and so advise the contracting officer or will notify the contracting officer within the 30-day period that additional time is necessary.

(D) The wage rate (including fringe benefits where appropriate) determined pursuant to paragraphs (a)(1)(ii)(B) or (C) of this section, shall be paid to all workers performing work in the classification under this contract from the first day on which work is performed in the classification.

(iii) Whenever the minimum wage rate prescribed in the contract for a class of laborers or mechanics includes a fringe benefit which is not expressed as an hourly rate, the contractor shall either pay the benefit as stated in the wage determination or shall pay another bona fide fringe benefit or an hourly cash equivalent thereof.

(iv) If the contractor does not make payments to a trustee or other third person, the contractor may consider as part of the wages of any laborer or mechanic the amount of any costs reasonably anticipated in providing bona fide fringe benefits under a plan or program, Provided, That the Secretary of Labor has found, upon the written request of the contractor, that the applicable standards of the Davis-Bacon Act have been met. The Secretary of Labor may require the contractor to set aside in a separate account assets for the meeting of obligations under the plan or program.

(2) Withholding. The subrecipient(s) shall upon written request of the EPA Award Official or an authorized representative of the Department of Labor, withhold or cause to be withheld from the contractor under this contract or any other Federal contract with the same prime contractor, or any other federally-assisted contract subject to Davis-Bacon prevailing wage requirements, which is held by the same prime contractor, so much of the accrued payments or advances as may be considered necessary to pay laborers and mechanics, including apprentices, trainees, and helpers, employed by the contractor or any subcontractor the full amount of wages required by the contract. In the event of failure to pay any laborer or mechanic, including any apprentice, trainee, or helper, employed or working on the site of the work, all or part of the wages required by the contract, the (Agency) may, after written notice to the contractor, sponsor, applicant, or owner, take such action as may be necessary to cause the suspension of any further payment, advance, or guarantee of funds until such violations have ceased.

(3) Payrolls and basic records.

(i) Payrolls and basic records relating thereto shall be maintained by the contractor during the course of the work and preserved for a period of three years thereafter for all laborers and mechanics working at the site of the work. Such records shall contain the name, address, and social security number of each such worker, his or her correct classification, hourly rates of wages paid (including rates of contributions or costs anticipated for bona fide fringe benefits or cash equivalents thereof of the types described in section 1(b)(2)(B) of the Davis-Bacon Act), daily and weekly number of hours worked, deductions made and actual wages paid. Whenever the Secretary of Labor has found under 29 CFR 5.5(a)(1)(iv) that the wages of any laborer or mechanic include the amount of any costs reasonably anticipated in providing benefits under a plan or program described in section 1(b)(2)(B) of the Davis-Bacon Act, the contractor shall maintain records which show that the commitment to provide such benefits is enforceable, that the plan or program is financially responsible, and that the plan or program has been communicated in writing to the laborers or mechanics affected, and records which show the costs anticipated or the actual cost incurred in providing such benefits. Contractors employing apprentices or trainees under approved programs shall maintain written evidence of the registration of apprenticeship programs and certification of trainee programs, the registration of the apprentices and trainees, and the ratios and wage rates prescribed in the applicable programs.

(ii)(A) The contractor shall submit weekly, for each week in which any contract work is performed, a copy of all payrolls to the subrecipient, that is, the entity that receives the sub-grant or loan from the State capitalization grant recipient. Such documentation shall be available on request of the State recipient or EPA. As to each payroll copy received, the subrecipient shall provide written confirmation in a form satisfactory to the State indicating whether or not the project is in compliance with the requirements of 29 CFR 5.5(a)(1) based on the most recent payroll copies for the specified week. The payrolls shall set out accurately and completely all of the information required to be maintained under 29 CFR 5.5(a)(3)(i), except that full social security numbers and home addresses shall not be included on the weekly payrolls. Instead the payrolls shall only need to include an individually identifying number for each employee (e.g., the last four digits of the employee's social security number). The required weekly payroll information may be submitted in any form desired. Optional Form WH-347 is

available for this purpose from the Wage and Hour Division Web site at <https://www.dol.gov/whd/forms/wh347.pdf> or its successor site. The prime contractor is responsible for the submission of copies of payrolls by all subcontractors. Contractors and subcontractors shall maintain the full social security number and current address of each covered worker, and shall provide them upon request to the subrecipient(s) for transmission to the State or EPA if requested by EPA, the State, the contractor, or the Wage and Hour Division of the Department of Labor for purposes of an investigation or audit of compliance with prevailing wage requirements. It is not a violation of this section for a prime contractor to require a subcontractor to provide addresses and social security numbers to the prime contractor for its own records, without weekly submission to the subrecipient(s).

(B) Each payroll submitted shall be accompanied by a “Statement of Compliance,” signed by the contractor or subcontractor or his or her agent who pays or supervises the payment of the persons employed under the contract and shall certify the following:

- (1) That the payroll for the payroll period contains the information required to be provided under § 5.5 (a)(3)(ii) of Regulations, 29 CFR part 5, the appropriate information is being maintained under § 5.5 (a)(3)(i) of Regulations, 29 CFR part 5, and that such information is correct and complete;
- (2) That each laborer or mechanic (including each helper, apprentice, and trainee) employed on the contract during the payroll period has been paid the full weekly wages earned, without rebate, either directly or indirectly, and that no deductions have been made either directly or indirectly from the full wages earned, other than permissible deductions as set forth in Regulations, 29 CFR part 3;
- (3) That each laborer or mechanic has been paid not less than the applicable wage rates and fringe benefits or cash equivalents for the classification of work performed, as specified in the applicable wage determination incorporated into the contract.

(C) The weekly submission of a properly executed certification set forth on the reverse side of Optional Form WH-347 shall satisfy the requirement for submission of the “Statement of Compliance” required by paragraph (a)(3)(ii)(B) of this section.

(D) The falsification of any of the above certifications may subject the contractor or subcontractor to civil or criminal prosecution under section 1001 of title 18 and section 231 of title 31 of the United States Code.

(iii) The contractor or subcontractor shall make the records required under paragraph (a)(3)(i) of this section available for inspection, copying, or transcription by authorized representatives of the State, EPA or the Department of Labor, and shall permit such representatives to interview employees during working hours on the job. If the contractor or subcontractor fails to submit the required records or to make them available, the Federal agency or State may, after written notice to the contractor, sponsor, applicant, or owner, take such action as may be necessary to cause the suspension of any further payment, advance, or guarantee of funds. Furthermore, failure to submit the required records upon request or to make such records available may be grounds for debarment action pursuant to 29 CFR 5.12.

(4) Apprentices and trainees--

(i) Apprentices. Apprentices will be permitted to work at less than the predetermined rate for the work they performed when they are employed pursuant to and individually registered in a bona fide apprenticeship program registered with the U.S. Department of Labor, Employment and Training Administration, Office of Apprenticeship Training, Employer and Labor Services, or with a State Apprenticeship Agency recognized by the Office, or if a person is employed in his or her first 90 days of probationary employment as an apprentice in such an apprenticeship program, who is not individually registered in the program, but who has been certified by the Office of Apprenticeship Training, Employer and Labor Services or a State Apprenticeship Agency (where appropriate) to be eligible for probationary employment as an apprentice. The allowable ratio of apprentices to journeymen on the job site in any craft classification shall not be greater than the ratio permitted to the contractor as to the entire work force under the registered program. Any worker listed on a payroll at an apprentice wage rate, who is not registered or otherwise employed as stated above, shall be paid not less than the applicable wage rate on the wage determination for the classification of work actually performed. In addition, any apprentice performing work on the job site in excess of the ratio permitted under the registered program shall be paid not less than the applicable wage rate on the wage determination for the work actually performed. Where a contractor is performing construction on a project in a locality other than that in which its program is registered, the ratios and wage rates (expressed in percentages of the journeyman's hourly rate) specified in the contractor's or subcontractor's registered program shall be observed. Every apprentice must be paid at not less than the rate specified in the registered program for the apprentice's level of progress, expressed as a percentage of the journeymen hourly rate specified in the applicable wage determination. Apprentices shall be paid fringe benefits in accordance with the provisions of the apprenticeship program. If the apprenticeship program does not specify fringe benefits, apprentices must be paid the full amount of fringe benefits listed on the wage determination for the applicable classification. If the Administrator determines that a different practice prevails for the applicable apprentice classification, fringes shall be paid in accordance with that determination. In the event the Office of Apprenticeship Training, Employer and Labor Services, or a State Apprenticeship Agency recognized by the Office, withdraws approval of an apprenticeship program, the contractor will no longer be permitted to utilize apprentices at less than the applicable predetermined rate for the work performed until an acceptable program is approved.

(ii) Trainees. Except as provided in 29 CFR 5.16, trainees will not be permitted to work at less than the predetermined rate for the work performed unless they are employed pursuant to and individually registered in a program which has received prior approval, evidenced by formal certification by the U.S. Department of Labor, Employment and Training Administration. The ratio of trainees to journeymen on the job site shall not be greater than permitted under the plan approved by the Employment and Training Administration. Every trainee must be paid at not less than the rate specified in the approved program for the trainee's level of progress, expressed as a percentage of the journeyman hourly rate specified in the applicable wage determination. Trainees shall be paid fringe benefits in accordance with the provisions of the trainee program. If the trainee program does not mention fringe benefits, trainees shall be paid the full amount of

fringe benefits listed on the wage determination unless the Administrator of the Wage and Hour Division determines that there is an apprenticeship program associated with the corresponding journeyman wage rate on the wage determination which provides for less than full fringe benefits for apprentices. Any employee listed on the payroll at a trainee rate who is not registered and participating in a training plan approved by the Employment and Training Administration shall be paid not less than the applicable wage rate on the wage determination for the classification of work actually performed. In addition, any trainee performing work on the job site in excess of the ratio permitted under the registered program shall be paid not less than the applicable wage rate on the wage determination for the work actually performed. In the event the Employment and Training Administration withdraws approval of a training program, the contractor will no longer be permitted to utilize trainees at less than the applicable predetermined rate for the work performed until an acceptable program is approved.

(iii) Equal employment opportunity. The utilization of apprentices, trainees and journeymen under this part shall be in conformity with the equal employment opportunity requirements of Executive Order 11246, as amended, and 29 CFR part 30.

(5) Compliance with Copeland Act requirements. The contractor shall comply with the requirements of 29 CFR part 3, which are incorporated by reference in this contract.

(6) Subcontracts. The contractor or subcontractor shall insert in any subcontracts the clauses contained in 29 CFR 5.5(a)(1) through (10) and such other clauses as the EPA determines may be appropriate, and also a clause requiring the subcontractors to include these clauses in any lower tier subcontracts. The prime contractor shall be responsible for the compliance by any subcontractor or lower tier subcontractor with all the contract clauses in 29 CFR 5.5.

(7) Contract termination: debarment. A breach of the contract clauses in 29 CFR 5.5 may be grounds for termination of the contract, and for debarment as a contractor and a subcontractor as provided in 29 CFR 5.12.

(8) Compliance with Davis-Bacon and Related Act requirements. All rulings and interpretations of the Davis-Bacon and Related Acts contained in 29 CFR parts 1, 3, and 5 are herein incorporated by reference in this contract.

(9) Disputes concerning labor standards. Disputes arising out of the labor standards provisions of this contract shall not be subject to the general disputes clause of this contract. Such disputes shall be resolved in accordance with the procedures of the Department of Labor set forth in 29 CFR parts 5, 6, and 7. Disputes within the meaning of this clause include disputes between the contractor (or any of its subcontractors) and Subrecipient(s), State, EPA, the U.S. Department of Labor, or the employees or their representatives.

(10) Certification of eligibility.

(i) By entering into this contract, the contractor certifies that neither it (nor he or she) nor any person or firm who has an interest in the contractor's firm is a person or firm ineligible to be awarded Government contracts by virtue of section 3(a) of the Davis-Bacon Act or 29 CFR 5.12(a)(1).

(ii) No part of this contract shall be subcontracted to any person or firm ineligible for award of a Government contract by virtue of section 3(a) of the Davis-Bacon Act or 29 CFR 5.12(a)(1).

(iii) The penalty for making false statements is prescribed in the U.S. Criminal Code, 18 U.S.C. 1001.

4. Contract Provision for Contracts in Excess of \$100,000.

(a) Contract Work Hours and Safety Standards Act. The subrecipient shall insert the following clauses set forth in paragraphs (a)(1), (2), (3), and (4) of this section in full in any contract in an amount in excess of \$100,000 and subject to the overtime provisions of the Contract Work Hours and Safety Standards Act. These clauses shall be inserted in addition to the clauses required by Item 3, above or 29 CFR 4.6. As used in this paragraph, the terms laborers and mechanics include watchmen and guards.

- (1) Overtime requirements. No contractor or subcontractor contracting for any part of the contract work which may require or involve the employment of laborers or mechanics shall require or permit any such laborer or mechanic in any workweek in which he or she is employed on such work to work in excess of forty hours in such workweek unless such laborer or mechanic receives compensation at a rate not less than one and one-half times the basic rate of pay for all hours worked in excess of forty hours in such workweek.
- (2) Violation; liability for unpaid wages; liquidated damages. In the event of any violation of the clause set forth in paragraph (b)(1) of this section the contractor and any subcontractor responsible therefore shall be liable for the unpaid wages. In addition, such contractor and subcontractor shall be liable to the United States (in the case of work done under contract for the District of Columbia or a territory, to such District or to such territory), for liquidated damages. Such liquidated damages shall be computed with respect to each individual laborer or mechanic, including watchmen and guards, employed in violation of the clause set forth in paragraph (b)(1) of this section, in the sum of \$10 for each calendar day on which such individual was required or permitted to work in excess of the standard workweek of forty hours without payment of the overtime wages required by the clause set forth in paragraph (b)(1) of this section.
- (3) Withholding for unpaid wages and liquidated damages. The subrecipient shall upon the request of the EPA Award Official or an authorized representative of the Department of Labor, withhold or cause to be withheld, from any moneys payable on account of work performed by the contractor or subcontractor under any such contract or any other Federal contract with the same prime contractor, or any other federally-assisted contract subject to the Contract Work Hours and Safety Standards Act, which is held by the same prime contractor, such sums as may be determined to be necessary to satisfy any liabilities of such contractor or subcontractor for unpaid wages and liquidated damages as provided in the clause set forth in paragraph (b)(2) of this section.
- (4) Subcontracts. The contractor or subcontractor shall insert in any subcontracts the clauses set forth in paragraph (b)(1) through (4) of this section and also a clause requiring the subcontractors to include these clauses in any lower tier subcontracts. The prime contractor shall be responsible for compliance by any subcontractor or lower tier subcontractor with the clauses set forth in paragraphs (b)(1) through (4) of this section.

(c) In addition to the clauses contained in Item 3, above, in any contract subject only to the Contract Work Hours and Safety Standards Act and not to any of the other statutes cited in 29 CFR 5.1, the Subrecipient shall insert a clause requiring that the contractor or subcontractor shall maintain payrolls and basic payroll records during the course of the work and shall preserve them for a period of three years from the completion of the contract for all laborers and mechanics, including guards and watchmen, working on the contract. Such records shall contain the name and address of each such employee, social security number, correct classifications, hourly rates of wages paid, daily and weekly number of hours worked, deductions made, and actual wages paid. Further, the Subrecipient shall insert in any such contract a clause providing that the records to be maintained under this paragraph shall be made available by the contractor or subcontractor for inspection, copying, or transcription by authorized representatives of the (write the name of agency) and the Department of Labor, and the contractor or subcontractor will permit such representatives to interview employees during working hours on the job.

5. Compliance Verification

(a). The subrecipient shall periodically interview a sufficient number of employees entitled to DB prevailing wages (covered employees) to verify that contractors or subcontractors are paying the appropriate wage rates. As provided in 29 CFR 5.6(a)(6), all interviews must be conducted in confidence. The subrecipient must use Standard Form 1445 (SF 1445) or equivalent documentation to memorialize the interviews. Copies of the SF 1445 are available from EPA on request.

(b) The subrecipient shall establish and follow an interview schedule based on its assessment of the risks of noncompliance with DB posed by contractors or subcontractors and the duration of the contract or subcontract. At a minimum, the subrecipient should conduct interviews with a representative group of covered employees within two weeks of each contractor or subcontractor's submission of its initial weekly payroll data and two weeks prior to the estimated completion date for the contract or subcontract. Subrecipients must conduct more frequent interviews if the initial interviews or other information indicates that there is a risk that the contractor or subcontractor is not complying with DB. Subrecipients shall immediately conduct necessary interviews in response to an alleged violation of the prevailing wage requirements. All interviews shall be conducted in confidence.

(c). The subrecipient shall periodically conduct spot checks of a representative sample of weekly payroll data to verify that contractors or subcontractors are paying the appropriate wage rates. The subrecipient shall establish and follow a spot check schedule based on its assessment of the risks of noncompliance with DB posed by contractors or subcontractors and the duration of the contract or subcontract. At a minimum, if practicable the subrecipient should spot check payroll data within two weeks of each contractor or subcontractor's submission of its initial payroll data and two weeks prior to the completion date the contract or subcontract. Subrecipients must conduct more frequent spot checks if the initial spot check or other information indicates that there is a risk that the contractor or subcontractor is not complying with DB . In addition, during the examinations the subrecipient shall verify evidence of fringe benefit plans and payments thereunder by contractors and subcontractors who claim credit for fringe benefit contributions.

(d). The subrecipient shall periodically review contractors and subcontractors use of apprentices and trainees to verify registration and certification with respect to apprenticeship and training programs approved by either the U.S Department of Labor or a state, as appropriate, and that contractors and subcontractors are not using disproportionate numbers of, laborers, trainees and apprentices. These reviews shall be conducted in accordance with the schedules for spot checks and interviews described in Item 5(b) and (c) above.

(e) Subrecipients must immediately report potential violations of the DB prevailing wage requirements to the EPA DB contact listed above and to the appropriate DOL Wage and Hour District Office listed at https://www.dol.gov/whd/whd_district_offices.pdf.

EXHIBIT B

GENERAL TERMS AND CONDITIONS

1 WORK OF THE SUBCONTRACTOR

- 1.1 All Work shall be performed in accordance with sound and generally accepted professional practices and industry standards by professional, managerial, and administrative personnel fully qualified in the respective professional disciplines required and practicing under similar circumstances at the same time and in the same locality.
- 1.2 In performing the Work hereunder, Subcontractor shall:
 - (a) Have the complete professional, managerial, or technical responsibility for the validity, accuracy, and reliability of the Work performed, and its work shall conform to all applicable codes, standards, statutes, rules and regulations and the Work criteria and definition;
 - (b) Designate a Manager, in charge of the entire Work on a continuous basis with responsibility for providing adequate supervision or direction and having authority to take all action that may be required in performance of this Agreement. When required by state law, such individual shall have an appropriate engineering license or other appropriate registration;
 - (c) Comply with all government, state and local laws, ordinances, codes or regulations which apply to performance of the Work;
 - (d) Be properly licensed in the governmental jurisdiction where the Work is being performed and where the Project is located and secure at its own expense, all necessary licenses, permits, registrations, certificates and such other documents which may be required by the appropriate governmental authority or authorities to perform the Work.
- 1.3 All Subcontractor's personnel shall be subject to the review and approval by Company. Subcontractor shall immediately remove from the Project any personnel designated by Company; and Subcontractor shall hold harmless Company on account of such action. Subcontractor shall not remove or reassign its Manager in charge of the Work or its other Key Personnel designated in this Agreement without the prior written approval of Company, unless such personnel are no longer employed by Subcontractor.
- 1.4 The Work shall be performed at locations satisfactory to Company and such locations shall not be changed without the written approval of Company. Company shall have access at all times to the locations where Work is performed and to all of the drawings, specifications, data, calculations, models, test results and specimens, documents and other things related to the Work or the Project.
- 1.5 Subcontractor shall be responsible for the professional quality, technical accuracy and timely completion of its services furnished under this Agreement. In the event Subcontractor's services hereunder should not prove satisfactory to Company or Client, as a result of human error, omission or otherwise, Subcontractor shall, without additional compensation, and at its own cost and expense, remedy the defective services and the consequences thereof, provided such corrective services are requested in writing by Company or Client, within the period of warranty for such corrective Work as required by Client of Company under the Prime Contract executed by and between Client and Company.
- 1.6 Review and approval by Company of Subcontractor's drawings, samples, or other representations shall not relieve Subcontractor of the obligation to complete the entire Work in strict compliance with the requirements of this Agreement and to represent to Company that the Work will be sufficient and adequate to fulfill the purposes of the Project, and satisfy all applicable obligations and requirements of Company under the Prime Contract.

2 SCHEDULE AND DELAYS

- 2.1 Time is of the essence in this Agreement. Subcontractor agrees to commence the Work promptly when directed by Company and to prosecute the Work diligently to completion. Subcontractor shall schedule its services in compliance with Company's directions and consistent with the Project schedule. The schedule for the Work shall be subject to revision by Company to coordinate the overall Project progress. In the event the Work is delayed, Company may direct the Subcontractor to supplement its labor force, add equipment, or work overtime at Subcontractor's expense in order to alleviate any delay.
- 2.2 Delays caused solely by Company, its Client, or incurred as a result of "Force Majeure" which shall only include acts of God, fire, labor strikes or picketing, epidemic, pandemic, and unseasonable weather shall be excusable and shall entitle Subcontractor to an extension of the Project schedule, but there shall be no adjustment in the Subcontractor's compensation. Company will determine the normal working hours for the Work and overtime shall be subject to Company's prior written approval.
- 2.3 If the Prime Contract imposes the risk of penalties or liquidated or other damages on Company for delays, then, to the extent such penalties or damages are imposed on Company because of delays within the control of Subcontractor, then Subcontractor shall defend, hold harmless, and indemnify Company against such penalties or damages.

3 PERMITS

Subcontractor shall be solely responsible for acquiring and maintaining, at its own cost, any and all permits, licenses, easements, waivers and permissions of every nature necessary to perform the Works in full compliance with any applicable laws and/or regulations.

4 CHARGES AND PAYMENT CONDITIONS

- 4.1 Subcontractor agrees to provide such supporting documentation for each invoice as Company may reasonably require. Company's payment terms are NET 30 (i.e., undisputed amount paid within thirty (30) days after receipt of a correct invoice, which references the Company's Purchase Order Number). Payment of any invoice by Company shall not imply inspection, approval, or acceptance of the Work by Company or Client.

Subcontractor shall bear the risk of Client's insolvency, non-payment, and dispute of amounts invoiced. In the event of non-payment by Client, Company shall not be obligated to make payment to Subcontractor, but both parties shall cooperate in seeking payment from Client. **It is expressly acknowledged that receipt of payment by Company from the Client on account of the work performed by the Subcontractor shall be a condition precedent to any obligation by Company to make any payment to the Subcontractor hereunder.**

The final milestone payment invoice, not less than 10% of the Agreement Price, shall be paid upon completion and acceptance of the Work by Company and Client. Payment of any invoice by Company shall not imply review, approval, or acceptance of the Work by Company.

- 4.2 Subcontractor shall certify to Company in writing at the time of submittal of each invoice that all sub-subcontractors, subconsultants and suppliers have been paid for work and material from previous progress payments received, prior to receipt of any further progress payments. This provision in no way creates any contractual relationship between any sub-subcontractor, subconsultant or supplier and Company or any liability on Company for the Subcontractor's failure to make timely payments to them.
- 4.3 As a condition precedent to Company's final payment under this Agreement, Subcontractor shall furnish certifications, satisfactory to Company, that state that no liens of any kind, including, but not limited to, mechanics' liens or other claims arising directly or indirectly out of any act or omission of Subcontractor or any of its subconsultants, sub-subcontractors or suppliers, have been made or attached against the Work or upon any property owned by Company or its Client. Company at any

time, without notice, may pay and discharge liens, claims, and encumbrances filed by Subcontractor's sub-subcontractors or suppliers and deduct the amount paid, together with costs and attorneys' fees, from compensation due Subcontractor hereunder.

- 4.4 The acceptance by Subcontractor of the final payment under this Agreement shall constitute and operate as a release to Company for all claims and liability to Subcontractor, its representatives, subconsultants, sub-subcontractors, supplies and assigns for any additional compensation or payment relating to any and all things done or furnished to the services rendered by Subcontractor. However, final payment shall in no way relieve the Subcontractor of liability for its obligations or for faulty or defective work discovered after final payment.
- 4.5 The compensation to be paid to Subcontractor includes, and Subcontractor shall be liable for and shall pay, and shall defend, hold harmless, and indemnify Company against, all taxes, contributions, interest accrued, penalties imposed, and all taxes, excises, assessments, and other charges levied by any government agent, authority, or any other jurisdictional body on, or because of, the services performed hereunder or any labor, materials, supplies, or services furnished for or used in the performance of the Work.

5 CHANGES AND ADDITIONAL COMPENSATION

- 5.1 Company, by written order (hereinafter "Change Order"), may make changes in the Work including, but not limited to, increasing or decreasing the Work or directing acceleration in the performance of the Work. Where practicable, Company and Subcontractor shall negotiate, prior to the issuance of a Change Order, the amount of any charge for increases or decreases in the Work or schedule change related to the Change Order. In the event the parties cannot agree, Company may issue the Change Order and the Subcontractor shall proceed with the Work, being compensated for the change in Work on a cost reimbursable basis as set forth in Article 4.2.
- 5.2 No change shall be made by Subcontractor in the Work or its manner of performance, without prior instructions from Company, in a written Change Order specifying the change in plans, specifications, procedures, schedule, sequence, or other requirements of this Agreement, and specifying whether there is to be an adjustment in the price for performance and how any such adjustment shall be determined. No adjustment in price or time of performance shall be made for changes in arrangement, aesthetics, substitution of equivalent materials, or equipment or other changes, unless such changes significantly affect Subcontractor's cost of performing the Work. An equitable adjustment will be made in price or time of performance or both, if the change ordered by Company substantially increases or decreases the cost and/or time of performance of the Work. The method of changing the price shall be specified in the Change Order. In the event a Change Order does not specify pricing for services, Subcontractor shall be paid all actual, direct additional cost incurred, without allocation of its home office general and administrative expense, plus ten percent (10%) of such costs, and Subcontractor shall maintain and furnish Company accurate and detailed records daily segregating the cost of the change in the Work. In case of deletion or reduction of the Work by such change, Subcontractor shall not be entitled to anticipated contribution to its home office overhead and profit from any portion of the Work not performed.
- 5.3 Whenever an event occurs or condition arises which Subcontractor considers to constitute a basis for additional compensation or time, and Company has not issued a Change Order, Subcontractor shall so notify Company immediately by telephone, and confirm in writing within five (5) business days, after the occurrence of the event or discovery of the condition, requesting Company to issue a Change Order under the procedure set forth above and forwarding adequate supporting information to substantiate Subcontractor's position. Subcontractor shall not proceed with respect to the event or condition forming the subject of the claim until advised in writing, or orally and confirmed in writing, by Company to do so. Company's liability to Subcontractor for any such events or conditions shall be limited to any sums or extension of time obtained from Client therefor.
- 5.4 Upon receipt of the notice from Subcontractor, Company shall either initiate the Change Order procedure or give other instructions by telephone or in writing, as appropriate. If Company orders Subcontractor to proceed and concludes that no Change Order is warranted, the disagreement shall

constitute a dispute and Subcontractor shall proceed in accordance with Company's instructions. The dispute shall be resolved in accordance with Article 19.0 Disputes.

6 INDEMNIFICATION

Subcontractor releases and agrees to indemnify and defend Company, its Client, their officers, directors, and employees from and against any and all suits, actions, claims, demands, damages, liabilities, interest, attorney's fees, costs, and expenses of whatsoever kind, including those arising out of injury, disease, or death of Subcontractor's employees in any manner directly or indirectly caused, occasioned, or contributed to in whole or in part, or claimed to be caused, occasioned, or contributed to in whole or in part, by reason of any act, omission, fault, or negligence whether active or passive of Subcontractor, its subconsultants or sub-subcontractors, or of anyone acting under its direction or control. Subcontractor's aforesaid release and indemnity shall apply in the event of joint or contributory negligence, whether active or passive, or strict liability of Company or its Client to the fullest extent permitted by law, but in no event shall the release and indemnity obligation apply to liability caused by the willful misconduct or sole negligence of the party released or indemnified.

7 SAFETY

- 7.3 Subcontractor shall be responsible for the health and safety of its employees and the employees of its subconsultants and sub-subcontractors, if any, while present at the Subcontractor's home and branch offices and other locations where Work is performed. While performing Work on Company's or Client's property and/or at Project Sites, Subcontractor shall place the highest priority on safety and safe working practices. Therefore, it will be the responsibility of Subcontractor to provide and maintain a safe working environment for its employees while working on Company's or Client's property and/or Project Sites and to protect the health and safety of Subcontractor's employees, agents and subconsultants and sub-subcontractors and their respective employees, and Company employees, the public and other third parties. All tools, equipment, facilities, and other items used by Subcontractor and practices employed by Subcontractor in accomplishing the Work are considered to be part of the working environment.
- 7.4 Subcontractor shall comply with all applicable laws, rules and regulations relating to health and safety, including but not limited to, those set forth in the Occupational Health and Safety Act, as amended (OSHA).
- 7.5 Whenever Subcontractor has any employees at the site of the Work, either temporarily on visits or on assigned basis, Subcontractor shall comply with all of the regulations and directives of Company and/or the Client with respect to safety, security, entrances, parking areas, sanitation, and other provisions for maintenance of good order and coordination of the activities of all participants in the Work as a whole.

8 DOCUMENTS

- 8.1 The Work and all records relating to it, including, without limitation, all drawings, specifications, reports, summaries, samples, photographs, memoranda, notes, calculations, and other documents developed by Subcontractor during the period of performance of this Project is work product and shall be deemed to be the property of Company or Client. Subcontractor shall maintain all such materials in kind, or on microfilm, except for samples, for a period of not less than two (2) years after completion of the Work, or for such longer time as may be required by the Prime Contract.
- 8.2 All dimensions in notes and drawings prepared in the performance of the services specified in this Agreement shall be in the foot/pound system, unless otherwise required or approved by Company.
- 8.3 Subcontractor shall return to Company all drawings and written materials furnished to Subcontractor by Company, including all copies thereof, if any, made by Subcontractor, except that Subcontractor may retain one copy of the same in its files for record purposes only.

- 8.4 Subcontractor will limit access to Company's and Client's confidential and technical information to Subcontractor's employees who reasonably require such access for performance of Work pursuant to this Agreement.

9 PATENTS AND COPYRIGHTS

- 9.1 If Subcontractor or its personnel make any inventions or prepare copyrightable material as a result of the performance of this Agreement, Subcontractor promptly shall disclose such inventions or materials to Company. Subcontractor agrees to grant, and hereby grants, to Company the entire right, title, and interest in and to such inventions and copyrightable materials, and Subcontractor shall cooperate with Company and execute all documents necessary to perfect Company's rights in the inventions or materials and to allow Company to prosecute and obtain patents and copyrights thereon.

- 9.2 Subcontractor shall indemnify and hold harmless Company and Client against any loss, cost or liability for infringement of any period or proprietary rights involving any services furnished hereunder.

10 CONFIDENTIALITY AND NONDISCLOSURE

Subcontractor shall not disclose information regarding this Agreement or the Work, except for information that is required for the purposes of the performance of Work or in the public domain, to any person. Noncompliance by the Subcontractor or others under the control or direction of the Subcontractor with this obligation shall be sufficient cause for Company immediately to terminate this Agreement for cause without prior written notice, and shall entitle Company to injunctive and other relief from a court of competent jurisdiction. In addition, Subcontractor agrees to comply with any more restrictive confidentiality requirements imposed by Client in the Prime Contract.

11 AUDIT

Not Used

12 INSPECTION AND NON-WAIVER

- 12.1 Subcontractor shall permit representatives of Company to inspect and observe the Work at all reasonable times, and all Work shall be subject to acceptance and approval by Company. However, the exercise of any such rights shall not relieve Subcontractor of its responsibility to perform the Work in accordance with all Agreement requirements.
- 12.2 The failure of Company to insist upon strict performance of any of the terms of this Agreement or to exercise any rights conferred by this Agreement shall not be construed as a waiver of its right to assert or rely on any such terms or rights on any future occasion or as a waiver of any other terms or rights.

13 REMEDIES UPON DEFAULT

In addition to any rights provided by any other provisions of this Agreement or any applicable law, Company shall have the right to retain any money in its possession due to the Subcontractor under this Agreement so as to reimburse Company for any damage or costs caused by or attributable to the acts or omissions of the Subcontractor with respect to this Agreement or any other subcontract or contract between the parties including, but not limited to, Subcontractor's late completion, breach of warranty, breach of guarantees, negligence or any other contractual breach. Failure to withhold payment shall in no event be construed as a waiver of any right of Company to assert any claim for breach of any obligation under this or any other agreement between the parties.

14 WARRANTY

- 14.1 Subcontractor warrants that all Works will be as represented by Subcontractor, free from defects in materials, workmanship, and design, in conformance with all applicable specifications, descriptions,

samples, and drawings referred to in this Agreement and in Order(s), merchantable and fit for their intended purposes.

- 14.2 Subcontractor warrants that the production, packaging, labeling and transportation of all goods will comply with all applicable national, regional, state and local laws, rules, regulations, ordinances and orders.
- 14.3 Subcontractor warrants that it has the experience and ability as may be necessary to perform all Works with a high standard of quality and that all Works will be performed in a workmanlike, professional manner and in accordance with the highest standards in the industry.
- 14.4 Subcontractor warrants that it will make all appropriate tax payments and tax withholdings for all individuals it provides to perform Works and, in the case of Works performed in the United States of America, will verify such individuals as being legally able to work in the United States.
- 14.5 All warranties will survive inspection, testing and acceptance of the Works and expiration or termination of this Agreement.
- 14.6 All warranties are considered independent. Each will be separately construed and interpreted without reference to any other warranty.

15 TERMINATION AND SUSPENSION

15.1 Termination for Convenience. Company, by ten (10) days written notice, may terminate this Agreement in whole or part for any reason, including solely for its convenience. Subcontractor will be paid for reasonable costs of all work performed including a reasonable overhead and profit. No money will be paid for interruption of business or loss of business opportunities, for overhead and profit on Work not completed, or for any other intangible costs. In no event shall the total sums paid Subcontractor exceed the Agreement price.

15.2 Termination for Cause. If, in the reasonable opinion of Company, the Subcontractor shall at any time, (1) fail in any material respect to prosecute timely the Work, (2) fail to comply with any material provision of this Agreement, (3) make a general assignment for the benefit of its creditors, (4) have a receiver appointed, or (5) become insolvent, then, after serving seven (7) days written notice, unless the condition specified in such notice shall have been eliminated within seven (7) days, Company, at its option and without voiding the other provisions of this Agreement, may, after an additional seven (7) days, (i) take such steps as are necessary to overcome the condition, in which case the Subcontractor shall be liable to Company for any cost hereof, or (ii) partially or wholly terminate for default the Subcontractor's continued performance of its duties under this Agreement. In the event of a termination for default, Company may, at its option, use all of Subcontractor's work product for completion of the Work by others, take assignment of any or all of the Subcontractor's agreements with subconsultants, sub-subcontractors or suppliers and/or have the remainder of the Subcontractor's obligations completed by whatever means Company deems expedient. In case of a termination for default, the Subcontractor shall not be entitled to receive any further payment until the Work shall be fully completed and accepted by Company and the Client and payment made in full by the Client at which point the Subcontractor shall be paid the remainder of its fee less any costs or expenses incurred by Company as a result of Company taking any steps necessary to overcome the deficiency or complete the Subcontractor's duties hereunder.

15.3 Suspension.

- (a) Company may order Subcontractor, in writing, to suspend, interrupt or defer all or any part of its Work for such period of time as may be appropriate to the convenience of Company and/or Client.
- (b) If the performance of all or any part of Subcontractor's Work is suspended, interrupted or deferred by the direction of Company for a period greater than ninety (90) continuous days, an equitable adjustment shall be made for any increase in the cost of affected Work and the

schedule of such affected Work shall be adjusted in accordance with the provisions of this Agreement. However, no adjustments shall be made for any such suspension, interruption or deferment whereby performance would have been so suspended, interrupted or deferred by any other cause, including the fault or negligence of Subcontractor, or whereby an equitable adjustment is provided for or excluded under any other provision of this Agreement. Should any such suspension, interruption or deferment be directed by the Client, any equitable adjustment in cost and/or schedule adjustment, subject to the provisions of this Article, Subcontractor shall be compensated therefor only to the extent Company can recover such cost and/or schedule adjustment from the Client.

- (c) No claim hereunder shall be allowed unless such claim, in an amount stated, is asserted in writing within fifteen (15) days after termination of such suspension, delay or interruption, but in no case later than the date of Final Payment.

16 INDEPENDENT CONTRACTOR, NON- ASSIGNMENT, AND SUBCONTRACTS

- 16.1 In the performance of the Work, Subcontractor shall operate as, and have the status of, an independent contractor and shall not act as or be an agent or employee of Company or its Client. As an independent contractor, Subcontractor shall be solely responsible for executing the Work.
- 16.2 Subcontractor shall not assign this Agreement without the prior written consent of Company. After assignment, this Agreement shall inure to the benefit of, and shall be binding upon, Company's and Subcontractor's respective successors and assigns. Subcontractor shall notify Company in writing of each subconsultant or sub-subcontractor it intends to use before entering into a subcontract. None of the Work may be subcontracted by Subcontractor without the prior written approval of Company.
- 16.3 Each subcontract with a subconsultant or sub-subcontractor must contain provisions, or be made expressly subject to provisions, for changes, notice, indemnification, insurance, nondisclosure and confidentiality, patents and inventions, documents, termination, suspension, dispute resolution, inspection and non-waiver, ethics and gratuities, employment practices, audit, liens and encumbrances, at least as restrictive in form and content as those contained or referred to in this Agreement. Subcontractor shall advise each prospective subconsultant or sub-subcontractor of these requirements and shall ensure that each subconsultant or sub-subcontractor complies with them.

17 TRUTH IN NEGOTIATIONS REPRESENTATIONS

- 17.1 Subcontractor warrants that sub-subcontractor has not employed or retained any company or person other than a bona fide employee working solely for Subcontractor, to solicit or secure this Agreement and that has not paid or agreed to pay any person, company, corporation, individual or firm, other than a bona fide employee working solely for subcontractor, any fee, commission, percentage, gift or any other consideration contingent upon or resulting from the award or making of this Agreement.
- 17.2 Subcontractor warrants that the prices for the Work sold Company hereunder are not less favorable than those currently extended to any other customer of Subcontractor for the same or similar services in similar quantities. Subcontractor further warrants that wage rates and other factual unit costs supporting the compensation are accurate, complete and current at the time of the Agreement. The Subcontractor agrees that the original Agreement price and any additions thereto shall be adjusted to exclude any significant sums by which Company or Client determines the Agreement price was increased due to inaccurate, incomplete, or non-current wage rates and other factual unit costs.

18 ETHICS AND GRATUITIES

The Subcontractor represents and warrants that in connection with its performance of this Agreement, it has not or will not, directly or indirectly, pay, give, offer, promise to pay or give, or authorize the payment or giving of any money, gift, or things of value to any governmental official, political party, or candidate for political office; or to any person who knowingly will give all or a portion of the money, gift, or thing of value to any such official in its official capacity. Breach of this

representation or warranty shall be considered a default under the terms of this Agreement and shall, in addition to any other remedies, entitle Company to recover all amounts paid to Subcontractor under this Agreement.

19 EMPLOYMENT PRACTICES

Subcontractor shall not discriminate against any employee or applicant for employment or applicant for employment because of race, color, national origin, religion, sex, age or for any reason prohibited by law. To the extent applicable to the Work on this Project, Subcontractor shall comply with Executive Order 11246 or any amendment, replacement or counterpart thereof.

20 COMMUNICATIONS AND NOTICES

- 20.1 All inquiries the Subcontractor may have concerning this Agreement shall be made to Company and not directly to the Client.
- 20.2 All of Subcontractor's correspondence/ communication regarding this Agreement shall include Company's Agreement Number and Work Description, and shall be mailed or delivered to Company's Designated Representative.
- 20.3 Notices of changes, deficiencies, delays, claims or disputes shall be in writing, and shall furnish full information to the extent available. The party notified will acknowledge receipt by endorsement of a copy if requested or will otherwise confirm receipt in writing. To avoid difficulty in delivery of Notice, sufficient Notice shall be deemed to have been given by mailing via Registered or Certified Mail or equivalent to the Site address shown on page 1 of this Agreement.

21 DISPUTES

- 21.1 The Parties agree to attempt to resolve disputes through informal mediation. The Parties may pursue their respective remedies at law or equity for any claim, controversy, or dispute relating to this Agreement, except as follows: Subcontractor acknowledges that the Prime Contract may include a disputes resolution clause pursuant to which Company may be limited to certain dispute resolution procedures such as arbitration or administrative proceedings in the event of a dispute relating to the Prime Contract. In the event that such provisions govern disputes between Company and its Client, Subcontractor agrees to be bound by the procedures in the Prime Contract with respect to disputes under this Agreement in the same manner that Company is bound under the terms of the Prime Contract. Subcontractor consents to joinder in any proceedings between Company and its Client upon Company's request. Subcontractor shall not have the right to join in proceedings between Company and the Client unless Company consents to the joinder.
- 21.2 The Subcontractor shall carry on the Work and maintain the Project schedule during any dispute proceedings, unless otherwise instructed by Company.

22 GOVERNING LAW

This Agreement shall be governed by and construed in accordance with the laws of the jurisdiction in which the Project is located.

23 SETOFF

Company is authorized to deduct any sums owed it by Subcontractor (whether or not the debt arises out of this Agreement) from the payments due Subcontractor under this Agreement. Company may also withhold payment from Subcontractor in an amount sufficient to protect Company from any claims of third parties or any liens which arise as a result of Subcontractor's or its subconsultants' and sub-subcontractors' performance of the Work.

24 SURVIVAL

The warranty, liability, indemnity, audit, ownership of work product, patent, and confidentiality (including publicity releases) provisions of this Agreement shall survive its termination or final settlement. The provisions of this Agreement relating to termination and settlement of disputes and claims (including choice of law) shall survive its termination, but not its final settlement.

25 SEVERABILITY

Any provisions of this Agreement held in violation of any law or ordinance shall be deemed stricken, and all remaining provisions shall continue to be valid and binding upon the Parties. Company and Subcontractor shall in good faith attempt to replace any invalid or unenforceable provisions of this Agreement with provisions that are valid and enforceable and that come as close as possible to expressing the intention of the original provisions.

26 REMEDIES

The remedies reserved for Company herein shall be cumulative and additional to any other or further remedies provided in law or equity. Any waiver by Company of any provision of this Agreement shall not constitute a waiver of any other provisions of the Agreement.

27 HEADINGS

The descriptive headings at the beginning of the articles, clauses, and subclauses of this Agreement are provided for convenience only and do not affect the interpretation or construction of this Agreement. In some instances an article or clause contains provisions not covered by the heading hereof, in other instances an article or clause contains provisions that are described in the heading of another article or clause.

EXHIBIT C
COMPENSATION

1.0 AGREEMENT PRICE

- 1.1 Company shall pay Subcontractor for complete, satisfactory and timely performance of the Work in strict accordance with the requirements hereof, the following firm fixed price, which excludes all applicable taxes and which is not subject to escalation: \$_____.
- 1.2 Change Orders
- 1.1. As allowed in DEP's Policy Memorandum #10 - the agreed upon DIRECT LABOR MARKUP (percentage) for Change Orders on this project shall be _____%. The "direct labor mark-up" rate shall account for the cost of Worker's Compensation Insurance, Federal Social Security and State Unemployment Compensation.
- 1.2. The agreed-upon mark-up for Overhead and Profit (OH&P) on this project shall be 15 percent (15%).
- 1.3. The agreed-upon mark-up for the Contractor's Overhead and Profit (OH&P) on Subcontractors shall be five percent (5%).
- 1.4. Any Change Orders authorized on a Time and Materials (T&M) basis shall have daily time and materials forms prepared by the Contractor and signed by Veolia.

2.0 INVOICES

- 2.1 Payment will be made in accordance with Article 3.0 of Exhibit B.
- 2.2 Subcontractor's invoice shall:
- 2.2.1 Reflect Company's Purchase Order ("PO") number and Site ID
- 2.2.2 Be numbered sequentially
- 2.2.3 Be submitted by email to us.apinvoices@veolia.com for approval
- 2.2.4 Be submitted on a monthly basis no later than the fifteenth (15th) day of the following month
- 2.2.5 Show previous amount billed, current amount billed, and amount billed to date by each activity and by the sum of all activities
- 2.2.6 Be accompanied by such supporting documentation as Company may reasonably require
- 2.3 An executed waiver and release form in the respective formats referenced as Exhibit C.1 - Interim Waiver And Release of Liens and Claims Upon Payment and Exhibit C.2 - Unconditional Final Waiver and Release of Liens and Claims upon Final Payment shall accompany Subcontractor's final invoice.

EXHIBIT C.1

INTERIM WAIVER AND RELEASE OF LIENS AND CLAIMS UPON PAYMENT

(To be provided by Subcontractor with Interim Progress Payment Invoices)

STATE OF Massachusetts
COUNTY OF Worcester

The undersigned, Subcontractor ("Subcontractor"), has been engaged under subcontract with Veolia Water North America - Northeast, LLC ("Company") to furnish certain materials, equipment, services, and/or labor for the project known as Taunton MA, Main Lift Pump Station Improvements, which is located at 690 West Water Street, Taunton, MA ("Property"), and more particularly described as follows: Taunton MA, Main Lift Pumping Station Improvements.

Upon receipt of the sum of \$ _____, the Subcontractor waives and releases any and all liens or claims of liens and all claims, demands, actions, causes of action or other rights against Company and the Client and upon the foregoing described Project and Property through the date of _____, 20__ ("Current Date") and reserving those rights and liens that the Subcontractor might have in any retained amounts, on account of materials, equipment, services and/or labor furnished by the undersigned to or on account of Company for said Taunton MA, Main Lift Pump Station Improvements. Exceptions as follows:

(if no exception entry or "none" is entered above, Subcontractor shall be deemed not to have reserved any claim.)

Subcontractor further represents that all employees, laborers, materialmen, sub-subcontractors and sub-subconsultants employed by the Subcontractor in connection with the Project and all bills incurred through the Current Date for materials, equipment, services and/or labor, and taxes furnished by such parties to the Subcontractor in connection with the Subcontractor's work on the Project have been, or shall be within 10 days of receipt of payment from Company stated above, fully paid and that no obligations, legal, equitable or otherwise, are, or shall be then, owed by the Subcontractor to such parties.

This Waiver and Release is freely and voluntarily given and the undersigned acknowledges and represents that it has fully reviewed the terms and conditions of this Waiver and Release, that it is fully informed with respect to the legal effect of this Waiver and Release, and that it has voluntarily chosen to accept the terms and conditions of this Waiver and Release in return for the payment recited above.

The undersigned understands that the failure to complete correctly or fully any of the blank spaces in this document shall not invalidate the document so long as the subject matter of this Waiver and Release may reasonably be determined.

FOR SUBCONTRACTOR:

Applicable to Payment Request(s) No. _____
(or) Invoice(s) No. _____ By: _____
Date: _____ Title: _____

AFFIDAVIT

On this ____ day of _____, 20__, before me appeared the above-signed, known or identified to me personally, who, being first duly sworn, did say that s/he is the authorized representative of the above-referenced Subcontractor and that this document was signed under oath personally and on behalf of the Subcontractor and the above-signed acknowledged that this Affidavit was executed as a free act and deed of Subcontractor.

Signature _____ (Seal)
Signature of Notary Public

EXHIBIT C.2

UNCONDITIONAL FINAL WAIVER AND RELEASE OF LIENS AND CLAIMS UPON FINAL PAYMENT

(To be provided by Subcontractor with Final Invoice)

STATE OF Massachusetts

COUNTY OF Worcester

The undersigned, Subcontractor ("Subcontractor"), has, under an agreement with Veolia Water North America - Northeast, LLC ("Company"), furnished certain materials, equipment, services, and/or labor for the project known as Taunton MA, Main Lift Pump Station Improvements, which is located at 690 West Water Street, Taunton, MA, County of Worcester ("Property"), and more particularly described as follows: Taunton MA, Main Lift Pump Station Improvements

Upon receipt of the sum of \$_____, such receipt being hereby acknowledged, the Subcontractor waives and releases any and all claims, demands, actions, causes of action or other rights against Company, the Client, the Project and Property, at law, in contract, tort, equity or otherwise, and any and all liens or claims of liens or any right against any labor and/or material bond Subcontractor has, may have had or may have in the future arising out of Subcontractor's performance of work on the Project.

This Waiver and Release applies to all facts, acts, events, circumstances, changes, constructive or actual delays, accelerations, extra work, disruptions, interferences and the like which have occurred, or may be claimed to have occurred prior to the date of this Waiver and Release, whether or not known to the Subcontractor at the time of execution of this Waiver and Release.

The Subcontractor further represents that all of its obligations, legal, equitable, or otherwise, relating to or arising out of its work on the Project have been, or shall be within 10 days of the date stated below, fully satisfied, including, but not limited to obligations relating to:

- Employees, laborers, materialmen, sub-subcontractors and sub-subcontractors employed by the Subcontractor;
- Labor, materials, equipment and supplies furnished by others to the Subcontractor; and
- Sales and use taxes, social security taxes, income tax withholding, unemployment insurance, privilege taxes, license fees, and any other taxes and obligations imposed by governmental authorities.

This Waiver and Release is freely and voluntarily given and the Subcontractor acknowledges and represents that it has fully reviewed the terms and conditions of this Waiver and Release, that it is fully informed with respect to the legal effect of this Waiver and Release, and that it has voluntarily chosen to accept the terms and conditions of this Waiver and Release in return for the payment recited above. The Subcontractor understands, agrees and acknowledges that, upon payment; this document waives rights unconditionally and is fully enforceable to extinguish all claims of the Subcontractor as of the date of execution of this document by the Subcontractor. The Subcontractor understands that the failure to complete correctly any of the blank spaces in this document shall not invalidate the document so long as the subject matter of this Waiver and Release may reasonably be determined.

FOR SUBCONTRACTOR:

Applicable to Payment Request(s) No. _____

Signed: _____(SEAL)

*If all, print "all" _____

By: _____

Date: _____

Title: _____

AFFIDAVIT

On this ___ day of _____, 20___, before me appeared the above-signed, known or identified to me personally, who, being first duly sworn, did say that s/he is the authorized representative of the above-referenced Subcontractor and that this document was signed under oath personally and on behalf of the Subcontractor and the above-signed acknowledged that this Affidavit was executed as a free act and deed of Subcontractor.

Signature _____ (Seal)

Signature of Notary Public

EXHIBIT D

INSURANCE REQUIREMENTS

Without in any way limiting Subcontractor's liability hereunder, Subcontractor shall maintain the following minimum limits of insurance at its own expense during the performance of the Work, with insurance companies rated A-VII or higher by A.M. Best's, to cover the risk of losses associated with this Agreement:

<u>Coverage</u>	<u>Limits</u>
(i) Workers' Compensation	\$100,000
(ii) Employers' Liability	\$1,000,000 each accident \$1,000,000 each employee \$1,000,000 policy limit
(iii) Commercial General Liability written on ISO CG 00 01 coverage form or its equivalent. No limiting or exclusionary endorsements material to Subcontractor's obligations in this Subcontract may be attached. Coverage shall include: a) contractual liability; b) explosion, collapse & underground perils (XCU); c) third-party over action coverage; d) Riggers Liability endorsement for the use of cranes, booms or other rigging equipment, if applicable; and e) amendment of the aircraft exclusion to include coverage for the use of commercial UAVs (drones), if applicable	\$2,000,000 each occurrence for property damage and bodily injury (PD/BI) \$2,000,000 general aggregate per project \$2,000,000 products/completed operations aggregate
(iv) Automobile Liability - covering all owned (if any), hired and non-owned autos. If Subcontractor is performing any hauling, endorsements MCS-90 and/or CA 99 48 shall be attached.	\$2,000,000 combined single limits - each accident
(v) Umbrella/Excess Liability providing coverage at least as broad as the underlying policy(ies)	May be utilized to meet limits outlined above
(vi) Property	Subcontractor shall be solely responsible for protecting and insuring all property owned or leased or used by Subcontractor in conjunction with the Work during the term of this Subcontract
(vii) Professional Liability (Errors & Omissions), if applicable to the Work - Coverage shall not exclude Technology Errors & Omissions coverage if Subcontractor will have any type of access to any Company systems, including, but not limited to, any Company-owned or managed IT asset (network, server or application) wherever it is hosted	\$1,000,000 each claim \$1,000,000 annual aggregate
(viii) Contractor's Pollution Liability, if applicable to the Work	\$1,000,000 each claim \$1,000,000 annual aggregate

Prior to providing any Work under this Agreement, Subcontractor will provide Company with an ACORD certificate of insurance evidencing that the above described coverages are in full force and effect. Subcontractor will name Company and Client as additional insured with respect to coverages (iii), (iv), and (viii), (and (v) if applicable) above. All policies will be primary and non-contributory, provide a full waiver of the insurer's right of subrogation in favor of Company and Client, if applicable, and/or any sub-subcontractor with respect to claims that are covered or should have been covered by valid and collectible insurance provided hereunder and said waiver will extend to any deductibles, co-insurance or

retentions. Subcontractor will not permit any cancellation or non-renewal in the insurance coverage to be provided hereunder without thirty (30) days' written notice to Company.

All policies shall be issued on occurrence-based forms, except for coverages (vii) or (viii), which may be issued on a claims-made form. All claims-made policies will at least be retroactive to the earlier of the date of this Agreement or the commencement of Subcontractor's services in relation to the Work, and shall be maintained for three (3) years after the expiration or termination of this Agreement.

These insurance requirements will not be construed in any matter as waiving, restricting or limiting Company's rights or Subcontractor's obligations under this Agreement. Company does not represent that coverage or limits herein will be adequate to protect Subcontractor. Subcontractor remains responsible for any liability not paid by insurance including deductibles and retentions.

EXHIBIT E
INSURANCE SUPPLEMENT (IF APPLICABLE)
INTENTIONALLY LEFT BLANK

EXHIBIT F
ADDITIONAL / SPECIAL TERMS
INTENTIONALLY LEFT BLANK

EXHIBIT G

TERMS AND CONDITIONS FOR SERVICES INVOLVING HAZARDOUS OR CONTAMINATED NON-HAZARDOUS WASTE OR MATERIALS

1. DEFINITIONS

- 1.1. "Hazardous Waste or Hazardous Materials": Means any substance falling within the definition of hazardous waste or hazardous material as set forth in the United States Resource Conservation and Recovery Act, 42 U.S.C §6901 et seq., the United States Comprehensive Environmental Response, Compensation and Liability Act, 42 U.S.C §9601 et seq., or any other federal, state or local statutes, regulations and ordinances which are applicable to the handling, remediation or transportation of Hazardous Waste or Hazardous Materials.
- 1.2. "Non-Hazardous Contaminated Materials": Means any material considered contaminated by State or Federal law or regulation but is not listed under RCRA and are able to pass TCLP, e g, oil contaminated materials.
- 1.3. "Law" or "Laws": Means all federal, state and local statutes, laws, ordinances and any regulations, orders and administrative guidelines (by whatever title, and without respect to whether enforceable at law) issued thereunder that are applicable to the performance of the Work under this Agreement. To the extent that a Permit is required for Subcontractor to perform the Work, "Law" includes "Permit."
- 1.4. "Permit" or "Permits": Means every permit, license, authorization, certification, permission, or equivalent control document required under any federal, state or local statute, law ordinance, regulation or order.

2. WARRANTY

- 2.1. Subcontractor warrants that it is aware of and is knowledgeable about all Laws, including Environmental Protection Agency (EPA) Regulations, U.S. Department of Transportation (DOT) Regulations, the Occupational Safety and Health Act (OSHA) Regulations and the Resource Conservation and Recovery Act (RCRA), which may be applicable to the handling, remediation, disposal or transportation of Non-Hazardous Contaminated Materials, Hazardous Waste or Hazardous Materials which comprise all or part of the Work under this Agreement. Subcontractor further warrants that the Work will be accomplished in a manner which complies with Laws including, but not limited to, EPA DOT, OSHA and RCRA.
- 2.2. Subcontractor warrants that it is fully aware of the extent of the Work required by this Agreement, that it has conducted adequate research and analysis with respect to the handling, remediation, disposal and/or transportation of Non-Hazardous Contaminated Materials, Hazardous Waste or Hazardous Materials which comprise all or part of the Work under this Agreement, and that it has the expertise, experience, personnel, equipment (including the necessary health and safety personal protective equipment), facilities and financial resources necessary to perform the Work in accordance with all Laws.
- 2.3. Subcontractor warrants that it possesses or shall obtain, prior to commencing the Work, all Permits and other forms of documentation required in order to perform the Work in full compliance with all Laws, and shall ensure that all of the Subcontractor's employees, and all sub-subcontractors and their employees at any tier shall also possess the necessary Permits, and other forms of required documentation prior to the commencement of the Work.
- 2.4. If Work requires the generation of a Site-Specific Safety and Health Plan (SSHP) as required by OSHA, the Subcontractor and its sub-subcontractors shall generate such a plan for their employees in compliance with 29 CFR 19101.20/1926.65. This plan shall be made available to Company prior

to the start of any field activities. The Subcontractor's SSHP is solely the responsibility of Subcontractor, who shall evaluate the potential hazards to its employees and adhere to its SSHP. The Subcontractor's SSHP shall, at a minimum, conform to the requirements, where applicable, established in Company SSHP if one is generated. However, the Company SSHP does not, nor is it intended to, address procedures or activities of Subcontractor or its sub-subcontractors.

2.5. Subcontractor warrants that it is aware of and understands the currently known hazards and risk of injury to persons, property and the environment associated with the handling, remediation, disposal and/or transportation of Non-Hazardous Contaminated Materials, Hazardous Waste or Hazardous Materials which comprise all or part of the Work, Subcontractor shall have instructed its employees and the employees of its sub-subcontractors at any tier in the proper safety procedures and safety equipment to be used in the performance of the Work in compliance with all Laws, including OSHA.

3. TRANSPORTING WASTES OFF-SITE

3.1. Any vehicles/waste shipment containers leaving an exclusion zone shall be decontaminated prior to leaving the Project Site. The Subcontractor shall inspect all waste shipment containers prior to leaving the Project Site to ensure that the least possible amount of soil adheres to wheels and undercarriages.

3.2. Subcontractor shall not deliver site materials to any facility other than the approved disposal facility(ies) listed on the shipping manifest.

3.3. Subcontractor shall be responsible for and all actions necessary to remedy situations involving transit of mud, soil, contaminates, or waste materials trucked offsite. This cleanup shall be accomplished at the Subcontractor's expense.

3.4. Subcontractor shall prepare and submit for approval by Client through Company, a route selection report containing results of any inspections of the proposed access routes to determine road conditions, overhead clearance, weight restrictions, and required traffic control measures.

3.5. The Subcontractor shall ensure that waste shipment containers are protected against contamination by properly covering and lining them with compatible materials or by decontaminating them prior to any use other than hauling contaminated materials.

3.6. Prior to leaving the Project Site, a load inspection of all shipments shall be conducted by a designated responsible party approved by Company's Designated Representative. The load inspection report shall be submitted to Client through Company, which shall verify and provide written documentation of the following:

- A complete and accurate manifest.
- Utilization of the proper DOT approved shipping container in accordance with 49 Code of Federal Regulation (CFR).
- Labeling in accordance with DOT regulations specified by 49 CFR.
- A bill of lading traceable to the manifest.
- Validation that all waste shipment containers are in good condition and are not leaking.
- A statement that the driver is physically fit to perform his duties.
- Validation that the driver has written documentation in his possession of completion of the required DOT safety training and health monitoring.
- A statement that the driver's log book is current.
- Validation that a certificate of insurance is in force.

3.7. Site materials will be stored and transported in bulk containers when practical.

4. NOTIFICATION OF RELEASE

4.1. The Subcontractor shall be prepared and qualified to respond to emergency situations and releases for operations under the Subcontractor's control.

4.2. Should any release of Non-Hazardous Contaminated Materials, Hazardous Waste or Hazardous Materials occur during the performance of the Work, Subcontractor shall immediately notify all appropriate agencies and take all appropriate action. The Subcontractor shall also notify Company of such release by telephone or facsimile within four (4) hours of the incident. Subcontractor shall provide Company with copies of all notices of the release provided to any person, agency or authority by Subcontractor or its agents. Such copies shall be provided to Company simultaneously with the service of the original to any person, agency or authority.

EXHIBIT H

IT Security Requirements

At all times during its performance of work arising under this Agreement, Subcontractor shall comply with (and ensure that its managers/members, employees, agents and representatives of any type comply with) all requirements and policies of Veolia or its customers concerning information security, safety and other business operations, and all applicable Federal, foreign, state and local laws, rules, ordinances, codes and regulations including, but not limited to, all laws regulating the conduct of Works.

CONFIDENTIAL INFORMATION

At the expiration or termination of this Agreement, Subcontractor shall return or destroy (if requested by Company) all copies, extracts or other reproductions in whole or in part of the Confidential Information disclosed to the Subcontractor by Company. If Company requests that the documents be destroyed, Subcontractor shall provide a certification of such destruction, by an officer of Subcontractor. Subcontractor shall retain no copies of any Confidential Information.

NOTICES

Subcontractor is required to provide notification to Company of any suspected or actual breach of security, intrusion or unauthorized use or disclosure of Company personally identifiable information or Confidential Information and/or any actual or suspected use or disclosure of data in violation of any applicable federal or state laws or regulations in connection with the services and/or deliverables contained within this Agreement. In addition to sending notification to the General Counsel, notification shall also be sent to: na.information.security@veolia.com

WARRANTIES

Subcontractor warrants that it will maintain commercially reasonable security standards for its and its end users' systems, including without limitation the use of sufficiently secure passwords and regularly required password change, maintain its systems with proper patching and security updates; will use good industry virus protection software and practices, and other security best practice procedures to protect Company data and to avoid introducing any virus that could disrupt the proper operation of the Company systems used or corrupt the data.

Subcontractor also warrants that it shall use all reasonable endeavors to ensure that its end users do not upload or distribute files that contain viruses, malicious files or other harmful code on to, or disrupt or attempt to disrupt the systems and networks used during the Works. In the event a virus or other such code is introduced into the Company systems due to Subcontractor's failure to use such endeavors or Company data is breached from Subcontractor's systems, Subcontractor will at its cost assist Company in mitigating the direct effects of such issue.

VIRUSES

Subcontractor warrants it has not knowingly included any known viruses (including, but not limited to Trojan horses, or worms, or other software code designed to permit unauthorized access to, or to erase or otherwise harm, Company software, hardware, or data) with any material provided to Company.

OWNERSHIP OF DATA

Company will at all times retain ownership in the data, proprietary information and materials that Company provides to Subcontractor, including all patent, copyright and other intellectual property rights of Company, and all materials prepared by Subcontractor pursuant to this Agreement, including but not limited to surveys, results and findings.

EXHIBIT I

ANTI-CORRUPTION COMPLIANCE

1. In carrying out the terms of this Agreement, Subcontractor hereby undertakes to strictly comply with applicable laws prohibiting the bribery of public officials and private persons, influence peddling, money laundering that may in particular entail a public contract debarment, including:
 - (a) the 1977 Foreign Corrupt Practices Act of the United States,
 - (b) the 1999 Canadian Corruption of Foreign Public Officials Act,
 - (c) the 2010 UK Bribery Act, the OECD Convention on Combating Bribery of Foreign Public Officials in International Business Transactions of December 17, 1997. SUBCONTRACTOR undertakes to put in place and implement all necessary and reasonable policies and measures to prevent corruption.
2. Subcontractor declares that to its knowledge, its legal representatives, directors, employees, agents, and anyone performing services for or on behalf of Company pursuant to this Agreement do not and will not directly or indirectly offer, give, agree to give, authorize, solicit, or accept the giving of money or anything else of value or grant any advantage or gift to any person, company or undertaking whatsoever including any government official or employee, political party official, candidate for political office, person holding a legislative, administrative or judicial position of any kind for or on behalf of any country, public agency or state owned company, official of a public international organization, for the purpose of corruptly influencing such person in their official capacity, or for the purpose of rewarding or inducing the improper performance of a relevant function or activity by any person in order to obtain or retain any business for Company or to gain any advantage in the conduct of business for Company.
3. Subcontractor further undertakes to ensure that neither Subcontractor nor any of its legal representatives, directors, employees, agents, sub-contractors and anyone performing services for or on behalf of Company under this Agreement has been, or is listed by any government agency as being debarred, suspended, proposed for suspension or debarment, or otherwise ineligible for participation in government procurement programs and/or bidding following invitations to bid advertised by the World Bank or any other international development bank.
4. Subcontractor undertakes to retain for an appropriate period following termination of this Agreement, accurate supporting documentation of its compliance with the terms of this clause.
5. Subcontractor agrees to notify Company of any breach of any term of this clause within a reasonable time.
6. If Company notifies Subcontractor that it has reasonable grounds to believe that Subcontractor has breached any term of this clause:
 - (a) Company is entitled to suspend performance of this Agreement without notice for as long as Company considers necessary to investigate the relevant conduct without incurring any liability or obligation to Subcontractor for such suspension;
 - (b) Subcontractor is obliged to take all reasonable steps to prevent the loss or destruction of any documentary evidence in relation to the relevant conduct.
7. If Subcontractor breaches any term of this clause:
 - (a) Company may immediately terminate this Agreement without notice and without incurring any liability.
 - (b) Subcontractor undertakes to indemnify Company, to the maximum extent permitted by law, for any loss, damages, or expenses incurred or suffered by Company arising out of such breach.

EXHIBIT J

BONDING / LETTER OF CREDIT REQUIREMENTS

Effective on the date this Contract is entered into the Subcontractor shall provide financial security for the performance of its obligations hereunder through a Performance Bond issued by a surety company: (1) approved by the Owner having a rating of "A" in the latest revision of the A.M. Best Company's Insurance Report; (2) listed in the United States Treasury Department's Circular 570, "Companies Holding Certificates of Authority as Acceptable Sureties on Federal Bonds and as Acceptable Reinsurance Companies"; and (3) properly registered and licensed to conduct business in the State of Connecticut. The bond shall be issued in the name of the Subcontractor, as principal, and the Company and Client, as obligee, in the full amount (100%) of the Work, to be adjusted to account for any adjustments, and shall remain open until the final completion of the Work and any modifications.

DIVISION 01

(THIS PAGE INTENTIONALLY LEFT BLANK)

SECTION 01010

SUMMARY OF WORK

PART 1 GENERAL

1.01 SECTION INCLUDES

- A. Work covered by the Contract, listing of Owner, Project location, Engineer. Sequence requirements, the Contractor's use of the premises Owner's occupancy requirements, State Sales and Use Tax, Non Discrimination in Employment, DCAM Certification Requirements, and Wetland and Waterways.

1.02 WORK COVERED BY CONTRACT DOCUMENTS

A. Main Lift Pump Station Improvements

Bid Package #1 – General

Bid Package #1 consists of all work not included in Packages #2-#3, including:

- New pumps, piping, electrical and instrumentation associated with a new dry pit / wet pit sewage pumping station
- New standby generator and plumbing, heating and ventilation systems.
- New above grade masonry block structure with brick facade
- Startup of new equipment, demonstration of control strategies, and activation of new pumping station

Bid Package #2 – Instrumentation and Control Procurement

- Furnish and program Instrumentation and control equipment as shown in the Contract Documents – Instrumentation drawings and Specifications Division 17

Bid Package #3 – Sewage Pumps Procurement

- Furnish dry pit submersible pumps and appurtenances for wastewater pumping as specified in Specification Section 11310.

All as more particularly indicated, shown or described in the Drawings, Specifications, and other Contract Documents.

1.03 OWNER

A. City of Taunton, Department of Public Works

90 Ingell Street
Taunton, MA 02708
Telephone: 508-821-1434
Contact: Fred Cornaglia, Commissioner

1.04 PROJECT LOCATION

A. Main Lift Pumping Station

690 West Water Street
Taunton, MA 02708

1.05 ENGINEER

- A. BETA Group, Inc.
700 George Washington Highway
Lincoln, Rhode Island 02865
Telephone: 401-333-2382
- Contact: Alan Gunnison, P.E.
Email: agunnison@beta-inc.com

1.06 WORK SEQUENCE

- A. In order that Work may be conducted with minimum inconvenience to the public and, work under this Contract may be coordinated with other work which may be under construction or contemplated, and that work under the Contract may conform to conditions which it has been undertaken or conditions attached to a right-of-way or particular location for this work, the Engineer may determine the point or points and time or times when portions of work will commence or be carried on and may issue orders pertaining to the work sequence, relative to the rate of progress on several portions of the work.

1.07 CONTRACTOR USE OF PREMISES

- A. The Contractor's use of premises shall be within the limits shown on the Drawings and as defined in Section 00500 – Contract Agreement, for the performance of the Work.
- B. The Contractor shall maintain access and utilities to the existing pumping station facilities at all times.
- C. The Contractor shall assume full responsibility for security of all materials and equipment on the site, including those of his subcontractor's.
- D. If directed by the Owner, the Contractor shall move any stored items that interfere with operations of the Owner.
- E. Obtain and pay for use of additional storage or work areas if needed to perform the Work.

1.08 OWNER OCCUPANCY REQUIREMENTS

- A. The existing Main Lift Pumping Station conveys the City's wastewater to the Taunton Wastewater Treatment Facility. The existing collection systems and force mains servicing the existing Main Lift Pumping Station must remain in full service at all times, throughout the duration of the project.
- B. The Owner requires safe and unhindered access to be maintained to the existing Main Lift Pumping Station for the purpose of operating and maintaining the station, throughout the duration of the Contract.

1.09 STATE SALES AND USE TAX

- A. Materials and equipment purchased for installation under this Contract are exempt from Massachusetts Sales Tax. The Contractor shall file for exemption on behalf of the Owner

with the Commonwealth of Massachusetts Department of Revenue as required by law. The exemption from the Sales Tax shall be taken into account by the Contractor during bidding.

1.10 NONDISCRIMINATION IN EMPLOYMENT

- A. Contracts for work will obligate the Contractors and subcontractors not to discriminate in employment practices.
- B. The Contractor will not discriminate against any employee or applicant for employment because of race, color, religion, sex, age, handicap, or national origin. The Contractor shall take affirmative action to ensure that applicants are employed and the employees are treated during employment without regard to their race, color, religion, sex, age, handicap, or national origin. Such actions shall include, but not be limited to, the following: employment, upgrading; demotions, or transfers; recruitment or recruitment advertising, layoffs, or terminations; rates of pay or other forms of compensation; selection for training including apprenticeship; and participation in recreational and education activities. The Contractor agrees to post in conspicuous places available to employees and applicants for employment notice to be provided setting forth the provisions of this non-discrimination clause. The Contractor will in all solicitations or advertisements for employees placed by or on behalf on the Contractor state that all qualified applicants will receive consideration for employment without regard to race, color, religion, sex, age, handicap or national origin. The Contractor will cause the foregoing provisions to be inserted in all sub-contracts for any work covered by this Contract so that such provisions will be binding upon each sub-contractor and upon sub-contracts for standard commercial supplies or raw materials.
- C. The Contractor shall keep such records and submit such reports concerning the racial and ethnic origin of applicants for employment and employees as the Owner may require as consistent with Federal and State law. The Contractor agrees to comply with such rules, regulations, or guidelines as the Commonwealth of Massachusetts may implement these requirements. The Contractor further warrants, that he will comply with the President's Executive Order No. 11246 or any preceding similar Executive Order relating thereto.
- D. Contractors must, if required, submit a compliance report (EPA Form 5720-4) concerning their employment practices and policies in order to maintain their eligibility to receive award of the Contract.
- E. Contractors must, submit a list of all Subcontractors who will perform work on the project, and written signed statements from authorized agents of labor pools with which they will or may deal with for employees on the work, together with any information to the effect that such labor pools' practices or policies are in conformity with said Executive Order that they will affirmatively cooperate in or offer no hindrance to the recruitment, employment, and equal treatment of employees seeking employment and performing work under this Contract; or a certification as to when such agents or labor pools have failed or refused to furnish them, prior to award of the Contract.
- F. Contractor will be required to comply with Equal Opportunity Requirements and to abide by the prevailing wage rates for Public Work Projects for all employees on the job. It is the responsibility of Bidders to inform themselves as to the local labor conditions, overtime compensation, health and welfare contributions, labor supply and prospective changes or adjustment of wage rates. Information is available at the Department of Labor.

- G. Contractor shall comply with the Minority and Women Workforce Participation goals as outlined in the Commonwealth of Massachusetts Supplemental Equal Employment Opportunity, Non-Discrimination and Affirmative Action Program.

1.11 WETLANDS AND WATERWAYS

- A. The Contractor's attention is directed to the fact that a portion of the work is located within and/or immediately adjacent to wetlands and waterways. Work within these areas is subject to the jurisdiction of the Massachusetts Department of Environmental Protection. All requirements and/or control measures deemed necessary by the Department shall be strictly adhered to throughout the duration of this Contract.

- B. The Contractor shall not have or assert any claim for nor shall he be entitled to any additional compensation or damages on account of requirements set forth by the Department of Environmental Protection regarding wetlands and waterways encountered during construction.

PART 2 PRODUCTS

NOT USED

PART 3 EXECUTION

NOT USED

END OF SECTION

SECTION 01020

ALLOWANCES

PART 1 GENERAL

1.01 SUMMARY

A. Section Includes

1. Contingencies and their respective value which have been established in the BID as an estimated lump sum to facilitate comparison of bids only.

B. Related Sections

1. Section 00300 - Bid Forms
2. Section 01025 - Measurement and Payment

1.02 ALLOWANCES

A. Utility Services - Bid Item No.3.

1. Provide the installation, relocation, replacement or repair of building utility services as shown on the Contract Drawings or as directed by the Engineer.
2. Coordinate all work with the respective utility company or department providing access to the site at the appropriate time to prevent any delay in the work specified to be done under these Contract Documents.

1.03 PAYMENT PROCEDURES

- A. Under these items, the Contractor shall be reimbursed for charges for the allowances required and authorized by the Owner and Engineer, as detailed in Section 01025 - Measurement and Payment.
- B. The lump-sum price for allowances is established in Section 00300 - Bid Forms as an estimated figure to facilitate comparison of bids only. The actual amount to be paid under this item shall constitute full compensation for services rendered.
- C. The lump-sum price for this item shall NOT include any costs associated with services rendered for routine utility markings, repair damages incurred as a result of the Contractor's operations, relocations of utilities done at the Contractor's request and/or convenience, or any other unauthorized services rendered by utility companies. The purpose of this item is strictly for the Contractor's reimbursement for those services authorized by the Owner or Engineer prior to the work being performed.
- D. The Contractor will be paid based on the actual PAID invoiced amount from the authority in question as approved by the Engineer. If the total cost for such charges is greater or less than the allowance amount stated under this item of the BID, a debit or credit of the difference in cost shall be to the Owner.

PART 2 PRODUCTS

2.01 MATERIALS

- A. Materials as required and ordered by the Engineer shall conform to the Contract Documents.

PART 3 EXECUTION

3.01 INSTALLATION

- A. Installation, relocation, or repair of utilities, shall be performed in accordance with the Contract Documents.

END OF SECTION

SECTION 01025

MEASUREMENT AND PAYMENT

PART 1 GENERAL

1.01 SUMMARY

A. Section Includes

1. Measurement and payment criteria applicable to the Work performed under a unit price and/or lump sum payment method of Items listed in the BID.

B. Related Sections

1. Section 00300 - Bid
2. Section 00500 - Agreement

1.02 LUMP SUM PRICES

- A. Payment will be computed on the basis of the percentage of work completed on each Item in the contract BID as determined by the Engineer. Lump sum prices are to include the cost of all necessary materials, labor, equipment, overhead, profit and other applicable costs. (See Par. 1.03, this Section.)

1.03 PRICES INCLUDE

- A. The prices stated in the Proposal include full compensation not only for furnishing all the labor, equipment and material needed for, and for performing the work and building the structures contemplated by, the Contract, but also for assuming all risks of any kind for expenses arising by reason of the nature of the soil, ground water, or the action of the elements; for all excavation and backfilling; for the removal of and delay or damage occasioned by trees, stumps, tracks, pipes, ducts, timber, masonry or other obstacles; for removing, protecting, repairing, or restoring, without cost to the Owner, all pipes, ducts, drains, sewers, culverts, conduits, curbs, gutters, walks, fences, tracks, or other obstacles, road pavements and other ground surfacing whether shown on plans or not for draining, damming, pumping or otherwise handling and removing, without damage to the work or to other parties, and without needless nuisance, all water or sewage from whatever source which might affect the work or its progress, or be encountered in excavations made for the work; for maintaining existing plant flows, for providing temporary equipment, systems and facilities as specified and as necessary so that the pumping station may continue operation during construction; for furnishing, inserting and removing as directed, all shoring staging, cofferdams etc.; for all signs, fencing, lighting, watching, guarding, temporary surfacing, bridging, snow removal, etc., necessary to maintain and protect travel on streets, walks and private ways; for making all provisions necessary to maintain and protect buildings, fences, poles, trees, structures, pipes, ducts and other public or private property affected or endangered by

the work; for the repair or replacement of such things if injured by neglect of such provisions for removing all surplus or rejected materials as may be directed; for replacing, repairing and maintaining the surfaces of streets, highways, public and private lands if and where disturbed by work performed under the Contract or by negligence in the performance of work under the Contract; for furnishing the requisite filling materials in case of any deficiency or lack of suitable materials; for obtaining all permits and licenses and complying with the requirements thereof, including the cost of furnishing any security needed in connection therewith; for any and all expense on account of the use of any patented device or process; for protection against inclement or cold weather; for all expenses incurred by or on account of the suspension; interruption or discontinuance of work; for the cost of the surety bond and adequate insurance; for all taxes, fees, union dues, etc., for which the Contractor may be or become liable, arising out of his operations incidental to the Contract; for providing equipment on the site and off site; for providing a field office and its appurtenances and for all general and incidental expenses; for tools, implements and equipment required to build and put into good working order all work contemplated by the Contract; for maintaining and guaranteeing the same as provided; and for fulfilling all obligations assumed by the Contractor under the Contract and its related documents.

- B. The Owner shall pay and the Contractor shall receive the prices stipulated in the BID made a part hereof as full compensation for everything performed and for all risks and obligations undertaken by the Contractor under and as required by the Contract.
- C. The prices shall also include the removal and disposal of the existing pipe being replaced or repaired, unless otherwise specified in the Contract.

1.04 GENERAL BID, PART I

BID ITEM NO. 1 MAIN LIFT PUMP STATION IMPROVEMENTS

- A. Payment of the lump-sum price bid in the Bid Form for Item No. 1 shall constitute full compensation for all labor, material, tools, equipment and incidentals necessary for constructing the Main Lift Pumping Station Improvements, Construction Contract, including construction of the new pumping station complete, as indicated on the Drawings and as specified in the Bidding and Contract Requirements and Divisions 1 through 17. EXCEPT:
 - A. Bid Items 2A, 2B, 2C, 2D and 3.
 - B. Bid Package #2 (Instrumentation and Controls)
 - C. Bid Package #3 (Sewage Pumps Procurement)
- B. For all equipment and systems provided in Division 11, Division 13, Division 15, Division 16, and Division 17:
 - Five (5) percent of the equipment/system cost will be withheld until the operations and maintenance manual has been approved and all copies have been turned over to the Owner.

- Five (5) percent of the equipment/system cost will be withheld until the spare parts and lubricants have been turned over to the Owner.
- Five (5) percent of the equipment/system cost will be withheld until the manufacturer's representative has certified the equipment, assisted with the start-up and completed the training.
- Five (5) percent of the equipment/system cost will be withheld until the testing has been completed and the test results have been submitted and approved.

**BID ITEM NO. 2A MANAGEMENT OF SOIL/FILL AND CONTAMINATED
MATERIALS**

1. Under this Item, the Contractor shall be paid for management of soil/fill and contaminated materials at the lump sum price stated in the Bid Schedule.
2. The lump sum price shall constitute full compensation for furnishing all labor, materials, tools, equipment, and incidentals required for managing soil/fill and contaminated material; including segregating, handling, staging, testing, and characterization of all soil and fill material prior to final transport and disposal as well as the costs associated with characterizing the destination site as required to assess background conditions; all controls necessary to maintain compliance with regulatory requirements relative to handling contaminated soils and materials; submittal and approval of all required and specified Plans; LSP services; analytical testing and characterization of all excavated soil and fill material handled; health and safety equipment; securing a staging area for stockpiling soil pending analytical testing, reuse, or disposal; protecting the stockpile areas. All costs related to transporting soils to and, if not disposed of offsite, from the staging area, if reused, shall be included for payment in this item; air monitoring; controlling the spread of airborne contaminants; all notifications, fees, permits, and taxes; and all other requirements specified in other sections of the Contract Documents; and any other work not covered by other Bid Items.
3. The Contractor will be eligible for payment for a portion of the lump sum price based on the Schedule of Values submitted in accordance with Section 01026, as approved by the Engineer.

BID ITEM NO. 2B REMOVE & DISPOSE OF RE-USE FACILITY SOIL

1. The quantity of Re-use Facility Soil to be paid for under this Item shall be the actual number of tons of Re-use Facility Soil material removed and disposed of as directed and authorized by the Engineer.
2. The unit price shall include all costs associated with the removal and disposal of Re-use Facility Soil including but not limited to labor, equipment disposal fees and furnishing the City with the appropriate material shipping record forms.

3. The Contractor will be eligible for up to 75% of the unit price when material is transported and disposed of offsite. The remaining 25% of the unit price will be paid upon the Owner's receipt of all signed transportation and disposal documents.

BID ITEM NO. 2C REMOVE & DISPOSE OF IN-STATE LANDFILL MATERIAL

1. The quantity of In-State Landfill Material to be paid for under this Item shall be the actual number of tons of In-State Landfill Material removed and disposed of as directed and authorized by the Engineer.
2. The unit price shall include all costs associated with the removal and disposal of In-State Landfill Material including but not limited to labor, equipment disposal fees and furnishing the City with the appropriate material shipping record forms.
3. The Contractor will be eligible for up to 75% of the unit price when material is transported and disposed of offsite. The remaining 25% of the unit price will be paid upon the Owner's receipt of all signed transportation and disposal documents.

BID ITEM NO. 2D REMOVE & DISPOSE OF OUT-OF-STATE LANDFILL MATERIAL

4. The quantity of Out-of-State Landfill Material to be paid for under this Item shall be the actual number of tons of Out-of-State Landfill Material removed and disposed of as directed and authorized by the Engineer.
5. The unit price shall include all costs associated with the removal and disposal of Out-of-State Landfill Material including but not limited to labor, equipment disposal fees and furnishing the City with the appropriate material shipping record forms.
6. The Contractor will be eligible for up to 75% of the unit price when material is transported and disposed of offsite. The remaining 25% of the unit price will be paid upon the Owner's receipt of all signed transportation and disposal documents.

BID ITEM NO. 3 UTILITY SERVICE ALLOWANCE

- A. The lump sum price to be paid for under this Item shall constitute full compensation as detailed in Section 01020 - Allowances, and not specifically paid for under other Items, as directed by the Engineer.
- B. The lump sum price allowance for this Item established in the Bid is an estimated figure to facilitate comparison of bids only. The actual amount to be paid under this Item to the Contractor will be the amount invoiced by the utility company.
- C. The lump sum price allowance for this Item shall NOT include any costs associated with Items and/or services for which specific payment Items are provided for under the Bid.
- D. If the total cost for such charges is greater or less than the allowance amount stated under this Item of the Bid, a debit or credit of the difference in such cost shall be to the Owner.

1.05 TOTAL BID

- A. Part I covers the work of the General Contractor and Part II covers work of the Subcontractors.

1.06 PAYMENTS, PART I AND II

- A. Payment of the total price bid in the General Bid for Part I, together with the lump sums bid in the Sub-bid for Part II, shall fully compensate the Contractor for furnishing all labor, materials, equipment and incidentals required to complete the work as outlined above and under Section 01010. Payment shall also include compensation for all other work required to complete the Project as described in the Contract Documents and not specifically mentioned under Part I or II.

1.07 EXTRA WORK

- A. Extra work, if any, will be performed and paid for in accordance with the Owner Contractor Agreement, General Conditions and Supplementary Conditions.

END OF SECTION

(THIS PAGE INTENTIONALLY LEFT BLANK)

SECTION 01026

SCHEDULE OF VALUES

PART 1 GENERAL

1.01 SUMMARY

A. Section Includes

1. Requirements for breakdown of lump sum bid.

B. Related Sections

1. Section 01300 - Submittals

1.02 BREAKDOWN OF LUMP SUM BID

A. Within 20 business days of the date of the executed Contract, a list detailing the breakdown of the lump sums bid by the appropriate Divisions of these Specifications or as otherwise directed by the Engineer, shall be submitted for review and concurrence by the Engineer. This list will be used by the Engineer as a guide in preparing estimates for payment. The list shall be an accurate representation of costs required to complete the Work in accordance with the Contract Documents.

B. A schedule of the monthly value of work done based on the Progress Schedule submitted under Section 01300 - Submittals shall be submitted within 20 business days of the date of the executed Contract. The schedule shall show the total sum of work done for each month of the projected construction period and shall be updated monthly to reflect the actual amount requisitioned for payment.

PART 2 PRODUCTS

NOT USED

PART 3 EXECUTION

NOT USED

END OF SECTION

(THIS PAGE INTENTIONALLY LEFT BLANK)

SECTION 01035

MODIFICATION PROCEDURES

PART 1 GENERAL

1.01 SUMMARY

A. Section Includes

1. Procedures for making modifications to the Contract by change orders or other means.

B. Related Sections

1. Document 00500 - Agreement

1.02 CHANGE ORDERS

- A. In general Change Orders will be issued for modification of Contract documents which will incorporate changes in the Contract requirements, including additions or deletions in the Work; for unforeseen field conditions which will necessitate changes in the Work; changes in code provisions or other requirements of federal, state or local authority requiring changes in the Work; changes in the availability of products or for incorporating new products into the work and for changes directed by the Engineer for the benefit of the Owner.
- B. Authority to execute Change Orders shall be that of the Owner and not of the Contractor. Changes Orders will, in general, originate by a "Change Order Proposal Request" or by issuance of a "Construction Change Authorization".
- C. Unless authorized by the Owner, no work shall be performed that is involved in the change until a formal Change Order is issued.
- D. To initiate a Change Order, the Owner will forward a Change Order proposal request describing the proposed changes and if required, include additional or revised drawings and specifications soliciting a formal quotation of cost and time to complete the proposed Change Order work. Upon reaching mutual agreement on the cost and time, the Engineer will sign his approval of the Change Order and submit it to the Contractor for his full signature of acceptance.

1.03 FIELD ORDERS

- A. The Owner may, to avoid costly removal of, or alterations to, present on-going work, issue a Work Directive Change authorizing the Contractor to proceed, subject to later negotiation of the price of the change.

1.04 PRICE AGREEMENTS

- A. Prices agreed upon to cover the Change Orders may be either by mutual acceptance of a lump sum or by unit prices as stated in the Contract bid proposal or actual direct cost plus a percentage for overhead, profit and other expenses consistent with Section 00500 – Contract Agreement.

- B. Work done by a subcontractor entitles the General Contractor a percentage of the sum of the actual direct cost, not including the subcontractor's overhead and profit, consistent with Section 00500 – Contract Agreement.
- C. Method for computing the cost of the change shall be based on the net additional increase. No overhead and profit shall be deducted from prices for changes deleting work.
- D. The Change Order form document shall indicate the net adjustment (+/-) to the total Contract price as a result thereof including extension or reduction of time when applicable.

PART 2 PRODUCTS

NOT USED

PART 3 EXECUTION

NOT USED

END OF SECTION

SECTION 01040

COORDINATION

PART 1 GENERAL

1.01 SECTION INCLUDES

- A. Requirements for coordinating the various parts of Work under this Contract.

1.02 REQUIREMENTS

- A. Coordinate scheduling, submittals, and Work of the various Sections of specifications to assure efficient and orderly sequence of installation of interdependent construction elements.
- B. Verify that utility requirement characteristics of operating equipment are compatible with building utilities. Coordinate work of various Sections having interdependent responsibilities for installing, connecting to, and placing in service, such equipment.
- C. Coordinate space requirements and installation of mechanical, instrumentation and electrical work, which are indicated diagrammatically on Drawings. Follow routing shown for pipes, ducts, and conduit, as closely as practicable; place runs parallel with line of building. Utilize spaces efficiently to maximize accessibility for other installations, for maintenance, and for repairs.
- D. In finished areas except as otherwise indicated, conceal pipes, ducts, and wiring within the construction. Coordinate locations of fixtures and outlets with finish elements.
- E. Coordinate completion and clean up of Work of separate Sections in preparation for Substantial Completion.
- F. After Owner occupancy of premises, coordinate access to site for correction of defective Work and Work not in accordance with Contract Documents, to minimize disruption of Owner's activities.
- G. Coordinate work with all utility companies necessary for completion of work under this contract.

PART 2 PRODUCTS

NOT USED

PART 3 EXECUTION

NOT USED

END OF SECTION

(THIS PAGE INTENTIONALLY LEFT BLANK)

SECTION 01045

CUTTING, CORING AND PATCHING

PART 1 GENERAL

1.01 SUMMARY

A. Section Includes

1. Requirements and limitations for cutting, coring and patching of Work.

B. Related Sections

1. Section 01300-Submittals

1.02 SUBMITTALS

A. In accordance with Section 01300 submit written request in advance of cutting or alteration which affects the following:

1. Structural integrity of any element of Project.
2. Integrity of weather-exposed or moisture-resistant element.
3. Efficiency, maintenance, or safety of any operational element.
4. Visual qualities of sight exposed elements.
5. Work of Owner or separate contractor.

B. Include in request:

1. Identification of Project.
2. Location and description of affected work.
3. Necessity for cutting or alteration.
4. Description of proposed work, and products to be used.
5. Alternatives to cutting and patching.
6. Effect on work of Owner or separate contractor.
7. Written permission of affected separate contractor.
8. Date and time work will be executed.

C. Should conditions of the Work, or schedule, indicate a required change of materials or methods for cutting and patching, notify the Engineer and secure his written permission and the required Change Order prior to proceeding.

1.03 RELATED SECTIONS

A. Section 15050 – Pipe Sleeves

PART 2 PRODUCTS

2.01 MATERIALS

A. For replacement of items removed, use materials complying with pertinent sections of these specifications.

- B. Sealing materials to be used to seal annular space between cored hole in walls and related pipes to be in accordance with Section 15050.
- C. Sealing cored holes in sewer manholes to be with a resilient seal similar to Kor-N-Seal made by National Pollution Control Systems, Inc., Nashua, NH or similar product, as indicated on the Drawings.

PART 3 EXECUTION

3.01 EXAMINATION

A. Site Verification of Conditions

1. Inspect existing conditions, including elements subject to movement or damage during cutting, excavating, patching, and backfilling.
2. After uncovering the work, inspect conditions affecting installation of new work.
3. If uncovered conditions are not as anticipated, immediately notify the Engineer.
4. Do not proceed until unsatisfactory conditions are corrected.

3.02 PREPARATION

A. Protection

1. Provide required protection including, but not necessarily limited to, shoring, bracing, and support to maintain structural integrity of the Work.
2. Perform cutting and demolition by methods which will prevent damage to portions of the Work.

B. Surface Preparation

1. Provide proper surfaces to receive installation of repair and new work.

3.03 INSTALLATION

A. Use adequate numbers of skilled workmen who are trained and experienced in the necessary crafts and who are familiar with the specified requirements and the methods needed for proper performance of the Work.

B. Execute cutting, fitting, and patching (including excavation and fill) to complete work.

C. Installation of materials shall be in accordance with manufacturer's instructions.

D. Installations, repair or replacement of items provided under this Contract shall be in accordance with the Contract Documents.

3.04 FIELD QUALITY CONTROL

A. In addition to other requirements specified, upon the Engineer's request uncover work to provide for inspection by the Engineer of covered work, and remove samples of installed materials for testing.

B. Do not cut or alter work performed under separate contracts without the Engineer's written permission.

3.05 ADJUSTING

- A. Perform fitting and adjusting of products to provide finished installation complying with the specified tolerances and finishes.

END OF SECTION

(THIS PAGE INTENTIONALLY LEFT BLANK)

SECTION 01050
FIELD ENGINEERING

PART 1 GENERAL

1.01 SECTION INCLUDES

- A. Survey work and other field engineering responsibilities of the Contractor.

1.02 REQUIREMENTS

- A. The Contractor shall be responsible for layout of the work and the establishing of lines and grades.
- B. Establish elevations, lines, levels, reference marks, batter boards, etc., required during the progress of the Work. Verify such marks by instrument to confirm accuracy.
- C. Locate and protect survey control and reference points.
- D. Make, check, and be responsible for all measurements and dimensions necessary for the proper construction of the Work.
- E. The Engineer will be permitted to check the lines, elevations, reference marks, batter boards, etc., set by the Contractor. The Contractor shall correct any errors found in lines, elevations, reference marks, batter boards, etc.. Such a check shall not be construed as approval of the Contractor's work and shall not relieve or diminish the responsibility of the Contractor for the accurate construction and completion of the Work.
- F. Control datum for survey as shown on Drawings.

1.03 QUALITY ASSURANCE

- A. Qualifications
 - 1. Employ a Civil Engineer or Land Surveyor registered within the Commonwealth of Massachusetts, acceptable to the Engineer.
- B. Certifications
 - 1. Submit certificate signed by the Contractor's Engineer or Land Surveyor stating elevations and locations of the Work are in conformance with the Contract Documents.

PART 2 PRODUCTS

NOT USED

PART 3 EXECUTION

NOT USED

END OF SECTION

SECTION 01060

PERMITS

PART 1 GENERAL

1.01 SECTION INCLUDES

- A. Building codes, Mechanical codes, and Electrical codes, Regulations, Permits and Fees applicable to the project.

1.02 PERMITS BY CONTRACTOR

- A. The Contractor shall secure all necessary permits from the state, city or town authorities having jurisdiction, for digging of trenches in the streets or highways and all other building and construction operations requiring permits.
- B. As a minimum the following permits are required:
 - 1. Building Permit – City of Taunton
 - 2. National Pollutant Discharge Elimination System (NPDES) General Permit for Dewatering Activity Discharge, Permit No. MAG070000.
 - 3. City of Taunton Contractor's License
 - a. Contractor's License Requirements and Application is attached to this specification section.
 - 4. Trench Permit (Jackie's Law) – City of Taunton Dept. of Public Works
 - a. The Permit Application Form is attached to this Specification Section
 - 5. Industrial User Permit – Veolia Water
 - a. This permit is required to discharge treated groundwater to the City sewer system.

1.03 PERMITS BY OWNER

- A. The Owner has obtained or will obtain and pay all fees for the permits listed here:
 - 1. Order of Conditions – Local Conservation Commission
 - 2. WM 16 and WP 68 Treatment Works Plan Approval, without Permit Modification - MassDEP

1.04 CODES

- A. The Contractor shall conform to the requirements of and pay all fees imposed by local and State Building Authorities having jurisdiction over the Work. The Contractor is responsible to conform to all building, mechanical, electrical and plumbing code requirements.
- B. The Contractor shall conform to the latest requirements of the following codes:
 - 1. Federal, State and Municipal Laws
 - 2. 2009 International Building Code (IBC)
 - 3. 2009 International Energy Conservation Code (IECC)
 - 4. Commonwealth of Massachusetts State Building Code, 780 CMR
 - 5. Commonwealth of Massachusetts State Plumbing Code 248 CMR 10.00
 - 6. Commonwealth of Massachusetts Electrical Code 527 CMR 12.00
 - 7. Massachusetts Architectural Access Board (521 CMR)
 - 8. Massachusetts Board of Fire Prevention Regulations (527 CMR)
 - 9. OSHA

10. Any prevailing rules and regulations pertaining to adequate protection and/or guarding of any moving parts or otherwise hazardous locations.

1.04 FEES

A. The cost of all permits secured by the Contractor shall be borne by him and shall be considered as having been included in the price or prices stated in the Bid. Copies of all required permits shall be filed with the Engineer prior to starting work for which a permit is required.

PART 2 PRODUCTS

NOT USED

PART 3 EXECUTION

NOT USED

END OF SECTION



City of Taunton

Department of Public Works Commissioner's Office

Contractor Licensing Requirements & Application

Construction Contract Year

May 1st 2021 to April 30th 2022

Prepared by:

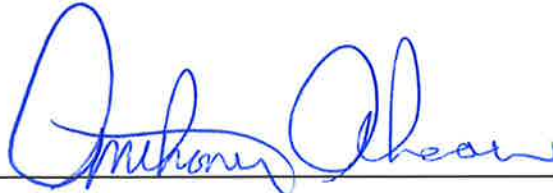
 3/30/2021

Tony Abreau: Assistant Commissioner, Taunton Public Works

Approved by:

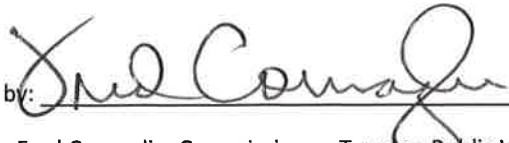
 3/30/21

Fred Cornaglia: Commissioner, Taunton Public Works



City of Taunton
Department of Public Works Commissioner's Office
Contractor Licensing Requirements

Contractors are licensed by the City of Taunton (City) through the Department of Public Works Commissioner's Office (DPW). Only licensed contractors may work in the City's layout of a public way to install or work on driveways and underground utilities such as water, sewer, drainage, gas, electrical, or road construction.

1.0 Licensing Requirements:

1.1: Only utility contractors licensed by or contractors working directly for the City of Taunton are allowed to work within the limits of the city streets, sidewalks, easement, layouts, or right-of-ways, or to make connections to municipal storm drains, sewers, or water lines.

1.2: To assure faithful performance of all work and to indemnify the city against any loss or damage from negligent or defective work a yearly bond in the amount of either \$50,000.00 for road projects or \$5,000.00 for sewer laterals, must be submitted by all contractor applicants. For larger projects, the DPW Commissioner's Office may require the bond to be increased.

1.3: To the fullest extent not prohibited by laws and regulations, the contractor shall indemnify, hold harmless and defend the City of Taunton, its officers, employees, and agents from and against all claims, cost, losses, and damages, including but not limited to attorney's fees, caused by, arising out of, or relating to any claim of action against the City of Taunton, provided that any such claim, cost, loss or damage is caused in whole or in part by any negligent act or omission of the contractor, its employees, agents, or anyone for whose acts any of them may be liable.

1.4: Each contractor shall provide to the City of Taunton a Certificate of Insurance (COI) providing evidence of the following.

- 1. Commercial General Liability (CGL) with limits of not less than \$1,000,000.00 each occurrence and \$2,000,000.00 Annual Aggregate. If the CGL coverage contains a General Aggregate Limit, such General Aggregate shall apply separately to each project. CGL coverage shall be written on ISO Occurrence Form CG 00 01 (1093) or a substitute form providing equivalent coverage and shall cover liability arising from collapse, explosive hazards, underground work by equipment on the street, premises, completed operations, independent contractors, and personal injury. The City of Taunton shall be listed as "additional insured" on the CGL policy.**

2. Automobile Liability

A: Business Auto Liability with limits of as least \$1,000,000.00 each accident;

B: Business Auto coverage must include coverage for liability arising out of all owned, leased, hired, and non-owned automobiles.

3. Workers Compensation and Employers Liability

Employers Liability Insurance limits of at least \$500,000.00 each accident for bodily injury by accident and \$500,000.00 each employee for injury by disease.

1.5

Applications for a contractor's license shall be submitted to the City Department of Public Works Commissioner for approval or disapproval.

1.6

Each license shall be granted for one year from May 1st until April 30th of the following year, and the required bond and certificate of insurance shall be co-terminus with the license. Such license may be suspended for cause by the City Council at its next meeting.

1.7

Every Corporation shall submit with its application a copy of its current annual Certificate of Good Standing and a copy of any subsequent certificate of change of corporate officers on file with the Secretary of State as required by M.G.L.c. 156. SS 24 AND 27.

2.0 Schedule of License Fees

Licensed road opening and utility contractor fees are as follows:

Initial Application Fee	\$500.00
Annual Renewal Fee	\$250.00

3.0 License Application

Complete the License Application identified as Exhibit A

Exhibit A: Contractor License Application



City of Taunton
Department of Public Works
Commissioner's Office

Company Name:

Owners Name:

Street Address:

City: State: Zip Code:

Telephone #: E-mail:

Country: Dunn & Bradstreet #: Federal Employee ID #:

Point of Contact: Point of Contact Phone #:

Website (Optional) E-mail:

What areas does your company serve?:

S.E Mass	Metro Boston	W. Mass	N. Mass
Mass (ALL)	RI	CT	NH
NY	NJ	PA	Other

Primary SIC Code

Secondary SIC Code

Date company was founded?

Gross Annual Sales:

\$0-\$49,999	\$50,000-\$99,999	\$100,000-\$499,999
\$500,000-\$999,999	\$1,000,000-\$2,499,999	
\$2,500,000-\$4,999,999	\$5,000,000-\$10,000,000	
Over \$10,000,000		

Number of Employees:

1-10	10-20	20-30
30-50	Over 50 Employees	

Bonding Capacity:

\$0-\$49,999	\$50,000-\$99,999	\$1000,000-\$499,999
\$500,000-\$999,999	\$1,000,000-\$2,499,99	
\$2,500,000-\$4,999,999	\$5,000,000-\$10,000,000	
Over \$10,000,000		

Business Structure:

Profit	Non-Profit	S Corporation	C Corporation
Sole Proprietor	Partnership	Joint Venture	LLC

Qualifications

What contractor licenses do you currently hold in Massachusetts?

In which Municipalities in Massachusetts do you currently hold open road licenses?

Please identify Massachusetts contractor license (s) you have that are currently active. (Include license (s) number, type of contractor's license, and expiration date)

Please provide at least 4 business references including your current bonding company.

Largest Contract:

\$0-\$49,999

\$50,000-\$99,999

\$100,000-\$499,999

\$500,000-\$999,999

\$1,000,000-\$2,499,999

\$2,500,000-\$4,999,999

\$5,000,000-\$10,000,000

Over \$10,000,000

Contracting agency for largest contract?

Company comments (Include a brief description of the goods and/or services your company provides):

Name of President or CEO?:

Date:

Telephone Number:

E-mail:

Name of individual completing this form?

Telephone Number:

E-mail:

Signature of individual completing the form.

Date



City of Taunton

Permit issued by: Department of Public Works
 90 Ingel Street
 Taunton, Massachusetts 02780
 Phone (508) 821-1431
 FAX (508) 821-1059

Permit Number _____

Date Issued _____

Expiration Date _____

TRENCH PERMIT APPLICATION

Pursuant to G.L. c. 82A §1 and 520 CMR 7.00 et seq.(as amended)

Submittals Normally Processed in 5 Business Days

Name of Applicant			Phone	Cell
Applicant Street Address				
City/Town	ST	ZIP		
Name of Excavator (if different from applicant)			Phone	Cell
Excavator Street Address				
City/Town	ST	ZIP		
Name of Property Owner(s)			Phone	Cell
Trench Address				
City/Town	ST	ZIP		
Email			Permit Fee Received No () Yes ()	
Description, location and purpose of proposed trench: Please describe the exact location of the proposed trench and its purpose (include a description of what is (or is intended) to be laid in proposed trench (eg; pipes/cable lines etc.) Please use reverse side if additional space is needed.				
Insurance Certificate #:				
Name and Contact Information of Insurer:				
Policy Expiration Date:				
Dig Safe #:				
Name of Competent Person (as defined by 520 CMR 7.02):				
Massachusetts Hoisting License #			Expiration Date:	
License Grade:				

THIS PERMIT MUST BE FULLY COMPLETED PRIOR TO CONSIDERATION

BY SIGNING THIS FORM, THE APPLICANT, OWNER, AND EXCAVATOR ALL ACKNOWLEDGE AND CERTIFY THAT THEY ARE FAMILIAR WITH, OR, BEFORE COMMENCEMENT OF THE WORK, WILL BECOME FAMILIAR WITH, ALL LAWS AND REGULATIONS APPLICABLE TO WORK PROPOSED, INCLUDING OSHA REGULATIONS, G.L. c. 82A, 520 CMR 7.00 et seq., AND ANY APPLICABLE MUNICIPAL ORDINANCES, BY-LAWS AND REGULATIONS AND THEY COVENANT AND AGREE THAT ALL WORK DONE UNDER THE PERMIT ISSUED FOR SUCH WORK WILL COMPLY THEREWITH IN ALL RESPECTS AND WITH THE CONDITIONS SET FORTH BELOW.

THE UNDERSIGNED OWNER AUTHORIZES THE APPLICANT TO APPLY FOR THE PERMIT AND THE EXCAVATOR TO UNDERTAKE SUCH WORK ON THE PROPERTY OF THE OWNER, AND ALSO, FOR THE DURATION OF CONSTRUCTION, AUTHORIZES PERSONS DULY APPOINTED BY THE MUNICIPALITY TO ENTER UPON THE PROPERTY TO MONITOR AND INSPECT THE WORK FOR CONFORMITY WITH THE CONDITIONS ATTACHED HERETO AND THE LAWS AND REGULATIONS GOVERNING SUCH WORK.

THE UNDERSIGNED APPLICANT, OWNER AND EXCAVATOR AGREE JOINTLY AND SEVERALLY TO REIMBURSE THE MUNICIPALITY FOR ANY AND ALL COSTS AND EXPENSES INCURRED BY THE MUNICIPALITY IN CONNECTION WITH THIS PERMIT AND THE WORK CONDUCTED THEREUNDER, INCLUDING BUT NOT LIMITED TO ENFORCING THE REQUIREMENTS OF STATE LAW AND CONDITIONS OF THIS PERMIT, INSPECTIONS MADE TO ASSURE COMPLIANCE THEREWITH, AND MEASURES TAKEN BY THE MUNICIPALITY TO PROTECT THE PUBLIC WHERE THE APPLICANT OWNER OR EXCAVATOR HAS FAILED TO COMPLY THEREWITH INCLUDING POLICE DETAILS AND OTHER REMEDIAL MEASURES DEEMED NECESSARY BY THE MUNICIPALITY.

THE UNDERSIGNED APPLICANT, OWNER AND EXCAVATOR AGREE JOINTLY AND SEVERALLY TO DEFEND, INDEMNIFY, AND HOLD HARMLESS THE MUNICIPALITY AND ALL OF ITS AGENTS AND EMPLOYEES FROM ANY AND ALL LIABILITY, CAUSES OR ACTION, COSTS, AND EXPENSES RESULTING FROM OR ARISING OUT OF ANY INJURY, DEATH, LOSS, OR DAMAGE TO ANY PERSON OR PROPERTY DURING THE WORK CONDUCTED UNDER THIS PERMIT.

APPLICANT SIGNATURE

_____ **DATE** _____

EXCAVATOR SIGNATURE (IF DIFFERENT)

_____ **DATE** _____

OWNER'S SIGNATURE (IF DIFFERENT)

_____ **DATE** _____

For City/Town use -- Do not write in this section	
PERMIT APPROVED BY	\$ _____ Application Fee
PERMITTING AUTHORITY Date	
CONDITIONS OF APPROVAL	

CONDITIONS AND REQUIREMENTS PURSUANT TO G.L.C.82A AND 520 CMR 7.00 et seq. (as amended)

By signing the application, the applicant understands and agrees to comply with the following:

No trench may be excavated unless the requirements of sections 40 through 40D of chapter 82, and any accompanying regulations, have been met and this permit is invalid unless and until said requirements have been complied with by the excavator applying for the permit including, but not limited to, the establishment of a valid excavation number with the underground plant damage prevention system as said system is defined in section 76D of chapter 164 (DIG SAFE);

Trenches may pose a significant health and safety hazard. Pursuant to Section 1 of Chapter 82 of the General Laws, an excavator shall not leave any open trench unattended without first making every reasonable effort to eliminate any recognized safety hazard that may exist as a result of leaving said open trench unattended. Excavators should consult regulations promulgated by the Department of Public Safety in order to familiarize themselves with the recognized safety hazards associated with excavations and open trenches and the procedures required or recommended by said department in order to make every reasonable effort to eliminate said safety hazards which may include covering, barricading or otherwise protecting open trenches from accidental entry.

Persons engaging in any in any trenching operation shall familiarize themselves with the federal safety standards promulgated by the Occupational Safety and Health Administration on excavations: 29 CFR 1926.650 et seq., entitled

Subpart P "Excavations".

Excavators engaging in any trenching operation who utilize hoisting or other mechanical equipment subject to chapter 146 shall only employ individuals licensed to operate said equipment by the Department of Public Safety pursuant to said chapter and this permit must be presented to said licensed operator before any excavation is commenced;

By applying for, accepting and signing this permit, the applicant hereby attests to the following: (1) that they have read and understands the regulations promulgated by the Department of Public Safety with regard to construction related excavations and trench safety; (2) that he has read and understands the federal safety standards promulgated by the Occupational Safety and Health Administration on excavations: 29 CFR 1926.650 et seq., entitled Subpart P "Excavations" as well as any other excavation requirements established by this municipality; and (3) that he is aware of and has, with regard to the proposed trench excavation on private property or proposed excavation of a city or town public way that forms the basis of the permit application, complied with the requirements of sections 40-40D of chapter 82A.

This permit shall be posted in plain view on the site of the trench.

For additional information please visit the Department of Public Safety's website at www.mass.gov/dps

Summary of Excavation and Trench Safety Regulation (520 CMR 14.00 et seq.)

This summary was prepared by the Massachusetts Department of Public Safety pursuant to G.L.c.82A and does not include all requirements of the 520 CMR 14.00. To view the full regulation and G.L.c.82A, go to www.mass.gov/dps Pursuant to M.G.L. c. 82, § 1, the Department of Public Safety, jointly with the Division of Occupational Safety, drafted regulations relative to trench safety. The regulation is codified in section 14.00 of title 520 of the Code of Massachusetts Regulations. The regulation requires all excavators to obtain a permit prior to the excavation of a trench made for a construction-related purpose on public or private land or rights-of-way. All municipalities must establish a local permitting authority for the purpose of issuing permits for trenches within their municipality. Trenches on land owned or controlled by a public (state) agency requires a permit to be issued by that public agency unless otherwise designated.

In addition to the permitting requirements mandated by statute, the trench safety regulations require that all excavators, whether public or private, take specific precautions to protect the general public and prevent unauthorized access to unattended trenches. Accordingly, unattended trenches must be covered, barricaded or backfilled. Covers must be road plates at least ¾" thick or equivalent; barricades must be fences at least 6' high with no openings greater than 4" between vertical supports; backfilling must be sufficient to eliminate the trench. Alternatively, excavators may choose to attend trenches at all times, for instance by hiring a police detail, security guard or other attendant who will be present during times when the trench will be unattended by the excavator.

The regulations further provide that local permitting authorities, the Department of Public Safety, or the Division of Occupational Safety may order an immediate shutdown of a trench in the event of a death or serious injury; the failure to obtain a permit; or the failure to implement or effectively use adequate protections for the general public. The trench shall remain shutdown until re-inspected and authorized to re-open provided, however, that excavators shall have the right to appeal an immediate shutdown. Permitting authorities are further authorized to suspend or revoke a permit following a hearing. Excavators may also be subject to administrative fines issued by the Department of Public Safety for identified violations.

Summary of 1926 CFR Subpart P -OSHA Excavation Standard

This is a worker protection standard, and is designed to protect employees who are working inside a trench. This summary was prepared by the Massachusetts Division of Occupational Safety and not OSHA for informational purposes only and does not constitute an official interpretation by OSHA of their regulations, and may not include all aspects of the standard. For further information or a full copy of the standard go to www.osha.gov.

Trench Definition per the OSHA standard:

An excavation made below the surface of the ground, narrow in relation to its length.

In general, the depth is greater than the width, but the width of the trench is not greater than fifteen feet.

Protective Systems to prevent soil wall collapse are always required in trenches deeper than 5', and are also required in trenches less than 5' deep when the competent person determines that a hazard exists. Protection options include:

Shoring. Shoring must be used in accordance with the OSHA Excavation standard appendices, the equipment manufacturer's tabulated data, or designed by a registered professional engineer.

Shielding (Trench Boxes). Trench boxes must be used in accordance with the equipment manufacturer's tabulated data, or a registered professional engineer.

Sloping or Benching. In Type C soils (what is most typically encountered) the excavation must extend horizontally 1 ½ feet for every foot of trench depth on both sides, 1 foot for Type B soils, and ¾ foot for Type A soils.

A registered professional engineer must design protective systems for all excavations greater than 20' in depth.

Ladders must be used in trenches deeper than 4'.

Ladders must be inside the trench with workers at all times, and located within 25' of unobstructed lateral travel for every worker in the trench.

Ladders must extend 3' above the top of the trench so workers can safely get onto and off of the ladder.

Inspections of every trench worksite are required:

Prior to the start of each shift, and again when there is a change in conditions such as a rainstorm.

Inspections must be conducted by the competent person (see below).

Competent Person(s) is:

Capable (i.e., trained and knowledgeable) in identifying existing and predictable hazards in the trench, and other working conditions which may pose a hazard to workers, and

Authorized by management to take necessary corrective action to eliminate the hazards. Employees must be removed from hazardous areas until the hazard has been corrected.

Underground Utilities must be:

Identified prior to opening the excavation (e.g., contact Digsafe).

Located by safe and acceptable means while excavating.

Protected, supported, or removed once exposed.

Spoils must be kept back a minimum of 2' from the edge of the trench.

Surface Encumbrances creating a hazard must be removed or supported to safeguard employees. Keep heavy equipment and heavy material as far back from the edge of the trench as possible.

Stability of Adjacent Structures:

Where the stability of adjacent structures is endangered by creation of the trench, they must be underpinned, braced, or otherwise supported.

Sidewalks, pavements, etc. shall not be undermined unless a support system or other method of protection is provided.

Protection from water accumulation hazards:

It is not allowable for employees to work in trenches with accumulated water. If water control such as pumping is used to prevent water accumulation, this must be monitored by the competent person.

If the trench interrupts natural drainage of surface water, ditches, dikes or other means must be used to prevent this water from entering the excavation.

Additional Requirements:

For mobile equipment operated near the edge of the trench, a warning system such as barricades or stop logs must be used.

Employees are not permitted to work underneath loads. Operators may not remain in vehicles being loaded unless vehicles are equipped with adequate protection as per 1926.601(b)(6).

Employees must wear high-visibility clothing in traffic work zones.

Air monitoring must be conducted in trenches deeper than 4' if the potential for a hazardous atmosphere exists. If a hazardous atmosphere is found to exist (e.g., O₂ <19.5% or >23.5%, 20% LEL, specific chemical hazard), adequate protections shall be taken such as ventilation of the space.

Walkways are required where employees must cross over the trench. Walkways with guardrails must be provided for crossing over trenches > 6' deep.

Employees must be protected from loose rock or soil through protections such as scaling or protective barricades.

(THIS PAGE INTENTIONALLY LEFT BLANK)

SECTION 01067

COMMONWEALTH OF MASSACHUSETTS AND FEDERAL REQUIREMENTS

PART 1 - GENERAL

TABLE OF CONTENTS

- 1.01 American Iron and Steel
- 1.02 Suspension and Debarment
- 1.03 Excerpts From Massachusetts Statutes
- 1.04 Minimum Wage Rates
- 1.05 Safety and Health
- 1.06 Modified Supplemental Equal Employment Opportunity Anti-Discrimination and Affirmative Action Program
- 1.07 Supplemental Equal Employment Opportunity Anti-Discrimination and Affirmative Action Program – Contract Compliance Procedure
- 1.08 Special Provisions for Minority/Women Business Enterprises Statutes Regulating Construction Contracts for Public Buildings and Public Works Projects

LIST OF ATTACHMENTS

- A - Excerpts from Massachusetts General Laws
- B - Massachusetts Prevailing Wage Rates & Federal Davis-Bacon Wage Rates
- C - Massachusetts Equal Employment Opportunity Package
- D - Massachusetts Diesel Retrofit Forms

1.01 AMERICAN IRON AND STEEL

A. The Contractor acknowledges to and for the benefit of the City of Taunton (“Owner”) and the Commonwealth of Massachusetts (the “State”) that it understands the goods and services under this Agreement are being funded with monies made available by the Clean Water State Revolving Fund that have statutory requirements commonly known as “American Iron and Steel;” that requires all of the iron and steel products used in the project to be produced in the United States (“American Iron and Steel Requirement”) including iron and steel products provided by the Contractor pursuant to this Agreement. The Contractor hereby represents and warrants to and for the benefit of the Owner and the State that (a) the Contractor has reviewed and understands the American Iron and Steel Requirement, (b) all of the iron and steel products used in the project will be and/or have been produced in the United States in a manner that complies with the American Iron and Steel Requirement, unless a waiver of the requirement is approved, and (c) the Contractor will provide any further verified information, certification or assurance of compliance with this paragraph, or information necessary to support a waiver of the American Iron and Steel Requirement, as may be requested by the Owner or the State. Notwithstanding any other provision of this Agreement, any failure to comply with this paragraph by the Contractor

shall permit the Owner or State to recover as damages against the Contractor any loss, expense, or cost (including without limitation attorney's fees) incurred by the Owner or State resulting from any such failure (including without limitation any impairment or loss of funding, whether in whole or in part, from the State or any damages owed to the State by the Owner). While the Contractor has no direct contractual privity with the State, as a lender to the Owner for the funding of its project, the Owner and the Contractor agree that the State is a third-party beneficiary and neither this paragraph (nor any other provision of this Agreement necessary to give this paragraph force or effect) shall be amended or waived without the prior written consent of the State.

1.02 SUSPENSION AND DEBARMENT

The Contractor agrees that it will fully comply with Subpart C of 2 CFR Part 180 and 2 CFR Part 1532, entitled "Responsibilities of Participants Regarding Transactions (Doing Business with Other Persons)". The Contractor shall not award any subcontracts or purchase any materials from suppliers that appear on the Excluded Parties List System. The Contractor shall include this requirement in each subcontract and require it to be included in all subcontracts regardless of tier. The Contractor shall maintain reasonable records to demonstrate compliance with these requirements.

1.03 EXCERPTS FROM MASSACHUSETTS STATUTES

A. In addition to the requirements as set forth under "Compliance with Laws" in the AGREEMENT, particular attention is directed to certain stipulations of Chapter 149 of the General Laws of Massachusetts, as amended to date as follows:

Section 25. "Every employee in public work shall lodge, board, and trade where and with whom he elects; and no person or his agents or employees under contract with the commonwealth, a county, city or town, or with a department, board, commission or officer acting therefore, for the doing of public work shall directly or indirectly require, as a condition of employment therein, that the employee shall lodge, board or trade at a particular place or with a particular person. This section shall be made a part of the contract for such employment."

Section 26. "In the employment of mechanics and apprentices, teamsters, chauffeurs and laborers in the construction of public works by the commonwealth, or by a county, town, authority or district, or by persons contracting or subcontracting for such works, preference shall first be given to citizens of the commonwealth who have been residents of the commonwealth for at least six months at the commencement of their employment who are male veterans as defined in clause Forty-third of section seven of chapter four, and who are qualified to perform the work to which the employment relates; and secondly, to citizens of the commonwealth generally who have been residents of the commonwealth for at least six months at the commencement of their employment, and if they cannot be obtained in sufficient numbers, then to citizens of the United States, and every contract for such work shall contain a provision to this effect.

Section 34. "Every contract, except for the purchase of, material or supplies, involving the employment of laborers, workmen, mechanics, foremen, or inspectors, to which the commonwealth or any county or any town, subject to section thirty, is a party, shall contain a stipulation that no laborer, workman, mechanic, foreman or inspector working within the commonwealth, in the employ of the contractor, subcontractor or other person doing or contracting to do the whole or a part of the work contemplated by the contract, shall be required or permitted to work more than eight hours in any one day or more than 48 hours in any one week, or more than six days in any one week, except in cases of emergency, or in case any town subject to section thirty-one is a party to such a contract, more than eight hours in any one day, except as aforesaid..."

Section 34A. "Every contract for the construction, alteration, maintenance, repair or demolition of or addition to, any public building or other public works for the commonwealth or any political subdivision thereof shall contain stipulations requiring that the contractor shall, before commencing performance of such contract, provide by insurance for the payment of compensation and the furnishing of other benefits under chapter one hundred and fifty-two to all persons to be employed under the contract, and that the contractor shall continue such insurance in full force and effect during the term of the contract. No officer or agent contracting in behalf of the commonwealth or any political subdivision thereof shall award such a contract until he has been furnished with sufficient proof of compliance with the aforesaid stipulations. Failure to provide and continue in force such insurance as aforesaid shall be deemed a material breach of contract and shall operate as an immediate termination thereof. No cancellation of such insurance, whether by the insurer or by the insured, shall be valid unless written notice thereof is given by the party proposing cancellation to the other party and to the officer or agent who awarded the contract at least fifteen days prior to the intended effective date thereof, which date shall be expressed in said notice. Notice of cancellation sent by the party proposing receipt of the addressee requested, shall be a sufficient notice..."

Section 34B. "Every contract for the construction, alteration, maintenance, repair or demolition of, or addition to, any public works for the commonwealth or any political subdivision thereof shall contain stipulations requiring that the contractor shall pay to any reserve police officer employed by him in any city or town the prevailing rate of wage paid to regular police officers employed by him in such city or town."

Attention is directed to Chapter 774 of the Acts of 1972 amending Section 39F of Chapter 30 to read as follows:

Section 39F. "(1) Every contract awarded shall contain the following subparagraphs and in each case those subparagraphs shall be binding between the general contractor and each subcontractor.

(a) Forthwith after the general contractor receives payment on account of a periodic estimate, the general contractor shall pay to each subcontractor the amount paid for the labor performed and the materials furnished by that subcontractor, less any amount specified in any court proceedings barring such payment and also less any amount claimed due from the subcontractor by the general contractor.

(b) Not later than the sixty-fifth day after each subcontractor substantially completes his work in accordance with the plans and specifications, the entire balance due under the subcontract less amounts retained by the awarding authority as the estimated cost of completing the incomplete and unsatisfactory items of work, shall be due the subcontractor; and the awarding authority shall pay that amount to the general contractor. The general contractor shall forthwith pay to the subcontractor the full amount received from the awarding authority less any amount specified in any court proceedings barring such payment and also less any amount claimed due from the subcontractor by the general contractor.

(c) Each payment made by the awarding authority to the general contractor pursuant to sub-paragraphs (a) and (b) of this paragraph for the labor performed and the materials furnished by a subcontractor shall be made to the general contractor for the account of that subcontractor; and the awarding authority shall take reasonable steps to compel the general contractor to make each such payment to each such subcontractor. If the awarding authority has received a demand for direct payment from a subcontractor for any amount which has already been included in a payment to the general contractor for payment to the subcontractor as provided in subparagraphs (a) and (b), the awarding authority shall act upon the demand as provided in this section.

(d) If, within seventy days after the subcontractor has substantially completed the subcontractor work, the subcontractor has not received from the general contractor the balance due under the subcontract including any amount due for extra labor and materials furnished to the general contractor, less any amount retained by the awarding authority as the estimated cost of completing the incomplete and unsatisfactory items of work, the subcontractor may demand direct payment of that balance from the awarding authority. The demand shall be by a sworn statement delivered to or sent by certified mail to the awarding authority, and a copy shall be delivered to or sent by certified mail to the general contractor at the same time. The demand shall contain a detailed breakdown of the balance due under the subcontract and also a statement of the status of completion of the subcontract work. Any demand made after substantial completion of the subcontract work shall be valid even if delivered or mailed prior to the seventieth day after the subcontract work. Within ten days after the subcontractor has delivered or so mailed the demand to the awarding authority and delivered or so mailed a copy to the general contractor, the general contractor may reply to the demand. The reply shall be by a sworn statement delivered to or sent by certified mail to the awarding authority and a copy shall be delivered to or sent by certified mail to the subcontractor at the same time. The reply shall contain a detailed breakdown of the balance due under the subcontract including any amount due for extra labor and materials furnished to the general contractor and of the amount due for each claim made by the general contractor against the subcontractor.

(e) Within fifteen days after receipt of the demand by the awarding authority, but in no event prior to the seventieth day after substantial completion of the subcontract work, the awarding authority shall make direct payment to the subcontractor of the balance due under the subcontract including any amount due for extra and materials furnished to the general

contractor, less any amount (i) retained by the awarding authority as the estimated cost of completing the incomplete or unsatisfactory items of work, (ii) specified in any court proceedings barring such payment, or (iii) disputed by the general contractor in the sworn reply; provided, that the awarding authority shall not deduct from a direct payment any amount as provided in part (iii) if the reply is not sworn to, or for which the sworn reply does not contain the detailed breakdown required by subparagraph (d). The awarding authority shall make further direct payments to the Subcontractor forthwith after the removal of the basis for deductions from direct payments made as provided in parts (i) and (ii) of this subparagraph.

(f) The awarding authority shall forthwith deposit the amount deducted from a direct payment as provided in part (iii) of subparagraph (e) in an interest-bearing joint account in the names of the general contractor and the subcontractor in a bank in Massachusetts selected by the awarding authority or agreed upon by the general contractor and the subcontractor and shall notify the general contractor and the subcontractor of the date of the deposit and the bank receiving the deposit. The bank shall pay the amount in the account, including accrued interest, as provided in an agreement between the general contractor and the subcontractor or as determined by decree of a court of competent jurisdiction.

(g) All direct payments and all deductions from demands for direct payments deposited in an interest-bearing account or accounts in a bank pursuant to subparagraph (f) shall be made out of amounts payable to the general contractor at the time of receipt of a demand for direct payment for a subcontractor and out of amounts which later become payable to the general contractor and in the order of receipt of such demands from subcontractors. All direct payments shall discharge the obligation of the awarding authority to the general contractor to the extent of such payment.

(h) The awarding authority shall deduct from payments to a general contractor amounts which, together with the deposits in interest-bearing accounts pursuant to subparagraph (f), are sufficient to satisfy all unpaid balances of demands for direct payment received from subcontractors. All such amounts shall be earmarked for such direct payments, and the subcontractors shall have a right in such deductions prior to any claims against such amounts by creditors of the general contractor."

Attention is also directed to Chapter 774 of the Acts of 1972 further amending Chapter 30 by adding after Section 39M the following section:

Section 39M. (b) Specifications for such contracts, and specification for contracts awarded pursuant to the provisions of said sections forty-four A to forty-four L of said chapter one hundred and forty-nine, shall be written to provide for full competition for each item of material to be furnished under the contract; except, however, that said specifications may be otherwise written for sound reasons in the public interest stated in writing in the public records of the awarding authority or promptly given in writing by the awarding authority to anyone making a written request therefore, in either instance such writing to be prepared after reasonable investigation. Every such contract shall provide that an item equal to that

named or described in the said specifications may be furnished; and an item shall be considered equal to the item so named or described if (1) it is at least equal in quality, durability, appearance, strength and design, (2) it will perform at least equally the function imposed by the general design for the public work being contracted for or the material being purchased, and (3) it conforms substantially, even with deviations, to the detailed requirements for the item in the said specifications. For each item of material the specifications shall provide for either a minimum of three named brands of material or a description of material which can be met by a minimum of three manufacturers or producers, and for the equal of any one of said named or described materials.

Section 39N. "Every contract subject to section forty-four A of chapter one hundred forty-nine or subject to section thirty-nine M of chapter thirty shall contain the following paragraph in its entirety and an awarding authority may adopt reasonable rules or regulations in conformity with that paragraph concerning the filing, investigation and settlement of such claims:

If, during the progress of the work, the contractor or the awarding authority discovers that the actual subsurface or latent physical conditions encountered at the site differ substantially or materially from those shown on the plans or indicated in the contract documents either the contractor or the contracting authority may request an equitable adjustment in the contract price of the contract applying to work affected by the differing site conditions. A request for such an adjustment shall be in writing and shall be delivered by the party making such claim to the other party as soon as possible after such conditions are discovered. Upon receipt of such a claim from a contractor, or upon its own initiative, the contracting authority shall make an investigation of such physical conditions, and, if they differ substantially or materially from those shown on the plans or indicated in the contract documents or from those ordinarily encountered and generally recognized as inherent in work of the character provided for in the plans and contract documents are of such a nature as to cause an increase or decrease in the cost of performance of the work or a change in the construction methods required for the performance of the work which results in an increase or decrease in the cost of the work, the contracting authority shall make an equitable adjustment in the contract price and the contract shall be modified in writing accordingly."

Attention is also directed to Chapter 1164 of the Acts of 1973 further amending Chapter 30 by adding after Section 39N the following two sections:

Section 39O. "Every contract subject to the provisions of section thirty-nine M of this chapter or subject to section forty-four A of chapter one hundred forty-nine shall contain the following provisions (a) and (b) in their entirety...

(a) The awarding authority may order the general contractor in writing to suspend, delay, or interrupt all or any part of the work for such period of time as it may determine to be appropriate for the convenience of the awarding authority; provided however, that if there is a suspension, delay or interruption for fifteen days or more due to a failure of the awarding authority shall make an adjustment in the contract but shall not include any profit

to the general contractor on such increase; and provide further, that the awarding authority shall not make any adjustment in the contract price under this provision for any suspension, delay, interruption or failure to act to the extent that such is due to any cause for which this contract provides for an equitable adjustment of the contract price under any other contract provisions.

(b) The general contractor must submit the amount of a claim under provision (a) to the awarding authority in writing as soon as practicable after the end of the suspension, delay, interruption or failure to act and, in any event, not later than the date of final payment under this contract and, except for costs due to a suspension order, the awarding authority shall not approve any costs in the claim incurred more than 20 days before the general contractor notified the awarding authority of the act or failure to act involved in the claim."

Section 39P. "Every contract subject to section thirty-nine M of this chapter or section forty-four A of chapter one hundred forty-nine which requires the awarding authority, any official, its architect or engineer to make a decision on interpretation of the specifications, approval of equipment, material or any other approval, or progress of the work, shall require that the decision be made promptly and, in any event no later than thirty days after the written submission for decision; but if such decision required extended investigation and study, the awarding authority, the official, architect or engineer shall, within thirty days after the receipt of the submission, give the party making the submission written notice of the reasons why the decision cannot be made within the thirty day period and the date by which the decision will be made."

Attention is also directed to Chapter 30, Section 39R of the General Laws of Massachusetts as amended to date as follows:

Section 39R. (a) The words defined herein shall have the meaning stated below whenever they appear in this section:

(1) "Contractor" means any person, corporation, partnership, joint venture, sole proprietorship, or other entity awarded a contract pursuant to section thirty-nine M of chapter thirty, sections forty-four A through forty-four H, inclusive, of chapter one hundred forty-nine and sections thirty B through thirty P, inclusive, of chapter seven.

(2) "Contract" means any contract awarded or executed pursuant to sections thirty B through thirty P, inclusive, of chapter seven and any contract awarded or executed pursuant to section thirty-nine M of chapter thirty, or sections forty-four A through forty-four H, inclusive, of chapter one hundred forty-nine, which is for an amount or estimated amount greater than one hundred thousand dollars.

(3) "Records" means books of original entry, accounts, checks, bank statements and all other banking documents, correspondence, memorandum invoices, computer printouts, tapes, discs, papers and other documents transcribed information of any type, whether expressed in ordinary or machine language.

(4) "Independent Certified Public Accountant" means a person duly registered in good standing and entitled to practice as a certified public accountant under the laws of the place of his/her residence or principal office and who is in fact independent. In determining whether an accountant is independent with respect to a particular person, appropriate consideration should be given to all relationships between the accountant and that person or any affiliate thereof. Determination of an accountant's independence shall not be confined to the relationships existing in connection with the filing of reports with the awarding authority.

(5) "Audit", when used in regard to financial statements, means an examination of records by an independent certified public accountant in accordance with generally accepted accounting principles and auditing standards for the purpose of expressing a certified opinion thereon, or, in the alternative, a qualified opinion or a delineation to express an opinion for stated reasons.

(6) "Accountant's Report", when used in regard to financial statements, means a document in which an independent certified public accountant indicates the scope of the audit which she/he has made and sets forth his/her opinion regarding the financial statements taken as a whole with a listing of noted exceptions and qualifications, or an assertion to the effect that an overall opinion cannot be expressed. When an overall opinion cannot be expressed the reason therefor shall be stated. An accountant's report shall include as a part thereof a signed statement by the responsible corporate officer attesting that management has fully disclosed all material facts to the independent certified public accountant, and that the audited financial statement is a true and complete statement of a financial condition of the contractor.

(7) "Management", when used herein, means the chief executive officers, partners, principals or other person or persons primarily responsible for the financial and operational policies and practices of the contractor.

(8) Accounting terms, unless otherwise defined herein, shall have a meaning in accordance with generally accepted accounting principals and auditing standards.

(b) Subsection (a) (2) hereof notwithstanding, every agreement or contract awarded or executed pursuant to sections 30B through 30P, inclusive, of chapter seven, and pursuant to section 39M of chapter 30 or to section 44A through 44H, inclusive, of chapter 149, shall provide that:

(1) The contractor shall make, and keep for at least six years after final payment, books, records, and accounts which in reasonable detail accurately and fairly reflect the transactions and dispositions of the contractor, and

(2) until the expiration of six years after final payment, the awarding authority, office of inspector general, and the deputy commissioner of capital planning and operations shall have the right to examine any books, documents, papers or records of the contractor or of

his/her subcontractors that directly pertain to, and involve transactions relating to, the contractor or his/her subcontractors, and

(3) if the agreement is a contract as defined herein, the contractor shall describe any change in the method of maintaining records or recording transactions which materially affect any statements filed with the awarding authority, including in his/her description the date of the change and reasons therefore, and shall accompany said description with a letter from the contractor's independent certified public accountant approving or otherwise commenting on the changes, and

(4) if the agreement is a contract as defined herein, the contractor has filed a statement of management on internal accounting controls as set forth in paragraph (c) below prior to the execution of the contract, and

(5) if the agreement is a contract as defined herein, the contractor has filed prior to the execution of the contracts and will continue to file annually, an audited financial statement for the most recent completed fiscal year as set forth in paragraph (d) below.

(c) Every contractor awarded a contract shall file with the awarding authority a statement of management as to whether the system of internal accounting controls of the contractor and its subsidiaries reasonably assures that:

(1) transactions are executed in accordance with management's general and specific authorization;

(2) transactions are recorded as necessary:

i. to permit preparation of financial statements in conformity with generally accepted accounting principles, and

ii. To maintain accountability for assets;

(3) access to assets is permitted only in accordance with management's general or specific authorization; and

(4) the recorded accountability for assets is compared with the existing assets at reasonable intervals and appropriate action was taken with respect to any difference.

Every contractor awarded a contract shall also file with the awarding authority a statement prepared and signed by an independent certified public accountant, stating that she/he has examined the statement of management on internal accounting controls, and expressing an opinion as to

(1) whether the representations of management in response to this paragraph and paragraph (b) above are consistent with the result of management's evaluation of the system of internal accounting controls; and

(2) whether such representations of management are, in addition, reasonable with respect to transactions and assets in amounts which would be material when measured in relation to the applicant's financial statements.

(d) Every contractor awarded a contract by the commonwealth or by any political subdivision thereof shall annually file with the awarding authority during the term of the contract a financial statement prepared by an independent certified public accountant on

the basis of an audit by sub accountant. The final statement filed shall include the date of final payment. All statements shall be accompanied by an accountant's report.

(e) The office of inspector general, the deputy commissioner for capital planning and operations and any other awarding authority shall enforce the provisions of this section. The deputy commissioner of capital planning and operations may after providing an opportunity for the inspector general and other interested parties to comment, promulgate pursuant to the provisions of chapter thirty A such rules, regulations and guidelines as are necessary to effectuate the purposes of this section. Such rules, regulations and guidelines may be applicable to all awarding authorities. A contractor's failure to satisfy any of the requirements of this section may be grounds for disqualification pursuant to section forty-four C of Chapter one hundred forty-nine.

1.04 MINIMUM WAGE RATES

- A. Minimum Wage Rates as determined by the Commissioner of Department of Labor and Industries under the provision of the Massachusetts General Laws, Chapter 149, Sections 26 to 27D, as amended, apply to this project. It is the responsibility of the contractor, before bid opening, to request if necessary, any additional information of Minimum Wage Rates for those trades-people who may be employed for the proposed work under this contract. Minimum wage rates are included at the end of this section.
- B. Minimum Wage Rates as determined by the United States Department of Labor under the Davis-Bacon Act also apply to this project.

1.05 SAFETY AND HEALTH

- A. This project is subject to the Safety and Health regulation of the U.S. Department of Labor set forth in 29 CFR Part 1926, Commonwealth of Massachusetts Regulations CMR 454, and to the Massachusetts Department of Labor and Industries, Division of Industrial Safety "Rules and Regulations for the Prevention of Accidents in Construction operations (Chapter 454 CMR 10.00 et. seq.)". Contractors shall be familiar with the requirements of these regulations.

1.06 MODIFIED SUPPLEMENTAL EQUAL EMPLOYMENT OPPORTUNITY NON-DISCRIMINATION AND AFFIRMATIVE ACTION PROGRAM

- A. See Attached pages EEO-AAO-MS Page 1 through EEO-AAO-MS Page 7.

1.07 SPECIAL PROVISIONS FOR DISADVANTAGED BUSINESS ENTERPRISES

- A. See Attached pages EEO-DEP-SP Page 1 through EEO-DEP-SP Page 9 AND EEO-DEP Forms.

1.08 STATUTES REGULATING CONSTRUCTION CONTRACTS FOR PUBLIC BUILDINGS AND PUBLIC WORKS PROJECTS

- A. The following statutes regulating construction contracts for public buildings and public works projects are incorporated into the specifications. Where indicated, statutory references are included as attachments.

1. M.G.L c.30 s 39F Payment to Subcontractor (attached)
2. M.G.L c.30 s 39I Deviation from Plans and Specifications
3. M.G.L c.30 s 39J No Arbitrary Decisions are Final
4. M.G.L c.30 s 39L Construction Work by Foreign Corporations
5. M.G.L c.30 s 39M(b) Substitution of Equal Products
6. M.G.L c.30 s 39N Differing Site Conditions (attached)
7. M.G.L c.30 s 39O Equitable Adjustments for Delays (attached)
8. M.G.L c.30 s 39P Decision on Interpretation of Specifications
9. M.G.L c.30 s 39R Contractor's Records
10. M.G.L c.149 s 34 Limitations on Hours of Work
11. M.G.L c.149 s 44J Advertising Invitations to Bid
12. M.G.L c.82 s 40 Excavations; Notice; Penalties
13. M.G.L c.30 s 39K Prompt Payment
14. M.G.L c.149 ss44F and 44G

END OF SECTION

ATTACHMENT A

Excerpts from the Massachusetts General Laws

**GENERAL LAWS OF MASSACHUSETTS
PART I.
ADMINISTRATION OF THE GOVERNMENT.**

**TITLE III.
LAWS RELATING TO STATE OFFICERS.**

CHAPTER 30. GENERAL PROVISIONS RELATIVE TO STATE DEPARTMENTS, COMMISSIONS, OFFICERS AND EMPLOYEES.

Chapter 30: Section 39F. Construction contracts; assignment and subrogation; subcontractor defined; enforcement of claim for direct payment; deposit, reduction of disputed amounts.

Section 39F. (1) Every contract awarded pursuant to sections forty-four A to L, inclusive, of chapter one hundred and forty-nine shall contain the following subparagraphs (a) through (i) and every contract awarded pursuant to section thirty-nine M of chapter thirty shall contain the following subparagraphs (a) through (h) and in each case those subparagraphs shall be binding between the general contractor and each subcontractor.

(a) Forthwith after the general contractor receives payment on account of a periodic estimate, the general contractor shall pay to each subcontractor the amount paid for the labor performed and the materials furnished by that subcontractor, less any amount specified in any court proceedings barring such payment and also less any amount claimed due from the subcontractor by the general contractor.

(b) Not later than the sixty-fifth day after each subcontractor substantially completes his work in accordance with the plans and specifications, the entire balance due under the subcontract less amounts retained by the awarding authority as the estimated cost of completing the incomplete and unsatisfactory items of work, shall be due the subcontractor; and the awarding authority shall pay that amount to the general contractor. The general contractor shall forthwith pay to the subcontractor the full amount received from the awarding authority less any amount specified in any court proceedings barring such payment and also less any amount claimed due from the subcontractor by the general contractor.

(c) Each payment made by the awarding authority to the general contractor pursuant to subparagraphs (a) and (b) of this paragraph for the labor performed and the materials furnished by a subcontractor shall be made to the general contractor for the account of that subcontractor; and the awarding authority shall take reasonable steps to compel the general contractor to make each such payment to each such subcontractor. If the awarding authority has received a demand for direct payment from a subcontractor for any amount which has already been included in a payment to the general contractor or which is to be included in a payment to the general contractor for payment to the subcontractor as provided in subparagraphs (a) and (b), the awarding authority shall act upon the demand as provided in this section.

(d) If, within seventy days after the subcontractor has substantially completed the subcontract work, the subcontractor has not received from the general contractor the balance due under the subcontract including any amount due for extra labor and materials furnished to the general contractor, less any amount retained by the awarding authority as the estimated cost of completing the incomplete and unsatisfactory items of work, the subcontractor may demand direct payment of that balance from the awarding authority.

The demand shall be by a sworn statement delivered to or sent by certified mail to the awarding authority, and a copy shall be delivered to or sent by certified mail to the general contractor at the same time. The demand shall contain a detailed breakdown of the balance due under the subcontract and also a statement of the status of completion of the subcontract work. Any demand made after substantial completion of the subcontract work shall be valid even if delivered or mailed prior to the seventieth day after the subcontractor has substantially completed the subcontract work. Within ten days after the subcontractor has delivered or so mailed the demand to the awarding authority and delivered or so mailed a copy to the general contractor, the general contractor may reply to the demand. The reply shall be by a sworn statement delivered to or sent by certified mail to the awarding authority and a copy shall be delivered to or sent by certified mail to the subcontractor at the same time. The reply shall contain a detailed breakdown of the balance due under the subcontract including any amount due for extra labor and materials furnished to the general contractor and of the amount due for each claim made by the general contractor against the subcontractor.

(e) Within fifteen days after receipt of the demand by the awarding authority, but in no event prior to the seventieth day after substantial completion of the subcontract work, the awarding authority shall make direct payment to the subcontractor of the balance due under the subcontract including any amount due for extra labor and materials furnished to the general contractor, less any amount (i) retained by the awarding authority as the estimated cost of completing the incomplete or unsatisfactory items of work, (ii) specified in any court proceedings barring such payment, or (iii) disputed by the general contractor in the sworn reply; provided, that the awarding authority shall not deduct from a direct payment any amount as provided in part (iii) if the reply is not sworn to, or for which the sworn reply does not contain the detailed breakdown required by subparagraph (d). The awarding authority shall make further direct payments to the subcontractor forthwith after the removal of the basis for deductions from direct payments made as provided in parts (i) and (ii) of this subparagraph.

(f) The awarding authority shall forthwith deposit the amount deducted from a direct payment as provided in part (iii) of subparagraph (e) in an interest-bearing joint account in the names of the general contractor and the subcontractor in a bank in Massachusetts selected by the awarding authority or agreed upon by the general contractor and the subcontractor and shall notify the general contractor and the subcontractor of the date of the deposit and the bank receiving the deposit. The bank shall pay the amount in the account, including accrued interest, as provided in an agreement between the general contractor and the subcontractor or as determined by decree of a court of competent jurisdiction.

(g) All direct payments and all deductions from demands for direct payments deposited in an interest-bearing account or accounts in a bank pursuant to subparagraph (f) shall be made out of amounts payable to the general contractor at the time of receipt of a demand for direct payment from a subcontractor and out of amounts which later become payable to the general contractor and in the order of receipt of such demands from subcontractors. All direct payments shall discharge the obligation of the awarding authority to the general contractor to the extent of such payment.

(h) The awarding authority shall deduct from payments to a general contractor amounts which, together with the deposits in interest-bearing accounts pursuant to subparagraph (f),

are sufficient to satisfy all unpaid balances of demands for direct payment received from subcontractors. All such amounts shall be earmarked for such direct payments, and the subcontractors shall have a right in such deductions prior to any claims against such amounts by creditors of the general contractor.

(i) If the subcontractor does not receive payment as provided in subparagraph (a) or if the general contractor does not submit a periodic estimate for the value of the labor or materials performed or furnished by the subcontractor and the subcontractor does not receive payment for same when due less the deductions provided for in subparagraph (a), the subcontractor may demand direct payment by following the procedure in subparagraph (d) and the general contractor may file a sworn reply as provided in that same subparagraph. A demand made after the first day of the month following that for which the subcontractor performed or furnished the labor and materials for which the subcontractor seeks payment shall be valid even if delivered or mailed prior to the time payment was due on a periodic estimate from the general contractor. Thereafter the awarding authority shall proceed as provided in subparagraph (e), (f), (g) and (h).

(2) Any assignment by a subcontractor of the rights under this section to a surety company furnishing a bond under the provisions of section twenty-nine of chapter one hundred forty-nine shall be invalid. The assignment and subrogation rights of the surety to amounts included in a demand for direct payment which are in the possession of the awarding authority or which are on deposit pursuant to subparagraph (f) of paragraph (1) shall be subordinate to the rights of all subcontractors who are entitled to be paid under this section and who have not been paid in full.

(3) ""Subcontractor" as used in this section (i) for contracts awarded as provided in sections forty-four A to forty-four H, inclusive, of chapter one hundred forty-nine shall mean a person who files a sub-bid and receives a subcontract as a result of that filed sub-bid or who is approved by the awarding authority in writing as a person performing labor or both performing labor and furnishing materials pursuant to a contract with the general contractor, (ii) for contracts awarded as provided in paragraph (a) of section thirty-nine M of chapter thirty shall mean a person approved by the awarding authority in writing as a person performing labor or both performing labor and furnishing materials pursuant to a contract with the general contractor, and (iii) for contracts with the commonwealth not awarded as provided in forty-four A to forty-four H, inclusive, of chapter one hundred forty-nine shall also mean a person contracting with the general contractor to supply materials used or employed in a public works project for a price in excess of five thousand dollars.

(4) A general contractor or a subcontractor shall enforce a claim to any portion of the amount of a demand for direct payment deposited as provided in subparagraph (f) of paragraph 1 by a petition in equity in the superior court against the other and the bank shall not be a necessary party. A subcontractor shall enforce a claim for direct payment or a right to require a deposit as provided in subparagraph (f) of paragraph 1 by a petition in equity in the superior court against the awarding authority and the general contractor shall not be a necessary party. Upon motion of any party the court shall advance for speedy trial any petition filed as provided in this paragraph. Sections fifty-nine and fifty-nine B of chapter two hundred thirty-one shall apply to such petitions. The court shall enter an interlocutory decree upon which execution shall issue for any part of a claim found due pursuant to sections fifty-nine and fifty-nine B and, upon motion of any party, shall advance for speedy

trial the petition to collect the remainder of the claim. Any party aggrieved by such interlocutory decree shall have the right to appeal therefrom as from a final decree. The court shall not consolidate for trial the petition of any subcontractor with the petition of one or more subcontractors or the same general contract unless the court finds that a substantial portion of the evidence of the same events during the course of construction (other than the fact that the claims sought to be consolidated arise under the same general contract) is applicable to the petitions sought to be consolidated and that such consolidation will prevent unnecessary duplication of evidence. A decree in any such proceeding shall not include interest on the disputed amount deposited in excess of the interest earned for the period of any such deposit. No person except a subcontractor filing a demand for direct payment for which no funds due the general contractor are available for direct payment shall have a right to file a petition in court of equity against the awarding authority claiming a demand for direct payment is premature and such subcontractor must file the petition before the awarding authority has made a direct payment to the subcontractor and has made a deposit of the disputed portion as provided in part (iii) of subparagraph (e) and in subparagraph (f) of paragraph (1).

(5) In any petition to collect any claim for which a subcontractor has filed a demand for direct payment the court shall, upon motion of the general contractor, reduce by the amount of any deposit of a disputed amount by the awarding authority as provided in part (iii) of subparagraph (e) and in subparagraph (f) of paragraph (1) any amount held under a trustee writ or pursuant to a restraining order or injunction.

**GENERAL LAWS OF MASSACHUSETTS
PART I.
ADMINISTRATION OF THE GOVERNMENT.**

**TITLE III.
LAWS RELATING TO STATE OFFICERS.**

CHAPTER 30. GENERAL PROVISIONS RELATIVE TO STATE DEPARTMENTS, COMMISSIONS, OFFICERS AND EMPLOYEES.

Chapter 30: Section 39N. Construction contracts; equitable adjustment in contract price for differing subsurface or latent physical conditions.

Section 39N. Every contract subject to section forty-four A of chapter one hundred and forty-nine or subject to section thirty-nine M of chapter thirty shall contain the following paragraph in its entirety and an awarding authority may adopt reasonable rules or regulations in conformity with that paragraph concerning the filing, investigation and settlement of such claims:

If, during the progress of the work, the contractor or the awarding authority discovers that the actual subsurface or latent physical conditions encountered at the site differ substantially or materially from those shown on the plans or indicated in the contract documents either the contractor or the contracting authority may request an equitable adjustment in the contract price of the contract applying to work affected by the differing site conditions. A request for such an adjustment shall be in writing and shall be delivered by the party making such claim to the other party as soon as possible after such conditions are discovered. Upon receipt of such a claim from a contractor, or upon its own initiative, the contracting authority shall make an investigation of such physical conditions, and, if they differ substantially or materially from those shown on the plans or indicated in the contract documents or from those ordinarily encountered and generally recognized as inherent in work of the character provided for in the plans and contract documents and are of such a nature as to cause an increase or decrease in the cost of performance of the work or a change in the construction methods required for the performance of the work which results in an increase or decrease in the cost of the work, the contracting authority shall make an equitable adjustment in the contract price and the contract shall be modified in writing accordingly.

**GENERAL LAWS OF MASSACHUSETTS
PART I.
ADMINISTRATION OF THE GOVERNMENT.**

**TITLE III.
LAWS RELATING TO STATE OFFICERS.**

CHAPTER 30. GENERAL PROVISIONS RELATIVE TO STATE DEPARTMENTS, COMMISSIONS, OFFICERS AND EMPLOYEES.

Chapter 30: Section 39O. Contracts for construction and materials; suspension, delay or interruption due to order of awarding authority; adjustment in contract price; required provisions.

Section 39O. Every contract subject to the provisions of section thirty-nine M of this chapter or subject to section forty-four A of chapter one hundred forty-nine shall contain the following provisions (a) and (b) in their entirety and, in the event a suspension, delay, interruption or failure to act of the awarding authority increases the cost of performance to any subcontractor, that subcontractor shall have the same rights against the general contractor for payment for an increase in the cost of his performance as provisions (a) and (b) give the general contractor against the awarding authority, but nothing in provisions (a) and (b) shall in any way change, modify or alter any other rights which the general contractor or the subcontractor may have against each other.

(a) The awarding authority may order the general contractor in writing to suspend, delay, or interrupt all or any part of the work for such period of time as it may determine to be appropriate for the convenience of the awarding authority; provided however, that if there is a suspension, delay or interruption for fifteen days or more or due to a failure of the awarding authority to act within the time specified in this contract, the awarding authority shall make an adjustment in the contract price for any increase in the cost of performance of this contract but shall not include any profit to the general contractor on such increase; and provided further, that the awarding authority shall not make any adjustment in the contract price under this provision for any suspension, delay, interruption or failure to act to the extent that such is due to any cause for which this contract provides for an equitable adjustment of the contract price under any other contract provisions.

(b) The general contractor must submit the amount of a claim under provision (a) to the awarding authority in writing as soon as practicable after the end of the suspension, delay, interruption or failure to act and, in any event, not later than the date of final payment under this contract and, except for costs due to a suspension order, the awarding authority shall not approve any costs in the claim incurred more than twenty days before the general contractor notified the awarding authority in writing of the act or failure to act involved in the claim.

ATTACHMENT B

Massachusetts Prevailing Wage Rates

And

Federal Davis-Bacon Wage Rates

(THIS PAGE INTENTIONALLY LEFT BLANK)



**THE COMMONWEALTH OF MASSACHUSETTS
EXECUTIVE OFFICE OF LABOR AND WORKFORCE DEVELOPMENT
DEPARTMENT OF LABOR STANDARDS**

Prevailing Wage Rates

**As determined by the Director under the provisions of the
Massachusetts General Laws, Chapter 149, Sections 26 to 27H**

CHARLES D. BAKER
Governor

KARYN E. POLITO
Lt. Governor

ROSALIN ACOSTA
Secretary
MICHAEL FLANAGAN
Director

Awarding Authority: City of Taunton DPW
Contract Number: S-2020-2 **City/Town:** TAUNTON
Description of Work: Improvements to the Taunton Main Lift Pump Station

Job Location: 690 West Water Street, Taunton, MA

Information about Prevailing Wage Schedules for Awarding Authorities and Contractors

- This wage schedule applies only to the specific project referenced at the top of this page and uniquely identified by the “Wage Request Number” on all pages of this schedule.
- An Awarding Authority must request an updated wage schedule from the Department of Labor Standards (“DLS”) if it has not opened bids or selected a contractor within 90 days of the date of issuance of the wage schedule. For CM AT RISK projects (bid pursuant to G.L. c.149A), the earlier of: (a) the execution date of the GMP Amendment, or (b) the bid for the first construction scope of work must be within 90-days of the wage schedule issuance date.
- The wage schedule shall be incorporated in any advertisement or call for bids for the project as required by M.G.L. c. 149, § 27. The wage schedule shall be made a part of the contract awarded for the project. The wage schedule must be posted in a conspicuous place at the work site for the life of the project in accordance with M.G.L. c. 149 § 27. The wages listed on the wage schedule must be paid to employees performing construction work on the project whether they are employed by the prime contractor, a filed sub-bidder, or any sub-contractor.
- All apprentices working on the project are required to be registered with the Massachusetts Department of Labor Standards, Division of Apprentice Standards (DLS/DAS). Apprentice must keep his/her apprentice identification card on his/her person during all work hours on the project. An apprentice registered with DAS may be paid the lower apprentice wage rate at the applicable step as provided on the prevailing wage schedule. **Any apprentice not registered with DLS/DAS regardless of whether or not they are registered with any other federal, state, local, or private agency must be paid the journeyworker's rate for the trade.**
- The wage rates will remain in effect for the duration of the project, except in the case of multi-year public construction projects. For construction projects lasting longer than one year, awarding authorities must request an updated wage schedule. Awarding authorities are required to request these updates no later than two weeks before the anniversary of the date the contract was executed by the awarding authority and the general contractor. For multi-year CM AT RISK projects, awarding authority must request an annual update no later than two weeks before the anniversary date, determined as the earlier of: (a) the execution date of the GMP Amendment, or (b) the execution date of the first amendment to permit procurement of construction services. Contractors are required to obtain the wage schedules from awarding authorities, and to pay no less than these rates to covered workers. The annual update requirement is not applicable to 27F “rental of equipment” contracts.
- Every contractor or subcontractor which performs construction work on the project is required to submit weekly payroll reports and a Statement of Compliance directly to the awarding authority by mail or email and keep them on file for three years. Each weekly payroll report must contain: the employee’s name, address, occupational classification, hours worked, and wages paid. Do not submit weekly payroll reports to DLS. A sample of a payroll reporting form may be obtained at <http://www.mass.gov/dols/pw>.
- Contractors with questions about the wage rates or classifications included on the wage schedule have an affirmative obligation to inquire with DLS at (617) 626-6953.
- Employees not receiving the prevailing wage rate set forth on the wage schedule may report the violation to the Fair Labor Division of the office of the Attorney General at (617) 727-3465.
- Failure of a contractor or subcontractor to pay the prevailing wage rates listed on the wage schedule to all employees who perform construction work on the project is a violation of the law and subjects the contractor or subcontractor to civil and criminal penalties.

Classification	Effective Date	Base Wage	Health	Pension	Supplemental Unemployment	Total Rate
Construction						
(2 AXLE) DRIVER - EQUIPMENT <i>TEAMSTERS JOINT COUNCIL NO. 10 ZONE B</i>	08/01/2021	\$35.95	\$13.41	\$14.82	\$0.00	\$64.18
	12/01/2021	\$35.95	\$13.41	\$16.01	\$0.00	\$65.37
(3 AXLE) DRIVER - EQUIPMENT <i>TEAMSTERS JOINT COUNCIL NO. 10 ZONE B</i>	08/01/2021	\$36.02	\$13.41	\$14.82	\$0.00	\$64.25
	12/01/2021	\$36.02	\$13.41	\$16.01	\$0.00	\$65.44
(4 & 5 AXLE) DRIVER - EQUIPMENT <i>TEAMSTERS JOINT COUNCIL NO. 10 ZONE B</i>	08/01/2021	\$36.14	\$13.41	\$14.82	\$0.00	\$64.37
	12/01/2021	\$36.14	\$13.41	\$16.01	\$0.00	\$65.56
ADS/SUBMERSIBLE PILOT <i>PILE DRIVER LOCAL 56 (ZONE 1)</i>	08/01/2020	\$103.05	\$9.40	\$23.12	\$0.00	\$135.57
For apprentice rates see "Apprentice- PILE DRIVER"						
AIR TRACK OPERATOR <i>LABORERS - ZONE 2</i>	06/01/2021	\$35.75	\$8.60	\$16.64	\$0.00	\$60.99
	12/01/2021	\$36.66	\$8.60	\$16.64	\$0.00	\$61.90
	06/01/2022	\$37.56	\$8.60	\$16.64	\$0.00	\$62.80
	12/01/2022	\$38.41	\$8.60	\$16.64	\$0.00	\$63.65
	06/01/2023	\$39.31	\$8.60	\$16.64	\$0.00	\$64.55
	12/01/2023	\$40.21	\$8.60	\$16.64	\$0.00	\$65.45
For apprentice rates see "Apprentice- LABORER"						
AIR TRACK OPERATOR (HEAVY & HIGHWAY) <i>LABORERS - ZONE 2 (HEAVY & HIGHWAY)</i>	06/01/2021	\$35.75	\$8.60	\$16.64	\$0.00	\$60.99
	12/01/2021	\$36.66	\$8.60	\$16.64	\$0.00	\$61.90
For apprentice rates see "Apprentice- LABORER (Heavy and Highway)"						
ASBESTOS WORKER (PIPES & TANKS) <i>HEAT & FROST INSULATORS LOCAL 6 (SOUTHERN MASS)</i>	12/01/2020	\$38.10	\$12.80	\$9.45	\$0.00	\$60.35
ASPHALT RAKER <i>LABORERS - ZONE 2</i>	06/01/2021	\$35.25	\$8.60	\$16.64	\$0.00	\$60.49
	12/01/2021	\$36.16	\$8.60	\$16.64	\$0.00	\$61.40
	06/01/2022	\$37.06	\$8.60	\$16.64	\$0.00	\$62.30
	12/01/2022	\$37.91	\$8.60	\$16.64	\$0.00	\$63.15
	06/01/2023	\$38.81	\$8.60	\$16.64	\$0.00	\$64.05
	12/01/2023	\$39.71	\$8.60	\$16.64	\$0.00	\$64.95
For apprentice rates see "Apprentice- LABORER"						
ASPHALT RAKER (HEAVY & HIGHWAY) <i>LABORERS - ZONE 2 (HEAVY & HIGHWAY)</i>	06/01/2021	\$35.25	\$8.60	\$16.64	\$0.00	\$60.49
	12/01/2021	\$36.16	\$8.60	\$16.64	\$0.00	\$61.40
For apprentice rates see "Apprentice- LABORER (Heavy and Highway)"						
ASPHALT/CONCRETE/CRUSHER PLANT-ON SITE <i>OPERATING ENGINEERS LOCAL 4</i>	06/01/2021	\$50.73	\$13.75	\$15.80	\$0.00	\$80.28
	12/01/2021	\$51.88	\$13.75	\$15.80	\$0.00	\$81.43
For apprentice rates see "Apprentice- OPERATING ENGINEERS"						
BACKHOE/FRONT-END LOADER <i>OPERATING ENGINEERS LOCAL 4</i>	06/01/2021	\$50.73	\$13.75	\$15.80	\$0.00	\$80.28
	12/01/2021	\$51.88	\$13.75	\$15.80	\$0.00	\$81.43
For apprentice rates see "Apprentice- OPERATING ENGINEERS"						
BARCO-TYPE JUMPING TAMPER <i>LABORERS - ZONE 2</i>	06/01/2021	\$35.25	\$8.60	\$16.64	\$0.00	\$60.49
	12/01/2021	\$36.16	\$8.60	\$16.64	\$0.00	\$61.40
	06/01/2022	\$37.06	\$8.60	\$16.64	\$0.00	\$62.30
	12/01/2022	\$37.91	\$8.60	\$16.64	\$0.00	\$63.15
	06/01/2023	\$38.81	\$8.60	\$16.64	\$0.00	\$64.05
	12/01/2023	\$39.71	\$8.60	\$16.64	\$0.00	\$64.95
For apprentice rates see "Apprentice- LABORER"						

Classification	Effective Date	Base Wage	Health	Pension	Supplemental Unemployment	Total Rate
BLOCK PAVER, RAMMER / CURB SETTER <i>LABORERS - ZONE 2</i>	06/01/2021	\$35.75	\$8.60	\$16.64	\$0.00	\$60.99
	12/01/2021	\$36.66	\$8.60	\$16.64	\$0.00	\$61.90
	06/01/2022	\$37.56	\$8.60	\$16.64	\$0.00	\$62.80
	12/01/2022	\$38.41	\$8.60	\$16.64	\$0.00	\$63.65
	06/01/2023	\$39.31	\$8.60	\$16.64	\$0.00	\$64.55
	12/01/2023	\$40.21	\$8.60	\$16.64	\$0.00	\$65.45
For apprentice rates see "Apprentice- LABORER"						
BLOCK PAVER, RAMMER / CURB SETTER (HEAVY & HIGHWAY) <i>LABORERS - ZONE 2 (HEAVY & HIGHWAY)</i>	06/01/2021	\$35.75	\$8.60	\$16.64	\$0.00	\$60.99
	12/01/2021	\$36.66	\$8.60	\$16.64	\$0.00	\$61.90
For apprentice rates see "Apprentice- LABORER (Heavy and Highway)"						
BOILER MAKER <i>BOILERMAKERS LOCAL 29</i>	01/01/2020	\$46.10	\$7.07	\$17.98	\$0.00	\$71.15

Apprentice - BOILERMAKER - Local 29

Effective Date - 01/01/2020

Step	percent	Apprentice Base Wage	Health	Pension	Supplemental Unemployment	Total Rate
1	65	\$29.97	\$7.07	\$11.69	\$0.00	\$48.73
2	65	\$29.97	\$7.07	\$11.69	\$0.00	\$48.73
3	70	\$32.27	\$7.07	\$12.59	\$0.00	\$51.93
4	75	\$34.58	\$7.07	\$13.49	\$0.00	\$55.14
5	80	\$36.88	\$7.07	\$14.38	\$0.00	\$58.33
6	85	\$39.19	\$7.07	\$15.29	\$0.00	\$61.55
7	90	\$41.49	\$7.07	\$16.18	\$0.00	\$64.74
8	95	\$43.80	\$7.07	\$17.09	\$0.00	\$67.96

Notes:

Apprentice to Journeyworker Ratio:1:4

BRICK/STONE/ARTIFICIAL MASONRY (INCL. MASONRY WATERPROOFING) <i>BRICKLAYERS LOCAL 3 (FOXBORO)</i>	08/01/2021	\$55.01	\$11.39	\$21.57	\$0.00	\$87.97
	02/01/2022	\$55.59	\$11.39	\$21.57	\$0.00	\$88.55

Classification

Effective Date Base Wage Health Pension Supplemental Unemployment Total Rate

Apprentice - BRICK/PLASTER/CEMENT MASON - Local 3 Foxboro

Effective Date - 08/01/2021

Step	percent	Apprentice Base Wage	Health	Pension	Supplemental Unemployment	Total Rate
1	50	\$27.51	\$11.39	\$21.57	\$0.00	\$60.47
2	60	\$33.01	\$11.39	\$21.57	\$0.00	\$65.97
3	70	\$38.51	\$11.39	\$21.57	\$0.00	\$71.47
4	80	\$44.01	\$11.39	\$21.57	\$0.00	\$76.97
5	90	\$49.51	\$11.39	\$21.57	\$0.00	\$82.47

Effective Date - 02/01/2022

Step	percent	Apprentice Base Wage	Health	Pension	Supplemental Unemployment	Total Rate
1	50	\$27.80	\$11.39	\$21.57	\$0.00	\$60.76
2	60	\$33.35	\$11.39	\$21.57	\$0.00	\$66.31
3	70	\$38.91	\$11.39	\$21.57	\$0.00	\$71.87
4	80	\$44.47	\$11.39	\$21.57	\$0.00	\$77.43
5	90	\$50.03	\$11.39	\$21.57	\$0.00	\$82.99

Notes:

Apprentice to Journeyworker Ratio:1:5

BULLDOZER/GRADER/SCRAPER <i>OPERATING ENGINEERS LOCAL 4</i>	06/01/2021	\$50.19	\$13.75	\$15.80	\$0.00	\$79.74
	12/01/2021	\$51.33	\$13.75	\$15.80	\$0.00	\$80.88
For apprentice rates see "Apprentice- OPERATING ENGINEERS"						
CAISSON & UNDERPINNING BOTTOM MAN <i>LABORERS - FOUNDATION AND MARINE</i>	06/01/2021	\$41.82	\$8.60	\$17.72	\$0.00	\$68.14
	12/01/2021	\$42.83	\$8.60	\$17.72	\$0.00	\$69.15
For apprentice rates see "Apprentice- LABORER"						
CAISSON & UNDERPINNING LABORER <i>LABORERS - FOUNDATION AND MARINE</i>	06/01/2021	\$40.67	\$8.60	\$17.72	\$0.00	\$66.99
	12/01/2021	\$41.68	\$8.60	\$17.72	\$0.00	\$68.00
For apprentice rates see "Apprentice- LABORER"						
CAISSON & UNDERPINNING TOP MAN <i>LABORERS - FOUNDATION AND MARINE</i>	06/01/2021	\$40.67	\$8.60	\$17.72	\$0.00	\$66.99
	12/01/2021	\$41.68	\$8.60	\$17.72	\$0.00	\$68.00
For apprentice rates see "Apprentice- LABORER"						
CARBIDE CORE DRILL OPERATOR <i>LABORERS - ZONE 2</i>	06/01/2021	\$35.25	\$8.60	\$16.64	\$0.00	\$60.49
	12/01/2021	\$36.16	\$8.60	\$16.64	\$0.00	\$61.40
	06/01/2022	\$37.06	\$8.60	\$16.64	\$0.00	\$62.30
	12/01/2022	\$37.91	\$8.60	\$16.64	\$0.00	\$63.15
	06/01/2023	\$38.81	\$8.60	\$16.64	\$0.00	\$64.05
	12/01/2023	\$39.71	\$8.60	\$16.64	\$0.00	\$64.95
For apprentice rates see "Apprentice- LABORER"						
CARPENTER <i>CARPENTERS -ZONE 2 (Eastern Massachusetts)</i>	09/01/2021	\$44.18	\$8.58	\$19.82	\$0.00	\$72.58
	03/01/2022	\$44.78	\$8.58	\$19.82	\$0.00	\$73.18
	09/01/2022	\$45.43	\$8.58	\$19.82	\$0.00	\$73.83
	03/01/2023	\$46.03	\$8.58	\$19.82	\$0.00	\$74.43

Classification

Effective Date Base Wage Health Pension Supplemental Unemployment Total Rate

Apprentice - CARPENTER - Zone 2 Eastern MA

Effective Date - 09/01/2021

Step	percent	Apprentice Base Wage	Health	Pension	Supplemental Unemployment	Total Rate
1	50	\$22.09	\$8.58	\$1.73	\$0.00	\$32.40
2	60	\$26.51	\$8.58	\$1.73	\$0.00	\$36.82
3	70	\$30.93	\$8.58	\$14.63	\$0.00	\$54.14
4	75	\$33.14	\$8.58	\$14.63	\$0.00	\$56.35
5	80	\$35.34	\$8.58	\$16.36	\$0.00	\$60.28
6	80	\$35.34	\$8.58	\$16.36	\$0.00	\$60.28
7	90	\$39.76	\$8.58	\$18.09	\$0.00	\$66.43
8	90	\$39.76	\$8.58	\$18.09	\$0.00	\$66.43

Effective Date - 03/01/2022

Step	percent	Apprentice Base Wage	Health	Pension	Supplemental Unemployment	Total Rate
1	50	\$22.39	\$8.58	\$1.73	\$0.00	\$32.70
2	60	\$26.87	\$8.58	\$1.73	\$0.00	\$37.18
3	70	\$31.35	\$8.58	\$14.63	\$0.00	\$54.56
4	75	\$33.59	\$8.58	\$14.63	\$0.00	\$56.80
5	80	\$35.82	\$8.58	\$16.36	\$0.00	\$60.76
6	80	\$35.82	\$8.58	\$16.36	\$0.00	\$60.76
7	90	\$40.30	\$8.58	\$18.09	\$0.00	\$66.97
8	90	\$40.30	\$8.58	\$18.09	\$0.00	\$66.97

Notes:

% Indentured After 10/1/17; 45/45/55/55/70/70/80/80
 Step 1&2 \$30.19/ 3&4 \$36.28/ 5&6 \$55.87/ 7&8 \$62.01

Apprentice to Journeyworker Ratio:1:5

CARPENTER WOOD FRAME	04/01/2021	\$23.16	\$7.21	\$4.80	\$0.00	\$35.17
CARPENTERS-ZONE 3 (Wood Frame)	04/01/2022	\$23.66	\$7.21	\$4.80	\$0.00	\$35.67
	04/01/2023	\$24.16	\$7.21	\$4.80	\$0.00	\$36.17

All Aspects of New Wood Frame Work

Classification

Effective Date Base Wage Health Pension Supplemental Unemployment Total Rate

Apprentice - CARPENTER (Wood Frame) - Zone 3

Effective Date - 04/01/2021

Step	percent	Apprentice Base Wage	Health	Pension	Supplemental Unemployment	Total Rate
1	60	\$13.90	\$7.21	\$0.00	\$0.00	\$21.11
2	60	\$13.90	\$7.21	\$0.00	\$0.00	\$21.11
3	65	\$15.05	\$7.21	\$0.00	\$0.00	\$22.26
4	70	\$16.21	\$7.21	\$0.00	\$0.00	\$23.42
5	75	\$17.37	\$7.21	\$3.80	\$0.00	\$28.38
6	80	\$18.53	\$7.21	\$3.80	\$0.00	\$29.54
7	85	\$19.69	\$7.21	\$3.80	\$0.00	\$30.70
8	90	\$20.84	\$7.21	\$3.80	\$0.00	\$31.85

Effective Date - 04/01/2022

Step	percent	Apprentice Base Wage	Health	Pension	Supplemental Unemployment	Total Rate
1	60	\$14.20	\$7.21	\$0.00	\$0.00	\$21.41
2	60	\$14.20	\$7.21	\$0.00	\$0.00	\$21.41
3	65	\$15.38	\$7.21	\$0.00	\$0.00	\$22.59
4	70	\$16.56	\$7.21	\$0.00	\$0.00	\$23.77
5	75	\$17.75	\$7.21	\$3.80	\$0.00	\$28.76
6	80	\$18.93	\$7.21	\$3.80	\$0.00	\$29.94
7	85	\$20.11	\$7.21	\$3.80	\$0.00	\$31.12
8	90	\$21.29	\$7.21	\$3.80	\$0.00	\$32.30

Notes:

% Indentured After 10/1/17; 45/45/55/55/70/70/80/80
 Step 1&2 \$17.63/ 3&4 \$19.95/ 5&6 \$27.22/ 7&8 \$29.54

Apprentice to Journeyworker Ratio:1:5

CEMENT MASONRY/PLASTERING BRICKLAYERS LOCAL 3 (FOXBORO)	01/01/2020	\$44.67	\$12.75	\$22.41	\$0.62	\$80.45
--	------------	---------	---------	---------	--------	---------

Apprentice - CEMENT MASONRY/PLASTERING - Foxboro

Effective Date - 01/01/2020

Step	percent	Apprentice Base Wage	Health	Pension	Supplemental Unemployment	Total Rate
1	50	\$22.34	\$12.75	\$15.41	\$0.00	\$50.50
2	60	\$26.80	\$12.75	\$17.41	\$0.62	\$57.58
3	65	\$29.04	\$12.75	\$18.41	\$0.62	\$60.82
4	70	\$31.27	\$12.75	\$19.41	\$0.62	\$64.05
5	75	\$33.50	\$12.75	\$20.41	\$0.62	\$67.28
6	80	\$35.74	\$12.75	\$21.41	\$0.62	\$70.52
7	90	\$40.20	\$12.75	\$22.41	\$0.62	\$75.98

Notes:

Steps 3,4 are 500 hrs. All other steps are 1,000 hrs.

Apprentice to Journeyworker Ratio:1:3

Classification	Effective Date	Base Wage	Health	Pension	Supplemental Unemployment	Total Rate
CHAIN SAW OPERATOR <i>LABORERS - ZONE 2</i>	06/01/2021	\$35.25	\$8.60	\$16.64	\$0.00	\$60.49
	12/01/2021	\$36.16	\$8.60	\$16.64	\$0.00	\$61.40
	06/01/2022	\$37.06	\$8.60	\$16.64	\$0.00	\$62.30
	12/01/2022	\$37.91	\$8.60	\$16.64	\$0.00	\$63.15
	06/01/2023	\$38.81	\$8.60	\$16.64	\$0.00	\$64.05
	12/01/2023	\$39.71	\$8.60	\$16.64	\$0.00	\$64.95
For apprentice rates see "Apprentice- LABORER"						
CLAM SHELLS/SLURRY BUCKETS/HEADING MACHINES <i>OPERATING ENGINEERS LOCAL 4</i>	06/01/2021	\$51.73	\$13.75	\$15.80	\$0.00	\$81.28
	12/01/2021	\$52.88	\$13.75	\$15.80	\$0.00	\$82.43
For apprentice rates see "Apprentice- OPERATING ENGINEERS"						
COMPRESSOR OPERATOR <i>OPERATING ENGINEERS LOCAL 4</i>	06/01/2021	\$33.40	\$13.75	\$15.80	\$0.00	\$62.95
	12/01/2021	\$34.19	\$13.75	\$15.80	\$0.00	\$63.74
For apprentice rates see "Apprentice- OPERATING ENGINEERS"						
DELEADER (BRIDGE) <i>PAINTERS LOCAL 35 - ZONE 2</i>	01/01/2021	\$52.06	\$8.25	\$22.75	\$0.00	\$83.06

Apprentice - PAINTER Local 35 - BRIDGES/TANKS

Effective Date - 01/01/2021

Step	percent	Apprentice Base Wage	Health	Pension	Supplemental Unemployment	Total Rate
1	50	\$26.03	\$8.25	\$0.00	\$0.00	\$34.28
2	55	\$28.63	\$8.25	\$6.16	\$0.00	\$43.04
3	60	\$31.24	\$8.25	\$6.72	\$0.00	\$46.21
4	65	\$33.84	\$8.25	\$7.28	\$0.00	\$49.37
5	70	\$36.44	\$8.25	\$19.39	\$0.00	\$64.08
6	75	\$39.05	\$8.25	\$19.95	\$0.00	\$67.25
7	80	\$41.65	\$8.25	\$20.51	\$0.00	\$70.41
8	90	\$46.85	\$8.25	\$21.63	\$0.00	\$76.73

Notes:

Steps are 750 hrs.

Apprentice to Journeyworker Ratio:1:1

DEMO: ADZEMAN <i>LABORERS - ZONE 2</i>	06/01/2021	\$40.82	\$8.60	\$17.57	\$0.00	\$66.99
	12/01/2021	\$41.83	\$8.60	\$17.57	\$0.00	\$68.00
	06/01/2022	\$42.83	\$8.60	\$17.57	\$0.00	\$69.00
	12/01/2022	\$43.83	\$8.60	\$17.57	\$0.00	\$70.00
	06/01/2023	\$44.83	\$8.60	\$17.57	\$0.00	\$71.00
	12/01/2023	\$46.08	\$8.60	\$17.57	\$0.00	\$72.25
For apprentice rates see "Apprentice- LABORER"						
DEMO: BACKHOE/LOADER/HAMMER OPERATOR <i>LABORERS - ZONE 2</i>	06/01/2021	\$41.82	\$8.60	\$17.57	\$0.00	\$67.99
	12/01/2021	\$42.83	\$8.60	\$17.57	\$0.00	\$69.00
	06/01/2022	\$43.83	\$8.60	\$17.57	\$0.00	\$70.00
	12/01/2022	\$44.83	\$8.60	\$17.57	\$0.00	\$71.00
	06/01/2023	\$45.83	\$8.60	\$17.57	\$0.00	\$72.00
	12/01/2023	\$47.08	\$8.60	\$17.57	\$0.00	\$73.25
For apprentice rates see "Apprentice- LABORER"						

Classification	Effective Date	Base Wage	Health	Pension	Supplemental Unemployment	Total Rate
DEMO: BURNERS <i>LABORERS - ZONE 2</i>	06/01/2021	\$41.57	\$8.60	\$17.57	\$0.00	\$67.74
	12/01/2021	\$42.58	\$8.60	\$17.57	\$0.00	\$68.75
	06/01/2022	\$43.58	\$8.60	\$17.57	\$0.00	\$69.75
	12/01/2022	\$44.58	\$8.60	\$17.57	\$0.00	\$70.75
	06/01/2023	\$45.58	\$8.60	\$17.57	\$0.00	\$71.75
	12/01/2023	\$46.83	\$8.60	\$17.57	\$0.00	\$73.00
For apprentice rates see "Apprentice- LABORER"						
DEMO: CONCRETE CUTTER/SAWYER <i>LABORERS - ZONE 2</i>	06/01/2021	\$41.82	\$8.60	\$17.57	\$0.00	\$67.99
	12/01/2021	\$42.83	\$8.60	\$17.57	\$0.00	\$69.00
	06/01/2022	\$43.83	\$8.60	\$17.57	\$0.00	\$70.00
	12/01/2022	\$44.83	\$8.60	\$17.57	\$0.00	\$71.00
	06/01/2023	\$45.83	\$8.60	\$17.57	\$0.00	\$72.00
	12/01/2023	\$47.08	\$8.60	\$17.57	\$0.00	\$73.25
For apprentice rates see "Apprentice- LABORER"						
DEMO: JACKHAMMER OPERATOR <i>LABORERS - ZONE 2</i>	06/01/2021	\$41.57	\$8.60	\$17.57	\$0.00	\$67.74
	12/01/2021	\$42.58	\$8.60	\$17.57	\$0.00	\$68.75
	06/01/2022	\$43.58	\$8.60	\$17.57	\$0.00	\$69.75
	12/01/2022	\$44.58	\$8.60	\$17.57	\$0.00	\$70.75
	06/01/2023	\$45.58	\$8.60	\$17.57	\$0.00	\$71.75
	12/01/2023	\$46.83	\$8.60	\$17.57	\$0.00	\$73.00
For apprentice rates see "Apprentice- LABORER"						
DEMO: WRECKING LABORER <i>LABORERS - ZONE 2</i>	06/01/2021	\$40.82	\$8.60	\$17.57	\$0.00	\$66.99
	12/01/2021	\$41.83	\$8.60	\$17.57	\$0.00	\$68.00
	06/01/2022	\$42.83	\$8.60	\$17.57	\$0.00	\$69.00
	12/01/2022	\$43.83	\$8.60	\$17.57	\$0.00	\$70.00
	06/01/2023	\$44.83	\$8.60	\$17.57	\$0.00	\$71.00
	12/01/2023	\$46.08	\$8.60	\$17.57	\$0.00	\$72.25
For apprentice rates see "Apprentice- LABORER"						
DIRECTIONAL DRILL MACHINE OPERATOR <i>OPERATING ENGINEERS LOCAL 4</i>	06/01/2021	\$50.19	\$13.75	\$15.80	\$0.00	\$79.74
	12/01/2021	\$51.33	\$13.75	\$15.80	\$0.00	\$80.88
For apprentice rates see "Apprentice- OPERATING ENGINEERS"						
DIVER <i>PILE DRIVER LOCAL 56 (ZONE 1)</i>	08/01/2020	\$68.70	\$9.40	\$23.12	\$0.00	\$101.22
For apprentice rates see "Apprentice- PILE DRIVER"						
DIVER TENDER <i>PILE DRIVER LOCAL 56 (ZONE 1)</i>	08/01/2020	\$49.07	\$9.40	\$23.12	\$0.00	\$81.59
For apprentice rates see "Apprentice- PILE DRIVER"						
DIVER TENDER (EFFLUENT) <i>PILE DRIVER LOCAL 56 (ZONE 1)</i>	08/01/2020	\$73.60	\$9.40	\$23.12	\$0.00	\$106.12
For apprentice rates see "Apprentice- PILE DRIVER"						
DIVER/SLURRY (EFFLUENT) <i>PILE DRIVER LOCAL 56 (ZONE 1)</i>	08/01/2020	\$103.05	\$9.40	\$23.12	\$0.00	\$135.57
For apprentice rates see "Apprentice- PILE DRIVER"						
DRAWBRIDGE OPERATOR (Construction) <i>DRAWBRIDGE - SEIU LOCAL 888</i>	07/01/2020	\$26.77	\$6.67	\$3.93	\$0.16	\$37.53
ELECTRICIAN <i>ELECTRICIANS LOCAL 223</i>	09/01/2020	\$43.66	\$10.90	\$14.66	\$0.00	\$69.22

Classification

Effective Date Base Wage Health Pension Supplemental Unemployment Total Rate

Apprentice - ELECTRICIAN - Local 223

Effective Date - 09/01/2020

Step	percent	Apprentice Base Wage	Health	Pension	Supplemental Unemployment	Total Rate
1	40	\$17.46	\$10.90	\$0.52	\$0.00	\$28.88
2	45	\$19.65	\$10.90	\$0.59	\$0.00	\$31.14
3	50	\$21.83	\$10.90	\$0.65	\$0.00	\$33.38
4	55	\$24.01	\$10.90	\$6.28	\$0.00	\$41.19
5	60	\$26.20	\$10.90	\$6.77	\$0.00	\$43.87
6	65	\$28.38	\$10.90	\$7.24	\$0.00	\$46.52
7	70	\$30.56	\$10.90	\$7.73	\$0.00	\$49.19
8	75	\$32.75	\$10.90	\$8.21	\$0.00	\$51.86

Notes:

Apprentice to Journeyworker Ratio:2:3***

ELEVATOR CONSTRUCTOR ELEVATOR CONSTRUCTORS LOCAL 4	01/01/2021	\$63.47	\$15.88	\$19.31	\$0.00	\$98.66
	01/01/2022	\$65.62	\$16.03	\$20.21	\$0.00	\$101.86

Apprentice - ELEVATOR CONSTRUCTOR - Local 4

Effective Date - 01/01/2021

Step	percent	Apprentice Base Wage	Health	Pension	Supplemental Unemployment	Total Rate
1	50	\$31.74	\$15.88	\$0.00	\$0.00	\$47.62
2	55	\$34.91	\$15.88	\$19.31	\$0.00	\$70.10
3	65	\$41.26	\$15.88	\$19.31	\$0.00	\$76.45
4	70	\$44.43	\$15.88	\$19.31	\$0.00	\$79.62
5	80	\$50.78	\$15.88	\$19.31	\$0.00	\$85.97

Effective Date - 01/01/2022

Step	percent	Apprentice Base Wage	Health	Pension	Supplemental Unemployment	Total Rate
1	50	\$32.81	\$16.03	\$0.00	\$0.00	\$48.84
2	55	\$36.09	\$16.03	\$20.21	\$0.00	\$72.33
3	65	\$42.65	\$16.03	\$20.21	\$0.00	\$78.89
4	70	\$45.93	\$16.03	\$20.21	\$0.00	\$82.17
5	80	\$52.50	\$16.03	\$20.21	\$0.00	\$88.74

Notes:

Steps 1-2 are 6 mos.; Steps 3-5 are 1 year

Apprentice to Journeyworker Ratio:1:1

ELEVATOR CONSTRUCTOR HELPER ELEVATOR CONSTRUCTORS LOCAL 4	01/01/2021	\$44.43	\$15.88	\$19.31	\$0.00	\$79.62
	01/01/2022	\$45.93	\$16.03	\$20.21	\$0.00	\$82.17

For apprentice rates see "Apprentice - ELEVATOR CONSTRUCTOR"

FENCE & GUARD RAIL ERECTOR (HEAVY & HIGHWAY) LABORERS - ZONE 2 (HEAVY & HIGHWAY)	06/01/2021	\$35.25	\$8.60	\$16.64	\$0.00	\$60.49
	12/01/2021	\$36.16	\$8.60	\$16.64	\$0.00	\$61.40

Classification	Effective Date	Base Wage	Health	Pension	Supplemental Unemployment	Total Rate
For apprentice rates see "Apprentice- LABORER (Heavy and Highway)						
FIELD ENG.INST.PERSON-BLDG,SITE,HVY/HWY <i>OPERATING ENGINEERS LOCAL 4</i>	05/01/2021	\$45.88	\$13.50	\$15.70	\$0.00	\$75.08
	11/01/2021	\$46.88	\$13.50	\$15.70	\$0.00	\$76.08
	05/01/2022	\$48.03	\$13.50	\$15.70	\$0.00	\$77.23
For apprentice rates see "Apprentice- OPERATING ENGINEERS"						
FIELD ENG.PARTY CHIEF-BLDG,SITE,HVY/HWY <i>OPERATING ENGINEERS LOCAL 4</i>	05/01/2021	\$47.40	\$13.50	\$15.70	\$0.00	\$76.60
	11/01/2021	\$48.41	\$13.50	\$15.70	\$0.00	\$77.61
	05/01/2022	\$49.57	\$13.50	\$15.70	\$0.00	\$78.77
For apprentice rates see "Apprentice- OPERATING ENGINEERS"						
FIELD ENG.ROD PERSON-BLDG,SITE,HVY/HWY <i>OPERATING ENGINEERS LOCAL 4</i>	05/01/2021	\$22.91	\$13.50	\$15.70	\$0.00	\$52.11
	11/01/2021	\$23.51	\$13.50	\$15.70	\$0.00	\$52.71
	05/01/2022	\$24.18	\$13.50	\$15.70	\$0.00	\$53.38
For apprentice rates see "Apprentice- OPERATING ENGINEERS"						
FIRE ALARM INSTALLER <i>ELECTRICIANS LOCAL 223</i>	09/01/2020	\$43.66	\$10.90	\$14.66	\$0.00	\$69.22
For apprentice rates see "Apprentice- ELECTRICIAN"						
FIRE ALARM REPAIR / MAINTENANCE <i>LOCAL 223</i> <i>/ COMMISSIONINGELECTRICIANS</i>	09/01/2020	\$36.86	\$10.90	\$12.45	\$0.00	\$60.21
For apprentice rates see "Apprentice- TELECOMMUNICATIONS TECHNICIAN"						
FIREMAN (ASST. ENGINEER) <i>OPERATING ENGINEERS LOCAL 4</i>	06/01/2021	\$41.31	\$13.75	\$15.80	\$0.00	\$70.86
	12/01/2021	\$42.26	\$13.75	\$15.80	\$0.00	\$71.81
For apprentice rates see "Apprentice- OPERATING ENGINEERS"						
FLAGGER & SIGNALER (HEAVY & HIGHWAY) <i>LABORERS - ZONE 2 (HEAVY & HIGHWAY)</i>	06/01/2021	\$24.50	\$8.60	\$16.64	\$0.00	\$49.74
	12/01/2021	\$24.50	\$8.60	\$16.64	\$0.00	\$49.74
For apprentice rates see "Apprentice- LABORER (Heavy and Highway)						
FLOORCOVERER <i>FLOORCOVERERS LOCAL 2168 ZONE 1</i>	09/01/2021	\$49.38	\$8.58	\$20.12	\$0.00	\$78.08
	03/01/2022	\$50.18	\$8.58	\$20.12	\$0.00	\$78.88

Classification

Effective Date Base Wage Health Pension Supplemental Unemployment Total Rate

Apprentice - FLOORCOVERER - Local 2168 Zone I

Effective Date - 09/01/2021

Step	percent	Apprentice Base Wage	Health	Pension	Supplemental Unemployment	Total Rate
1	50	\$24.69	\$8.58	\$1.79	\$0.00	\$35.06
2	55	\$27.16	\$8.58	\$1.79	\$0.00	\$37.53
3	60	\$29.63	\$8.58	\$14.75	\$0.00	\$52.96
4	65	\$32.10	\$8.58	\$14.75	\$0.00	\$55.43
5	70	\$34.57	\$8.58	\$16.54	\$0.00	\$59.69
6	75	\$37.04	\$8.58	\$16.54	\$0.00	\$62.16
7	80	\$39.50	\$8.58	\$18.33	\$0.00	\$66.41
8	85	\$41.97	\$8.58	\$18.33	\$0.00	\$68.88

Effective Date - 03/01/2022

Step	percent	Apprentice Base Wage	Health	Pension	Supplemental Unemployment	Total Rate
1	50	\$25.09	\$8.58	\$1.79	\$0.00	\$35.46
2	55	\$27.60	\$8.58	\$1.79	\$0.00	\$37.97
3	60	\$30.11	\$8.58	\$14.75	\$0.00	\$53.44
4	65	\$32.62	\$8.58	\$14.75	\$0.00	\$55.95
5	70	\$35.13	\$8.58	\$16.54	\$0.00	\$60.25
6	75	\$37.64	\$8.58	\$16.54	\$0.00	\$62.76
7	80	\$40.14	\$8.58	\$18.33	\$0.00	\$67.05
8	85	\$42.65	\$8.58	\$18.33	\$0.00	\$69.56

Notes: Steps are 750 hrs.
 % After 10/1/17; 45/45/55/55/70/70/80/80 (1500hr Steps)
 Step 1&2 \$32.59/ 3&4 \$39.26/ 5&6 \$59.69/ 7&8 \$66.41

Apprentice to Journeyworker Ratio:1:1

FORK LIFT/CHERRY PICKER <i>OPERATING ENGINEERS LOCAL 4</i>	06/01/2021	\$50.73	\$13.75	\$15.80	\$0.00	\$80.28
For apprentice rates see "Apprentice- OPERATING ENGINEERS"	12/01/2021	\$51.88	\$13.75	\$15.80	\$0.00	\$81.43
GENERATOR/LIGHTING PLANT/HEATERS <i>OPERATING ENGINEERS LOCAL 4</i>	06/01/2021	\$33.40	\$13.75	\$15.80	\$0.00	\$62.95
For apprentice rates see "Apprentice- OPERATING ENGINEERS"	12/01/2021	\$34.19	\$13.75	\$15.80	\$0.00	\$63.74
GLAZIER (GLASS PLANK/AIR BARRIER/INTERIOR SYSTEMS) <i>GLAZIERS LOCAL 1333</i>	06/01/2020	\$39.18	\$10.80	\$10.45	\$0.00	\$60.43

Classification

Effective Date Base Wage Health Pension Supplemental Unemployment Total Rate

Apprentice - GLAZIER - Local 1333

Effective Date - 06/01/2020

Step	percent	Apprentice Base Wage	Health	Pension	Supplemental Unemployment	Total Rate
1	50	\$19.59	\$10.80	\$1.80	\$0.00	\$32.19
2	56	\$22.04	\$10.80	\$1.80	\$0.00	\$34.64
3	63	\$24.49	\$10.80	\$2.45	\$0.00	\$37.74
4	69	\$26.94	\$10.80	\$2.45	\$0.00	\$40.19
5	75	\$29.39	\$10.80	\$3.15	\$0.00	\$43.34
6	81	\$31.83	\$10.80	\$3.15	\$0.00	\$45.78
7	88	\$34.28	\$10.80	\$10.45	\$0.00	\$55.53
8	94	\$36.73	\$10.80	\$10.45	\$0.00	\$57.98

Notes:

Apprentice to Journeyworker Ratio:1:3

HOISTING ENGINEER/CRANES/GRADALLS	06/01/2021	\$50.73	\$13.75	\$15.80	\$0.00	\$80.28
OPERATING ENGINEERS LOCAL 4	12/01/2021	\$51.88	\$13.75	\$15.80	\$0.00	\$81.43

Classification

Effective Date Base Wage Health Pension Supplemental Unemployment Total Rate

Apprentice - OPERATING ENGINEERS - Local 4

Effective Date - 06/01/2021

Step	percent	Apprentice Base Wage	Health	Pension	Supplemental Unemployment	Total Rate
1	55	\$27.90	\$13.75	\$0.00	\$0.00	\$41.65
2	60	\$30.44	\$13.75	\$15.80	\$0.00	\$59.99
3	65	\$32.97	\$13.75	\$15.80	\$0.00	\$62.52
4	70	\$35.51	\$13.75	\$15.80	\$0.00	\$65.06
5	75	\$38.05	\$13.75	\$15.80	\$0.00	\$67.60
6	80	\$40.58	\$13.75	\$15.80	\$0.00	\$70.13
7	85	\$43.12	\$13.75	\$15.80	\$0.00	\$72.67
8	90	\$45.66	\$13.75	\$15.80	\$0.00	\$75.21

Effective Date - 12/01/2021

Step	percent	Apprentice Base Wage	Health	Pension	Supplemental Unemployment	Total Rate
1	55	\$28.53	\$13.75	\$0.00	\$0.00	\$42.28
2	60	\$31.13	\$13.75	\$15.80	\$0.00	\$60.68
3	65	\$33.72	\$13.75	\$15.80	\$0.00	\$63.27
4	70	\$36.32	\$13.75	\$15.80	\$0.00	\$65.87
5	75	\$38.91	\$13.75	\$15.80	\$0.00	\$68.46
6	80	\$41.50	\$13.75	\$15.80	\$0.00	\$71.05
7	85	\$44.10	\$13.75	\$15.80	\$0.00	\$73.65
8	90	\$46.69	\$13.75	\$15.80	\$0.00	\$76.24

Notes:

Apprentice to Journeyworker Ratio:1:6

HVAC (DUCTWORK) SHEETMETAL WORKERS LOCAL 17 - A	08/01/2021	\$51.95	\$13.80	\$25.60	\$2.74	\$94.09
	02/01/2022	\$53.70	\$13.80	\$25.60	\$2.79	\$95.89

For apprentice rates see "Apprentice- SHEET METAL WORKER"

HVAC (ELECTRICAL CONTROLS) ELECTRICIANS LOCAL 223	09/01/2020	\$43.66	\$10.90	\$14.66	\$0.00	\$69.22
--	------------	---------	---------	---------	--------	---------

For apprentice rates see "Apprentice- ELECTRICIAN"

HVAC (TESTING AND BALANCING - AIR) SHEETMETAL WORKERS LOCAL 17 - A	08/01/2021	\$51.95	\$13.80	\$25.60	\$2.74	\$94.09
	02/01/2022	\$53.70	\$13.80	\$25.60	\$2.79	\$95.89

For apprentice rates see "Apprentice- SHEET METAL WORKER"

HVAC (TESTING AND BALANCING -WATER) PLUMBERS & PIPEFITTERS LOCAL 51	08/30/2021	\$46.49	\$10.15	\$19.95	\$0.00	\$76.59
--	------------	---------	---------	---------	--------	---------

For apprentice rates see "Apprentice- PIPEFITTER" or "PLUMBER/PIPEFITTER"

HVAC MECHANIC PLUMBERS & PIPEFITTERS LOCAL 51	08/30/2021	\$46.49	\$10.15	\$19.95	\$0.00	\$76.59
--	------------	---------	---------	---------	--------	---------

For apprentice rates see "Apprentice- PIPEFITTER" or "PLUMBER/PIPEFITTER"

Classification	Effective Date	Base Wage	Health	Pension	Supplemental Unemployment	Total Rate
HYDRAULIC DRILLS <i>LABORERS - ZONE 2</i>	06/01/2021	\$35.75	\$8.60	\$16.64	\$0.00	\$60.99
	12/01/2021	\$36.66	\$8.60	\$16.64	\$0.00	\$61.90
	06/01/2022	\$37.56	\$8.60	\$16.64	\$0.00	\$62.80
	12/01/2022	\$38.41	\$8.60	\$16.64	\$0.00	\$63.65
	06/01/2023	\$39.31	\$8.60	\$16.64	\$0.00	\$64.55
	12/01/2023	\$40.21	\$8.60	\$16.64	\$0.00	\$65.45
For apprentice rates see "Apprentice- LABORER"						
HYDRAULIC DRILLS (HEAVY & HIGHWAY) <i>LABORERS - ZONE 2 (HEAVY & HIGHWAY)</i>	06/01/2021	\$35.75	\$8.60	\$16.64	\$0.00	\$60.99
	12/01/2021	\$36.66	\$8.60	\$16.64	\$0.00	\$61.90
For apprentice rates see "Apprentice- LABORER (Heavy and Highway)"						
INSULATOR (PIPES & TANKS) <i>HEAT & FROST INSULATORS LOCAL 6 (SOUTHERN MASS)</i>	09/01/2021	\$46.50	\$13.80	\$17.14	\$0.00	\$77.44
	09/01/2022	\$48.95	\$13.80	\$17.14	\$0.00	\$79.89

Apprentice - ASBESTOS INSULATOR (Pipes & Tanks) - Local 6 Southern MA

Effective Date - 09/01/2021

Step	percent	Apprentice Base Wage	Health	Pension	Supplemental Unemployment	Total Rate
1	50	\$23.25	\$13.80	\$12.42	\$0.00	\$49.47
2	60	\$27.90	\$13.80	\$13.36	\$0.00	\$55.06
3	70	\$32.55	\$13.80	\$14.31	\$0.00	\$60.66
4	80	\$37.20	\$13.80	\$15.25	\$0.00	\$66.25

Effective Date - 09/01/2022

Step	percent	Apprentice Base Wage	Health	Pension	Supplemental Unemployment	Total Rate
1	50	\$24.48	\$13.80	\$12.42	\$0.00	\$50.70
2	60	\$29.37	\$13.80	\$13.36	\$0.00	\$56.53
3	70	\$34.27	\$13.80	\$14.31	\$0.00	\$62.38
4	80	\$39.16	\$13.80	\$15.25	\$0.00	\$68.21

Notes:

Steps are 1 year

Apprentice to Journeyworker Ratio:1:4

IRONWORKER/WELDER <i>IRONWORKERS LOCAL 37</i>	03/16/2021	\$42.46	\$7.70	\$17.10	\$0.00	\$67.26
--	------------	---------	--------	---------	--------	---------

Classification

Effective Date Base Wage Health Pension Supplemental Unemployment Total Rate

Apprentice - IRONWORKER - Local 37

Effective Date - 03/16/2021

Step	percent	Apprentice Base Wage	Health	Pension	Supplemental Unemployment	Total Rate
1	70	\$29.72	\$7.70	\$17.10	\$0.00	\$54.52
2	75	\$31.85	\$7.70	\$17.10	\$0.00	\$56.65
3	80	\$33.97	\$7.70	\$17.10	\$0.00	\$58.77
4	85	\$36.09	\$7.70	\$17.10	\$0.00	\$60.89
5	90	\$38.21	\$7.70	\$17.10	\$0.00	\$63.01
6	95	\$40.34	\$7.70	\$17.10	\$0.00	\$65.14

Notes:

Apprentice to Journeyworker Ratio:1:4

JACKHAMMER & PAVING BREAKER OPERATOR LABORERS - ZONE 2	06/01/2021	\$35.25	\$8.60	\$16.64	\$0.00	\$60.49
	12/01/2021	\$36.16	\$8.60	\$16.64	\$0.00	\$61.40
	06/01/2022	\$37.06	\$8.60	\$16.64	\$0.00	\$62.30
	12/01/2022	\$37.91	\$8.60	\$16.64	\$0.00	\$63.15
	06/01/2023	\$38.81	\$8.60	\$16.64	\$0.00	\$64.05
	12/01/2023	\$39.71	\$8.60	\$16.64	\$0.00	\$64.95

For apprentice rates see "Apprentice- LABORER"

LABORER LABORERS - ZONE 2	06/01/2021	\$35.00	\$8.60	\$16.64	\$0.00	\$60.24
	12/01/2021	\$35.91	\$8.60	\$16.64	\$0.00	\$61.15
	06/01/2022	\$36.81	\$8.60	\$16.64	\$0.00	\$62.05
	12/01/2022	\$37.66	\$8.60	\$16.64	\$0.00	\$62.90
	06/01/2023	\$38.56	\$8.60	\$16.64	\$0.00	\$63.80
	12/01/2023	\$39.46	\$8.60	\$16.64	\$0.00	\$64.70

Classification

Effective Date Base Wage Health Pension Supplemental Unemployment Total Rate

Apprentice - LABORER - Zone 2

Effective Date - 06/01/2021

Step	percent	Apprentice Base Wage	Health	Pension	Supplemental Unemployment	Total Rate
1	60	\$21.00	\$8.60	\$16.64	\$0.00	\$46.24
2	70	\$24.50	\$8.60	\$16.64	\$0.00	\$49.74
3	80	\$28.00	\$8.60	\$16.64	\$0.00	\$53.24
4	90	\$31.50	\$8.60	\$16.64	\$0.00	\$56.74

Effective Date - 12/01/2021

Step	percent	Apprentice Base Wage	Health	Pension	Supplemental Unemployment	Total Rate
1	60	\$21.55	\$8.60	\$16.64	\$0.00	\$46.79
2	70	\$25.14	\$8.60	\$16.64	\$0.00	\$50.38
3	80	\$28.73	\$8.60	\$16.64	\$0.00	\$53.97
4	90	\$32.32	\$8.60	\$16.64	\$0.00	\$57.56

Notes:

Apprentice to Journeyworker Ratio:1:5

LABORER (HEAVY & HIGHWAY)	06/01/2021	\$35.00	\$8.60	\$16.64	\$0.00	\$60.24
LABORERS - ZONE 2 (HEAVY & HIGHWAY)	12/01/2021	\$35.91	\$8.60	\$16.64	\$0.00	\$61.15

Apprentice - LABORER (Heavy & Highway) - Zone 2

Effective Date - 06/01/2021

Step	percent	Apprentice Base Wage	Health	Pension	Supplemental Unemployment	Total Rate
1	60	\$21.00	\$8.60	\$16.64	\$0.00	\$46.24
2	70	\$24.50	\$8.60	\$16.64	\$0.00	\$49.74
3	80	\$28.00	\$8.60	\$16.64	\$0.00	\$53.24
4	90	\$31.50	\$8.60	\$16.64	\$0.00	\$56.74

Effective Date - 12/01/2021

Step	percent	Apprentice Base Wage	Health	Pension	Supplemental Unemployment	Total Rate
1	60	\$21.55	\$8.60	\$16.64	\$0.00	\$46.79
2	70	\$25.14	\$8.60	\$16.64	\$0.00	\$50.38
3	80	\$28.73	\$8.60	\$16.64	\$0.00	\$53.97
4	90	\$32.32	\$8.60	\$16.64	\$0.00	\$57.56

Notes:

Apprentice to Journeyworker Ratio:1:5

Classification	Effective Date	Base Wage	Health	Pension	Supplemental Unemployment	Total Rate
LABORER: CARPENTER TENDER <i>LABORERS - ZONE 2</i>	06/01/2021	\$35.00	\$8.60	\$16.64	\$0.00	\$60.24
	12/01/2021	\$35.91	\$8.60	\$16.64	\$0.00	\$61.15
	06/01/2022	\$36.81	\$8.60	\$16.64	\$0.00	\$62.05
	12/01/2022	\$37.66	\$8.60	\$16.64	\$0.00	\$62.90
	06/01/2023	\$38.56	\$8.60	\$16.64	\$0.00	\$63.80
	12/01/2023	\$39.46	\$8.60	\$16.64	\$0.00	\$64.70
For apprentice rates see "Apprentice- LABORER"						
LABORER: CEMENT FINISHER TENDER <i>LABORERS - ZONE 2</i>	06/01/2021	\$35.00	\$8.60	\$16.64	\$0.00	\$60.24
	12/01/2021	\$35.91	\$8.60	\$16.64	\$0.00	\$61.15
	06/01/2022	\$36.81	\$8.60	\$16.64	\$0.00	\$62.05
	12/01/2022	\$37.66	\$8.60	\$16.64	\$0.00	\$62.90
	06/01/2023	\$38.56	\$8.60	\$16.64	\$0.00	\$63.80
	12/01/2023	\$39.46	\$8.60	\$16.64	\$0.00	\$64.70
For apprentice rates see "Apprentice- LABORER"						
LABORER: HAZARDOUS WASTE/ASBESTOS REMOVER <i>LABORERS - ZONE 2</i>	06/01/2021	\$35.09	\$8.60	\$16.70	\$0.00	\$60.39
	12/01/2021	\$36.00	\$8.60	\$16.70	\$0.00	\$61.30
	06/01/2022	\$36.90	\$8.60	\$16.70	\$0.00	\$62.20
	12/01/2022	\$37.75	\$8.60	\$16.70	\$0.00	\$63.05
	06/01/2023	\$38.65	\$8.60	\$16.70	\$0.00	\$63.95
	12/01/2023	\$39.55	\$8.60	\$16.70	\$0.00	\$64.85
For apprentice rates see "Apprentice- LABORER"						
LABORER: MASON TENDER <i>LABORERS - ZONE 2</i>	06/01/2021	\$35.25	\$8.60	\$16.64	\$0.00	\$60.49
	12/01/2021	\$36.16	\$8.60	\$16.64	\$0.00	\$61.40
	06/01/2022	\$37.06	\$8.60	\$16.64	\$0.00	\$62.30
	12/01/2022	\$37.91	\$8.60	\$16.64	\$0.00	\$63.15
	06/01/2023	\$38.81	\$8.60	\$16.64	\$0.00	\$64.05
	12/01/2023	\$39.71	\$8.60	\$16.64	\$0.00	\$64.95
For apprentice rates see "Apprentice- LABORER"						
LABORER: MASON TENDER (HEAVY & HIGHWAY) <i>LABORERS - ZONE 2 (HEAVY & HIGHWAY)</i>	06/01/2021	\$35.25	\$8.60	\$16.64	\$0.00	\$60.49
	12/01/2021	\$36.16	\$8.60	\$16.64	\$0.00	\$61.40
For apprentice rates see "Apprentice- LABORER (Heavy and Highway)"						
LABORER: MULTI-TRADE TENDER <i>LABORERS - ZONE 2</i>	06/01/2021	\$35.00	\$8.60	\$16.64	\$0.00	\$60.24
	12/01/2021	\$35.91	\$8.60	\$16.64	\$0.00	\$61.15
	06/01/2022	\$36.81	\$8.60	\$16.64	\$0.00	\$62.05
	12/01/2022	\$37.66	\$8.60	\$16.64	\$0.00	\$62.90
	06/01/2023	\$38.56	\$8.60	\$16.64	\$0.00	\$63.80
	12/01/2023	\$39.46	\$8.60	\$16.64	\$0.00	\$64.70
For apprentice rates see "Apprentice- LABORER"						
LABORER: TREE REMOVER <i>LABORERS - ZONE 2</i>	06/01/2021	\$35.00	\$8.60	\$16.64	\$0.00	\$60.24
	12/01/2021	\$35.91	\$8.60	\$16.64	\$0.00	\$61.15
	06/01/2022	\$36.81	\$8.60	\$16.64	\$0.00	\$62.05
	12/01/2022	\$37.66	\$8.60	\$16.64	\$0.00	\$62.90
	06/01/2023	\$38.56	\$8.60	\$16.64	\$0.00	\$63.80
	12/01/2023	\$39.46	\$8.60	\$16.64	\$0.00	\$64.70
This classification applies to the removal of standing trees, and the trimming and removal of branches and limbs when related to public works construction or site clearance incidental to construction . For apprentice rates see "Apprentice- LABORER"						

Classification	Effective Date	Base Wage	Health	Pension	Supplemental Unemployment	Total Rate
LASER BEAM OPERATOR <i>LABORERS - ZONE 2</i>	06/01/2021	\$35.25	\$8.60	\$16.64	\$0.00	\$60.49
	12/01/2021	\$36.16	\$8.60	\$16.64	\$0.00	\$61.40
	06/01/2022	\$37.06	\$8.60	\$16.64	\$0.00	\$62.30
	12/01/2022	\$37.91	\$8.60	\$16.64	\$0.00	\$63.15
	06/01/2023	\$38.81	\$8.60	\$16.64	\$0.00	\$64.05
	12/01/2023	\$39.71	\$8.60	\$16.64	\$0.00	\$64.95
For apprentice rates see "Apprentice- LABORER"						
LASER BEAM OPERATOR (HEAVY & HIGHWAY) <i>LABORERS - ZONE 2 (HEAVY & HIGHWAY)</i>	06/01/2021	\$35.25	\$8.60	\$16.64	\$0.00	\$60.49
	12/01/2021	\$36.16	\$8.60	\$16.64	\$0.00	\$61.40
For apprentice rates see "Apprentice- LABORER (Heavy and Highway)"						
MARBLE & TILE FINISHERS <i>BRICKLAYERS LOCAL 3 - MARBLE & TILE</i>	08/01/2021	\$43.69	\$11.39	\$20.30	\$0.00	\$75.38
	02/01/2022	\$44.16	\$11.39	\$20.30	\$0.00	\$75.85

Apprentice - MARBLE & TILE FINISHER - Local 3 Marble & Tile

Effective Date - 08/01/2021

Step	percent	Apprentice Base Wage	Health	Pension	Supplemental Unemployment	Total Rate
1	50	\$21.85	\$11.39	\$20.30	\$0.00	\$53.54
2	60	\$26.21	\$11.39	\$20.30	\$0.00	\$57.90
3	70	\$30.58	\$11.39	\$20.30	\$0.00	\$62.27
4	80	\$34.95	\$11.39	\$20.30	\$0.00	\$66.64
5	90	\$39.32	\$11.39	\$20.30	\$0.00	\$71.01

Effective Date - 02/01/2022

Step	percent	Apprentice Base Wage	Health	Pension	Supplemental Unemployment	Total Rate
1	50	\$22.08	\$11.39	\$20.30	\$0.00	\$53.77
2	60	\$26.50	\$11.39	\$20.30	\$0.00	\$58.19
3	70	\$30.91	\$11.39	\$20.30	\$0.00	\$62.60
4	80	\$35.33	\$11.39	\$20.30	\$0.00	\$67.02
5	90	\$39.74	\$11.39	\$20.30	\$0.00	\$71.43

Notes:

Apprentice to Journeyworker Ratio:1:3

MARBLE MASONS, TILELAYERS & TERRAZZO MECH <i>BRICKLAYERS LOCAL 3 - MARBLE & TILE</i>	08/01/2021	\$57.17	\$11.39	\$22.24	\$0.00	\$90.80
	02/01/2022	\$57.74	\$11.39	\$22.24	\$0.00	\$91.37

Classification

Effective Date Base Wage Health Pension Supplemental Unemployment Total Rate

Apprentice - MARBLE-TILE-TERRAZZO MECHANIC - Local 3 Marble & Tile

Effective Date - 08/01/2021

Step	percent	Apprentice Base Wage	Health	Pension	Supplemental Unemployment	Total Rate
1	50	\$28.59	\$11.39	\$22.24	\$0.00	\$62.22
2	60	\$34.30	\$11.39	\$22.24	\$0.00	\$67.93
3	70	\$40.02	\$11.39	\$22.24	\$0.00	\$73.65
4	80	\$45.74	\$11.39	\$22.24	\$0.00	\$79.37
5	90	\$51.45	\$11.39	\$22.24	\$0.00	\$85.08

Effective Date - 02/01/2022

Step	percent	Apprentice Base Wage	Health	Pension	Supplemental Unemployment	Total Rate
1	50	\$28.87	\$11.39	\$22.24	\$0.00	\$62.50
2	60	\$34.64	\$11.39	\$22.24	\$0.00	\$68.27
3	70	\$40.42	\$11.39	\$22.24	\$0.00	\$74.05
4	80	\$46.19	\$11.39	\$22.24	\$0.00	\$79.82
5	90	\$51.97	\$11.39	\$22.24	\$0.00	\$85.60

Notes:

Apprentice to Journeyworker Ratio:1:5

MECH. SWEEPER OPERATOR (ON CONST. SITES) <i>OPERATING ENGINEERS LOCAL 4</i>	06/01/2021	\$50.19	\$13.75	\$15.80	\$0.00	\$79.74
For apprentice rates see "Apprentice- OPERATING ENGINEERS"	12/01/2021	\$51.33	\$13.75	\$15.80	\$0.00	\$80.88
MECHANICS MAINTENANCE <i>OPERATING ENGINEERS LOCAL 4</i>	06/01/2021	\$50.19	\$13.75	\$15.80	\$0.00	\$79.74
For apprentice rates see "Apprentice- OPERATING ENGINEERS"	12/01/2021	\$51.33	\$13.75	\$15.80	\$0.00	\$80.88
MILLWRIGHT (Zone 2) <i>MILLWRIGHTS LOCAL 1121 - Zone 2</i>	03/01/2021	\$39.42	\$8.58	\$21.57	\$0.00	\$69.57
	01/03/2022	\$40.67	\$8.58	\$21.57	\$0.00	\$70.82
	01/02/2023	\$41.92	\$8.58	\$21.57	\$0.00	\$72.07

Apprentice - MILLWRIGHT - Local 1121 Zone 2

Effective Date - 03/01/2021

Step	percent	Apprentice Base Wage	Health	Pension	Supplemental Unemployment	Total Rate
1	55	\$21.68	\$8.58	\$5.72	\$0.00	\$35.98
2	65	\$25.62	\$8.58	\$17.93	\$0.00	\$52.13
3	75	\$29.57	\$8.58	\$18.98	\$0.00	\$57.13
4	85	\$33.51	\$8.58	\$20.01	\$0.00	\$62.10

Effective Date - 01/03/2022

Step	percent	Apprentice Base Wage	Health	Pension	Supplemental Unemployment	Total Rate
1	55	\$22.37	\$8.58	\$5.72	\$0.00	\$36.67
2	65	\$26.44	\$8.58	\$17.93	\$0.00	\$52.95
3	75	\$30.50	\$8.58	\$18.98	\$0.00	\$58.06
4	85	\$34.57	\$8.58	\$20.01	\$0.00	\$63.16

Notes: Step 1&2 Appr. indentured after 1/6/2020 receive no pension, but do receive annuity. (Step 1 \$5.72, Step 2 \$6.66)
Steps are 2,000 hours

Apprentice to Journeyworker Ratio:1:5

MORTAR MIXER LABORERS - ZONE 2	06/01/2021	\$35.25	\$8.60	\$16.64	\$0.00	\$60.49
	12/01/2021	\$36.16	\$8.60	\$16.64	\$0.00	\$61.40
	06/01/2022	\$37.06	\$8.60	\$16.64	\$0.00	\$62.30
	12/01/2022	\$37.91	\$8.60	\$16.64	\$0.00	\$63.15
	06/01/2023	\$38.81	\$8.60	\$16.64	\$0.00	\$64.05
	12/01/2023	\$39.71	\$8.60	\$16.64	\$0.00	\$64.95
For apprentice rates see "Apprentice- LABORER"						
OILER (OTHER THAN TRUCK CRANES,GRADALLS) OPERATING ENGINEERS LOCAL 4	06/01/2021	\$23.40	\$13.75	\$15.80	\$0.00	\$52.95
	12/01/2021	\$23.98	\$13.75	\$15.80	\$0.00	\$53.53
For apprentice rates see "Apprentice- OPERATING ENGINEERS"						
OILER (TRUCK CRANES, GRADALLS) OPERATING ENGINEERS LOCAL 4	06/01/2021	\$28.26	\$13.75	\$15.80	\$0.00	\$57.81
	12/01/2021	\$28.94	\$13.75	\$15.80	\$0.00	\$58.49
For apprentice rates see "Apprentice- OPERATING ENGINEERS"						
OTHER POWER DRIVEN EQUIPMENT - CLASS II OPERATING ENGINEERS LOCAL 4	06/01/2021	\$50.19	\$13.75	\$15.80	\$0.00	\$79.74
	12/01/2021	\$51.33	\$13.75	\$15.80	\$0.00	\$80.88
For apprentice rates see "Apprentice- OPERATING ENGINEERS"						
PAINTER (BRIDGES/TANKS) PAINTERS LOCAL 35 - ZONE 2	01/01/2021	\$52.06	\$8.25	\$22.75	\$0.00	\$83.06

Classification

Effective Date Base Wage Health Pension Supplemental Unemployment Total Rate

Apprentice - PAINTER Local 35 - BRIDGES/TANKS

Effective Date - 01/01/2021

Step	percent	Apprentice Base Wage	Health	Pension	Supplemental Unemployment	Total Rate
1	50	\$26.03	\$8.25	\$0.00	\$0.00	\$34.28
2	55	\$28.63	\$8.25	\$6.16	\$0.00	\$43.04
3	60	\$31.24	\$8.25	\$6.72	\$0.00	\$46.21
4	65	\$33.84	\$8.25	\$7.28	\$0.00	\$49.37
5	70	\$36.44	\$8.25	\$19.39	\$0.00	\$64.08
6	75	\$39.05	\$8.25	\$19.95	\$0.00	\$67.25
7	80	\$41.65	\$8.25	\$20.51	\$0.00	\$70.41
8	90	\$46.85	\$8.25	\$21.63	\$0.00	\$76.73

Notes:
Steps are 750 hrs.

Apprentice to Journeyworker Ratio:1:1

PAINTER (SPRAY OR SANDBLAST, NEW) *	01/01/2021	\$42.96	\$8.25	\$22.75	\$0.00	\$73.96
-------------------------------------	------------	---------	--------	---------	--------	---------

* If 30% or more of surfaces to be painted are new construction, NEW paint rate shall be used. PAINTERS LOCAL 35 - ZONE 2

Apprentice - PAINTER Local 35 Zone 2 - Spray/Sandblast - New

Effective Date - 01/01/2021

Step	percent	Apprentice Base Wage	Health	Pension	Supplemental Unemployment	Total Rate
1	50	\$21.48	\$8.25	\$0.00	\$0.00	\$29.73
2	55	\$23.63	\$8.25	\$6.16	\$0.00	\$38.04
3	60	\$25.78	\$8.25	\$6.72	\$0.00	\$40.75
4	65	\$27.92	\$8.25	\$7.28	\$0.00	\$43.45
5	70	\$30.07	\$8.25	\$19.39	\$0.00	\$57.71
6	75	\$32.22	\$8.25	\$19.95	\$0.00	\$60.42
7	80	\$34.37	\$8.25	\$20.51	\$0.00	\$63.13
8	90	\$38.66	\$8.25	\$21.63	\$0.00	\$68.54

Notes:
Steps are 750 hrs.

Apprentice to Journeyworker Ratio:1:1

PAINTER (SPRAY OR SANDBLAST, REPAINT)	01/01/2021	\$41.02	\$8.25	\$22.75	\$0.00	\$72.02
---------------------------------------	------------	---------	--------	---------	--------	---------

PAINTERS LOCAL 35 - ZONE 2

Classification

Effective Date Base Wage Health Pension Supplemental Unemployment Total Rate

Apprentice - PAINTER Local 35 Zone 2 - Spray/Sandblast - Repaint

Effective Date - 01/01/2021

Step	percent	Apprentice Base Wage	Health	Pension	Supplemental Unemployment	Total Rate
1	50	\$20.51	\$8.25	\$0.00	\$0.00	\$28.76
2	55	\$22.56	\$8.25	\$6.16	\$0.00	\$36.97
3	60	\$24.61	\$8.25	\$6.72	\$0.00	\$39.58
4	65	\$26.66	\$8.25	\$7.28	\$0.00	\$42.19
5	70	\$28.71	\$8.25	\$19.39	\$0.00	\$56.35
6	75	\$30.77	\$8.25	\$19.95	\$0.00	\$58.97
7	80	\$32.82	\$8.25	\$20.51	\$0.00	\$61.58
8	90	\$36.92	\$8.25	\$21.63	\$0.00	\$66.80

Notes:

Steps are 750 hrs.

Apprentice to Journeyworker Ratio:1:1

Painter / Taper (BRUSH, NEW) *	01/01/2021	\$41.56	\$8.25	\$22.75	\$0.00	\$72.56
--------------------------------	------------	---------	--------	---------	--------	---------

* If 30% or more of surfaces to be painted are new construction, NEW paint rate shall be used. PAINTERS LOCAL 35 - ZONE 2

Apprentice - PAINTER - Local 35 Zone 2 - BRUSH NEW

Effective Date - 01/01/2021

Step	percent	Apprentice Base Wage	Health	Pension	Supplemental Unemployment	Total Rate
1	50	\$20.78	\$8.25	\$0.00	\$0.00	\$29.03
2	55	\$22.86	\$8.25	\$6.16	\$0.00	\$37.27
3	60	\$24.94	\$8.25	\$6.72	\$0.00	\$39.91
4	65	\$27.01	\$8.25	\$7.28	\$0.00	\$42.54
5	70	\$29.09	\$8.25	\$19.39	\$0.00	\$56.73
6	75	\$31.17	\$8.25	\$19.95	\$0.00	\$59.37
7	80	\$33.25	\$8.25	\$20.51	\$0.00	\$62.01
8	90	\$37.40	\$8.25	\$21.63	\$0.00	\$67.28

Notes:

Steps are 750 hrs.

Apprentice to Journeyworker Ratio:1:1

Painter / Taper (BRUSH, REPAINT)	01/01/2021	\$39.62	\$8.25	\$22.75	\$0.00	\$70.62
----------------------------------	------------	---------	--------	---------	--------	---------

PAINTERS LOCAL 35 - ZONE 2

Classification

Effective Date Base Wage Health Pension Supplemental Unemployment Total Rate

Apprentice - PAINTER Local 35 Zone 2 - BRUSH REPAINT

Effective Date - 01/01/2021

Step	percent	Apprentice Base Wage	Health	Pension	Supplemental Unemployment	Total Rate
1	50	\$19.81	\$8.25	\$0.00	\$0.00	\$28.06
2	55	\$21.79	\$8.25	\$6.16	\$0.00	\$36.20
3	60	\$23.77	\$8.25	\$6.72	\$0.00	\$38.74
4	65	\$25.75	\$8.25	\$7.28	\$0.00	\$41.28
5	70	\$27.73	\$8.25	\$19.39	\$0.00	\$55.37
6	75	\$29.72	\$8.25	\$19.95	\$0.00	\$57.92
7	80	\$31.70	\$8.25	\$20.51	\$0.00	\$60.46
8	90	\$35.66	\$8.25	\$21.63	\$0.00	\$65.54

Notes:

Steps are 750 hrs.

Apprentice to Journeyworker Ratio:1:1

PAINTER TRAFFIC MARKINGS (HEAVY/HIGHWAY)	06/01/2021	\$35.00	\$8.60	\$16.64	\$0.00	\$60.24
LABORERS - ZONE 2 (HEAVY & HIGHWAY)	12/01/2021	\$35.91	\$8.60	\$16.64	\$0.00	\$61.15

For apprentice rates see "Apprentice- LABORER (Heavy and Highway)

PANEL & PICKUP TRUCKS DRIVER	08/01/2021	\$35.78	\$13.41	\$14.82	\$0.00	\$64.01
TEAMSTERS JOINT COUNCIL NO. 10 ZONE B	12/01/2021	\$35.78	\$13.41	\$16.01	\$0.00	\$65.20

PIER AND DOCK CONSTRUCTOR (UNDERPINNING AND DECK)	08/01/2020	\$49.07	\$9.40	\$23.12	\$0.00	\$81.59
---	------------	---------	--------	---------	--------	---------

PILE DRIVER LOCAL 56 (ZONE 1)

For apprentice rates see "Apprentice- PILE DRIVER"

PILE DRIVER	08/01/2020	\$49.07	\$9.40	\$23.12	\$0.00	\$81.59
PILE DRIVER LOCAL 56 (ZONE 1)						

Apprentice - PILE DRIVER - Local 56 Zone 1

Effective Date - 08/01/2020

Step	percent	Apprentice Base Wage	Health	Pension	Supplemental Unemployment	Total Rate
1	50	\$24.54	\$9.40	\$23.12	\$0.00	\$57.06
2	60	\$29.44	\$9.40	\$23.12	\$0.00	\$61.96
3	70	\$34.35	\$9.40	\$23.12	\$0.00	\$66.87
4	75	\$36.80	\$9.40	\$23.12	\$0.00	\$69.32
5	80	\$39.26	\$9.40	\$23.12	\$0.00	\$71.78
6	80	\$39.26	\$9.40	\$23.12	\$0.00	\$71.78
7	90	\$44.16	\$9.40	\$23.12	\$0.00	\$76.68
8	90	\$44.16	\$9.40	\$23.12	\$0.00	\$76.68

Notes:

% Indentured After 10/1/17; 45/45/55/55/70/70/80/80
Step 1&2 \$34.01/ 3&4 \$41.46/ 5&6 \$62.80/ 7&8 \$69.25

Apprentice to Journeyworker Ratio:1:5

Classification	Effective Date	Base Wage	Health	Pension	Supplemental Unemployment	Total Rate
PIPELAYER <i>LABORERS - ZONE 2</i>	06/01/2021	\$35.25	\$8.60	\$16.64	\$0.00	\$60.49
	12/01/2021	\$36.16	\$8.60	\$16.64	\$0.00	\$61.40
	06/01/2022	\$37.06	\$8.60	\$16.64	\$0.00	\$62.30
	12/01/2022	\$37.91	\$8.60	\$16.64	\$0.00	\$63.15
	06/01/2023	\$38.81	\$8.60	\$16.64	\$0.00	\$64.05
	12/01/2023	\$39.71	\$8.60	\$16.64	\$0.00	\$64.95
For apprentice rates see "Apprentice- LABORER"						
PIPELAYER (HEAVY & HIGHWAY) <i>LABORERS - ZONE 2 (HEAVY & HIGHWAY)</i>	06/01/2021	\$35.25	\$8.60	\$16.64	\$0.00	\$60.49
	12/01/2021	\$36.16	\$8.60	\$16.64	\$0.00	\$61.40
For apprentice rates see "Apprentice- LABORER (Heavy and Highway)"						
PLUMBER & PIPEFITTER <i>PLUMBERS & PIPEFITTERS LOCAL 51</i>	08/30/2021	\$46.49	\$10.15	\$19.95	\$0.00	\$76.59

Apprentice - PLUMBER/PIPEFITTER - Local 51

Effective Date - 08/30/2021

Step	percent	Apprentice Base Wage	Health	Pension	Supplemental Unemployment	Total Rate
1	40	\$18.60	\$10.15	\$2.50	\$0.00	\$31.25
2	50	\$23.25	\$10.15	\$2.50	\$0.00	\$35.90
3	60	\$27.89	\$10.15	\$8.80	\$0.00	\$46.84
4	70	\$32.54	\$10.15	\$14.08	\$0.00	\$56.77
5	80	\$37.19	\$10.15	\$17.60	\$0.00	\$64.94

Notes:

Steps 2000hrs. Prior 9/1/05; 40/40/45/50/55/60/65/75/80/85

Apprentice to Journeyworker Ratio:1:3

PNEUMATIC CONTROLS (TEMP.) <i>PLUMBERS & PIPEFITTERS LOCAL 51</i>	08/30/2021	\$46.49	\$10.15	\$19.95	\$0.00	\$76.59
For apprentice rates see "Apprentice- PIPEFITTER" or "PLUMBER/PIPEFITTER"						
PNEUMATIC DRILL/TOOL OPERATOR <i>LABORERS - ZONE 2</i>	06/01/2021	\$35.25	\$8.60	\$16.64	\$0.00	\$60.49
	12/01/2021	\$36.16	\$8.60	\$16.64	\$0.00	\$61.40
	06/01/2022	\$37.06	\$8.60	\$16.64	\$0.00	\$62.30
	12/01/2022	\$37.91	\$8.60	\$16.64	\$0.00	\$63.15
	06/01/2023	\$38.81	\$8.60	\$16.64	\$0.00	\$64.05
	12/01/2023	\$39.71	\$8.60	\$16.64	\$0.00	\$64.95
For apprentice rates see "Apprentice- LABORER"						
PNEUMATIC DRILL/TOOL OPERATOR (HEAVY & HIGHWAY) <i>LABORERS - ZONE 2 (HEAVY & HIGHWAY)</i>	06/01/2021	\$35.25	\$8.60	\$16.64	\$0.00	\$60.49
	12/01/2021	\$36.16	\$8.60	\$16.64	\$0.00	\$61.40
For apprentice rates see "Apprentice- LABORER (Heavy and Highway)"						
POWDERMAN & BLASTER <i>LABORERS - ZONE 2</i>	06/01/2021	\$36.00	\$8.60	\$16.64	\$0.00	\$61.24
	12/01/2021	\$36.91	\$8.60	\$16.64	\$0.00	\$62.15
	06/01/2022	\$37.81	\$8.60	\$16.64	\$0.00	\$63.05
	12/01/2022	\$38.66	\$8.60	\$16.64	\$0.00	\$63.90
	06/01/2023	\$39.56	\$8.60	\$16.64	\$0.00	\$64.80
	12/01/2023	\$40.46	\$8.60	\$16.64	\$0.00	\$65.70
For apprentice rates see "Apprentice- LABORER"						

Classification	Effective Date	Base Wage	Health	Pension	Supplemental Unemployment	Total Rate
POWDERMAN & BLASTER (HEAVY & HIGHWAY) <i>LABORERS - ZONE 2 (HEAVY & HIGHWAY)</i>	06/01/2021	\$36.00	\$8.60	\$16.64	\$0.00	\$61.24
	12/01/2021	\$36.91	\$8.60	\$16.64	\$0.00	\$62.15
For apprentice rates see "Apprentice- LABORER (Heavy and Highway)						
POWER SHOVEL/DERRICK/TRENCHING MACHINE <i>OPERATING ENGINEERS LOCAL 4</i>	06/01/2021	\$50.73	\$13.75	\$15.80	\$0.00	\$80.28
	12/01/2021	\$51.88	\$13.75	\$15.80	\$0.00	\$81.43
For apprentice rates see "Apprentice- OPERATING ENGINEERS"						
PUMP OPERATOR (CONCRETE) <i>OPERATING ENGINEERS LOCAL 4</i>	06/01/2021	\$50.73	\$13.75	\$15.80	\$0.00	\$80.28
	12/01/2021	\$51.88	\$13.75	\$15.80	\$0.00	\$81.43
For apprentice rates see "Apprentice- OPERATING ENGINEERS"						
PUMP OPERATOR (DEWATERING, OTHER) <i>OPERATING ENGINEERS LOCAL 4</i>	06/01/2021	\$33.40	\$13.75	\$15.80	\$0.00	\$62.95
	12/01/2021	\$34.19	\$13.75	\$15.80	\$0.00	\$63.74
For apprentice rates see "Apprentice- OPERATING ENGINEERS"						
READY-MIX CONCRETE DRIVER <i>TEAMSTERS 170 - Dauphinis (Bellingham)</i>	01/01/2021	\$25.00	\$9.31	\$3.20	\$0.00	\$37.51
	12/01/2021	\$25.75	\$9.76	\$4.00	\$0.00	\$39.51
	01/01/2022	\$25.75	\$9.76	\$4.00	\$0.00	\$39.51
	12/01/2022	\$26.40	\$10.26	\$4.75	\$0.00	\$41.41
	01/01/2023	\$26.40	\$10.26	\$4.75	\$0.00	\$41.41
	12/01/2023	\$27.00	\$10.76	\$5.45	\$0.00	\$43.21
	01/01/2024	\$27.00	\$10.76	\$5.45	\$0.00	\$43.21
	12/01/2024	\$27.60	\$11.26	\$6.15	\$0.00	\$45.01
	01/01/2025	\$27.60	\$11.26	\$6.15	\$0.00	\$45.01
RECLAIMERS <i>OPERATING ENGINEERS LOCAL 4</i>	06/01/2021	\$50.19	\$13.75	\$15.80	\$0.00	\$79.74
	12/01/2021	\$51.33	\$13.75	\$15.80	\$0.00	\$80.88
For apprentice rates see "Apprentice- OPERATING ENGINEERS"						
RIDE-ON MOTORIZED BUGGY OPERATOR <i>LABORERS - ZONE 2</i>	06/01/2021	\$35.25	\$8.60	\$16.64	\$0.00	\$60.49
	12/01/2021	\$36.16	\$8.60	\$16.64	\$0.00	\$61.40
	06/01/2022	\$37.06	\$8.60	\$16.64	\$0.00	\$62.30
	12/01/2022	\$37.91	\$8.60	\$16.64	\$0.00	\$63.15
	06/01/2023	\$38.81	\$8.60	\$16.64	\$0.00	\$64.05
	12/01/2023	\$39.71	\$8.60	\$16.64	\$0.00	\$64.95
For apprentice rates see "Apprentice- LABORER"						
ROLLER/SPREADER/MULCHING MACHINE <i>OPERATING ENGINEERS LOCAL 4</i>	06/01/2021	\$50.19	\$13.75	\$15.80	\$0.00	\$79.74
	12/01/2021	\$51.33	\$13.75	\$15.80	\$0.00	\$80.88
For apprentice rates see "Apprentice- OPERATING ENGINEERS"						
ROOFER (Inc.Roofing Waterproofing &Roofing Damproofg) <i>ROOFERS LOCAL 33</i>	08/01/2021	\$47.03	\$12.28	\$18.15	\$0.00	\$77.46
	02/01/2022	\$48.46	\$12.28	\$18.15	\$0.00	\$78.89

Classification

Effective Date Base Wage Health Pension Supplemental Unemployment Total Rate

Apprentice - ROOFER - Local 33

Effective Date - 08/01/2021

Step	percent	Apprentice Base Wage	Health	Pension	Supplemental Unemployment	Total Rate
1	50	\$23.52	\$12.28	\$4.56	\$0.00	\$40.36
2	60	\$28.22	\$12.28	\$18.15	\$0.00	\$58.65
3	65	\$30.57	\$12.28	\$18.15	\$0.00	\$61.00
4	75	\$35.27	\$12.28	\$18.15	\$0.00	\$65.70
5	85	\$39.98	\$12.28	\$18.15	\$0.00	\$70.41

Effective Date - 02/01/2022

Step	percent	Apprentice Base Wage	Health	Pension	Supplemental Unemployment	Total Rate
1	50	\$24.23	\$12.28	\$4.56	\$0.00	\$41.07
2	60	\$29.08	\$12.28	\$18.15	\$0.00	\$59.51
3	65	\$31.50	\$12.28	\$18.15	\$0.00	\$61.93
4	75	\$36.35	\$12.28	\$18.15	\$0.00	\$66.78
5	85	\$41.19	\$12.28	\$18.15	\$0.00	\$71.62

Notes: ** 1:5, 2:6-10, the 1:10; Reroofing: 1:4, then 1:1
 Step 1 is 2000 hrs.; Steps 2-5 are 1000 hrs.
 (Hot Pitch Mechanics' receive \$1.00 hr. above ROOFER)

Apprentice to Journeyworker Ratio:**

ROOFER SLATE / TILE / PRECAST CONCRETE ROOFERS LOCAL 33	08/01/2021	\$47.28	\$12.28	\$18.15	\$0.00	\$77.71
	02/01/2022	\$48.71	\$12.28	\$18.15	\$0.00	\$79.14
For apprentice rates see "Apprentice- ROOFER"						
SHEETMETAL WORKER SHEETMETAL WORKERS LOCAL 17 - A	08/01/2021	\$51.95	\$13.80	\$25.60	\$2.74	\$94.09
	02/01/2022	\$53.70	\$13.80	\$25.60	\$2.79	\$95.89

Classification

Effective Date Base Wage Health Pension Supplemental Unemployment Total Rate

Apprentice - SHEET METAL WORKER - Local 17-A

Effective Date - 08/01/2021

Step	percent	Apprentice Base Wage	Health	Pension	Supplemental Unemployment	Total Rate
1	42	\$21.82	\$13.80	\$6.01	\$0.00	\$41.63
2	42	\$21.82	\$13.80	\$6.01	\$0.00	\$41.63
3	47	\$24.42	\$13.80	\$11.26	\$1.48	\$50.96
4	47	\$24.42	\$13.80	\$11.26	\$1.48	\$50.96
5	52	\$27.01	\$13.80	\$12.23	\$1.59	\$54.63
6	52	\$27.01	\$13.80	\$12.48	\$1.60	\$54.89
7	60	\$31.17	\$13.80	\$13.87	\$1.77	\$60.61
8	65	\$33.77	\$13.80	\$14.84	\$1.87	\$64.28
9	75	\$38.96	\$13.80	\$16.77	\$2.09	\$71.62
10	85	\$44.16	\$13.80	\$18.20	\$2.28	\$78.44

Effective Date - 02/01/2022

Step	percent	Apprentice Base Wage	Health	Pension	Supplemental Unemployment	Total Rate
1	42	\$22.55	\$13.80	\$6.01	\$0.00	\$42.36
2	42	\$22.55	\$13.80	\$6.01	\$0.00	\$42.36
3	47	\$25.24	\$13.80	\$11.26	\$1.51	\$51.81
4	47	\$25.24	\$13.80	\$11.26	\$1.51	\$51.81
5	52	\$27.92	\$13.80	\$12.23	\$1.62	\$55.57
6	52	\$27.92	\$13.80	\$12.48	\$1.63	\$55.83
7	60	\$32.22	\$13.80	\$13.87	\$1.80	\$61.69
8	65	\$34.91	\$13.80	\$14.84	\$1.91	\$65.46
9	75	\$40.28	\$13.80	\$16.77	\$2.13	\$72.98
10	85	\$45.65	\$13.80	\$18.20	\$2.33	\$79.98

Notes:
Steps are 6 mos.

Apprentice to Journeyworker Ratio:1:4

SPECIALIZED EARTH MOVING EQUIP < 35 TONS TEAMSTERS JOINT COUNCIL NO. 10 ZONE B	08/01/2021	\$36.24	\$13.41	\$14.82	\$0.00	\$64.47
	12/01/2021	\$36.24	\$13.41	\$16.01	\$0.00	\$65.66
SPECIALIZED EARTH MOVING EQUIP > 35 TONS TEAMSTERS JOINT COUNCIL NO. 10 ZONE B	08/01/2021	\$36.53	\$13.41	\$14.82	\$0.00	\$64.76
	12/01/2021	\$36.53	\$13.41	\$16.01	\$0.00	\$65.95
SPRINKLER FITTER SPRINKLER FITTERS LOCAL 550 - (Section A) Zone 1	03/01/2021	\$62.45	\$10.00	\$21.25	\$0.00	\$93.70

Classification

Effective Date Base Wage Health Pension Supplemental Unemployment Total Rate

Apprentice - SPRINKLER FITTER - Local 550 (Section A) Zone 1

Effective Date - 03/01/2021

Step	percent	Apprentice Base Wage	Health	Pension	Supplemental Unemployment	Total Rate
1	35	\$21.86	\$10.00	\$11.99	\$0.00	\$43.85
2	40	\$24.98	\$10.00	\$12.70	\$0.00	\$47.68
3	45	\$28.10	\$10.00	\$13.41	\$0.00	\$51.51
4	50	\$31.23	\$10.00	\$14.13	\$0.00	\$55.36
5	55	\$34.35	\$10.00	\$14.84	\$0.00	\$59.19
6	60	\$37.47	\$10.00	\$15.55	\$0.00	\$63.02
7	65	\$40.59	\$10.00	\$16.26	\$0.00	\$66.85
8	70	\$43.72	\$10.00	\$16.98	\$0.00	\$70.70
9	75	\$46.84	\$10.00	\$17.69	\$0.00	\$74.53
10	80	\$49.96	\$10.00	\$18.40	\$0.00	\$78.36

Notes: Apprentice entered prior 9/30/10:
40/45/50/55/60/65/70/75/80/85
Steps are 850 hours

Apprentice to Journeyworker Ratio:1:3

STEAM BOILER OPERATOR <i>OPERATING ENGINEERS LOCAL 4</i>	06/01/2021	\$50.19	\$13.75	\$15.80	\$0.00	\$79.74
	12/01/2021	\$51.33	\$13.75	\$15.80	\$0.00	\$80.88
For apprentice rates see "Apprentice- OPERATING ENGINEERS"						
TAMPERS, SELF-PROPELLED OR TRACTOR DRAWN <i>OPERATING ENGINEERS LOCAL 4</i>	06/01/2021	\$50.19	\$13.75	\$15.80	\$0.00	\$79.74
	12/01/2021	\$51.33	\$13.75	\$15.80	\$0.00	\$80.88
For apprentice rates see "Apprentice- OPERATING ENGINEERS"						
TELECOMMUNICATION TECHNICIAN <i>ELECTRICIANS LOCAL 223</i>	09/01/2020	\$36.86	\$10.90	\$12.45	\$0.00	\$60.21

Apprentice - TELECOMMUNICATION TECHNICIAN - Local 223

Effective Date - 09/01/2020

Step	percent	Apprentice Base Wage	Health	Pension	Supplemental Unemployment	Total Rate
1	0	\$0.00	\$0.00	\$0.00	\$0.00	\$0.00

Notes: See Electrician Apprentice Wages

Telecom Apprentice Wages shall be the same as the Electrician Apprentice Wages

Apprentice to Journeyworker Ratio:2:3***

TERRAZZO FINISHERS <i>BRICKLAYERS LOCAL 3 - MARBLE & TILE</i>	08/01/2021	\$56.09	\$11.39	\$22.25	\$0.00	\$89.73
	02/01/2022	\$56.68	\$11.39	\$22.25	\$0.00	\$90.32

Classification

Effective Date Base Wage Health Pension Supplemental Unemployment Total Rate

Apprentice - TERRAZZO FINISHER - Local 3 Marble & Tile

Effective Date - 08/01/2021

Step	percent	Apprentice Base Wage	Health	Pension	Supplemental Unemployment	Total Rate
1	50	\$28.05	\$11.39	\$22.25	\$0.00	\$61.69
2	60	\$33.65	\$11.39	\$22.25	\$0.00	\$67.29
3	70	\$39.26	\$11.39	\$22.25	\$0.00	\$72.90
4	80	\$44.87	\$11.39	\$22.25	\$0.00	\$78.51
5	90	\$50.48	\$11.39	\$22.25	\$0.00	\$84.12

Effective Date - 02/01/2022

Step	percent	Apprentice Base Wage	Health	Pension	Supplemental Unemployment	Total Rate
1	50	\$28.34	\$11.39	\$22.25	\$0.00	\$61.98
2	60	\$34.01	\$11.39	\$22.25	\$0.00	\$67.65
3	70	\$39.68	\$11.39	\$22.25	\$0.00	\$73.32
4	80	\$45.34	\$11.39	\$22.25	\$0.00	\$78.98
5	90	\$51.01	\$11.39	\$22.25	\$0.00	\$84.65

Notes:

Apprentice to Journeyworker Ratio:1:3

TEST BORING DRILLER <i>LABORERS - FOUNDATION AND MARINE</i>	06/01/2021	\$42.07	\$8.60	\$17.72	\$0.00	\$68.39
	12/01/2021	\$43.08	\$8.60	\$17.72	\$0.00	\$69.40
For apprentice rates see "Apprentice- LABORER"						
TEST BORING DRILLER HELPER <i>LABORERS - FOUNDATION AND MARINE</i>	06/01/2021	\$40.79	\$8.60	\$17.72	\$0.00	\$67.11
	12/01/2021	\$41.80	\$8.60	\$17.72	\$0.00	\$68.12
For apprentice rates see "Apprentice- LABORER"						
TEST BORING LABORER <i>LABORERS - FOUNDATION AND MARINE</i>	06/01/2021	\$40.67	\$8.60	\$17.72	\$0.00	\$66.99
	12/01/2021	\$41.68	\$8.60	\$17.72	\$0.00	\$68.00
For apprentice rates see "Apprentice- LABORER"						
TRACTORS/PORTABLE STEAM GENERATORS <i>OPERATING ENGINEERS LOCAL 4</i>	06/01/2021	\$50.19	\$13.75	\$15.80	\$0.00	\$79.74
	12/01/2021	\$51.33	\$13.75	\$15.80	\$0.00	\$80.88
For apprentice rates see "Apprentice- OPERATING ENGINEERS"						
TRAILERS FOR EARTH MOVING EQUIPMENT <i>TEAMSTERS JOINT COUNCIL NO. 10 ZONE B</i>	08/01/2021	\$36.82	\$13.41	\$14.82	\$0.00	\$65.05
	12/01/2021	\$36.82	\$13.41	\$16.01	\$0.00	\$66.24
TUNNEL WORK - COMPRESSED AIR <i>LABORERS (COMPRESSED AIR)</i>	06/01/2021	\$52.90	\$8.60	\$18.17	\$0.00	\$79.67
	12/01/2021	\$53.91	\$8.60	\$18.17	\$0.00	\$80.68
For apprentice rates see "Apprentice- LABORER"						
TUNNEL WORK - COMPRESSED AIR (HAZ. WASTE) <i>LABORERS (COMPRESSED AIR)</i>	06/01/2021	\$54.90	\$8.60	\$18.17	\$0.00	\$81.67
	12/01/2021	\$55.91	\$8.60	\$18.17	\$0.00	\$82.68
For apprentice rates see "Apprentice- LABORER"						
TUNNEL WORK - FREE AIR <i>LABORERS (FREE AIR TUNNEL)</i>	06/01/2021	\$44.97	\$8.60	\$18.17	\$0.00	\$71.74
	12/01/2021	\$45.98	\$8.60	\$18.17	\$0.00	\$72.75
For apprentice rates see "Apprentice- LABORER"						
TUNNEL WORK - FREE AIR (HAZ. WASTE) <i>LABORERS (FREE AIR TUNNEL)</i>	06/01/2021	\$46.97	\$8.60	\$18.17	\$0.00	\$73.74
	12/01/2021	\$47.98	\$8.60	\$18.17	\$0.00	\$74.75

Classification	Effective Date	Base Wage	Health	Pension	Supplemental Unemployment	Total Rate
For apprentice rates see "Apprentice- LABORER"						
VAC-HAUL <i>TEAMSTERS JOINT COUNCIL NO. 10 ZONE B</i>	08/01/2021	\$36.24	\$13.41	\$14.82	\$0.00	\$64.47
	12/01/2021	\$36.24	\$13.41	\$16.01	\$0.00	\$65.66
WAGON DRILL OPERATOR <i>LABORERS - ZONE 2</i>	06/01/2021	\$35.25	\$8.60	\$16.64	\$0.00	\$60.49
	12/01/2021	\$36.16	\$8.60	\$16.64	\$0.00	\$61.40
	06/01/2022	\$37.06	\$8.60	\$16.64	\$0.00	\$62.30
	12/01/2022	\$37.91	\$8.60	\$16.64	\$0.00	\$63.15
	06/01/2023	\$38.81	\$8.60	\$16.64	\$0.00	\$64.05
	12/01/2023	\$39.71	\$8.60	\$16.64	\$0.00	\$64.95
For apprentice rates see "Apprentice- LABORER"						
WAGON DRILL OPERATOR (HEAVY & HIGHWAY) <i>LABORERS - ZONE 2 (HEAVY & HIGHWAY)</i>	06/01/2021	\$35.25	\$8.60	\$16.64	\$0.00	\$60.49
	12/01/2021	\$36.16	\$8.60	\$16.64	\$0.00	\$61.40
For apprentice rates see "Apprentice- LABORER (Heavy and Highway)"						
WASTE WATER PUMP OPERATOR <i>OPERATING ENGINEERS LOCAL 4</i>	06/01/2021	\$50.73	\$13.75	\$15.80	\$0.00	\$80.28
	12/01/2021	\$51.88	\$13.75	\$15.80	\$0.00	\$81.43
For apprentice rates see "Apprentice- OPERATING ENGINEERS"						
WATER METER INSTALLER <i>PLUMBERS & PIPEFITTERS LOCAL 51</i>	08/30/2021	\$46.49	\$10.15	\$19.95	\$0.00	\$76.59
For apprentice rates see "Apprentice- PLUMBER/PIPEFITTER" or "PLUMBER/GASFITTER"						
Outside Electrical - East						
CABLE TECHNICIAN (Power Zone) <i>OUTSIDE ELECTRICAL WORKERS - EAST LOCAL 104</i>	08/30/2020	\$29.67	\$9.25	\$1.89	\$0.00	\$40.81
For apprentice rates see "Apprentice- LINEMAN"						
CABLEMAN (Underground Ducts & Cables) <i>OUTSIDE ELECTRICAL WORKERS - EAST LOCAL 104</i>	08/30/2020	\$42.03	\$9.25	\$10.27	\$0.00	\$61.55
For apprentice rates see "Apprentice- LINEMAN"						
DRIVER / GROUNDMAN CDL <i>OUTSIDE ELECTRICAL WORKERS - EAST LOCAL 104</i>	08/30/2020	\$34.62	\$9.25	\$10.07	\$0.00	\$53.94
For apprentice rates see "Apprentice- LINEMAN"						
DRIVER / GROUNDMAN -Inexperienced (<2000 Hrs) <i>OUTSIDE ELECTRICAL WORKERS - EAST LOCAL 104</i>	08/30/2020	\$27.20	\$9.25	\$1.82	\$0.00	\$38.27
For apprentice rates see "Apprentice- LINEMAN"						
EQUIPMENT OPERATOR (Class A CDL) <i>OUTSIDE ELECTRICAL WORKERS - EAST LOCAL 104</i>	08/30/2020	\$42.03	\$9.25	\$14.35	\$0.00	\$65.63
For apprentice rates see "Apprentice- LINEMAN"						
EQUIPMENT OPERATOR (Class B CDL) <i>OUTSIDE ELECTRICAL WORKERS - EAST LOCAL 104</i>	08/30/2020	\$37.09	\$9.25	\$10.87	\$0.00	\$57.21
For apprentice rates see "Apprentice- LINEMAN"						
GROUNDMAN <i>OUTSIDE ELECTRICAL WORKERS - EAST LOCAL 104</i>	08/30/2020	\$27.20	\$9.25	\$1.82	\$0.00	\$38.27
For apprentice rates see "Apprentice- LINEMAN"						
GROUNDMAN -Inexperienced (<2000 Hrs.) <i>OUTSIDE ELECTRICAL WORKERS - EAST LOCAL 104</i>	08/30/2020	\$22.25	\$9.25	\$1.82	\$0.00	\$33.32
For apprentice rates see "Apprentice- LINEMAN"						
JOURNEYMAN LINEMAN <i>OUTSIDE ELECTRICAL WORKERS - EAST LOCAL 104</i>	08/30/2020	\$49.45	\$9.25	\$17.48	\$0.00	\$76.18

Classification

Effective Date Base Wage Health Pension Supplemental Unemployment Total Rate

Apprentice - LINEMAN (Outside Electrical) - East Local 104

Effective Date - 08/30/2020

Step	percent	Apprentice Base Wage	Health	Pension	Supplemental Unemployment	Total Rate
1	60	\$29.67	\$9.25	\$3.39	\$0.00	\$42.31
2	65	\$32.14	\$9.25	\$3.46	\$0.00	\$44.85
3	70	\$34.62	\$9.25	\$3.54	\$0.00	\$47.41
4	75	\$37.09	\$9.25	\$5.11	\$0.00	\$51.45
5	80	\$39.56	\$9.25	\$5.19	\$0.00	\$54.00
6	85	\$42.03	\$9.25	\$5.26	\$0.00	\$56.54
7	90	\$44.51	\$9.25	\$7.34	\$0.00	\$61.10

Notes:

Apprentice to Journeyworker Ratio:1:2

TELEDATA CABLE SPLICER <i>OUTSIDE ELECTRICAL WORKERS - EAST LOCAL 104</i>	02/04/2019	\$30.73	\$4.70	\$3.17	\$0.00	\$38.60
TELEDATA LINEMAN/EQUIPMENT OPERATOR <i>OUTSIDE ELECTRICAL WORKERS - EAST LOCAL 104</i>	02/04/2019	\$28.93	\$4.70	\$3.14	\$0.00	\$36.77
TELEDATA WIREMAN/INSTALLER/TECHNICIAN <i>OUTSIDE ELECTRICAL WORKERS - EAST LOCAL 104</i>	02/04/2019	\$28.93	\$4.70	\$3.14	\$0.00	\$36.77

Additional Apprentice Information:

Minimum wage rates for apprentices employed on public works projects are listed above as a percentage of the pre-determined hourly wage rate established by the Commissioner under the provisions of the M.G.L. c. 149, ss. 26-27D. Apprentice ratios are established by the Division of Apprenticeship Training pursuant to M.G.L. c. 23, ss. 11E-11L.

All apprentices must be registered with the Division of Apprenticeship Training in accordance with M.G.L. c. 23, ss. 11E-11L.

All steps are six months (1000 hours.)
Ratios are expressed in allowable number of apprentices to journeymen or fraction thereof, unless otherwise specified.

** Multiple ratios are listed in the comment field.
*** APP to JM; 1:1, 2:2, 2:3, 3:4, 4:4, 4:5, 4:6, 5:7, 6:7, 6:8, 6:9, 7:10, 8:10, 8:11, 8:12, 9:13, 10:13, 10:14, etc.
**** APP to JM; 1:1, 1:2, 2:3, 2:4, 3:5, 4:6, 4:7, 5:8, 6:9, 6:10, 7:11, 8:12, 8:13, 9:14, 10:15, 10:16, etc.

"General Decision Number: MA20220001 01/07/2022

Superseded General Decision Number: MA20210001

State: Massachusetts

Construction Type: Building

Counties: Barnstable, Bristol, Dukes, Essex, Middlesex, Nantucket, Norfolk and Suffolk Counties in Massachusetts.

BUILDING CONSTRUCTION PROJECTS (does not include single family homes and apartments up to and including 4 stories)

Note: Contracts subject to the Davis-Bacon Act are generally required to pay at least the applicable minimum wage rate required under Executive Order 14026 or Executive Order 13658. Please note that these Executive Orders apply to covered contracts entered into by the federal government that are subject to the Davis-Bacon Act itself, but do not apply to contracts subject only to the Davis-Bacon Related Acts, including those set forth at 29 CFR 5.1(a)(2)-(60).

If the contract is entered into on or after January 30, 2022, or the contract is renewed or extended (e.g., an option is exercised) on or after January 30, 2022, Executive Order 14026 generally applies to the contract. The contractor must pay all covered workers at least \$15.00 per hour (or the applicable wage rate listed on this wage determination, if it is higher) for all hours spent performing on that contract in 2022.

If the contract was awarded on or between January 1, 2015 and January 29, 2022, and the contract is not renewed or extended on or after January 30, 2022, Executive Order 13658 generally applies to the contract. The contractor must pay all covered workers at least \$11.25 per hour (or the applicable wage rate listed on this wage determination, if it is higher) for all hours spent performing on that contract in 2022.

The applicable Executive Order minimum wage rate will be adjusted annually. If this contract is covered by one of the Executive Orders and a classification considered necessary for performance of work on the contract does not appear on this wage determination, the contractor must still submit a conformance request.

Additional information on contractor requirements and worker protections under the Executive Orders is available at www.dol.gov/whd/govcontracts.

Modi fication Number Publication Date
0 01/07/2022

ASBE0006-001 09/01/2021

	Rates	Fri nges
Insulator/asbestos worker Includes the application of all insulating materials, protective coverings, coatings, and finishes to all types of mechanical systems		
(ZONE A).....	\$ 50.00	32.89
(ZONE B).....	\$ 50.00	32.89

ZONES:

ZONE A

BARNSTABLE COUNTY (Brewster, Chatham, Dennis, Eastham, Harwich, Orleans, Provincetown, Truro, Wellfleet, Yarmouth)
BRISTOL COUNTY (Easton), MIDDLESEX COUNTY, and NORFOLK COUNTY (Avon, Braintree, Brookline, Canton, Cohasset, Dedham, Dover, Foxborough, Holbrook, Medfield, Medway, Millis, Milton, Needham, Norfolk, Norwood, Quincy, Randolph, Sharon, Stoughton, Walpole, Wellesley, Westwood, Weymouth)

ZONE B

BARNSTABLE COUNTY (Barnstable, Bourne, Falmouth, Mashpee, Sandwich), BRISTOL COUNTY (All cities except Easton), and NORFOLK COUNTY (Bellingham, Franklin, Plainville)

ASBE0006-002 09/01/2021

BARNSTABLE (Brewster, Chatham, Dennis, Eastham, Harwich, Orleans, Provincetown, Truro, Wellfleet and Yarmouth); BRISTOL (Easton); ESSEX; MIDDLESEX; NORFOLK (Avon, Braintree, Brookline, Canton, Cohasset, Dedham, Dover, Foxboro, Holbrook, Hull, Medfield, Medway, Millis, Milton, Needham, Norfolk, Norwood, Quincy, Randolph, Sharon Stoughton, Walpole, Wellesley, Westwood, and Weymouth) AND SUFFOLK COUNTIES

	Rates	Fri nges
HAZARDOUS MATERIAL HANDLER (Includes preparati on,		

wetting, stripping, removal, scrapping, vacuuming, bagging and disposing of all insulation materials from mechanical systems whether they contain asbestos or not).... \$ 40.00 33.04

ASBE0006-010 09/01/2021

BARNSTABLE (Barnstable, Bourne, Falmouth, Mashpee and Sandwich); BRISTOL (Acushnet, Attleboro city, Berkeley, Dartmouth, Dighton, Fairhaven, Fall river City, Freetown, Marion, Mansfield, New Bedford City, North Attleboro, Norton, Raynham, Rehoboth, Seekonk, Somerset, Swansea, Taunton City and Westport); DUKES; NANTUCKET; NORFOLK (Bellingham, Franklin, Plainville, and Wrentham); PLYMOUTH (Lakeville, Mattapoisett, Middlboro, Rochester and Wareham)

Rates Fringes

Insulator/asbestos worker (Includes the application of all insulating materials, protective coverings, coatings and finishes to all types of mechanical systems.).... \$ 50.00 32.89

BOIL0029-001 01/01/2021

Rates Fringes

BOILERMAKER..... \$ 45.87 29.02

BRMA0001-008 02/01/2021

FOXBORO CHAPTER
BRISTOL (Attleboro, Berkley, Dighton, Mansfield, North Attleboro, Norton, Raynham, Rehoboth, Seekonk, Taunton) AND NORFOLK (Bellingham, Canton, Dedham, Foxboro, Franklin, Norfolk, Norwood, Plainville, Sharon, Walpole, Westwood, Wrentham) COUNTIES

Rates Fringes

Bricklayer, Cement Mason, Plasterer..... \$ 53.61 35.94

BRMA0001-009 02/01/2021

LOWELL CHAPTER

MIDDLESEX (Acton, Asby, Ayer, Bedford, Billerica, Boxboro, Carlisle, Chemsford, Dracut, Dunstable, Ft. Denvens, Groton, Littleton, Lowell, North Acton, Pepperell, Shirley, South Acton, Tewksbury, Townsend, Tyngsboro, West Acton, Westford, Wilmingon)

	Rates	Fringes
Bricklayer and plasterer.....	\$ 53.61	35.94

BRMA0001-010 08/01/2020

LOWELL CHAPTER

MIDDLESEX (Ashland, Framingham, Holliston, Hopkinton, Hudson, Maynard, Natick, Sherborn, Stow); and NORFOLK (Medfield, Medway, Millis)

	Rates	Fringes
BRICKLAYER.....	\$ 53.16	34.95

BRMA0003-001 02/01/2021

	Rates	Fringes
Marble & Tile Finisher.....	\$ 42.57	32.00
Marble, Tile & Terrazzo Workers.....	\$ 54.69	33.80
TERRAZZO FINISHER.....	\$ 55.77	34.47

BRMA0003-003 02/01/2021

BOSTON CHAPTER

MIDDLESEX (Arlington, Cambridge, Everett, Malden, Medford, Melrose, Somerville); NORFOLK (Brookline, Milton); and SUFFOLK

	Rates	Fringes
BRICKLAYER.....	\$ 55.75	35.85

BRMA0003-006 08/01/2021

LYNN CHAPTER

ESSEX (Amesbury, Andover, Beverly, Boxford, Danvers, Essex, Georgetown, Gloucester, Groveland, Hamilton, Haverhill, Ipswich, Lawrence, Lynn, Lynnfield, Manchester, Marblehead, Merrimac, Methuen, Middleton, Nahant, Newbury, Newburyport,

North Andover, Peabody, Rockport, Rowley, Salisbury, Salem, Saugus, Swampscott, Topsfield Wakefield, Wenham, West Newbury); and MIDDLESEX (Reading, North Reading, Wakefield)

	Rates	Fringes
Bricklayer, cement mason and plasterer.....	\$ 57.17	35.98

BRMA0003-007 08/01/2021

WALTHAM CHAPTER

MIDDLESEX (Belmont, Burlington, Concord, Lexington, Lincoln, Stoneham, Sudbury, Waltham, Watertown, Wayland, Weston, Winchester, Woburn)

	Rates	Fringes
Bricklayer and plasterer.....	\$ 57.17	35.98

BRMA0003-008 08/01/2021

NEWTON CHAPTER

MIDDLESEX (Newton) and NORFOLK (Dover, Needham, Wellesley)

	Rates	Fringes
Bricklayer, cement mason and plasterer.....	\$ 57.17	35.98

BRMA0003-009 08/01/2021

NEW BEDFORD

BARNSTABLE; BRISTOL (Acushnet, Dartmouth, Fairhaven, Fall River, Freetown, New Bedford, Somerset, Swansea, Westport); DUKES; and NANTUCKET COUNTIES

	Rates	Fringes
Bricklayer, cement mason and plasterer.....	\$ 57.17	35.98

BRMA0003-010 08/01/2021

QUINCY CHAPTER

NORFOLK COUNTY (Avon, Braintree, Cohasset, Holbrook, Quincy, Randolph, Soughton, Weymouth)

	Rates	Fringes
Bricklayer, cement mason and plasterer.....	\$ 57.17	35.98

 CARP0056-011 08/01/2021

SUFFOLK (All of County); and those areas of BARNSTABLE, BRISTOL, ESSEX, MIDDLESEX & NORFOLK COUNTIES situated inside Boston Beltway (I-495) and North of Cape Cod Canal. ALL of DUKES AND NANTUCKET COUNTIES

	Rates	Fringes
PILED RIVERMAN.....	\$ 50.74	33.66

 CARP0056-012 08/01/2020

The areas of BARNSTABLE, BRISTOL, and NORFOLK COUNTIES situated OUTSIDE Boston Beltway (I-495) and South of Cape Cod Canal

	Rates	Fringes
PILED RIVERMAN.....	\$ 49.07	35.57

 CARP0056-013 08/01/2021

Those areas of ESSEX and MIDDLESEX COUNTIES situated OUTSIDE Boston Beltway (I-495)

	Rates	Fringes
PILED RIVERMAN.....	\$ 44.61	33.45

 CARP0327-001 03/01/2021

MIDDLESEX (Belmont, Cambridge, Everett, Malden, Medford, Somerville); NORFOLK (Brookline, Dedham, Milton); and SUFFOLK

	Rates	Fringes
CARPENTER.....	\$ 52.38	20.78

 * CARP0339-001 09/01/2021

BRISTOL (Attleborough, North Attleborough); ESSEX; MIDDLESEX
 (Except Belmont, Cambridge, Everett, Malden, Medford,
 Somerville); AND NORFOLK (Bellingham, Canton, Foxboro,
 Franklin, Medfield, Medway, Millis, Needham, Norfolk, Norwood,
 Plainville, Sharon, Walpole, Wellesley, Westwood, Wrentham)

	Rates	Fringes
CARPENTER.....	\$ 44.18	29.27

 CARP0346-003 03/01/2020

NORFOLK COUNTY (Braintree, Cohasset, Scituate, Weymouth,
 Quincy)

	Rates	Fringes
CARPENTER.....	\$ 42.40	29.10

 CARP0624-005 09/01/2017

DUKES; NANTUCKET

	Rates	Fringes
CARPENTER.....	\$ 46.43	28.35

 CARP0624-007 09/01/2017

BARNSTABLE; BRISTOL (Except Attleboro & North Attleboro); AND
 NORFOLK (Avon, Holbrook, Randolph, Stoughton) COUNTIES

	Rates	Fringes
CARPENTER.....	\$ 39.28	27.90

 CARP1121-001 01/06/2020

SUFFOLK COUNTY

	Rates	Fringes
MILLWRIGHT.....	\$ 42.32	31.15

 CARP1121-003 01/06/2020

BARNSTABLE, BRISTOL, DUKES, ESSEX, MIDDLESEX, NANTUCKET and
 NORFOLK COUNTIES

	Rates	Fringes
MILLWRIGHT.....	\$ 38.47	31.15

* CARP2168-001 09/01/2021

MIDDLESEX (Belmont, Cambridge, Everett, Malden, Medford, Somerville); NORFOLK (Brookline, Dedham, Milton); and SUFFOLK

	Rates	Fringes
FLOOR LAYER: Carpet.....	\$ 53.27	29.37

* CARP2168-004 09/01/2021

BRISTOL; ESSEX; MIDDLESEX (Except Belmont, Cambridge, Everett, Malden, Medford, Somerville); Remainder of Norfolk County

	Rates	Fringes
FLOOR LAYER: Carpet.....	\$ 53.27	29.37

* CARP2168-005 09/01/2021

BARNSTABALE; DUKES; AND NANTUCKET

	Rates	Fringes
FLOOR LAYER: Carpet.....	\$ 53.27	29.37

ELEC0096-001 09/06/2021

MIDDLESEX (Ashby, Ashland, Ayer, Ft. Devens, Groton, Hopkinton, Hudson, Marlboro, Pepperell, Shirley, Stow, Townsend)

	Rates	Fringes
ELECTRICIAN.....	\$ 45.01	11%+25.01
Tel edata System Installer.....	\$ 32.85	28.12

ELEC0099-001 06/01/2021

BRISTOL (Attleboro, North Attleboro, Seekonk)

	Rates	Fringes
--	-------	---------

ELECTRICIAN.....	\$ 43.61	54.71%
Teledata System Installer.....	\$ 31.21	13.1%+14.93

ELEC0103-001 09/01/2021

ESSEX; MIDDLESEX (Excluding Ashby, Ashland, Ayer, Ft. Devens, Groton, Hopkinton, Hudson, Marlboro, Pepperell, Shirley, Stow, Townsend); NORFOLK (Excluding Avon, Holbrook, Plainville, Randolph, Stoughton) SUFFOLK

	Rates	Fringes
Teledata System Installer.....	\$ 43.40	32.02

ELEC0103-002 09/01/2021

ESSEX (Amesbury, Andover, Boxford, Georgetown, Groveland, Haverhill, Lawrence, Merrimac, Methuen, Newbury, Newburyport, North Andover, Rowley, Salisbury, West Newbury); MIDDLESEX (Bedford, Billerica, Boxboro, Burlington, Carlisle, Chelmsford, Dracut, Dunstable Littleton, Lowell, North Reading, Tewksbury, Tyngsboro, Westford, Wilmington)

	Rates	Fringes
ELECTRICIAN.....	\$ 56.36	34.39

ELEC0103-004 09/01/2021

ESSEX (Beverly, Danvers, Essex, Gloucester, Hamilton, Ipswich, Manchester, Marblehead, Middleton, Peabody, Rockport, Salem, Topsfield, Wenham)

	Rates	Fringes
ELECTRICIAN.....	\$ 56.36	34.39

ELEC0103-005 09/01/2021

ESSEX (Lynn, Lynnfield, Nahant, Saugus, Swampscott); MIDDLESEX (Acton, Arlington, Belmont, Cambridge, Concord, Everett, Framingham, Holliston, Lexington, Lincoln, Malden, Maynard, Medford, Melrose, Natick, Newton, Reading, Sherborn, Somerville, Stoneham, Sudbury, Wakefield, Waltham, Watertown, Wayland, Weston, Winchester, Woburn); NORFOLK (Bellingham, Braintree, Brookline, Canton, Cohasset, Dedham, Dover, Foxboro, Franklin, Medfield, Medway, Millis, Milton, Needham, Norfolk, Norwood, Quincy, Sharon, Walpole, Wellesley, Westwood,

Weymouth, Wrentham); PLYMOUTH (Hingham and Hull); SUFFOLK

	Rates	Fringes
ELECTRICIAN.....	\$ 56.36	34.39

* ELEC0104-001 09/01/2021

	Rates	Fringes
Line Construction:		
Cableman.....	\$ 51.09	27.91+A
Equipment Operator.....	\$ 43.43	24.62+A
Groundman.....	\$ 28.10	11.80+A
Lineman.....	\$ 51.09	27.91+A

A. PAID HOLIDAYS: New Year's Day; Memorial Day; Independence Day; Labor Day; Thanksgiving Day; Christmas Day and Columbus Day, provided the employee has been employed 5 working days prior to any one of the listed holidays.

ELEC0223-005 09/01/2021

BARNSTABLE; BRISTOL (Except Attleboro, North Attleboro, Seekonk); DUKES; NANTUCKET AND NORFOLK (Avon, Halbrook, Plainville, Randolph, Stoughton)

	Rates	Fringes
ELECTRICIAN.....	\$ 44.27	31.18%+14.00

ELEC0223-006 09/01/2021

BARNSTABLE; BRISTOL (Except Attleboro, North Attleboro, Seekonk); DUKES; NANTUCKET AND NORFOLK (Avon, Halbrook, Plainville, Randolph, Stoughton)

	Rates	Fringes
Tel edata System Installer.....	\$ 37.63	31.09%+13.75

ELEV0004-001 01/01/2021

	Rates	Fringes
ELEVATOR MECHANIC.....	\$ 63.47	35.83

FOOTNOTE FOR ELEVATOR MECHANICS:

- a. Vacation: 6%/under 5 years based on regular hourly rate for all hours worked. 8%/over 5 years based on regular hourly rate for all hours worked.
- b. PAID HOLIDAYS: New Year's Day; Memorial Day; Independence Day; Labor Day; Veterans' Day; Thanksgiving Day; the Friday after Thanksgiving Day; and Christmas Day.

ENGI 0004-001 06/01/2020

	Rates	Fringes
Power equipment operators:		
Group 1.....	\$ 49.33	29.75
Group 2.....	\$ 48.81	29.75
Group 3.....	\$ 32.72	29.75
Group 4.....	\$ 40.30	29.75
Group 5.....	\$ 23.13	29.75
Group 6.....	\$ 27.79	29.75

FOOTNOTE FOR POWER EQUIPMENT OPERATORS:

- A. PAID HOLIDAYS: New Year's Day, Washington's Birthday, Labor Day, Memorial Day, Independence Day, Patriot's Day, Columbus Day, Veteran's Day, Thanksgiving Day, Christmas Day

HOURLY PREMIUM FOR BOOM LENGTHS (Including Jib):

- Over 150 ft. +2.18
- Over 185 ft. +3.84
- Over 210 ft. +5.39
- Over 250 ft. +8.16
- Over 295 ft. +11.29
- Over 350 ft. +13.14

POWER EQUIPMENT OPERATORS CLASSIFICATIONS

- Group 1: Crane; shovel; truck crane; cherry picker; dragline; trench hoe; backhoe; three drum machine; derrick; pile driver; elevator tower; hoist; gradall; shovel dozer; front end loader; fork lift; suger; boring machine; rotary drill; post hole hammer; post hole digger; pumpcrete machine; asphalt plant (on site); concrete batching and/or mixing plant (on site); crusher plant (on site); paving concrete mixer; timber jack
- Group 2: Sonic or vibratory hammer; grader; scraper; tandem scraper; concrete pump; bulldozer; tractor; york rake; mulching machine; portable steam boiler; portable steam generator; roller; spreader; tamper (self propelled or tractor drawn); asphalt paver; mechanic - maintenance; paving screed machine; stationary steam boiler; paving

concrete finishing machine; cal truck; ballast regulator;
 switch tamper; rail anchor machine; tire truck
 Group 3: Pumps (1-3 grouped); compressor; welding machine
 (1-3 grouped); generator; concrete vibrator; heater (power
 driven 1- 5); well point system (operating);
 syphon-pul someter; concrete mixer; valves controlling
 permanent plant air or steam; conveyor; Jackson type
 tamper; single diaphragm pump; lighting plant
 Group 4: Assistant engineer (fireman)
 Group 5: Oiler (other than truck cranes and gradalls)
 Group 6: Oiler (on truck cranes and gradalls) stant engineer
 (on truck crane and gradall)

 IRON0007-006 09/16/2021

AREA 1: BRISTOL (Easton); ESSEX (Beverly, Gloucester,
 Lynn, Lynnfield, Manchester, Marblehead, Nahant, Rockport,
 Salem, Saugus, Swampscott); MIDDLESEX (Arlington, Bedford,
 Belmont, Burlington, Cambridge, Carlisle, Concord, Dunstable,
 Everett, Framingham, Lexington, Lincoln, Malden, Maynard,
 Medford, Melrose, Natick, Newton, Reading, Sherborn,
 Somerville, Stoneham, Sudbury, Wakefield, Waltham, Watertown,
 Wayland, Weston, Winchester, Woburn); NORFOLK (Except Medway);
 SUFFOLK

AREA 2: ESSEX (Amesbury, Andover, Boxford, Danvers, Essex,
 Georgetown, Hamilton, Haverhill, Ipswich, Lawrence, Merrimac,
 Methuen, Newbury, Newburyport, North Andover, Rowley,
 Salisbury, Topsfield, Wenham, West Newbury); MIDDLESEX (Acton,
 Billerica, Chelmsford, Dracut, Groton, Groveland, Littleton,
 Lowell, Middleton, North Reading, Pepperell, Tewksbury,
 Tyngsboro, Westford, Wilmingon)

	Rates	Fringes
Ironworkers:		
AREA 1.....	\$ 50.13	34.81
AREA 2.....	\$ 45.72	34.81

 IRON0007-010 09/16/2021

MIDDLESEX (Ashby, Ashland, Ayer, Boxboro, Holliston, Hopkinton,
 Hudson, Marlboro, Shirley, Stow, Townsend); NORFOLK (Medway)

	Rates	Fringes
IRONWORKER.....	\$ 49.83	34.81

IRON0037-005 03/16/2021

BARNSTABLE; BRISTOL (Acushnet, Attleboro, Berkley, Dartmouth, Dighton, Fairhaven, Fall River, Freetown, Mansfield, New Bedford, North Attleboro, Norton, Raynham, Rehoboth, Seekonk, Somerset, Swansea, Taunton, Westport); DUKES; NANTUCKET; NORFOLK (Biltingham, Franklin, Plainville, Wrentham)

	Rates	Fringes
IRONWORKER.....	\$ 37.87	30.13

* LAB00022-001 12/01/2021

	Rates	Fringes
Laborers: (HEAVY CONSTRUCTION)		
GROUP 1.....	\$ 35.41	26.59
GROUP 2.....	\$ 35.66	26.59
GROUP 3.....	\$ 36.16	26.59
GROUP 4.....	\$ 36.41	26.59
GROUP 5.....	\$ 24.50	26.59
GROUP 6.....	\$ 37.41	26.59

LABORERS CLASSIFICATIONS

GROUP 1: Laborers; carpenter tenders; cement finisher tenders, plasterer tenders

GROUP 2: Asphalt raker; fence and guard rail erector; laser beam operator; mason tender; pipelayer; pneumatic drill operator; pneumatic tool operator; wagon drill operator, jack hammer operator, pavement breaker, carbide core drilling machine, chain saw operator, barco type jumping tampers, concrete pump, motorized mortar mixer, ride-on-motorized buggy

GROUP 3: Air track operator; block paver; rammer; curb setter, hydraulic and similar self powered drills

GROUP 4: Blaster; powderman

GROUP 5: Flagger

GROUP 6: Asbestos Abatement; Toxic and Hazardous Waste Laborers

* LAB00022-003 12/01/2021

	Rates	Fringes
Plasterer tender BARNSTABLE, BRISTOL, DUKES, ESSEX, NANTUCKET, MIDDLESEX (with the exception of Arlington, Belmont, Burlington, Cambridge, Everett, Malden, Medford, Melrose, Reading, Somerville, Stoneham, Wakefield, Winchester, Winthrop and Woburn); NORFOLK (with the exception of Brookline Dedham and Milton) COUNTIES. \$ 35.41		26.59
SUFFOLK COUNTY (Boston, Chelsea, Revere, Winthrop, Deer Island, Nut Island); MIDDLESEX COUNTY (Arlington, Belmont, Burlington, Cambridge, Everett, Malden, Medford, Melrose, Reading, Somerville, Stoneham, Wakefield, Winchester, Winthrop and Woburn only); NORFOLK COUNTY (Brookline, Dedham, and Milton only).... \$ 41.18		27.52

* LAB00022-004 12/01/2021

	Rates	Fringes
Plasterer tender..... \$ 35.41		26.59

* LAB00022-005 12/01/2021

	Rates	Fringes
Plasterer tender BARNSTABLE, BRISTOL, DUKES, ESSEX, NANTUCKET, MIDDLESEX (with the exception of Arlington, Belmont, Burlington, Cambridge, Everett, Malden, Medford, Melrose, Reading, Somerville, Stoneham, Wakefield, Winchester, Winthrop and		

Woburn); NORFOLK (with the exception of Brookline Dedham and Milton) COUNTIES. \$ 35.41 26.59
 SUFFOLK COUNTY (Boston, Chelsea, Revere, Winthrop, Deer Island, Nut Island);
 MIDDLESEX COUNTY (Arlington, Belmont, Burlington, Cambridge, Everett, Malden, Medford, Melrose, Reading, Somerville, Stoneham, Wakefield, Winchester, Winthrop and Woburn only);
 NORFOLK COUNTY (Brookline, Dedham, and Milton only).... \$ 41.18 27.52

 * LAB00022-009 12/01/2021

SUFFOLK COUNTY (Boston, Chelsea, Revere, Winthrop, Deer & Nut Islands); MIDDLESEX COUNTY (Arlington, Belmont, Burlington, Cambridge, Everett, Malden, Medford, Melrose, Reading, Somerville, Stoneham, Wakefield, Winchester, Winthrop, and Woburn only); NORFOLK COUNTY (Brookline, Dedham, and Milton only)

	Rates	Fringes
Laborers:		
GROUP 1.....	\$ 41.18	27.52
GROUP 2.....	\$ 41.43	27.56
GROUP 3.....	\$ 41.93	27.56
GROUP 4.....	\$ 42.18	27.56
GROUP 5.....	\$ 41.93	27.56
GROUP 6.....	\$ 43.18	27.52
GROUP 7.....	\$ 24.50	27.52

LABORERS CLASSIFICATIONS

GROUP 1: Laborers; Carpenter Tenders

GROUP 2: Jackhammer operator; pavement breaker; asphalt raker carbide core drilling machine; chain saw operator; pipelayer; barco type jumping tampers; laser beam; concrete pump; mason tender; motorized mortar mixer; ride-on motorized buggy; fence and beam rail erector

GROUP 3: Air track, block paver; rammer; curb setter, hydraulic and similar self-powered drills

- GROUP 4: Blaster; powderman
- GROUP 5: Pre-cast floor and roof plank erector
- GROUP 6: Asbestos removal laborers/haz-mat laborers
- GROUP 7: Flaggers

 * LAB00022-010 12/01/2021

Counties of BARNSTABLE; BRISTOL; DUKES; ESSEX; NANTUCKET; MIDDLESEX (with the exception of Arlington, Belmont, Burlington, Cambridge, Everett, Malden, Medford, Melrose, Reading, Somerville, Stoneham, Waverfield, Winchester, Winthrop and Woburn); NORFOLK (with the exception of Brookline, Dedham and Milton)

	Rates	Fringes
Laborers:		
GROUP 1.....	\$ 35.41	26.59
GROUP 2.....	\$ 35.66	26.59
GROUP 3.....	\$ 36.16	26.59
GROUP 4.....	\$ 36.41	26.59
GROUP 5.....	\$ 36.16	26.59
GROUP 6.....	\$ 37.41	26.59

LABORERS CLASSIFICATIONS

GROUP 1: Laborers; Carpenter Tenders

GROUP 2: Jackhammer operator; pavement breaker; asphalt raker carbide core drilling machine; chain saw operator; pipelayer; barco type jumping tampers; laser beam; concrete pump; mason tender; motorized mortar mixer; ride-on motorized buggy; fence and beam rail erector

GROUP 3: Air track, block paver; hammer; curb setter, hydraulic and similar self-powered drills

- GROUP 4: Blaster; powderman
- GROUP 5: Pre-cast floor and roof plank erector
- GROUP 6: Asbestos removal laborers/haz-mat laborers

 * LAB01421-004 12/01/2021

BARNSTABLE, BRISTOL, DUKES, ESSEX, MIDDLESEX, NANTUCKET NORFOLK AND SUFFOLK COUNTIES

	Rates	Fringes
Laborers: (Wrecking)		
Group 1.....	\$ 41.33	27.37
Group 2.....	\$ 42.08	27.37
Group 3.....	\$ 42.33	27.37
Group 4.....	\$ 37.33	27.37
Group 5.....	\$ 40.43	27.37
Group 6.....	\$ 41.33	27.37

- Group 1: Adzeman, Wrecking Laborer.
- Group 2: Burners, Jackhammers.
- Group 3: Small Backhoes, Loaders on tracks, Bobcat Type Loaders, Hydraulic ""Brock"" Type Hammer Operators, Concrete Cutting Saws.
- Group 4: Yardman (Salvage Yard Only).
- Group 5: Yardman, Burners, Sawyers.
- Group 6: Asbestos, Lead Paint, Toxic and Hazardous Waste.

 * PAI N0011-007 06/01/2021

BARNSTABLE, BRISTOL, DUKES, AND NANTUCKET COUNTIES

	Rates	Fringes
GLAZIER.....	\$ 39.98	23.75

FOOTNOTE:
 A. PAID HOLIDAY: LABOR DAY (provided employee has worked any part of the week prior to Labor Day and any part of the week after Labor Day)

 PAI N0035-004 01/01/2019

BARNSTABLE; BRISTOL; ESSEX; NANTUCKET; DUKES; COUNTIES; REMAINDER OF NORFOLK; MIDDLESEX AND SUFFOLK COUNTIES

	Rates	Fringes
PAINTER		
NEW CONSTRUCTION:		
Brush, Taper.....	\$ 39.86	30.25
Spray, Sandblast.....	\$ 41.26	30.25
REPAINT:		

Brush, Taper.....	\$ 37.92	30.25
Spray, Sandblast.....	\$ 39.32	30.25

PAI N0035-013 01/01/2019

MIDDLESEX (Cambridge, Everett, Malden, Medford, Somerville)
SUFFOLK COUNTY (Boston, Chelsea) NORFOLK COUNTY (Brookline)

	Rates	Fringes
PAINTER		
NEW CONSTRUCTION:		
Brush, Taper.....	\$ 45.65	30.25
Spray, Sandblast.....	\$ 47.05	30.25
REPAINT:		
Brush, Taper.....	\$ 43.71	30.25
Spray, Sandblast.....	\$ 45.11	30.25

PAI N0035-020 01/01/2019

ESSEX; MIDDLESEX; NORFOLK; SUFFOLK

	Rates	Fringes
GLAZIER.....	\$ 39.86	30.25

PLAS0534-001 01/01/2020

ESSEX; MIDDLESEX; NORFOLK AND SUFFOLK COUNTY

	Rates	Fringes
CEMENT MASON/CONCRETE FINISHER...	\$ 43.00	37.66

PLAS0534-004 01/01/2020

MIDDLESEX; NORFOLK AND SUFFOLK COUNTIES

	Rates	Fringes
PLASTERER.....	\$ 43.00	37.66

PLUM0004-001 09/01/2021

MIDDLESEX (Ashby, Ayer-West of Greenville branch of Boston and
Maine Railroad, Ft. Devens, Groton, Shirley, Townsend)

Rates	Fringes
-------	---------

Plumbers and Pipefitters.....\$ 48.50 27.27

PLUM0012-005 09/02/2019

ESSEX (Ames, Andover, Beverly, Boxford, Byfield, Danvers, Essex, Georgetown, Gloucester, Groveland, Hamilton, Haverhill, Ipswich, Lawrence, Manchester, Marblehead, Merrimac, Methuen, Middleton, Newbury, Newburyport, North Andover, Peabody, Rockport, Rowley, Salem, Salisbury, Topsfield, Wenham, West Newbury)

	Rates	Fringes
PLUMBER.....	\$ 53.61	30.43

PLUM0012-007 09/02/2021

ESSEX (Lynn, Lynnfield, Nahant, Saugus, and Swampscott); MIDDLESEX (Acton, Arlington, Ashford, Ayer-except west of Greenville Branch of Boston & Maine Rail Road, Bedford, Belmont, Billerica, Boxboro, Burlington, Cambridge, Carlisle, Chelmsford, Concord, Dracut, Dunstable, Everett, Framingham, Hudson, Holliston, Hopkinton, Lexington, Lincoln, Littleton, Lowell, Malden, Marlboro, Maynard, Medford, Melrose, Natick, Newton, North Reading, Pepperell, Reading, Sherborn, Somerville, Stoneham, Stow, Sudbury, Tewksbury, Tyngsboro, Wakefield, Watham, Watertown, Wayland, Westford, Wilmington, Winchester and Woburn), NORFOLK (Bellingham, Braintree, Brookline, Canton, Cohasset, Dedham, Dover, Foxboro, Franklin, Medford, Medway, Millis, Milton, Needham, Norfolk, Norwood, Plainville, Quincy, Sharon, Walpole, Wellesley, Westwood, Weymouth and Wrentham); PLYMOUTH (Hingham, Hull, Scituate); SUFFOLK; WORCESTER (Hopedale and Southboro)

	Rates	Fringes
PLUMBER.....	\$ 61.79	32.43

PLUM0051-004 09/01/2018

BARNSTABLE; BRISTOL; DUKES; NANTUCKET; AND NORFOLK (Avon, Holbrook, Randolph, Stoughton) COUNTIES

	Rates	Fringes
Plumbers and Pipefitters.....	\$ 42.04	29.91

PLUM0537-005 03/01/2021

ESSEX (Ames, Andover, Beverly, Boxford, Byfield, Danvers, Essex, Georgetown, Gloucester, Groveland, Hamilton, Haverhill, Ipswich, Lawrence, Lynn, Lynnfield, Manchester, Marblehead, Merrimac, Methuen, Middleton, Nahant, Newbury, Newburyport, North Andover, Peabody, Rockport, Rowley, Salem, Salisbury, Saugus, Swampscott, Topsfield, Wenham, West Newbury); MIDDLESEX (Acton, Arlington, Ashford, Ayer-except west of Greenville Branch of Boston & Maine Rail Road, Bedford, Belmont, Billerica, Boxboro, Burlington, Cambridge, Carlisle, Chelmsford, Concord, Dracut, Dunstable, Everett, Framingham, Hudson, Holliston, Hopkinton, Lexington, Lincoln, Littleton, Lowell, Malden, Marlboro, Maynard, Medford, Melrose, Natick, Newton, North Reading, Pepperell, Reading, Sherborn, Somerville, Stoneham, Stow, Sudbury, Tewksbury, Tyngsboro, Wakefield, Watham, Watertown, Wayland, Westford, Wilmington, Winchester and Woburn); NORFOLK (Bellingham, Braintree, Brookline, Canton, Cohasset, Dedham, Dover, Foxboro, Franklin, Medford, Medway, Millis, Milton, Needham, Norfolk, Norwood, Plainville, Quincy, Sharon, Walpole, Wellesley, Westwood, Weymouth and Wrentham); PLYMOUTH (Hingham, Hull, Scituate); SUFFOLK; WORCHESTER (Hopedale and Southboro)

	Rates	Fringes
PIPEFITTER.....	\$ 57.08	34.97

 * R00F0033-001 08/01/2021

	Rates	Fringes
Roofers: All Tear-off and/or removal of any types of roofing and all spudding, sweeping, vacuuming and/or cleanup of any and all areas of any type where a roof is to be relaid.....	\$ 47.03	32.18

 SFMA0550-001 10/01/2021

BRISTOL (Portion within 35 mile radius from Boston City Hall); ESSEX; MIDDLESEX (Except Ashby, Townsend, and portions of Pepperell and Shirley beyond 35 mile radius from Boston City Hall); NORFOLK; PLYMOUTH (Portion within 35 mile radius of Boston City Hall); SUFFOLK

Rates	Fringes
-------	---------

SPRINKLER FITTER..... \$ 63.30 33.21

a. PAID HOLIDAYS: Memorial Day, July 4th, Labor Day, Thanksgiving Day and Christmas Day, provided the employee has been in the employment of a contractor 20 working days prior to any such paid holiday.

SFMA0550-002 10/01/2021

BRISTOL (Seekonk, Swansea, and Somerset)

Rates Fringes
SPRINKLER FITTER..... \$ 56.97 33.21

a. PAID HOLIDAYS: Memorial Day, July 4th, Labor Day, Thanksgiving Day and Christmas Day, provided the employee has been in the employment of a contractor 20 working days prior to any such paid holiday.

SFMA0669-001 04/01/2021

BARNSTABLE; BRISTOL (Beyond 35 mile radius of Boston City Hall); DUKES; MIDDLESEX (Ashby, Townsend, portions of Pepperell and Shirley beyond 35 mile radius of Boston City Hall); NANTUCKET; PLYMOUTH (Beyond 35 mile radius of Boston City Hall)

Rates Fringes
SPRINKLER FITTER..... \$ 43.14 27.48

SHEE0017-003 08/01/2020

BRISTOL (Attleboro, Berkley, Easton, Mansfield, North Attleboro, Norton, Raynham, Taunton); ESSEX; MIDDLESEX; NORFOLK; PLYMOUTH (except except Marion, Mattapoisett, Rochester, Wareham); SUFFOLK

Rates Fringes
Sheet metal worker..... \$ 50.67 41.84

SHEE0017-007 08/01/2021

BARNSTABLE; BRISTOL (Acushnet, Assonet, Dartmouth, Dighton, Fairhaven, Fall River, Freetown, New Bedford, Rehoboth,

Seekonk, Somerset, Swansea, Westport); DUKES; AND NANTUCKET

	Rates	Fringes
Sheet metal worker.....	\$ 51.95	43.04

TEAM0379-001 08/01/2020		

	Rates	Fringes
Truck drivers:		
Group 1.....	\$ 34.98	26.6325+A+B
Group 2.....	\$ 35.15	26.6325+A+B
Group 3.....	\$ 35.22	26.6325+A+B
Group 4.....	\$ 34.44	26.6325+A+B
Group 5.....	\$ 35.44	26.6325+A+B
Group 6.....	\$ 35.73	26.6325+A+B
Group 7.....	\$ 36.02	26.6325+A+B

POWER TRUCKS \$.25 DIFFERENTIAL BY AXLE
TUNNEL WORK (UNDERGROUND ONLY) \$.40 DIFFERENTIAL BY AXLE
HAZARDOUS MATERIALS (IN HOT ZONE ONLY) \$2.00 PREMIUM

TRUCK DRIVERS CLASSIFICATIONS

- Group 1: Station wagons; panel trucks; and pickup trucks
- Group 2: Two axle equipment; & forklift operator
- Group 3: Three axle equipment and tireman
- Group 4: Four and Five Axle equipment
- Group 5: Specialized earth moving equipment under 35 tons other than conventional type trucks; low bed; vachual; mechanics, paving restoration equipment
- Group 6: Specialized earth moving equipment over 35 tons
- Group 7: Trailers for earth moving equipment (double hookup)

FOOTNOTES:

A. PAID HOLIDAYS: New Year's Day, Washington's Birthday, Memorial Day, Independence Day, Labor Day, Patriot's Day, Columbus Day, Veteran's Day, Thanksgiving Day and Christmas Day

B. PAID VACATION: Employees with 4 months to 1 year of service receive 1/2 day's pay per month; 1 week vacation for 1 - 5 years of service; 2 weeks vacation for 5 - 10 years of service; and 3 weeks vacation for more than 10 years of service

WELDERS - Receive rate prescribed for craft performing operation to which welding is incidental.

Note: Executive Order (EO) 13706, Establishing Paid Sick Leave for Federal Contractors applies to all contracts subject to the Davis-Bacon Act for which the contract is awarded (and any solicitation was issued) on or after January 1, 2017. If this contract is covered by the EO, the contractor must provide employees with 1 hour of paid sick leave for every 30 hours they work, up to 56 hours of paid sick leave each year. Employees must be permitted to use paid sick leave for their own illness, injury or other health-related needs, including preventive care; to assist a family member (or person who is like family to the employee) who is ill, injured, or has other health-related needs, including preventive care; or for reasons resulting from, or to assist a family member (or person who is like family to the employee) who is a victim of, domestic violence, sexual assault, or stalking. Additional information on contractor requirements and worker protections under the EO is available at www.dol.gov/whd/govcontracts.

Unlisted classifications needed for work not included within the scope of the classifications listed may be added after award only as provided in the labor standards contract clauses (29CFR 5.5 (a) (1) (ii)).

The body of each wage determination lists the classification and wage rates that have been found to be prevailing for the cited type(s) of construction in the area covered by the wage determination. The classifications are listed in alphabetical order of "identifiers" that indicate whether the particular rate is a union rate (current union negotiated rate for local), a survey rate (weighted average rate) or a union average rate (weighted union average rate).

Union Rate Identifiers

A four letter classification abbreviation identifier enclosed in dotted lines beginning with characters other than ""SU"" or ""UAVG"" denotes that the union classification and rate were prevailing for that classification in the survey. Example: PLUM0198-005 07/01/2014. PLUM is an abbreviation identifier of the union, which prevailed in the survey for this classification, which in this example would be Plumbers 0198 indicates the local union number or district council number where applicable, i.e., Plumbers Local 0198. The next number, 005 in the example, is an internal number used in processing the wage determination. 07/01/2014 is the effective date of the most current negotiated rate, which in this example is July 1, 2014.

Union prevailing wage rates are updated to reflect all rate changes in the collective bargaining agreement (CBA) governing this classification and rate.

Survey Rate Identifiers

Classifications listed under the ""SU"" identifier indicate that no one rate prevailed for this classification in the survey and the published rate is derived by computing a weighted average rate based on all the rates reported in the survey for that classification. As this weighted average rate includes all rates reported in the survey, it may include both union and non-union rates. Example: SULA2012-007 5/13/2014. SU indicates the rates are survey rates based on a weighted average calculation of rates and are not majority rates. LA indicates the State of Louisiana. 2012 is the year of survey on which these classifications and rates are based. The next number, 007 in the example, is an internal number used in producing the wage determination. 5/13/2014 indicates the survey completion date for the classifications and rates under that identifier.

Survey wage rates are not updated and remain in effect until a new survey is conducted.

Union Average Rate Identifiers

Classification(s) listed under the UAVG identifier indicate that no single majority rate prevailed for those classifications; however, 100% of the data reported for the classifications was union data. EXAMPLE: UAVG-OH-0010 08/29/2014. UAVG indicates that the rate is a weighted union average rate. OH indicates the state. The next number, 0010 in the example, is an internal number used in producing the wage determination. 08/29/2014 indicates the survey completion date for the classifications and rates under that identifier.

A UAVG rate will be updated once a year, usually in January of

each year, to reflect a weighted average of the current negotiated/CBA rate of the union locals from which the rate is based.

WAGE DETERMINATION APPEALS PROCESS

1.) Has there been an initial decision in the matter? This can be:

- * an existing published wage determination
- * a survey underlying a wage determination
- * a Wage and Hour Division letter setting forth a position on a wage determination matter
- * a conformance (additional classification and rate) ruling

On survey related matters, initial contact, including requests for summaries of surveys, should be with the Wage and Hour Division National Office Branch of Wage Surveys. If the response from this initial contact is not satisfactory, then the process described in 2.) and 3.) should be followed.

With regard to any other matter not yet ripe for the formal process described here, initial contact should be with the Branch of Construction Wage Determinations. Write to:

Branch of Construction Wage Determinations
Wage and Hour Division
U. S. Department of Labor
200 Constitution Avenue, N. W.
Washington, DC 20210

2.) If the answer to the question in 1.) is yes, then an interested party (those affected by the action) can request review and reconsideration from the Wage and Hour Administrator (See 29 CFR Part 1.8 and 29 CFR Part 7). Write to:

Wage and Hour Administrator
U. S. Department of Labor
200 Constitution Avenue, N. W.
Washington, DC 20210

The request should be accompanied by a full statement of the interested party's position and by any information (wage payment data, project description, area practice material, etc.) that the requestor considers relevant to the issue.

3.) If the decision of the Administrator is not favorable, an

interested party may appeal directly to the Administrative Review Board (formerly the Wage Appeals Board). Write to:

Administrative Review Board
U. S. Department of Labor
200 Constitution Avenue, N. W.
Washington, DC 20210

4.) All decisions by the Administrative Review Board are final.

=====

END OF GENERAL DECISION"

"General Decision Number: MA20220008 01/07/2022

Superseded General Decision Number: MA20210008

State: Massachusetts

Construction Types: Heavy (Heavy and Marine)

Counties: Barnstable, Bristol, Dukes, Essex, Middlesex, Nantucket, Norfolk, Plymouth and Suffolk Counties in Massachusetts.

HEAVY AND MARINE CONSTRUCTION PROJECTS

Note: Contracts subject to the Davis-Bacon Act are generally required to pay at least the applicable minimum wage rate required under Executive Order 14026 or Executive Order 13658. Please note that these Executive Orders apply to covered contracts entered into by the federal government that are subject to the Davis-Bacon Act itself, but do not apply to contracts subject only to the Davis-Bacon Related Acts, including those set forth at 29 CFR 5.1(a)(2)-(60).

If the contract is entered into on or after January 30, 2022, or the contract is renewed or extended (e.g., an option is exercised) on or after January 30, 2022, Executive Order 14026 generally applies to the contract. The contractor must pay all covered workers at least \$15.00 per hour (or the applicable wage rate listed on this wage determination, if it is higher) for all hours spent performing on that contract in 2022.

If the contract was awarded on or between January 1, 2015 and January 29, 2022, and the contract is not renewed or extended on or after January 30, 2022, Executive Order 13658 generally applies to the contract. The contractor must pay all covered workers at least \$11.25 per hour (or the applicable wage rate listed on this wage determination, if it is higher) for all hours spent performing on that contract in 2022.

The applicable Executive Order minimum wage rate will be adjusted annually. If this contract is covered by one of the Executive Orders and a classification considered necessary for performance of work on the contract does not appear on this wage determination, the contractor must still submit a conformance request.

Additional information on contractor requirements and worker protections under the Executive Orders is available at www.dol.gov/whd/govcontracts.

Modification Number Publication Date
0 01/07/2022

BOIL0029-001 01/01/2021

	Rates	Fringes
BOILERMAKER.....	\$ 45.87	29.02

BRMA0001-011 08/01/2020

FOXBORO CHAPTER

BRISTOL (Attleboro, Berkley, Dighton, Mansfield, North Attleboro, Norton, Raynham, Rehoboth, Seekonk, Taunton); NORFOLK, (Bellingham, Canton, Dedham, Foxboro, Franklin, Norfolk, Norwood, Plainville, Sharon, Walpole, Westwood, Wrentham); and PLYMOUTH (Lakeville)

	Rates	Fringes
Bricklayer/Cement Mason.....	\$ 53.16	34.95

BRMA0001-012 08/01/2020

LOWELL CHAPTER

MIDDLESEX (Acton, Ashby, Ayer, Bedford, Billerica, Boxboro, Carlisle, Chemsford, Dracut, Dunstable, Ft Devens, Groton, Littleton, Lowell, North Acton, Pepperell, Shirley, South Acton, Tewksbury, Townsend, Tyngsboro, West Acton, Westford, Wilmingon)

	Rates	Fringes
BRICKLAYER.....	\$ 53.16	34.95

BRMA0001-013 08/01/2020

LOWELL CHAPTER

MIDDLESEX (Ashland, Framingham, Holliston, Hopkinton, Hudson, Maynard, Natick, Sherborn, Stow); and NORFOLK (Medfield, Medway, Millis)

	Rates	Fringes
BRICKLAYER.....	\$ 53.16	34.95

BRMA0003-001 02/01/2021

	Rates	Fringes
Marble & Tile Finisher.....	\$ 42.57	32.00
Marble, Tile & Terrazzo Workers.....	\$ 54.69	33.80
TERRAZZO FINISHER.....	\$ 55.77	34.47

BRMA0003-003 02/01/2021

BOSTON CHAPTER
MIDDLESEX (Arlington, Cambridge, Everett, Malden, Medford,
Melrose, Somerville); NORFOLK (Brookline, Milton); and SUFFOLK

	Rates	Fringes
BRICKLAYER.....	\$ 55.75	35.85

BRMA0003-011 02/01/2021

LYNN CHAPTER

ESSEX (Amesbury, Andover, Beverly, Boxford, Danvers, Essex,
Georgetown, Gloucester, Groveland, Hamilton, Haverhill,
Ipswich, Lawrence, Lynn, Lynnfield, Manchester, Marblehead,
Merrimac, Methuen, Middleton, Nahant, Newbury, Newburyport,
North Andover, Peabody, Rockport, Rowley, Salisbury, Salem,
Saugus, Swampscott, Topsfield, Wakefield, Wenham, West
Newbury); and MIDDLESEX (North Reading, Reading, Wakefield)

	Rates	Fringes
Bricklayer/Cement Mason.....	\$ 55.75	35.85

BRMA0003-012 02/01/2021

	Rates	Fringes
BRICKLAYER WALTHAM CHAPTER - MIDDLESEX (Belmont, Burlington, Concord, Lexington, Lincoln, Stoneham, Sudbury, Waltham, Watertown, Wayland, Weston, Winchester, Woburn).....	\$ 55.75	35.85

BRMA0003-014 02/01/2021

QUINCY CHAPTER

PLYMOUTH COUNTY (Abington, Bridgewater, Brockton, Carver, Duxbury, East Bridgewater, Halifax, Hanover, Hanson, Hingham, Hull, Kingston, Marshfield, Middleboro, Norwell, Pembroke, Plymouth, Rockland, Scituate, West Bridgewater, Whitman)

	Rates	Fringes
Bricklayer/Cement Mason.....	\$ 55.75	35.85

BRMA0003-025 02/01/2021

NEW BEDFORD CHAPTER

BARNSTABLE; BRISTOL (Acushnet, Dartmouth, Fairhaven, Fall River, Freetown, New Bedford, Somerset, Swansea, Westport); DUKES; NANTUCKET; PLYMOUTH (Marion, Mattapoisett, Rochester, Wareham)

	Rates	Fringes
Bricklayer/Cement Mason.....	\$ 55.75	35.85

BRMA0003-033 02/01/2021

NEWTON CHAPTER

MIDDLESEX (Newton); NORFOLK (Dover, Needham, Wellesley)

	Rates	Fringes
Bricklayer, Plasterer.....	\$ 55.75	35.85

CARP0056-001 08/01/2021

All of SUFFOLK COUNTY; and those areas of BARNSTABLE, BRISTOL, ESSEX, MIDDLESEX, NORFOLK, and PLYMOUTH COUNTIES situated INSIDE Boston Beltway (I-495) and North of Cape Cod Canal. ALL of DUKES and NANTUCKET COUNTIES

	Rates	Fringes
PILEDRIVERMAN.....	\$ 50.74	33.66

CARP0056-002 08/01/2021

The areas of BARNSTABLE, BRISTOL, PLYMOUTH, and NORFOLK COUNTIES situated OUTSIDE Boston Beltway (I-495) and South of Cape Cod Canal

	Rates	Fringes
PI LEDRIVERMAN.....	\$ 47.14	33.45

CARP0056-003 08/01/2021

Those areas of ESSEX and MIDDLESEX COUNTIES situated OUTSIDE Boston Beltway (I-495)

	Rates	Fringes
PI LEDRIVERMAN.....	\$ 44.61	33.45

CARP0056-004 08/01/2020

	Rates	Fringes
DIVER TENDER.....	\$ 49.07	35.57
DIVER.....	\$ 68.70	35.57

CARP0327-002 03/01/2021

MIDDLESEX (Belmont, Cambridge, Everett, Malden, Medford, Somerville); NORFOLK (Brookline, Dedham, Milton); AND SUFFOLK COUNTIES

	Rates	Fringes
CARPENTER.....	\$ 52.38	20.78

* CARP0339-002 09/01/2021

BRISTOL (Attleborough, North Attleborough); ESSEX; MIDDLESEX (Except Belmont, Cambridge, Everett, Malden, Medford, Somerville); AND NORFOLK (Bellingham, Braintree, Canton, Cohasset, Foxboro, Franklin, Medfield, Medway, Millis, Needham, Norfolk, Norwood, Plainville, Quincy, Sharon, Walpole, Wellesley, Westwood, Weymouth, Wrentham) COUNTIES

	Rates	Fringes
CARPENTER.....	\$ 44.18	29.27

CARP0346-001 03/01/2020

NORFOLK (Braintree, Quincy, Cohasset, Weymouth, etc.) PLYMOUTH
(Duxbury, Hanover, Hull, Hingham, Marshfield, Norwell, Pembroke
Rockland, Scituate)

	Rates	Fringes
CARPENTER.....	\$ 42.40	29.10

CARP0624-002 09/01/2017

DUKES; NANTUCKET

	Rates	Fringes
CARPENTER.....	\$ 46.43	28.35

CARP0624-006 09/01/2017

BARNSTABLE; BRISTOL (Except Attleboro & North Attleboro);
NORFOLK (Avon, Holbrook, Randolph, Stoughton); PLYMOUTH
(Bridgewater, Kingston, Lakeville, Middleboro, Plymouth, S.
Hanover, Whitman)

	Rates	Fringes
CARPENTER.....	\$ 39.28	27.90

CARP1121-001 01/06/2020

SUFFOLK COUNTY

	Rates	Fringes
MILLWRIGHT.....	\$ 42.32	31.15

CARP1121-005 01/06/2020

BARNSTABLE, BRISTOL, DUKES, ESSEX, MIDDLESEX, NANTUCKET,
NORFOLK and PLYMOUTH COUNTIES

	Rates	Fringes
MILLWRIGHT.....	\$ 38.47	31.15

ELEC0096-001 09/06/2021

MIDDLESEX (Ashby, Ashland, Ayer, Ft. Devens, Groton, Hopkinton, Hudson, Marlboro, Pepperell, Shirley, Stow, Townsend)

	Rates	Fringes
ELECTRICIAN.....	\$ 45.01	11%+25.01
Teladata System Installer.....	\$ 32.85	28.12

 ELEC0099-001 06/01/2021

BRISTOL (Attleboro, North Attleboro, Seekonk)

	Rates	Fringes
ELECTRICIAN.....	\$ 43.61	54.71%
Teladata System Installer.....	\$ 31.21	13.1%+14.93

 ELEC0103-002 09/01/2021

ESSEX (Amesbury, Andover, Boxford, Georgetown, Groveland, Haverhill, Lawrence, Merrimac, Methuen, Newbury, Newburyport, North Andover, Rowley, Salisbury, West Newbury); MIDDLESEX (Bedford, Billerica, Boxboro, Burlington, Carlisle, Chelmsford, Dracut, Dunstable, Littleton, Lowell, North Reading, Tewksbury, Tyngsboro, Westford, Wilmington)

	Rates	Fringes
ELECTRICIAN.....	\$ 56.36	34.39

 ELEC0103-004 09/01/2021

ESSEX (Beverly, Danvers, Essex, Gloucester, Hamilton, Ipswich, Manchester, Marblehead, Middleton, Peabody, Rockport, Salem, Topsfield, Wenham)

	Rates	Fringes
ELECTRICIAN.....	\$ 56.36	34.39

 ELEC0103-005 09/01/2021

ESSEX (Lynn, Lynnfield, Nahant, Saugus, Swampscott); MIDDLESEX (Acton, Arlington, Belmont, Cambridge, Concord, Everett, Framingham, Holliston, Lexington, Lincoln, Malden, Maynard, Medford, Melrose, Natick, Newton, Reading, Sherborn, Somerville, Stoneham, Sudbury, Wakefield, Waltham, Watertown,

Wayland, Weston, Winchester, Woburn); NORFOLK (Bellingham, Braintree, Brookline, Canton, Cohasset, Dedham, Dover, Foxboro, Frankl oin, Medfield, Medway, Millis, Milton, Needham, Norfolk, Norwood, Quincy, Sharon, Walpole, Wellesley, Westwood, Weymouth, Wrentham); PLYMOUTH (Hingham and Hull); SUFFOLK

	Rates	Fringes
ELECTRICIAN.....	\$ 56.36	34.39

* ELEC0104-001 09/01/2021

	Rates	Fringes
Line Construction:		
Cableman.....	\$ 51.09	27.91+A
Equipment Operator.....	\$ 43.43	24.62+A
Groundman.....	\$ 28.10	11.80+A
Lineman.....	\$ 51.09	27.91+A

A. PAID HOLIDAYS: New Year's Day; Memorial Day; Independence Day; Labor Day; Thanksgiving Day; Christmas Day and Columbus Day, provided the employee has been employed 5 working days prior to any one of the listed holidays.

ELEC0223-002 09/01/2021

BARNSTABLE, BRISTOL (Except Attleboro, North Attleboro, Seekonk); DUKES; NANTUCKET; PLYMOUTH (Except Hingham and Hull Twps); NORFOLK (Avon, Halbrook, Randolph, Soughton)

	Rates	Fringes
ELECTRICIAN.....	\$ 44.27	31.18%+14.00

ENGI0004-009 06/01/2020

	Rates	Fringes
Power equipment operators:		
Group 1.....	\$ 49.33	29.75+a
Group 2.....	\$ 48.81	29.75+a
Group 3.....	\$ 32.72	29.75+a
Group 4.....	\$ 40.30	29.75+a
Group 5.....	\$ 23.13	29.75+a
Group 6.....	\$ 27.79	29.75+a

HOURLY PREMIUM FOR BOOM LENGTHS (Including Jib):

Over 150 ft. +2.18
Over 185 ft. +3.84
Over 210 ft. +5.39
Over 250 ft. +8.16
Over 295 ft. +11.29
Over 350 ft. +13.14

FOOTNOTE FOR POWER EQUIPMENT OPERATORS:

A. PAID HOLIDAYS: New Year's Day, Washington's Birthday, Labor Day, Memorial Day, Independence Day, Patriot's Day, Columbus Day, Veteran's Day, Thanksgiving Day, Christmas Day

POWER EQUIPMENT OPERATORS CLASSIFICATIONS [HEAVY CONSTRUCTION]

GROUP 1: Power shovel; crane; truck crane; derrick; pile driver; trenching machine; mechanical hoist pavement breaker; cement concrete paver; dragline; hoisting engine; three drum machine; pumpcrete machine; loaders; shovel dozer; front end loader; mucking machine; shaft hoist; steam engine; backhoe; gradall; cable way; fork lift; cherry picker; boring machine; rotary drill; post hole hammer; post hole digger; asphalt plant on job site; concrete batching and/or mixing plant on job site; crusher plant on job site; paving concrete mixer; timber jack

GROUP 2: Sonic or vibratory hammer; grader; scraper; tandem scraper; bulldozer; tractor; mechanic - maintenance; York rake; mulching machine; paving screed machine; stationary steam boiler; paving concrete finishing machine; grout pump; portable steam boiler; portable steam generator; roller; spreader; asphalt paver; locomotives or machines used in place thereof; tamper (self propelled or tractor-draw); cal tracks; ballast regulator; rail anchor machine; switch tamper; tire truck

GROUP 3: Pumps (1-3 grouped); compressor; welding machines (1-3 grouped); generator; sighting plant; heaters (power driven, 1- 5); syphon-pul someter; concrete mixer; valves controlling permanent plant air steam, conveyor, wellpoint system (operating)

GROUP 4: Assitant engineer (fireman)

GROUP 5: Oiler (other than truck cranes and gradalls)

GROUP 6: Oiler (on truck cranes and gradalls)

IRON007-001 09/16/2021

AREA 1: BRISTOL (Easton); ESSEX (Beverly, Gloucester, Lynn, Lynnfield, Manchester, Marblehead, Nahant, Rockport, Salem, Saugus, Swampscott); MIDDLESEX (Arlington, Bedford, Belmont, Burlington, Cambridge, Carlisle, Concord, Dunstable, Everett, Framingham, Lexington, Lincoln, Malden, Maynard, Medford,

Melrose, Natick, Newton, Reading, Sherborn, Somerville, Stoneham, Sudbury, Wakefield, Waltham, Watertown, Wayland, Weston, Winchester, Woburn); NORFOLK (Except Medway); PLYMOUTH (Abington, Bridgewater, Brocton, Duxbury, East Bridgewater, Halifax, Hanover, Hanson, Hingham, Hull, Kingston, Marshfield, Norwell, Pembroke, Plymouth, Plympton, Rockland, Scituate, West Bridgewater, Whitman); SUFFOLK

AREA 2: ESSEX (Amesbury, Andover, Boxford, Danvers, Essex, Georgetown, Hamilton, Haverhill, Ipswich, Lawrence, Merrimac, Methuen, Newbury, Newburyport, North Andover, Rowley, Salisbury, Topsfield, Wenham, West Newbury); MIDDLESEX (Acton, Billerica, Chelmsford, Dracut, Groton, Groveland, Littleton, Lowell, Middleton, North Reading, Pepperell, Tewksbury, Tyngsboro, Westford, Wiliminton)

	Rates	Fringes
IRONWORKER		
AREA 1.....	\$ 50.13	34.81
AREA 2.....	\$ 45.72	34.81

 IRON0007-010 09/16/2021

MIDDLESEX (Ashby, Ashland, Ayer, Boxboro, Holliston, Hopkinton, Hudson, Marlboro, Shirley, Stow, Townsend); NORFOLK (Medway)

	Rates	Fringes
IRONWORKER.....	\$ 49.83	34.81

 IRON0037-002 03/16/2021

BARNSTABLE; BRISTOL (Acushnet, Attleboro, Berkley, Dartmouth, Dighton, Fairhaven, Fall River, Freetown, Mansfield, New Bedford, North Attleboro, Norton, Raynham, Rehoboth, Seekonk, Somerset, Swansea, Taunton, Westport); DUKES; NANTUCKET; NORFOLK (Billingham, Franklin, Plainville, Wrentham); PLYMOUTH (Lakeville, Marion, Mattapoisett, Middleboro, Rochester, Wareham)

	Rates	Fringes
IRONWORKER.....	\$ 37.87	30.13

 * LAB00022-006 12/01/2021

SUFFOLK COUNTY (Boston, Chelsea, Revere, Winthrop, Deer & Nut

Islands); MIDDLESEX COUNTY (Arlington, Belmont, Burlington, Cambridge, Everett, Malden, Medford, Melrose, Reading, Somerville, Stoneham, Wakefield, Winchester, Winthrop and Woburn only); NORFOLK COUNTY (Brookline, Dedham, and Milton only)

	Rates	Fringes
Laborers:		
GROUP 1.....	\$ 41.18	27.52
GROUP 2.....	\$ 41.43	27.52
GROUP 3.....	\$ 41.93	27.52
GROUP 4.....	\$ 42.18	27.52
GROUP 5.....	\$ 24.50	27.52
GROUP 6.....	\$ 43.18	27.52

LABORERS CLASSIFICATIONS

GROUP 1: Laborers; carpenter tenders; cement finisher tenders

GROUP 2: Asphalt raker; fence and guard rail erector; laser beam operator; mason tender; pipelayer; pneumatic drill operator; pneumatic tool operator; wagon drill operator

GROUP 3: Air track operator; block paver; rammer; curb setter

GROUP 4: Blaster; powderman

GROUP 5: Flagger

GROUP 6: Asbestos Abatement; Toxic and Hazardous Waste Laborers

* LAB00022-012 12/01/2021

Counties of BARNSTABLE; BRISTOL; DUKES; ESSEX; NANTUCKET; PLYMOUTH; MIDDLESEX (With the exception of Arlington, Belmont, Burlington, Cambridge, Everett, Malden, Melrose, Reading, Somerville, Stoneham, Wakefield, Winchester, Winthrop and Woburn); NORFOLK (With the exception of Brookline, Dedham, and Milton)

	Rates	Fringes
Laborers:		
GROUP 1.....	\$ 35.41	26.59

GROUP 2.....	\$ 35.66	26.59
GROUP 3.....	\$ 36.16	26.59
GROUP 4.....	\$ 36.41	26.59
GROUP 5.....	\$ 24.50	26.59
GROUP 6.....	\$ 37.41	26.59

LABORERS CLASSIFICATIONS

GROUP 1: Laborers; carpenter tenders; cement finisher tenders

GROUP 2: Asphalt raker; fence and guard rail erector; laser beam operator; mason tender; pipelayer; pneumatic drill operator; pneumatic tool operator; wagon drill operator

GROUP 3: Air track operator; block paver; rammer; curb setter; hydraulic & similar self powered drills

GROUP 4: Blaster; powderman

GROUP 5: Flagger

GROUP 6: Asbestos Abatement; Toxic and Hazardous Waste Laborers

* LAB00022-013 12/01/2021

	Rates	Fringes
Laborers:		
(FREE AIR OPERATION):		
SHIELD DRIVEN AND LINER PLATE IN FREE AIR)		
GROUP 1.....	\$ 45.48	28.02
GROUP 2.....	\$ 45.48	28.02
(OPEN AIR CASSONS, UNDERPINNING AND TEST BORING INDUSTRIES):		
TEST BORING & WELL DRILLING		
Driller.....	\$ 42.58	27.67
Laborer.....	\$ 41.18	27.67
(OPEN AIR CASSONS, UNDERPINNING AND TEST BORING INDUSTRIES):		

OPEN AIR CASSON, UNDERPINNING WORK & BORING CREW		
Bottom man.....	\$ 42.33	27.67
Laborers; Top man.....	\$ 41.18	27.67
(TUNNELS, CAISSON & CYLINDER WORK IN COMPRESSED AIR)		
GROUP 1.....	\$ 42.93	28.02
GROUP 2.....	\$ 53.41	28.02
GROUP 3.....	\$ 53.41	28.02
GROUP 4.....	\$ 53.41	28.02
GROUP 5.....	\$ 53.41	28.02
GROUP 6.....	\$ 55.41	28.02
CLEANING CONCRETE AND CAULKING TUNNEL (Both New & Existing)		
GROUP 1.....	\$ 45.48	28.02
GROUP 2.....	\$ 45.48	28.02
ROCK SHAFT, CONCRETE LINING OF SAME AND TUNNEL IN FREE AIR		
GROUP 1.....	\$ 42.93	28.02
GROUP 2.....	\$ 45.48	28.02
GROUP 3.....	\$ 45.48	28.02
GROUP 4.....	\$ 45.48	28.02
GROUP 5.....	\$ 47.48	28.02

LABORERS CLASSIFICATIONS for TUNNELS, CAISSON & CYLINDER WORK
IN COMPRESSED AIR

GROUP 1: Powder watchman; Top man on iron bolt; change house attendant

GROUP 2: Brakeman; trackman; groutman; tunnel laborer; outside lock tender; lock tender; guage tender

GROUP 3: Motorman, miner

GROUP 4: Blaster

GROUP 5: Mucking machine operator

GROUP 6: Hazardous Waste work within the ""HOT"" zone. (A premium of two dollars \$2.00 per hour over the basic wage rate.

LABORERS CLASSIFICATIONS for (FREE AIR OPERATION): SHIELD
DRIVEN AND LINER PLATE IN FREE AIR

GROUP 1: Miner; miner welder; conveyor operator; motorman; mucking machine operator; nozzle man; grout man-; pumps, shaft and tunnel steel and rodman; shield and erector arm operators, mole nipper, outside motorman, burner, TBM operator, safety miner; laborer topside; heading motormen; erecting operators; top signal men

GROUP 2: Brakeman; trackman

LABORERS CLASSIFICATIONS FOR CLEANING CONCRETE AND CAULKING TUNNEL (Both New & Existing)

GROUP 1: Concrete workers; strippers and form movers (wood & steel), cement finisher

GROUP 2: Form erector (wood & steel and all accessories)

LABORERS CLASSIFICATIONS for ROCK SHAFT, CONCRETE LINING OF SAME AND TUNNEL IN FREE AIR

GROUP 1: Change house attendants

GROUP 2: Laborers, topside, bottom men (when heading is 50 ft. from shaft) and all other laborers

GROUP 3: Brakeman; trackman; tunnel laborers; shaft laborers

GROUP 4: Miner; cage tender; bellman

GROUP 5: Hazardous Waste work within the "HOT" zone. (A premium of two dollars \$2.00 per hour over the basic wage rate)

FOOTNOTE FOR LABORERS:

A. PAID HOLIDAYS: New Year's Day, Washington's Birthday, Patriot's Day, Memorial Day, Independence Day, Labor Day, Columbus Day, Veteran's Day, Thanksgiving Day, and Christmas Day

* LAB01421-001 12/01/2021

WRECKING LABORERS:

Rates

Fringes

Laborers: (Wrecking)

Group 1.....	\$ 41.33	27.37
Group 2.....	\$ 42.08	27.37
Group 3.....	\$ 42.33	27.37
Group 4.....	\$ 37.33	27.37
Group 5.....	\$ 40.43	27.37
Group 6.....	\$ 41.33	27.37

Group 1: Adzeman, Wrecking Laborer.

Group 2: Burners, Jackhammers.

Group 3: Small Backhoes, Loaders on tracks, Bobcat Type Loaders, Hydraulic ""Brock"" Type Hammer Operators, Concrete Cutting Saws.

Group 4: Yardman (Salvage Yard Only).

Group 5: Yardman, Burners, Sawyers.

Group 6: Asbestos, Lead Paint, Toxic and Hazardous Waste.

 PAI N0035-001 07/01/2019

BARNSTABLE BRISTOL; DUKES; ESSEX; NANTUCKET; PLYMOUTH
 (Remainder of NORFOLK; MIDDLESEX AND SUFFOLK COUNTIES)

Rates Fringes

PAINTER

NEW CONSTRUCTION:

Bridge.....	\$ 50.36	30.25
Brush, Taper.....	\$ 39.86	30.25
Spray, Sandblast.....	\$ 41.26	30.25

REPAINT:

Bridge.....	\$ 50.66	30.90
Brush, Taper.....	\$ 37.92	30.25
Spray, Sandblast.....	\$ 39.32	30.25

 PAI N0035-015 07/01/2019

MIDDLESEX (Cambridge, Everett, Malden, Medford, Somerville)
 SUFFOLK COUNTY (Boston, Chelsea) NORFOLK COUNTY (Brookline)

Rates Fringes

PAINTER

NEW CONSTRUCTION:

Brush, Taper.....	\$ 45.65	30.25
Spray, Sandblast.....	\$ 47.05	30.25

REPAINT:

Bridge.....	\$ 50.66	30.90
-------------	----------	-------

Brush, Taper.....	\$ 43.71	30.25
Spray, Sandblast.....	\$ 45.11	30.25

PLAS0534-001 01/01/2020

ESSEX; MIDDLESEX; NORFOLK AND SUFFOLK COUNTY

	Rates	Fringes
CEMENT MASON/CONCRETE FINISHER... \$	43.00	37.66

PLUM0004-001 09/01/2021

MIDDLESEX (Ashby, Ayer-West of Greenville branch of Boston and
Maine Railroad, Ft. Devens, Groton, Shirley, Townsend)

	Rates	Fringes
Plumbers and Pipefitters..... \$	48.50	27.27

PLUM0012-001 03/01/2019

ESSEX (Ames, Andover, Beverly, Boxford, Byfield, Danvers,
Essex, Georgetown, Gloucester, Groveland, Hamilton, Haverhill,
Ipswich, Lawrence, Manchester, Marblehead, Merrimac, Methuen,
Middleton, Newbury, Newburyport, North Andover, Peabody,
Rockport, Rowley, Salem, Salisbury, Topsfield, Wenham, West
Newbury)

	Rates	Fringes
PLUMBER..... \$	52.61	29.93

PLUM0012-003 03/01/2019

ESSEX (Ames, Andover, Beverly, Boxford, Byfield, Danvers,
Essex, Georgetown, Gloucester, Groveland, Hamilton, Haverhill,
Ipswich, Lawrence, Manchester, Marblehead, Merrimac, Methuen,
Middleton, Newbury, Newburyport, North Andover, Peabody,
Rockport, Rowley, Salem, Salisbury, Topsfield, Wenham, West
Newbury)

	Rates	Fringes
Plumber, Pipefitter, Steamfitter..... \$	52.61	29.93

PLUM0012-006 03/01/2019

ESSEX (Lynn, Lynnfield, Nahant, Saugus, and Swampscott);
MIDDLESEX (Acton, Arlington, Ashland, Ayer - except W. of
Greenville Branch of Boston & Maine RR, Bedford, Belmont,
Billerica, Boxboro, Burlington, Cambridge, Carlisle,
Chelmsford, Concord, Dracut, Dunstable, Everett, Framingham,
Hudson, Holliston, Hopkinton, Lexington, Lincoln, Littleton,
Lowell, Malden, Marlboro, Maynard, Medford, Melrose, Natick,
Newton, North Reading, Pepperell, Reading, Sherborn,
Somerville, Stoneham, Stow, Sudbury, Tewksbury, Tyngsboro,
Wakefield, Waltham, Watertown, Wayland, Westford, Wilmington,
Winchester, Woburn); NORFOLK (Bellingham, Braintree,
Brookline, Canton, Cohasset, Dedham, Dover, Foxboro, Franklin,
Medfield, Medway, Millis, Milton, Needham, Norfolk, Norwood,
Plainville, Quincy, Sharon, Walpole, Wellesley, Westwood,
Weymouth, Wrentham); PLYMOUTH (Hingham, Hull, Scituate);
SUFFOLK

	Rates	Fringes
PLUMBER.....	\$ 56.69	29.93

PLUM0051-005 09/01/2018		

BARNSTABLE; BRISTOL; DUKES; NANTUCKET; NORFOLK (Avon, Holbrook,
Randolph, Stoughton) PLYMOUTH(Remainder of County)

	Rates	Fringes
Plumbers and Pipefitters.....	\$ 42.04	29.91

PLUM0537-001 03/01/2021		

MIDDLESEX (Arlington, Cambridge, Everett, Malden, Medford,
Melrose, Reading, Wakefield, Winchester and Woburn); NORFOLK
(Bellingham, Braintree, Brookline, Canton, Cohasset, Dedham,
Foxboro, Franklin, Millis, Milton, Sharon, Walpole, Westwood,
and Wrentham); PLYMOUTH (Hingham, Hull, Scituate); ESSEX (Ames,
Andover, Beverly, Boxford, Byfield, Danvers, Essex, Georgetown,
Gloucester, Groveland, Hamilton, Haverhill, Ipswich,
Lawrence, Lynn, Lynnfield, Manchester, Marblehead, Merrimac,
Methuen, Middleton, Nahant, Newbury, Newburyport, North
Andover, Peabody, Rockport, Rowley, Salem, Salisbury, Saugus,
Swampscott, Topsfield, Wenham, West Newbury)

	Rates	Fringes
PIPEFITTER.....	\$ 52.75	34.97

	Rates	Fringes
Truck drivers:		
Group 1.....	\$ 34.98	26.6325+A+B
Group 2.....	\$ 35.15	26.6325+A+B
Group 3.....	\$ 35.22	26.6325+A+B
Group 4.....	\$ 34.44	26.6325+A+B
Group 5.....	\$ 35.44	26.6325+A+B
Group 6.....	\$ 35.73	26.6325+A+B
Group 7.....	\$ 36.02	26.6325+A+B

POWER TRUCKS \$.25 DIFFERENTIAL BY AXLE
TUNNEL WORK (UNDERGROUND ONLY) \$.40 DIFFERENTIAL BY AXLE
HAZARDOUS MATERIALS (IN HOT ZONE ONLY) \$2.00 PREMIUM

TRUCK DRIVERS CLASSIFICATIONS

- Group 1: Station wagons; panel trucks; and pickup trucks
- Group 2: Two axle equipment; & forklift operator
- Group 3: Three axle equipment and tireman
- Group 4: Four and Five Axle equipment
- Group 5: Specialized earth moving equipment under 35 tons other than conventional type trucks; low bed; vachual; mechanics, paving restorati on equipment
- Group 6: Specialized earth moving equipment over 35 tons
- Group 7: Trailers for earth moving equipment (double hookup)

FOOTNOTES:

- A. PAID HOLIDAYS: New Year's Day, Washington's Birthday, Memorial Day, Independence Day, Labor Day, Patriot's Day, Columbus Day, Veteran's Day, Thanksgiving Day and Christmas Day
- B. PAID VACATION: Employees with 4 months to 1 year of service receive 1/2 day's pay per month; 1 week vacation for 1 - 5 years of service; 2 weeks vacation for 5 - 10 years of service; and 3 weeks vacation for more than 10 years of service

WELDERS - Receive rate prescribed for craft performing operation to which welding is incidental.

=====
Note: Executive Order (EO) 13706, Establishing Paid Sick Leave for Federal Contractors applies to all contracts subject to the Davis-Bacon Act for which the contract is awarded (and any solicitation was issued) on or after January 1, 2017. If this contract is covered by the EO, the contractor must provide employees with 1 hour of paid sick leave for every 30 hours they work, up to 56 hours of paid sick leave each year. Employees must be permitted to use paid sick leave for their own illness, injury or other health-related needs, including preventive care; to assist a family member (or person who is like family to the employee) who is ill, injured, or has other health-related needs, including preventive care; or for reasons resulting from, or to assist a family member (or person who is like family to the employee) who is a victim of, domestic violence, sexual assault, or stalking. Additional information on contractor requirements and worker protections under the EO is available at www.dol.gov/whd/govcontracts.

Unlisted classifications needed for work not included within the scope of the classifications listed may be added after award only as provided in the labor standards contract clauses (29CFR 5.5 (a) (1) (ii)).

The body of each wage determination lists the classification and wage rates that have been found to be prevailing for the cited type(s) of construction in the area covered by the wage determination. The classifications are listed in alphabetical order of "identifiers" that indicate whether the particular rate is a union rate (current union negotiated rate for local), a survey rate (weighted average rate) or a union average rate (weighted union average rate).

Union Rate Identifiers

A four letter classification abbreviation identifier enclosed in dotted lines beginning with characters other than ""SU"" or ""UAVG"" denotes that the union classification and rate were prevailing for that classification in the survey. Example: PLUM0198-005 07/01/2014. PLUM is an abbreviation identifier of the union, which prevailed in the survey for this

classification, which in this example would be Plumbers 0198 indicates the local union number or district council number where applicable, i.e., Plumbers Local 0198. The next number, 005 in the example, is an internal number used in processing the wage determination. 07/01/2014 is the effective date of the most current negotiated rate, which in this example is July 1, 2014.

Union prevailing wage rates are updated to reflect all rate changes in the collective bargaining agreement (CBA) governing this classification and rate.

Survey Rate Identifiers

Classifications listed under the ""SU"" identifier indicate that no one rate prevailed for this classification in the survey and the published rate is derived by computing a weighted average rate based on all the rates reported in the survey for that classification. As this weighted average rate includes all rates reported in the survey, it may include both union and non-union rates. Example: SULA2012-007 5/13/2014. SU indicates the rates are survey rates based on a weighted average calculation of rates and are not majority rates. LA indicates the State of Louisiana. 2012 is the year of survey on which these classifications and rates are based. The next number, 007 in the example, is an internal number used in producing the wage determination. 5/13/2014 indicates the survey completion date for the classifications and rates under that identifier.

Survey wage rates are not updated and remain in effect until a new survey is conducted.

Union Average Rate Identifiers

Classification(s) listed under the UAVG identifier indicate that no single majority rate prevailed for those classifications; however, 100% of the data reported for the classifications was union data. EXAMPLE: UAVG-OH-0010 08/29/2014. UAVG indicates that the rate is a weighted union average rate. OH indicates the state. The next number, 0010 in the example, is an internal number used in producing the wage determination. 08/29/2014 indicates the survey completion date for the classifications and rates under that identifier.

A UAVG rate will be updated once a year, usually in January of each year, to reflect a weighted average of the current negotiated/CBA rate of the union locals from which the rate is based.

WAGE DETERMINATION APPEALS PROCESS

1.) Has there been an initial decision in the matter? This can be:

- * an existing published wage determination
- * a survey underlying a wage determination
- * a Wage and Hour Division letter setting forth a position on a wage determination matter
- * a conformance (additional classification and rate) ruling

On survey related matters, initial contact, including requests for summaries of surveys, should be with the Wage and Hour Division National Office Branch of Wage Surveys. If the response from this initial contact is not satisfactory, then the process described in 2.) and 3.) should be followed.

With regard to any other matter not yet ripe for the formal process described here, initial contact should be with the Branch of Construction Wage Determinations. Write to:

Branch of Construction Wage Determinations
Wage and Hour Division
U. S. Department of Labor
200 Constitution Avenue, N. W.
Washington, DC 20210

2.) If the answer to the question in 1.) is yes, then an interested party (those affected by the action) can request review and reconsideration from the Wage and Hour Administrator (See 29 CFR Part 1.8 and 29 CFR Part 7). Write to:

Wage and Hour Administrator
U. S. Department of Labor
200 Constitution Avenue, N. W.
Washington, DC 20210

The request should be accompanied by a full statement of the interested party's position and by any information (wage payment data, project description, area practice material, etc.) that the requestor considers relevant to the issue.

3.) If the decision of the Administrator is not favorable, an interested party may appeal directly to the Administrative Review Board (formerly the Wage Appeals Board). Write to:

Administrative Review Board
U. S. Department of Labor
200 Constitution Avenue, N. W.

Washington, DC 20210

4.) All decisions by the Administrative Review Board are final.

=====

END OF GENERAL DECISION"

(THIS PAGE INTENTIONALLY LEFT BLANK)

ATTACHMENT C

Massachusetts Equal Employment Opportunity Package

(THIS PAGE INTENTIONALLY LEFT BLANK)

THE COMMONWEALTH OF MASSACHUSETTS
SUPPLEMENTAL EQUAL EMPLOYMENT OPPORTUNITY, NON-DISCRIMINATION
AND AFFIRMATIVE ACTION PROGRAM

I. Definitions

For purposes of this contract,

“Minority” means a person who meets one or more of the following definitions:

- (a) American Indian or Native American means: all persons having origins in any of the original peoples of North America and who are recognized as an Indian by a tribe or tribal organization.
- (b) Asian means: All persons having origins in any of the original peoples of the Far East, Southeast Asia, the Indian sub-continent, or the Pacific Islands, including, but not limited to China, Japan, Korea, Samoa, India, and the Philippine Islands.
- (c) Black means: All persons having origins in any of the Black racial groups of Africa, including, but not limited to, African-Americans, and all persons having origins in any of the original peoples of the Cape Verdean Islands.
- (d) Eskimo or Aleut means: All persons having origins in any of the peoples of Northern Canada, Greenland, Alaska, and Eastern Siberia.
- (e) Hispanic means: All persons having their origins in any of the Spanish-speaking peoples of Mexico, Puerto Rico, Cuba, Central or South America, or the Caribbean Islands.

“State construction contract” means a contract for the construction, reconstruction, installation, demolition, maintenance or repair of a building or capital facility, or a contract for the construction, reconstruction, alteration, remodeling or repair of a public work undertaken by a department, agency, board, or commission of the commonwealth.

“State assisted construction contract” means a contract for the construction, reconstruction, installation, demolition, maintenance or repair of a building or capital facility undertaken by a political subdivision of the commonwealth, or two or more political subdivisions thereof, an authority, or other instrumentality and whose costs of the contract are paid for, reimbursed, grant funded, or otherwise supported, in whole or in part, by the commonwealth.

II. Equal Opportunity, Non-Discrimination and Affirmative Action

During the performance of this Contract, the Contractor and all subcontractors (hereinafter collectively referred to as “the Contractor”) for a state construction contract or a state assisted construction contract, for him/herself, his/her assignees and successors in interest, agree to comply with all applicable equal employment opportunity, non-discrimination and affirmative action requirements, including but not limited to the following:

In connection with the performance of work under this contract, the Contractor shall not discriminate against any employee or applicant for employment because of race, color, religious creed, national origin, sex, sexual orientation, genetic information, military service, age, ancestry or disability, shall not discriminate in the selection or retention of subcontractors, and shall not discriminate in the procurement of materials and rentals of equipment.

The aforesaid provision shall include, but not be limited to, the following: employment upgrading, demotion, or transfer; recruitment advertising, layoff or termination; rates of pay or other forms of compensation; conditions or privileges of employment; and selection for apprenticeship or on-the-job training opportunity. The Contractor shall comply with the provisions of chapter 151B of the Massachusetts General Laws, as amended, and all other applicable anti-discrimination and equal opportunity laws, all of which are herein incorporated by reference and made a part of this Contract.

The Contractor shall post hereafter in conspicuous places, available for employees and applicants for employment, notices to be provided by the Massachusetts Commission Against Discrimination setting forth the provisions of the Fair Employment Practices Law of the Commonwealth (Massachusetts General Laws Chapter 151B).

In connection with the performance of work under this contract, the Contractor shall undertake, in good faith, affirmative action measures to eliminate any discriminatory barriers in the terms and conditions of employment on the grounds of race, color, religious creed, national origin, sex, sexual orientation, genetic information, military service, age, ancestry or disability. Such affirmative action measures shall entail positive and aggressive measures to ensure non-discrimination and to promote equal opportunity in the areas of hiring, upgrading, demotion or transfer, recruitment, layoff or termination, rate of compensation, apprenticeship and on-the-job training programs. A list of positive and aggressive measures shall include, but not be limited to, advertising employment opportunities in minority and other community news media; notifying minority, women and other community-based organizations of employment opportunities; validating all job specifications, selection requirements, and tests; maintaining a file of names and addresses of each worker referred to the Contractor and what action was taken concerning such worker; and notifying the administering agency in writing when a union with whom the Contractor has a collective bargaining agreement has failed to refer a minority or woman worker. These and other affirmative action measures shall include all actions required to guarantee equal employment opportunity for all persons, regardless of race, color, religious creed, national origin, sex, sexual orientation, genetic information, military service, age, ancestry or disability. One purpose of this provision is to ensure to the fullest extent possible an adequate supply of skilled tradesmen for this and future Commonwealth public construction projects.

III. Minority and Women Workforce Participation

Pursuant to his/her obligations under the preceding section, the Contractor shall strive to achieve on this project the labor participation goals contained herein. Said participation goals shall apply in each job category on this project including but not limited to bricklayers, carpenters, cement masons, electricians, ironworkers, operating engineers and those classes of work enumerated in Section 44F of Chapter 149 of the Massachusetts General Laws. The participation goals for this project shall be 15.3% for minorities and 6.9% for women. The participation goals, as set forth herein, shall not be construed as quotas or set-asides; rather, such participation goals will be used to measure the progress of the Commonwealth's equal opportunity, non-discrimination and affirmative action program. Additionally, the participation goals contained herein should not be seen or treated as a floor or as a ceiling for the employment of particular individuals or group of individuals.

IV. Liaison Committee

At the discretion of the agency that administers the contract for the construction project there may be established for the life of the contract a body to be known as the Liaison Committee. The Liaison Committee shall be composed of one representative each from the agency or agencies administering the contract for the construction project, hereinafter called the administering agency, a representative from the Office of Affirmative action, and such other representatives as may be designated by the administering agency.

The Contractor (or his/her agent, if any, designated by him/her as the on-site equal employment opportunity officer) shall recognize the Liaison Committee as an affirmative action body, and shall establish a continuing working relationship with the Liaison Committee, consulting with the Liaison Committee on all matters related to minority recruitment, referral, employment and training.

V. Reports and Records

The Contractor shall prepare projected workforce tables on a quarterly basis when required by the administering agency. These shall be broken down into projections, by week, of workers required in each trade. Copies shall be furnished one week in advance of the commencement of the period covered, and also, when updated, to the administering agency and the Liaison Committee when required.

The Contractor shall prepare weekly reports in a form approved by the administering agency, unless information required is required to be reported electronically by the administering agency, the number of hours worked in each trade by each employee, identified as woman, minority, or non-minority. Copies of these shall be provided at the end of each such week to the administering agency and the Liaison Committee.

Records of employment referral orders, prepared by the Contractor, shall be made available to the administering agency on request.

The Contractor will provide all information and reports required by the administering agency on instructions issued by the administering agency and will permit access to its facilities and any books, records, accounts and other sources of information which may be determined by the administering agency to effect the employment of personnel. This provision shall apply only to information pertinent to the Commonwealth's supplementary non-discrimination, equal opportunity and access and opportunity contract requirements. Where information required is in the exclusive possession of another who fails or refuses to furnish this information, the Contractor shall so certify to the administering agency and shall set forth what efforts he has made to obtain the information.

VI. Access to Work Site

A designee of the administering agency and a designee of the Liaison Committee shall each have a right to access the work site.

VII. Solicitations for Subcontracts, and for the Procurement of Materials and Equipment

In all solicitations either by competitive bidding or negotiation made by the Contractor either for work to be performed under a subcontract or for the procurement of materials or equipment, each potential subcontractor or supplier shall be notified in writing by the Contractor of the Contractor's obligations under this contract relative to non-discrimination and equal opportunity.

VIII. Sanctions

Whenever the administering agency believes the General or Prime Contractor or any subcontractor may not be operating in compliance with the provisions of the Fair Employment Practices Law of the Commonwealth (Massachusetts General Laws Chapter 151B), the administering agency may refer the matter to the Massachusetts Commission Against Discrimination ("Commission") for investigation.

Following the referral of a matter by the administering agency to the Massachusetts Commission Against Discrimination, and while the matter is pending before the MCAD, the administering agency may withhold payments from contractors and subcontractors when it has documentation that the contractor or subcontractor has violated the Fair Employment Practices Law with respect to its activities on the Project, or if the administering agency determines that the contractor has materially failed to comply with its obligations and the requirements of this Section. The amount withheld shall not exceed a withhold of payment to the General or Prime Contractor of 1/100 or 1% of the contract award price or \$5,000, whichever sum is greater, or, if a subcontractor is in non-compliance, a withhold by the administering agency from the General Contractor, to be assessed by the General Contractor as a charge against the subcontractor, of 1/100 or 1% of the subcontractor price, or \$1,000 whichever sum is greater, for each violation of the applicable law or contract requirements. The total withheld from any one General or Prime Contractor or subcontractor on a Project shall not exceed \$20,000 overall. No withhold of payments or investigation by the Commission or its agent shall be initiated without the administering agency providing prior notice to the Contractor.

If, after investigation, the Massachusetts Commission Against Discrimination finds that a General or Prime Contractor or subcontractor, in commission of a state construction contract or state-assisted construction contract, violated the provisions of the Fair Employment Practices Law, the administering agency may convert the amount withheld as set forth above into a permanent sanction, as a permanent deduct from payments to the General or Prime Contractor or subcontractor, which sanction will be in addition to any such sanctions, fines or penalties imposed by the Massachusetts Commission Against Discrimination:

No sanction enumerated under this Section shall be imposed by the administering agency except after notice to the General or Prime Contractor or subcontractor and an adjudicatory proceeding, as that term is used, under Massachusetts General Laws Chapter 30A, has been conducted.

IX. Severability

The provisions of this section are severable, and if any of these provisions shall be held unconstitutional by any court of competent jurisdiction, the decision of such court shall not affect or impair any of the remaining provisions.

X. Contractor's Certification

A bidder for a state construction contract or state assisted construction contract will not be eligible for award of the contract unless such bidder has submitted to the administering agency the following certification, which will be incorporated into the resulting contract:

CONTRACTOR'S CERTIFICATION

_____ certifies that they:
(Contractor Name)

1. Will not discriminate in their employment practices;
2. Intend to use the following listed construction trades in the work under the contract

_____ ; and
3. Will make good faith efforts to comply with the minority employee and women employee workforce participation ratio goals and specific affirmative action steps contained herein; and
4. Are in compliance with all applicable federal and state laws, rules, and regulations governing fair labor and employment practices; and
5. Will provide the provisions of the "Supplemental Equal Employment Opportunity, Non-Discrimination and Affirmative Action Program" to each and every subcontractor employed on the Project and will incorporate the terms of this Section into all subcontracts and work orders entered into on the Project.
6. Agree to comply with all provisions contained herein.

(Signature of authorized representative of Contractor) Date

(Printed name of authorized representative of Contractor)

XI. Subcontractor Requirements

Prior to the award of any subcontract for a state construction contract or a state assisted construction contract, regardless of tier, the Prime or General Contractor shall provide all prospective subcontractors with a complete copy of this Section entitled "Supplemental Equal Employment Opportunity, Non-Discrimination and Affirmative Action Program" and will incorporate the provisions of this Section by reference into any and all contracts or work orders for all subcontractors providing work on the Project. In order to ensure that the said subcontractor's certification becomes a part of all subcontracts under the prime contract, the Prime or General Contractor shall certify in writing to the administering agency that it has complied with the requirements as set forth in the preceding paragraph.

CONSTRUCTION BID SPECIFICATIONS
SPECIAL PROVISIONS FOR DISADVANTAGED BUSINESS ENTERPRISES
MASSACHUSETTS DEPARTMENT OF ENVIRONMENTAL PROTECTION

DIVISION OF MUNICIPAL SERVICES

DISADVANTAGED BUSINESS ENTERPRISE PROGRAM BACKGROUND

In May 2008 a new United States Environmental Protection Agency (EPA) rule became effective that changed the Minority Business Enterprise (MBE) and Women Business Enterprise (WBE) Program to a Disadvantaged Business Enterprise (DBE) Program.

For firms to qualify under the old MBE/WBE program they needed to be socially disadvantaged and had to be certified by the State Office of Minority and Women Business Assistance (SOMWBA), recently renamed the Supplier Diversity Office (SDO). Under the new DBE rule, the firms must be both **socially** and **economically** disadvantaged, citizens of the United States, and certified as a DBE. Women and certain minorities are presumed to be socially disadvantaged. The economic disadvantage is measured by the owner's initial and continuing personal net worth of less than \$1,320,000.

Because the Clean Water Act requires the use of MBEs and WBEs, these firms will still be utilized in the State Revolving Fund (SRF) Loan Program, but they must also be certified as DBEs.

SDO (formerly SOWMBA) will continue to be the certifying agency for the SRF program.

BID SPECIFICATIONS

I. In this contract, the percentage of business activity to be performed by disadvantaged business enterprise(s) (DBE) shall not be less than the following percentages of the total contract price or the percentage submitted by the contractor in the Schedule of Participation, whichever is greater:

Disadvantaged MBE (D/MBE) 6.6% Disadvantaged WBE (D/WBE) 6.4%

II. DEFINITIONS

For the purpose of these provisions, the following terms are defined as follows:

- A. Awarding Authority – Entity that awards a prime contract under a State Revolving Fund loan.
- B. Bidder - Any individual, partnership, joint venture, corporation, or firm submitting a price, directly or through an authorized representative, for the purpose of performing construction or construction related activities under a Contract.
- C. Certified DBE – A DBE certified by the United States Small Business Administration, under its 8(a) Business Development Program (13 CFR part 124, subpart A) or its Small Disadvantaged Business Program (13 CFR part 124, subpart B); The United States Department of Transportation (DOT), under its regulations for Participation by DBEs in DOT programs (49 CFR parts 23 and 26); or SDO in accordance with 40 CFR part 33; provided that the certification meets the U.S. citizenship requirement under 40 CFR §33.202 or §33.203.
- D. Compliance Unit - A subdivision of MassDEP’s Affirmative Action Office designated to ensure compliance under these provisions.
- E. Contractor - Any business that contracts or subcontracts for construction, demolition, renovation, survey, or maintenance work in the various classifications customarily used in work and that is acting in this capacity under the subject contract.
- F. Construction Related Services - Those services performed at the work site ancillary to, and/or in support of, the construction work, such as hauling, trucking, equipment operation, surveying or other technical services, etc. For the purposes hereof, supply and delivery of materials (e.g. pre-cast concrete elements) to the site by a supplier who has manufactured those goods, or substantially altered them before re-sales shall be considered as “construction related services
- G. Construction Work - The activities at the work site, or labor and use of materials in the performance of constructing, reconstructing, erecting, demolishing, altering, installing, disassembling, excavating, etc, all or part of the work required by the Contract Documents.
- H. Disadvantaged Business Enterprise (DBE) - An entity owned or controlled by a socially and economically disadvantaged individual as described by Public Law 102-389 (42 U.S.C. 4370d) or an entity owned and controlled by a socially and economically disadvantaged individual as described by Title X of the Clean Air Act Amendments of 1990 (42 U.S.C. 7601 note); a Small Business Enterprise (SBE); a Small Business in a Rural Area (SBRA); or a Labor Surplus Area Firm (LAF), a Historically Underutilized Business (HUB) Zone Small Business Concern, or a concern under a successor program.
- I. Equipment Rental Firm - A firm that owns equipment and assumes actual and contractual responsibility for renting said equipment to perform a useful function of the work of the contract consistent with normal industry practice
- J. Good Faith Efforts – The race and/or gender neutral measures described in 40 CFR 33, subpart C.

- K. HUBZone - A historically underutilized business zone, which is an area located within one or more qualified census tracts, qualified metropolitan counties, or lands within the external boundaries of an Indian reservation.
- L. HUBZone small business concern - A small business concern that appears on the List of Qualified HUBZone Small Business Concerns maintained by the Small Business Administration.
- M. Joint Venture - An agreement between SDO certified DBE and a non-DBE or non-DBE controlled enterprise.
1. A pairing of companies will be considered a DBE joint venture if the SDO certified DBE which is part of the relationship has more than 51% of the profits that are derived from that project.
 2. A joint venture between a certified DBE subcontractor and a non DBE subcontractor, in which the DBE for that proportion of the joint venture's contract equal to the DBE participation in the joint venture.
 3. Whenever a general bid is filed by a joint venture with a certified DBE participant in the joint venture that does not exercise more than 51% control over management and profits, that joint venture shall be entitled to credit as a DBE for that portion of the joint venture's contract equal to the DBE participation in the joint venture. Minority As deemed by SDO.
- N. Labor surplus area firm (LSAF) - A concern that together with its first-tier subcontractors will perform substantially in labor surplus areas (as identified by the Department of Labor in accordance with 20 CFR part 654). Performance is substantially in labor surplus areas if the costs incurred under the contract on account of manufacturing, production or performance of appropriate services in labor surplus areas exceed 50 percent of the contract price.
- O. Letter of Intent – Certified document signed by the principal(s) of the DBE with respect to the work to be performed under contract.
- P. Local Government Unit – A city, town, or municipal district which applies for a loan under the Water Pollution Abatement Trust Program.
- Q. Material Supplier – A vendor certified by SDO as a DBE in sales to supply industry from an established place of business or source of supply, and that vendor.
1. Manufactures goods from raw materials, or substantially utilizes them in the work, or substantially alters them before resale, entitling the general contractor to DBE credit for 100% of the purchase order.
 2. Provides and maintains a storage facility for materials utilized in the work, entitling the general contractor to DBE credit for 10% of the purchase order
- R. Minority and Women Business Enterprise (M/WBE) – Any business concern certified by the SDO as a bona-fide M/WBE. A bona-fide M/WBE is a business whose minority group/women ownership interests are real, which have at least 51% ownership and control over management and operation.
- S. Percent of Total Price – Is the percentage to be paid to the DBE, work they perform, as compared to the total bid price
- T. Recipient - An agency, person or political subdivision which has been awarded or received financial assistance by the Trust or MassDEP.
- U. Small business, small business concern or small business enterprise (SBE) - A concern, including its affiliates, that is independently owned and operated, not

- dominant in the field of operation in which it is bidding, and qualified as a small business under the criteria and size standards in 13 CFR part 121.
- V. Small business in a rural area (SBRA) - A small business operating in an area identified as a rural county with a code 6-9 in the Rural-Urban continuum Classification Code developed by the United States Department of Agriculture in 1980.
 - W. SDO – The Supplier Diversity Office.
 - X. Subcontractor – A company, firm, joint venture, or individual who enters into an agreement with a contractor to provide services pursuant to an award of financial assistance.
 - Y. Total Contract Price – The total amount of compensation to be paid for all materials, work or services rendered in the performance of the contract
 - Z. Trust – The Massachusetts Water Pollution Abatement Trust established by M.G.L. c.29.

III. REQUIREMENTS FOR CONTRACT AWARD

DBE packages must be submitted by the two lowest bidders on the project. Following bid opening, the LGU shall notify the two lowest bidders to submit DBE packages to the LGU or the LGUs consultant, as directed. By the close of business on the third business day after notification, the two lowest bidders, including a bidder who is a MBE, WBE or DBE, shall submit the following information:

- A. A Schedule of Participation (Form EEO-DEP-190). The Schedule of Participation shall list those certified DBEs the bidder intends to use in fulfilling the contract obligations, the nature of the work to be performed by each certified DBE subcontractor and the total price they are to be paid.
 - 1. A listing of bona-fide services such as a professional, technical, consultant or managerial services, assistance in the procurement of essential personnel, facilities, equipment, materials, or supplies required for performance of the contract, and reasonable fees or commissions charged.
 - 2. A listing of haulers, truckers, or delivery services, not the contractors, including reasonable fees for delivery of said materials or supplies to be included on the project.
- B. A Letter of Intent (Form EEO-DEP-191) for each DBE the bidder intends to use on the project. The Letter of Intent shall include, among other things, a reasonable description of the work the certified DBE is proposing to perform and the prices the certified DBE proposes to charge for the work. A Letter of Intent shall be jointly signed by the certified DBE and the General Contractor who proposes to use them in the performance of the Contract.
- C. The SDO “DBE Certification” as prepared by each certified DBE.
- D. A completed Request for Waiver form and backup documentation should the goals not be achieved (See IV below).

IV. REQUIREMENTS FOR MODIFICATION OR WAIVERS.

The bidder shall make every possible effort to meet the minimum requirements of certified DBE participation. If the percentage of certified DBE participation submitted by the bidder on its Schedule of Participation (EEO-DEP-190) does not meet the minimum requirements, the bid may be rejected by the Awarding Authority and found not to be eligible for award of the contract.

In the event that a bidder is unable to meet the minimum requirements of certified DBE participation, the bidder shall submit with his/her bid a Request for Waiver (EEO-DEP-490) form. If directed by the Awarding Authority, the Bidder may submit the waiver request and supporting documentation to MassDEP within five (5) working days following bid opening, by registered mail. MassDEP in conjunction with the project manager, the Compliance Unit, will determine whether the waiver will be granted.

The waiver request shall include detailed information as specified below to establish that the bidder has made a good faith effort to comply with the minimum requirements of certified DBE participation specified in Part I. In addition, the bidder must show that such efforts were undertaken well in advance of the time set for opening of bids to allow adequate response. A waiver request shall include the following:

- A. A detailed record of the effort made to contact and negotiate with the certified DBE, including, but not limited to:
 1. names, addresses and telephone numbers of all such companies contacted;
 2. copies of written notices(s) which were sent to certified DBE potential subcontractors, prior to bid opening;
 3. a detailed statement as to why each subcontractor contacted (i) was not willing to do the job or (ii) was not qualified to perform the work as solicited; and
 4. in the case(s) where a negotiated price could not be reached the bidder should detail what efforts were made to reach an agreement on a competitive price;
 5. copies of advertisements, dated not less than ten (10) days prior to bid opening, as appearing in general publications, trade-oriented publications, and applicable minority/ women-focused media detailing the opportunities for participation.
- B. MassDEP may require the bidder to produce such additional information as it deems appropriate.
- C. No later than fifteen (15) days after MassDEP receives all required

information and documentation, it shall make a decision in writing, whether the waiver is granted and shall provide that determination to the bidder and Awarding Authority. If the waiver request is denied, the facts upon which a denial is based will be set forth in writing. If the waiver request is denied, the bid shall be rejected by the Awarding Authority.

If at any time, MassDEP determines that one or more of the DBE contractors submitted by the bidder on form EEO-DEP-190 is not certified, the bidder shall have 10 working days, following notification, to either find a certified DBE to perform work equal to or greater than that of the uncertified contractor or to submit a waiver request pursuant to this section.

V. DISADVANTAGED BUSINESS ENTERPRISES PARTICIPATION

A. Reporting Requirements

1. The Contractor's utilization of certified DBEs will be documented based upon submittal of the Local Government Unit's monthly Payment Requisitions as reported on Form-2000. The Form-2000 form will show all certified DBEs performing work on the project regardless of any billing activity for that month. For auditing and accounting purposes, the Contractor periodically may be required to submit copies of canceled checks verifying that payments have been made to the certified DBE as listed on the schedule. The Contractor may also be required to submit current schedules on utilization of all DBEs to indicate when their services will commence and be billed for.
2. During the life of the Contract, the Contractor's fulfillment of the percentage requirements in Part I shall be determined with reference to the Contract price as follows:
 - A. If the price in the Contract executed exceeds the base bid price (e.g., because an alternate was selected or because unit prices were used in awarding the Contract), the Contractor shall submit for approval by MassDEP a revised Schedule of Participation by certified DBEs satisfying the percentage requirements and such other information concerning additional DBE participation as may be requested by MassDEP.
 - B. If the Contract price increases after execution due to change orders or other adjustments, MassDEP may require the Contractor to subcontract additional work or to purchase additional goods and services from certified DBEs up to the percentages stated in Part I.

VI. COMPLIANCE

- A. If the Schedule or any of the Letters of Intent are materially incomplete, the Local Government Unit may rescind its vote of award; treat the bid informal as to substance and reject the bid. If the bid is incomplete in any other respect than the Schedule the Local Government Unit with the approval of MassDEP may waive the informalities upon satisfactory completion of the required information by the Contractor and the certified DBE as applicable.
- B. If the Local Government Unit finds that the percentage of certified DBE participation submitted by the contractor on its Schedule does not meet the percentage requirement in Part I, it shall rescind its vote of award and find such contractor not to be eligible for award of the contract.
- C. The Contractor shall not perform with its own organization, or subcontract to any other primary or subcontractor any work designated for the named certified DBEs on the schedule submitted by the Contractor under Part III without the approval of MassDEP.
- D. A Contractor's compliance with the percentage requirement in Part I shall continue to be determined by reference to the required percentage of the total

contract price as stated in Section I even though the total of actual contract payments may be greater or less than the bid price.

- E. If the Contractor for reasons beyond its control cannot comply with Part III in accordance with the Schedule submitted under Part III, Section B, the contractor must submit to MassDEP as soon as they are aware of the deficiency, the reason for its inability to comply. Proposed revisions to the Schedule stating how the contractor intends to meet its obligations under these conditions must be submitted within ten (10) working days of notification.
- F. If the Contractor is becomes aware by any means that that DBE is no longer certified, the Contractor shall immediately notify MassDEP. The Contractor shall use good faith efforts to retain a substitute certified DBE.
- G. If a certified DBE listed by the bidder in its Schedule of M/WBE contractors fails to obtain a performance or payment bond requested by the bidder, said failure shall not entitle the bidder to avoid the requirements of Part III (A). After a bidder has been awarded the contract, he shall not change the certified DBE listed in its Schedule at the time of the award or make any other such substitutions without the written approval of MassDEP.

VII. SANCTIONS

- A. If the Contractor does not comply with the terms of these Special Provisions, the Awarding Authority may (1) suspend any payment for the work that should have been performed by a certified DBE pursuant to the schedule, or (2) require specific performance of the Contractor's obligation by requiring the Contractor to subcontract with a DBE for any contract or specialty item at the contract price established for that item in the proposal submitted by the Contractor.
- B. To the extent that the Contractor has not complied with the terms of these Special Provisions, the Awarding Authority may retain in connection with Estimates and Payments an amount determined by multiplying the bid price of this contract by the percentage in Section I, less the amount paid to DBE's for work performed under the contract and any payments already suspended under VIII A.
- C. The Awarding Authority may suspend, terminate or cancel this contract, in whole or in part, or may call upon the Contractor's surety to perform all terms and conditions in the contract, unless the contractor is able to demonstrate his compliance with the terms of these Special Provisions, and further deny to the Contractor, the right to participate in any future contracts awarded by the Awarding Authority for a period of up to three years.
- D. In any proceeding involving the imposition of sanctions by the Awarding Authority, no sanctions shall be imposed if the Awarding Authority finds that the contractor has taken every possible measure to comply with these Special Provisions or that some other justifiable reason exists for waiving these Special Provisions in whole or in part.
- E. The contract shall provide such information as is necessary in the judgment of the Awarding Authority to ascertain its compliance with the terms of these Special Provisions.
- F. A contractor shall have the right to request suspension of any sanctions imposed under this section upon demonstrating that he is in compliance with these Special Provisions.

DISADVANTAGED BUSINESS ENTERPRISE PARTICIPATION
 MASSACHUSETTS DEPARTMENT OF ENVIRONMENTAL PROTECTION
 DIVISION OF MUNICIPAL SERVICES

SCHEDULE OF PARTICIPATION FOR SRF CONSTRUCTION

Project Title: _____ **Project Location:** _____

Disadvantaged Minority Business Enterprise Participation in the SRF Loan Work

Name & Address of D/MBE	Nature of Participation	Dollar Value of Participation
1.		
2.		
3.		
Total D/MBE Commitment:		\$
Percentage D/MBE Participation = (Total D/MBE Commitment) / (Bid Price) =		%

Disadvantaged Women Business Enterprise Participation in the SRF Loan Work

Name & Address of D/WBE	Nature of Participation	Dollar Value of Participation
1.		
2.		
3.		
Total D/WBE Commitment:		\$
Percentage D/WBE Participation = (Total D/WBE Commitment) / (Bid Price) =		%

The Bidder agrees to furnish implementation reports as required by MassDEP to indicate the D/MBEs and D/WBE(s) which it has used or intends to use. Breach of this commitment constitutes a breach of the contract.

Name of Bidder: _____

Date: _____ By: _____

Signature

NOTE: Participation of a DBE may be counted in only their certified category; the same dollar participation cannot be used in computing the percentage of D/MBE participation and again of D/WBE participation.

LETTER OF INTENT FOR SRF CONSTRUCTION

This form is to be completed by the D/MBE and D/WBE and must be submitted by the Bidder as part of the bid. A separate form must be completed for each D/MBE and D/WBE involved in the project.

Project Title: _____ Project Location: _____

TO: _____
(Name of Bidder)

FROM: _____
(Please Indicate Status [] D/MBE or [] D/WBE)

° I/we intend to perform work in connection with the above project as (check one):

- An individual
- A partnership
- A corporation
- A joint venture with: _____
- Other (explain): _____

° It is understood that if you are awarded the contract, you intend to enter into an agreement to perform the activity described below for the prices indicated.

DBE PARTICIPATION

Description of Activity	Date of Project Commencement	\$ Amount	% Bid Price
		\$	%

° The undersigned certify that they will enter into a formal agreement upon execution of the contract for the above referenced project.

BIDDER		DBE	
(Authorized Original Signature)	Date	(Authorized Original Signature)	Date
ADDRESS:		ADDRESS:	
TELEPHONE #:		TELEPHONE #:	
FEIN:		FEIN:	

ORIGINALS:

- ° Compliance Mgr. City/Town Project Location
- ° DEP Program Manager for DEP's AAO Director

*** Attach a copy of current (within 2 years) DBE Certification**

If it is determined that one or more of the DBE subcontractors as submitted by the Bidder on this form is not a certified DBE, the Bidder shall have an opportunity, following notification, to either find a certified DBE subcontractor to perform work equal to or greater than that of the uncertified subcontractor or to submit a waiver request.

DISADVANTAGED BUSINESS ENTERPRISE PROGRAM
DBE SUBCONTRACTOR PARTICIPATION FORM

The United States Environmental Protection Agency (EPA) requires that this form be provided to all subcontractors on the project. At the option of the subcontractor, this form may be filled out and submitted directly to the EPA DBE Coordinator.

NAME OF SUBCONTRACTOR	PROJECT NAME
ADDRESS	CONTRACT NO.
TELEPHONE NO.	E-MAIL ADDRESS
PRIME CONTRACTOR NAME:	

Please use the space below to report any concerns regarding the above EPA-funded project (e.g., reason for termination by prime contractor, late payment, etc.).

CONTRACT ITEM NO.	ITEM OF WORK OR DESCRIPTION OF SERVICES RECEIVED FROM THE PRIME CONTRACTOR	AMOUNT SUBCONTRACTOR WAS PAID BY PRIME CONTRACTOR

_____	_____
Subcontractor Signature	Title/Date

REQUEST FOR WAIVER FOR SRF CONSTRUCTION

Upon exhausting all known sources and making every possible effort to meet the minimum requirements for DBE participation, the Bidder may seek relief from these requirements by filing this form with the bid and submitting a completed waiver package NO LATER THAN FIVE (5) working days following bid opening. Failure to comply with this process shall be cause to reject the bid thereby rendering the Bidder not eligible for award of the contract.

General Information

Project Title: _____ Project Location: _____
Bid Opening (time/date) _____
Bidder: _____
Mailing Address: _____
Contact Person: _____ Telephone No. () _____ Ext. _____

Minimum Requirements

The bidder must show that good faith efforts were undertaken to comply with the percentage goals as specified. The firm seeking relief must show that such efforts were taken appropriately in advance of the time set for opening bid proposals to allow adequate time for response(s) by submitting the following:

- A. A detailed record of the effort made to contact and negotiate with disadvantaged minority and/or woman owned businesses, including:
1. names, addresses, telephone numbers and contact dates of all such companies contacted;
 2. copies of written notice(s) which were sent to DBE potential subcontractors prior to bid opening;
 3. a detailed statement as to why each subcontractor contacted (i) was not willing to do the job or (ii) was not qualified to perform the work as solicited; and
 4. in the case(s) where a negotiated price could not be reached the bidder should detail what efforts were made to reach an agreement on a competitive price.
 5. copies of advertisements, dated not less than ten (10) days prior to bid opening, as appearing in general publications, trade-oriented publications, and applicable minority/women-focused media detailing the opportunities for participation;

- B. MassDEP may require the bidder to produce such additional information as it deems appropriate.
- C. No later than fifteen (15) days after submission of all required information and documentation, MassDEP shall make a determination, in writing, whether the waiver request is granted and shall provide that determination to the bidder and Awarding Authority. If the waiver request is denied, the facts upon which a denial is based will be set forth in writing.

Special Note

If at any time, MassDEP determines that one or more of the DBE contractors as submitted by the bidder on form EEO-DEP-190C is not certified, the bidder shall have 10 working days, following notification to MassDEP, to either find a certified DBE contractor to perform work equal to or greater than that of the uncertified contractor or submit a waiver request.

CERTIFICATION

The undersigned herewith certifies that the above information and appropriate attachments are true and accurate to the best of my knowledge and that I have been authorized to act on behalf of the bidder in this matter.

(authorized original signature)

DATE

MAILING INSTRUCTIONS: (CERTIFIED MAIL)

TO: DEP-DMS PROGRAM MANAGER _____
ONE WINTER STREET – 6TH FLOOR
BOSTON, MA 02108-4747

CC: DEP - CRU DIRECTOR
ONE WINTER STREET - 4TH FLOOR
BOSTON, MA 02108-4747

Contract Value _____

The United States Environmental Protection Agency (EPA) requires that all SRF borrowers develop and maintain a list of all MBE/WBE and non MBE/WBE subcontractors on the project.

This form must be completed and returned to MassDEP within 90 days of award of the contract.

DEPARTMENT OF ENVIRONMENTAL PROTECTION
BUREAU OF RESOURCE PROTECTION
DIVISION OF MUNICIPAL SERVICES POLICIES

The Division of Municipal Services (DMS) has established the following policies for all Division financially-assisted projects.

POLICY MEMORANDUM NO. CG-1

EASEMENTS AND RIGHTS OF WAY

Prior to the approval of financial assistance for construction, the owner shall obtain and shall thereafter retain, a fee simple or such estate or interest in the site of construction and rights of access as will assure undisturbed use and possession for the purpose of construction and operation for the estimated life of the project. The Division may refuse to approve financial assistance until it has received from the owner sufficient assurances that such interests have been obtained. Unless the Division otherwise notifies the owner, the certificate (under pains and penalties of perjury) of the owner's legal representative shall constitute such sufficient assurance.

Additional cost which result from interruptions of construction or extensions of contract time caused by the owner's failure to obtain the necessary interests in land shall be ineligible for financial assistance, and all such additional costs shall be borne by the owner.

POLICY MEMORANDUM NO. CG-2

PERMITS

The owner shall be responsible for identifying and obtaining all federal, state, local and railroad permits required by the nature and location of construction, including but not limited to building construction permits and permits for street and highway cuts and openings, and all such permits shall be listed in a separate permits section of the contract documents. To the extent possible, such permits shall be obtained by the owner prior to the solicitation of bids for construction, and copies of all permits so obtained shall be included in the said permits section. The status of the application for each permit, including the permit conditions, and costs, not obtained prior to the solicitation of bids shall also be indicated in the contract documents permits section. The Division may refuse to approve financial assistance for construction unless and until it has received from the owner sufficient assurances that all necessary permits have been or will be obtained prior to the commencement of construction.

The contractor shall be responsible for obtaining all permits required of his equipment, work force, or particular operations (such as blasting) in the performance of the contract and not otherwise specified in the two preceding paragraphs as to be obtained by the owner. These permit fees shall be paid by the contractor.

The owner shall be responsible for the payment of all other permit fees required by the construction.

The following permits shall not be eligible for financial participation by the Department of Environmental Protection (DEP).

- Permits and insurance for construction in railroads' rights of way;
- Building permits;
- Permits for opening public streets and other public or municipal rights of way;
- Permits for the use of explosives;
- Permits for the disposal of waste materials;
- Permits and fees for connecting to municipal utilities.

Permits required by extraordinary circumstances and not specifically excluded from eligibility above may be eligible for DEP participation. For such permits to be so eligible, the owner or his representative must notify the DEP project engineer in advance of obtaining such permit and receive from the engineer specific agreement that such permit will be eligible for DEP participation. Eligibility for such participation will not be made retroactively.

Additional costs which result from interruptions of construction or extensions of contract time resulting from the owner's or the contractor's failure to obtain the necessary permits may be ineligible for participation.

POLICY MEMORANDUM NO. CG-3

FIELD CONTROLS

The Owner shall be responsible for indicating on the contract drawings all easement limits and all property and other control lines for locating the principal component parts of the work together with those elevations and bench marks used in the design of the work, all hereinafter referred to as "field controls". Where easement and property limits have not previously been established in the field, the owner shall be responsible for establishment of such limits. From the information provided by the Owner, unless otherwise specified, the Contractor shall develop and make all layouts required for construction, such as slope stakes, batter boards, stakes for pipe locations and other working points, lines, elevations and cut sheets.

Whenever he has reason to believe that an error exists or whenever he is otherwise unable to locate the field controls, the contractor shall promptly notify the owner and the owner's engineer of such error with appropriate documentation.

POLICY MEMORANDUM NO. CG-4

RECORD DRAWINGS:

The Owner shall be responsible for the preparation of all record drawings required by this contract. This responsibility may be delegated to the Owner's representative. The responsibility for preparation of record drawings shall not be delegated or transferred to the contractor. They may use the contractor's and sub-contractor's certified AS BUILT drawings along with their own marked up set in the preparation of the Record Drawings.

Division approved contract drawings shall be revised upon completion of the contract to reflect any changes made and/or final quantities, as appropriate.

POLICY MEMORANDUM NO. CG-5

PLAN SCALE

Unless otherwise approved in advance by the Division, the horizontal scale for construction plans for non-structural facilities shall be 1" = 40'. A larger horizontal scale shall be used where appropriate to show sufficient detail to construct the project. The vertical scale for construction plans for non-structural facilities shall be 1" = 4'. Based on the best information available at the time of their preparation, the location of underground utilities and support structures for overhead utilities shall be shown on the plans.

Unless otherwise exempted in advance by the Division, construction plans shall be updated whenever the date of the advertisement for bids for the construction of such facilities is more than one year after the date of approval by the Division or EPA; and in the case of approval by both such agencies, the later approval date shall be used in determining the need for update.

The consulting engineer shall receive adequate compensation for updating plans and specifications, and such additional cost shall be eligible for assistance to the extent not otherwise prohibited by USEPA and Division regulations and program guidance.

All revision, or review without need for revision, shall be noted and dated on the plans prior to advertisement of the project for bid.

POLICY MEMORANDUM NO. CG-6

BORINGS LOGS

All soil borings shall be taken as close as practicable to the construction line, and the location of all such borings shall be clearly indicated on the contract drawings. The plan view shall show the location and boring number of each boring. The profile view shall show the location, elevation, and depth of each soil boring, the location of each change in soil stratum, the groundwater level, and the average of blow counts at each five foot interval. As a minimum, boring logs to be submitted with the plans and specifications shall show the name of the company taking the borings, the soil classification, the number of blows per foot of penetration, the groundwater elevation, and the date on which the borings were taken.

As part of the submission of plans and specification for approval, the owner's representative shall include written justification for the lesser frequency and depth of borings where their interval is more than approximately 300' or their depth is less than 50% below depth of pipe invert.

POLICY MEMORANDUM NO. CG-7

BREAKDOWN OF BID ITEMS

The following items shall, where applicable, be listed separately in the bid documents.

1. Mobilization
2. Pavement
 - a. Municipal
 - i. temporary
 - ii. permanent
 - b. State
 - i. temporary
 - ii. permanent
4. Rock-Excavation
5. Wood or steel sheeting left in place
6. Excavation of unsuitable materials below grade.
7. Select and/or borrow material
8. Dewatering
9. Special Dewatering (coffer dam)

3. Concrete cradle or encasement
(to be identified where applicable)

Mobilization costs are the costs of initiating the contract, exclusive of the cost of materials. Payment for mobilization shall be a lump sum at the price bid for this item in the proposal and shall be payable when the contractor is operational on the site. For purposes of this policy, “operational” shall mean the substantial commencement of work on site.

The lump sum price bid for mobilization shall not exceed five per centum (5%) of the total amount of the bid.

POLICY MEMORANDUM NO. CG-8

PAVEMENT

All roads and trenches therein shall be refilled and repaved in accordance with specifications provided by the owner in the contract documents. Please note that this policy may be excludable on federally assisted projects where bid alternative items may be required (i.e. trench width vs. full width pavement). You are advised to seek project specific clarification.

Loan eligibility shall be limited to the following:

- A. Where the depth of the pipe invert is 0 to 8’, the maximum pavement widths which shall be eligible for financial assistance are as follows:

<u>Nominal Pipe Diameter</u>	<u>Maximum Eligible Widths</u>	
	<u>Initial Pavement</u>	<u>Permanent Trench</u>
0-24”	6’-6”	8’-6”

Where the nominal pipe diameter is greater than 24” the maximum eligible width for initial re-paving shall be the nominal diameter of the pipe plus four (4) feet, and for permanent trench re-paving the maximum eligible width shall be the nominal pipe diameter plus six (6) feet.

- B. For each additional four (4) feet (or fraction thereof) of pipe invert depth, add three feet to the eligible width limits stated in paragraph A.

At the design phase of a project the owner has the option to elect either Initial Pavement with Option I (Permanent Trench replacement) or Initial with Option II (curb to curb over initial)

Initial Pavement

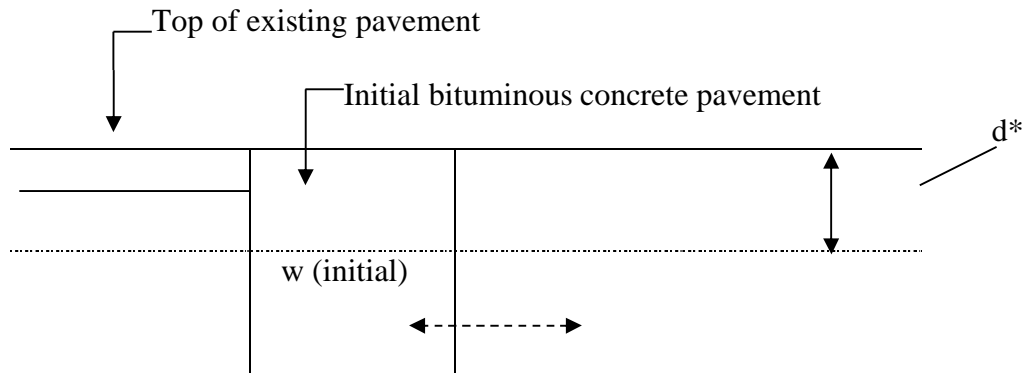

d^* = depth of existing pavement to a maximum of 3 inches (see general notes #3)

w = maximum eligible Initial pavement width as described in paragraphs "A" & "B" on page DEP-DMS-CG's-P4.

OPTION I Permanent Trench Pavement

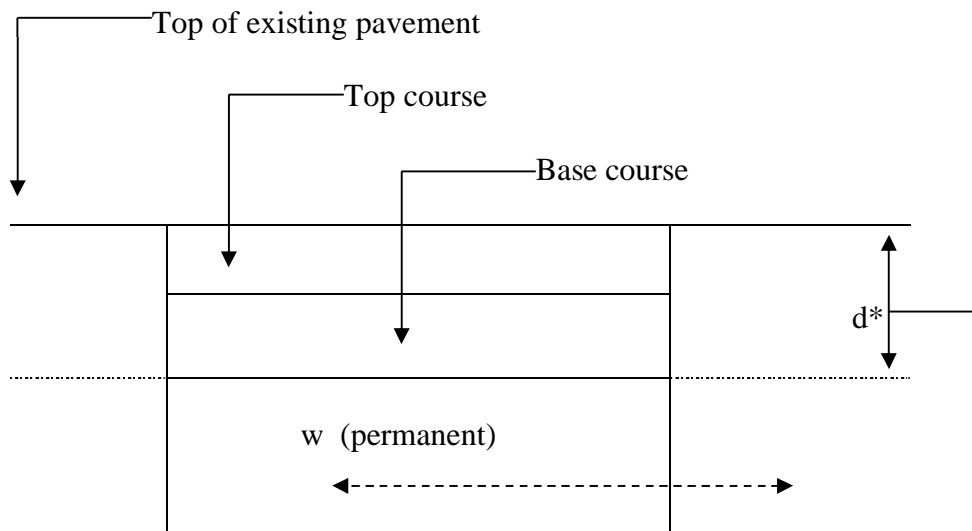

d^* = depth of existing pavement trench to a maximum of 3 inches (see general notes #3)

w = maximum eligible permanent pavement width as described in paragraphs "A" & "B". equals initial width plus 2 feet and includes:

- Cutting edges for the permanent trench
- Removal of initial patch plus two feet of existing pavement
- Fine grading/compacting gravel
- Placement of Permanent Trench pavement in two courses.

OPTION II Curb to Curb Pavement (overlay pavement for roadways up to 28 feet)

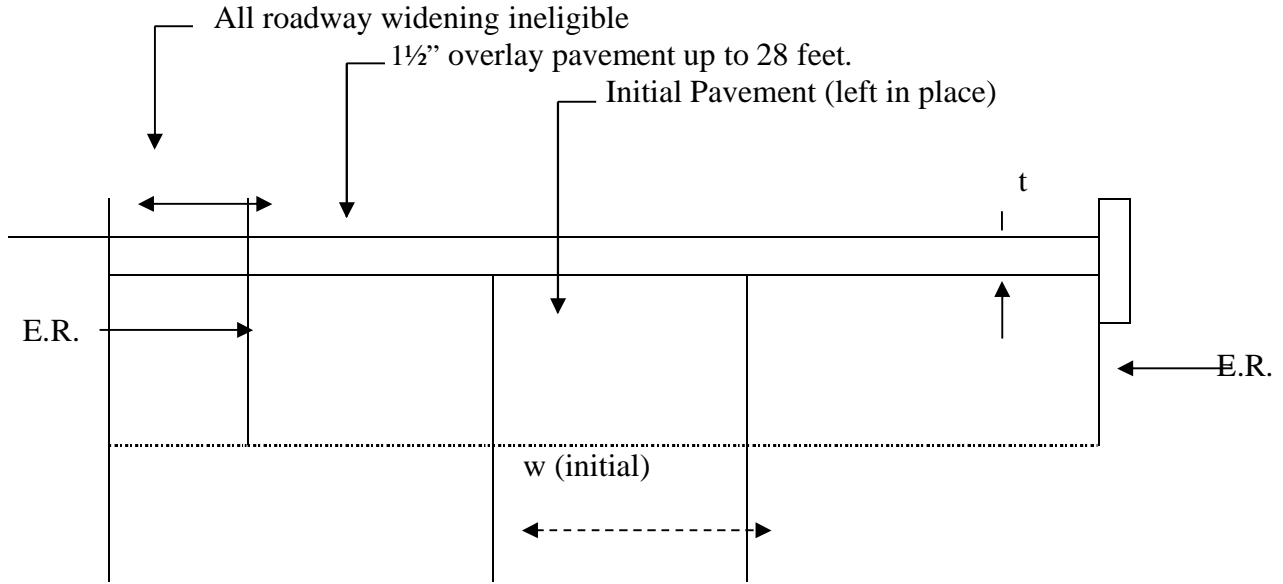

E.R.= edge of existing paved roadway

t = one and one half inch (1 1/2") overlay of bituminous concrete pavement

GENERAL NOTES:

1. Repavement of settled areas and crown restoration within the trench limits shall be the responsibility of the contractor.
2. Leveling outside the trench limits shall be the responsibility of the owner.
3. Sewer trench re-fill and pavement re-paving on public ways under the jurisdiction of the Massachusetts Department of Public Works, the Metropolitan District Commission, or other such agency shall be in accordance with permit(s) issued therefore by that Department or Commission, as the case may be.
4. The Division will consider requests for increase in the participating pay limits defined in paragraphs A and B, when such increases are, in the Division's opinion, reasonable. Such requests should be documented in writing and submitted to the Division in a timely manner.
5. Projects which deviate from the above options are required to seek Division review and approval.

POLICY MEMORANDUM NO. CG-9

PIPE TESTING

Monthly payment estimates shall be prepared in accordance with contract documents. All pipe shall be tested in accordance with the contract documents and sound engineering practice. If, after 60 days following submission of a monthly payment estimate for pipe items, the pipe for which payment is requested has not been successfully tested, the owner may withhold up to 10% of the amount requested for such pipe items until the pipe has been so tested. However, in the case of a major (pipe diameter 24 inches or greater) interceptor pipe installation, sums retained by the owner pursuant to this policy memorandum shall not exceed two per centum (2%) of the costs of such pipe items.

Executed change orders submitted to the Division for review and processing for financial assistance must be prepared on the attached Change Order Forms (CG-10, Attachment 1, pages A-1 & A-2) with a duplicate copy, calculation sheet(s) (CG-10, Attachment 2), and all other supporting documentation necessary for evaluation. Failure to comply with these instructions will result in delays in processing the change order and/or limited financial assistance.

M.G.L. c.44, s.31C requires that the auditor, accountant, or other municipal officer having similar duties must certify that adequate funding in an amount sufficient to cover the total cost of the change order has been made. Change orders will not be processed or approved until this certification is made on the face of the Change Order Form (CG-10 Attachment 1).

Payment of Change Orders:

Payment of all change orders shall be in accordance with the relevant provisions of Massachusetts General laws, Chapter 30, Section 39G for non-building construction and Section 39K for building construction.

Payment of change orders shall be made in accordance with one of the following three methods:

- A. Existing unit prices as set forth in the contract; or
 - B. Agreed upon lump sum or unit prices; or
 - C. Time and materials
- A. Payment for work for which there is a unit price in the contract:

Where the contract contains a unit price for work and the Engineer orders a change for work of the same kind as other work contained in the contract and is performed under similar physical conditions, the contractor may accept full and final payment at the contract unit price(s) for the acceptable quantities.

- B. Payment for work or materials for which no price is contained in the contract:

If the Engineer directs, the contractor shall submit promptly in writing to the Engineer and offer to do the required work on a lump sum or unit price basis, as specified by the Engineer. The stated price, either lump sum or unit price, shall be divided so as to show that it is the sum of:

- (1) The estimated cost of labor, plus
- (2) Direct Labor Cost, plus
- (3) Material and Freight Costs, plus
- (4) Equipment Costs, plus
- (5) An amount not to exceed 20% of the sum of items (1) through (4) for overhead and profit, plus (if applicable),
- (6) In the case of work done by a subcontractor and amount not to exceed 7 ½ %, for the general contractor of the sum of items (1) through (4) for his overhead and profit, less, if applicable,

(7) Credits for work deleted from the contract.

C.

D. Payment for work on a time and materials basis:

Unless an agreed lump sum and/or unit price is obtained from above and is so stated in the change price, the contractor shall accept as full payment for which no other agreement is contained in contract, and amount equal to:

- (1) The estimated cost of Labor, plus
- (2) Direct Labor Cost, plus
- (3) Material and Freight Costs, plus
- (4) Equipment Costs, plus
- (5) An amount not to exceed 20% of the sum of items (1) through (4) for overhead and profit, plus (if applicable),
- (6) In the case of work done by a subcontractor and amount not to exceed 7 ½ %, for the general contractor of the sum of items (1) through (4) for his overhead and profit, less, if applicable,
- (7) Credits for work deleted from the contract.

Explanation of items (1) through (7) as outlined in “B” and “C”:

(1)Labor – Only those workers employed on the project who are doing the extra work, including the foreman in charge, are allowable. General foremen, superintendents, or other supervisory personnel are considered to be included in the overhead markup as provided in items (5) and/or (6). Hourly labor rates in excess of those as listed in the contract wage rates (Federal or State, whichever applies require documentation. As a minimum, an explanation and the appropriate copy of the certified payroll are required.

(2)Direct Labor Costs - These costs are limited to those which are required in the contract document. Coverage in excess of the contract provisions, secured by the contractor/subcontractor(s) at his option, are ineligible for financial assistance. The following list of typical direct labor charges is provided for your assistance and is in no way intended to be complete or all encompassing:

- Workman’s Compensation
- Federal/State: Social Security Tax and Unemployment Tax;
- Health, Welfare and Pension Benefits; (this cost is included in the wage rates appearing in the Mass. Wage Rates of the contract specifications)
- Liability Insurance: Bodily Injury;
Excess Umbrella;
Property damage;
Public Liability
- Blasters Insurance If applied to any required
- Builders Risk Insurance direct labor costs.
- Experience Modification Insurance
- Surcharges

Following award and prior to execution of a construction contract, the contractor and filed sub-bidders (where applicable) shall submit for review by the owner, documentation to establish the Direct Labor Cost percentage(s) (Direct Labor markup percentage(s)).

The documented direct labor markup for this contract may be adjusted on an annual basis as measured from the date the contract is executed. The contract agreement will provide for the establishment of the Direct Labor Cost percentage.

- (3) Material and Freight – Only those materials required as a result of the change order and reasonable freight charges for delivery of same are allowable.
- (4) Equipment – Only the equipment required as a result of the change order is allowable. Equipment rental rates shall be governed by the current Nielson/Dataquest Rental Rate bluebook for Construction Equipment (the “Bluebook”). In determining the rental rate the following shall apply:
 - (a) For equipment already on the project – the monthly prorated rental rate by the hourly use shall be applicable;
 - (b) For equipment not on the project the daily rate, the weekly rate, or monthly rate will prevail, whichever will prove to be most cost effective. Small tools and manual equipment are examples of costs not allowable under this item. These costs are considered to be included in the overhead markup as provided in items (5) and/or (6)
(1 month (normal use) = 176 hours)
- (5) & (6) Overhead and Profit – All other costs not previously mentioned are considered to be included in this item, be it for the general contractor or subcontractor(s).
- (7) Credits – Work deleted, material and equipment removed from the contractor, stored and/or returned shall be credited to the cost of the change order, less costs.

The Contractor shall furnish itemized statements of the cost of the work ordered and shall give the Engineer access to all accounts, bills and vouchers relating thereto; and unless the Contractor shall furnish such itemized statements, and access to all accounts, bills and vouchers, he shall not be entitled to payment for any items of extra work for which such information is sought by the Engineer. Deviations from any of the above will be reviewed for financial assistance on a case-by-case basis.

The change order will be prepared in such manner as to clearly separate Eligible and Ineligible Costs.

CHANGE ORDER FORM

SRF Number _____
Public Entity _____
Contract Number _____
Change Order Number _____

Contract Amount (As Bid) \$ _____
Net Change in Contract Price (this change order) \$ _____
Total Adjusted Contract Price (including this and all other change orders) \$ _____

This change order extends the time to complete the work by _____ calendar days.

The extended completion date is _____

This change order checked by _____
(Chief) Resident Engineer Date

This change order is requested by: _____

This change order is recommended by: _____

Consultant Engineer P.E. Number Date

The undersigned agree to the terms of the change order.

Contractor Date

Owner Date

Certification of Appropriation under M.G.L. c.44, §31C: Adequate funding in an amount sufficient to cover the total cost of this change order is available.

By: _____
Certification Officer (Auditor, accountant, treasurer) Date

Do not write below: this space reserved for STATE AGENCY APPROVAL

CHANGE ORDER FORM (Continued)

Public Entity _____

SRF No: _____ Contract No. _____ Change Order No. _____

Contract Title: _____

Owner's Name: _____

Owner's Address: _____

Contractor's Name: _____

Contractor's Address: _____

Description of Change

Reason for Change

CALCULATION SHEET

(1)	Labor			
	Foreman	10 hrs @ \$10.00/hr.	\$	100.00
	Engineer	10 hrs @ 8.50/hr		85.00
	Operator	10 hrs @ 9.50/hr		95.00
	Laborers	24 hrs @ 7.00/hr		<u>168.00</u>
				\$448.00
(2)	Direct Labor Cost (use the agreed upon Direct Labor Cost)			
	*	(30)% of \$448		
	*	(Used for example purposes only)		134.00
(3)	Materials & Freight			
	150 l.f. of 12" pipe @ \$2.00/l.f.		\$	300.00
	15 v.f. precast SMH			1,700.00
	Freight (slip # _____ Enclosed)			<u>25.00</u>
				2,025.00
(4)	Equipment			
	1 Backhoe	10 hrs @ \$80.00/hr	\$	800.00
	1 Truck-crane	10 hrs @ \$100.00/hr		<u>1,000.00</u>
				<u>1,800.00</u>
		Total (Items 1 through 4)		4,407.00
(5)	20% markup for Overhead, Profit			
	20% of \$4,407			881.00
(6)	7 ½% markup for general contractor (if subcontractor is involved)			
	7 ½% of \$4,407			331.00
(7)	Credits (deductibles)			<u>- 323.00</u>
		Total Cost	\$	5,296.00

Reminder: Provide support documentation as necessary i.e. vouchers, correspondence, Calculation, photographs, reports

POLICY MEMORANDUM NO. CG-11

UTILITY RELOCATION

The construction of treatment facilities, sewers, pumping stations, force mains and appurtenant work can cause the relocation of utilities. Costly relocation can sometimes be minimized by early communication and cooperation of the representatives of the municipality (owner) and the utilities.

Every possible effort should be made by the owner and each utility to establish the location of existing utilities in the vicinity of the proposed construction. The owner or its consulting engineer should make every reasonable effort to design the proposed construction so that relocation of existing utilities is minimized whenever possible. If the proposed construction is in an area of many existing utilities or in an otherwise critical area, the utilities are encouraged to mark the location of their existing utilities at the site during the design phase of the project.

During the design phase of the project, the municipality should provide timely notice to all utilities known or thought to have facilities in or proximate to the site of such future construction.

POLICY MEMORANDUM NO. CG-12

**REFUNDABLE DEPOSITS FOR
PLANS AND SPECIFICATIONS**

For each set of project plans and specifications provided, the owner may require a deposit in form of cash or other appropriate security, in an amount sufficient to cover the costs of production of such plans and specifications.

Upon return of the plans and specifications to the owner within a reasonable time and in good condition, such deposit shall be refunded.

Actual mailing costs, if any, shall be borne by the party requesting such plans and specifications.

POLICY MEMORANDUM NO. CG-13

BID OPENING PROCEDURES

As a minimum, bid documents shall be reviewed/inspected for conformance to the following bid opening procedure in the order presented below. Failure to comply with any of these steps shall render the bid non-responsive and upon determination of such non-responsiveness, such bid shall be rejected immediately, set aside, and shall receive no further consideration.

Bid Opening Procedure

Step #1. **Timeliness** – The bid must be filed at the place and within the time specified therefore in the invitation to bid, and no bid shall be accepted after such time. The time at which a bid is filed should be time/date stamped or otherwise prominently noted on the bid;

Policy Memorandum No. CG-13 – Bid Opening Procedures (Con't)

Step #2. **Bid Security** – Properly executed bid security, in the amount and terms specified in the invitation to bid (equal to 5% of Base Bid or Highest Possible Amount considering all alternatives) shall be placed in a seal envelope and attached to the outside of the envelope containing the bid at the time of its submission;

A. Bid Bond

The Bid bond must be dated On or Before the Bid Date;
Issued by a Bonding Company Licensed in Massachusetts;
Accompanied by a Current Power of Attorney;
Signed by Surety;

B. Check

The Check must be a Certified, Cashiers or Bank Treasurer's;
Dated On or Before the Bid Date;

Step #3. Bid Signature – The bid and all accompanying documents so required shall be signed by the bidder or its authorized representative before submission;

Step #4. Addenda – All addenda shall be sent certified mail, return receipt requested, by the owner to all individuals and organizations which have received plans and specifications and shall be mailed not later than five days prior to the date established for submission of bids. All bidders shall include with their bids written acknowledgement of receipt of all addenda, which acknowledgement may be on a form provided therefore by the owner.

Alternates – Any Alternates shall be acknowledged.

Step #5. Written Dollar Amounts – The total dollar amount of each bid shall be read, and the three lowest bids shall be selected for further consideration. The remaining bids shall then be set aside. The three apparent low bids shall be read to determine whether the unit price for each line item of each bid has been written therein in words. If it has not, such bid shall be rejected and shall receive no further consideration. ***Bid amounts shall be consistent (words vs. numbers) and if words and numbers differ, the words govern.*** This procedure shall then be repeated with the next apparent low bid until three are acceptable which have all the unit prices written in words, at which time the lowest bid shall be announced as the apparent low bidder, and the bid opening procedure shall be closed.

The Division recommends that this policy memorandum be included in all contract specifications and that the owner's evaluator(s) use the attached form (CG-13 Attachment #1) for bid opening procedures.

The Contractor's Bid Opening Checklist also attached hereto, is for use by each contractor to assure that his bid conforms with this policy memorandum. It is recommended that the checklist (CG-13 Attachment #2) be included in information for bidders, or at the end of the bid proposal, or in some other prominent part of the bid specifications

FORM FOR BID OPENING PROCEDURES
(to be completed by the owner's evaluator(s))

CONTRACT NO.: _____

DATE: _____

CONTRACT NAME: _____

BID OPENING TIME: _____

All non-responsive bids shall be rejected forthwith by the awarding authority upon determination of such bids' non-responsiveness at the time bids are opened and read. Failure to comply with any one of the requirements shall render the bid non-responsive, and upon determination of such non-responsiveness such bid shall be rejected and receive no further consideration.

A = Acceptable

N-R = Non-Responsive (explain reasons on supplemental sheet & attach)

BIDDER	1. TIMELINESS	2. BID SECURITY	3. SIGNATURE	4. ADDENDA ALTERNATIVES	WRITTEN 5. DOLLAR AMOUNTS	COMPLIANCE (CIRCLE ONE)	
						YES	NO
1						YES	NO
2						YES	NO
3						YES	NO
4						YES	NO
5						YES	NO
6						YES	NO
7						YES	NO
8						YES	NO
9						YES	NO
10						YES	NO
11						YES	NO
12						YES	NO

DEP/DMS

Evaluator(s) _____

BID OPENING PROCEDURES

CONTRACTORS CHECKLIST

CONTRACT NO.: _____ BIDDER: _____ DATE: _____

All non-responsive bids shall be rejected forthwith by the awarding authority upon determination of such bids' non-responsiveness at the time bids are opened and read. Failure to comply with one or more of the following requirements shall render the bid non-responsive, and upon determination of such non-responsiveness such bid shall be rejected and receive no further consideration.

ITEM	REQUIREMENTS	COMPLIANCE (CIRCLE 1)		REASONS FOR REJECTION
		Yes	No; Rejected	
1. Timeliness	Bid filed w/in time specified	Yes	No; Rejected	
2. Bid Security	Appropriate and properly Executed security w/bid.	Yes	No; Rejected	
3. Signature	Bid signed by authorized Representative	Yes	No; Rejected	
4. Addenda	All addenda acknowledge Any alternative	Yes	No; Rejected	
5. Dollar Amount	Dollar amount in words Specified for each line item in bid	Yes	No; Rejected	

There shall be in the contract documents a separate pay item for rock excavation. For such purposes, “rock” shall mean igneous, sedimentary, metamorphic, and conglomerate rock, which for excavation must be drilled, blasted, broken, or ripped by power tools. Boulders and concrete structures one cubic yard or greater, however removed, are included within this definition of rock for payment purposes. At the option of the owner or his representative a separate pay item for boulders, concrete structures, or concrete road base may be used.

<u>Depth From Ground Surface</u>	<u>Pay Width</u>	
<u>To Invert Pipe</u>	<u>(Nominal Pipe Diameter)</u>	
	<u>0-24”</u>	<u>Over 24”</u>
* 0 – 12’	5’0”	D+3’0”
* Over 12’ – 20’	7’0”	D+5’

Engineer’s plans and specifications shall establish pay limits below pipe and structures.

- See CG-14 Attachment #1 (typical cross section)

Payment width for depths over twenty feet (20’) shall be determined on a case-by-case basis consistent with the foregoing chart.

The pay limit for rock removal outside proposed manholes shall commence one foot (1’) outside the widest dimension of the structure of shall be the maximum connecting trench width, whichever is greater.

Payment depth for rock which is encountered in a trench shall be no less than three feet (3’) when removal can be accomplished only by drilling and blasting or by use of jack (air or hydraulic) hammers.

Payment for rock removed, using the same or equal equipment as utilized for normal trench excavation, shall be limited to the actual depth removed within the limits established by the contract documents.

Boulders encountered within the pay limits of excavation, whose volume is one cubic yard or greater, part of which extends outside said limits shall be paid in accordance with the actual volume excavated.

CG-14 ROCK EXCAVATION

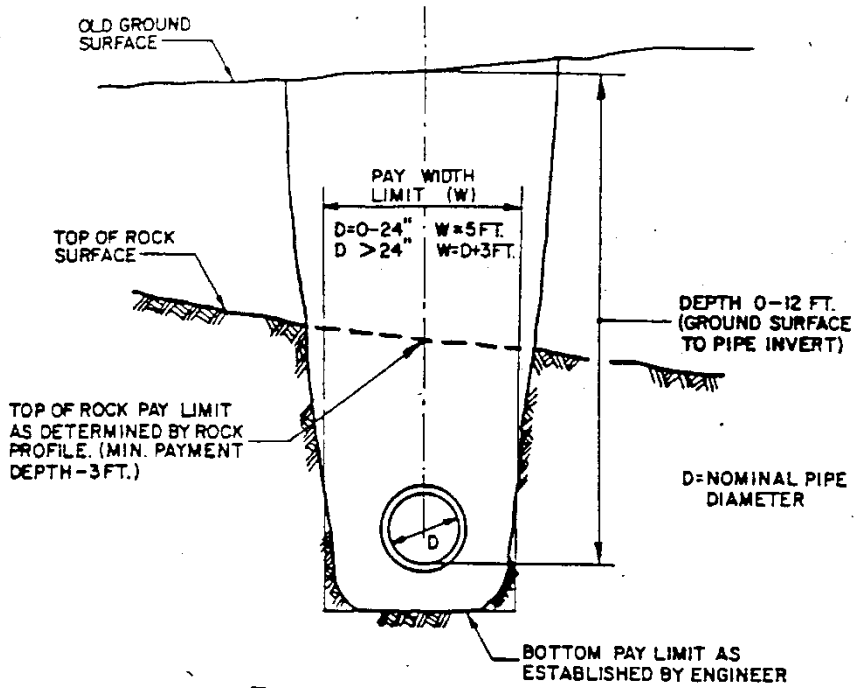

FOR DEPTH 0 TO 12 FEET

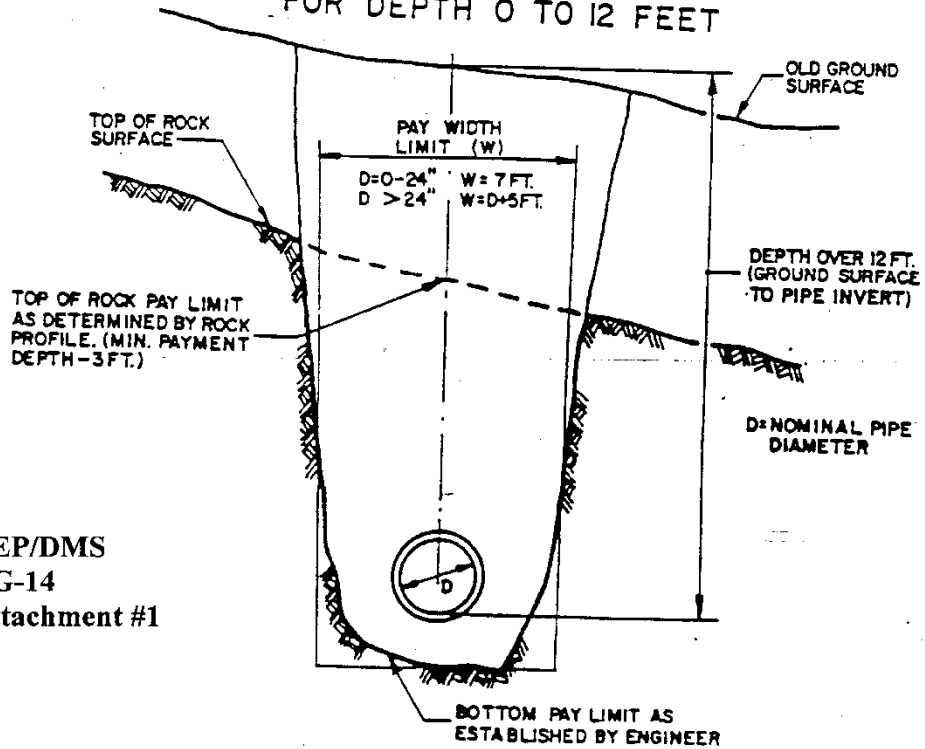

FOR DEPTH OVER 12 FEET AND UP TO 20 FEET

DEP/DMS
 CG-14
 Attachment #1

POLICY MEMORANDUM NO. CG-15

TRAFFIC POLICE

The reasonable costs for police details required for traffic control on a construction project which receives financial assistance shall be considered as an eligible administrative cost. A police detail item shall not be included as a bid item in the contract documents.

“Police” as used in this memorandum includes local, county, capital, state, regular and auxiliary police.

Owner’s Responsibility

It shall be the owner’s responsibility to submit in writing the hourly rate of pay to be established for detailed traffic police and each change in rate during the course of the project. It is the owner’s responsibility to arrange, document and pay for such police details. The owner or its representative shall meet with the police chief or other officer in charge of police detail duty to review contract needs. The owner shall maintain a daily record of the following:

- a. Officer’s name
- b. Hours worked
- c. Location of assignment
- d. Hourly rate

POLICY MEMORANDUM NO. CG-16

**DOCUMENTATION REQUIRED TO
SUBSTANTIATE CONTRACT QUANITITES**

<u>Unit</u>	<u>Documentation required</u>
Acres (A)	Location, station, offset and calculations. Location = Street right-of-way, etc; Station = Point on Baseline; Offset = Distance left or right of Baseline
Cubic Yard (C.Y.)	Location, stations, widths, depths, calculations and Cross sections as necessary
Each (Ea.)	Location, station, and offset.
Gallon (Gal.)	Location, stations, calculations (if appropriate) and delivery slips.
Hour (Hr.)	Hours and location.
Linear Feet (L.F.)	Location, stations, and offsets.
Month (Mo.)	Location, period of time and calculations if applicable.

1000 Foot Board Measure

(MFBM)	Location, stations, offset, elevations, grade, and calculations. Attach invoices where applicable.
Pound (Lb.)	Locations, stations, and calculations (if applicable). Attach Delivery weight slips.
Square Feet (S.F.)	Locations, stations and calculations
Square Yard (S.Y.)	Locations, stations and calculations
Ton	Locations, stations and calculations (if applicable). Attach Delivery weight slips.
Vertical Feet (V.F.)	Locations, stations, elevations, and offsets.

Note:

1. All of the above, that apply must be submitted with a final payment request or change order as applicable.
2. Where in place measurement is not possible or practical, delivery slips may be used to substantiate quantities.
3. Change orders – See CG-10 in which some of the above may be applicable in justifying materials, equipment and labor.
4. When necessary, itemized quantities must be separated into eligible and non-eligible units with separate calculations to justify eligible costs.
5. Overruns and underruns of any specific item shall be explained with an appropriate sentence or paragraph.
6. On all quantities, units of payment shall be maintained at the project site and shall be updated daily so that upon field inspection by the C.O.E., EPA or DMS, the quantities paid to date can be substantiated.
7. In the case of unforeseen conditions, photos should be submitted with the applicable item in addition to the recommended documentation.
8. Documentation of units of payment shall be clearly legible and cross referenced to the applicable sheets of the record drawings.
9. For record drawings policy, please see CG-4.

DMS Policies 1 through 16 Approved By:

Steven J. McCurdy
Division of Municipal Services

DWS POLICY 88-02

DEPARTMENT OF ENVIRONMENTAL PROTECTION

POLICY FOR REVIEW OF SEWER LINE/WATER SUPPLY PROTECTION

The Department of Environmental Protection seeks to protect existing and potential water supplies from the potentially negative effects of leaking sewer lines through the adoption of a Department policy on this subject.

The following restrictions will apply to new sewer construction statewide:

Gravel Packed Wells

- ~ Within the 400 foot radius protective distance around gravel packed wells, all sewer lines and appurtenances are prohibited, unless they are necessary to eliminate existing and/or potential sources of pollution to the well.

Tubular Wells

- ~ Within the 250 foot radius protective distance around tubular wells, all sewer lines and appurtenances are prohibited, unless they are necessary to eliminate existing and/or potential sources of pollution to the well.

Gravel Packed and Tubular Wells

- ~ Within a minimum radius of 2,640 feet or unless otherwise documented by an appropriate study specifically defining the area of influence and approved by the Division of Water Supply, all sewer lines and appurtenances will be designed and constructed for maximum water tightness.
- Force Mains or Pressure Sewers: shall be tested at 150% above maximum operating pressure or 150 p.s.i. whichever is greater. Testing shall conform to the requirements of the American Water works Association (AWWA) standard c 600.
- Gravity Sewers: shall be tested by approved methods which will achieve test results for infiltration or exfiltration of less than 100 gallons/inch diameter/mile/24 hours.
- Manholes: shall be installed with watertight covers with locking or bolted and gasketed assemblies. Testing for infiltration/exfiltration shall conform to the same standards as the maximum allowed for pipes in the manhole as required for gravity sewers, indicated above.
- Satisfactory test results for Force Mains, Manholes and Gravity Sewers shall be performed prior to the expiration of the contractor's one year guarantee period.
- All pumping stations within this zone shall have standby power high water alarms telemetered to an appropriated location that is manned at all times. An emergency contingency plan must be developed by the owner and approved by the BRP.
- A minimum of Class B bedding as defined by WPCF-MOP9 must be used for all piping.
- Service connections (laterals and house connections) shall be rigidly inspected by the appropriate municipal official. Certified inspection reports shall be submitted to the BRP.

Bedrock Wells

The above requirements are the same for bedrock wells, with the Department reserving the right to require more stringent controls on a case-by-case basis.

Surface Water Supplies

- ~ Within 100 feet of all surface water supplies and tributaries all sewer lines and appurtenances are prohibited except as required to cross tributaries or to eliminate existing or potential pollution to the water supply. In the latter case, watertight construction methods shall be use.
- ~ Tributary stream crossings shall employ watertight construction methods of sewer lines and manholes. Watertight construction must extend 100 feet to either side of the stream.
- ~ Within 1,000 feet of surface water supplies and tributaries, all pumping stations shall have standby power and high water alarms telemetered to an appropriate location that is manned at all times. An emergency contingency plan must be developed by the owner of the wastewater treatment facility and submitted to the BRP for approval.
- ~ Beyond 1,000 feet and within the watershed of surface water supplies the Department may in specific circumstances after review, require additional controls.

Potential Public Water Supplies

The above requirements also apply to potential public water supplies.

Baseline Data Requirements

Two (2) copies of an appropriately scaled map(s) shall be submitted to the Department which details the proposed sewers and/or appurtenances and also includes the following:

- (1) the location of all nearby existing or potential surface water supplies, tributaries thereto, and watershed boundaries;
- (2) the location of existing and potential public and municipal potable groundwater supply wells.

The Department reserves the right to impose more restrictive measures than those contained in this policy as deemed appropriate.

Definitions

- Appurtenances – all attachments to sewer lines necessary for the transport and operation and maintenance of sewer lines, including manholes, pumping station, siphons, etc.
- Area of influence – that area of an aquifer which contributes water to a well under the most severe recharge and pumping condition that can be realistically anticipated (i.e. pumping at the safe yield of the well for 180 days without any natural recharge occurring). It is bounded by the groundwater divides which result from pumping the well and by the contact of the edge of the aquifer with less permeable materials such as till and bedrock. At some locations, streams and lakes may form recharge boundaries.
- Potential public water supply – areas designated by communities for water supply purposes where land has been set aside and Department approved pump tests conducted and surface water supplies as defined below.
- Surface Water Supply – Waters classified as Class A by the DWPC.
- Public Water Supply Systems – as defined in 310 CMR 22.02 (DEP Drinking Water Regulations).
- Class B Bedding – as defined in WPCF Manual of Practice No. 9.

APPROVED: (Signature on File)

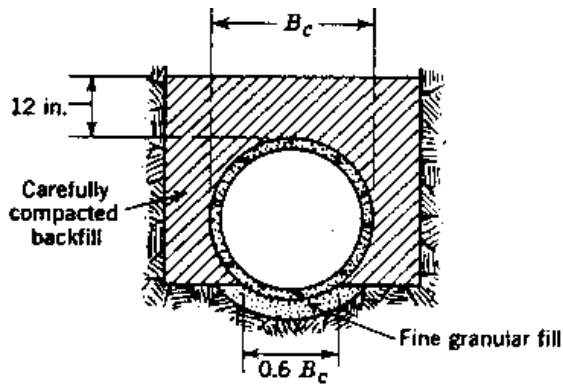

Shaped bottom with tamped backfill,
load factor 1.9

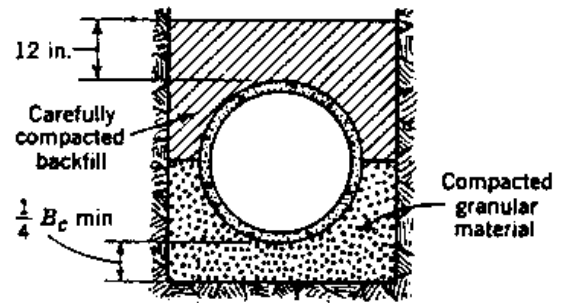

Compacted granular bedding,
load factor 1.9

Class B---First-Class Bedding – Class B bedding may be achieved by either of two construction methods:

- a. **Shaped Bottom with Tamped Backfill.** The bottom of the trench excavation shall be shaped to conform to a cylindrical surface with a radius at least 2 in. (5 cm) greater than the radius to the outside of the pipe and with a width sufficient to allow six-tenths of the width of the pipe barrel to be bedded in fine granular fill placed in the shaped excavation. Carefully compacted backfill shall be placed at the sides of the pipe to a thickness of at least 12 in. (30 cm) above the top of the pipe. Shaped trench bottoms are difficult to achieve under current construction conditions.
- b. **Compacted Granular Bedding with Tamped Backfill.** The pipe shall be bedded in compacted granular material placed on a flat trench bottom. The granular bedding shall have a minimum thickness of one-fourth the outside pipe diameter and shall extend halfway up the pipe barrel at the sides. The remainder of the side fills and a minimum depth of 12 in. (30 cm) over the top of the pipe shall be filled with carefully compacted material.

Davis Bacon Act Requirements

The Main Lift Pumping Station Foundation project is subject to the Davis Bacon wage rate requirements and must include the appropriate sections of the following document in its entirety in the contract documents.

Preamble

With respect to the Clean Water and Safe Drinking Water State revolving Funds, EPA provides capitalization grants to each State which in turn provides subgrants or loans to eligible entities within the State. Typically, the subrecipients are municipal or other local governmental entities that manage the funds. For these types of recipients, the provisions set forth under Roman Numeral I, below, shall apply. Although EPA and the State remain responsible for ensuring subrecipients' compliance with the wage rate requirements set forth herein, those subrecipients shall have the primary responsibility to maintain payroll records as described in Section 3(ii)(A), below and for compliance as described in Section I-5.

Occasionally, the subrecipient may be a private for profit or not for profit entity. For these types of recipients, the provisions set forth in Roman Numeral II, below, shall apply. Although EPA and the State remain responsible for ensuring subrecipients' compliance with the wage rate requirements set forth herein, those subrecipients shall have the primary responsibility to maintain payroll records as described in Section II-3(ii)(A), below and for compliance as described in Section II-5.

I. Requirements For Subrecipients That Are Governmental Entities:

The following terms and conditions specify how recipients will assist EPA in meeting its Davis-Bacon (DB) responsibilities when DB applies to EPA awards of financial assistance with respect to State recipients and subrecipients that are governmental entities. If a subrecipient has questions regarding when DB applies, obtaining the correct DB wage determinations, DB provisions, or compliance monitoring, it may contact the State recipient. If a State recipient needs guidance, the recipient may contact Valerie Marshall at EPA Region 1 (617-918-1674) for guidance. The recipient or subrecipient may also obtain additional guidance from DOL's web site at <https://www.dol.gov/whd/govcontracts/dbra.htm>

1. Applicability of the Davis- Bacon (DB) prevailing wage requirements.

DB prevailing wage requirements apply to the construction, alteration, and repair of treatment works carried out in whole or in part with assistance made available by a State water pollution control revolving fund and to any construction project carried out in whole or in part by assistance made available by a drinking water treatment revolving loan fund. If a subrecipient encounters a unique situation at a site that presents uncertainties regarding DB applicability, the subrecipient must discuss the situation with the recipient State before authorizing work on that site.

2. Obtaining Wage Determinations.

(a) Subrecipients shall obtain the wage determination for the locality in which a covered activity subject to DB will take place prior to issuing requests for bids, proposals, quotes or other methods for soliciting contracts (solicitation) for activities subject to DB. These wage determinations shall be incorporated into solicitations and any subsequent contracts.

Prime contracts must contain a provision requiring that subcontractors follow the wage determination incorporated into the prime contract.

(i) While the solicitation remains open, the subrecipient shall monitor www.wdol.gov weekly to ensure that the wage determination contained in the solicitation remains current. The subrecipients shall amend the solicitation if DOL issues a modification more than 10 days prior to the closing date (i.e. bid opening) for the solicitation. If DOL modifies or supersedes the applicable wage determination less than 10 days prior to the closing date, the subrecipients may request a finding from the State recipient that there is not a reasonable time to notify interested contractors of the modification of the wage determination. The State recipient will provide a report of its findings to the subrecipient.

(ii) If the subrecipient does not award the contract within 90 days of the closure of the solicitation, any modifications or supersedes DOL makes to the wage determination contained in the solicitation shall be effective unless the State recipient, at the request of the subrecipient, obtains an extension of the 90 day period from DOL pursuant to 29 CFR 1.6(c)(3)(iv). The subrecipient shall monitor www.wdol.gov on a weekly basis if it does not award the contract within 90 days of closure of the solicitation to ensure that wage determinations contained in the solicitation remain current.

(b) If the subrecipient carries out activity subject to DB by issuing a task order, work assignment or similar instrument to an existing contractor (ordering instrument) rather than by publishing a solicitation, the subrecipient shall insert the appropriate DOL wage determination from www.wdol.gov into the ordering instrument.

(c) Subrecipients shall review all subcontracts subject to DB entered into by prime contractors to verify that the prime contractor has required its subcontractors to include the applicable wage determinations.

(d) As provided in 29 CFR 1.6(f), DOL may issue a revised wage determination applicable to a subrecipient's contract after the award of a contract or the issuance of an ordering instrument if DOL determines that the subrecipient has failed to incorporate a wage determination or has used a wage determination that clearly does not apply to the contract or ordering instrument. If this occurs, the subrecipient shall either terminate the contract or ordering instrument and issue a revised solicitation or ordering instrument or incorporate DOL's wage determination retroactive to the beginning of the contract or ordering instrument by change order. The subrecipient's contractor must be compensated for any increases in wages resulting from the use of DOL's revised wage determination.

3. Contract and Subcontract provisions.

(a) The Recipient shall insure that the subrecipient(s) shall insert in full in any contract in excess of \$2,000 which is entered into for the actual construction, alteration and/or repair, including painting and decorating, of a treatment work under the CWSRF or a construction project under the DWSRF financed in whole or in part from Federal funds or in accordance with guarantees of a Federal agency or financed from funds obtained by pledge of any contract of a Federal agency to make a loan, grant or annual contribution (except where a different meaning is expressly indicated), and which is subject to the labor standards provisions of any of the acts listed in § 5.1 or the FY 2012 Appropriations Act, the following clauses:

(1) Minimum wages.

(i) All laborers and mechanics employed or working upon the site of the work will be paid unconditionally and not less often than once a week, and without subsequent deduction or rebate on any account (except such payroll deductions as are permitted by regulations issued by the Secretary of Labor under the Copeland Act (29 CFR part 3)), the full amount of wages and bona fide fringe benefits (or cash equivalents thereof) due

at time of payment computed at rates not less than those contained in the wage determination of the Secretary of Labor which is attached hereto and made a part hereof, regardless of any contractual relationship which may be alleged to exist between the contractor and such laborers and mechanics.

Contributions made or costs reasonably anticipated for bona fide fringe benefits under section 1(b)(2) of the Davis-Bacon Act on behalf of laborers or mechanics are considered wages paid to such laborers or mechanics, subject to the provisions of paragraph (a)(1)(iv) of this section; also, regular contributions made or costs incurred for more than a weekly period (but not less often than quarterly) under plans, funds, or programs which cover the particular weekly period, are deemed to be constructively made or incurred during such weekly period. Such laborers and mechanics shall be paid the appropriate wage rate and fringe benefits on the wage determination for the classification of work actually performed, without regard to skill, except as provided in §5.5(a)(4). Laborers or mechanics performing work in more than one classification may be compensated at the rate specified for each classification for the time actually worked therein:

Provided, that the employer's payroll records accurately set forth the time spent in each classification in which work is performed. The wage determination (including any additional classification and wage rates conformed under paragraph (a)(1)(ii) of this section) and the Davis-Bacon poster (WH-1321) shall be posted at all times by the contractor and its subcontractors at the site of the work in a prominent and accessible place where it can be easily seen by the workers. Subrecipients may obtain wage determinations from the U.S. Department of Labor's web site, www.dol.gov.

(ii)(A) The subrecipient(s), on behalf of EPA, shall require that any class of laborers or mechanics, including helpers, which is not listed in the wage determination and which is to be employed under the contract shall be classified in conformance with the wage determination. The State award official shall approve a request for an additional classification and wage rate and fringe benefits therefore only when the following criteria have been met:

- (1) The work to be performed by the classification requested is not performed by a classification in the wage determination; and
- (2) The classification is utilized in the area by the construction industry; and
- (3) The proposed wage rate, including any bona fide fringe benefits, bears a reasonable relationship to the wage rates contained in the wage determination.

(B) If the contractor and the laborers and mechanics to be employed in the classification (if known), or their representatives, and the subrecipient(s) agree on the classification and wage rate (including the amount designated for fringe benefits where appropriate), documentation of the action taken and the request, including the local wage determination shall be sent by the subrecipient (s) to the State award official. The State award official will transmit the request, to the Administrator of the Wage and Hour Division, Employment Standards Administration, U.S. Department of Labor, Washington, DC 20210 and to the EPA DB Regional Coordinator concurrently. The Administrator, or an authorized representative, will approve, modify, or disapprove every additional classification request within 30 days of receipt and so advise the State award official or will notify the State award official within the 30-day period that additional time is necessary.

(C) In the event the contractor, the laborers or mechanics to be employed in the classification or their representatives, and the subrecipient(s) do not agree on the

proposed classification and wage rate (including the amount designated for fringe benefits, where appropriate), the award official shall refer the request and the local wage determination, including the views of all interested parties and the recommendation of the State award official, to the Administrator for determination. The request shall be sent to the EPA DB Regional Coordinator concurrently. The Administrator, or an authorized representative, will issue a determination within 30 days of receipt of the request and so advise the contracting officer or will notify the contracting officer within the 30-day period that additional time is necessary.

(D) The wage rate (including fringe benefits where appropriate) determined pursuant to paragraphs (a)(1)(ii)(B) or (C) of this section, shall be paid to all workers performing work in the classification under this contract from the first day on which work is performed in the classification.

(iii) Whenever the minimum wage rate prescribed in the contract for a class of laborers or mechanics includes a fringe benefit which is not expressed as an hourly rate, the contractor shall either pay the benefit as stated in the wage determination or shall pay another bona fide fringe benefit or an hourly cash equivalent thereof.

(iv) If the contractor does not make payments to a trustee or other third person, the contractor may consider as part of the wages of any laborer or mechanic the amount of any costs reasonably anticipated in providing bona fide fringe benefits under a plan or program, Provided, That the Secretary of Labor has found, upon the written request of the contractor, that the applicable standards of the Davis-Bacon Act have been met. The Secretary of Labor may require the contractor to set aside in a separate account assets for the meeting of obligations under the plan or program.

(2) Withholding. The subrecipient(s), shall upon written request of the EPA Award Official or an authorized representative of the Department of Labor, withhold or cause to be withheld from the contractor under this contract or any other Federal contract with the same prime contractor, or any other federally-assisted contract subject to Davis-Bacon prevailing wage requirements, which is held by the same prime contractor, so much of the accrued payments or advances as may be considered necessary to pay laborers and mechanics, including apprentices, trainees, and helpers, employed by the contractor or any subcontractor the full amount of wages required by the contract. In the event of failure to pay any laborer or mechanic, including any apprentice, trainee, or helper, employed or working on the site of the work, all or part of the wages required by the contract, the (Agency) may, after written notice to the contractor, sponsor, applicant, or owner, take such action as may be necessary to cause the suspension of any further payment, advance, or guarantee of funds until such violations have ceased.

(3) Payrolls and basic records.

(i) Payrolls and basic records relating thereto shall be maintained by the contractor during the course of the work and preserved for a period of three years thereafter for all laborers and mechanics working at the site of the work. Such records shall contain the name, address, and social security number of each such worker, his or her correct classification, hourly rates of wages paid (including rates of contributions or costs anticipated for bona fide fringe benefits or cash equivalents thereof of the types described in section 1(b)(2)(B) of the Davis-Bacon Act), daily and weekly number of hours worked, deductions made and actual wages paid. Whenever the Secretary of Labor has found under 29 CFR 5.5(a)(1)(iv) that the wages of any laborer or mechanic include the amount

of any costs reasonably anticipated in providing benefits under a plan or program described in section 1(b)(2)(B) of the Davis-Bacon Act, the contractor shall maintain records which show that the commitment to provide such benefits is enforceable, that the plan or program is financially responsible, and that the plan or program has been communicated in writing to the laborers or mechanics affected, and records which show the costs anticipated or the actual cost incurred in providing such benefits. Contractors employing apprentices or trainees under approved programs shall maintain written evidence of the registration of apprenticeship programs and certification of trainee programs, the registration of the apprentices and trainees, and the ratios and wage rates prescribed in the applicable programs.

(ii)(A) The contractor shall submit weekly, for each week in which any contract work is performed, a copy of all payrolls to the subrecipient, that is, the entity that receives the sub-grant or loan from the State capitalization grant recipient. Such documentation shall be available on request of the State recipient or EPA. As to each payroll copy received, the subrecipient shall provide written confirmation in a form satisfactory to the State indicating whether or not the project is in compliance with the requirements of 29 CFR 5.5(a)(1) based on the most recent payroll copies for the specified week. The payrolls shall set out accurately and completely all of the information required to be maintained under 29 CFR 5.5(a)(3)(i), except that full social security numbers and home addresses shall not be included on the weekly payrolls. Instead the payrolls shall only need to include an individually identifying number for each employee (e.g., the last four digits of the employee's social security number). The required weekly payroll information may be submitted in any form desired. Optional Form WH-347 is available for this purpose from the Wage and Hour Division Web site at <http://www.dol.gov/esa/whd/forms/wh347instr.htm> or its successor site. The prime contractor is responsible for the submission of copies of payrolls by all subcontractors. Contractors and subcontractors shall maintain the full social security number and current address of each covered worker, and shall provide them upon request to the subrecipient(s) for transmission to the State or EPA if requested by EPA, the State, the contractor, or the Wage and Hour Division of the Department of Labor for purposes of an investigation or audit of compliance with prevailing wage requirements. It is not a violation of this section for a prime contractor to require a subcontractor to provide addresses and social security numbers to the prime contractor for its own records, without weekly submission to the subrecipient(s).

(B) Each payroll submitted shall be accompanied by a "Statement of Compliance," signed by the contractor or subcontractor or his or her agent who pays or supervises the payment of the persons employed under the contract and shall certify the following:

- (1) That the payroll for the payroll period contains the information required to be provided under § 5.5 (a)(3)(ii) of Regulations, 29 CFR part 5, the appropriate information is being maintained under § 5.5 (a)(3)(i) of Regulations, 29 CFR part 5, and that such information is correct and complete;
- (2) That each laborer or mechanic (including each helper, apprentice, and trainee) employed on the contract during the payroll period has been paid the full weekly wages earned, without rebate, either directly or indirectly, and that no deductions have been made either directly or indirectly from the full wages earned, other than permissible deductions as set forth in Regulations, 29 CFR part 3;

(3) That each laborer or mechanic has been paid not less than the applicable wage rates and fringe benefits or cash equivalents for the classification of work performed, as specified in the applicable wage determination incorporated into the contract.

(C) The weekly submission of a properly executed certification set forth on the reverse side of Optional Form WH-347 shall satisfy the requirement for submission of the "Statement of Compliance" required by paragraph (a)(3)(ii)(B) of this section.

(D) The falsification of any of the above certifications may subject the contractor or subcontractor to civil or criminal prosecution under section 1001 of title 18 and section 231 of title 31 of the United States Code.

(iii) The contractor or subcontractor shall make the records required under paragraph (a)(3)(i) of this section available for inspection, copying, or transcription by authorized representatives of the State, EPA or the Department of Labor, and shall permit such representatives to interview employees during working hours on the job. If the contractor or subcontractor fails to submit the required records or to make them available, the Federal agency or State may, after written notice to the contractor, sponsor, applicant, or owner, take such action as may be necessary to cause the suspension of any further payment, advance, or guarantee of funds. Furthermore, failure to submit the required records upon request or to make such records available may be grounds for debarment action pursuant to 29 CFR 5.12.

(4) Apprentices and trainees--

(i) Apprentices. Apprentices will be permitted to work at less than the predetermined rate for the work they performed when they are employed pursuant to and individually registered in a bona fide apprenticeship program registered with the U.S. Department of Labor, Employment and Training Administration, Office of Apprenticeship Training, Employer and Labor Services, or with a State Apprenticeship Agency recognized by the Office, or if a person is employed in his or her first 90 days of probationary employment as an apprentice in such an apprenticeship program, who is not individually registered in the program, but who has been certified by the Office of Apprenticeship Training, Employer and Labor Services or a State Apprenticeship Agency (where appropriate) to be eligible for probationary employment as an apprentice. The allowable ratio of apprentices to journeymen on the job site in any craft classification shall not be greater than the ratio permitted to the contractor as to the entire work force under the registered program. Any worker listed on a payroll at an apprentice wage rate, who is not registered or otherwise employed as stated above, shall be paid not less than the applicable wage rate on the wage determination for the classification of work actually performed. In addition, any apprentice performing work on the job site in excess of the ratio permitted under the registered program shall be paid not less than the applicable wage rate on the wage determination for the work actually performed. Where a contractor is performing construction on a project in a locality other than that in which its program is registered, the ratios and wage rates (expressed in percentages of the journeyman's hourly rate) specified in the contractor's or subcontractor's registered program shall be observed. Every apprentice must be paid at not less than the rate specified in the registered program for the apprentice's level of progress, expressed as a percentage of the journeymen hourly rate specified in the applicable wage determination. Apprentices shall be paid fringe

benefits in accordance with the provisions of the apprenticeship program. If the apprenticeship program does not specify fringe benefits, apprentices must be paid the full amount of fringe benefits listed on the wage determination for the applicable classification. If the Administrator determines that a different practice prevails for the applicable apprentice classification, fringes shall be paid in accordance with that determination. In the event the Office of Apprenticeship Training, Employer and Labor Services, or a State Apprenticeship Agency recognized by the Office, withdraws approval of an apprenticeship program, the contractor will no longer be permitted to utilize apprentices at less than the applicable predetermined rate for the work performed until an acceptable program is approved.

(ii) Trainees. Except as provided in 29 CFR 5.16, trainees will not be permitted to work at less than the predetermined rate for the work performed unless they are employed pursuant to and individually registered in a program which has received prior approval, evidenced by formal certification by the U.S. Department of Labor, Employment and Training Administration. The ratio of trainees to journeymen on the job site shall not be greater than permitted under the plan approved by the Employment and Training Administration. Every trainee must be paid at not less than the rate specified in the approved program for the trainee's level of progress, expressed as a percentage of the journeyman hourly rate specified in the applicable wage determination. Trainees shall be paid fringe benefits in accordance with the provisions of the trainee program. If the trainee program does not mention fringe benefits, trainees shall be paid the full amount of fringe benefits listed on the wage determination unless the Administrator of the Wage and Hour Division determines that there is an apprenticeship program associated with the corresponding journeyman wage rate on the wage determination which provides for less than full fringe benefits for apprentices. Any employee listed on the payroll at a trainee rate who is not registered and participating in a training plan approved by the Employment and Training Administration shall be paid not less than the applicable wage rate on the wage determination for the classification of work actually performed. In addition, any trainee performing work on the job site in excess of the ratio permitted under the registered program shall be paid not less than the applicable wage rate on the wage determination for the work actually performed. In the event the Employment and Training Administration withdraws approval of a training program, the contractor will no longer be permitted to utilize trainees at less than the applicable predetermined rate for the work performed until an acceptable program is approved.

(iii) Equal employment opportunity. The utilization of apprentices, trainees and journeymen under this part shall be in conformity with the equal employment opportunity requirements of Executive Order 11246, as amended, and 29 CFR part 30.

(5) Compliance with Copeland Act requirements. The contractor shall comply with the requirements of 29 CFR part 3, which are incorporated by reference in this contract.

(6) Subcontracts. The contractor or subcontractor shall insert in any subcontracts the clauses contained in 29 CFR 5.5(a)(1) through (10) and such other clauses as the EPA determines may be appropriate, and also a clause requiring the subcontractors to include these clauses in any lower tier subcontracts. The prime contractor shall be responsible for the compliance by any subcontractor or lower tier subcontractor with all the contract clauses in 29 CFR 5.5.

- (7) Contract termination; debarment. A breach of the contract clauses in 29 CFR 5.5 may be grounds for termination of the contract, and for debarment as a contractor and a subcontractor as provided in 29 CFR 5.12.
- (8) Compliance with Davis-Bacon and Related Act requirements. All rulings and interpretations of the Davis-Bacon and Related Acts contained in 29 CFR parts 1, 3, and 5 are herein incorporated by reference in this contract.
- (9) Disputes concerning labor standards. Disputes arising out of the labor standards provisions of this contract shall not be subject to the general disputes clause of this contract. Such disputes shall be resolved in accordance with the procedures of the Department of Labor set forth in 29 CFR parts 5, 6, and 7. Disputes within the meaning of this clause include disputes between the contractor (or any of its subcontractors) and Subrecipient(s), State, EPA, the U.S. Department of Labor, or the employees or their representatives.
- (10) Certification of eligibility.
 - (i) By entering into this contract, the contractor certifies that neither it (nor he or she) nor any person or firm who has an interest in the contractor's firm is a person or firm ineligible to be awarded Government contracts by virtue of section 3(a) of the Davis-Bacon Act or 29 CFR 5.12(a)(1).
 - (ii) No part of this contract shall be subcontracted to any person or firm ineligible for award of a Government contract by virtue of section 3(a) of the Davis-Bacon Act or 29 CFR 5.12(a)(1).
 - (iii) The penalty for making false statements is prescribed in the U.S. Criminal Code, 18 U.S.C. 1001.

4. Contract Provision for Contracts in Excess of \$100,000.

- (a) Contract Work Hours and Safety Standards Act. The subrecipient shall insert the following clauses set forth in paragraphs (a)(1), (2), (3), and (4) of this section in full in any contract in an amount in excess of \$100,000 and subject to the overtime provisions of the Contract Work Hours and Safety Standards Act. These clauses shall be inserted in addition to the clauses required by Item 3, above or 29 CFR 4.6. As used in this paragraph, the terms laborers and mechanics include watchmen and guards.
 - (1) Overtime requirements. No contractor or subcontractor contracting for any part of the contract work which may require or involve the employment of laborers or mechanics shall require or permit any such laborer or mechanic in any workweek in which he or she is employed on such work to work in excess of forty hours in such workweek unless such laborer or mechanic receives compensation at a rate not less than one and one-half times the basic rate of pay for all hours worked in excess of forty hours in such workweek.
 - (2) Violation; liability for unpaid wages; liquidated damages. In the event of any violation of the clause set forth in paragraph (a)(1) of this section the contractor and any subcontractor responsible therefore shall be liable for the unpaid wages. In addition, such contractor and subcontractor shall be liable to the United States (in the case of work done under contract for the District of Columbia or a territory, to such District or

to such territory), for liquidated damages. Such liquidated damages shall be computed with respect to each individual laborer or mechanic, including watchmen and guards, employed in violation of the clause set forth in paragraph (a)(1) of this section, in the sum of \$10 for each calendar day on which such individual was required or permitted to work in excess of the standard workweek of forty hours without payment of the overtime wages required by the clause set forth in paragraph (a)(1) of this section.

- (3) Withholding for unpaid wages and liquidated damages. The subrecipient, upon written request of the EPA Award Official or an authorized representative of the Department of Labor, shall withhold or cause to be withheld, from any moneys payable on account of work performed by the contractor or subcontractor under any such contract or any other Federal contract with the same prime contractor, or any other federally-assisted contract subject to the Contract Work Hours and Safety Standards Act, which is held by the same prime contractor, such sums as may be determined to be necessary to satisfy any liabilities of such contractor or subcontractor for unpaid wages and liquidated damages as provided in the clause set forth in paragraph (b)(2) of this section.
- (4) Subcontracts. The contractor or subcontractor shall insert in any subcontracts the clauses set forth in paragraph (a)(1) through (4) of this section and also a clause requiring the subcontractors to include these clauses in any lower tier subcontracts. The prime contractor shall be responsible for compliance by any subcontractor or lower tier subcontractor with the clauses set forth in paragraphs (a)(1) through (4) of this section.

(b) In addition to the clauses contained in Item 3, above, in any contract subject only to the Contract Work Hours and Safety Standards Act and not to any of the other statutes cited in 29

CFR 5.1, the Subrecipient shall insert a clause requiring that the contractor or subcontractor shall maintain payrolls and basic payroll records during the course of the work and shall preserve them for a period of three years from the completion of the contract for all laborers and mechanics, including guards and watchmen, working on the contract. Such records shall contain the name and address of each such employee, social security number, correct classifications, hourly rates of wages paid, daily and weekly number of hours worked, deductions made, and actual wages paid. Further, the Subrecipient shall insert in any such contract a clause providing that the records to be maintained under this paragraph shall be made available by the contractor or subcontractor for inspection, copying, or transcription by authorized representatives of the (write the name of agency) and the Department of Labor, and the contractor or subcontractor will permit such representatives to interview employees during working hours on the job.

5. Compliance Verification

(a) The subrecipient shall periodically interview a sufficient number of employees entitled to DB prevailing wages (covered employees) to verify that contractors or subcontractors are paying the appropriate wage rates. As provided in 29 CFR 5.6(a)(6), all interviews must be conducted in confidence. The subrecipient must use Standard Form 1445 (SF 1445) or equivalent documentation to memorialize the interviews. Copies of the SF 1445 are available from EPA on request.

(b) The subrecipient shall establish and follow an interview schedule based on its assessment of the risks of noncompliance with DB posed by contractors or subcontractors and the duration of the contract or subcontract. At a minimum, the subrecipient should

conduct interviews with a representative group of covered employees within two weeks of each contractor or subcontractor's submission of its initial weekly payroll data and two weeks prior to the estimated completion date for the contract or subcontract. Subrecipients must conduct more frequent interviews if the initial interviews or other information indicates that there is a risk that the contractor or subcontractor is not complying with DB. Subrecipients shall immediately conduct necessary interviews in response to an alleged violation of the prevailing wage requirements. All interviews shall be conducted in confidence.

(c) The subrecipient shall periodically conduct spot checks of a representative sample of weekly payroll data to verify that contractors or subcontractors are paying the appropriate wage rates. The subrecipient shall establish and follow a spot check schedule based on its assessment of the risks of noncompliance with DB posed by contractors or subcontractors and the duration of the contract or subcontract. At a minimum, if practicable, the subrecipient should spot check payroll data within two weeks of each contractor or subcontractor's submission of its initial payroll data and two weeks prior to the completion date the contract or subcontract. Subrecipients must conduct more frequent spot checks if the initial spot check or other information indicates that there is a risk that the contractor or subcontractor is not complying with DB. In addition, during the examinations the subrecipient shall verify evidence of fringe benefit plans and payments thereunder by contractors and subcontractors who claim credit for fringe benefit contributions.

(d) The subrecipient shall periodically review contractors and subcontractors use of apprentices and trainees to verify registration and certification with respect to apprenticeship and training programs approved by either the U.S Department of Labor or a state, as appropriate, and that contractors and subcontractors are not using disproportionate numbers of, laborers, trainees and apprentices. These reviews shall be conducted in accordance with the schedules for spot checks and interviews described in Item 5(b) and (c) above.

(e) Subrecipients must immediately report potential violations of the DB prevailing wage requirements to the EPA DB contact listed above and to the appropriate DOL Wage and Hour District Office listed at <http://www.dol.gov/esa/contacts/whd/america2.htm>.

Contract Value _____

The United States Environmental Protection Agency (EPA) requires that all SRF borrowers develop and maintain a list of all MBE/WBE and non MBE/WBE subcontractors on the project.

This form must be completed and returned to MassDEP within 90 days of award of the contract

ATTACHMENT D

Massachusetts Diesel Retrofit Certifications

DIESEL RETROFIT PROGRAM CONTRACTOR CERTIFICATION

Each Contractor and its Subcontractor(s) must sign and submit this form to MassDEP and the Municipality within 10 days after the Contractor is notified that it is awarded the Contract.

Local Governmental Unit City of Taunton, MA **SRF Project No.** 6832

Contract No. S-2022-2 **Contact Title** Main Lift Pumping Station

Contractor _____

I, _____, an authorized signatory for _____,

whose principal place of business is at _____

_____ do hereby certify that any and all diesel powered non-road construction equipment and vehicles greater than 50 brake horsepower which will be used in the performance of the work under the Contract (hereinafter “Diesel Construction Equipment”) have pollution control devices, such as oxidation catalysts or particulate filters, installed on the exhaust system side of the diesel combustion engine equipment in accordance with the Diesel Retrofit Program Standard.

I am submitting on behalf of _____ a list of all said Diesel Construction Equipment, labeled “Diesel Retrofit List,” that will be used in connection with this Contract by _____. I hereby certify that the information on the attached Diesel Retrofit List is correct and accurate as of the date of signature. The List includes the following information for each piece of Diesel Construction Equipment:

1. Equipment type, make, model;
2. Vehicle Identification Number or VIN;
3. Engine model and year of manufacture;
4. Engine HP rating;
5. Emission Control Device (“ECD”) type (Diesel Oxidation Catalyst or Diesel Particulate Filter);
6. ECD make, model, and manufacturer;
7. ECD EPA or CARB Verification Number or manufacturer’s certification that the DOC or DPF meets or exceeds emission reductions provided by similar emission control technology verified by EPA or CARB;
8. ECD installation date;
9. Type of fuel to be used; and
10. Whether the equipment is owned or rented.

DIESEL RETROFIT PROGRAM CONTRACTOR CERTIFICATION

_____ shall notify MassDEP within 48 hours of any new Diesel Construction Equipment brought onto the Contract site.

_____ shall maintain detailed records of all Diesel Construction Equipment used at the Contract site, including the dates and duration times the Diesel Construction Equipment is used at the Contract site. _____ shall make such records available for inspection by MassDEP. _____ shall ensure that the emissions control technology for each piece of Diesel Construction Equipment is operated, maintained, and serviced as recommended by the manufacturer.

_____ shall retrofit prior to the end of the Contract any Diesel Construction Equipment no longer exempt from meeting the Diesel Construction Equipment Standard under exemption 3 (because it had an engine that met the EPA particulate matter (PM) Tier emission standards currently in effect at the start of the Contract for non-road diesel engines for the applicable engine power group and such emissions standards were superseded during the Contract).

I acknowledge that this certificate is being furnished as a requirement under this Contract and is subject to applicable State and federal laws, both criminal and civil. Signed under pains and penalty of perjury on this date _____.

Signature _____

Name: _____

Title: _____

(THIS PAGE INTENTIONALLY LEFT BLANK)

SECTION 01069

HEALTH & SAFETY REQUIREMENTS

PART 1 GENERAL

1.01 SECTION INCLUDES

- A. Requirements for providing a Health and Safety Plan (HASP) and maintenance of health and safety while performing the Work.

1.02 REQUIREMENTS

- A. Monitor working conditions at all times during construction and provide appropriate protective clothing, equipment and facilities for personnel, and establish workplace procedures to ensure personnel safety.
- B. Implement a Health and Safety protection program. The procedures for such implementation shall be submitted to the Engineer and Owner for approval. The procedures shall include provisions for stations allowing workers to wash and to put on and remove protective clothing, and stations for vehicles to be cleaned, if necessary, before leaving the site, air monitoring, and evaluation of areas where unsafe levels of gas has accumulated.
- C. Comply with all Federal, State, and local safety requirements related to the hazards anticipated to be encountered during the course of this project.
- D. In addition to the above requirements, comply with the following:
 - 1. All construction equipment on the site shall be equipped with vertical exhaust pipes or a spark proof exhaust.
 - 2. Smoking shall not be permitted in any area where gases can accumulate, or in areas where contaminated soil is present.
 - 3. Welding or open flames shall not be permitted in enclosed areas.
 - 4. Toxic gas indicators, an organic vapor analyzer, a combustible gas indicator, an oxygen indicator, and fire extinguishers shall be available at all times during operations. Periodic monitoring with portable monitoring devices shall be employed as dictated by the Health and Safety Plan.
 - 5. During operations, whenever unsafe levels of toxic gases are detected, all work will cease in that area until acceptable levels are reached.

1.03 SHOP DRAWINGS

- A. Submit site specific Health and Safety Plan (HASP) that complies with all applicable OSHA requirements to the Engineer for review and acceptance within fifteen (15) working days of the Contractor's Notice to Proceed. Certified Industrial Hygienist must certify the Contractor's plan prior to submittal to and review by the Engineer. The Contractor is not to proceed with any subsurface or site work without review and acceptance of the submitted Health and Safety Plan by the Engineer.

1.04 QUALITY ASSURANCE

- A. Engage an independent, qualified Health and Safety expert having experience in similar construction conditions, to monitor site conditions and recommend all necessary Health and

Safety protection. This person shall be a Certified Industrial Hygienist (CIH). The Contractor shall follow such recommendations and shall provide such protection to his personnel, and personnel of the Owner and Engineer, as may be affected.

1.05 REGULATORY REQUIREMENTS

- A. Establish work place procedures, enforce the use of these procedures, and the associated equipment and facilities in accordance with the following guidelines:
 - 1. Safety and Health Regulations Promulgated by the U.S. Department of Labor OSHA, 29 CFR 1910 - Occupational Safety and Health Standards, and 29 CFR 1920 - Safety and Health Regulations for Construction.
 - 2. Occupational Safety and Health Standards, 29 CFR 1926 - Safety and Health Regulations for Construction.
 - 3. U.S. Environmental Protection Agency Medical Monitoring Program Guidelines.

1.06 SITE CONDITIONS

- A. The Contractor's attention is directed to the fact that the work includes connecting new pipe lines to the existing sewer system. In addition to confined space issues, hazardous gasses and oxygen depletion may be encountered in the existing sewer system where proposed work is to take place.
- B. BETA has performed subsurface soil and groundwater sampling in the Project Area. A summary of all analytical results compiled by BETA is included in Environmental Assessment Memorandum located in Appendix 2 of the Contract Documents.
- C. The Contractor is also responsible for reviewing site specific investigation reports included in the various Appendices of the Contract Documents.

PART 2 PRODUCTS

NOT USED

PART 3 EXECUTION

3.01 PROTECTION

- A. If, at any time, the Owner or the Engineer is apprised of a safety hazard which demands immediate attention because of its high potential for harm to the public travel, persons on or about the Work, or public or private property, the Owner or the Engineer shall have the right to order such safeguards to be erected and such precautions to be taken as necessary and the Contractor shall comply with such orders. If, under such circumstances, the Contractor does not or cannot immediately put the Work into proper and approved condition, or if the Contractor or his representative is not upon the site so that he can be notified immediately of the insufficiency of safety precautions, then the Owner may put the Work into such a condition that is, in his opinion, in all respects safe, and the Contractor shall pay all expenses of such labor and materials as may have been used for this purpose by him or by the Owner. The fact that the Owner or the Engineer does not observe a safety hazard or does not order the Contractor to take remedial measures shall in no way relieve the Contractor of the entire responsibility for any costs, loss or damage by any party sustained on account of the

insufficiency of the safety precautions taken by him or by the Owner acting under authority of this Section.

- B. If the Contractor is alerted to the fact that conditions of high hazard are present or can be present at the site during the performance of the Work, it is the responsibility of the Contractor to take appropriate safety precautions to meet whatever conditions of hazard may be present during the performance of the Work, whether reasonably foreseeable or not. The safety conditions enumerated in the Specifications are the minimum permissible and neither the Owner nor the Engineer makes any representation that the safety standards provided herein will be adequate to meet all eventualities. The Contractor is therefore alerted to the fact that it shall be his responsibility to anticipate and provide such additional safety precautions, facilities, personnel and equipment as shall be necessary to protect life and property from whatsoever conditions of hazard are present or may be present.
- C. The Contractor shall supply and erect highly visible safety fencing a minimum of three feet in height around all construction areas that pose a threat to safety and post proper signage as required by Local, State and Federal requirements. The Contractor shall erect safety fencing as documented in the Contract Drawings or as directed by the Engineer and shall maintain such fencing and signage until such a time that the potential safety hazard has been rectified. Upon final completion of construction all safety fencing shall be removed off-site by the Contractor. Safety fencing requirements of OSHA shall be enforced by the Contractor.

END OF SECTION

(THIS PAGE INTENTIONALLY LEFT BLANK)

SECTION 01090

REFERENCE STANDARDS

PART 1 GENERAL

1.01 SECTION INCLUDES

- A. Reference material, abbreviations, and terms used in the Construction Documents and establishes edition dates and complete titles for standards referenced elsewhere in the Specifications.

1.02 QUALITY ASSURANCE

- A. For products or workmanship specified by association, trade or Federal Standards, comply with requirements of the standard, except when more rigid requirements are specified or are required by applicable codes.
- B. Obtain copies of standards when required by Contract Documents.
- C. Maintain copy at jobsite during submittals, planning, and progress of the specific work, until Substantial Completion.
- D. Should specified reference standards conflict with Contract Documents, request clarification from Architect/Engineer before proceeding.
- E. The contractual relationship of the parties to the Contract shall not be altered from the Contract Documents by mention or inference otherwise in any reference document.

1.03 SCHEDULE OF REFERENCES

AA	Aluminum Association 1400 Crystal Dr. Suite 430 Arlington, VA 22202
AASHTO	American Association of State Highway and Transportation Officials 444 North Capitol Street, N.W. Washington, DC 20001
ACI	American Concrete Institute 38800 Country Club Dr. Farmington Hills, MI 48331-3439
AFBMA	Anti-Friction Bearing Manufacturers Association 2025 M. Street, NW Washington, DC 20036-3309
AGC	Associated General Contractors of America 2300 Wilson Blvd. Arlington, VA 22201

AGM	American Gear Manufacturers Association 1001 N. Fairfax Street Alexandria, VA 22314-1587
AI	Asphalt Institute 2696 Research Park Drive Lexington, KY 40511-8480
AISC	American Institute of Steel Construction One East Wacker Drive Chicago, IL 60601-1802
AISI	American Iron and Steel Institute 25 Massachusetts Drive Washington, DC 20001
AMCA	Air Movement and Control Association 30 West University Drive Arlington Heights, IL 60004
ANS	American National Standard
ANSI	American National Standards Institute 1899 L Street, NW, 11 th Floor Washington, DC 20036
API	American Petroleum Institute 1220 L Street, NW Washington, DC 20005
ARI	Air-Conditioning and Refrigeration Institute 2111 Wilson Boulevard Arlington, VA 22201
ASCE	American Society of Civil Engineers 1801 Alexander Bell Drive Reston, VA 20191
ASHRAE	American Society of Heating, Refrigerating and Air Conditioning Engineers 1791 Tullie Circle, N.E. Atlanta, GA 30329
ASME	American Society of Mechanical Engineers Two Park Avenue New York, NY 10016-5990
ASPA	American Sod Producers Association 1855 A Hicks Road Rolling Meadows, IL 60008

ASTM	American Society for Testing and Materials 100 Bar Harbor Drive PO Box C700 West Conshohocken, PA 19428-2959
AWG	American or Brown and Sharpe Wire Gage
AWPA	American Wood-Preservers' Association 100 Chase Park South Birmingham, AL 35244-1851
AWS	American Welding Society
AWWA	American Water Works Association 6666 West Quincy Avenue Denver, CO 80235
BIA	Brick Institute of America 1850 Centennial Park Drive Reston, VA 20191
CS	Commercial Standard
EJCDC	Engineers' Joint Contract Document Committee American Consulting Engineers Council 1015 15 th Street, N.W. Washington, DC 20005
FM	Factory Mutual System 1151 Boston-Providence Turnpike PO Box 688 Norwood, Massachusetts 02062
Fed Spec.	Federal Specification General Services Administration Specification and Consumer Information Distribution Section (WFSIS) Washington Navy Yard, Bldg. 197 Washington, DC 20407
HMA	Hot Mix Asphalt
IBR	Institute of Boiler and Radiator Manufacturers
ICBO	International Conference of Building Officials 900 Montclair Road Birmingham, AL 35213-2298
IPS	Iron Pipe Size
JIC	Joint Industry Conference Standards

MIL	Military Specification Naval Publications and Forms Center 5801 Tabor Avenue Philadelphia, PA 19120
NASSCO	National Association of Sewer Service Companies 2470 Longstone Lane Marriottsville, MD 21104
NBS	National Bureau of Standards
NCMA	National Concrete Masonry Association 13750 Sunrise Valley Drive Herndon, VA 20171
NCPWB	National Certified Pipe Welding Bureau
NEMA	National Electrical Manufacturers' Association 1300 North 17 th Street Arlington, VA 22209
NFPA	National Fire Protection Association Battery March Park Quincy, MA 02269
NPT	National Pipe Thread
OS&Y	Outside screw and yoke
PCA	Portland Cement Association 5420 Old Orchard Road Skokie, IL 60077
SMACNA	Sheet Metal and Air Conditioning Contractors' National Assoc. 4201 Lafayette Center Drive Chantilly, VA 20151-1219
Stl. WG	U.S. Steel Wire Washburn and Moen, American Steel and Wire or Roebling Gage
UL	Underwriters' Laboratories, Inc. 333 Pfingston Road Northbrook, IL 60062
USS Gage	United States Standard Gage
125-lb. ANS 250-lb. ANS	American National Standard for Cast-Iron Pipe Flanges and Flange Fittings, Designation B16.1-1975, for the appropriate class

1.04 EDITION DATES

- A. Reference to publications and reference material shall be understood to mean the latest edition, unless stated otherwise.

PART 2 PRODUCTS NOT USED

PART 3 EXECUTION NOT USED

END OF SECTION

(THIS PAGE INTENTIONALLY LEFT BLANK)

SECTION 01170

ENVIRONMENTAL PROTECTION

PART 1 GENERAL

1.01 SUMMARY

A. Section Includes

1. Requirements for environmental protection during and as the result of construction operations under this Contract except for those measures set forth in other provisions of these Specifications.
2. Environmental protection requires consideration of air, water and land, noise, solid waste management, vector and fire control.

B. Related Sections

1. Section 01300 - Submittals
2. Section 02228 - Waste Material Disposal

1.02 QUALITY ASSURANCE

A. Requirements of regulatory agencies:

1. In order to prevent environmental pollution and to provide for environmental protection arising from construction activities related to the performance of this Contract, the Contractor and his subcontractors shall comply with all applicable Federal, State, and local laws and regulations concerning environmental protection, as well as the specific requirements stated in the Section and elsewhere in the Specifications.

1.03 SUBMITTALS

A. Under the requirements of Section 01300 - Submit the following.

B. Implementation Plan

1. Prior to commencement of the work, the Contractor shall:
 - a. Submit in writing his plans for implementing this Section for environmental protection.
 - b. Meet with the Engineer to develop mutual understandings relative to compliance with the provisions of this Section and administration of the environmental protection program.

C. Temporary Excavation and Embankments

1. If the Contractor proposes to construct temporary roads or embankments and excavations for work areas, he shall submit the following for approval prior to scheduled start of such temporary work:
 - a. A layout of all temporary roads, excavations and embankments to be constructed within the work area.
 - b. Plans and cross-sections of proposed embankments and their foundations, including a description of proposed materials.
 - c. A landscaping plan showing the proposed restoration of the area. Removal of any necessary trees and shrubs outside the limits of existing cleared areas shall

be indicated. The plan shall provide for the obliteration of construction scars and shall provide for a reasonably natural appearing final condition of the area. Modification of the Contractor's plans shall be made only with the written approval of the Engineer. No unauthorized road construction, excavation or embankment construction, including disposal areas will be permitted.

D. Erosion Sedimentation Plan

1. The Contractor shall submit to the Engineer, a detailed erosion and sedimentation plan for approval at least 10 days prior to initiation of work. The plan shall include location and construction details of the Contractor's proposed dikes, basins, etc. The Contractor shall provide and submit his control measures for stockpile material.

PART 2 PRODUCTS

2.01 GENERAL

- A. All materials shall be as specified elsewhere in this Specification.

PART 3 EXECUTION

3.01 PROTECTION OF LAND RESOURCES

- A. It is intended that the land resources within the project boundaries and outside the limits of permanent work performed under this Contract be preserved in their present condition, or be restored to a condition after completion of construction, that will appear to be natural and not detract from the appearance of the project. The Contractor shall confine his construction activities to areas defined on the Drawings or in the Specifications except with written approval of the property owners and the Engineer.
- B. Limits of working areas include areas for storage of construction material, and shall be cleared in a manner which will enable satisfactory restoration and which will not affect the environment during or after the construction period. The Contractor shall not enter beyond the working limits of the working area except with written approval of the Engineer and Owner.
- C. The location of areas for storage of the Contractor's materials required temporarily in the performance of the work, shall be within the limits of the working area and shall require written approval of the Engineer prior to use. The preservation of the landscape shall be an imperative consideration in the selection of all such sites. Where temporary structures are constructed on sidehills, the Engineer may require cribbing to be used to obtain level foundation. Benching or leveling of earth may not be allowed, depending on the location of the proposed facility.
- D. The Contractor shall obliterate all signs of temporary construction facilities such as haul roads, work areas, structures, foundations of temporary structures, stockpiles of excess or waste materials, or any other vestiges of construction. It is anticipated that excavation, filling and plowing of roadways will be required to restore the area to near natural conditions which permit the growth of vegetation thereon. The disturbed areas shall be graded and filled as

required, and topsoil shall be spread to a depth of approximately 6 inches over the entire area and the entire area shall be seeded.

3.02 PROTECTION OF WATER RESOURCES

- A. The Contractor shall not pollute streams, lakes or reservoirs with fuels, oils, bitumen's, calcium chloride, acids or harmful materials. It is the responsibility of the Contractor to investigate and comply with all applicable Federal, State, County, and Municipal laws concerning pollution of rivers, streams and impounded water. All work under this Contract shall be performed in such a manner that objectionable conditions will not be created in streams through, or bodies of water adjacent to, the project area.
- B. Surface drainage from cuts and fills within the construction limits, whether or not completed, and from borrow and waste disposal areas, shall, if turbidity producing materials are present, be held in suitable sedimentation basins or shall be graded to control erosion within acceptable limits. Temporary erosion and sediment control measures such as berms, dikes, drains, or sedimentation basins, if required to meet the above standards, shall be provided and maintained until permanent drainage and erosion control facilities are completed and operative. The area of bare soil exposed at any one time by construction operations should be held to a minimum.
- C. Apply temporary mulch on denuded ground immediately after rough grading is completed. This shall apply to all areas not subject to appreciable traffic during construction, even those that are to receive some form of construction later if ground is to be exposed 30 days or more.
- D. Stream and drainage ditch crossings by fording with equipment shall be limited to control turbidity, and in areas of frequent crossings, temporary culverts or bridge structures shall be installed. Any temporary culverts or bridge structures shall be removed upon completion of the project. Fills and waste areas shall be constructed by selective placement to eliminate silts or clays on the surface that will erode and contaminate adjacent streams.
- E. At all times of the year, special measures shall be taken to prevent chemicals, fuels, oils, greases, bituminous materials, waste washings, herbicides and insecticides, and cement and surface drainage from entering public waters.
- F. Disposal of any materials, wastes, effluents, trash, garbage, oil, grease, chemicals, etc., in areas adjacent to streams or other waterways shall be disposed of by the Contractor in accordance with the applicable governing regulations. If any waste material is dumped in unauthorized area, the Contractor shall remove the material and restore the area to the condition of the adjacent undisturbed area. If necessary, contaminated ground shall be excavated, disposed of as specified hereinbefore, and replaced with suitable fill material, compacted and finished with topsoil, all at the expense of the Contractor.

3.03 MAINTENANCE

- A. The Contractor shall dispose of all discarded debris and aggregate samples in a manner approved by the Engineer. Toilet facilities shall be kept clean and sanitary at all times. Services shall be performed at such a time and in such a manner to least interfere with the operations. Services shall be accomplished to the satisfaction of the Engineer.

- B. The Contractor shall frequently remove materials no longer required on the site so that, at all times, the site, access routes to the site and any other areas disturbed by his operations shall present a neat, orderly, workmanlike appearance.
- C. Before semi-final payment, the Contractor shall remove all surplus material, plant of any description, and debris of every nature resulting from his operations, and put the site in a neat, orderly condition; and restore all areas which have been used for storage of materials and equipment, and all areas which have been disturbed by his operations, to their original condition or to a condition satisfactory to and approved by the Engineer.

3.04 DUST CONTROL

- A. The Contractor shall maintain all excavations, embankments, stockpiles, haul roads, permanent access roads, waste areas, borrow areas and all other work areas within or without the project boundaries free from dust which would cause a hazard or nuisance to others or contaminate surface water.

3.05 NOISE CONTROL

- A. The Contractor shall use every effort and means possible to minimize or eliminate noise caused by his operation which the Engineer may consider objectionable.
- B. All equipment utilized by the Contractor at the Landfill shall be equipped with adequate muffler systems to minimize on-site noise generation.

3.06 ODOR CONTROL

- A. Suitable measures shall be taken to minimize odors at the Landfill. Any odors originating from the Contractor's operations which expose solid waste shall be minimized by immediately covering with adequate layers of approved cover material.
- B. Under no circumstances shall exposed solid waste remain uncovered overnight.

3.07 LITTER CONTROL

- A. Any litter generated by the Contractor's operation, whether from disturbance of existing buried solid waste or generated in the course of performing the work under Contract, shall be collected and properly disposed of on a daily basis.

3.08 VECTOR CONTROL

- A. Sanitary measures and conditions shall be maintained at the Landfill, by the Contractor, at all times in order to avoid harboring, feeding, and breeding of vectors.

3.09 FIRE PREVENTION AND CONTROL

- A. Open burning of any type within the Landfill or on adjacent property is prohibited.

- B. The Contractor shall take necessary precautions and implement procedures to prevent and control fires, whether on the Landfill or within a piece of equipment used in performing the work under Contract.

3.10 PROHIBITED CONSTRUCTION PROCEDURES

- A. The Contractor is advised that the disposal of excess excavated material in wetlands, stream corridors, and floodplains is strictly prohibited. Any violation of this restriction by the Contractor or any person employed by him, will be brought to the immediate attention of the responsible regulatory agencies.
- B. The Contractor shall comply with the following requirements regarding prohibited construction procedures as follows:
 - 1. Dumping of spoil material into any stream corridor, any wetland, any surface waters, or at unspecified locations.
 - 2. Indiscriminate, arbitrary or capricious operation of equipment in any stream corridors, any wetlands or surface waters.
 - 3. Pumping of silt-laden water from trenches or other excavations into any surface waters, any stream corridors or any wetlands.
 - 4. Damaging vegetation adjacent to, or outside of, the area of the work.
 - 5. Disposal of trees, brush and other debris in any stream corridors, any wetlands, any surface waters, or at unspecified locations.
 - 6. Permanent or unspecified alteration of the flow line of any stream.
 - 7. Open burning of project debris.
 - 8. Location of storage stockpile areas in environmentally sensitive areas.
 - 9. Disposal of excess or unsuitable excavation material in wetlands or floodplains even with permission of the property owner.

END OF SECTION

(THIS PAGE INTENTIONALLY LEFT BLANK)

SECTION 01170

ENVIRONMENTAL PROTECTION

PART 1 GENERAL

1.01 SUMMARY

A. Section Includes

1. Requirements for environmental protection during and as the result of construction operations under this Contract except for those measures set forth in other provisions of these Specifications.
2. Environmental protection requires consideration of air, water and land, noise, solid waste management, vector and fire control.

B. Related Sections

1. Section 01300 - Submittals
2. Section 02228 - Waste Material Disposal

1.02 QUALITY ASSURANCE

A. Requirements of regulatory agencies:

1. In order to prevent environmental pollution and to provide for environmental protection arising from construction activities related to the performance of this Contract, the Contractor and his subcontractors shall comply with all applicable Federal, State, and local laws and regulations concerning environmental protection, as well as the specific requirements stated in the Section and elsewhere in the Specifications.

1.03 SUBMITTALS

A. Under the requirements of Section 01300 - Submit the following.

B. Implementation Plan

1. Prior to commencement of the work, the Contractor shall:
 - a. Submit in writing his plans for implementing this Section for environmental protection.
 - b. Meet with the Engineer to develop mutual understandings relative to compliance with the provisions of this Section and administration of the environmental protection program.

C. Temporary Excavation and Embankments

1. If the Contractor proposes to construct temporary roads or embankments and excavations for work areas, he shall submit the following for approval prior to scheduled start of such temporary work:
 - a. A layout of all temporary roads, excavations and embankments to be constructed within the work area.
 - b. Plans and cross-sections of proposed embankments and their foundations, including a description of proposed materials.
 - c. A landscaping plan showing the proposed restoration of the area. Removal of any necessary trees and shrubs outside the limits of existing cleared areas shall

be indicated. The plan shall provide for the obliteration of construction scars and shall provide for a reasonably natural appearing final condition of the area. Modification of the Contractor's plans shall be made only with the written approval of the Engineer. No unauthorized road construction, excavation or embankment construction, including disposal areas will be permitted.

D. Erosion Sedimentation Plan

1. The Contractor shall submit to the Engineer, a detailed erosion and sedimentation plan for approval at least 10 days prior to initiation of work. The plan shall include location and construction details of the Contractor's proposed dikes, basins, etc. The Contractor shall provide and submit his control measures for stockpile material.

PART 2 PRODUCTS

2.01 GENERAL

- A. All materials shall be as specified elsewhere in this Specification.

PART 3 EXECUTION

3.01 PROTECTION OF LAND RESOURCES

- A. It is intended that the land resources within the project boundaries and outside the limits of permanent work performed under this Contract be preserved in their present condition, or be restored to a condition after completion of construction, that will appear to be natural and not detract from the appearance of the project. The Contractor shall confine his construction activities to areas defined on the Drawings or in the Specifications except with written approval of the property owners and the Engineer.
- B. Limits of working areas include areas for storage of construction material, and shall be cleared in a manner which will enable satisfactory restoration and which will not affect the environment during or after the construction period. The Contractor shall not enter beyond the working limits of the working area except with written approval of the Engineer and Owner.
- C. The location of areas for storage of the Contractor's materials required temporarily in the performance of the work, shall be within the limits of the working area and shall require written approval of the Engineer prior to use. The preservation of the landscape shall be an imperative consideration in the selection of all such sites. Where temporary structures are constructed on sidehills, the Engineer may require cribbing to be used to obtain level foundation. Benching or leveling of earth may not be allowed, depending on the location of the proposed facility.
- D. The Contractor shall obliterate all signs of temporary construction facilities such as haul roads, work areas, structures, foundations of temporary structures, stockpiles of excess or waste materials, or any other vestiges of construction. It is anticipated that excavation, filling and plowing of roadways will be required to restore the area to near natural conditions which permit the growth of vegetation thereon. The disturbed areas shall be graded and filled as

required, and topsoil shall be spread to a depth of approximately 6 inches over the entire area and the entire area shall be seeded.

3.02 PROTECTION OF WATER RESOURCES

- A. The Contractor shall not pollute streams, lakes or reservoirs with fuels, oils, bitumen's, calcium chloride, acids or harmful materials. It is the responsibility of the Contractor to investigate and comply with all applicable Federal, State, County, and Municipal laws concerning pollution of rivers, streams and impounded water. All work under this Contract shall be performed in such a manner that objectionable conditions will not be created in streams through, or bodies of water adjacent to, the project area.
- B. Surface drainage from cuts and fills within the construction limits, whether or not completed, and from borrow and waste disposal areas, shall, if turbidity producing materials are present, be held in suitable sedimentation basins or shall be graded to control erosion within acceptable limits. Temporary erosion and sediment control measures such as berms, dikes, drains, or sedimentation basins, if required to meet the above standards, shall be provided and maintained until permanent drainage and erosion control facilities are completed and operative. The area of bare soil exposed at any one time by construction operations should be held to a minimum.
- C. Apply temporary mulch on denuded ground immediately after rough grading is completed. This shall apply to all areas not subject to appreciable traffic during construction, even those that are to receive some form of construction later if ground is to be exposed 30 days or more.
- D. Stream and drainage ditch crossings by fording with equipment shall be limited to control turbidity, and in areas of frequent crossings, temporary culverts or bridge structures shall be installed. Any temporary culverts or bridge structures shall be removed upon completion of the project. Fills and waste areas shall be constructed by selective placement to eliminate silts or clays on the surface that will erode and contaminate adjacent streams.
- E. At all times of the year, special measures shall be taken to prevent chemicals, fuels, oils, greases, bituminous materials, waste washings, herbicides and insecticides, and cement and surface drainage from entering public waters.
- F. Disposal of any materials, wastes, effluents, trash, garbage, oil, grease, chemicals, etc., in areas adjacent to streams or other waterways shall be disposed of by the Contractor in accordance with the applicable governing regulations. If any waste material is dumped in unauthorized area, the Contractor shall remove the material and restore the area to the condition of the adjacent undisturbed area. If necessary, contaminated ground shall be excavated, disposed of as specified hereinbefore, and replaced with suitable fill material, compacted and finished with topsoil, all at the expense of the Contractor.

3.03 MAINTENANCE

- A. The Contractor shall dispose of all discarded debris and aggregate samples in a manner approved by the Engineer. Toilet facilities shall be kept clean and sanitary at all times. Services shall be performed at such a time and in such a manner to least interfere with the operations. Services shall be accomplished to the satisfaction of the Engineer.

- B. The Contractor shall frequently remove materials no longer required on the site so that, at all times, the site, access routes to the site and any other areas disturbed by his operations shall present a neat, orderly, workmanlike appearance.
- C. Before semi-final payment, the Contractor shall remove all surplus material, plant of any description, and debris of every nature resulting from his operations, and put the site in a neat, orderly condition; and restore all areas which have been used for storage of materials and equipment, and all areas which have been disturbed by his operations, to their original condition or to a condition satisfactory to and approved by the Engineer.

3.04 DUST CONTROL

- A. The Contractor shall maintain all excavations, embankments, stockpiles, haul roads, permanent access roads, waste areas, borrow areas and all other work areas within or without the project boundaries free from dust which would cause a hazard or nuisance to others or contaminate surface water.

3.05 NOISE CONTROL

- A. The Contractor shall use every effort and means possible to minimize or eliminate noise caused by his operation which the Engineer may consider objectionable.
- B. All equipment utilized by the Contractor at the Landfill shall be equipped with adequate muffler systems to minimize on-site noise generation.

3.06 ODOR CONTROL

- A. Suitable measures shall be taken to minimize odors at the Landfill. Any odors originating from the Contractor's operations which expose solid waste shall be minimized by immediately covering with adequate layers of approved cover material.
- B. Under no circumstances shall exposed solid waste remain uncovered overnight.

3.07 LITTER CONTROL

- A. Any litter generated by the Contractor's operation, whether from disturbance of existing buried solid waste or generated in the course of performing the work under Contract, shall be collected and properly disposed of on a daily basis.

3.08 VECTOR CONTROL

- A. Sanitary measures and conditions shall be maintained at the Landfill, by the Contractor, at all times in order to avoid harboring, feeding, and breeding of vectors.

3.09 FIRE PREVENTION AND CONTROL

- A. Open burning of any type within the Landfill or on adjacent property is prohibited.

- B. The Contractor shall take necessary precautions and implement procedures to prevent and control fires, whether on the Landfill or within a piece of equipment used in performing the work under Contract.

3.10 PROHIBITED CONSTRUCTION PROCEDURES

- A. The Contractor is advised that the disposal of excess excavated material in wetlands, stream corridors, and floodplains is strictly prohibited. Any violation of this restriction by the Contractor or any person employed by him, will be brought to the immediate attention of the responsible regulatory agencies.
- B. The Contractor shall comply with the following requirements regarding prohibited construction procedures as follows:
 - 1. Dumping of spoil material into any stream corridor, any wetland, any surface waters, or at unspecified locations.
 - 2. Indiscriminate, arbitrary or capricious operation of equipment in any stream corridors, any wetlands or surface waters.
 - 3. Pumping of silt-laden water from trenches or other excavations into any surface waters, any stream corridors or any wetlands.
 - 4. Damaging vegetation adjacent to, or outside of, the area of the work.
 - 5. Disposal of trees, brush and other debris in any stream corridors, any wetlands, any surface waters, or at unspecified locations.
 - 6. Permanent or unspecified alteration of the flow line of any stream.
 - 7. Open burning of project debris.
 - 8. Location of storage stockpile areas in environmentally sensitive areas.
 - 9. Disposal of excess or unsuitable excavation material in wetlands or floodplains even with permission of the property owner.

END OF SECTION

(THIS PAGE INTENTIONALLY LEFT BLANK)

SECTION 01200

PROJECT MEETINGS

PART 1 GENERAL

1.01 SECTION INCLUDES

- A. Administrative and procedural requirements for project meetings.

1.02 PRECONSTRUCTION CONFERENCE

- A. The Engineer will schedule and administer a pre-construction conference.
- B. The pre-construction conference will be scheduled and administered within fourteen (14) calendar days after the dated "Notice to Proceed". The Contractor shall be prepared to address such topics as projected construction schedules, major personnel, critical work areas, construction facilities and shop drawing submittals.

1.03 PROGRESS MEETINGS

- A. The Engineer will schedule and administer progress meetings and specially called meetings throughout the duration of the Work at minimum monthly intervals.
- B. The time and location of such meetings shall be designated by the Engineer and shall be convenient for all parties involved.
- C. The Engineer will, prepare agenda with copies for participants, preside at meetings, record minutes, and distribute copies to participants, and those affected by decisions made.

PART 2 PRODUCTS

NOT USED

PART 3 EXECUTION

NOT USED

END OF SECTION

(THIS PAGE INTENTIONALLY LEFT BLANK)

SECTION 01300

SUBMITTALS

PART 1 GENERAL

1.01 SECTION INCLUDES

- A. Requirements for submission of schedules and shop drawings.

1.02 PROGRESS SCHEDULE

- A. Refer to Section 01310 Construction Progress Schedule for Critical Path Method (CPM) construction scheduling requirements.
- B. Special attention is directed to the requirement that the Contractor shall start the Work, as specified under this Contract, no later than thirty (30) calendar days after the execution of the Contract Documents, unless otherwise directed by the Owner. The Contractor shall comply with all pre-construction requirements as specified. The Owner reserves the right to delay the commencement of the Work or any part thereof if the specified requirements as determined by the Engineer have not been satisfied. The Owner further reserves the right to limit or, delay construction, or certain activities thereof, in certain areas of the Contract should the Owner deem it to be in the public's best interest and/or safety to do so.
- C. The Contractor shall contact the appropriate town or city authorities concerning any public or semi-public events that may occur during the construction period that may affect construction. The Contractor alone shall be responsible for arranging his construction sequence to conform to any restrictions these events may impose. No claims for extras will be allowed because of any delay, extra materials handling, extra excavation, etc. caused by the imposed restrictions. However, additional time may be granted for completion of the work to compensate for delays caused by said restrictions.

1.03 SHOP DRAWINGS

- A. Submit all shop and working drawings through agreed upon electronic Shop Drawing Submittal and tracking program. Shop Drawings shall be provided for materials and equipment to be permanently incorporated into the work and shall include items such as concrete reinforcement, structural details, piping layout, wiring, materials fabricated especially for the Contract, and materials and equipment for which such drawings are specifically requested.
- B. Products, materials, equipment, appurtenances, and fasteners incorporated into this project are subject **to the American Iron and Steel requirements of P.L. 113-76, the Consolidated Appropriations Act of 2014**. Proper certification shall be included with the initial Shop Drawing submission. Submissions that do not include the required certifications will be rejected without review.
- C. A maximum of two (2) submittals of each shop drawing will be reviewed by the Engineer. If more submittals are required due to the Contractor's neglect or failure to fulfill the requirements of the Contract plans and specifications, or to make corrections or modifications

required by the Engineer in the review of the first two submittals, the Engineer will review the submittal and the Contractor will be responsible for the cost of the review, as determined by the Owner based on the Engineer's documentation of time and rates for additional services established in the Engineering Agreement between the Owner and the Engineer.

- D. Such drawings shall show the principal dimensions, weight, structural and operating features, space required, clearances, type and/or brand of finish or shop coat, grease fittings, etc., depending on the subject of the drawing. When the dimensions are of particular importance, or when specified, the drawings shall be certified by the manufacturer or fabricator as correct for the Contract.
- E. When so specified or if considered by the Engineer to be acceptable, manufacturer's specifications, catalog data, descriptive matter, illustrations, etc., may be submitted in place of shop and working drawings.
- F. The Contractor shall be responsible for the prompt and timely submittal of all shop and working drawings to eliminate delay to the Work due to the absence of such drawings. All shop and working drawings must be submitted to the Engineer within thirty (30) calendar days prior to incorporation into the Work, unless otherwise permitted by the Engineer. **Prior to the submittal of any shop drawings, the Contractor shall submit a schedule of proposed shop drawing transmittals.** The schedule shall identify the subject matter of each transmittal, the corresponding specification section number and the proposed date of submission. Prior to and during the progress of the Work the schedule shall be revised and resubmitted as requested by the Engineer.
- G. No material or equipment shall be purchased or fabricated for the Contract until the required shop and working drawings have been submitted as hereinabove provided and reviewed for conformance to the Contract requirements. All such materials and equipment and the work involved in their installation or incorporation into the Work shall then be as shown in and represented by said drawings.
- H. Until the necessary review has been made, the Contractor shall not proceed with any portion of the Work (such as the construction of foundations) for which review is required.
- I. All shop and working drawings shall be submitted to the Engineer by and/or through the Contractor, who shall be responsible for obtaining shop and working drawings from his subcontractors and returning reviewed drawings to them. All shop and working drawings shall be prepared on standard size, 24 inch by 36 inch sheets, except those which are made by changing existing standard shop and working drawings. All drawings shall be clearly marked with the names of the Owner, Contractor, and building, equipment, or structure to which the drawing applies, and shall be suitable numbered. Submitted shop drawings shall be accompanied by a letter of transmittal, completed by the Contractor as provided by the Engineer.
- J. Only drawings which have been checked and corrected by the fabricator should be submitted to the Contractor by his subcontractors and vendors. Prior to submitting drawings to the Engineer, the Contractor shall check thoroughly all such drawings to satisfy himself that the subject matter thereof conforms to the Drawings and Specifications in all respects. All drawings which are correct shall be marked with the date, checker's name, and indication of the Contractor's approval, and then shall be submitted to the Engineer; other drawings shall be returned for correction.

- K. If a shop drawing shows any deviation from the Contract requirements, the Contractor shall make specific mention of the deviations in his letter of transmittal.
- L. The review of shop and working drawings by the Engineer will be general only, and nothing contained in this Section shall relieve, diminish or alter in any respect the responsibilities of the Contractor under the Contract Documents and in particular, the specific responsibility of the Contractor for details of design and dimensions necessary for proper fitting and construction of the work as required by the Contract and for achieving the result and performance as specified. The Contractor shall be responsible for errors and omissions in shop drawings.
- M. Should the Contractor submit equipment that requires modifications to the structures, piping, electrical conduit, wires, appurtenances, or layouts etc., either existing or as detailed on the Drawings, he shall also submit details of the proposed modifications. If such equipment and modifications are accepted, the Contractor, at no additional cost to the Owner, shall do the work necessary to make such modifications.
- N. The Contractor shall furnish additional copies of shop drawings or catalog cuts when so requested.

PART 2 PRODUCTS

NOT USED

PART 3 EXECUTION

NOT USED

END OF SECTION

(THIS PAGE INTENTIONALLY LEFT BLANK)

SECTION 01310

CONSTRUCTION PROGRESS SCHEDULE

PART 1 GENERAL

1.01 SECTION INCLUDES

- A. Requirements for computer generated Critical Path Method (CPM) construction scheduling and Narrative progress report.
- B. No portion of this specification shall take precedent over SECTION 00500-Contract Agreement.

1.02 SUBMITTALS

- A. Submit in accordance with SECTION 01300-Submittals
 - 1. Quality Assurance/Control Submittal
 - a. Name and version of CPM software proposed for use.
 - b. List of construction projects completed on which progress of work was controlled with CPM software.
 - 2. Schedule
 - a. Within **14 days** following the receipt of the Notice to Proceed, the Contractor shall submit **two** color copies of a computer generated schedule and a list of activities to the Engineer. Following review by the Engineer and Owner the Contractor shall meet with the Engineer and Owner to discuss the review. The Contractor shall incorporate the Engineer's comments into the schedule and submit eight color copies of the revised schedule within 14 days following receipt of the Engineer's comments.

PART 2 PRODUCTS

2.01 SOFTWARE

- A. Computer based scheduling software used by the Contractor shall be the product of a recognized commercial computer software producer and shall be capable of meeting the requirements specified herein.

PART 3 EXECUTION

3.01 PREPARATION

- A. General
 - 1. The Contractor shall prepare his proposed CPM schedule based on a breakdown of work tasks that he has developed.
 - 2. The construction schedule and updates shall be prepared by the Contractor or the Contractor's qualified consultant.

B. Schedule

1. Each schedule shall be prefaced with the following summary data:
 - a. Contract name and number
 - b. Contractor's Name
 - c. Contract duration
 - d. The effective or starting date of the schedule
 - e. Revision date of the latest schedule.
2. The CPM schedule shall be sequenced by early start date and shall include the following minimum items:
 - a. Activity Name
 - b. Estimated duration
 - c. Activity description
 - d. Early start date (calendar date)
 - e. Early finish date (calendar date)
 - f. Latest allowable start date (calendar date)
 - g. Latest allowable finish date (calendar date)
 - h. Status (whether critical)
 - i. Estimated cost of the activity
 - j. Float (total and free)
 - k. Major milestones
3. Separate milestones shall be included for Notice-to-Proceed and Project Completion Date.
4. Activities shall include major components of the work including submittals that might impact the critical path, subcontractor work, major and critical equipment design, fabrication, testing, delivery and installation times, system/subsystem/component testing, process and facility startup, training, demobilization, project cleanup and closeout. Critical portions of process instrumentation and control system work, shall be defined in detail in a sub schedule.
5. The sum of the costs assigned to the activities shall be equal to the Contract price. Activity costs shall not be assigned to submittals or submittal reviews. Comply with SECTION 01026-Schedule of Values. Provide a table showing the anticipated monthly percentage of completion, based on the total contract price.
6. Critical activities, predecessors, free float and total float shall be clearly displayed on the schedule in graphical form. Schedules that contain activities showing negative float or that extend beyond the contract completion date will not be approved.
7. Each schedule submittal shall also include a list of activities in the order in which the activities will be performed, along with activity durations, activity predecessors, type of predecessor (finish-start, finish-finish, start-start, lead/lag), and any dependency or required date.
8. The schedule shall be based on a standard 5-day work week with allowance for holidays and adverse weather.
9. Engineer's approval of the CPM schedule is advisory only and shall not relieve the Contractor of responsibility for accomplishing the work prior to the contract completion date. Omissions and errors in the approved CPM schedule shall not excuse performance less than that required by the Contract. Approval by the Engineer in no way makes the Engineer an insurer of the CPM schedule's success or liable for time or cost overruns flowing from its shortcomings. The Owner hereby disclaims any obligation or liability by reason of approval by its agent, the Engineer, of the CPM schedule.

C. Narrative Progress Report

1. Include as a minimum:
 - a. Summary of work completed during the previous period (since submission of last narrative progress report).
 - b. Explanation for variations between actual work completed in previous period and planned work as reported in last period.
 - c. Summary of work planned during the next period.
 - d. Current and anticipated delaying factors and their estimated impacts on other activities and milestones, both critical and non-critical.
 - e. Corrective actions taken or proposed.
2. A Narrative Progress Report shall be submitted monthly to the Engineer, at least 5 working days prior to the progress meeting.
3. At the discretion of the Engineer, the Contractor may be required to submit a revised CPM schedule showing completion to date and any changes to the previous schedule.

3.02 MONITORING SCHEDULE

- A. The CPM approved construction schedule shall be used by the Contractor throughout the duration of the project for planning, organizing, and directing the Work, and for reporting progress of the Work
- B. The Contractor is solely responsible for monitoring schedule compliance. When a delay to the critical path occurs, the Contractor shall immediately notify the Engineer in writing. Within one week of the notification, the Contractor shall submit for the Engineer's approval, a description of proposed actions to return the project to schedule.

3.03 MODIFYING SCHEDULE

- A. If the Contractor desires to make changes in his method of operating which affect the approved CPM schedule, he shall notify the Engineer in writing stating what changes are proposed and the reason for the change. If the Engineer approves these changes, the Contractor shall revise and submit for approval, without additional cost to the Owner, all of the affected portions of the CPM schedule.
- B. It may be necessary for the contract schedule or completion time to be adjusted by the Owner to reflect the effects of job conditions, weather, technical difficulties, strikes, unavoidable delays on the part of the Owner or its representatives and other unforeseeable conditions which may indicate schedule adjustments or completion time extensions. Under such conditions, the Engineer will direct the Contractor to reschedule the work or contract completion time to reflect the changed conditions and the Contractor shall revise his schedule accordingly.
- C. Float time is a project resource available to both the Contractor and the Owner to meet contract milestones and completion dates. Use of float suppression techniques such as preferential sequencing or logic, special lead/lag logic restraints, and extended activity times are prohibited, and use of float time disclosed or implied by use of alternate float suppression techniques shall be shared to proportionate benefit of OWNER and CONTRACTOR.

- D. If the Contractor provides an accepted schedule with an early completion date, the Owner reserves the right to reduce the Time of Completion to match the early completion date by issuing a deductive Change Order at no change in Contract Price.

END OF SECTION

SECTION 01400

QUALITY CONTROL

PART 1 GENERAL

1.01 SECTION INCLUDES

- A. Requirements for Contractor's quality control of products, suppliers, manufacturers, services, site conditions, and workmanship, to produce Work of specified quality.

1.02 QUALITY ASSURANCE/CONTROL OF INSTALLATION

- A. Comply fully with manufacturers' instructions, including each step in sequence.
- B. Should manufacturers' instructions conflict with Contract Documents, request clarification from Engineer before proceeding.
- C. Comply with specified standards as a minimum quality for the Work except when more stringent tolerances, codes, or specified requirements indicate higher standards or more precise workmanship.
- D. Perform work by persons qualified to produce workmanship of specified quality.
- E. Secure Products in place with positive anchorage devices designed and sized to withstand stresses, vibration, physical distortion or disfigurement.

1.03 FIELD SAMPLES

- A. Install field samples at the site as required by individual specifications sections for review.
- B. Acceptable samples represent a quality level for the Work.
- C. Where field sample is specified to be removed, clear area only after field sample has been accepted by the Engineer.

1.04 CERTIFIED WELDERS

- A. Structural welds shall be made only by operators who have been qualified by tests, as prescribed in the "Standard Qualification Procedure" of the American Welders Society, to perform the type of work required.
- B. Pipe welds shall be made only by operators who have been qualified by the National Certified Pipe Welding Bureau and each operator's qualification record shall be submitted to the Engineer before any work is performed.
- C. Shop welding shall be in accordance with the "Code for Welding in Building Construction".

PART 2 PRODUCTS

NOT USED

PART 3 EXECUTION

NOT USED

END OF SECTION

SECTION 01410

TESTING LABORATORY SERVICES

PART 1 GENERAL

1.01 SUMMARY

A. Section Includes

1. Qualification, duties and responsibilities of testing laboratories.
2. Coordination and scheduling responsibilities of the Contractor.

B. Related Sections

1. Section 01600 - Materials and Equipment

1.02 RESPONSIBILITY

- A. Contractor is responsible for hiring an Independent Laboratory to conduct sampling and analyses. The Contractor has full responsibility for the scheduling, coordination and payment.

1.03 REFERENCES

A. American Society for Testing and Materials (ASTM)

1. E329, Standard Specification for Agencies Engaged in Construction Inspection, Testing, or Special Inspection

1.04 REQUIREMENTS

A. Work included:

1. Cooperate with the Owner's selected testing agency and all others responsible for testing and inspecting the Work.
2. Provide other testing and inspecting as specified to be furnished by the Contractor in this Section and/or elsewhere in the Contract Documents.
3. Where no testing requirements are described, but the Owner directs testing, the Contractor shall provide testing under the requirements of this Specification.

B. Work not included:

1. Selection of testing laboratory: The Owner will select a qualified independent testing laboratory.

1.05 QUALITY ASSURANCE

A. Qualifications

1. The testing laboratory will be qualified to the Owner's approval in accordance with ASTM E329.

B. Regulatory requirements

1. Testing, when required, will be in accordance with all pertinent codes and regulations and with selected standards of the American Society for Testing and Materials.

2. Regulatory Requirements Inspections and tests required by codes or ordinances, or by a plan approved authority, and which are made by a legally constituted authority, shall be the responsibility of and shall be paid for by the Contractor, unless otherwise provided in the Contract Documents.

1.06 DELIVERY, STORAGE, AND HANDLING

- A. Comply with pertinent provisions of Section 01600 - Materials and Equipment.
- B. Promptly process and distribute, to the Engineer, required copies of test reports and instructions to assure necessary retesting and replacement of materials with the least possible delay in progress of the Work.

1.07 SCHEDULING

- A. Establishing schedule
 1. By advance discussion with the testing laboratory selected by the Owner, determine the time required for the laboratory to perform its tests and to issue each of its findings.
 2. Provide all required time within the construction schedule.
 3. Coordinate testing activity with the appropriate testing laboratory.
- B. Revising schedule
 1. When changes of construction schedule are necessary during construction, coordinate all such changes with the testing laboratory as required.
- C. Adherence to schedule
 1. When the testing laboratory is ready to test according to the established schedule, but is prevented from testing or taking specimens due to incompleteness of the Work, all extra charges for testing attributable to the delay may be back-charged to the Contractor and shall not be borne by the Owner.

PART 2 PRODUCTS

NOT USED

PART 3 EXECUTION

3.01 FIELD QUALITY CONTROL

- A. Site Tests
 1. Representatives of the testing laboratory shall have access to the Work at all times and at all locations where the Work is in progress. Provide facilities for such access to enable the laboratory to perform its functions properly.
 2. All specimens and samples for testing, unless otherwise provided in the Contract Documents, shall be taken by the testing personnel. All sampling equipment and personnel will be provided by the testing laboratory. All deliveries of specimens and samples to the testing laboratory will be performed by the testing laboratory.

END OF SECTION

SECTION 01510

TEMPORARY UTILITIES

PART 1 GENERAL

1.01 SECTION INCLUDES

- A. Requirements for temporary utilities required during construction.

1.02 GENERAL REQUIREMENTS

- A. The Contractor is responsible for payment of all costs associated with the installation and operation of all temporary utilities necessary for the completion of the work. The General Contractor shall arrange with the Engineer and Owner methods of determining monthly utility costs for Temporary Utilities prior to connection of any temporary systems. The Contractor shall pay the Owner on a monthly basis for all temporary utility costs. The Temporary Utilities to be paid by the Contractor include but are not limited to the following: Electricity, Water, Sanitary, Heating, Ventilation, Plumbing and other services required to complete the work.

1.03 TEMPORARY WATER

- A. Temporary pipe lines and connections from the permanent service lines, necessary for the use of the General Contractor and his Subcontractors shall be installed, protected, and maintained at the expense of the General Contractor.
- B. Provide an adequate supply of drinking water from an approved source of acceptable quality, satisfactorily cooled, for his employees and those of his Subcontractors.

1.04 TEMPORARY ELECTRICITY

- A. Provide electrical energy required for temporary lighting and power.
- B. Temporary wiring of a special nature shall be paid for by the Contractor including but not limited to special circuits required by electric welders, elevators, lifts, pumps or other special equipment requiring high-amperage and/or special voltage service and exterior lighting circuits for protection against vandalism, public warning lights and lights for advertising, etc.
- C. The General Contractor and all Subcontractors, individually, shall furnish all extension cords, sockets, motors, and accessories required for their work. They shall also pay for all temporary wiring of construction offices and buildings used by them.
- D. Temporary wiring installed by the Electrical Subcontractor shall be removed after it has served its purpose.
- E. Electrical work to be done in accordance with applicable codes.

1.05 TEMPORARY SANITARY FACILITIES

- A. Provide adequate sanitary facilities for the use of those employed on the Work. Sanitary facilities shall be made available when the first employees arrive on the site of the Work, be properly secluded from public observation, and be maintained during the progress of the Work in suitable numbers.
- B. Maintain sanitary facilities in an orderly and sanitary condition at all times and enforce their use. Rigorously prohibit the committing of nuisances on the site of the Work, on the lands of the Owner, or any adjacent property.

1.06 TEMPORARY HEATING

- A. Within 30 calendar days after the execution of this Contract, submit in writing to the Engineer for approval, three copies of method and time schedule for heating during construction which shall concur with his progress schedule submitted under Specification Section 01300.
- B. The installation and operation of heating devices shall comply with all safety regulations including provisions for adequate ventilation and fire protection. Heating devices which may cause damage to finish surfaces shall not be used.
- C. After the permanent heating system has been installed, tested, and made ready for operation, the Contractor may, at his own risk and expense, use it for providing heat for protection of the Work. He shall provide and pay for all fuel and care necessary, and, when the Work is ready for acceptance, he shall, at his own expense, put the system into first-class condition, even to the extent of replacing worn or damaged parts as directed.

PART 2 PRODUCTS

NOT USED

PART 3 EXECUTION

NOT USED

END OF SECTION

SECTION 01525

TEMPORARY ENCLOSURES

PART 1 GENERAL

1.01 SECTION INCLUDES

- A. Requirements for protecting portions of the Work which are affected by inclement weather conditions.
- B. Provide "Weather Protection" and heat to permit construction work to be carried on during the months of November through March. These Specifications are not to be construed as requiring enclosures or heat for operations that are not economically feasible to protect in the judgment of the Engineer. Included in the preceding category, without limitation, are such items as site work, excavation, pile driving, steel erection, erection of certain "exterior" wall panels, roofing, and similar operation.

1.02 SUBMITTALS

- A. Within 30 calendar days after execution of this contract, submit in accordance with Specification Section 01300, proposed methods for "Weather Protection".

1.03 WEATHER PROTECTION

- A. Weather Protection shall be provided for protection of that work adversely affected by moisture, wind and cold, by covering, enclosing and/or heating. This protection shall provide adequate working areas during dates consistent with the approved Progress Schedule to permit the continuous progress of all work necessary to maintain an orderly and efficient sequence of construction operations.
- B. Furnish and install all enclosures and be responsible for all costs, including heating required to maintain a minimum temperature of 40 degrees F., at the working surface. This provision does not supersede any specific requirements for methods of construction, curing of materials or the applicable general conditions set forth in the Contract Documents with added regard to performance obligations of the Contractor.
- C. Installation of weather protection and heating devices shall comply with all safety regulations including provisions for adequate ventilation and fire protection devices. Heating devices which may cause damage to finish surfaces shall not be used.

PART 2 PRODUCTS NOT USED

PART 3 EXECUTION NOT USED

END OF SECTION

(THIS PAGE INTENTIONALLY LEFT BLANK)

SECTION 01560

TEMPORARY CONTROLS

PART 1 GENERAL

1.01 SECTION INCLUDES

- A. Requirements for cleaning, maintenance of the site, barriers and fences required during construction.

1.02 CLEANING DURING CONSTRUCTION

- A. Unless otherwise specified under the various trade Sections of the Specifications, the General Contractor shall perform clean-up operations during construction as herein specified.
 - 1. Control accumulation of waste materials and rubbish; periodically dispose of off-site. Bear all costs, including fees resulting from disposal.
 - 2. Clean interior areas prior to start finish work and maintain areas free of dust and other contaminants during finishing operations.
 - 3. Maintain project in accordance with all local, State and Federal Regulatory Requirements.
 - 4. Store volatile wastes in covered metal containers, and remove from premises.
 - 5. Prevent accumulation of wastes that create hazardous conditions.
 - 6. Provide adequate ventilation during use of volatile or noxious substances
- B. Conduct cleaning and disposal operations to comply with local ordinances and anti-pollution laws.
 - 1. Do not burn or bury rubbish and waste materials on site.
 - 2. Do not dispose of volatile wastes such as mineral spirits, oil, or paint thinner in storm or sanitary drains.
 - 3. Do not dispose of wastes into streams or waterways.
 - 4. Use only those materials which will not create hazards to health or property and which will not damage surfaces.
 - 5. Use only those cleaning materials and methods recommended by manufacturer of surface material to be cleaned.
 - 6. Execute cleaning to ensure that the buildings, the sites, and adjacent properties are maintained free from accumulations of waste materials and rubbish and wind blown debris, resulting from construction operations.
 - 7. Provide on-site containers for collection of waste materials, debris, and rubbish.
 - 8. Remove waste materials, debris, and rubbish from the site periodically and dispose of at legal disposal areas off the construction site.
 - 9. Handle material in a controlled manner with as little handling as possible. Do not drop or throw materials from heights.
 - 10. Schedule cleaning operations so that dust and other contaminants resulting from cleaning process will not damage surrounding surfaces.
 - 11. During its progress, the work and the adjacent areas affected thereby shall be kept cleaned up and all rubbish, surplus materials, and unneeded construction equipment shall be removed and all damage repaired so that the public and property owners will be inconvenienced as little as possible.
 - 12. Where material or debris has washed or flowed into or been placed in existing watercourses, ditches, gutters, drains, pipes, structures, work done under this contract, or

elsewhere during the course of the Contractor's operations, such material or debris shall be entirely removed and satisfactorily disposed of during the progress of the work, and the ditches, channels, drains, pipes, structures, and work, etc. shall, upon completion of the work, be left in a clean and neat condition.

1.03 DUST CONTROL

- A. Provide adequate means for the purpose of preventing dust caused by construction operations throughout the period of the construction contract.
- B. This provision does not supersede any specific requirements for methods of construction or applicable general conditions or performance obligations of the General Contractor.

1.04 EROSION AND SEDIMENT CONTROL

- A. Plan and execute construction by methods to control surface drainage from cuts and fills, from borrow and waste disposal areas. Prevent erosion and sedimentation.
- B. Minimize amount of bare soil exposed at one time.
- C. Provide temporary measures such as berms, dikes, and drains, to prevent water flow.
- D. Construct fill and waste areas by selective placement to avoid erosive surface silts for clays.
- E. Periodically inspect earthwork to detect evidence of erosion and sedimentation; promptly apply corrective measures.
- F. Construct sediment control devices for discharge from dewatering trenches.
- G. Construct all sedimentation control devices shown on the plans.

1.05 NOISE CONTROL

- A. Develop and maintain a noise-abatement program and enforce strict discipline over all personnel to keep noise to a minimum.
- B. Execute construction work by methods and by use of equipment which will reduce excess noise.
 - 1. Equip air compressors with Silencers, and power equipment with mufflers.
 - 2. Manage vehicular traffic and scheduling to reduce noise.

1.06 POLLUTION CONTROL

- A. Special care shall be taken to prevent contamination or muddying up or interfering in any way with the stream flows, if any along the line of work. No waste matter of any kind will be allowed to discharge into the stream flows or impounded water of any pools or other bodies of water.

1.07 SURFACE WATER CONTROL

- A. Take all precautions to prevent damage to the work or equipment by high waters or by storms. The Engineer with the approval of the Owner may prohibit the carrying out of any work at any time when in his judgment, high water or storm conditions are unfavorable or not suitable, or at any time, regardless of the weather, when proper precautions are not being taken to safeguard previously constructed work or work in progress.
- B. In case of damage caused by the failure of the Contractor to take adequate precautions, the Contractor shall repair or replace equipment damaged and shall make such repairs or rebuild such parts of the damaged work, as the Engineer may require, at no additional expense to the Owner.

1.08 BARRIERS AND ENCLOSURES

- A. Fences and Barricades
 - 1. Provide and maintain temporary fences, barriers, lights, guardrails, and barricades as indicated in the Contract Documents, or as necessary to secure the Work and adjacent property, and protect persons and property.
 - 2. Obtain necessary approvals and permits and provide temporary expedients as necessary to accommodate tasks requiring items mentioned herein.
- B. Protection of Trees
 - 1. The Contractor shall take care not to harm trees along the sides of roads or with in the existing facility in which the construction work is to be done or trees on adjacent lands except as indicated on the drawings or with the written permission of the Owner and any other owner of the trees involved. Care shall be taken not to cut tree roots so as to harm the growth of trees to remain.
 - 2. If, in the opinion of the Engineer, any trees damaged during construction can be repaired, the Contractor shall satisfactorily repair same at no further cost to the Owner.
 - 3. If, in the opinion of the Engineer, any tree damaged during construction cannot be repaired and should be removed, the Contractor shall satisfactorily remove and replace, in kind, same at no further cost to the Owner.

PART 2 PRODUCTS

NOT USED

PART 3 EXECUTION

NOT USED

END OF SECTION

(THIS PAGE INTENTIONALLY LEFT BLANK)

SECTION 01570

TRAFFIC REGULATIONS
(MASSACHUSETTS)

PART 1 GENERAL

1.01 SECTION INCLUDES

- A. Requirements for traffic control for the duration of the Contract.

1.02 REFERENCES

- A. Manual of Uniform Traffic Control Devices (MUTCD) Latest Edition, including all latest revisions.

1.03 PERFORMANCE REQUIREMENTS

- A. Contractor shall have the sole responsibility for the maintenance and protection of traffic.
- B. An authorized representative of the Contractor shall be available on a 24-hour basis for the duration of the Contract for the purpose of correcting construction related impediments or hazards.

1.04 SHOP DRAWINGS

- A. In accordance with SECTION 01300 – SUBMITTALS, submit a traffic plan delineating requirements of this section, the Contract Drawings, and the City of Taunton’s requirements.
- B. Traffic control plans shall detail all typical work zones and detours.

1.05 SITE CONDITIONS

- A. Replace at no cost to the Owner pavement markings, legends and lane arrows removed or damaged by the construction operation.
- B. Restore temporary detours to original condition.
- C. Replace traffic signal loops damaged during construction with in 72 hours.

1.06 SCHEDULING

- A. There shall be no time limitations on construction operations except those hours and locations where noise regulations may apply and except as required for the maintenance of traffic as required by the City of Taunton’s requirements.
- B. Keep closing of travel lanes to a minimum.
- C. Notify city departments 48 hours prior to construction operations on travel ways.

1. Police Department (508-824-7522).
2. Fire Department (508-821-1542).
3. Department of Public Works (508-821-1431).

PART 2 PRODUCTS

2.01 TRAFFIC CONTROL DEVICES

- A. In accordance with the MUTCD.

PART 3 EXECUTION

3.01 INSTALLATION OF TRAFFIC CONTROL DEVICES

- A. In accordance with the MUTCD.

3.02 PROTECTION OF TRAFFIC

- A. Barricade trenches and roadway excavations at the end of each work period with temporary precast concrete barriers, properly lighted and marked to guide traffic to designated travel lane. Or other means acceptable to the Engineer and approved on the Traffic Plan.
- B. Maintain and protect traffic movements for the entire length of the project.
- C. Keep one lane of traffic open at all times except for brief stoppages dictated by the construction operation involving safety of vehicles in the travel lanes.
- D. Maintain access to business and private ways during construction operations.
- E. Furnish sufficient number of signs, temporary precast concrete barriers, warning lights, drums and traffic cones to warn traffic of construction and guide traffic through the construction area in accordance with the MUTCD.

3.03 POLICE DETAILS

- A. Provide service of uniformed police details as required to complete construction as required by the Owner.

END OF SECTION

SECTION 01590

FIELD OFFICES

PART 1 GENERAL

1.01 SECTION INCLUDES

- A. Requirements for Contractor's and Engineer's field offices.

1.02 CONTRACTOR'S FIELD OFFICE

- A. Maintain a temporary field office near the work for his own use during the period of construction at which readily accessible copies of all contract documents shall be kept. Locate field office where it will not interfere with the progress of the Work. In charge of this office there shall be a responsible contractor superintendent.

1.03 ENGINEER'S FIELD OFFICE

- A. Prior to starting work at the site, provide and equip a suitable office for the exclusive use of the Engineer, and maintain this office until the completion of the Work under this Contract. This office shall be a separate building located, as directed, where it will not interfere with the progress of the work. An approved, suitably constructed and equipped trailer of adequate size and design for the purpose may be furnished as the Engineer's office. The office, furniture, equipment, and services necessary shall be satisfactory to the Engineer.
- B. The office shall be of suitable height and of ample size to accommodate the furniture and equipment listed below, without crowding (at least 400 sq. ft. of floor area). It shall be weather tight; the walls and roof shall be insulated with at least 1/2-in. insulating board suitably ventilated; and the floor shall be tight and of double-thick construction. The office shall have at least three screened windows which can be both opened and locked shut and the door shall have a cylinder lock with two keys. There also shall be a screen door.
- C. Provide acceptable toilet facilities within the office for the exclusive use of the Engineer. The Contractor shall make all water and sewer connections and pay all charges for such connections.
- D. Furnish the following furniture, equipment, supplies, and services:
 - 1. One plan table or sloping plan shelves, each about 3 ft. by 5 ft., with a reasonably smooth top, and two suitable swivel stools.
 - 2. Four additional chairs.
 - 3. Shelves as directed.
 - 4. Electric lights and outlets as directed. The Contractor shall pay all charges for the energy used.
 - 5. Broom and dustpan.
 - 6. Two desks for general office use, each about 3 ft. by 5 ft., one with a desk chair of the armchair swivel type and one with a secretary's chair.
 - 7. Plan rack, as directed.
 - 8. Two fireproof four-drawer, legal size, metal filing cabinets, each with lock.
 - 9. Wireless internet service with modem and router or hotspot. The Contractor shall pay all charges.

10. Carbon dioxide type fire extinguisher of at least 4-lb. capacity.
11. Insulated chest for storage and moist curing of concrete cylinders; size and construction as directed.
12. A wireless copy/fax/scan/printer machine with supplies and service.
13. Supply of drinking water in a suitable cooler or other approved container.
14. An outdoor thermometer - to be mounted on the outside of engineer's trailer.
15. Janitor service.
16. Paper cups, paper towels, liquid soap, and toilet paper; each with suitable dispenser or holder.
17. Thermostatically controlled heating unit or system of adequate capacity to maintain a minimum temperature of not less than 68 degrees. F. under all cold weather conditions.
18. Thermostatically controlled, refrigerant type, air conditioners of adequate capacity to maintain a maximum temperature of not more than 72 degrees F. under all hot weather conditions.

1.04 REMOVAL OF OFFICES

- A. Remove the Engineer's field office and all other temporary facilities from the site, after the date of completion of the Work as stated in the final estimate, unless otherwise directed by the Engineer. The field office and temporary facilities shall become the Contractor's property and the premises shall be left in a condition acceptable to the Engineer.

PART 2 PRODUCTS

NOT USED

PART 3 EXECUTION

NOT USED

END OF SECTION

SECTION 01600

MATERIALS AND EQUIPMENT

PART 1 GENERAL

1.01 SUMMARY

A. Section Includes

1. Requirements for delivery, storage, handling and installation of systems, materials, manufactured units, equipment, components, and accessories used in the work.

B. Related Sections

1. Section 01300 - Submittals

1.02 DELIVERY

A. Refer to Specifications' Sections for requirements pertaining to delivery and handling of materials and equipment.

B. Transport products by methods to avoid product damage; deliver in undamaged condition in manufacturers' unopened containers or packaging, dry.

C. Provide equipment and personnel to handle products by methods to prevent soiling or damage.

D. Promptly inspect shipments to assure that products comply with requirements, that quantities are correct, and products are undamaged.

1.03 STORAGE AND PROTECTION

A. Refer to Specifications' Sections for requirements pertaining to storage and protection of materials and equipment.

B. Store products in accordance with manufacturers' instruction, with seals and labels intact and legible. Store sensitive products in weather tight enclosures; maintain within temperature and humidity ranges required by manufacturers' instructions.

C. For exterior storage of fabricated products, place on sloped supports above ground. Cover products subject to deterioration with impervious sheet covering; provide ventilation to avoid condensation.

D. Store loose granular materials on solid surfaces in a well-drained area; prevent mixing with foreign matter.

E. Arrange storage to provide access for inspection. Periodically inspect to assure that products are undamaged, and are maintained under required conditions.

1.04 INSTALLATION STANDARDS

- A. Comply with Specifications and referenced standards as minimum requirements.
- B. Components required to be supplied in quantity within a Specification Section shall be the same, and shall be interchangeable.
- C. Do not use materials and equipment removed from existing structures, except as specifically required, or allowed, by the Contract Documents.
- D. Perform work by persons qualified to produce workmanship of specified quality.
- E. Secure products in place with positive anchorage devices designed and sized to withstand stresses, vibration, and racking.
- F. When work is specified to comply with manufacturers' instructions, submit copies as specified in Section 01300 - Submittals, distribute copies to persons involved, and maintain one set in field office.
- G. Perform work in accordance with details of instructions and specified requirements.

PART 2 PRODUCTS

NOT USED

PART 3 EXECUTION

NOT USED

END OF SECTION

SECTION 01631

USE OF OTHER THAN FIRST NAMED MANUFACTURER

PART 1 GENERAL

1.01 DESCRIPTION

- A. This Section includes requirements related to the Contractor's responsibilities when using a named manufacturer or product other than the first named.

1.02 EQUIVALENT MATERIALS AND EQUIPMENT

- A. Whenever a material, article, or method is specified or described by using the name of a proprietary product or the name of a particular manufacturer(s) or vendor(s), followed by the phrase "or equal," the specific item mentioned shall be understood as establishing the type, function, dimension, appearance, and quality desired and is to be the basis upon which bids are to be prepared, subject to the provisions of this Section.
- B. In every instance, the design was completed using criteria required to accommodate the first named manufacturer. When practical, other named manufacturers were included in the Technical Specifications based upon performance and design criteria comparable to the first named. However, in some instances, the size, shape, loadings, configuration, and/or other design criteria for other named manufacturers may require redesign of the Work. Other named manufacturers may be used subject to the requirements of this Section.
- C. When the Contractor uses any manufacturer or product other than the first named in the specifications, which use requires modification to the Work, the Contractor shall, to the satisfaction of the Program Manager, review and revise the design of the Work, including coordination with other Technical Specification sections to ensure that all component units fit and function as a whole, to properly accommodate the use of that product.
- D. The Contractor shall bear the costs and liability for all redesigned elements of the Work necessary to properly accommodate the proposed item.

1.03 SUBMITTALS

- A. In addition to the requirements of Section 01300, the Contractor shall submit complete data and engineering documents that provide a complete analysis of the proposed item and the extent of the redesign of the Work necessary to properly incorporate the proposed item into the Work. The Contractor shall:
- B. Identify each and every element of the design of the Work that must be modified to:
 - 1. Accommodate the proposed item.
 - 2. Coordinate the proposed item with the overall design, inclusive of all related disciplines.
 - 3. Ensure the proper functioning of the entire system in which the item is to be incorporated.

- C. Include complete engineering drawings, bearing the seal of a Professional Engineer registered in the Commonwealth of Massachusetts, addressing all requirements in 1.02 above.

PART 2 PRODUCTS (NOT USED)

PART 3 EXECUTION (NOT USED)

END OF USE OF OTHER THAN FIRST NAMED MANUFACTURERS

SECTION 01665

SERVICES OF MANUFACTURER'S REPRESENTATIVES

PART 1 GENERAL

1.01 SECTION INCLUDES

- A. Requirements for services provided by manufacturer's representatives.

1.02 SERVICES OF MANUFACTURER'S REPRESENTATIVES

A. General

1. Arrange for a qualified factory trained service representative from each company manufacturing or supplying certain equipment and systems, as listed in the Table at the end of this section and as specified in Division 11 through Division 16, to perform the duties described herein.
2. Qualified factory trained service representative shall be approved by the Engineer
3. All 8-hour days specified herein and in other sections of the specifications are exclusive of travel time
4. Services of Manufacturer's Representative shall not commence until an Operation and Maintenance Manual has been submitted and approved for each piece of equipment and system.

B. Supervision of Installation

1. Provide on-site supervision and advice to the Contractor to insure that proper procedures are followed during equipment installation.

C. Equipment Checkout

1. Inspect, align, operate, test and adjust the equipment after equipment installation has been completed and equipment is presumably ready for operation, but before it is operated by others.
2. The inspection shall include, but shall not be limited to, the following points as applicable:
 - a. Soundness (without cracked or otherwise damaged parts)
 - b. Completeness in all details as specified
 - c. Correctness of setting, alignment, and relative arrangement of various parts
 - d. Adequacy and correctness of packing, sealing and lubricants.
3. Operate, test and adjust the equipment, as required, to prove that the equipment is left in proper condition for satisfactory operation under the conditions specified.
4. Upon completion of the work, submit a complete signed report of the result of the inspection, operation, adjustments and tests to the Engineer via the Contractor. The report shall include:
 - a. Detailed descriptions of the points inspected and work completed
 - b. Deficiencies noted and/or corrected
 - c. Tests and adjustments made
 - d. Quantitative results obtained if such are specified
 - e. Suggestions for precautions to be taken to ensure proper maintenance

- f. A certificate that specifically states that "... the equipment conforms to the requirements of the Contract and is ready for permanent operation and that nothing in the installation will render the manufacture's warrantee null and void".

D. Field Acceptance Test

1. Tests shall be conducted by the Contractor, with assistance from the manufacturer's representative, after the Engineer has reviewed completed and equipment checkout report
2. Manufacturer's representative shall be present during field acceptance tests

E. Pre-Startup Operator Training

1. General

- a. Provision for classroom and hands on training to plant personnel in the operation and maintenance of the equipment prior to placing the equipment in full operation.
- b. Provide the Owner's personnel and their consultants with sufficient information and skills training on the theory, design, site specific operation and maintenance practices (including items such as routine monitoring with normal and abnormal parameters, troubleshooting techniques, and preventive and corrective maintenance requirements) to insure that equipment and systems can be efficiently and effectively operated and maintained by the trainees upon completion of the training.
- c. Training shall be a combination of classroom, field observance and hands-on applications.
- d. Provide the following as specified herein:
 - 1) Lesson Plans
 - 2) Trainee Manuals
 - 3) Catalog of training materials.
- e. The Contractor shall provide a credit to the Owner for any unused instructor hours.
- f. Training classes shall be based on the approved Contractor Operation and Maintenance Manual.
- g. Conduct the training at scheduled times in accordance with the Contractor's approved comprehensive training schedule for all equipment, system and components. All training shall be coordinated and scheduled with the Owner a minimum of 7 days in advance. All training sessions will be conducted during the day shift. Currently the day shift is approximately 7:00 AM to 3:00 PM. For scheduling and training effectiveness, no one class will be longer than 4 hours.

2. Operations Sessions

- a. Overview of the equipment and its' auxiliary support/systems covering nomenclature, function and theory of operation.
- b. General safety requirements for operation of the equipment and its' auxiliary/support systems, including suggested safety equipment.
- c. Pre-start-up safety and equipment check.
- d. Equipment and auxiliary/support systems start-up procedures covering manual and automatic modes, if available.
- e. Routine operation and monitoring requirements; including specifics on normally expected ranges for items such as oil, water pressure and temperatures, discharge pressures, sensory observations, etc., procedures to change operating parameters (such as air or flow rates).
- f. Equipment/systems shut down procedures covering manual and automatic modes (if applicable).
- g. Operational troubleshooting of equipment and auxiliary/support systems.
- h. Procedures for handling non-routine operational problems such as response to alarms, power failures, emergency shutdown, auxiliary/support system failures, etc.

3. Maintenance Sessions

- a. If session is specific to a discipline; (e.g., electrical, mechanical, I&C), include only appropriate maintenance items for the discipline. If session is to include multiple disciplines, include all items for those disciplines and indicate in submittal outline which discipline the material refers to.
- b. For All Disciplines provide:
 - 1) An overview of the equipment and its' auxiliary/support systems covering nomenclature, function and theory of operation.
 - 2) General safety requirements for maintenance of the equipment and its' auxiliary/support systems appropriate to each discipline including suggested safety equipment and practices. Cover local/remote lockout procedures, safe procedures for handling alarms and built in safety devices during preventive and corrective maintenance.
 - 3) Overview of pre-start-up, routine operation monitoring, and shutdown procedures covering automatic and manual modes (if applicable).
- c. For Each Specific Discipline provide:
 - 1) Preventive maintenance procedures to be followed; include parts' lube quantities, types, frequencies, application points, time requirements to perform procedures, etc.
 Note: Information should be provided to trainees from the O&M manuals which cross references manufacturer's lube requirements.
 - 2) Specific procedures to cover adjustment requirements for alignment, wear, calibration, etc. for all preventive maintenance and corrective maintenance procedures, including time required to perform.
 - 3) Special tools, techniques or procedures required for either preventive or corrective maintenance of equipment or its' auxiliary support systems.
 - 4) Assembly/disassembly procedures required for preventive or corrective maintenance, including time required to perform.
 - 5) Maintenance troubleshooting of equipment and auxiliary/support systems.

F. Post-Startup Services

1. Provision for assistance to the Owner in the calibration, tuning and troubleshooting, plus any additional training which may be required during the one-year guarantee period.

1.03 SUBMITTALS

1. Submit instructor qualifications, training outline, and lesson plans 90 calendar days prior to pre-startup operator training. Qualifications of the factory trained service representative, as defined below.
2. Submit trainee manuals at least 30 calendar days prior to scheduled training.
3. Training Outline/ Lesson Plans:
 - a. 4 copies
 - b. Training outline/lesson plans to cover each major trainee group (i.e.: operations, electrical maintenance, instrumentation, etc). If the same session outline is to be used for more than one type of trainee group, such as one which would cover equipment identification and principals of operation, this information should be so indicated on the outline. The outline should be detailed and include length of session for each major topic and type of session; i.e., field or classroom.
 - c. The lesson plan shall be cross referenced to the trainee manuals provided and include instructor references for the use of training aids, training strategies, etc. They should contain sufficient technical material to guide the instructor in the delivery of the training material session. Lesson plans are to be provided for each separate technical discipline to be trained. Generic "informational" lesson plans may be used for

multiple trainee discipline target groups. The specific number of lesson plans for each session will be determined by the complexity, content and objectives of the subject equipment covered.

- d. The purpose of the manual is to provide specific guidance for the instructor and the trainees on what is to be taught and how, as well as to insure consistency and completeness of the sessions when they are presented to different groups of the same target trainee group.
4. Trainee Manuals
 - a. 4 final copies.
 - b. Key trainee manuals to the training outline. Copies should be available to pass out to each trainee at the session, they are to be retained by the trainee for future use. This trainee manual is not the O&M manual required in the specification, however, similar materials may be included as appropriate.
 - c. The purpose of the manual is to provide an organized package of information for the trainee, which will be used during the training sessions as well as for future reference material.
 - d. The organization of the manual should correspond to the training outline. Material in the manual should include information on the training topics, the training outline, and other relative reference material. Specifically, all manuals should be geared toward an eighth grade level of reading.
 - e. Manuals for Operations training sessions should include a description of the equipment, pre-start-up checks, start-up and shutdown procedure, specific monitoring checks including expected parameters, troubleshooting and safety procedures, etc. as described previously.
 - f. Manuals for Maintenance training sessions should include a description of the equipment, pre-start-up checks, start-up and shutdown procedure, specific monitoring checks including expected parameters, troubleshooting and safety procedures, etc. as described previously.
 5. 2 copies of a catalog of all training materials including training outline, lesson plans and trainee manuals.

1.04 QUALITY ASSURANCE

A. Qualifications

1. Factory trained service representative shall have the training and experience to provide technical and/or process related advice, and/or assistance, relating to the installation, operation, maintenance and utilization of the products that he represents. Additional qualifications may be specified elsewhere.
2. Representative is subject to acceptance by Engineer. No Substitute representatives will be allowed unless prior written approval by Engineer has been given.

PART 2 PRODUCTS

NOT USED

PART 3 EXECUTION

- A. Equipment and Components Requiring Services is listed in the Table at the end of this section.

B. Provide a credit to the Owner for unused service manhours as specified below, at the manufacturer's published field service rate plus travel costs.

SERVICES OF MANUFACTURER'S REPRESENTATIVE
Manhour Requirements Table

Specification Section	Section Number	Supervision of Installation	Equipment Checkout	Field Acceptance Tests	Pre-Startup Operator Training	Post-Startup Services
Stainless Steel Sluice Gates and Appurtenances	11282	4	4	8	4	4
Wet Well Mixing Systems	11301	8	8	4	4	8
Submersible Sewage Pumps	11305	4	4	4	4	8
Hoisting Equipment	14600	4	4	4	4	4
Heating and Ventilation Equipment	15500	8	8	16	8	16
Generator and ATS	16612	4	4	8	4	8
Variable Frequency Drives	16495	8	8	8	8	40
Security Alarm System	16720	4	4	4	4	4
Flow Meters	11381	4	4	4	4	8
Submersible Transducers	17300	4	4	4	4	8
Instrumentation & Control System	17300	N/A	16	16	16	40

EQUIPMENT CERTIFICATION

Owner: _____ Date: _____

Project : _____

Contractor: _____

Equipment Manufacturer: _____

Equipment: _____

Specification Section: _____

As an authorized representative of the Equipment Manufacturer, the undersigned certifies that the equipment listed above conforms to the requirements of the construction contract between the Contract and the Owner. The undersigned further certifies that the equipment has been installed in accordance with the Manufacturer's written instructions, that the equipment is ready for permanent operation and that nothing in the installation will render the Equipment Manufacturer's warranty null and void.

(Authorized Manufacturer's Representative)

Date: _____

(Witness)

Date: _____

Remarks: _____

EQUIPMENT TRAINING CERTIFICATION

Owner: _____ Date: _____

Project: _____

Contractor: _____

Equipment Manufacturer: _____

Equipment: _____

Specification Section: _____

As an authorized representative of the Equipment Manufacturer, I certify that I have trained the Owner's personnel in the proper operation and maintenance of the above equipment.

(Authorized Manufacturer's Representative)

Date: _____

The following personnel listed below attended the training session(s):

(Owner's Representative)

Date: _____

(Beta Group, Inc. Witness)

Date: _____

END OF SECTION

(THIS PAGE INTENTIONALLY LEFT BLANK)

SECTION 01680

EQUIPMENT AND SYSTEM CHECKOUT, CERTIFICATIONS AND TESTING

PART 1 GENERAL

1.01 SECTION INCLUDES

- A. Requirements and procedures for physical checkout certification, and testing of equipment.

1.02 DEFINITIONS

- A. Shop Testing is defined as testing that is done by the manufacturer either at the place of manufacture, the place of assembly, or at another location where the required testing apparatus is located, for the purpose of proving that the equipment meets the requirements of the pertinent technical specification(s).
- B. Equipment Checkout, Inspection and Certification is defined as the process of physically inspecting products after they have been installed in the work, and then certifying that the products have been properly and completely installed, and are ready for field and/or functional testing.
- C. Field Testing is defined as testing that is performed by the Contractor with supplier assistance on products they have been installed in the work and after the performance of physical checkout, for the purpose of proving that the tested products meet the requirements of the pertinent technical specifications. While field testing can be described as "shop testing in the field", it may be required regardless of whether or not shop testing was performed on the same piece of equipment or material.
- D. System Testing is defined as testing performed on a "system" normally comprised of two or more pieces of equipment, after the equipment has been installed in the work, and after physical checkout and field testing has been completed, for the purpose of providing that the system meets requirements as specified and as indicated.
- E. Manufacturer's Representative, sometimes referred to as the Factory-Trained Service Technician, is defined as a person or persons provided by the manufacturer, who is qualified by having the training and experience to provide technical and/or process related advice, and/or assistance, relating to the installation or utilization of the products provided by that same manufacturer, for installation and utilization in the work. Such training and experience shall include a minimum of three years participation in similar work including no less than three similar projects during this three year period. The qualifications of each representative must be submitted to the Engineer for approval at least 30 days prior to their first site visit.
- F. The Testing Checkout Coordinator is defined as the person provided by the contractor to coordinate and oversee the total spectrum of testing and inspection activities required by the contract documents. The testing and checkout coordinator shall have been in responsible charge of at least two similar projects in the last four years.

1.03 ROLES AND RESPONSIBILITIES

- A. The Contractor shall provide all outside services, materials, labor, supplies, test equipment and other items necessary to perform the testing specified herein. In addition, arrange for and provide the participation or assistance of survey crews, engineers, quality control technicians, manufacturers' representative(s), and required governmental agency representatives.

1.04 CHECKOUT PLAN

- A. The Contractor shall submit a checkout plan based upon the requirements defined herein to the Engineer. Six copies of checkout plan (preliminary) shall be submitted for review within 90 calendar days prior to the proposed date of the first test, whichever occurs first. The plan shall define:
 - 1. The logical and systematic performance of physical inspections, shop, field, and system tests.
 - 2. A list of all shop tests, and supplier certifications, including those required by the applicable technical specifications. Provisions shall also be included for retesting in the event it is required.
 - 3. Participants in the testing.
 - 4. Special test equipment.
 - 5. Sources of the test media (water, power, air) and the proposed method of delivery of the media to the equipment to be tested.
 - 6. Ultimate disposal of the test media.
- B. The plan shall be reviewed by the Engineer, modified or revised as necessary by the Contractor, then approved by the Engineer. The Contractor shall continue to update the checkout plan, working in conjunction with the Engineer prior to the start of the scheduled equipment checkout and functional testing activities.
- C. The Contractor shall designate, in the checkout plan, a testing and checkout coordinator to coordinate and manage the activities defined in the checkout plan, as approved by the Engineer.

1.05 EQUIPMENT AND SYSTEM CHECKOUT AND CERTIFICATIONS

- A. Checkout is defined as inspection by the Contractor, Engineer and Owner to verify conformance to the contract drawings and specifications. Checkout procedures will be conducted by the Contractor in the presence of the Engineer and Owner to verify the presence, appropriateness, and proper construction or installation of each being "checked out". Typical elements of the checkout include the following:
 - 1. Verify exterior areas for backfill, grading, surfacing, drainage, landscaping, roadways, fencing, and gates.
 - 2. Verify buildings for structure, masonry, architectural, mechanical systems, electrical/lighting, communications, and HVAC.
 - 3. Verify concrete structures for structural integrity, finish tolerance, durability, appearance, embedded and inserted items, painting and surface applications.
 - 4. Verify steel structures for member alignment, connection bolts torque, connection welds integrity, painting, fire proofing and surface applications.
 - 5. Verify mechanical systems and items for setting, alignment and securing, check and adjust packing and seals, lubrication, drying out, drive connection and alignment

including rotation and belt/chain tension, painting or surface applications, and tagging for project system.

6. Verify piping systems for material, size, components, direction, alignment of joints and bolts/welding, packing and seals, screens and filters and strainers, leak and pressure hydro tests, painting and color coding, hangers and anchors and expansion provision and supports, clean out of foreign matter and tagging for project system.
 7. Verify electrical and control/instrumentation systems for conduit and tray installation, wire/cable material and size, circuit continuity and identification, voltage testing, ground continuity and testing, terminal installation and identification, jar switches and circuit breakers and transformers tested, substation operation tested, and tagging for project system.
 8. Verify communication system including telephone, fire/smoke alarm, security, page/part, closed circuit TV similar to electrical above.
 9. Verify computer systems by station, function, and network interface.
- B. Each piece of equipment and system must be certified by the manufacturer's representative as specified in Section 01665 Services of Manufacturer's Representatives.
- C. Certifications shall not be completed until an Operation and Maintenance Manual has been submitted and approved.

1.06 FIELD TESTING OF EQUIPMENT

- A. When required by the technical specifications, perform field testing on installed equipment. Field testing shall be in addition to and not in lieu of, any shop testing either required or otherwise performed. Perform field testing as a part of the overall equipment and system testing process defined herein and in accordance with the approved checkout plan.
- B. Provide ninety days written notice indicating the date and time for testing one piece of equipment, or a series of equipment pieces. Submit with this notice the following for approval by the Engineer:
1. Description of the tests, specifically outlining how the test will prove conformance with the requirements in the technical specifications.
 2. Testing devices that will be used in the tests. Description shall state what portion of the tests that the devices will perform or measure, and device accuracy.
 3. Personnel used to perform the tests. Submit resumes, qualifications, and experience. As a minimum, personnel must have three years experience with the manufacturer and operation of the equipment to be tested and will have participated in five similar tests during this period of experience.
 4. Schedule of testing. Schedule shall include frequency of measurements, personnel present, and contingency plans for equipment and/or test failure.
 5. Test forms. Provide test forms for recording reporting on the field test data, prior to the test.
 6. Material and equipment required for the test. This material and equipment shall be supplied at no additional cost to the Owner.
 7. Water and Power Requirements. Water and power requirements shall be identified in the plan by the Contractor and will be supplied by the Contractor for field testing purposes. The Contractor shall provide all temporary piping and wiring required for field testing; and equipment and labor for the reuse of the test water. When testing is performed with water during freezing conditions, the Contractor shall take measures to prevent damage to the work caused by freezing of the water.

8. Operational Requirements. Include valve positions, set-ups, gate positions, including temporary arrangements that are required to run the tests so that the Owner can anticipate and plan for the testing situation.
 9. Provide seven days written notice to the Engineer prior to the actual start of any testing. This will include a statement by the Contractor that the equipment and facilities to be tested have been thoroughly inspected and cleaned of construction debris or other extraneous materials and all lubrication, materials, and preparations are completed.
- C. Field test procedures will be reviewed and returned by the Engineer within 30 days of receipt. Incorporate minor comments on the procedures, equipment, or personnel prior to testing. Major comments by the Engineer will require a resubmission of the field test procedure and proposed test date. The Contractor will be notified, in writing, by the Engineer if a formal resubmission is required with the transmittal of the review comments.
- D. Submit within one week after completion of the tests, the following to the Engineer for approval:
1. Completed test forms for each device tested.
 2. Completed certification documentation.
 3. A written summary of testing, reporting on the results and summarizing the entire procedure.
 4. A schedule for retesting, if necessary. Perform any retesting required to fulfill the intent of the technical specification test requirements at no additional cost to the Owner.

1.07 SYSTEM TESTING

- A. Specific system tests shall be performed by the general contractor in addition to the requirement for shop, field, and other tests called for in the technical specifications. System tests will be performed with fluid or gaseous substances that are generally non-septic, non-corrosive, non-toxic, and non-inflammable.
- B. Provide 30 days written notice indicating the date and time during which the specific functional test is proposed. Submit with this notice, the following to the Engineer for approval:
1. Testing devices that will be used in the tests. Description shall state what portion of the tests that the devices will perform or measure, and device accuracy.
 2. Personnel used to perform the tests. Submit resumes, qualifications, and experience. As a minimum, personnel must have three years experience with the manufacturer and operation of the equipment to be tested and will have participated in five similar tests during this period of experience.
 3. Schedule for Testing: Schedule shall include frequency of measurements, personnel present, and contingency plans for equipment and/or system test failure.
 4. Test forms. Provide test forms for recording reporting on the field test data, prior to the test.
 5. Material and equipment required for the test. This material and equipment shall be supplied at no additional cost to the Owner.
 6. Water and Power Requirements. Water and power requirements shall be identified in the plan by the Contractor and will be supplied by the Contractor for system testing purposes. The Contractor shall provide all temporary piping and wiring required for field testing; and equipment and labor for the reuse of the test water. When testing is performed with water during freezing conditions, the Contractor shall take measures to prevent damage to the work caused by freezing of the water.

7. Operational Requirements. Include valve positions, set-ups, and gate positions that are required to run the tests in the written request so that the Engineer can anticipate and plan for the testing.
 8. Provide seven days written notice to the Engineer prior to the actual start of any testing. This will include a statement by the Contractor that the equipment and facilities to be tested have been thoroughly inspected and cleaned of construction debris or other extraneous materials and all lubrication, materials, and preparations are completed.
- C. The Engineer, and the Owner may witness the performance of these tests, at their option.
- D. A review of the system test package by the Engineer will be made within two weeks of receiving the package. The Contractor shall incorporate minor comments on the procedures, equipment, and personnel prior to testing. Major comments by the Engineer will require a resubmission of the system test package and test date.
- E. Submit within one week after completion of the tests, the following to the Engineer for approval.
1. Completed test forms, for each device.
 2. Completed certification.
 3. A written summary of testing, reporting on the results and summarizing the entire procedure.
 4. A schedule for retesting, if necessary, including changes to procedures, testing devices, or personnel. Any retesting required to fulfill the intent of the test requirements due to negligence, poor workmanship, or products that fail to meet the contract requirements, shall be at no additional cost to the Owner.

1.08 CORRECTIONS TO THE WORK

- A. Correct any items of work failing to meet the specified requirements, at no additional cost to the Owner. Correct the nonconforming items by re-work, modification, or replacement, to the option of the Engineer. This includes the provision of all required labor, materials, and requirements for retesting as specified herein, to verify that the items conform with contract documents.

1.09 SAFETY

- A. Conduct all specified test procedures in compliance with all applicable safety standards and regulations.

PART 2 PRODUCTS

NOT USED

PART 3 EXECUTION

NOT USED

END OF SECTION

(THIS PAGE INTENTIONALLY LEFT BLANK)

SECTION 01700

CONTRACT CLOSE-OUT

PART 1 GENERAL

1.01 SECTION INCLUDES

- A. Requirements for specific administrative procedures, record keeping, close-out submittals, and forms used at substantial and final completion of the Work.
- B. Contractor shall satisfy all administrative requirements within the Contract Documents and the Requirements listed in this section prior to Contract Close-out.

1.02 FINAL CLEANING

- A. On or before the completion of the work, the Contractor shall, unless otherwise especially directed or permitted in writing, tear down and remove all temporary buildings and structures built by him; shall remove all temporary works, tools, and machinery or other construction equipment furnished by him; shall remove all rubbish from any grounds which he has occupied; and shall leave the roads and all parts of the premises and adjacent property affected by his operations in a neat and satisfactory condition.
- B. The Contractor shall restore or replace, when and as directed, any public or private property damage by his work, equipment, or employees, to a condition at least equal to that existing immediately prior to the beginning of operations. To this end, the Contractor shall do as required, all necessary highway or driveway, walk and landscaping work. Suitable materials, equipment, and methods shall be used for such restoration. The restoration of existing property or structures shall be done as promptly as practicable as work progresses and shall not be left until the end of the contract period.
- C. Unless otherwise specified under the various Sections of the Specifications, the Contractor shall perform final cleaning operations as herein specified prior to final inspection.
- D. At completion of work, remove waste materials, rubbish tools, equipment, machinery and surplus materials, and clean all sight-exposed surfaces; leave project clean and ready for occupancy.
- E. Cleaning shall include all surfaces, interior and exterior in which the Contractor and all Subcontractors have had access whether existing or new.
- F. Refer to Sections of the Specifications for cleaning of specific products or work.
- G. Use only those materials which will not create hazards to health or property and which will not damage surfaces.
- H. Use only those cleaning materials and methods that are recommended by the manufacturer of surfaces material to be cleaned.
- I. Employ experienced workmen, or professional cleaners, for final cleaning operations.

1.03 PROJECT RECORD DOCUMENTS

- A. Project Record Documents also referred here as Record Drawings shall consist of all the contract drawings.
- B. The Contractor and all Subcontractors shall be required to maintain one set of Record Drawings, as the work relates to their Sections of the Specifications, at the site.
- C. Record Drawings shall be stored and maintained in the General Contractor's field office apart from other documents used for construction. The Record Drawings shall be maintained in a clean, dry, and legible condition and shall not be used for construction purposes.
- D. Record Drawings shall be available at all time for inspection by the Engineer. All deficiencies noted shall be promptly corrected.
- E. The following information shall be indicated on the Record Drawings for building construction:
 - 1. Record all changes, including change orders, in the location, size, number, and type both horizontally and vertically of all elements of the projects which deviate from those indicated on all the contract drawings.
 - 2. The tolerance for the actual location of utilities and appurtenances within the building to be marked on the Record Drawings shall be plus or minus two (2) inches.
 - 3. The location of all underground utilities and appurtenances referenced to permanent surface improvements, both horizontally and vertically at ten (10) ft. intervals and at all changes of direction.
 - 4. The location of all internal utilities and appurtenances, concealed by finish materials, including but not limited to valves, coils, dampers, vents, clean outs, strainers, pipes, junction boxes, turning vanes, variable and constant volume boxes, ducts, traps and maintenance devices. The location of these internal utilities, appurtenances and devices shall be shown by offsets to the column grid lines on the drawings.
 - 5. Each of the utilities and appurtenances shall be referenced by showing a tag number, area served and function on the Record Drawings.
 - 6. Prior to the installation of all finish materials, a review of the Record Drawings shall be made to confirm that all changes have been recorded. All costs to investigate such conditions shall be borne by the applicable party as demonstrated by the Engineer.
- F. The following information shall be indicated on the Record Drawings for sewer construction:
 - 1. Location of manholes with 3 swing ties.
 - 2. Linear distance of sewer from manhole to manhole, including size and type of pipe.
 - 3. Manhole rim elevation and invert elevations of all pipes within manholes, including drops.
 - 4. Recalculated pipe slopes based on record elevations.
 - 5. Location in feet from downstream manhole of wyes and chimneys and vertical height of chimneys.
 - 6. Length of service connections.
 - 7. Location of service connection terminus (at property line) with 3 swing ties and depth from existing surface grade.
 - 8. Pumping station information as detailed in 1.03, E.
- G. The following information shall be indicated on the Record Drawings for water main construction:

1. Linear distance along watermain from appurtenance (i.e. vault to tee, tee to bends, bends to valves, blow offs and service corporations, including size and type of pipe.
 2. Depths of pipe and fittings.
 3. Location of vaults, valves, hydrants, bends, blow offs and service curb boxes with 3 swing ties.
 4. Rim elevation on vaults (meter, air release etc.).
- H. The following information shall be indicated on the Record Drawings for storm drain construction:
1. Rim elevations on inlets, catch basins, manholes and other structures.
 2. Invert elevations of all pipes within inlets, catch basins, manholes, end sections, headwalls, culverts and other structures.
 3. Linear distance along drain from structure to structure, and branch connections, including size and type of pipe.
 4. Recalculated pipe slopes based on record elevations.
 5. Location of manholes, inlets, catch basins, outlets, headwalls, other structures and service line connections with 3 swing ties.
- I. At the end of each month and before payment for materials installed, the Contractor, and his Subcontractors, shall review Record Drawings for purpose of payment. If the changes in location of all installed elements are not shown on the Record Drawings and verified in the field, then the material shall not be considered as installed and payment will be withheld.
- J. At the completion of the contract, each Subcontractor shall submit to the Contractor a complete set of his respective Record Drawings indicating all changes. After checking the above drawings, the Contractor shall certify in writing on the title sheet of the drawings that they are complete and correct and shall submit the Record Drawings to the Engineer.

1.04 EQUIPMENT AND SYSTEM CHECKOUT, CERTIFICATIONS AND TESTING

- A. Comply with requirements of Section 01680 Equipment and System Checkout, Certifications and Testing.

1.05 OPERATING AND MAINTENANCE MANUALS

- A. Comply with requirements of Section 01730 Operation and Maintenance Manuals.

1.06 SPARE PARTS

- A. Comply with requirements of Section 01750 Spare Parts.

1.07 LUBRICANTS

- A. Comply with requirements of Section 01751 Lubricants.

1.08 WARRANTIES

- A. Comply with requirements of Section 01740 Warranties.

1.09 FINAL INSPECTION

A. The Contractor shall submit written certification that:

1. Project has been inspected for compliance with Contract Documents.
2. Equipment and systems have been tested in the presence of the manufacturer's representative and are operational and satisfactory.
3. Project is completed, and ready for final inspection.

PART 2 PRODUCTS

NOT USED

PART 3 EXECUTION

NOT USED

END OF SECTION

SECTION 01710

STARTUP

PART 1 GENERAL

1.01 SECTION INCLUDES

- A. Startup requirements for processes, equipment and components, and the roles and responsibilities of the Contractor and the Owner.

1.02 DEFINITIONS

- A. Startup: The initial operation of a sufficiently completed facility and/or plant by the Owner, utilizing wastewater and related substances (sludge, wastewater, scum), or other media, which the facility has been designed to process.

1.03 DESCRIPTION OF WORK

- A. The primary responsibility for startup rests with the Contractor with assistance from the Owner as specified herein.
- B. The Contractor shall not operate any of the existing facilities at any time. This shall include the starting and stopping of equipment or opening and closing of valves. Whenever the Contractor believe his work will effect or be effected by the existing facilities operation he shall so notify the Engineer in writing three (3) working days prior to the intended start of the work. This notification shall clearly detail the work to be completed, the method by which the existing facilities operation may be effected and the assistance requested of the Owner.
- C. At the discretion of the Engineer, individual startups may be required for various phases of the work. If this occurs, the phase startups will be ordered by the Engineer when the following has been completed for all equipment and systems within each Phase. The Engineer may order the startups prior to the completion of non-essential items of work.
 - 1. Compliance with Section 01665 Services of Manufacturer's Representatives, including:
 - a. Supervision of Installation
 - b. Equipment Checkout
 - c. Field Testing of Equipment
 - d. Pre-Startup Operator Training
 - 2. Compliance with requirements of Section 01680 Equipment and System Checkout, Certifications and Testing
 - 3. Compliance with requirements of Section 01730 Operation and Maintenance Manuals
 - 4. Compliance with requirements of Section 01750 Spare Parts
 - 5. Compliance with requirements of Section 01751 Lubricants
- D. The Contractor shall be responsible for maintaining all equipment until the dates of substantial completion.
- E. The Contractor shall assist the Owner during startup in any way deemed appropriate by the Engineer.

- F. There will be a date of substantial completion certified by the Engineer for each Phase of construction. These dates will not be certified until the following requirements have been satisfied by the Contractor:
1. All Contract requirements are coordinated into a fully operational system. All individual units of equipment and treatment processes are fully operative and performing at specified efficiencies. Where efficiencies are not specified, performance must meet acceptable standards for the particular unit.
 2. All field tests have been completed and satisfactory reports forwarded to the Engineer.
 3. All pre-startup training has been completed by the manufacturer's representatives.
 4. All spare parts and lubricants have been satisfactorily delivered to the Owner.

1.04 ROLES AND RESPONSIBILITIES

A. Contractor's Responsibilities

1. Startup
 - a. Develop specific startup plans and schedule.
 - b. Provide specific startup material and operating supplies until substantial completion or until acceptance of a specific system. Supplies include lubricants, chemicals, gases, specialized fluids, electric power, water (City and non-potable process water) and all other required appurtenances.
 - c. Provide the necessary craft or labor assistance, in the event of an emergency equipment failure requiring immediate attention, (emergency is defined as a failure of function which precludes the further operation of a critical segment of; or the whole of the work) with a response time of not less than four hours from the time of notification. The time of notification is defined as the time of contact between the Engineer's representative and the Contractor's representative.
 - d. Clarify submittals, testing requirements, schedules, or other items related to the startup of the equipment and facilities specified and indicated in the Contract Documents.
 - e. Correct all failures or equipment problems identified during startup when notified by the Engineer.
 - f. Attend meetings related to the review of startup plan(s).
2. Performance Testing (where specified in individual technical specifications Sections 11 through 16).
 - a. Review procedures for performance testing.
 - b. Provide manufacturer's representative to provide guidance during performance testing.
 - c. Provide manufacturer's representatives and operating supplies for retesting of systems that fail to pass the initial performance tests due to deficiencies in products or workmanship at no additional cost to the Owner.
 - d. Resolve and correct all equipment or system failures during the performance testing.
3. Provide to the Engineer a list of 24 hour, "on call" representative supervisory persons who will monitor the startup and performance testing.

B. Owner's Responsibilities

1. Assist in the startup testing activities. The Owner will endeavor to be cooperative with the Contractor when required. However, it is emphasized that the existing facilities operations and treatment take precedence and only requests that do not adversely affect the flow or treatment will be considered. Additionally, any assistance given to the Contractor must be completed when the Owner's schedule and manpower permit. There

may be instances when the Owner cannot provide assistance at the time of the Contractor's request and this shall not be the basis for a claim by the Contractor.

2. Provide staff to operate and maintain equipment, systems, and facilities requiring startup.

1.05 SUBMITTALS

- A. Specific Startup Plans and schedule for all phases of startup.
- B. List of 24-hour "on call" representative supervisory persons.

PART 2 PRODUCTS

NOT USED

PART 3 EXECUTION

NOT USED

END OF SECTION

(THIS PAGE INTENTIONALLY LEFT BLANK)

SECTION 01730

OPERATION AND MAINTENANCE MANUALS

PART 1 GENERAL

1.01 SECTION INCLUDES

- A. Requirements for compiling and submitting operation and maintenance manuals.

1.02 OPERATION AND MAINTENANCE MANUALS

A. General

1. Include all elements and components of the system including instrumentation. Provide a description of how the equipment or complete system works. Additionally, where a number of components are furnished to provide a complete system, describe the operation of components as they relate to the complete system.
2. Include all necessary instruction for the maintenance and operation of the equipment or system in accordance with the manufacturer's recommendations, and as herein specified.
3. Customize the manual so that only data pertaining to the specific equipment or system to be furnished is included. If a standard type manual is utilized, it shall be neatly annotated to highlight the data pertaining to, and deleting the data not pertaining to, the specific equipment or equipment being furnished.
4. Bind each manual for each type of equipment or system separately as specified below

B. Content of Manuals

1. Table of Contents and index. Provide title of Contract and schedule of products and systems, indexed to content of the volume.
2. Brief description of each system and components. Identify function, normal operating characteristics and limiting conditions. Include performance curves, with engineering data and tests. Include equipment Nameplate Data (Serial No., Model No., rating, voltage, etc.).
3. Names, addresses, and telephone numbers of subcontractors and suppliers, including local source of supplies and replacement parts.
4. One copy of each approved shop drawing and each Contractor's coordination and layout drawing
5. Record drawings of wiring diagrams and control schematics including external connection diagrams.
6. Test and balancing reports, calibration data, alignment records, and other information.
7. Copy of any applicable warranties, guarantees and bonds
8. Operating Procedures:
 - a. Include start-up, break-in, and routine normal operating instructions and sequence. Include regulation, control, stopping, shut-down, and emergency instructions. Include summer, winter, and any special operating instructions.
 - b. Manufacturer's printed operating instructions.
9. Maintenance Procedures:
 - a. Complete maintenance instructions (include routine, preventive and corrective maintenance).
 - b. Manufacturer's printed maintenance instructions, parts list, illustrations, and diagrams.

- c. Include maintenance schedule and types of lubricants. Cross-reference lubricants to products offered by at least three major lubricant suppliers.
 - 10. Spare Parts:
 - a. List of recommended spare parts, manufacturer's current price, and recommended quantity
 - b. Parts lists to include the specific part or identification number used by the manufacturer of the parts. Arbitrary sequential numbers or letters keyed to a sectional diagram are not satisfactory.
 - 11. Additional Requirements: As specified in individual product specification sections.
- C. Format
- 1. PDF
 - a. PDF file for each piece of equipment or system shall be provided
 - b. File shall have complete Table of Contents with each section book marked
 - c. Each section shall have a cover sheet
 - 2. Binder
 - a. Binders: Commercial quality, 8-1/2 x 11 inch three-ring binders with hardback, cleanable, plastic covers; two inch maximum ring size. When multiple binders are used, correlate data into related, consistent groupings. Provide a table of contents in each binder.
 - b. All binders to be of similar design and color, but sized to suit the individual manuals with a minimum allowable edge of width of 1 inch.
 - c. Identify each manual with a permanent label affixed to the outside binding of the binder and include the following information:
 - 1) Name of Contract, Contract Number
 - 2) Location of equipment or system (i.e. Primary Settling Tanks)
 - 3) Common name of equipment or system (i.e. Chain and Flight Sludge Collectors)
 - d. Provide tabbed fly leaf for each separate product and system, with typed description of product and major component parts of equipment.
 - 3. Material for Content
 - a. Loose leaf on 60 pound, punched paper
 - b. Holes reinforced with plastic cloth or metal
 - c. Page size, 8 1/2 by 11 inches
 - d. Diagrams, illustrations, and attached foldouts as required, of original quality, reproduced by dry copy method
 - e. Drawings: Provide with reinforced punched, binder tab. Bind in with text; fold larger drawings to size of text pages

1.03 SUBMITTALS

- A. Sample of typical binder, cover and tabbed fly leaf.
- B. Provide three (3) hard copies and one (1) electronic copy of O&M manuals for approval no later than the time that the equipment is delivered to the site. If the manual is satisfactory, the Engineer will retain all three (3) copies. If the manual is not satisfactory, the Engineer will retain one (1) copy and return two (2) copies to the Contractor. When manuals are resubmitted, three (3) copies will again be required. When the manual is satisfactory, except for some missing information, the Engineer may, at his option, retain all three (3) copies of the manual and request three (3) copies of the additional information to be provided.

- C. All manuals pertaining to equipment or a system within each specific components of construction must be completely approved prior to the Field Acceptance Tests of that component.

PART 2 PRODUCTS

NOT USED

PART 3 EXECUTION

NOT USED

END OF SECTION

(THIS PAGE INTENTIONALLY LEFT BLANK)

SECTION 01740

WARRANTIES

PART 1 GENERAL

1.01 SECTION INCLUDES

- A. General administrative and procedural requirements for warranties required by the Contract Documents, including manufacturers standard warranties on products and special warranties.

1.02 SUBMITTAL

- A. Submit written warranties to the Owner prior to the date fixed by the Engineer for Substantial Completion. If the Certificate of Substantial Completion designates a commencement date for warranties other than a date of Substantial Completion for the Work, or a designed portion of the Work, submit written warranties upon request of the Owner.
- B. When a designated portion of the Work is completed and occupied or used by the Owner, by separate agreement with the Contractor during the construction period, submit properly executed warranties to the Owner prior to acceptance of this portion of the Work.
- C. Refer to individual Sections of Division 2 through 16 for specific content requirements, and particular requirements for submittal of special warranties.

1.03 WARRANTY REQUIREMENT

- A. Related Damages and Losses: When correcting warranted Work that has failed, remove and replace other Work that has been damaged as a result of such failure or that must be removed and replaced to provide access for correction of warranted Work.
- B. Reinstatement of Warranty: When Work covered by a warranty has failed and been corrected by replacement or rebuilding, reinstate the warranty by written endorsement. The reinstated warranty shall be equal to the original warranty with an equitable adjustment for depreciation.
- C. Replacement Cost: Upon determination that Work covered by a warranty has failed, replace or rebuild the Work to an acceptable condition complying with requirements of Contract Documents. The Contractor is responsible for the cost of replacing or rebuilding defective Work regardless of whether the Owner has benefited from use of the Work through a portion of its anticipated useful service life.
- D. Owner's Recourse: Written warranties made to the Owner are in addition to implied warranties, and shall not limit the duties, obligations, rights and remedies otherwise available under the law, nor shall warranty periods be interpreted as limitations on time in which the Owner can enforce such other duties, obligations, rights, or remedies.
- E. Rejection of Warranties: The Owner reserves the right to reject warranties and to limit selections to products with warranties not in conflict with requirements of the contract Documents.

- F. Disclaimers and Limitations: Manufacturer's disclaimers and limitations on product warranties do not relieve the Contractor of the warranty on the Work that incorporates the products, nor does it relieve suppliers, manufacturers, and subcontractors required to countersign special warranties with the Contractor.

1.04 DEFINITIONS

- A. Standard Product Warranties are preprinted written warranties published by individual manufacturers for particular products and are specifically endorsed by the manufacturer to the Owner.
- B. Special Warranties are written warranties required by or incorporated in the Contract Documents, either to extend time limits provided by standard warranties or to provide greater rights for the Owner.

PART 2 PRODUCTS

NOT USED

PART 3 EXECUTION

NOT USED

END OF SECTION

SECTION 01750

SPARE PARTS

PART 1 GENERAL

1.01 DESCRIPTION

- A. Spare parts which are identical and interchangeable with original parts shall be provided with equipment as specified in each Section of the Specifications. Spare parts shall be individually packaged in boxes bearing the equipment reference, tag number, and part identification (Example: Sewage Pump No. 1).
- B. Subsequent to the approval of the appropriate operation and maintenance manuals but prior to the delivery of the spare parts, the Contractor shall prepare and submit an itemized tabulation of all spare parts to be provided. The tabulation shall include the name of the equipment for which the spare part is intended, type of spare part, manufacturer of spare part, manufacturer model or manufacturer identification number of spare part, quantity of spare part, and page in the appropriate operation and maintenance manual detailing the parts list.
- C. Spare parts shall be stored by the Contractor in a location approved by the Engineer. Unless otherwise directed by the Engineer, the Contractor shall deliver the spare parts to the Owner at the time of "Substantial Completion." Spare parts shall be stored in accordance with the manufacturer's written recommendations, and shall be protected against theft, vandalism, weather, and all other adverse conditions. Spare parts delivered to the Owner shall be in new, undamaged condition. Upon delivery to the Owner, spare parts shall be logged in against the above noted tabulation and inspected by the Contractor in the presence of the Engineer. Any missing or damaged spare parts shall be replaced by the Contractor at no expense to the Owner.

1.02 SPECIAL TOOLS

- A. Provide special tools required for operation, service, or maintenance of the products as specified or as needed, as determined by the manufacturer's representative.
- B. Pack items to protect them during storage. Tag items and containers to clearly identify them.

1.03 CONTRACT SPECIFIC REQUIREMENTS

- A. Specific requirements for spare parts for this contract are included in the technical specifications.

PART 2 PRODUCTS

NOT USED

PART 3 EXECUTION

NOT USED

END OF SECTION

SECTION 01751

LUBRICANTS

PART 1 GENERAL

1.01 REQUIREMENTS

- A. The Contractor shall furnish and deliver to the Owner such oil, grease and any special lubricants that are necessary for proper operation of all equipment furnished under this contract. The quantity furnished shall be sufficient for one year's operation after the date of substantial completion. The grade of lubricants furnished shall be in accordance with the recommendations of the equipment manufacturers.
- B. Subsequent to the approval of the appropriate operation and maintenance manuals but prior to the delivery of the lubricants, the contractor shall prepare and submit an itemized tabulation of all lubricants to be provided. The tabulation shall include the name of the equipment for which the lubricant is intended, its tag number, type of lubricant, manufacturer of lubricant, frequency of lubrication, quantity of lubricant required for one year, and page in the appropriate operation and maintenance manual referencing the lubricant.
- C. All lubricants shall be delivered to the Owner prior to the start-up of the equipment. They shall be delivered in the manufacturer's unopened containers and shall be labeled with the equipment name for which it is to be used. At the time of delivery they shall be logged in against the above noted tabulation and inspected by the Contractor in the presence of the Engineer.
- D. The Contractor shall also furnish and deliver to the Engineer such grease guns and auxiliary lubricating devices as are required to conveniently maintain all equipment furnished. As a minimum, one grease gun and accessories will be furnished for each individual item of equipment requiring lubrication.
- E. Prior to substantial completion, the Contractor shall submit an "Equivalent Lubrication Table" which shall list equivalent products from at least four major oil companies for all lubricants that will be required for all the equipment provided under this Contract.

PART 2 PRODUCTS

NOT USED

PART 3 EXECUTION

NOT USED

END OF SECTION

(THIS PAGE INTENTIONALLY LEFT BLANK)

SECTION 01800

MAINTENANCE

PART 1 GENERAL

1.01 SECTION INCLUDES

- A. Procedures for maintaining work completed under this Contract.

1.02 MAINTENANCE PERIOD

- A. The general maintenance period for all construction or materials under this Contract shall be one (1) year subsequent to the date of the acceptance of the work by the Owner, or as provided by other sections of this Specification.
- B. If the Owner puts any structure or equipment to use prior to acceptance of all work under the Contract, the maintenance period for such structures or equipment shall be calculated from the time use begins.
- C. Contractor agrees to replace the material which does not conform to the Contract requirements, and to repair any damage of material or work without cost to the Owner, to satisfaction of Engineer, in conformance with Contract Documents provided orders for replacement and/or repairs are received in writing by the Contractor within the one year period.
- D. This Section shall in no way limit the duration of the Contractor's responsibility for the correction of any defect due to workmanship or materials provided by the Contractor which are not in compliance with the Contract Documents.

1.03 ABUSE OF WORK

- A. Contractor is not obligated to perform work of replacement or repair that he may prove is required because of abuse by parties other than the Contractor, after the date the Owner puts to continuous use the work requiring replacements or repair, or after date the Owner has approved the Certificate of Completion.

1.04 EMERGENCY REPAIRS

- A. If the Owner deems necessary, the Owner shall order replacement or repairs be undertaken within 24 hours.
- B. If the Contractor delays or fails to make the ordered replacement or repairs within the time specified, the Owner shall have the right to make such replacements or repairs and the expense shall be deducted from moneys due the Contractor, or moneys of the Contractor retained by the Owner.

PART 2 PRODUCTS

NOT USED

PART 3 EXECUTION

NOT USED

END OF SECTION

SECTION 01810

MAINTENANCE OF PLANT OPERATION AND SEQUENCE OF CONSTRUCTION

PART 1 GENERAL

1.01 GENERAL PROVISIONS

- A. The existing wastewater pumping station facility will be maintained in continuous operation by Veolia at all times during the entire construction period. The Contractor shall schedule his operations to conform with the requirements specified herein, and shall include in his construction progress schedule all events which will impact operation of the existing pumping station.
- B. The Contractor shall at all times conduct his operations so as to interfere as little as possible with existing works. The Contractor shall develop a program, in cooperation with the Engineer and interested officials, which shall provide for the construction and putting into service of the new works in the most orderly manner possible. This program shall be adhered to except as deviations there from are expressly permitted. All work of connecting with, cutting into, and reconstructing existing pipes or structures shall be planned to interfere with the operation of the existing facilities for the shortest possible time and when the demands on the facilities best permit such interference, even though it may be necessary to work outside of normal working hours to meet these requirements. Before starting work which will interfere with the operation of existing facilities, the Contractor shall perform all preparatory work and shall see that all labor, tools, materials, and equipment are made ready and at hand.
- C. The Contractor shall make minor modifications in the work relating to existing structures as may be necessary to satisfactorily complete the work, without additional compensation.
- D. The Contractor shall plan and conduct his work so that such work does not adversely impact the intended plant operation. The Contractor's operations shall in no way cause a reduction in the effluent quality or create any nuisance not normally attributable to such operation, unless approved by the Owner, Engineer and State regulatory agencies. It shall be the Contractor's responsibility to ensure complete compatibility with the plant operations in his working schedules.
- E. All costs associated with maintaining existing flows and plant operations, including providing, maintaining, operating, and removal of all equipment and required appurtenances, shall be considered part of the work being constructed. It being understood and agreed to by the Contractor that the cost to complete the work shall constitute full and complete compensation to the Contractor for providing all provisions necessary and/or required for maintaining flow during construction.
- F. The Taunton Main Lift Pumping Station is designed to manage a peak flow of approximately 21 MGD. The station may occasionally experience instantaneous peak flows greater than that during wet weather conditions and if sustained will result in a Combined Sewer Overflow (CSO) at a designated CSO location on West Water Street, upstream of the Station. Unless specifically noted below, construction activities under this Contract shall not, under any circumstances, reduce pumping capacity of the existing

pumping station; interrupt the conveyance of wastewater to the pumping station or to the Wastewater Treatment Facility; be the cause of a combined sewer overflow.

- G. Any approved construction activity which will affect the operation of the influent sewers, or pumping capability of the facility, shall be done, unless otherwise approved by the Engineer, during low influent flow periods. Low influent flow periods are defined as early weekday and weekend mornings (between MIDNIGHT and 7 A.M.), during dry weather periods only. The Contractor may request to work on the existing facilities at such times and shall only proceed with full approval from the City, the Engineer and Plant Operations personnel.

1.02 RELATED WORK

- A. Section 00700 - General Conditions
- B. Section 00800 - Supplementary Conditions
- C. Section 01010 - Summary of Work
- D. Section 01300 - Submittals
- E. Section 01310 - Construction Progress Schedule
- F. Section 01510 - Temporary Utilities
- G. Section 01665 – Services of Manufacturer’s Representatives
- H. Section 01680 – Equipment Checkout, Certifications and Testing
- I. Section 01710 – Start-up
- J. Section 02050 - Demolition

1.03 SUBMITTALS

- A. Submit, in accordance with the provisions of Section 01300, complete descriptions of procedures to maintain facility operation to supplement the construction progress schedule developed in accordance with Section 01310. The description shall include step-by-step procedures, required duration, and specific procedures required to be performed by the Owner's personnel.

1.04 CONTRACTOR'S AND OWNER'S RESPONSIBILITIES AND LIMITATIONS

- A. The Contractor's construction activities shall not disrupt operation of the existing pumping station, nor the influent sewers, no matter how minor, without the approval of Plant operations personnel, the Engineer and Owner.
- B. The Contractor shall not operate or utilize any existing plant facilities. This includes the starting and stopping of equipment, the opening and closing of valves or the use of existing piping. Whenever the construction work requires action by the Owner, the Contractor shall so notify the Engineer as described below.
- C. The Contractor shall notify the Engineer in writing of any construction activity that will affect facility operations or require assistance from the Owner in operating any existing facilities. This notification shall be received at least one week prior to the planned construction work. The request shall clearly detail the Contractor's planned work, how his work will affect the operation of the existing facilities, the estimated duration of the work, and any assistance required of the Owner. The Contractor's request shall also explain why other construction methods, which may have less of an impact on treatment operations, are not feasible.

- D. It is emphasized that the operations of the existing facilities take precedence over all construction activities. Denials of requests from the Contractor for the Owner's assistance in modifying his plant operations shall not be a basis for any claim by the Contractor. Any approved assistance given to the Contractor from the Owner will be provided when the Owner's schedule and manpower permit. The Contractor shall also provide access for the Owner's personnel to all existing facilities at all times throughout the construction period.

1.05 SEQUENCE OF CONSTRUCTION

- A. The detailed schedule for construction shall be based upon the schedule submitted by the Contractor and approved by the Engineer as specified above. However, as a guide for the Contractor in the preparation of his schedule, scheduling requirements are described below for specific portions of the work.
- B. The order of construction shall be subject to the approval of the Engineer; such approval or direction, however, shall in no way relieve the Contractor's responsibility to perform the work in strict accordance with the Contract Documents. The construction plans and specifications have been developed to minimize the construction impacts on the operation of the Pumping Station, influent sewers and discharge force mains. The Contractor shall note the requirements of Section 01010 with regard to the operation of the pumping station and the phasing of construction when developing his work sequence. The Contractor's work sequence must be specifically detailed in the CPM which is required under Section 01310.
- C. Whenever the Contractor's proposed work will require the Owner to deviate from the normal operation of the plant, the Contractor shall so notify the Engineer in writing. Such notification shall be submitted one week prior to the planned construction activity and shall include all information as described in Section 01010.
- D. Contractor should note that other construction activities being performed under separate contracts will be underway at the time this contract is awarded. Contractor shall coordinate activities, as required, to minimize conflicts with other construction activities being performed on the property.
- E. Suggested sequences of construction for various work items are presented below. Note that these are only general suggested sequences of construction. The Contractor may wish, or may find it necessary, to alter the sequence of construction. All necessary details and items of work are not purported to be included.
- F. Following equipment checkout, certification and testing of instrumentation and control system, electrical equipment and mechanical equipment, the new station shall be operated in fully automatic mode for a minimum of three consecutive days, during the work week and within normal business hours, without interruption and without faulty alarm conditions, prior to acceptance. Wastewater shall be redirected to old station and returned to operation of the old system at the end of each day during this test period. Once approved by the Owner, the new station may be put on-line full time and rehabilitation work within the existing station may begin.

Main lift pump station:

Existing pumping station will remain on-line throughout construction and start-up of new station.

1. Establish sediment and erosion controls

2. Construct influent sewer connection/yard piping/generator foundation
3. Construct pumping station
 - Mechanical equipment and piping
 - Architectural
 - Electrical work and generator installation
 - Heating & ventilation
 - Instrumentation & controls
4. Start-up & test new station (See Note F.)
 - introduce flow to new station (via gate operation at existing manhole)
 - Old station will continue to operate to manage flow from siphon
5. Following testing of new station, and upon approval, remove plugs and introduce flow from the siphon to the new station
6. Clean/rehabilitate old station
 - Drain force main back into wet well and draw-down wet well with submersible pumps and pump to new station
 - Clean existing wet well
 - remove grease
 - Mechanically mix to stir rags and grease
 - Power wash wet well walls and floor and remove and dispose of residual sludge, scum, grease and debris from wet well
 - Remove and dispose existing landing
 - Complete improvements to old station
6. Complete site Improvements

END OF SECTION

DIVISION 02

(THIS PAGE INTENTIONALLY LEFT BLANK)

SECTION 02050

DEMOLITION

PART 1 GENERAL

1.01 SECTION INCLUDES

- A. Requirements for demolition of existing facilities and removal of equipment and materials for reuse or salvage.
- B. Buildings or areas scheduled for partial or selective demolition are shown on the Contract Drawings, as follows:

<u>Building Description</u>	<u>Description of Demolition</u>
1. Existing Main Lift Pumping Station	Influent Wet well Gate operator Existing Roof Miscellaneous Electrical Building Doors Building Windows Site Fencing Site Paving

1.02 SUBMITTALS

- A. Shop Drawings
 - 1. In accordance with Specification SECTION 01300 1.03 Shop Drawings.
 - 2. Schedule of demolition included in and consistent with requirements of Specification SECTION 01300 1.02 Progress Schedules and SECTION 01310 Construction Progress Schedule.
- B. Quality Assurance/Control Submittals
 - 1. Methods of demolition and equipment proposed for use in demolition
 - 2. Copies of Permits required for demolition.

PART 2 PRODUCTS

NOT USED

PART 3 EXECUTION

3.01 PREPARATION

A. Equipment Salvage and Reuse

1. Do not remove equipment or materials without approval of Engineer.
2. Properly store and maintain equipment and materials to be reused in the Work.

3.02 SEQUENCE

- #### A. See SECTION 01810 Maintenance of Plant Operation and Sequence of Construction.

3.03 SAFETY

- #### A. Protect persons and property throughout progress of work.
- #### B. Have acceptable fire extinguishers available at all times where demolition by burning torches is being conducted.
- #### C. Burning of demolition debris not permitted on or near site.
- #### D. Explosives not to be used or brought to site without prior written permission by Engineer.
- #### E. Maintain circulation of traffic within area of demolition operations.
- #### F. Provide and maintain lights, barriers and temporary passageways for safe access within area of demolition operation.
- #### G. Take precautions to minimize spread of dust and flying particles. Keep work area wet down to prevent dust from rising.
- #### H. Provide maximum practical protection from inclement weather to materials, equipment and personnel in partially dismantled structures.

3.04 DEMOLITION

- #### A. Dismantle and remove appurtenances indicated without damaging existing structures, equipment and appurtenances to remain.
- #### B. Confine demolition work, new construction and operations to areas that will not interfere with continued use and operation of entire plant.
- #### C. On exposed surfaces, where there will be in the finish work a joint between old and new concrete, the existing concrete at the face shall be removed to a straight rather than a rough line.

3.05 REPAIR/RESTORATION

- A. Repair or remove and replace items not scheduled for demolition damaged by Contractors operations to original condition as directed by Engineer.
- B. The Contractor shall exercise extreme caution when removing sections of concrete from slabs or walls that are to be utilized as part of the new construction. Demolition shall be to the exact limits indicated on the Drawings. Over-excavated concrete shall be replaced at the Contractor's expense and to the satisfaction of the Engineer. Any damage to the remaining structure caused by the Contractor's operations shall be satisfactorily repaired at the Contractor's expense.

3.06 DISPOSAL

- A. Debris from structures, including concrete, masonry, steel or other rubble shall become the property of the Contractor, unless otherwise directed by the Engineer, and shall be promptly removed from site at the Contractor's expense.

3.07 CLEANING

- A. Leave affected areas of demolition in a clean, safe and orderly condition, ready to accept new work if proposed.

END OF SECTION

(THIS PAGE INTENTIONALLY LEFT BLANK)

SECTION 02080

MANAGEMENT OF CONTAMINATED MATERIALS

PART 1 GENERAL

1.01 SUMMARY

A. Section Includes

1. Requirements for disposal of surplus materials generated from the construction of the main lift pumping station improvements.
2. Three categories of soil disposal have been identified for disposal of Excess Soil:
 - Re-Use Facility: defined as soil or materials containing concentrations of contaminants less than the acceptance criteria at a soil Re-Use facility based on the Contractor's laboratory analytical results.
 - In-State Landfill: defined as soil or materials containing concentrations of contaminants greater than the acceptance criteria at a soil Re-Use facility and less than the Massachusetts Department of Environmental Protection's COMM-97 acceptance criteria based on the Contractor's laboratory analytical results.
 - Out-of-State Landfill: defined as soil or materials containing concentrations of contaminants greater than the COMM-97 acceptance criteria based on the Contractor's laboratory analytical results.
3. Requirements for identifying, handling, stockpiling, and disposal of excess soil and groundwater.

B. Related Sections

1. Section 01025 – Measurement and Payment
2. Section 01300 – Submittals
3. Section 02140 – Dewatering
4. Section 02200 – Earth Excavation, Backfill, Fill and Grading

1.02 WORK INCLUDED

A. In general, work under this Section shall include all labor, materials, equipment, supervision and supplies necessary for the loading, handling, transportation, and off-site disposal of Excess soil and all labor, materials, equipment, supervision and supplies necessary for the loading, handling, and transportation soil as directed by the ENGINEER.

B. Excess Soil generated from excavation activities, shall be managed as follows:

1. Securing permits and licenses, as necessary, including notification of local emergency personnel and notification/reporting requirements, with respect to unforeseen conditions;

2. Mobilization and demobilization of personnel, equipment, materials and supplies required to perform the Work;
3. Excavation, loading and hauling Excess Soil to stockpile area on the pump station site, and Management of Stockpile on site. Identifying and coordination with Licensed Disposal/Reuse Facility; loading and hauling stockpiled material for disposal at a disposal/Reuse facility approved by the Engineer; and all fees associated with Excess Soil disposal. Segregating boulders and other large rocks for off-site management, as directed by the ENGINEER;
4. To the extent practical, removing and segregating asphalt from the soil; and
5. General site cleanup.

1.03 SAMPLING

- A. The CONTRACTOR will be responsible for **all costs** associated with sampling and analyses as may be required by the receiving disposal facility(ies) for off-site disposal of soil. **Due to the age of the existing laboratory data all Excess Soil must be sampled by the CONTRACTOR for management and offsite disposal.** Any such sampling services shall be completed by Contractor after stockpiling and as quickly as possible. Contractor shall schedule his/her activities to allow for sampling to be performed, analytical results to be compiled and management decisions to be made.
- B. The CONTRACTOR will provide ENGINEER with 48 hours notice of sampling activities. ENGINEER will be present during all sampling activities.
- C. Samples collected and/or tested by the CONTRACTOR without coordinating with the ENGINEER shall be for his own convenience only, and shall not be the basis for classification, determination of limits, or payment.

1.04 LICENSED SITE PROFESSIONAL (LSP) SERVICES

- A. Licensed Site Professional (LSP) services to be provided by the ENGINEER, include Massachusetts Department of Environmental Protection (MassDEP) response actions, preparing Massachusetts Contingency Plan (MCP) related filings including but not limited to Utility-related Abatement Measure (URAM) Plans, Release Abatement Measure (RAM) plans, Material Shipping Records, and Bills of Lading.
- B. The CONTRACTOR shall retain the services of an LSP for preparation of the soil management plan, preparation of soil disposal applications, sampling of stockpiled soil for soil management, and providing sampling data summaries. ENGINEER's LSP will be provided draft documents for review prior to submittal.

1.05 APPLICABLE LAWS AND REGULATIONS

- A. The CONTRACTOR is advised that Work under this Section may need to be performed under the requirements of 310 CMR 40.0000 et seq., also known as the Massachusetts Contingency Plan (MCP).

- B. Work under this Section shall be performed in strict compliance with applicable Federal, State and local laws, rules, regulations related to the handling and off-site management of contaminated wastes and regulated soil.
- C. Pertinent Federal and State Authorities having jurisdiction over this project include:
 - 1. Occupational Safety and Health Administration (OSHA)
 - 2. U.S. Environmental Protection Agency (EPA)
 - 3. Massachusetts Department of Environmental Protection (MassDEP)
- D. The following OSHA regulations will apply:
 - 1. Occupational Safety and Health Standards, Hazardous Waste Operations and Emergency Response - 29 CFR 1910.120.
 - 2. Safety and Health Regulations for Construction - 29 CFR 1926.

1.06 SUBMITTALS

- A. Submittals shall be made in compliance with the requirements of Section 01300 except as provided for herein.
- B. No Work will be permitted to proceed until the required submittals have been received and approved by the ENGINEER. In the event the ENGINEER requests additional information, it shall be the CONTRACTOR's responsibility to provide such additional information in a complete and timely manner, so that construction can proceed by the date stipulated in the Notice to Proceed.
- C. Contaminated soil will be encountered during the work. Prior to the commencement of work, the CONTRACTOR shall submit the following to the ENGINEER for approval:
 - 1. Submittal of required certifications demonstrating that personnel are properly trained and qualified to perform the Work in accordance with applicable OSHA regulations and laws governing the Work.
 - 2. Names and qualifications of proposed subcontractors, if any, identifying the tasks to be performed by each proposed Subcontractor.
 - 3. A Proposed Soil Management Plan, including a description of the proposed equipment and decontamination procedures; identification of staging areas for the loading of the Excess and Contaminated soil; stockpiling setup and procedures; loading and transportation procedures for off-site disposal; and project schedule. The plan should also identify disposal facilities for the Excess Soil.
 - 4. The CONTRACTOR's Site-Specific Health & Safety Plan pursuant to OSHA 1910.120 requirements.
- D. Approval of submittals by the ENGINEER shall not impose any liability upon the ENGINEER, nor shall any such approval relieve the CONTRACTOR of his/her

responsibilities to meet the requirements and comply with applicable laws, regulations and other applicable requirements under this Contract.

1.07 EXISTING ENVIRONMENTAL CONDITIONS

- A. Logs of borings completed, and test results on the soil from these borings, are attached to the Specifications as Appendix 3. Supplemental environmental conditions are also provided in Appendix 5. Visual and olfactory indicators may be used to identify distinct areas of Excess Soil for further segregation on the pump station site.
- B. The CONTRACTOR shall satisfy himself/herself as to the conditions existing at the Site, the type of equipment required to perform this Work, and the quality and quantity of the materials to be removed.
- C. Failure of the CONTRACTOR to become fully acquainted with the available information will not relieve him/her of the responsibility to completely and properly perform the work in full compliance with the Contract Documents. The ENGINEER assumes no responsibility for any conclusion or interpretation made by the CONTRACTOR on the basis of information made available by the Owner or ENGINEER.

PART 2 PRODUCTS [NOT USED]

PART 3 EXECUTION

3.01 GENERAL

- A. The CONTRACTOR will provide adequate barriers and demarcation of excavations and exclusion zones to warn site visitors and the public of potential hazards.
- B. The CONTRACTOR will take appropriate means to prevent a release or the spread of hazardous wastes or contaminated materials as a result of the CONTRACTOR's operations.
- C. The CONTRACTOR will notify the ENGINEER 48 hours prior to the collection of soil and/or groundwater samples for laboratory analyses. The ENGINEER or his representative shall be present during all sampling.

3.02 SITE HEALTH & SAFETY

- A. The CONTRACTOR is solely responsible for controlling Site health and safety, including the provision of a Site Health and Safety Officer. In the performance of its Work, the CONTRACTOR shall provide for the safety of CONTRACTOR personnel, other CONTRACTOR's personnel, regulatory agency personnel, and the public for the duration of the Contract.
- B. The CONTRACTOR is solely responsible for his/her construction means and methods.

- C. The ENGINEER will be responsible for the health and safety of its personnel only.
- D. The CONTRACTOR shall provide a Health and Safety Plan (HASP) which addresses identified contaminants of concern for the Work under this Contract. Such plan shall conform to the requirements of OSHA 1910.120 and other applicable federal, state, and local laws, regulations, ordinances, and procedures. The HASP shall be developed and implemented by the CONTRACTOR's Safety Officer experienced with the health and safety requirements of OSHA 1910.120. The HASP shall be revised, as needed, whenever new information about site hazards is obtained.
- E. Personnel performing Work in contaminated or hazardous areas shall be fully trained in accordance with the OSHA 1910.120 and the HASP and shall be thoroughly briefed on anticipated hazards, safety equipment to be employed, safety practices to be followed, and emergency procedures and communications. The CONTRACTOR shall have a medical monitoring surveillance program in place for personnel in accordance with applicable laws and regulations.

3.03 MISCELLANEOUS PROVISIONS

- A. CONTRACTOR must have a valid EPA identification number and any other permits or licenses required by federal, state, and local laws, regulations, ordinances, and procedures for the transportation of hazardous wastes.
- B. The CONTRACTOR shall be responsible for securing necessary and applicable permits, certificates, licenses, and approvals required for the performance of this Work and shall be responsible for the payment of associated fees.
- C. The CONTRACTOR shall comply with required reporting and record keeping requirements in accordance with the provisions of this Contract and applicable federal, state, and local laws, regulations, ordinances, and procedures.
- D. The CONTRACTOR shall be responsible for notifications required by federal, state, and local laws, regulations, ordinances, and procedures. Notifications shall be coordinated with the ENGINEER.
- E. Material Shipping Records and/or Bills of Lading, as appropriate, will be provided and coordinated by the ENGINEER. The Owner will be responsible for signing all waste manifests and bills of lading. In order for CONTRACTOR's operations to proceed without interruption, complete and accurate information shall be provided by the CONTRACTOR during the Submittals process. CONTRACTOR shall be responsible for preparing applications to disposal facilities.

3.04 DUST MONITORING & CONTROL MEASURES

- A. The CONTRACTOR is responsible for monitoring the Work for evidence of airborne particulates (dusts) emanating from the Work area. It shall be the CONTRACTOR's responsibility to continuously monitor the work area for dust levels.

- B. The CONTRACTOR shall take appropriate measures to substantially eliminate the generation of dusts within the Work Area, including use of water provided by the CONTRACTOR and covering all stockpiled wastes and/or soil, except in the immediate vicinity of the excavation, where water may be required to control dust emissions.
- C. The ENGINEER will also be monitoring the site for elevated levels of dusts. In the event that visible emissions are observed, the ENGINEER may direct the contractor to take appropriate measures to mitigate the condition. Failure of the CONTRACTOR to implement measures that reduce dust levels may be cause for suspension of the Work, until otherwise directed by the ENGINEER.

3.05 EXCAVATION OF SOIL

- A. Surplus soil generated from excavation activities associated with the Main Lift Pumping Station Improvements project shall be fall in one of the three soil categories identified . Activities involving Excess soil performed by the CONTRACTOR or SUBCONTRACTORS within the Project Limits shall be performed in a manner which considers the health and safety of CONTRACTOR and SUBCONTRACTOR personnel, support personnel, the ENGINEER and his representatives, and the surrounding environment.
- B. The CONTRACTOR shall minimize the spread and loss of Soil during excavation activities as follows:
 - 1. The CONTRACTOR shall segregate boulders, asphalt, construction debris and other deleterious materials from excavated Soil to the extent practicable and as directed by the ENGINEER. This segregation shall occur at the point of excavation, prior to the transport of soil.

3.06 TEMPORARY SOIL STOCKPILING

- A. The ENGINEER anticipates the need for temporary stockpiling of Excess Soil. Excess Soil shall be transported to and stockpiled at a suitable area on site. The following provisions shall apply to the stockpiling at the pump station site:
 - 1. As directed by the ENGINEER, the CONTRACTOR shall stockpile the Excess Soil into separate approximately 250 cubic yard stockpile areas (physically separated with “Jersey Barriers” by excavation site and labeled) to facilitate separate characterization by CONTRACTOR, and subsequent off-site management.
 - 2. Excess Soil shall be stockpiled out of the immediate work area at the pump station site, on 6-mil polyethylene sheeting. Excess Soil shall be covered with 6-mil polyethylene sheeting at the end of every working day. Sheeting shall be properly secured such that it remains fully intact during inclement weather conditions.
 - 3. Excess Soil shall be transported from pump station site as soon as possible. In no case shall excavated soil remain stockpiled for more than 120 days from its

excavation. In no event shall the total volume of stockpiled soil exceed 500 cubic yards, without the specific approval of ENGINEER.

3.07 OFF-SITE MANAGEMENT OF EXCESS SOIL

- A. The CONTRACTOR shall be responsible for the off-site transportation and disposal of Excess Soil at an approved Disposal Facility.
- B. The CONTRACTOR shall be responsible for coordination of transporter and receiving facility activities. Transporter vehicles used for the transportation of Excess Soil shall be covered, substance compatible, licensed, insured, and permitted pursuant to federal, state, and local laws, regulations, ordinances, and procedures.
- C. Vehicles departing the site shall be properly logged to show the vehicle identification, driver's name, time of departure, destination, and approximate volume and content of material carried.
- D. Excess Soil shall not leave the site or stockpile area until the designated receiving facility has agreed in writing to accept the type and quantity of waste/soil to be shipped.
- E. The CONTRACTOR shall complete required facility applications and other pertinent forms for proper transportation and disposal. The ENGINEER shall review and the City will sign the applications. Signatures from the receiving location of materials transported off-site are required. The CONTRACTOR shall be held accountable for ensuring that requirements of the transporter and receiving disposal facility(ies) and federal, state, and local laws, regulations, ordinances, and procedures are complied with and properly documented.
- F. Documentation shall be maintained indicating that applicable laws have been satisfied and that Excess Soil has been successfully transported and received at the disposal facility(ies).
- G. Actual quantities and measurements in the field shall be tabulated by the CONTRACTOR on a daily basis. The CONTRACTOR will not be reimbursed for unit rate work performed without the prior approval.

3.08 SITE CLEANUP

- A. During the course of the Work, the CONTRACTOR shall keep the Site and his operations clean and neat at all times. The CONTRACTOR shall dispose of residue resulting from the site operations; and at the conclusion for the day's Work, he shall remove and haul away surplus materials, lumber, equipment, temporary structures, and any other refuse remaining from the site operations and shall leave the site in a neat and orderly condition.

3.09 DOCUMENTATION

- A. Within 45 days after soil disposal, the CONTRACTOR shall submit to the ENGINEER one (1) original copy of all manifests, certified weigh slips (tons), bills-

of-lading, and records of final waste disposition from the accepting disposal facility(ies), and other pertinent documentation.

END OF SECTION

(THIS PAGE INTENTIONALLY LEFT BLANK)

SECTION 02100
SITE PREPARATION

PART 1 GENERAL

1.01 SECTION INCLUDES

- A. Requirements for removal of vegetation and topsoil at the site.

1.02 DEFINITIONS

- A. Clearing: Removal of trash, vegetation, or organic matter alive or dead.
- B. Grubbing: Removal of vegetation including stumps, buried logs and roots.
- C. Scalping: Removal of grass turf to a depth of 3 inches.
- D. Stripping: Removal of top soil after scalping operation is complete.

1.03 QUALITY ASSURANCE

- A. Obtain Engineer's approval of staked work limits prior to starting the clearing, grubbing, and stripping.

1.04 PROJECT/SITE CONDITIONS

- A. Environmental Requirements
 - 1. Install erosion and sediment controls prior to starting the Work.
- B. Existing Conditions
 - 1. Temporarily remove property improvements, to the minimum extent necessary, to complete the work and restore improvements to condition which existed prior to construction.

PART 2 PRODUCTS

2.01 EXISTING PRODUCTS

- A. Chips from cleared trees and brush.

PART 3 EXECUTION

3.01 PROTECTION

- A. Do not cut or injure any trees or other vegetation outside the limits of disturbance and/or permanent easement, as indicated on the drawings.
- B. Trees, shrubbery, or planting, along the traveled highways or roads, shall not be removed except with the written approval of the Engineer.
- C. Preserve certain vegetation such as trees, shrubs, hedges and plants within the construction area, as indicated on the drawings to be protected.
- D. Easement Clearing
 - 1. The Engineer shall designate trees to be removed within easement lines.
- E. Work In Improved Property
 - 1. Protect trees, cultivated hedges, lawns, shrubs, and plants that might be damaged by the Contractor's operations.
 - 2. Temporarily replant and care for trees less than 4 inches in diameter that would be damaged by the construction operation. After the construction operations have been substantially completed, replant in their original positions and care for until growth is reestablished. If trees, cultivated hedges, lawns, shrubs, and plants are injured to such a degree as to affect their growth or diminish their beauty or usefulness, they shall be replaced at the Contractor's expense by items of kind and quality existing at the start of the work.
 - 3. Do such handwork as may be required to prevent damage to buildings and improvements.
 - 4. Protect fences and stone walls and if needed to be removed to facilitate construction or if damaged, upon completion of the work, properly restore or repair to at least as good condition as existed prior to start of the work.

3.02 CLEARING

- A. Cut or remove all trees, saplings, brush, and vines, windfalls, logs, and trees lying on the ground, dead trees and stubs more than 1 foot high above the ground surface.
- B. Except where clearing is done by uprooting with machinery or where stumps are left longer to facilitate subsequent grubbing operations, trees, stumps, and the stubs to be cleared shall be cut as close to the ground surface as practicable, but no more than 6-inches above the ground surface in the case of small trees, and 12-inches in the case of larger trees. Saplings, brush, and vines shall be cut off close to the ground.
- C. Selective Trimming
 - 1. Cut back limbs and branches of trees to be preserved only to the extent necessary for construction.
 - 2. Trim neatly, and cleanly so that the remaining tree will not be damaged and healing will be facilitated. Where limbs and branches over 1 inch in diameter have been cut, the

newly cut area of the tree shall be given a thorough application of approved tree-healing paint.

D. Salvaged Wood

1. Logs, timber and other wood removed in the course of clearing found to be acceptable, as determined solely by the Engineer, shall remain the property of the applicable private property owner or the Owner, unless otherwise directed by the Engineer.
2. Cut logs, timber and other wood in 4 foot lengths and stack, as directed by the Engineer.
3. Prior to the final completion of the contract, all unclaimed logs, timber and other wood previously cut and stacked shall be removed from the site and properly disposed of by the Contractor at no additional cost to the Owner.

E. Chips from Cleared Wood and Brush

1. Stockpile for future use on cleared easements as indicated on the Drawings.
2. Spread at locations shown on the drawings once work is substantially complete.
3. If the wood chips from the cleared wood are not of sufficient amount, the Contractor at his own expense shall furnish the required amount to provide a minimum thickness as shown on the Contract Drawings.
4. Elm wood and elm bark shall not be used as chips for ground cover.

3.03 GRUBBING

- A. Remove completely all stumps.
- B. Remove to a depth of 12-inches all roots larger than 3-inches in diameter.
- C. Remove to a depth of 6-inches all roots larger than 1/2-inches in diameter.
- D. Measure depths from the existing ground surface or the proposed finished grade, whichever is the lower.

3.04 STRIPPING

- A. Strip topsoil, loam and unsuitable earth from the ground surface in areas cleared and grubbed.
- B. Utilize topsoil and loam, where possible, for finished surfacing.
- C. All loam to remain on site.
- D. Dispose of unsuitable materials off site at authorized disposal location.

3.05 DISPOSAL OF CLEARED AND GRUBBED MATERIALS

- A. Dispose of cleared and grubbed materials off site at authorized disposal location.
- B. Such disposal shall be carried on as promptly as possible after removal of material in the clearing and grubbing operations and shall not be left until the final period of cleaning up.

- C. Elm bark whether stripped from the wood or intact with the wood shall be either buried at least 1 ft. below grade in approved dumping areas or burned in a suitable incinerator off-site with satisfactory anti pollution and fire prevention controls to prevent the spread of Dutch Elm Disease.

END OF SECTION

SECTION 02140

DEWATERING

PART 1 GENERAL

1.01 SUMMARY

A. Section Includes

1. Requirements for designing, furnishing, installing, maintaining, operating and removal of temporary dewatering systems required to lower and control water levels and hydrostatic pressures during construction.
2. Requirements for disposing of pumped water.

B. Related Sections

1. Section 02160 – Excavation Support.
2. Section 02200 – Earth Excavation, Backfill, Fill, and Grading.

1.02 DEFINITIONS

- A. Dewatering: Lowering the zone of saturation and intercepting groundwater seepage which would otherwise emerge from the slopes or bottom of the excavations. The purposes of dewatering are to increase the stability of excavated slopes; prevent loss of material from beneath the slopes or bottom of the excavation; improve the excavating and hauling characteristics of on site soil; prevent rupture or heaving of the bottom of an excavation; and dispose of pumped water. In addition, dewatering is required to place and compact structural fill.

1.03 DESIGN REQUIREMENTS

- A. The Contractor is responsible for the adequacy of the dewatering system.

B. Design dewatering systems to:

1. Effectively reduce the hydrostatic pressure and lower the groundwater levels to a minimum of 2 feet below bottom of excavation in sandy soil; and lower the groundwater levels to a minimum of four (4) feet below bottom of excavation in silty soil;
2. Develop a substantially dry and stable subgrade for the protection of subsequent operations.
3. Result in no damage to adjacent buildings, structures, utilities and other work, included in this contract.
4. Depressurize stratified layers of sand that may be confined by silt layers so that a stable excavation bottom is maintained.

- C. Dewatering for construction shall be completed in accordance with the Contractor's chosen method capable of meeting the requirements of this specification.

- D. Methods may include sump pumping, single or multiple stage well point or jet eductor well point systems, deep wells, or combinations thereof.
- E. Locate dewatering facilities where they will not interfere with existing utilities, facilities and/or construction work to be done under this Contract.
- F. Contractor is responsible to obtain all necessary permits from state and local authorities, including Veolia, regarding the operation and discharge of the dewatering system, and to conduct all necessary sampling and testing that may be required by those authorities. The Contractor is responsible for **all associated costs.**
- G. Dewatering system performance shall be assessed by a program of groundwater well installations and well monitoring per this specification, and as approved by the Engineer.
- H. Design the dewatering system to meet Veolia's Industrial Pre-treatment Discharge requirements provided in Appendix 4. Total VOCs, Total SVOCs, and Cyanide have been identified in the groundwater above Veolia's discharge requirements. The system shall be designed to remove suspended solids and to remove groundwater contaminants identified at the site. See Appendix 3 and 5 for additional information.**
- I. Coordinate the dewatering system design with excavation support system requirements.
- J. Design, provide, install, operate, maintain and remove a temporary surface water control program, which will divert surface water away from excavations, trenches, utilities, and all other work areas.
- K. Design shall include provisions to prevent freezing including but not limited to heat trace, insulation, low temperature alarms, and appurtenances required to insure continuous operation of the dewatering system.

1.04 SUBMITTALS

A. Shop Drawings

- 1. Design of the excavation support and dewatering systems shall be coordinated and shall be submitted in the same transmittal.
- 2. In accordance with Section 01300 submit the following prior to dewatering system installation:
 - a. Proposed system components.
 - b. Operational plan to include locations and depth of components.
 - c. Method of disposal of pumped water, including method of insuring proper sediment removal should upset in dewatering system occur.
 - d. Approved Discharge Permit for disposal of treated groundwater to the Taunton Municipal Sewer System from Veolia and approved sampling and monitoring program identifying the contractor's laboratory.
 - e. Standby power equipment

B. Quality Assurance/Control Submittals

- 1. In accordance with Section 01300 submit the following:

- a. Dewatering systems to be designed under the direct supervision of a professional Civil Engineer registered in the state which the work is to be done.
- b. Complete Certificate of Design at the end of this section.
- c. Provide documentation demonstrating ability and experience of installing contractor for the type of conditions under this contract.
- d. Names, addresses and telephone numbers of supervisory personnel actively involved in at least five successful projects requiring dewatering.

1.05 PROJECT/SITE CONDITIONS

A. Environmental Requirements

1. Contaminants expected to be present and associated concentrations are presented in the "Limited Subsurface Investigation Report" included as Appendix 3 and supplemental testing provided in Appendix 5.

B. Existing Facilities

1. Discharge of dewatering effluent to the City of Taunton drainage system or Waters of the United States is not permitted.
2. Treated dewatering effluent may be discharged to the following location.
 - a. Treated groundwater from the contractors' operations shall be discharged to the City of Taunton Municipal Sewer System

C. Existing Conditions

1. Groundwater level information from previous investigations is included in Appendix 1.
2. Groundwater surface is subject to seasonal fluctuations and fluctuations during periods of heavy precipitation
3. Management of contaminated groundwater is anticipated for the dewatering operations associated with the Work within the pump station site.

PART 2 PRODUCTS

NOT USED

PART 3 EXECUTION

3.01 GENERAL

- A. Operation and Performance: Once started, operate the dewatering system continuously, 24 hours per day, 7 days per week, until such time as construction work below existing groundwater levels is complete, and/or as directed by the Engineer.

1. Measure and record the performance of the dewatering system at the same time each day using a flow measurement device.

B.

- C. The Contractor shall coordinate a Pre-Construction Meeting with the Engineer to discuss Contractor means, methods, procedures and schedule for dewatering systems construction, operation, monitoring and removal/abandonment when no longer needed.
- D. Complete installation of the dewatering system in accordance with the submittal design approved by the Engineer. Provide all labor, materials, equipment, and supervisory personnel required to perform the Work.
- E. Store materials at the designated locations in an organized fashion in order to execute the Work in an expeditious manner and to permit on-going existing pump station operations.
- F. Layout the Work in the field and mobilize labor, materials, equipment, and supervisory personnel necessary for the performance of dewatering work.
- G. The Contractor shall adapt and modify the dewatering, sedimentation and treatment systems as required throughout the course of the Work to meet applicable requirements.

3.02 SITE PREPARATION

A. Surface Drainage

- 1. Construct dikes, ditches, pipelines, sumps or other means to intercept and divert precipitation and surface water away from excavations.

B. Drainage of Excavated Areas

- 1. Construct dikes, ditches, pipelines, sumps or other means to collect surface and seepage water which may enter the excavation. Discharge collected water to the treatment system prior to discharge to the Taunton Municipal Wastewater Collection system.

3.03 INSTALLATION

- A. Advise Engineer of changes made to Operation Plan as submitted under article 1.05 of this section, made to accommodate field conditions
- B. Install additional dewatering facilities as needed to adequately dewater as specified herein at no additional cost to the Owner.
- C. Complete effluent sampling in accordance with the Industrial Pretreatment Permit.
- D. All wells, wellpoints and sumps shall be provided with suitable filter materials to prevent the migration or pumping of existing soil fines and subsequent subgrade weakening and disturbance.

3.04 MONITORING

- A. Observe and record daily flow records during the length of the dewatering operation and provide data to Engineer on daily basis.

3.05 OPERATION

- A. Operate dewatering systems to lower the groundwater level in excavations allowing the Work to be performed on a stable dry subgrade.
- B. Modify dewatering procedures which cause, or threaten to cause, damage to new or existing facilities, in the opinion of the Engineer, to prevent further damage. Modifications shall be made at no additional expense to the Owner.
- C. Effectively reduce the hydrostatic pressure and lower the groundwater levels to a minimum of two (2) feet below the bottom of excavation in sandy soil; and lower the groundwater levels to a minimum of four (4) feet below the bottom of excavation in silty soil.
- D. Prevent disturbance of foundation soils and loss of ground as water is removed.
- E. Notify the Engineer of disturbance to the foundation soils caused by an interruption or inadequacy of the dewatering system.
- F. Maintain on-site auxiliary equipment to operate the dewatering system continuously, while the excavation is open and as directed by the Engineer.
- G. Provide the Engineer access to the dewatering systems at all times to monitor performance. A flow meter capable of measuring to the nearest 0.1 gallons shall be installed at the discharge point prior to discharge entry into the City of Taunton's wastewater collection system.
- H. If sediment or other materials discharged from the dewatering system accumulates in the drains, conduits or other utilities, the Contractor shall be responsible to completely clean and remove all sediment from impacted utilities to the satisfaction of the Owner and at no additional cost to the Owner.

3.06 DISPOSAL OF WATER

- A. Effluent from dewatering operations shall be discharged through the approved treatment system. Discharged treated water is to be disposed of into the City's sewer system. **Discharge of untreated groundwater is not permitted.**

3.07 REMOVAL

- A. Remove all wells, sumps, material and equipment from the site upon completion of dewatering operations.
- B. Seal all existing and proposed dewatering wells upon completion of the dewatering by pressure injecting a grout capable of sealing the wells and preventing leakage.

END OF SECTION

CERTIFICATE OF DESIGN

Re: Contract Between

OWNER: _____
(Name)

and
CONTRACTOR: _____
(Name)

on
CONTRACT: _____
(Title)

_____ Dated: _____
(Number)

Contractor hereby certifies that _____
(Designer)

1. Is licensed or registered to perform professional engineering work in the state of _____
(Location of Project)

2. Is qualified to design the _____
(Item)
specified in Section _____ of the subject contract;

3. Has designed _____ before;

4. Has prepared the design in full compliance with the applications and requirements of
Section _____ of subject contract including all applicable laws, regulations, rules and
codes; and

5. The work has been signed and sealed pursuant to the applicable state law.

FOR: _____
(Contractor)

BY: _____
(Signature)

_____ Dated: _____
(Name and Title)

SECTION 02160

EXCAVATION SUPPORT

PART 1 GENERAL

1.01 DESCRIPTION

- A. The work specified in this section includes designing, furnishing, installing, and documenting the support of excavation system for the Influent Sewer connection and generator foundation at the Taunton Main Lift Pump Station Improvements; maintaining the support of excavation system as required removal when no longer needed. The Contractor shall properly design and furnish all labor and materials necessary, and shall construct complete, all shoring, bracing, pipeline penetrations and appurtenances required to perform the Work of excavation support for construction of the work as specified, as directed by the Engineer, or as required by agencies having jurisdiction over the Work.
- B. The support of excavation system is to be designed by the Contractor. The Contractor shall be responsible for all design and construction: means, methods and materials for the support of excavation system. The construction, maintenance, and removal of the excavation support system cannot adversely affect new or existing construction.
- C. The proximity of adjacent structures, manholes and pipelines shall be considered in the design, construction, maintenance and monitoring of the support of excavation system. Adjacent ground and structure movement as well as groundwater level monitoring, both inside and outside of the support of excavation system, shall be performed by the Contractor.
- D. The support of excavation and dewatering systems designs shall be coordinated.

1.02 REFERENCES

- A. ASTM, American Society of Testing and Materials
- B. AISC, American Institute of Steel Construction
- C. OSHA, U.S. Department of Labor, Occupational Safety and Health Administration, Construction Standards and Interpretations, 29 CFR Part 1926.

1.03 DESIGN RESPONSIBILITY

- A. The Contractor shall be fully responsible for providing a complete and adequately designed support of excavation system as required and/or directed by the Engineer in accordance with the provisions set forth herein. The excavation support system shall be designed to resist all hydrostatic pressures in accordance with the Contractor's dewatering design.
- B. The Contractor shall engage, at his own expense, the services of a fully competent and qualified Professional Engineer, hereinafter referred to as the "Contractor's Engineer", registered and in good standing with in the Commonwealth of Massachusetts for the design of dewatering and excavation support system requirements to accomplish the Work specified, and for supervising the proper on-site installation associated therewith. The Contractor's

Engineer shall be acceptable to the Engineer and demonstrate a minimum of ten (10) years documented experience. Prior to the actual employment of the Contractor's Engineer, the Contractor shall submit to the Engineer, to the full extent deemed necessary, a detailed resume stating the Contractor's Engineer's professional qualifications, related experience and references, and examples of work similar to that required for the Work specified, for a general review by the Engineer and a means of documenting the requisite experience hereinbefore specified. Only after a satisfactory review of the Contractor's Engineer's overall qualifications by the Engineer in fulfillment of the requisite experience hereinbefore specified shall the Contractor finalize such employment and begin the design aspects of the Work.

- C. The Contractor's attention is directed to the fact that the acceptance of the Contractor's Engineer and/or his/her qualifications by the Owner and/or Engineer shall not be an overall approval of the Contractor's Engineer nor the sheeting designs and methods of installation employed during the Work.
- D. The support of excavation design shall be coordinated with the dewatering system design to be submitted under Specification Section 2140, Dewatering.

1.04 QUALITY ASSURANCE

- A. The Contractor's Engineer shall provide and maintain throughout the support of excavation installation and/or Work sufficient supervision and technical guidance to the Contractor for proper sheeting/bracing materials, equipment, operations and methods to the extent necessary to assure strict compliance with the Contractor's Engineer's design, all safety procedures and standard requirements for such Work, and the successful completion of the Work. Failure to provide and/or maintain such supervision and/or technical guidance during the Work shall in no way relieve the Contractor's Engineer and/or the Contractor from their overall responsibilities and obligations under the Contract, nor shall it be a basis for any claim by either against the Owner and/or Engineer.
- B. The Contractor and Contractor's Engineer shall fully indemnify and save harmless the Owner and Engineer and their agents, employees and representatives, from and against any and all claims as stipulated under the Agreement, whether directly or indirectly arising out of, relating to or in connection with the Work.
- C. Quality assurances and proper safety procedures must be maintained at all times and be in strict accordance with the Contractor's Engineer's requirements and consistent with all federal, state and local regulatory agencies having jurisdiction over the Work. Should any conflict in requirements, regulations, restrictions or codes exist between that which is specified by the Contractor's Engineer and any federal, state or local agency, the more stringent application shall prevail.
- D. The Contractor may undertake their own existing conditions Preconstruction Survey, if if they deem necessary. A copy of the Contractor's Preconstruction Survey, if performed, shall be provided to the Engineer before the start of any construction.
- E. A Geotechnical Report including test borings and laboratory soil testing data; a ground water Pump Test Report; and a Test Pit Report including test pit logs excavated adjacent to the existing pump station have been completed by the Engineer and are including in Appendix 1 to this specification. The locations of project geotechnical borings are provided in the Geotechnical Report and on the project drawings. The Contractor shall fully examine existing

site conditions and provided information to ensure that this Work can be performed safely, as specified and in accordance with industry standards.

The Contractor shall provide all required equipment, modified if needed, to accommodate site conditions. Subsurface conditions may contain boulders, natural or manmade materials and/or other obstructions to the Work. The Contractor shall be prepared to penetrate through and/or remove such obstacles at no additional cost to the Owner.

- F. The Contractor shall coordinate a Preconstruction Meeting with the Engineer to discuss the Contractor's design and construction: means, methods, procedures and schedule for support of excavation system construction and additionally include, but not be limited to:
 - 1. Review of existing buildings, utilities and subsurface conditions.
 - 2. Review coordination for interruption, shutoff, capping, and continuation of utility services.
 - 3. Review proposed support of excavation, excavation and dewatering systems design and construction including specific attention to the pipeline penetrations of the support of excavation system.
 - 4. Review proposed sequence of construction, equipment and back-up equipment to be on-site.
 - 5. Review instrumentation: required groundwater level monitoring; survey monitoring of support of excavation system and adjacent: ground, buildings, utility manholes and valve boxes and other facilities.
 - 6. Review the removal of support of excavation system and the abandonment of the dewatering system when no longer needed.
 - 7. Review measures to maintain continuity of existing pump station operations during construction of the Work.

- G. The Contractor shall, at all times, be responsible for maintaining the support of excavation system to:
 - 1. Permit the satisfactory and safe construction of the work.
 - 2. Provide adequate protection against damage to all existing adjacent/nearby utilities, structures, manholes, buildings and completed portions of the work.
 - 3. Prevent injury to persons.

- H. The Contractor shall control surface water, and surface grades adjacent to excavations to prevent water from draining into excavated areas and to prevent damage to other structures or new construction.

- I. Survey-Work Benchmarks: Resurvey benchmarks regularly with a frequency of weekly, or more frequent and as directed by the Engineer during construction of support of excavation system, excavation progress, and for as long as the excavation remains open. Maintain an accurate log of surveyed elevations and positions for comparison with original elevations and positions. Promptly notify the Engineer if changes in sheeting elevations or positions occur or if cracks, sags, or other damage is evident in the support of excavation structure or adjacent construction.

- J. Promptly correct detected bulges, breakage, or other evidence of movement to ensure that the support of excavation system remains stable and safe.

- N. Promptly repair damages to adjacent facilities caused by the installation or faulty performance of support of excavation system.

1.05 PRODUCTS AND DESIGN CRITERIA

- A. The overall design, quality of materials and methods of installation to accomplish the Work specified shall be consistent with the established standards of the construction industry and must, as a minimum, comply with the requirements for earth support systems for excavations as defined by current US Department of Labor, Occupational Safety and Health Act (OSHA) regulation applicable thereto, and any other federal, state and local agencies having jurisdiction and/or requirements pertaining thereto including Building Code requirements for the Commonwealth of Massachusetts. The design and implementation thereof shall be in accordance with sound engineering practice and modern accepted principles of soil mechanics and shall include the effects of hydrostatic forces and all surcharge loads which may be reasonably anticipated. The methods employed shall be to the extent necessary to permit the proper and satisfactory installation and construction of the Work specified; to withstand all loads and forces encountered; to provide soil restraint and control of water as required; to insure the safety of the workers and all other personnel on or near the site; to prevent injurious caving or erosion, or loss of ground; to maintain at all times proper and safe pedestrian, vehicular traffic on public and private streets, property and rights-of-way; and to stabilize unforeseen areas of work encountered during the execution of the Work as deemed necessary by the Owner and/or Engineer.
- B. The Contractor and Contractor's Engineer's attention is directed to the fact that should any additional investigations, subsurface explorations and/or other appurtenant information be required to fulfill the needs of this design, as determined by the Contractor's Engineer above and beyond that which is already provided under these Contract Documents, the Contractor shall obtain all such information and data required at his own expense.

1.06 SHOP DRAWINGS AND/OR DESCRIPTIVE LITERATURE

- A. Submittals shall be provided in accordance with Specification Section 01300, SUBMITTALS. Construction shall not begin until submittal shop drawings are reviewed, evaluated and approved by the Engineer.
- B. Support of Excavation Submittals - The Contractor shall submit the following:
 - 1. Provide shop drawings: A support of excavation system design prepared by and/or under the direct supervision of a qualified experienced and registered Professional Engineer in good standing with the Commonwealth of Massachusetts.
 - i. Include plans, elevations, sections, and details.
 - ii. Show arrangement, locations, and complete design and construction details of the excavation support system, utility pipe penetrations, integration with the dewatering and instrumentation systems, and other components of support of excavation system.
 - iii. Include a written plan for support of excavation system construction, including sequence of construction coordinated with the progress of excavation, construction dewatering, system movement monitoring and other instrumentation components.
 - iv. If proposed the Contractor shall utilize "zero-resonance" vibratory sheet pile driver(s).
 - 2. Provide Contractor design calculations: For support of excavation system, and dewatering system analyses and other design information signed and sealed by a qualified

registered Professional Engineer in good standing with the Commonwealth of Massachusetts responsible for their preparation. This submission will not relieve the Contractor of the sole responsibility for the adequacy of the system nor shall it be construed as an approval or guarantee that the Contractor's proposed equipment, materials and methods for the shoring, bracing and/or appurtenances will be adequate for the Work required.

3. Survey Work: Engage and provide qualifications for the Professional Land Surveyor or Professional Engineer who are in good standing and registered in the Commonwealth of Massachusetts, who will survey the support of excavation structure, adjacent pump station, structures, utilities, manholes and other site improvements; establish exact elevations at fixed points to act as benchmarks, and clearly identify benchmarks and record existing elevations.
4. Qualifications: Contractor, Engineer and Land Surveyor: Qualifications shall be submitted to the Engineer for review and evaluation, which indicate that the Contractor, and the Contractor's design engineer and land surveyor have specialized in the design, construction, monitoring and maintenance of similar support of excavation systems, as indicated on the project drawings and this specification, for a minimum of ten (10) years.
5. Provide Record Drawings: Identify locations and depths of active and capped utilities, abandoned-in-place utilities, support of excavation system, and other surface and subsurface structural and utility conditions.
6. Existing Utility Locations: After checking utility locations by field investigations, provide drawings to show the actual locations of utilities and excavation support system interference(s)/penetration(s) with proposed Work, and measures proposed to overcome such interferences.
7. Provide all materials - sizes and members, connections, means, methods and sequence of installation and removal, as required, for the support of excavation system.
8. The excavation support design shall be coordinated with the dewatering system design that will be submitted to the Engineer under Specification Section 2140, DEWATERING. These submissions shall be made together in the same transmittal.

1.07 CERTIFICATE OF DESIGN

The Contractor's attention is directed to the required "Certificate of Design", the form of which is provided at the end of this Section. The Contractor and Contractor's Engineer shall complete this "Certificate" in its entirety for each location of work to be done, and any revisions associated there with, and submit it simultaneously with, as an integral part thereof, the sheeting submission. Any submission made without the completed "Certificate", appropriately signed and sealed, shall be returned to the Contractor. The Owner and/or Engineer hereby reserves the right to delay sheeting work and/or any work associated with, or dependent upon, the proper implementation of sheeting, without cause for claim against the Owner or Engineer, until a complete and appropriate submission is rendered. This Certification shall indicate that the excavation support system is designed to withstand the required loads, forces to be encountered, and to provide soil and water control, and are in compliance with these specifications and all federal, state or local agencies having jurisdiction over the Work to be performed.

PART 2 PRODUCTS

2.01 MATERIALS

- A. Bracing, Hardware and Fastenings:
 - 1. Steel bracing and other supports shall be of the strength and dimensions necessary to satisfactorily withstand the loads to which they will be subjected and shall be compatible in all aspects with the proposed excavation support sheeting. All bracing and other supports shall be free from any defects, which might impair this strength. The Contractor shall provide all necessary hardware and fastenings necessary in connections with satisfactory installation of all sheeting and bracing.
- B. **Excavation support components that will remain in place once construction is completed shall be produced in the United States in accordance with the American Iron and Steel requirements of P.L. 113-76, the Consolidated Appropriations Act of 2014.**

Part 3 EXECUTION

3.01 INSTALLATION

- A. The Contractor shall be fully responsible for ensuring adequate safety measures are provided at all times and shall comply with all safety requirements of federal, state and local agencies having jurisdiction over the Work. Installation of the excavation support system including all bracing, supports, utility penetrations, and appurtenances, and shall be adequate to permit the performance of the Work and be in accordance with the requirements of the Contractor's Engineer's and the sheeting design and acceptable to the Engineer.
- B. Any movements of the excavation support system and/or appurtenances which prevent the proper completion of the work shall be corrected at the expense of the Contractor.
- C. The excavation support system shall be installed in a manner which will prevent the disturbance of the surrounding surface, subsurface conditions, utilities and structures. Any such disturbances shall be corrected at the Contractor's expense and to the satisfaction of the Engineer.
- D. For installation of the excavation support system the Contractor shall limit vibrations, measured at existing utilities and at 50 feet from sheeting installation, to levels that do not exceed a peak particle velocity of 1.0 inch per second for impact event vibrations and 0.5 inch per second for continuous vibration events.
- E. The Contractor shall be responsible for maintaining the excavation support system and shall take all precautions necessary to prevent movement/settlement of soil material along the sides of excavations, and to prevent the intrusion of groundwater beyond that which the dewatering system can control.
- F. The Contractor shall monitor the performance/movement of the support of excavation system including: the horizontal and vertical support of excavation structure, adjacent building, pipelines, manholes and ground movement; and shall monitor excavation interior/exterior groundwater levels. If monitoring indicates excessive movement the Engineer may direct the Contractor to modify the support of excavation design and/or construction method at no additional cost to the Owner. The Contractor may be required to add supplemental bracing or use other measures, as may be appropriate to the situation.

- G. The Contractor shall provide the Engineer access to systems monitoring instrumentation and maintain instrument monitoring locations free from damage.
- H. Protection: Protect structures, utilities and other facilities from damage caused by settlement, lateral movement, undermining, washout, and other hazards that could develop during support of excavation system operations.
 - 1. Shore, support, and protect adjacent and encountered utilities.
- I. Site access/egress: Install support of excavation system to ensure minimum interference with roads, streets, walks, and other adjacent occupied and used facilities, e.g. existing pump station operations.
 - 1. Do not close or obstruct streets, walks, or other adjacent occupied or used facilities without permission from the Engineer and authorities having jurisdiction. Provide alternate routes around closed or obstructed traffic patterns if required by authorities having jurisdiction.
- J. Locate support of excavation system clear of permanent construction to avoid damage and so that construction and finishing of other work is not impeded.

3.03. MAINTENANCE OF SUPPORT OF EXCAVATION SYSTEM

- A. Maintain a sufficient quantity of support of excavation system components on hand throughout the conduct of the Work, including wales, bracing, sheets, shims and other system components for protection of the Work, personnel and for use in case of accident, emergency or required structure modification.
- B. Inform the Engineer in writing of any changes made to the support of excavation, dewatering and/or monitoring systems to accommodate field conditions

3.04 REMOVAL

- A. If sheeting is the proposed excavation support system, then no sheeting shall be removed except with specific written direction by the Engineer.
- B. If any excavation support is to be left in place then it shall be cut-off six (6) feet below grade level, or as directed by the Engineer.
- C. Do not disturb or damage adjacent structures, new construction, or utilities during removal. Fill voids immediately with lean concrete or with backfill compacted to the density as specified in Specification Section 02200, EARTHWORK. Cut-off and removal of excavation support may include bracing components, per Engineer direction. Repair or replace, adjacent work damaged or displaced by removing support of excavation system.
- D. All cut-off excavation support materials shall become the property of the Contractor and shall be removed from the worksite immediately.
- E. All restoration and clean-up shall be as indicated, specified and/or directed by the Engineer.

END OF SECTION

CERTIFICATE OF DESIGN

_____ (Owner)

Contract Reference: _____

_____, dated

_____.

In accordance with the provisions of the above referenced Contract, as the designated Contractor,

(Contractor's Name and Address)

hereby certifies that _____

(Contractor's Engineer's Name and Address)

(1) Is properly licensed and currently registered as a Professional Engineer in the Commonwealth of _____;

(2) Is fully qualified to design and supervise the _____

(Item of work and location)

In accordance with the provision specified under the appropriate Section and/or Subsections of the Contract Documents:

(3) Has successfully designed and supervised _____

(Item of work)

before and demonstrates a minimum of ten (10) documented years of proven experience in such field;

(4) Has personally examined the type(s) and locations(s) of the Work required under this Contract, and the overall conditions associated therewith, to the extent necessary to fully satisfy his or her professional responsibilities for designing and supervising the above referenced work;

- (5) Has prepared the attached design in full compliance with the applications and requirements of the Contract Documents, sound engineering practice, modern accepted principles of construction, and all applicable federal, state and local laws, regulations, rules and codes having jurisdiction over the Work;
- (6) Will provide sufficient supervision and technical guidance to the Contractor throughout the Work to ensure compliance with the design and all quality assurances necessary to successfully complete the Work;
- (7) Hereby indemnifies and holds harmless the _____
 _____ and BETA Group, Inc.,
 (name of owner)
 and their agents, employees and representatives, from and against any and all claims, whether directly or indirectly, arising out of, relating to or in connection with the Work; and
- (8) This "Certificate of Design" together with all applicable designs, drawings, details, specifications on other related documents necessary to complete the Work as specified, have been signed and sealed pursuant to applicable state law.

In recognition and observance of the above referenced statements, the undersigned parties hereby acknowledge and accept the responsibilities and obligations associated therewith.

CONTRACTOR:

CONTRACTOR'S ENGINEER:

(Contractor's Name)

(Engineer's Name)

By: _____

By: _____

(Name and Title)

(Name and Title)

Date: _____

Date: _____

(SEAL)

(P.E. STAMP)

(Note: Contractor to fully reference all attachments below)

END OF SECTION

SECTION 02200

EARTH EXCAVATION, BACKFILL, FILL AND GRADING

PART 1 GENERAL

1.01 SUMMARY

A. Section Includes

1. Requirements for; excavating in earth for trenches and structures; backfilling excavations; furnishing necessary material; compaction; constructing embankments and fills; miscellaneous earth excavations and miscellaneous grading.

B. Related Sections

1. Section 01410 - Testing Laboratory Services
2. Section 02140 – Dewatering
3. Section 02149 – Maintaining Existing Flow
4. Section 02160 – Excavation Support
5. Section 02215 - Aggregate Materials
6. Section 03300 - Cast-In-Place Concrete

1.02 REFERENCES

A. American Society for Testing and Materials (ASTM).

1. D1557, Standard Test Methods for Laboratory Compaction Characteristics of Soil Using Modified Effort (56,000 ft-lbf/ft³ (2,700 kN-m/m³)).

1.03 QUALITY ASSURANCE

A. Field Samples

1. Provide samples of materials as requested by the Engineer, to the Quality Control Engineer hired by the Owner, prior to delivery of materials on site, in order to facilitate field testing of compaction operations and material properties.

1.04 PROJECT/SITE CONDITIONS

A. Existing Conditions

1. There are pipes, drains, and other utilities in locations not indicated on drawings, no attempt has been made to show all services, and completeness or accuracy of information given is not guaranteed.

1.05 MAINTENANCE

- ###### A. Maintain all work in accordance with SECTION 01800.

PART 2 PRODUCTS

2.01 MATERIALS

A. Suitable Aggregate

1. The nature of materials will govern both acceptability for backfill and methods best suited for placement and compaction.
2. All material whether from excavations or from borrow pits, after being placed and properly compact, will make a dense stable fill and containing no vegetation, masses of roots, individual roots more than 18 inches long, or more than 1/2 inch in diameter, stones over 6 inches in diameter, or porous matter.
3. Organic matter to be well distributed and not to exceed minor quantities.

B. Trench and Excavation Backfill

1. In general, and unless other material is indicated on drawings or specified, material used for backfilling trenches and excavations shall be suitable material which was removed in the course of making the construction excavations. If sufficient suitable material is not available from the excavations, the backfill material shall be crushed stone, gravel borrow or select borrow as directed by the Engineer, in accordance to respective Specification Sections.
2. See Section 2.01.C for excavation backfill requirements under and adjacent to foundation walls.

C. Structure Backfill

1. Unless otherwise indicated or specified, all fill and backfill under and adjacent to structures, foundations walls, and pavement adjacent to structures shall be gravel borrow that consist of inert material that is hard, durable stone and coarse sand, free of loam and clay, surface coatings, and deleterious materials. Gradation requirements for backfill gravel shall be in accordance with SECTION 02215.
2. Excavated material shall not be permitted for backfill of structures or foundation walls.

D. Filling and Embankment Backfill

1. Suitable selected materials available from the excavations and not required for backfill around pipes or against structures may be used for filling and building embankments, except as otherwise specified. Material needed in addition to that available from construction operations shall be obtained from suitable gravel banks or other suitable deposits. The Contractor shall furnish, at his own expense, all borrow material needed on the work.

E. Additional materials

1. Concrete: In accordance with SECTION 03300.
2. Crushed stone: In accordance with SECTION 02215.
3. Gravel borrow: In accordance with SECTION 02215.
4. Select borrow: In accordance with SECTION 02215.

2.02 EQUIPMENT

A. Well Points

1. Designed to drain soil and prevent saturated soil from flowing into excavation.

B. Pumping Units

1. Designed for use with the wellpoints, capable of maintaining a high vacuum and, handling large volumes of air and water at the same time.

C. Underdrain Pipe

1. HDPE pipe enclosed in crushed stone encased in filter fabric.
2. Sewer pipe of quality known as "seconds".

2.03 SOURCE QUALITY CONTROL

- A. Provide Engineer with access to location of off site sources of materials.

PART 3 EXECUTION

3.01 EXAMINATION

- A. Verify all existing utilities and facilities prior to excavation.

3.02 PROTECTION

A. Utilities

1. Support and protect from damage existing pipes, poles, wires, fences, curbing, property line markers, and other structures, which the Engineer decides must be preserved in place without being temporarily or permanently relocated.
2. Restore items damaged during construction without compensation, to a condition at least equal prior to construction.

B. Trees

1. Enclose the trunks of trees adjacent to work with substantial wooden boxes of height necessary to protect trees from injury from piled material, equipment, operations or otherwise.
2. Employ excavating machinery and cranes of suitable type and size and operate with care to prevent injury to trees not to be cut and particularly to overhanging branches and limbs.
3. When trimming is required, make all cuts smooth and neat without splitting or crushing.
4. Cover cut areas with an application of grafting wax or tree healing paint.
5. Branches, limbs, and roots shall not be cut except by permission of the Engineer.

C. Plantings

1. Protect by suitable means or temporarily replant and maintain cultivated hedges, shrubs, and plants which may be injured by the Contractor's operations
2. Replant in their original positions and care for until growth is re-established, once the construction operations have been substantially completed.

3. If cultivated hedges, shrubs, and plants are injured to such a degree as to affect their growth or diminish their beauty or usefulness, they shall be replaced by items of kind and quality at least equal to which existed prior to the start of the Work.

D. Paved surfaces

1. Do not use or operate tractors, bulldozers, or other power-operated equipment with treads or wheels shaped as to cut or injure paved surfaces.
2. All surfaces which have been injured by the Contractor's operations shall be restored to a condition at least equal to which existed prior to start of the Work.
3. Suitable materials and methods shall be used for such restoration.

3.03 PREPARATION

A. Pavement Removal

1. Remove only existing pavement as necessary for the prosecution of the work.
2. Engineer may require that pavement be cut with pneumatic tools or saws without extra compensation to Contractor, where in the opinion of the Engineer it is necessary to prevent damage to the remaining road surface.
3. Dispose large of pieces of broken pavement before proceeding with excavation.

B. Top Soil Removal

1. From areas which excavations are to be made, loam and topsoil shall be carefully removed and separately stored to be used again as directed; or, if the Contractor prefers not to separate surface materials, he shall furnish, as directed, loam and topsoil at least equal in quantity and quality to that excavated.

C. Subgrade

1. Remove loam and topsoil, loose vegetable matter, stumps, large roots, etc., from areas where embankments will be built or material will be placed for grading.
2. Shape as indicated on the drawings and prepare by forking, furrowing, or plowing to bond first layer of the new material placed.

3.04 RELOCATION AND REPLACEMENT OF EXISTING STRUCTURES

A. The structures to which the provisions of this article apply include pipes, wires, and other structures which meet all of the following:

1. Are not indicated on the drawings or otherwise provided for.
2. Encroach upon or are encountered near and substantially parallel to the edge of the excavation.
3. In the opinion of the Engineer will impede progress to such an extent that satisfactory construction cannot proceed until they have been changed in location, removed (to be later restored), or replaced.

B. In removing existing pipes or other structures, the Contractor should use care to avoid damage to materials, and the Engineer shall include for payment only those new materials which, in his judgment, are necessary to replace those unavoidably damaged.

C. Whenever the Contractor encounters certain existing structures as described above and is so ordered in writing, he shall do the whole or such portions of the work as he may be directed to change the location of, remove and later restore, or replace such structures, or to assist the

Owner thereof in so doing. For all such work, the Contractor shall be paid under such items of work as may be applicable, otherwise as Extra Work.

- D. When fences interfere with the Contractor's operations, he shall remove and (unless otherwise specified) later restore them to a condition which existed prior to the start of the Work, all without additional compensation. The restoration of fences shall be done as promptly as possible and not left until the end of the construction period.

3.05 SHEETING AND BRACING

- A. Provide in accordance with Specification Section 02160.

3.06 DEWATERING

- A. Provide in accordance with Specification Section 02140.

3.07 EXCAVATION

- A. Execute operation of dewatering, sheeting and bracing without undermining or disturbing foundations of existing structures or of work previously completed under this contract.
- B. Excavate to widths that provide suitable room for:
 - 1. Building structures or laying and jointing piping.
 - 2. Placing all sheeting, bracing, and supports.
 - 3. Cofferdamming, pumping and draining.
- C. Render bottom of excavations firm, dry and acceptable in all respects.
- D. Do not plow, scrap or dig by machinery, earth at finished subgrade which results in disturbance of material below subgrade, unless indicated or specified, and remove with pick and shovel, last of material to be excavated, just before placing pipe, masonry or other structure.
- E. Make all excavations in open, except as otherwise specified or permitted.
- F. Excavation Near Existing Facilities
 - 1. As the excavation approaches pipes, conduits, or other underground structures, digging by machinery shall be discontinued and the excavation shall be done by means of hand tools. Such manual excavation when incidental to normal excavation shall be included in the work to be done under items involving normal excavation.
- G. Unauthorized Excavation
 - 1. If the bottom of any excavation is taken out beyond the limits indicated or prescribed, the resulting void shall be backfilled at the Contractor's expense with thoroughly compacted gravel borrow, if the excavation was for a pipeline, or with Class B concrete, if the excavation was for a masonry structure.
- H. Unsuitable Material

1. If material unsuitable for foundation (in the opinion of the Engineer) is found at or below the grade to which excavation would normally be carried in accordance with the Drawings and/or Specifications, the Contractor shall remove such material to the required width and depth and replace it with thoroughly compacted, crushed stone, gravel borrow, fine aggregate or concrete as directed.

3.08 TRENCHING

A. Trench Excavation

1. Where pipe is to be laid in specified bedding material or concrete cradle, the trench may be excavated by machinery to, or to just below, the designated subgrade, provided that the material remaining at the bottom of the trench is no more than slightly disturbed.
2. Where pipe is to be laid directly on the trench bottom, the lower part of trenches in earth shall not be excavated to subgrade by machinery, but, just before the pipe is to be placed, the last of the material to be excavated shall be removed by means of hand tools to form a flat or shaped bottom, true to grade, so that the pipe will have a uniform and continuous bearing and support on firm and undisturbed material between joints except for limited areas where the use of pipe slings may have disturbed the bottom.

B. Depth Of Trench

1. Excavate trench to depths permitting the pipe to be laid at the elevations, slopes, or depths of cover indicated on the drawings, and at uniform slopes between indicated elevations.

C. Width Of Trench

1. Excavate trench as narrow as practicable and do not widen by scraping or loosening materials from the sides. Every effort shall be made to keep the sides of the trenches firm and undisturbed until backfilling has been completed and consolidated.
2. Excavate trenches with approximately vertical sides between the elevation of the center of the pipe and an elevation 1 ft. above the top of the pipe.

D. Trench Excavation In Fill

1. If pipe is to be laid in embankments or other recently filled material, the material shall first be placed to the top of the fill or to a height of at least 1 ft. above the top of the pipe, whichever is the lesser. Particular care shall be taken to ensure maximum consolidation of material under the pipe location. The pipe trench shall then be excavated as though in undisturbed material.

- E. Length of trench open at any one time will be controlled by conditions, subject to any limits that may be prescribed by Engineer.

3.09 BACKFILLING

A. General

1. Frozen material shall not be placed in the backfill nor shall backfill be placed upon frozen material. Previously frozen material shall be removed or shall be otherwise treated as required, before new backfill is placed.

B. Fill And Backfill Under Structures

1. The fill and backfill materials shall be placed in layers not exceeding 6 in. in thickness. Unless otherwise indicated or specified, each layer shall be compacted to 95 percent in accordance with ASTM D1557.

C. Backfilling Around Structures

1. Do not place backfill against or on structures until they have attained sufficient strength to support the loads (including construction loads) to which they will be subjected, without distortion, cracking, or other damage. As soon as practicable after the structures are structurally adequate and other necessary work has been done, special leakage tests, if required, shall be made. Promptly after the completion of such tests, the backfilling shall be started and then shall proceed until its completion. Excavated materials shall not be used in backfilling of structures. Unequal soil pressures shall be avoided by depositing the material evenly around the structure.
2. The material shall be placed and compacted to 90 percent in accordance with ASTM D1557 unless otherwise indicated or specified.

D. Backfilling Pipe Trenches

1. As soon as practicable after the pipes have been laid and the joints have acquired a suitable degree of hardness, if applicable, or the structures have been built and are structurally adequate to support the loads, including construction loads to which they will be subjected, the backfilling shall be started and thereafter it shall proceed until its completion.
2. With the exception mentioned below in this paragraph, trenches shall not be backfilled at pipe joints until after that section of the pipeline has successfully passed any specified tests required. Should the Contractor wish to minimize the maintenance of lights and barricades and the obstruction of traffic, he may, at his own risk backfill the entire trench, omitting or including backfill at joints as soon as practicable after the joints have acquired a suitable degree of hardness, if applicable, and the related structures have acquired a suitable degree of strength. He shall, however, be responsible for removing and later replacing such backfill, at his own expense, should he be ordered to do so in order to locate and repair or replace leaking or defective joints or pipe.
3. No stone or rock fragment larger than 12 in. in greatest dimension shall be placed in the backfill nor shall large masses of backfill material be dropped into the trench in such a manner as to endanger the pipeline. If necessary, a timber grillage shall be used to break the fall of material dropped from a height of more than 5 ft. Pieces of bituminous pavement shall be excluded from the backfill unless their use is expressly permitted, in which case they shall be broken up as directed.
4. Zone Around Pipe
 - a. Backfilled with the materials and to the limits indicated on the drawings.
 - b. Material shall be compacted to 90 percent by tamping.
5. Remainder of Trench
 - a. Compact by water-jetting, or tamping, in accordance with the nature of the material to 95 percent in accordance with ASTM D1557. Water-jetting may be used wherever the material does not contain so much clay or loam as to delay or prevent satisfactory drainage. However, tamping shall be used if water-jetting does not compact the material to the density required.
6. Excavated material which is acceptable to the Engineer for surfacing or pavement subbase shall be placed at the top of the backfill to such depths as may be specified

elsewhere or as directed. The surface shall be brought to the required grade and stones raked out and removed.

E. Placing And Compacting Embankment Material

1. After the subgrade has been prepared as hereinbefore specified, the material shall be placed thereon and built up in successive layers until it has reached the required elevation.
2. Layers shall not exceed 12 in. in thickness before compaction. In embankments at structures, the layers shall have a slight downward slope away from the structure; in other embankments the layers shall have a slight downward slope away from the center. In general, the finer and less pervious materials shall be placed against the structures or in the center, and the coarser and more pervious materials, upon the outer parts of embankments.
3. Each layer of material shall be compacted by the use of approved rollers or other approved means so as to secure a dense, stable, and thoroughly compacted mass. At such points as cannot be reached by mobile mechanical equipment, the materials shall be thoroughly compacted by the use of suitable power-driven tampers.
4. Previously placed or new materials shall be moistened by sprinkling, if required, to ensure proper bond and compaction. No compacting shall be done when the material is too wet, from either rain or too great an application of water, to compact it properly; at such times the work shall be suspended until the previously placed and new materials have dried out sufficiently to permit proper compaction, or such other precautions shall be taken as may be necessary to obtain proper compaction.
5. The portion of embankments constructed below proposed structures shall be compacted to 95 percent in accordance with ASTM D1557. The top 2 ft. of an embankment below a pavement base shall be compacted to 95 percent. All other embankments shall be compacted to 90 percent in accordance with ASTM D1557.

3.10 METHODS OF COMPACTION

A. Water-Jetting

1. Saturate backfill material throughout its full depth and at frequent intervals across and along the trench until all slumping ceases.
2. Furnish one or more jet pipes, each of sufficient length to reach the specified depth and of sufficient diameter (not less than 1-1/4 in.) to supply an adequate flow of water to compact the material.
3. Equip jet pipe with a quick-acting valve, supply water through a fire hose from a hydrant or a pump having adequate pressure and capacity to achieve the required results.

B. Tamping and Rolling

1. Deposit backfill material and spread in uniform, parallel layers not exceeding 8 in. thick before compaction. Before the next layer is placed, each layer shall be tamped to obtain a thoroughly compacted mass. Care shall be taken that the material close to the bank, as well as in all other portions of the trench, is thoroughly compacted. When the trench width and the depth to which backfill has been placed are sufficient to make it feasible, and it can be done effectively and without damage to the pipe, backfill may, on approval, be compacted by the use of suitable rollers, tractors, or similar power equipment instead of by tamping. For compaction by tamping (or rolling), the rate at which backfilling material is deposited in the trench shall not exceed that permitted by the facilities for its spreading, leveling, and compacting.

2. If necessary to ensure proper compaction by tamping (or rolling), the backfill material shall first be wet by sprinkling. However, no compaction by tamping (or rolling) shall be done when the material is too wet either from rain or too great an application of water to be compacted properly; at such times the work shall be suspended until the previously placed and new materials have dried out sufficiently to permit proper compacting, or such other precautions shall be taken as may be necessary to obtain proper compaction.

C. Miscellaneous Requirements.

1. Whatever method of compacting backfill is used, care shall be taken that stones and lumps shall not become nested and that all voids between stones shall be completely filled with fine material. Only suitable quantities of stones and rock fragments shall be used in the backfill; the Contractor shall, as part of the work done under the items involving earth excavation and rock excavation as appropriate, furnish and place all other necessary backfill material.
2. All voids left by the removal of sheeting shall be completely backfilled with suitable materials, and thoroughly compacted.

3.11 DISPOSAL OF SURPLUS EXCAVATED MATERIALS

- A. No excavated materials shall be removed from the site of the work or disposed of by the Contractor except as directed or permitted by the Engineer.
- B. Surplus excavated materials suitable for backfill shall be used to backfill normal excavations in rock or to replace other materials unacceptable for use as backfill; shall be neatly deposited and graded so as to make or widen fills, flatten side slopes, or fill depressions; or shall be neatly deposited for other purposes within a haul of 1 mile from the point of excavation; all as directed or permitted and without additional compensation.
- C. Surplus excavated materials not needed as specified above shall be hauled away and dumped by the Contractor, at his expense, at appropriate locations, and in accordance with arrangements made by him.

3.12 DISPOSAL OF SPECIAL WASTES

- A. The Contractor's attention is directed to the requirements set forth by the State of Massachusetts, Department of Environmental Protection, (MA DEP) regarding "Special Wastes" and the proper disposal thereof. All waste materials and debris, as designated by the Owner and/or Engineer, including but not limited to any sewers, storm drains, catchbasins, and combined system pipelines and associated structures, or any portions thereof, including but not limited to sludge, grit, sediment, dirt, sand, rock, grease, roots and other liquid, solid or semi-solid materials contained therein, shall be considered "Special Wastes." In addition, any excavated soils contaminated in any manner, as designated by the Owner and/or Engineer, shall also fall under this category and shall be handled the same. When so encountered, all such materials and debris shall be removed to the extent so ordered by the Engineer and properly disposed of in strict compliance with the requirements of the MA DEP and other regulating authorities to an approved and certified waste disposal site. It shall remain the sole responsibility of the Contractor to apply for and obtain all required permits, bonds and/or insurance relative to such disposal. The Contractor shall also pay all costs associated with the disposal, required permits, bonds and insurance with no additional expense to the Owner. All handling of such "Special Waste" shall be done in strict compliance with the MA DEP requirements and/or any other federal, state or local agency

having jurisdiction or authority over the same. Under no circumstances shall sewage, solids or other "Special Wastes" removed from the sewer lines be dumped or spilled onto the streets or into ditches, catch basins or storm drains. The Contractor must use watertight and State approved vehicles in transporting any wastes as hereinbefore designated.

- B. The Contractor shall indemnify and save harmless the Owner and Engineer and all persons acting for or on behalf of the Owner and Engineer from all claims and liability of any nature or kind, and all damages, costs and expenses, including attorney's fees and penalties, arising from the improper handling, transportation or disposal of "Special Wastes" as determined by the MA DEP and/or any other federal, state or local agency having jurisdiction or authority over the same.

3.13 DUST CONTROL

- A. During the progress of the Work, maintain the area of activities, by sweeping and sprinkling of streets to minimize the creation and dispersion of dust. If the Engineer decides that it is necessary to use calcium chloride for more effective dust control, the Contractor shall furnish and spread the material, as directed.

3.14 BRIDGING TRENCHES

- A. Provide suitable and safe bridges and other crossings where required for the accommodation of travel, and to provide access to private property during construction. Remove once bridges and crossings are no longer needed.

3.15 FIELD QUALITY CONTROL

- A. Site Tests

- 1. In accordance with SECTION 01410

3.16 CARE AND RESTORATION OF PROPERTY

- A. Restoration of existing property or structures done as promptly as practicable and not left until the end of the construction period.

END OF SECTION

SECTION 02210

ROCK EXCAVATION

PART 1 GENERAL

1.01 SUMMARY

A. Section Includes

1. Requirements for removal and disposal of rock.

B. Related Sections

1. Section 00500-Agreement
2. Section 00800- Supplementary Conditions
3. Section 02200-Earth Excavation, Backfill, Fill and Grading

1.02 DEFINITIONS

- ###### A. Rock-as defined in SECTION 00500.

1.03 REQUIREMENTS

- ###### A. Excavate rock if encountered, to the lines and grades indicated on the drawings or as directed, dispose of the excavated material, and furnish acceptable material for backfill in place of the excavated rock.
- ###### B. Excavate rock in pipe trenches to a limit which provides 6-inches clearance minimum from the pipe after it has been laid. Before the pipe is laid, the trench shall be backfilled to the correct subgrade with thoroughly compacted, suitable material or, when so specified or indicated on the drawings, with the same material as that required for bedding the pipe, furnished and placed at the expense of the Contractor.
- ###### C. The use of explosives will not be allowed.

PART 2 PRODUCTS

NOT USED

PART 3 EXECUTION

3.01 EXCESS ROCK EXCAVATION

- ###### A. If rock is excavated beyond the limits of payment indicated on the drawings, specified, or authorized in writing by the Engineer, the excess excavation, whether resulting from overbreakage or other causes, shall be backfilled, by and at the expense of the Contractor, as specified below in this section.

- B. In pipe trenches, excess excavation below the elevation of the top of the bedding, cradle, or envelope shall be filled with material of the same type, placed and compacted in the same manner, as specified for the bedding, cradle, or envelope. Excess excavation above said elevation shall be filled with earth as specified in the article titled "Backfilling Pipe Trenches" in SECTION 02200.
- C. In excavations for structures, excess excavation in the rock beneath foundations shall be filled with 3000 psi concrete. Other excess excavation shall be filled with earth as specified in the article titled "Backfilling Around Structures" in SECTION 02200.

3.02 SHATTERED ROCK

- A. If the rock below normal depth is shattered due to rock removal operations of the Contractor, and the Engineer considers such shattered rock to be unfit for foundations, the shattered rock shall be removed and the excavation shall be backfilled with concrete as required, except that in pipe trenches screened gravel shall be used for backfill. All such removal and backfilling shall be done by and at the expense of the Contractor.

3.03 PREPARATION OF ROCK SURFACES

- A. Whenever so directed during the progress of the work, remove all dirt and loose rock from designated areas and shall clean the surface of the rock thoroughly, using steam to melt snow and ice, if necessary. Water in depressions shall then be removed as required so that the whole surface of the designated area can be inspected to determine whether seams or other defects exist.
- B. The surfaces of rock foundations shall be left sufficiently rough to bond well with the masonry and embankments to be built thereon, and if required, shall be cut to rough benches or steps.
- C. Before any masonry or embankment is built on or against the rock, the rock shall be scrupulously freed from all vegetation, dirt, sand, clay, boulders, scale, excessively cracked rock, loose fragments, ice, snow, and other objectionable substances. Picking, barring, wedging, streams of water under sufficient pressure, stiff brushes, hammers, steam jets, and other effective means shall be used to accomplish this cleaning. Remove free water left on the surface of the rock.

3.04 REMOVAL OF BOULDERS

- A. Remove piles of boulders and loose rock encountered within the limits of earth embankments and dispose in a suitable place.

3.05 DISPOSAL OF EXCAVATED ROCK

- A. All excavated rock shall be handled, transported and disposed of by the Contractor, at his expense, at appropriate locations, and in accordance with arrangements made by him without additional cost to the Owner.
- B. Excavated rock may be used in backfilling trenches subject to the following limitations:

1. Pieces of rock larger than permitted under the article titled "Backfilling Pipe Trenches" in SECTION 02200 shall not be used for this purpose.
 2. The quantity of rock used as backfill in any location shall not be so great as to result in the formation of voids.
 3. Rock backfill shall not be placed within 36 in. of the surface of the finish grade.
- C. Surplus excavated rock shall be disposed of as specified for surplus excavated material as specified in SECTION 02200.

3.06 BACKFILLING ROCK EXCAVATIONS

- A. Where rock has been excavated and the excavation is to be backfilled, the backfilling above normal depth shall be done as specified in SECTION 02200. If material suitable for backfilling is not available in sufficient quantity from other excavations, the Contractor shall, at his own expense, furnish suitable material from outside sources.

END OF SECTION

(THIS PAGE INTENTIONALLY LEFT BLANK)

SECTION 02215

AGGREGATE MATERIALS

PART 1 GENERAL

1.01 SUMMARY

A. Section Includes

1. Requirements for furnishing and placing materials, which include Crushed Stone, Gravel Borrow and Select Borrow.
2. Location of specified materials as detailed on the Drawings or as directed by the Engineer for excavation below normal depth, utility support, replacement of unsuitable material or elsewhere, as ordered.

B. Related Sections

1. Section 02200 - Earth Excavation, Backfill, Fill and Grading.
2. Section 02500 - Paving

1.02 REFERENCES

A. American Association of State Highway and Transportation Officials (AASHTO).

1. T11, Amount of Material Finer than 0.075 mm Sieve in Aggregate
2. T27, Sieve Analysis of Fine and Coarse Aggregates.

B. American Society for Testing and Materials (ASTM).

1. D1557, Standard Test Methods for Laboratory Compaction Characteristics of Soil Using Modified Effort (56,000 ft-lbf/ft³ (2,700 kN-m/m³)).

1.03 DEFINITIONS

- ###### A. The term Screened Gravel as used in the Contract Documents shall mean Crushed Stone.

1.04 SUBMITTALS

A. Shop Drawings

1. Provide sieve analysis when gradation requirements are given in the Specification.

B. Samples

1. Furnish representative sample including location of source with Shop Drawing transmittal sheet.

1.05 QUALITY ASSURANCE

A. Field Samples

1. The attention of the Contractor is directed to the fact that under Specification SECTION 00700, 1.03 Materials and Equipment, all materials furnished by the Contractor to be incorporated into the Work shall be subject to the inspection of the Engineer. The

Engineer shall be the sole judge as to the acceptability of proposed materials and said judgement shall be final, conclusive, and binding.

1.06 DELIVERY, STORAGE, AND HANDLING

A. Storage and Protection

1. In accordance with Specification SECTION 00700, 1.03 Materials and Equipment.

PART 2 PRODUCTS

2.01 MATERIALS

A. Crushed Stone

1. For bedding and pipe zone material for pipe larger than 3 inches diameter. Well graded in size from 3/8 inches to 3/4 inches or such other sizes as may be approved.
2. For bedding and pipe zone material for plastic pipe 3 inches diameter and less, maximum particle size shall be 3/8 inches.
3. Clean, hard, and durable particles or fragments, free from dirt, vegetation, or other objectionable matter, and free from an excess of soft, thin elongated, laminated or disintegrated pieces.
4. Screened Stone of similar size and grading to this specification may be used instead of Crushed Stone.

B. Gravel Borrow

1. Granular material well graded from fine to coarse with a maximum size of 3 inches, obtained from approved natural deposits and unprocessed except for the removal of unacceptable material and stones larger than the maximum size permitted.
2. Gravel shall not contain vegetation, masses of roots, or individual roots more than 18 inches long or more than 1/2 inches in diameter.
3. Gravel shall be substantially free from loam and other organic matter, clay and other fine or harmful substances.
4. Gradation requirements for gravel shall be determined by AASHTO-T11 and T27 and conform to the following:

<u>Sieve</u>	<u>Percent Passing</u>
1/2 inch	60-95
No. 4	50-85
No. 50	8-28
No. 200	0-8

C. Select Borrow

1. Use inorganic natural soils and/or rock, having not more than 8 percent by weight passing the No. 200 sieve and having a maximum stone size no greater than 6-inches.
2. Use only material well-graded throughout entire size range, free of roots, leaves and other organic material, ice or frost and aggregations of frozen soil particles.
3. Moisture content to be within plus minus 3 percent optimum at the borrow source.
4. Material must meet compaction requirements indicated or as specified.

D. Gravel Base Course

1. In accordance with SECTION 02500.

2.02 SOURCE QUALITY CONTROL

A. Test, Inspection

1. Engineer may elect to sample material supplied at the source.
2. Assist the Engineer and/or personnel from the designated testing laboratory in obtaining samples.

PART 3 EXECUTION

3.01 INSTALLATION

A. Crushed Stone

1. Spread in layers of uniform thickness not greater than 6 inches.
2. Compact thoroughly by means of a suitable vibrator or mechanical tamper.

B. Gravel Borrow

1. Spread in layers of uniform thickness not exceeding 12 inches before compaction and moistened or allowed to dry as directed.
2. Compact thoroughly by means of suitable power-driven tampers or other power-driven equipment.
3. Compaction shall conform to 95% of minimum dry density per ASTM D1557.
4. The percolation rate for the compacted bank-run gravel shall not exceed 5 minutes per inch.

C. Select Borrow

1. Spread in layers of uniform thickness not exceeding 12 in. (loose lift) before compaction and moistened or allowed to dry.
2. Compact thoroughly by means of suitable power-driven tampers or other power-driven equipment unless otherwise directed by the Engineer.

3.02 FIELD QUALITY CONTROL

A. Material and compaction testing

1. In accordance with SECTION 01410.

END OF SECTION

(THIS PAGE INTENTIONALLY LEFT BLANK)

SECTION 02224

CONTROLLED DENSITY FILL (MASSACHUSETTS)

PART 1 GENERAL

1.01 SUMMARY

A. Section Includes

1. Requirements for controlled density fill (CDF) to be used in place of compacted soil for general backfill of trenches and/or excavations.

1.02 REFERENCES

A. American Association of State Highway and Transportation Officials (AASHTO)

1. AASHTO M 85 - Standard Specification for Portland Cement (Chemical and Physical)
2. AASHTO M 295, Class F - Standard Specification for Coal Fly Ash and Raw or Calcined Natural Pozzolan for Use in Concrete

B. This specification makes reference to the requirements of additional specifications as listed. The Contractor shall obtain and familiarize himself with all requirements referenced by this specification prior to preparation and installation of any materials.

1. Massachusetts Department of Transportation Highway Division (massDOT), Standard Specifications for Highways and Bridges, 1988 Edition, including all addenda, issued by the State of Massachusetts Department of Transportation, (referred to as the Standard Specification).

1.03 DEFINITIONS

A. Controlled Density Fill, also known as "Flowable Fill" is a flowable, self-consolidating, rigid setting, low density material that can substitute for compacted gravel in backfills, fills and structural fills.

B. The two main categories of CDF's are Excavatable and Non-excavatable, with sub categories of flowable and very flowable.

C. Categories of CDF's:

1. Type 1 Very Flowable, non excavatable,
2. Type 1E Very Flowable, excavatable,
3. Type 2 Flowable, non excavatable,
4. Type 2E Flowable, excavatable.

D. Excavatable mixes shall be hand tool excavatable.

E. Very Flowable shall have very flowable characteristics for distances and small hard to reach areas.

1.04 DESIGN REQUIREMENTS

- A. Provide a mixture of Portland cement, aggregates, water and mineral admixtures with a low cement content and high slump to reduce strength development for possible removal and minimize settlement after placement.
- B. The proposed mix should maximize the flow characteristics of the material while producing the necessary strength.
- C. The mixes shall have the following design strengths:
 - 1. Non excavatable fill,
 - a. Type I (very flowable) and Type 2 (flowable),
 - b. Compressive strength at 28 days = 30 to 150 psi, 200 psi maximum at 90 days.
 - 2. Excavatable fill,
 - a. Type 1E (very flowable) and Type 2E (flowable),
 - b. Compressive strength at 28 days = 30 to 80 psi, 100 psi maximum at 90 days.
- D. Specific compressive strength(s) for structural applications are noted on the Contract Drawings.
- E. Slump
 - 1. Standard method = 10 to 12-inches.
 - 2. Modified method consisting of a six inch long by three inch inside diameter straight tube of non-porous material = 9 to 14-inches.

1.05 PERFORMANCE REQUIREMENTS

- A. Provide fill of homogeneous structure which when cured, will have the required strength, water tightness, and durability. To this end, it is essential that careful attention be given to the selection of materials, mixtures, placing and curing of the fill.

1.06 SUBMITTALS

- A. In accordance with Section 01300, submit the following,
 - 1. Mix design data not limited to, but including maximum and minimum strengths, air content, setting times, flowability and yield.
 - 2. Certification by the supplier stating compatibility with the project requirements and the Contractor's installation methods.

1.07 QUALITY ASSURANCE

- A. Furnish the supplier with information as to the intended use of the CDF.

PART 2 PRODUCTS

2.01 MATERIALS

- A. Portland cement,

1. In accordance with AASHTO M85.
- B. Fly Ash (very flowable),
 1. In accordance with AASHTO M295, Type F.
- C. Sand,
 1. In accordance with Standard Specification M4.02.02
- D. Water,
 1. Clean and potable.
- E. Air entraining admixtures,
 1. In accordance with Standard Specification M4.02.05.

PART 3 EXECUTION

3.01 GENERAL

- A. The Contractor shall follow the guideline set forth in ACI 229, except non standard materials shall not be used.

3.02 PREPARATION

- A. Pipes and all other members to be encased in CDF shall be temporarily secured in place to prevent displacement during fill placement.
- B. To reduce hydrostatic pressure and limit displacement potential, Contractor may use a high air generator in the fill mixture to lower unit weights.
- C. Pre-job test all pump applications prior to day of placement with actual equipment.
- D. Secure site during the placement for the CDF. Cautions include but are not limited to barricades, fences, lights and steel plates.
- E. Work shall be sequenced so as to keep traffic flowing within the project area.

3.03 INSTALLATION

- A. CDF shall be batched at concrete plants and hauled to job sites in ready-mix trucks with continuous agitating drums and be discharged with slumps as indicated.
- B. During waiting period prior to discharge, truck drums shall agitate mixture.
- C. CDF shall be installed in accordance with supplier's recommendations, be flowable and require no vibration.

3.04 FIELD QUALITY CONTROL

- A. All CDF to be used in the work shall be subject to testing to determine whether it conforms to the requirements of the specifications. The methods of testing shall be in accordance with the Standard Specification, and as approved by the Engineer.
- B. The place, time, frequency, and method of sampling will be determined by the Engineer in accordance with the particular conditions of this project.

3.05 PROTECTION

- A. Open excavations containing uncured CDF shall not be left uncovered overnight.

END OF SECTION

SECTION 02272

GEOTEXTILE MATERIALS

PART 1 GENERAL

1.01 SUMMARY

A. Section Includes

1. Requirements for installation of geotextile filter fabric in trenches and under riprap.

B. Related Sections

1. Section 02100 - Site Preparation
2. Section 02200 – Earthwork
3. Section 02215 – Aggregate Materials

1.02 REFERENCES

A. American Society for Testing and Materials (ASTM)

1. D3786, Test Method for Hydraulic Bursting Strength of Knitted Goods and Nonwoven Fabrics: Diaphragm Bursting Strength Tester Method
2. D4355, Test Method for Deterioration of Geotextiles From Exposure to Ultraviolet Light and Water (Xenon-Arc Type Apparatus)
3. D4491, Test Method for Water Permeability of Geotextiles by Permittivity
4. D4533, Test Method for Trapezoid Tearing Strength of Geotextiles
5. D4632, Test Method for Grab Breaking Load and Elongation of Geotextiles
6. D4751, Test Method for Determining Apparent Opening Size of a Geotextile
7. D4833, Test Method for Index Puncture Resistance of Geotextiles, Geomembranes and Related Products
8. D5261, Measuring Mass Per Unit Area of Geotextiles.
9. D6241, Standard Test Method for the Static Puncture Strength of Geotextiles and Geotextile-Related Products Using a 50-mm Probe

1.03 QUALITY ASSURANCE

A. General

1. Producer of fabric to maintain competent laboratory at point of manufacture to insure quality control in accordance with ASTM testing procedures.
2. Laboratory to maintain records of quality control results.

1.04 SUBMITTALS

A. Shop Drawings

1. Submit in accordance with SECTION 01300
2. Include manufacturer's recommended method of joining of adjacent fabric panels.

B. Certificate of Conformance

1. Upon each shipment/delivery of product to the work site, furnish mill certificate(s) from the company manufacturing the fabric attesting that the fabric meets the chemical, physical, manufacturing and performance requirements specified. Fabric will be rejected if it is found to have defects, rips, flaws, deterioration or other damage.

1.05 DELIVERY, STORAGE AND HANDLING

- A. Provide fabric in rolls wrapped with a heavy-duty protective covering to protect fabric from, mud, dirt, dust, debris and other deleterious sources until it is installed. Label each roll of fabric with number or symbol to identify production run.
- B. Do not expose fabric to ultraviolet radiation (sunlight) for more than 20 days total in period of time following manufacture until fabric is installed and covered.
- C. If Engineer determines material is damaged in any way or has excessive sunlight exposure, the Contractor shall immediately make all repairs and replacements as directed by the Engineer, at no additional cost to the Owner.

1.06 SCHEDULING

- A. Schedule Work so that the covering of the fabric with a layer of the cover material is accomplished immediately after inspection and approval of the placed fabric by the Engineer. Failure to comply with this requirement shall require replacement of the fabric.

PART 2 PRODUCTS

2.01 ACCEPTABLE MANUFACTURER/MATERIAL

- A. The geotextile fabric shall be nonwoven polypropylene designated as MIRAFI 140N as manufactured by US Fabrics, Cincinnati, Ohio; or acceptable equivalent and shall meet the following minimum requirements:

<u>Minimum Property (Unit)</u>	<u>Unit</u>	<u>Test Method</u>	<u>Requirements</u>
Weight	oz/sy	ASTM D5261	4.5
Grab Tensile Strength	lbs	ASTM D4632	120
Grab Tensile Elongation	%	ASTM D4632	50
CBR Puncture Strength	lbs	ASTM D6241	310
Trapezoid Tear Strength	lbs	ASTM D4533	50
Apparent Opening Size (AOS)	US Std. Sieve (mm)	ASTM D4751	70 (0.21)
Permittivity	sec ⁻¹	ASTM D4491	1.7
Permeability	cm/sec	ASTM D4491	0.22
Flow Rate	gal/min/sf	ASTM D4491	135
Ultraviolet Resistance (strength retained at 500 hrs)	%	ASTM D4355	70

- B. To keep the number of overlay joints to a minimum, fabric shall be provided in sections not less than fifteen (15) feet in width unless otherwise approved by the Engineer prior to delivery to the site.

PART 3 EXECUTION

3.01 SUBGRADE PREPARATION

A. For Riprap

1. Prepared areas to receive geotextile in accordance with SECTION 02100 and SECTION 02200
2. Clear subgrade of all sharp objects, large stones, roots, debris, or any other foreign materials that may contribute to puncturing, shearing, rupturing or tearing of the geotextile.
3. Grade area as smooth as possible and compact in accordance with SECTION 02200, with a vibratory roller or other method approved by the Engineer.
4. Inspect subgrade and repair all unstable areas or soft spots with the installation of gravel and recompact prior to the placement of geotextile.

3.02 FABRIC INSTALLATION

A. For Riprap

1. Place at the locations shown on the Contract Drawings.
2. Unroll directly onto the prepared slope in a continuous manner. Join adjacent sections by overlapping the fabric a minimum of 12-inches. Join end sections by overlapping the fabric a minimum of 2-feet with field-sewn joints or as recommended by the manufacturer.
3. Place fabric on slopes creating a “shingled” effect in the direction of anticipated water flow.
4. Lay fabric smooth, maximizing surface contact with the prepared subbase, free of tension, stress, folds, wrinkles, or creases.
5. Securely anchor fabric sections at the top of the slope as recommended by the manufacturer. Use anchoring pins, nails, staples or other such means to secure fabric to the subbase surface to prevent fabric movement caused by wind uplift, and/or placement of cover material.
6. Maintain sufficient amount of cover material (minimum depth of 6-inches) to protect fabric during placement of riprap. Dozer buckets or blades, or other heavy or damaging equipment shall not be in direct contact with the fabric.
7. Minimize the height from which cover material is dumped and/or dropped directly onto the fabric material in order to avoid fabric damage or movement. Equipment used for spreading and compacting the cover material shall be of the type and size to avoid damage or movement to the underlying geotextile fabric.
8. Spread cover material in the direction of fabric overlap and in a manner that avoids creating undue tension, stress, sagging, buckling and/or other movement of the underlying fabric.

B. Fabric Installation in Trenches

1. In accordance with manufacturers recommendations
2. Place fabric in trench prior to placing crushed stone pipe bedding.
3. Overlap fabric 18-inches minimum for unsewn lap joints.
4. Do not permit equipment to travel directly on fabric.
5. Place fabric in smooth condition to prevent tearing or puncture.
6. Lay fabric loosely, without wrinkles or creases.
7. Leave slack in fabric to allow for adjustment.

3.03 PROTECTION

- A. Protect the work before, during and after installation, and protect the installed work covered by other Sections.

3.04 REPAIR

- A. Geotextile fabric damaged during installation shall be repaired by a piece of geotextile material cut, placed and adequately anchored over the damaged area, subject to a 3-foot minimum overlap requirement or as directed by the Engineer.
- B. If detrimental movement of the geotextile fabric occurs during any step of the installation, as determined solely by the Engineer, the Contractor shall remove the cover material and/or sections of fabric to the limits deemed necessary and reinstall the fabric.
- C. Any fabric damage during its installation or during placement of cover materials shall be replaced by the Contractor at no additional cost to the Owner.

END OF SECTION

SECTION 02277

STRAW WATTLES

PART 1 GENERAL

1.01 SECTION INCLUDES

- A. Requirements to furnish and install straw wattles, as indicated on the Drawings and as herein specified.

1.02 SUBMITTALS

- A. In accordance with SECTION 01300 submit product details, manufacturers installation instructions and certifications.

1.03 STORAGE

- A. Store wattles off the ground and covered to protect from site construction damage, precipitation, sunlight (ultraviolet light), chemicals, open flames, sparks or other conditions which may damage the rolls.

PART 2 PRODUCTS

2.01 MATERIALS

- A. Straw Wattles
 - 1. Machine produced.
 - 2. Straw filled tubes of compacted straw of rice, wheat or barley.
 - 3. Straw wattles to be certified as weed free.
 - 4. Netting for tubes to be seamless, high density polyethylene with ultra violet inhibitors.
 - 5. Roll length to be 10.0 feet to 25.0 feet.
 - 6. Weight per linear foot,
 - a. 12-inch: 2.5 lbs. minimum
 - b. 9-inch: 1.5 lbs. minimum
 - 7. Stakes shall be wooden, 1 1/8-inch x 1 1/8-inch x 2.5 feet long, with lower ends tapered to facilitate driving into compacted soil. Rebar may be substituted for wooden stakes.

PART 3 EXECUTION

3.01 INSTALLATION

- A. Straw Wattles

1. Install at locations indicated on the Drawings or as directed by the Engineer.
2. Remove all rocks, vegetation or other obstructions at straw wattle location.
3. Excavate a trench approximately 2 to 3-inches deep to accept the straw wattle and place straw wattle in trench.
4. Anchor straw wattle with stakes placed a maximum of 4-feet apart.
5. The end stakes shall be placed 6-inches from the end of straw wattle and angled toward previously laid straw wattle to force straw wattles together.
6. Refer to detail on Drawings for additional installation requirements.

3.02 MAINTENANCE

1. Maintain straw wattles throughout the duration of the project.
 - a. Damaged or displaced straw wattles shall be replaced by the Contractor at no additional cost to the Owner.
2. Remove sediments when depths accumulate to 50% of the depth of the straw wattle height, or as necessary.

3.03 REMOVAL AT PROJECT COMPLETION

- A. Remove all sediment collected by the straw wattle, remove the straw wattle, and restore the area to pre-construction condition to the satisfaction of the Engineer.

END OF SECTION

SECTION 02500

PAVEMENT

PART 1 GENERAL

1.01 SUMMARY

A. Section Includes

1. Requirements for construction of all temporary and permanent pavement on paved areas affected or damaged by the Contractors operations, whether inside or outside the normal trench limits, as indicated on the Drawings and as herein specified.

B. Related Sections

1. Section 02200 - Earth Excavation, Backfill, Fill and Grading

1.02 REFERENCES

- ###### A. This specification makes reference to the requirements of additional specifications as listed. The Contractor shall obtain and familiarize himself with all requirements referenced by this specification prior to preparation and installation of any pavements.

1. The Massachusetts Department of Transportation, Highway Division, Standard Specifications for Highways and Bridges, dated 1988, together with all errata addenda additional revisions, and supplemental specifications, all of which are hereinafter referred to as the MassDOT Standard Specifications.

1.03 PAVEMENT SCHEDULE

- ###### A. The Contractors attention is directed to the various pavements required under this contract, and their locations as detailed below.

- ###### B. All pavement thickness specified in this specification shall be of the thickness required after compaction.

1. Location: *Pumping Station Drive Way*
Type: Flexible - 4"
Requirements: 16" Dense Graded/Gravel Sub-base Course
2" Bituminous Binder
2" Bituminous Surface

2. Location: *City Roads (Curb to Curb)*
Type: Flexible - 6"
Requirements: 16" Dense Graded/Gravel Sub-base Course
4" Bituminous Binder
2" Bituminous Surface

PRODUCTS

1.04 MATERIALS

A. Asphalt Tack

1. Tack coat shall consist of emulsified asphalt, grade RS-1 or cutback asphalt, conforming to the requirements of the MassDOT Standard Specification Section M3.11.06.

B. Bituminous Base

1. Bituminous Base shall conform to the requirements of the MassDOT Standard Specification Section 420 and M3.11.00 for Base Course.

C. Bituminous Binder Trench Width (Permanent Pavement)

1. Bituminous Binder Course shall conform to the requirements of the MassDOT Standard Specification Section 420 and M3.11.00 for Binder Course.

D. Bituminous Surface, Trench Width (Permanent Pavement)

1. Bituminous Surface Course shall conform to the requirements of the MassDOT Standard Specification Section 460 and M3.11.00 for surface course Class I-1.

E. Bituminous Surface, Curb to Curb

1. Bituminous Surface Course shall conform to the requirements of the MassDOT Standard Specification Section 460 and M3.11.00 for surface course Class I-1.

F. Reinforced Concrete Base

1. Concrete Base shall conform to the requirements of the MassDOT Standard Specification, Section 430.

G. Bituminous Binder Trench Width (Temporary Pavement)

1. Temporary Pavement shall be Binder Course conforming to the requirements of the MassDOT Standard Specification Section 420 and M3.11.00 for Binder Course.

H. Dense-Graded Crushed Stone Sub-base Course (Temporary and Permanent)

1. The dense graded crushed stone sub-base course shall consist of coarse aggregates of crushed stone or gravel and fine aggregates of natural sand or stone screenings. Uniformly pre-mixed with a predetermined quantity of water and placed on the sub-base in close conformity with the lines and grades shown on the Contract Documents or established by the Engineer.
2. Coarse aggregate shall consist of hard, durable particles of fragments of stone. Materials that break up when alternately frozen and thawed or wetted and dried shall not be used.
3. Coarse aggregate shall have a percentage of wear, by the Los Angeles Abrasion Test (AASSTO-T-96) of not more than 45.
4. Fine aggregate shall consist of natural or processed sand.
5. The composite material shall be free from clay, loam or other cohesive soil, and shall conform to the following grading requirements:

Sieve Designation Mesh Sieves	Percentage by Weight Passing Square
2 in.	100
1-1/2 in.	70-100

3/4 in.	50-85
No. 4	30-55
No. 50	8-24
No. 200	3-10

6. Sampling and testing shall be in accordance with the following standard AASHTO methods:

Sieve Analysis	T27
Passing No. 200 Sieve	T11

7. The dense-graded crushed stone sub-base course shall be spread and compacted in layers not to exceed 4 inches in compacted depth, to the same tolerances specified below for the gravel sub-base.
8. The dense-graded crushed stone sub-base course material shall meet the same requirements as specified in MassDOT Specification M2.01.7 except as noted above.

I. Gravel Sub-Base Course

1. The gravel sub-base course shall consist of Gravel Borrow Type b, (3-inches largest dimension) as specified in MassDOT Standard Specification Section M1.03.0
2. The gravel sub-base shall be spread and compacted in one layer, 8 inches in depth compacted measurement, to not less than 95 percent of the maximum dry density of the material, as determined by the Standard AASHTO Test Designation T99 compaction test Method C within 5% of optimum moisture content as determined by the Engineer. If the material retained on the #4 sieve is 50% or more of the total sample, this test shall not apply and the material shall be compacted to the satisfaction of the Engineer. The specific density of the Gravel Sub-base shall be maintained by determining the number of passes of a roller required to produce a constant and uniform density, after conducting a series of tests either using the sand/volume or the nuclear density-testing device.
3. Any stone with a dimension greater than 3 inches shall be removed from the sub-base before the gravel is compacted. Compaction shall continue until the surface is even and true to the proposed lines and grades within a tolerance of 1/2-inch above or below the required cross sectional elevations and to a maximum irregularity not exceeding 1/2 inch under a 10 foot line longitudinally. Any specific area a gravel sub-base which, after being rolled, does not form a satisfactory, solid, stable foundation shall be removed, replaced and recompactd by the Contractor without additional compensation.

1.05 SOURCE QUALITY CONTROL

- A. The paving plant used by the Contractor for preparation of bituminous paving materials shall be acceptable to the Engineer who shall have the right to inspect the plant and the making of the material as specified in MassDOT Specification M2.01.7 except as noted above.

PART 2 EXECUTION

2.01 PREPARATION

- A. Prior to placing pavement, all backfill shall have been properly compacted as specified under Section 02200 to eliminate settling of backfill. No pavement shall be placed over poorly compacted backfill. Backfill and gravel base course shall be compacted, brought to the

- proper elevation, and dressed so that new pavement construction shall be at the required grade. The Contractor shall maintain the surfaces of all excavated and disturbed areas until the pavement is placed. If there is a time lapse of more than 24 hours between completion of preparation of subgrade or placing of gravel base course and placing of paving, or if subgrade or gravel base course has been eroded or disturbed by traffic, the subgrade or gravel base course shall be restored before placing pavement.
- B. When installing permanent pavement on bituminous concrete roadway the edges of existing pavement shall be cut back 12-inches, or more as required, from the trench excavation wall or damaged area to sound undamaged material, straightened, cleaned, and painted with an accepted asphalt emulsion to ensure a satisfactory bond between it and the newly placed surface courses. Existing surface courses shall be stripped from the bituminous concrete base course for at least a 6-inch width and trimmed square and straight so that new permanent surfacing shall be placed on undisturbed bituminous concrete base course. Existing pavement shall be swept clean prior to placing any asphalt emulsion over it. Existing pavement that will be under new pavement shall be painted with asphalt emulsion to ensure a satisfactory bond.
 - C. Before permanent pavement is installed, the base shall be brought to the proper grade, and temporary pavement and excess gravel base shall be removed.
 - D. All manhole covers, catch basin grates, valve and meter boxes, curbs, walks, walls and fences shall be adequately protected and left in a clean condition. Where required, the grades of manhole covers, catch basin grates, valve boxes, and other similar items shall be adjusted to conform to the finished pavement grade.
 - E. The Contractor shall remove and acceptably dispose of all surplus and unsuitable material.

2.02 INSTALLATION

A. General

1. Unless indicated otherwise, all permanent bituminous pavement shall be installed in two courses or more. Bituminous base courses shall be carefully spread and raked to a uniform surface and thoroughly rolled before application of the top course.
2. All top courses of permanent paving shall be applied with acceptable mechanical spreaders in widths of at least 9 feet.
3. The rolling for all bituminous and gravel base courses shall conform to the standards listed in the appropriate Subsection of the Standard Specification.
4. Pavement shall be placed so that the entire roadway or paved area shall have a true and uniform surface, and the pavement shall conform to the proper grade and cross section with a smooth transition to existing pavement.

B. Dense Graded Crushed Stone Base Course

1. The base course shall be placed to such depth that the furnished compacted base course is the depth as indicated on the Contract Drawings and specified herein.
2. The top of the base course shall be below the furnish grade a distance required to accommodate the compacted pavement material as indicated on the Contract Drawings and specified herein.
3. The base course as herein specified shall be 18-inches thick for flexible pavement and 6-inches thick for rigid pavement.

C. Temporary Pavement

1. Temporary pavement shall be placed over all trenches in paved areas where directed by the Engineer.
2. The Contractor, upon completing the backfilling and compaction of the trenches in the streets and the placing of the gravel base courses, shall be required to construct temporary pavement unless otherwise directed by the Engineer.
3. Temporary Pavement in Town or City roads shall be placed in one course and shall consist of 2-inch compacted thickness of hot bituminous mix, on a 12-inch compacted thickness gravel base as directed by the Engineer.
4. Temporary Pavement in State roads shall be placed in one course and shall consist of 3-inch compacted thickness of hot bituminous mix, on a 18-inch compacted thickness gravel base as directed by the Engineer.
5. The Contractor shall maintain temporary pavement in good repair and flush with the existing pavement at all times until the permanent pavement is placed.
6. The temporary pavement shall not be removed until 60 days after installation or until such time that the Engineer authorizes the placement of permanent pavement at an earlier time.

D. Bituminous Base:

1. Bituminous Base shall be used in city streets and parking areas as listed in Article 1.03 of this specification.
2. Bituminous Base shall be placed to the thickness as indicated in Article 1.03 of this Specification and installed in accordance with the requirements of the MassDOT Standard Specification and as detailed in the Contract Drawings.
3. Prior to placing bituminous base, all temporary pavement and sufficient gravel base course shall be removed, to proper depths as detailed in the Contract Drawings.

E. Reinforced Concrete Base:

1. Reinforced Concrete Base shall be used in the streets as listed in Article 1.03 of this specification.
2. Reinforced Concrete Base shall be 8-inch thick and installed in accordance with the requirements of the MassDOT Standard Specification.
3. Prior to placing reinforced concrete base, all temporary pavement and sufficient gravel base course shall be removed, to proper depths as detailed in the Contract Drawings.

F. Bituminous Binder

1. Bituminous Binder shall be used in the streets as listed in Article 1.03 of this specification.
2. Bituminous Binder shall be placed to the thickness as indicated in Article 1.03 of this Specification and installed in accordance with the requirements of the MassDOT Standard Specification and as detailed in the Contract Drawings.

G. Bituminous Surface

1. Bituminous Surface shall be used in the streets as listed in Article 1.03 of this specification.
2. Bituminous Surface shall be placed to the thickness as indicated in Article 1.03 of this Specification and installed in accordance with the requirements of the MassDOT Standard Specification and as detailed in the Contract Drawings.

H. Sidewalks, Driveways, Parking Lots and Curbing

1. Sidewalks, driveways, parking lots and curbing that are removed or damaged by the Contractor's operations shall be restored to a condition at least equal to that in which they are found immediately prior to the start of operations. Materials and methods used for such restoration shall be in conformance with the requirements of the MassDOT Standard Specification.
2. Where the trench location is in a sidewalk, the entire width of the sidewalk shall be replaced with new material. Side forms shall be set so as to obtain and preserve a straight edge along both sides of the walk.
3. Where trench is in a driveway, the driveway shall be repaved across its entire width with even edges.
4. Parking lots shall be repaved in accordance with Article 3.01 of this section.
5. Gravel base course under sidewalks and driveways shall not be less than 16 inches thick.

I. Surface Maintenance

1. During the guarantee period, the Contractor shall maintain the bituminous surface and shall promptly make good all defects such as cracks, depressions, and holes that may occur. At all times, the surfacing shall be kept in a safe and satisfactory condition for traffic. If defects occur in surfacing constructed by the Contractor, the Contractor shall remove all bituminous concrete and base course as is necessary to properly correct the defect. After removing bituminous concrete and base course, the Contractor shall correct the cause of the defect and replace the base course and bituminous concrete in accordance with these specifications.

END OF SECTION

SECTION 02618

DUCTILE-IRON PIPE AND FITTINGS FOR BURIED SERVICE

PART 1 GENERAL

1.01 SECTION INCLUDES

- A. Requirements to furnish, lay, joint, and test ductile-iron pressure pipe, fittings (including special castings), and appurtenant materials and equipment indicated on the Drawings and specified in this Section.

1.02 REFERENCES

- A. American Water Works Association (AWWA)/American National Standards Institute (ANSI)
 - 1. C104/A21.4, Cement-Mortar Lining for Ductile-Iron Pipe and Fittings for Water.
 - 2. C105/A21.5, Polyethylene Encasement for Ductile Iron Pipe Systems
 - 3. C110/A21.10, Ductile-Iron and Gray-Iron Fittings, 3-inch. through 48-inch., for Water and Other Liquids.
 - 4. C111/A21.11, Rubber-Gasket Joints for Ductile-Iron and Pressure Pipe and Fittings.
 - 5. C116, Protective Fusion Bonded Epoxy Coatings for the Interior and Exterior Surfaces of Ductile-Iron and Gray-Iron Fittings for Water Supply Service
 - 6. C150/A21.50, Thickness Design of Ductile-Iron Pipe.
 - 7. C151/A21.51, Ductile-Iron Pipe, Centrifugally Cast for Water.
 - 8. C153/A21.53, Ductile-Iron Compact Fittings, 3 inches through 64 inches for Water Service
 - 9. C219, Bolted, Sleeve-Type Couplings for Plain-End Pipe
 - 10. C600, Installation of Ductile-Iron Water Mains and Their Appurtenances
 - 11. C651, Disinfecting Water Mains
- B. American Society of Testing and Materials (ASTM)
 - 1. A536, Standard Specification for Ductile Iron Castings

1.03 SUBMITTALS

- A. In accordance with SECTION 01300 submit the following:
- B. Shop Drawings
 - 1. Piping layouts in full detail.
 - 2. Location and type of backup block or device to prevent separation.
 - 3. Schedules of all pipe, fittings, special castings, couplings, expansion joints, restrained joints and other appurtenances.
 - 4. Detailed disinfection plan consistent with AWWA C651.
- C. Certificates
 - 1. **Ductile Iron pipe and fittings shall be produced in the United States in accordance with the American Iron and Steel requirements of P.L. 113-76, the Consolidated Appropriations Act of 2014.**

2. Sworn certificates of shop tests showing compliance with appropriate standard.
- D. Manufacturer's Literature
1. Catalog cuts of joints, couplings, harnesses, expansion joints, restrained joints gaskets, fasteners and other accessories.
 2. Brochures and technical data of coatings and lining's and proposed method of application.

1.04 QUALITY ASSURANCE

- A. Pipe and fittings to be inspected and tested at the foundry as required according to ANSI Standards.
- B. Owner reserves right to inspect and/or test by independent service at manufacturer's plant or elsewhere at his own expense.
- C. Owner reserves right to perform visual and hammer test prior to installation.

PART 2 PRODUCTS

2.01 PIPE

- A. Ductile-Iron Pipe
 1. Designed in accordance with AWWA/ANSI C150/ A21.50.
 - a. Ductile iron pipe used for sewer force mains and water mains shall be cement lined thickness class 52 push-on or mechanical joint, size as indicated on the Drawings.
 - b. For sewer pipeline use a minimum thickness class 52 ductile iron pipe. **Gravity sanitary sewer pipe lines and fittings shall be ductile iron pipe lined with a ceramic-filled amine-cured epoxy, Protecto 401 by Indurall.** The lining thickness shall be 40 mils minimum. Application shall be performed by an applicator approved by the coating manufacturer, in accordance with manufacturer's instructions and under controlled conditions at the applicator's shop or the pipe manufacturer's plant. Applicator shall submit a certified affidavit of compliance with manufacturer's instructions and requirements specified herein.
 2. Manufactured in accordance with AWWA/ANSI C151/A21.51.
 - a. Unless otherwise indicated or specified, ductile-iron pipe shall be at least thickness Class 52
- B. Pipe For Use With Couplings
 1. As specified above except that the ends shall be plain (without bells or beads) cast or machined at right angles to the axis.

2.02 FITTINGS

- A. General
 1. Push-on or mechanical-joint fittings shall be all-bell fittings unless otherwise indicated or specified.
 2. Compact fittings in accordance with AWWA/ANSI C153/A21.53 and shall have a working pressure rating of 350 psi

- B. Nuts and Bolts
 - 1. Ductile Iron or Kor-10 steel T bolts and nuts or approved equal.
- C. Nonstandard Fittings
 - 1. Fittings having nonstandard dimensions and cast especially for this project shall be of acceptable design.
 - 2. Manufactured to meet the requirements of these specifications and shall have the same diameter and thickness as standard fittings, but their laying lengths and types of ends shall be determined by their positions in the pipelines and by the particular piping to which they connect.

2.03 ADAPTERS

- A. Where it is necessary to joint pipes of different type, furnish and install the necessary adapters unless solid sleeves are indicated on the drawings or permitted. Adapters shall have ends, conforming to the above specifications for the appropriate type of joint, to receive the adjoining pipe. Adapters joining two classes of pipe may be of the lighter class provided that the annular space in bell-and-spigot type joints will be sufficient for proper jointing.

2.04 JOINTS

- A. Push-On and Mechanical
 - 1. In accordance with AWWA/ANSI C111/A21.11.
 - 2. The plain end of push-on pipe shall be factory machined to a true circle and chamfered to facilitate fitting the gasket.
 - 3. Push-on and mechanical-joint pipe and fittings shall be provided with sufficient quantities of accessories conforming to AWWA/ANSI C111/A21.11.
- B. Restrained
 - 1. Location of restrained joints shall be based on Thrust Restraint Design for Ductile Iron Pipe (Second Edition), published by Ductile Iron Pipe Research Association.
 - 2. Restraining glands will be required on all fittings.
 - 3. Pipe, fittings and appurtenances for restrained joints shall be in accordance with AWWA/ANSI C153/A21.53. Only restraining glands which impart multiple wedging action against the pipe increasing its pressure as the pipe pressure increases will be allowed. Flexibility of the joint shall be maintained after burial. Glands shall be manufactured of ductile iron conforming to ASTM A536. Twist off nuts shall be used to insure proper actuating of the restraining device.
 - 4. Mechanical joint restraint shall have a working pressure rating of at least 250 psi.
 - 5. Manufactured by EBAA Iron, Inc., Eastland, Texas, or equal.
- C. Gaskets
 - 1. Force main and water main gaskets shall be of a composition suitable for exposure to the product which the pipe is intended.
 - 2. Gravity sewer main gaskets shall have flouroelastomer (FKM) gaskets, such as Viton gaskets, as manufactured by DuPont, or an acceptable equivalent.

2.05 COUPLINGS

A. Flexible Connections

1. Where flexible connections in the piping are specified or indicated on the drawings, they shall be obtained by the use of sleeve-type couplings, split couplings, or mechanical-joint pipe and/or fittings as herein specified.

B. Sleeve Type Couplings

1. Pressure rating at least equal to that of the pipeline in which they are to be installed.
2. For sizes 2 1/2 to 16-inch diameter, up to 250 psi working pressure:
 - a. Provide style 442 Long Sleeve, Cast Coupling by Smith Blair, Inc., Texarkana, Texas, or be acceptable equivalent products.
3. For sizes greater than 16-inch diameter, up to 150 psi working pressure:
 - a. Provide style 411, with 10-inch long sleeve minimum, Steel Coupling by Smith Blair, Inc., Texarkana, Texas, or be acceptable equivalent products.
4. Nuts and Bolts to be high strength, low alloy steel, unless noted otherwise.
5. Provided with gaskets of a composition suitable for exposure to the liquid within the pipe.
6. Provide with fusion bonded epoxy finish.
7. Conform to requirements of AWWA C219.

C. Solid Sleeve Couplings

1. Solid sleeve couplings and accessories shall be of a pressure rating at least equal to that of the pipeline in which they are to be installed.
2. Couplings shall be ductile iron with gaskets of a composition suitable for exposure to the liquid within the pipe.

2.06 ACCESSORIES

A. Tapped Connections

1. Tapped connections in pipe and fittings shall be made in such manner as to provide a watertight joint and adequate strength against pullout. The maximum size of taps in pipe or fittings without bosses shall not exceed the listed size in the appropriate table of the Appendix to the above-mentioned ANS A21.51 based on 3 full threads for cast iron and 2 full threads for ductile iron.
2. Where the size of the connections exceeds that given above for the pipe in question, a boss shall be provided on the pipe barrel, the tap shall be made in the flat part of the intersection of the run and branch of a tee or cross, or the connection shall be made by means of a tapped tee, branch fitting and tapped plug or reducing flange, or tapping tee and tapping valve, all as indicated or permitted by the Engineer.
3. All drilling and tapping of cast-iron pipe shall be done normal to the longitudinal axis of the pipe; fitting shall be drilled and tapped similarly, as appropriate. Drilling and tapping shall be done only by skilled mechanics. Tools shall be adapted to the work and in good condition so as to produce good, clean-cut threads of the correct size, pitch, and taper.

2.07 POLYETHYLENE ENCASEMENT

- A. In accordance with AWWA C105.

2.08 FINISHES

A. Lining

1. Inside of sewer force main and water main pipe and fittings shall be coated with double thickness cement lining and bituminous seal coat conforming to AWWA/ANSI C104/A21.4.
2. Ductile iron pipe and fittings for the influent sewer shall be lined with a ceramic-filled amine-cured epoxy, Protecto 401 by Indurall. The lining thickness shall be 40 mils minimum. Application shall be performed by an applicator approved by the coating manufacturer, in accordance with manufacturer's instructions and under controlled conditions at the applicator's shop or the pipe manufacturer's plant. Applicator shall submit a certified affidavit of compliance with manufacturer's instructions and requirements specified herein.

B. Coating

1. Outside of pipe and fittings shall be coated with the standard bituminous coating conforming to AWWA/ANSI C151/A21.51

PART 3 EXECUTION

3.01 HANDLING

A. Pipe and Fittings

1. Every care shall be taken in handling and laying pipe and fittings to avoid damaging the pipe, scratching or marring machined surfaces, and abrasion of the pipe coatings.
2. Any fitting showing a crack and any pipe or fitting which has received a severe blow that may have caused an incipient fracture, even though no such fracture can be seen, shall be marked as rejected and removed at once from the Work.
3. In any pipe showing a distinct crack and in which it is believed there is no incipient fracture beyond the limits of the visible crack, the cracked portions, if so approved, may be cut off by and at the expense of the Contractor before the pipe is laid so that the pipe used is perfectly sound. The cut shall be made in the sound barrel at a point at least 12-inches from the visible limits of the crack.

3.02 CUTTING

A. Pipe

1. Except as otherwise approved, all cutting shall be done with a machine having rolling wheel cutters, knives, or saws adapted to the purpose. Hammer and chisel or so-called wheel span cutters shall not be used to cut pipe. All cut ends shall be examined for possible cracks caused by cutting.
2. Cut ends to be used with push-on joints shall be carefully chamfered to prevent cutting the gasket when the pipe is laid or installed.

3.03 INSTALLATION

A. Pipe and Fittings

1. No defective pipe or fittings shall be laid or placed in the piping, and any piece discovered to be defective after having been laid or placed shall be removed and replaced by a sound and satisfactory piece.

2. Each pipe and fitting shall be cleared of all debris, dirt, etc., before being laid and shall be kept clean until accepted in the complete work.
3. Pipe and fittings shall be laid accurately to the lines and grades indicated on the drawings or required. Care shall be taken to ensure a good alignment both horizontally and vertically.
4. Pipe shall have a firm bearing along its entire length. No pipe or fitting shall be permanently supported on saddles, blocking, or stones.
5. The deflection of alignment at a joint shall not exceed the appropriate permissible deflection as specified in the tabulation titled PIPE DEFLECTION ALLOWANCES.

PIPE DEFLECTION ALLOWANCES

Maximum permissible deflection, in.*

<u>Size of pipe, in.</u>	<u>push-on joint</u>	<u>Mechanical joint</u>
4	19	31
6	19	27
8	19	20
10	19	20
12	19	20
14	11	13-1/2
16	11	13-1/2
18	11	11
20	11	11
24	11	9
30	11	9
36	11	8
42	7-1/2	7-1/2
48	7-1/2	7-1/2
54	5-1/2	--

*Maximum permissible deflection for 18-ft. lengths; maximum permissible deflections for other lengths shall be in proportion of such lengths to 18 ft.

6. When mechanical joint, push-on joint or similar pipe is laid, the bell of the pipe shall be cleaned of excess tar or other obstructions and wiped out before the cleaned and prepared spigot of the next pipe is inserted into it. The new pipe shall be shoved firmly into place until properly seated and held securely until the joint has been completed.

B. Castings

1. Castings to be encased in masonry shall be accurately set with the bolt holes, if any, carefully aligned.
2. Immediately prior to being set, castings shall be thoroughly cleaned of all rust, scale and other foreign material.

C. Temporary Plugs

1. At all times when pipe laying is not actually in progress, the open ends of pipe shall be closed by temporary watertight plugs or by other approved means. If water is in the trench when work is resumed, the plug shall not be removed until all danger of water entering the pipe has passed.

D. Appurtenances

1. Valves, fittings and appurtenances shall be set and jointed as indicated on the drawings.

3.04 ASSEMBLING

A. Push-On Joints

1. Make up by inserting the gasket into the groove of the bell and applying a thin film of special nontoxic gasket lubricant uniformly over the inner surface of the gasket which will be in contact with the spigot end of the pipe.
2. The chamfered end of the plain pipe shall be inserted into the gasket and then forced past it until it seats against the bottom of the socket.

B. Bolted Joints

1. Before the pieces are assembled, rust-preventive coatings shall be removed from machined surfaces.
2. Pipe ends, sockets, sleeves, housings, and gaskets shall be thoroughly cleaned and all burrs and other defects shall be carefully smoothed.

C. Mechanical Joints

1. Surfaces against which the gasket will come in contact shall be thoroughly brushed with a wire brush prior to assembly of the joint. The gasket shall be cleaned. The gasket, bell, and spigot shall be lubricated by being washed with soapy water.
2. The gland and gasket, in that order, shall be slipped over the spigot, and the spigot shall be inserted into the bell until it is correctly seated.
3. The gasket shall then be seated evenly in the bell at all points, centering the spigot, and the gland shall be pressed firmly against the gasket.
4. After all bolts have been inserted and the nuts have been made up finger tight, diametrically opposite nuts shall be progressively and uniformly tightened all around the joint to the proper tension, preferably by means of a torque wrench.
5. The correct range of torque as indicated by a torque wrench and the length wrench (if not a torque wrench) used by an average man to produce such range of torque, shall not exceed the values specified in the tabulation titled TORQUE RANGE VALUES.

TORQUE RANGE VALUES

Nominal pipe size, <u>in. in.</u>	Bolt diameter, <u>ft.-lb.</u>	Range of torque, <u>in.</u>	Length of wrench,
3	5/8	40-60	8
4 thru 24	3/4	60-90	10
30, 36	1	70-100	12
42, 48	1-1/4	90-120	14

If the effective sealing of the joint is not attained at the maximum torque indicated above, the joint shall be disassembled and thoroughly cleaned, then reassembled. Bolts shall not be over stressed to tighten a leaking joint.

D. Restrained Joints

1. Install in accordance with manufacturers written instructions.
2. Do not exceed manufacturer's permissible pipe deflection allowance.

- E. Piping Restraint: Restrain all fittings and restrain all PVC piping according to the following table.

24 inch Nominal Pipe Diameter			
Horizontal Bends	11.25°	22.5°	45°
	Length of pipe needed to be restrained both sides (ft.)		
Upstream	8	15	31
Downstream	8	15	31
Vertical Bends	11.25°	22.5°	45°
	Length of pipe needed to be restrained both sides (ft.)		
Upstream	14	27	56
Downstream	14	27	56

Assumptions:

- 1) Pipe material is Ductile Iron
- 2) Soil type is Silty Sand (SM)
- 3) Safety Factor is 2 to 1
- 4) Trench Type 3
- 5) Minimum depth of pipe is at 5 feet below grade
- 6) The Test Pressure is at 200 psi
- 7) 90 degree elbows are not to be used in vertical bend situations due to extreme forces.

1. Should conditions vary from those presented in the assumptions, consult Engineer for direction.

E. Sleeve-Type Couplings

1. Prior to the installation of sleeve-type couplings, the pipe ends shall be cleaned thoroughly for a distance of 8-inches
2. Soapy water may be used as a gasket lubricant.
3. A follower and gasket, in that order, shall be slipped over each pipe to a distance of about 6-inches from the end, and the middle ring shall be placed on the already laid pipe end until it is properly centered over the joint.
4. The other pipe end shall be inserted into the middle ring and brought to proper position in relation to the pipe already laid.
5. The gaskets and followers shall then be pressed evenly and firmly into the middle ring flares.
6. After the bolts have been inserted and all nuts have been made up finger tight, diametrically opposite nuts shall be progressively and uniformly tightened all around the joint, preferably by use of a torque wrench of the appropriate size and torque for the bolts. The correct torque as indicated by a torque wrench shall not exceed the manufacturers recommended values
7. After assembly and inspection and before being backfilled, all exterior surfaces of buried sleeve-type couplings, including the middle and follower rings, bolts, and nuts, shall be thoroughly coated with an approved heavy-bodied bituminous mastic. Care shall be taken and appropriate devices used to ensure that the undersides, as well as the more readily accessible parts, are well coated.

3.05 POLYETHYLENE ENCASEMENT

- A. When required, install in accordance with AWWA C105.

3.06 SOCKET PIPE CLAMPS, TIE RODS AND BRIDLES

- A. Where indicated or necessary to prevent joints or sleeve couplings from pulling apart under pressure, suitable pipe clamps, tie rods or bridles shall be provided. Bridles and tie rods shall be at least 3/4 in. diameter except where they replace flange bolts of smaller size, in which case they shall be fitted with a nut on each side of the pair of flanges. The socket clamps, tie rods or bridles shall be coated with an approved bituminous paint after assembly or if necessary, prior to assembly.

3.07 PIPING SUPPORT (THRUST BLOCK)

- A. Where necessary, bends, tees, and other fittings in pipelines buried in the ground may be backed up with 3000 psi concrete placed against undisturbed earth where firm support can be obtained. If the soil does not provide firm support, then restraining devices shall be provided.

3.08 CLEANING

- A. Prior to the pressure and leakage tests, thoroughly clean piping of all dirt, dust, oil, grease and other foreign material. This work shall be done with care to avoid damage to linings and coatings.

3.09 TESTING

- A. Except as otherwise directed, pipelines shall be given combined pressure and leakage tests in sections of approved length.
 - 1. Provide 24 hour notice to Engineer for all testing
 - 2. The Contractor shall make arrangements for procuring water for testing and be responsible for all associated fees.
- B. Furnish and install suitable temporary testing plugs or caps; all necessary pressure pumps, pipe connections, meters, gages, relief valves, other necessary equipment; and all labor required.
- C. Subject to approval and provided that the tests are made within a reasonable time considering the progress of the project as a whole, and the need to put the section into service, the Contractor may make the tests when he desires.
- D. However, pipelines to be embedded in concrete shall be tested prior to placing of the concrete and exposed piping shall be tested prior to field painting.
- E. Unless it has already been done, the section of pipe to be tested shall be filled with water of approved quality, and all air shall be expelled from the pipe. If hydrants or blow offs are not available at high points for releasing air the Contractor shall make the necessary excavations and do the necessary backfilling and make the necessary taps. After completion of the tests, if directed by the Engineer, remove corporations and plug said holes.
- F. The section under test shall be maintained full of water for a period of 24 hours prior to the combined pressure and leakage test being applied.

- G. The pressure and leakage test shall consist of first raising the water pressure (based on the elevation of the lowest point of the section under test and corrected to the gage location) to a pressure in pounds per square inch numerically equal to the pressure rating of the pipe but not to exceed 200 psi. Do not apply this pressure to items of equipment known to be incapable of withstanding such pressure.
- H. If the Contractor cannot achieve the specified pressure and maintain it for a period of two hour with no additional pumping, the section shall be considered as having failed to pass the test. Allowable leakage over the two hour period shall be calculated per AWWA C-600 as summarized in the following table.

Hydrostatic Testing Allowance per 1,000 ft. of Pipe
(Loss in U.S. Gallons Following a 2 Hour Test)

Avg. Pipe Press. (psi)	Nominal Pipe Diameter					
	6 in.	8 in.	12 in.	16 in.	24 in.	36 in.
150	1.10	1.48	2.20	2.94	4.42	6.61
175	1.18	1.60	1.38	3.18	4.76	7.16
200	1.28	1.70	2.56	3.40	5.10	7.64

- I. If the section fails to pass the pressure and leakage test, the Contractor shall do everything necessary to locate, uncover, and repair or replace the defective pipe, fitting, or joint, all at his own expense and without extension of time for completion of the work. Additional tests and repairs shall be made until the section passes the specified test and is considered acceptable by the Engineer.
- J. If, in the judgment of the Engineer, it is impracticable to follow the foregoing procedure exactly for any reason, modifications in the procedure may be made as required and approved by the Engineer, but in any event the Contractor shall be fully responsible for the ultimate tightness of the line within the above leakage and pressure requirement.
- K. All testing to be witnessed by the Engineer.

3.10 DISINFECTING AND FLUSHING

- A. The Contractor shall disinfect the lines carrying potable water.
- B. Furnish all equipment and materials necessary to do the work of disinfecting, and shall perform the work in accordance with the procedure outlined in the AWWA Standard C651 except as otherwise specified herein.
- C. During the disinfection period, care shall be exercised to prevent contamination of water in existing mains.
- D. The dosage shall be such as to produce a chlorine concentration of not less than 10 PPM (mg/l) after a contact time of not less than 24 hours.
- E. After treatment, the main shall be flushed with clean water until the residual chlorine content does not exceed 0.2 PPM (mg/l).

- F. Before disposing of the water used in disinfecting and flushing water mains thoroughly neutralize it through the application of a reducing agent, as referenced in AWWA C651.
- G. Dispose of the water used in disinfecting and flushing in an approved manner.
- H. Connection at cut ins shall be swabbed with 50 PPM solution of chlorine at locations when above methods are not possible.
- I. Bacteriological sampling and testing shall be done in accordance with AWWA C651 for each main and each branch. Sampling shall be accomplished with sterile bottles treated with sodium thiosulfate, as required by Standard Methods. No hose or fire hydrants shall be used in collection of samples. A corporation stop installed on the main, with a removable copper tube gooseneck assembly, is the recommended method.
- J. Testing shall be done by a laboratory approved by the Engineer, in accordance with Standard Methods, and shall show the absence of coliform organisms. A standard plate count may be required at the option of the Engineer.

3.11 CONNECTION TO EXISTING WATER MAINS

- A. In general, connection to existing water mains will not be allowed prior to the new water main successfully passing pressure and bacteria tests that can be verified with written confirmation. Any exception to this requirement will be at the sole discretion of the Engineer and/or Owner.

END OF SECTION

(THIS PAGE INTENTIONALLY LEFT BLANK)

SECTION 02629

UNDERGROUND UTILITY MARKING TAPE

GENERAL

1.01 SECTION INCLUDES

- A. Requirements for furnishing and installing metallic (detectable) and non-metallic (non-detectable) marking tape over buried pipelines and conduits.

1.02 REFERENCES

- A. A.P.W.A. - American Public Works Association

1.03 SUBMITTALS

- A. Shop Drawings
 - 1. Submit in accordance with SECTION 01300 - SUBMITTALS
- B. Samples
 - 1. Provide samples of submitted products.

1.04 DESCRIPTION

- A. General
 - 1. Marking tape to be installed over all pipe lines and conduits installed under this Contract.
 - 2. Marking tape for non-ferrous pipe or conduits to be Detectable, magnetic type.
 - 3. Marking tape for ferrous pipe or conduits to be Non-detectable, non-magnetic type.
 - 4. Tape to be 6-inches wide.

PART 2 PRODUCTS

2.01 MANUFACTURERS

- A. Underground utility marking tape to be:
 - 1. Detectable: Magnatec by THOR Enterprises, Inc., Sun Prairie, WI.
 - 2. Non-detectable: Shieldtec by THOR Enterprises, Inc., Sun Prairie, WI.
 - 3. Or product deemed equal by the Engineer.

2.02 MATERIALS

- A. Detectable Underground Utility marking Tape
 - 1. Minimum overall thickness: 5.0 mil (0.005”).
 - 2. Aluminum foil core: 35 gauge (0.00035”) minimum.
 - 3. Foil visible from both sides of tape.
 - 4. Protective plastic jacket applied to both sides of foil.
 - 5. Jacket adhesive applied directly to the film and foil.
 - 6. No printing to extend to the edges of the tape.

7. No Dilutants, pigments or contaminants in the adhesive.
 8. Adhesive formulated to resist degradation by elements normally found in soil.
- B. Non-detectable Underground Utility marking Tape
1. Minimum overall thickness: 4.0 mil (0.004”).
 2. Polyethylene plastic film: 100% virgin, low density acid and alkali-resistant.
 3. Printing: Permanent, black, environmentally safe.
 4. Coloring: color-fast, lead free, organic pigments suitable for direct burial and prolonged exposure to the elements normally found in soil.
- C. Marking
1. Tape to printed with “BURIED *UTILITY* LINE BELOW”, replacing the word “*UTILITY*” with the word “WATER”, “SEWER”, “DRAIN”, “ELECTRIC”, “GAS”, or otherwise appropriate, repeating continuously every 30-inches max.
- D. Color Code in accordance with A.P.W.A. Standards as follows:
- | | |
|----------------------------------|---|
| 1. Safety Red | Electric power and high voltage lines |
| 2. High Visibility Safety Yellow | Gas and oil distribution/Transmission |
| | Dangerous materials/Steam |
| 3. Safety Alert Orange | Fiber optic/telephone/CATV |
| 4. Safety Precaution Blue | Water and irrigation lines |
| 5. Safety Green | Sewer/storm/sanitary systems, non-potable water |
| 6. Safety Brown | Force mains and effluent lines |
| 7. Alert Purple | Reclaimed and effluent re-use lines |

PART 3 EXECUTION

3.01 INSTALLATION

- A. Install marking tape directly above the pipe line or conduit tape is to identify, approximately, 24-inches below the proposed finished grade.
- B. Install marking tape in accordance with manufacturers recommendations.
- C. Install marking tape over existing utilities disturbed by the Contractors operation.

END OF SECTION

SECTION 02642

WATER SERVICE CONNECTIONS

PART 1 GENERAL

1.01 SECTION INCLUDES

- A. Requirements for furnishing and installing potable water service connections.

1.02 SUBMITTALS

A. Shop Drawings

- 1. In accordance with Section 01300, submit manufacturer's specifications, catalog data, descriptive literature, illustrations, diagrams, etc.

1.03 REFERENCES

A. American Water Works Association (ANSI/AWWA)

- 1. ANSI/AWWA C800, Underground Service Line Valves and Fittings.

B. American Society for Testing and Materials (ASTM)

- 1. ASTM B88 – Standard Specification for Seamless Copper Water Tube.

PART 2 PRODUCTS

2.01 SERVICE CONNECTIONS

- A. All domestic water services 2-inch or less in diameter shall be replaced with Type K soft copper tubing, 1-inch minimum diameter or as indicated on Contract Drawings or as indicated on Contract Drawings, conforming to ASTM B-88-49, and have valve box installed and a new curb stop.

- B. Plastic services, as approved by the City, shall be polyethylene manufactured of PE3408 materials as defined in ASTM D3350. Polyethylene shall be blue plastic with a pressure class of 200 PSI. Dimensional and performance characteristics shall conform to the requirements of AWWA C901.

- C. 4-inch and larger services to be Cement Lined Ductile Iron, Class 52.

2.02 CURB STOPS

- A. Curb stops shall be a minimum of 1-inch, lead free brass manufactured by Mueller or approved equal.

- B. Ball valve type, ends as required to suit type of pipe or tubing to be connected, and a combined cap and tee handle and shall open **RIGHT** (clockwise) and a drain shall not be allowed.

2.03 CORPORATION STOPS

- A. Lead free brass manufactured by Mueller, or approved equal.
- B. Corporations for 1-inch installation shall be heavy pattern, solid plug, easy turning. The inlet shall be an AWWA (CC) thread.
- C. The 1 ½-inch and 2-inch corporations shall be of a ball valve type which incorporates Teflon seats to assure self-centering of a Teflon coated bronze ball. The corporation shall be easy turning and non-binding with AWWA (CC) inlet thread.
- D. Corporations subject to a sustained hydraulic pressure of 200 PSI. All saddles for 1 ½ and 2-inch corporations shall have stainless steel straps
- E. Outlet connections shall be of the type required to suit the pipe or tubing connected.

2.04 LINE FITTINGS

- A. If required, shall be standard three-part unions conforming to AWWA C800.
- B. Lead free brass manufactured by Mueller, or approved equal.

2.05 SERVICE BOXES

- A. Services boxes shall be a two hole top with “WATER” cast into the top. Boxes shall be asphalt coated, cast iron, sliding type. Erie type or equal with a 1” diameter telescoping top pipe section.
- B. The shaft shall be 2 ½” inside diameter with extension rod.

2.06 SERVICE SADDLE

- A. DI Water Main Connections: Model 317, double strap style, manufactured by Smith Blair, Inc., Texarkana, TX.
- B. CI Water Main Connections: Model 331, double strap style, manufactured by Smith Blair, Inc., Texarkana, TX.

PART 3 EXECUTION

- A. Water service and fire service connections shall be replaced from the water main corporation stop to the new curb stop and connected to the existing service. Remove and replace existing curb stop, remove service pipe from old main, tap new main, install new corporation stop, install copper water service and fire service connection between new main and new installed curb stop.

- B. Service shall be maintained as continuously as possible, coordinate shut down with property owner.
- C. Services shall be flushed before activating to avoid meter clogging.
- D. Service connections shall be free from leaks and may be pressure tested through the water main as directed by the Engineer.
- E. The Engineer must inspect all service connections under normal water main pressure prior to backfilling of the service trench to inspect for leakage.

END OF SECTION

THIS PAGE INTENTIONALLY LEFT BLANK

SECTION 02769

DISPOSAL OF MATERIALS

PART 1 GENERAL

1.01 SECTION INCLUDES

- A. Requirements for disposal of materials resulting from the cleaning of sewer pipes.

1.02 SUBMITTALS

- A. In accordance with Specification Section 01300, submit the following
 1. Outline of the procedures proposed to accomplish the work.
 2. Include a detailed description of disposal methods and locations of disposal.

PART 2 PRODUCTS NOT USED

PART 3 EXECUTION

3.01 DISPOSAL PROCEDURES

- A. Material encountered in the cleaning of sewer lines and the existing wet well is considered "Special Waste" by **the Commonwealth of Massachusetts, Department of Environmental Protection (MADEP)**. The materials include sludge, sand, grit, debris, etc.
- B. The Contractor is required to test and dispose of any waste material removed from pipeline, manholes, etc. within the project area in accordance with State and Federal requirements. Testing of waste material will be at the Contractor's expense.
- C. The materials being removed from the pipelines and manholes during the cleaning process shall be deposited in such a manner as to not endanger the public, plant personnel or persons performing the work. Such debris deposits may be of such nature, high in biological organic contents, or chemically aggressive that they will require proper disposal in a safe, health risk free, environment. The Contractor shall contact the Owner and Engineer and all agencies having jurisdiction thereof, for approval of debris disposal methods and locations of disposal, prior to disposing of any or all debris removed from pipe cleaning methods. All solids or semi-solids resulting from the cleaning operations shall be removed and satisfactorily disposed of off-site at the Contractor's expense.
- D. Debris must be transported in a watertight vehicle. The Contractor must ensure that no water leaks from the vehicle in any manner during the transportation. The Contractor is solely responsible for any cleanup of debris on route to disposal at a licensed disposal facility. The Contractor is also responsible for the payment of any fines that are incurred as a result of any incident which occurs during the transportation and/or disposal of the contents of the vehicle.

- E. Disposal must be at a licensed facility that is regulated to accept and properly dispose of the debris that is normally expected to be in a wastewater collection system.

END OF SECTION

SECTION 02831

CHAIN LINK FENCES AND GATES

PART 1 GENERAL

1.01 SECTION INCLUDES

- A. Requirements to furnish and install the 10 foot high chain-link fence, gates, and accessories.

1.02 DESIGN REQUIREMENTS

- A. The fence shall be of the height indicated and shall have a top and bottom rail.
- B. Fence materials and installation shall meet or exceed the standards of the Chain Link Fence Manufacturers Institute, Columbia, MD., except as otherwise specified in this section; also fence materials shall meet or exceed Fed. Spec. RR-F-191G/GEN for Fencing, Wire and Post Metal (and Gates, Chain-link Fence Fabric, and Accessories), and shall conform to the ASTM Standards noted in this Specification.

1.03 RELATED SECTIONS

- A. Section 03300 - Cast-In-Place Concrete.

1.04 REFERENCES

- A. Fed. Spec. RR-F-191/1A, Type V, for Fencing, Wire and Post, Metal (Chain-link Fence Fabric).
- B. American Society for Testing and Materials
 1. A392, Specification for Zinc-Coated Steel Chain-Link Fence Fabric.
 2. F 626, Specification for Fencing Fittings
 3. F668, Standard Specification for Poly (Vinyl Chloride) (PVC)-Coated Steel Chain Link Fence Fabric.
 4. F669, Standard Specification for Strength Requirements of Metal Posts and Rails for Industrial Chain Link Fence.
 5. F900, Standard Specification for Industrial and Commercial Swing Gates.
 6. F934, Standard Specification for Standard Colors for Polymer Coated Chain Link Fence Materials.
 7. F1043, Specification for Strength and Protective Coatings on Metal Industrial Chain Link Fence Framework
 8. F1083, Specification for Pipe, Steel, Hot-Dipped Zinc-Coated (Galvanized) Welded, for Fence Structures.
 9. F1234, Protective Coatings on Steel Framework for Fences.
 10. F1664, Specification for Poly (Vinyl Chloride) (PVC)-Coated Steel Tension Wire Used with Chain Link Fence.

1.05 SUBMITTALS

- A. Shop Drawings, submit in accordance with SECTION 01300.
 - 1. Include detailed information, specifications, sizes and dimensions for all materials, accessories, and finishes.
- B. Samples
 - 1. Submit samples of the fencing materials to be used, in accordance with the requirements of SECTION 01300.
 - 2. Each sample shall be identified by mark or tag.
 - 3. Samples to include:
 - a. 2-inch length of each type of post.
 - b. 2-inch length of each type of brace and railing.
 - c. 2-inch length of framework for gates.
 - d. 2-inch length of diagonal truss brace.
 - e. 2-inch length of tension wire.
 - f. Each type of fitting used at terminal posts.
 - g. Fittings used at line posts.
 - h. Fittings for the gate leaf frame.
 - i. Gate hinge.
 - j. Gate latch.
 - k. Stretcher bar, 2-inch length.
 - l. Bolt and nut fastener.
 - m. Fence fabric, 2 weaves, 2 meshes long.
 - n. Tie.
 - o. Padlock with key and steel chain, 6-inch length.
 - 4. Accompanying the samples, the Contractor shall submit a written statement that samples submitted comply with the requirements of these Contract Documents.
 - 5. Samples shall be submitted for review at least 30 days prior to fence installation.
- C. Quality Control Submittals
 - 1. Manufacturer's recommended installation instructions.
 - 2. Evidence of Supplier and installer qualifications.

PART 2 PRODUCTS

2.01 GENERAL

- A. Match style, finish, and color of each fence component with that of other fence components.
- B. All fittings, post, fence and gate framework, and all accessories shall be galvanized steel, then coated with PVC.

2.02 CHAIN LINK FABRIC

- A. A. Vinyl-coated steel chain link fabric shall be No. 8 finished gauge, woven wire, to a uniform square mesh measuring $2\pm 1/8$ -inches between its parallel sides. Galvanized core wire shall be No. 9 gauge, of good commercial quality steel and shall be uniformly galvanized with a zinc-coat-weight of at least 0.30 oz per sq. ft. The galvanized wire shall

then be coated with a molecular bonding layer and a minimum 20 mil vinyl coating, continuously extrusion-bonded (not sprayed or dipped) by a thermal extrusion-bonding process to insure a dense and impervious covering, free of voids and having a smooth and lustrous appearance. Unbonded coatings are not acceptable. The vinyl coating shall not be capable of being stripped from the wire with wire strippers. The wire shall be vinyl-clad before weaving and shall be free and flexible at all joints. The bond shall exhibit equal or greater strength than the cohesive strength of the vinyl. All cut ends shall be coated with vinyl at the factory during the weaving process.

- B. Fabric shall measure 6 feet in height and be knuckled at top selvage and twisted and barbed at bottom selvage.
- C. Color of the PVC coating: Black, and shall match the color of the total fence system.

2.03 FENCE POSTS, RAILS AND BRACES

A. General

- 1. In accordance with ASTM F669, Heavy Industrial Fence.
- 2. Protective Coatings: Zinc Coating; ASTM F1234, Type A external and internal coating.
- 3. Color coating: ASTM F934, minimum 10 mils thickness of PVC over zinc coating to match color of chain link fabric.
- 4. All framework shall be SS-40 pipe.

B. Line Posts

- 1. 2.875 inch outside diameter steel pipe weighing not less than 4.64 lb. per ft.,

C. End, Corner, and Pull Posts

- 1. 4.00 inch outside diameter steel pipe weighing not less than 6.56 lb. per ft.,

D. Top and bottom railings and railings for top, middle and bottom braces between terminal posts and adjacent line posts.

- 1. 1 5/8 inch outside diameter steel pipe weighing not less than 1.84 lb. per ft.,

2.04 TENSION WIRE

- A. No. 7-gage, marcelled, coated steel wire conforming to ASTM A824 Type II Zinc coated Class 2, 1.20 oz/sf.

2.05 TIE WIRES

- A. 6 gage (outside diameter) galvanized steel wire for fastening fence fabric to line posts and rails.

2.06 STRETCHER BARS

- A. Flat bars with minimum cross section dimensions of not less than 3/16 inch by 3/4 inch.
- B. Not less than 2 inches shorter than height of the fabric with which they are to be used.

2.07 BANDS OR CLIPS

- A. Bar bends of not less than 11-gage sheet steel, $\frac{3}{4}$ inches wide for posts 4 inch OD or less and $\frac{7}{8}$ inches wide for posts greater than 4 inch OD, in accordance with ASTM F626, and bolted with $\frac{5}{16}$ inch diameter galvanized carriage bolts and nuts.

2.08 DIAGONAL TRUSS

- A. Use between terminal and adjacent line posts and for gate framework.
 - 1. $\frac{3}{8}$ inch diameter steel rod.

2.09 FITTINGS

- A. Malleable iron or pressed steel of suitable size to produce strong construction.
- B. Post Caps
 - 1. Accommodate passage of top rail.

2.10 GATES

- A. General
 - 1. In accordance with ASTM F900.
 - 2. Gate capable of being opened and closed easily by one person.
 - 3. Paint welded steel joints with zinc-based paint.
 - 4. Attach chain link fabric securely to gate frame at intervals not exceeding 15 inches.
- B. Gate posts for gate leaves up to and including 6 ft. wide.
 - 1. 2.875 inch outside diameter steel pipe weighing not less than 4.64 lb. per ft.,
 - 2. or 3.50 inch by 3.50 inch roll-formed, steel corner section weighing not less than 5.00 lb. per ft.
- C. Gate posts for gate leaves over 6 ft. up to and including 12 ft. wide.
 - 1. 4.00 inch outside diameter steel pipe weighing not less than 6.56 lb. per ft.,
- D. Gate Posts for gate leaves over 13 ft. wide and up to and including 18 ft. 6.625 in. outside diameter steel pipe weighing not less than 18.02 lb. per ft.
- E. Gate Leaf framework
 - 1. 2 inch outside diameter steel pipe weighing not less than 2.28 lb. per ft.
- F. Hinges
 - 1. Heavy pattern of adequate strength for the gate size.
 - 2. Large bearing surfaces for clamping or bolting in position.
- G. Gate Stops
 - 1. Mushroom type or flush plate with anchors, suitable for setting in concrete.
- H. Cantilever Sliding Gate

1. The cantilever sling gate shall be "freehanging" type, single leaf, and sized as shown on the Drawings. The gate manufacturer shall supply sliding gates of appropriate construction, which will be structurally stable and meeting the intended dimensions. The gate shall be manufactured by Anchor Fence/Master Halco Inc., Cyclone Fence, Page Fence, or approved equal.
2. The gate shall be provided with two roller truck assemblies, which operate within a combined track and top gate frame member. The roller truck assemblies shall provide vertical support and lateral movement control to insure alignment of the truck in the track. The roller truck assemblies shall be fastened to gate posts with 7/8-inch diameter ball bolts with 1/2-inch shank.
3. The gate frame shall be constructed of 2-inch square aluminum tubing alloy 6063-T6, weighing 0.94 lbs per linear foot, welded at the joints. The combined track and top frame member shall be extruded aluminum-sized per manufacturer's recommendations. The bottom frame member shall be 2-inch by 4-inch aluminum tubing weighting 1.71 pounds per linear foot.
4. Support posts for the cantilever slide gate shall be of 4-inch outside diameter, Schedule 40 steel pipe, ASTM A-120, as specified above.
5. Vertical uprights and diagonal truss rods shall be provided as necessary to insure rigidity of the gate frame and prevent sagging.
6. Appurtenant hardware including roller guide assemblies for each support post, latch assembly with provisions for padlocking, and gate stop assembly shall be provided.

I. Locking Mechanism

1. Provide with a suitable latch accessible from both sides and with provision for padlocking.
2. Double leaf swing gates shall have a center bolt, center stop, and automatic backstops to hold leaves in open position.
3. Padlocks
 - a. Solid brass cases.
 - b. Hardened steel shackles.
 - c. Removable core cylinders.
 - d. Galvanized steel chains attached to the shackle by a clevis.
 - e. Padlocks shall be manufactured by Eaton Corp Lock & Hardware Div., Yale Marketing Dept., Charlotte, N.C.; & P&F. Corbin, Div. of Emhart Corp., Berlin, Conn.; Best Universal Lock Co., Inc., Indianapolis, Ind.; or be an acceptable equivalent product.
 - f. Padlocks shall be furnished with four keys each.

2.11 FOUNDATIONS

- A. Concrete for post foundation bases shall be in accordance with SECTION 03300.
- B. Grout for posts set in solid rock shall consist of one part Portland cement and three parts of clean, sharp, well-graded sand with just enough water for proper workability.

PART 3 EXECUTION

3.01 GENERAL

- A. The fence and gates shall be erected by skilled mechanics.
- B. Any change in direction of the fence line of 30 degrees or more shall be considered corners. Pull posts shall be used at any abrupt change in grade.
- C. Maximum area of unbraced fence shall not exceed 1,500 square feet.
- D. Terminal posts shall be braced to adjacent posts with horizontal brace rails and diagonal truss rods brought to proper tension so that posts are plumb.
- E. There shall be no loose connections or sloppy fits in the fence framework. The fence framework shall withstand all wind and other forces due to the weather.

3.02 POST SETTING

- A. Post spacing shall uniform with maximum spacing of 10 ft. in fences erected along straight lines. All posts shall be placed plumb and centered in the concrete foundations.
- B. Post foundations in earth shall be concrete cylinders with a minimum diameter of 12 inches, crowned at grade to shed water, and shall not be less than 36 inches deep in the ground. Posts shall be set in the full depth of the foundations except for 3 inch of concrete under the posts.
- C. Coat portion of galvanized or aluminum-coated steel post that will be embedded in concrete with Bitumastic Super Service Black, manufactured by the Koppers Co.; 450 Heavy Themecol, manufactured by Tnemec Co., North Kansas City, MO; or an acceptable equivalent product. Extend coating to 1-inch above top of finished concrete.
- D. If foundation holes are excavated in peat or other unstable soil, the Engineer shall be notified for determination of suitable construction precautions.
- E. If solid ledge is encountered without overburden of soil, posts shall be set into the rock a minimum depth of 12 inch for line posts and 18 inch for terminal posts. Post holes shall be at least 1 inch greater in diameter than the post and the grout shall be thoroughly worked into the hole so as not to leave voids, and shall be crowned at the top to shed water. Where solid rock is covered by an overburden, the total setting depth shall not exceed the depths required for setting in earth, and the posts shall be grouted into the rock as described.

3.03 FENCE FABRIC

- A. Fabric shall be stretched taut and tied to posts, rails, and tension wires with the bottom edge following the finished grade not more than 2 inch above the grade. The fabric shall be installed on the security side of the fence and shall be anchored to the framework so that the fabric remains in tension after pulling force is released. The fabric shall be attached to line posts with tie wires spaced at not more than 15 inch intervals and to rails and braces at not

more than 24 inch intervals. The fabric shall be attached to the tension wire with hog ring ties on 24 inch centers.

3.04 GATES

- A. Gates shall be installed plumb, level, and secure for the full width of the opening and the hardware adjusted for smooth operation.

3.05 GATE OPERATOR SYSTEMS

- A. Install gate operator system in accordance with manufacturer's recommendations.
- B. Furnish with equipment and accessories necessary for complete installation.

3.06 ELECTRICAL GROUNDING

- A. Ground fences in accordance with applicable requirements of National Electric Safety Code.

END OF SECTION

(THIS PAGE INTENTIONALLY LEFT BLANK)

SECTION 02930

LOAMING AND SEEDING

PART 1 GENERAL

1.01 SECTION INCLUDES

- A. Requirements for loaming, fertilizing, seeding, and related work in areas disturbed in the process of performing the Work under this contract.

1.02 SUBMITTALS

- A. In accordance with SECTION 01300 submit the following:
 - 1. Submit with seed, certificates confirming seed mixture, purity, germinating value, and crop year identification.
 - 2. Submit test samples of loam.

1.03 DELIVERY, STORAGE AND HANDLING

- A. Fertilizer:
 - 1. Delivered mixed as specified in standard size, unopened containers showing weight, analysis, and name of manufacturer.
 - 2. Store in weather proof place.
- B. Seed:
 - 1. Delivered in original unopened containers with mixture listed.

PART 2 PRODUCTS

2.01 LOAM

- A. Fertile, natural topsoil, typical of locality, without admixture of subsoil, refuse or other foreign materials, and obtained from well-drained arable site. Mixture of sand, silt and clay particles in approximately equal proportions. Free of stumps, roots, heavy or stiff clay, stones large than 1 inch in diameter, lumps, coarse sand, noxious weeds, sticks, brush or other deleterious matter.
- B. Not less than 4 percent nor more than 20 percent organic matter as determined by loss on ignition of oven-dried samples.
- C. Loam test samples dried to constant weight at temperature of 230 degrees. F., plus or minus nine degrees.
- D. Use loam, having prior vegetative growth that did not contain toxic amounts of either acid or alkaline elements.

2.02 LIME, FERTILIZER AND SEED

- A. Ground agricultural limestone containing not less than 85 percent of total carbonates.
- B. Complete fertilizer, at least 50 percent of nitrogen derived from natural organic sources of ureaform and containing following percentages by weight:

Nitrogen 10% Phosphorus 10% Potash 10%

- C. Turf grass seed, clean, high in germinating value and latest year's crop mixture as follows:

Name	Minimum Proportion by Weight	Percent Purity	Percent Germination
Kentucky bluegrass	20%	87%	85%
Merion Kentucky bluegrass	20%	87%	85%
Red Chewings fescue	45%	98%	85%
Italian rye	15%	98%	90%

PART 3 EXECUTION

3.01 GENERAL

- A. Supply suitable quantities of water, hose and appurtenances.

3.02 LOAM

- A. Spread loam on areas to 6-inch depth after compaction, fine grade and compact.

3.03 LIME, FERTILIZER AND SEEDING

- A. Apply lime by mechanical means at rate of 3000 pounds per acre.
- B. Apply fertilizer at rate of 1200 pounds per acre.
- C. Remove weeds or replace loam and reestablish finish grades, if any delays in seeding lawn areas and weeds grow on surface or loam is washed out prior to sowing seed and without additional compensation. Sow seed at rate of 175 pounds per acre on calm day, by mechanical means. "Hydro-Seeding" not permitted unless otherwise permitted or required by Engineer. Sow one-half of seed in one direction, and other half at right angles to original direction. Rake seed lightly into loam, to depth of not more than 1/4 inch and compact by means of an acceptable lawn roller weighing 100 to 150 pounds per linear foot of width.
- D. Water lawn areas adequately at time of sowing and daily thereafter with fine spray, and continue throughout maintenance and protection period.
- E. Seed during approximate time periods of April 1 to May 15 and August 15 to October 1, and only when weather and soil conditions are suitable for such work, unless otherwise permitted.

3.04 MAINTENANCE OF SEEDED AREAS

- A. Maintain lawn areas and other seed areas at maximum height of 2-1/2 inches by mowing at least three times. Weed thoroughly once and maintained until time of final acceptance. Reseed and refertilize with original mixtures, watering or whatever is necessary to establish over entire area of lawn and other seeded areas a close stand of grasses specified, and reasonably free of weeds and undesirable coarse native grasses.
- B. Begin maintenance immediately after each portion of lawn is seeded and continue for minimum of 45 days.
- C. Repair or replace all seeded areas which, in judgment of Engineer, have not survived and grown in satisfactory manner, for a period of one year after acceptance.
- D. Seeding replacement, same seed mixture as specified and furnished and installed as specified.

3.05 TEMPORARY COVER CROP

- A. Sow a temporary cover crop of buckwheat, domestic rye grass or other acceptable seed if there is insufficient time in the planting season to complete seeding, fertilizing, and permanent seeding at the option of Contractor or order of Engineer. Cut and water cover crop as necessary until the beginning of the following planting season, at which time it shall be plowed or harrowed into soil, the areas shall be fertilized and permanent seed crop sown as specified.

END OF SECTION

(THIS PAGE INTENTIONALLY LEFT BLANK)

DIVISION 03

(THIS PAGE INTENTIONALLY LEFT BLANK)

SECTION 03100

CONCRETE FORMWORK

PART 1 GENERAL

1.01 SUMMARY

A. Section Includes

1. Requirements for forms to be used for all concrete masonry including footings, except as otherwise permitted.

B. Related Sections

1. Section 03200 - Concrete Reinforcement.
2. Section 03300 - Cast-In-Place Concrete.

1.02 REFERENCES

A. American Concrete Institute (ACI)

1. ACI 350, Code Requirements for Environmental Engineering Concrete Structures
2. ACI 347R, Guide to Formwork for Concrete.

1.03 SUBMITTALS

A. Submit in accordance with Section 01300.

B. Shop Drawings:

1. Layout of panel joints, tie hole pattern, and form liners.
2. Form Ties - Tapered Through-Bolts: Proposed method of sealing form tie hole; coordinate with details shown.

C. Samples: One each as follows:

1. Form liners.
2. Form ties.

D. Quality Control Submittals:

1. Statements of qualifications for formwork designer.
2. Manufacturer's Certificate of Proper Installation. (After installation)

1.04 QUALITY ASSURANCE

- ###### A. Qualifications: Formwork, falsework, and shoring designs prepared by an engineer licensed in the State of Massachusetts.

PART 2 PRODUCTS

2.01 FORM MATERIALS

A. Surfaces to be given burlap-rubbed finish.

1. Form surface in contact with the concrete shall be made of heavy gage metal, new plywood (used plywood which, in the opinion of the Engineer, is substantially equal to new plywood may be used), tempered wood fiberboards with smooth surface, or similar materials.
2. Metal forms or form linings shall have square edges so that the concrete will not have fins or fluting. Joints between form panels shall be well fitted so as to be tight and result in substantially flush concrete surfaces on opposite sides of the joints.
3. Forms shall not be pieced out by use of materials different from those in the adjacent form or in such manner as will detract from the uniformity of the finished surface.

B. Surfaces other than those to be given burlap-rubbed finish.

1. Forms shall be made of wood, metal, or other acceptable material. Wooden forms shall be constructed of sound lumber or plywood of suitable dimensions, free from knotholes and loose knots. Plywood shall be reasonable good, as accepted. Metal forms shall be of an acceptable type for the work involved. Edges of forms in contact with concrete shall be flush within 1/16 in.

C. Forms shall be of suitable material, design, and construction as to be rigid, tight enough to prevent the passage of mortar, and plane surfaces shall be plane within 1/16 in. in 4 ft. Particular care shall be taken to ensure that forms are true to line where deviations in the concrete would be obvious or objectionable, as where building superstructures are to be built thereon, or where the tops of walls are exposed. All such deviations which may occur shall be corrected by, and at the expense of the contractor, as directed, even to the extent of tearing down and rebuilding the concrete.

D. Forms for walls, columns, or piers shall have removable panels at the bottom for cleaning, inspection, and scrubbing-in of bonding grout. Forms for thin sections (such as walls or columns) of considerable height shall be arranged with suitable openings so that the concrete can be placed in a manner that will prevent segregation and accumulations of hardened concrete on the forms or reinforcement above the fresh concrete, unless special spouts are used to place concrete, and so that construction joints can be properly keyed and treated.

E. Forms shall be sufficiently rigid to prevent displacement or sagging between supports, and so constructed that the concrete will not be damaged by their removal. The Contractor shall be entirely responsible for their adequacy.

F. Wall Forms and Underside of Slabs and Beams:

1. Materials: Plywood, hard plastic finished plywood, overlaid waterproof particle

board, or steel in “new and undamaged” condition, of sufficient strength and surface smoothness to produce specified finish. Use in combination with form liners where required.

G. All Other Forms: Materials as specified for wall forms.

H. Form Sealer:

1. Material: Surface sealer will not bond with, stain, or adversely affect concrete surfaces, and will not impair subsequent treatments of concrete surfaces, when applied to most forms of form liners. A ready-to-use water based material formulated to reduce or eliminate surface imperfections, containing no mineral oil or organic solvents. Environmentally safe, meeting local, state, and federal regulations and can be used in clean water treatment plants.
2. Manufacturer and Product: Master Builders, Inc.; Rheofinish; or Equal.

I. Rustication Grooves and Beveled Edge Corner Strips: Nonabsorbent material, compatible with form surface, fully sealed on all sides prohibiting loss of paste or water between the two surfaces. Match the rustication grooves with the existing configuration and style located at the plant.

2.02 FORM TIES

A. Form ties to be encased in concrete shall not be made of through-bolts or commonwire, but shall be of a well-established type, so made and installed as to embody the following features:

1. After removal of the protruding part of the tie, there shall be no metal nearer than 1 in. to the face of the concrete.
2. The part of the tie which is to be removed shall be at least 1/2 in. in diameter, or if smaller, it shall be provided with a wood or metal cone 1 in. long placed against the inside of the forms. cones shall be carefully removed from the concrete after the forms have been stripped.
3. Ties which pass through walls subject to hydrostatic pressure shall be provided with acceptable water stops, such as washers, securely fastened to the ties.

B. Form Ties:

1. Material: Steel.
2. Spreader Inserts.
 - a. Conical or spherical type.
 - b. Design to maintain positive contact with forming material.
 - c. Furnish units that will leave no metal closer than 1 inch to concrete surface when forms, inserts, and tie ends are removed.
3. Wire ties not permitted.
4. Flat bar ties for panel forms, furnish plastic or rubber inserts with minimum 1 inch depth and sufficient dimensions to permit patching of tie hole.
5. Water Stop Ties: For water-holding structures, basements, pipe galleries, and accessible spaces below finish grade, furnish one of the following:
 - a. Integral steel water stop 0.103-inch thick and 0.625 inch in diameter tightly and continuously welded to tie.
 - b. Neoprene water stop 3/16-inch thick and 15/16 inch in diameter whose center

- hole is 1/2 diameter of tie, or a molded plastic water stop of comparable size.
- c. Water Stop: Oriented perpendicular to tie and symmetrical about center of tie.
- d. Design ties to prevent rotation or disturbance of center portion of tie during removal of ends and to prevent water leaking along tie.
- 6. Through-Bolts: Tapered minimum 1-inch diameter at smallest end.
- 7. Elastic Vinyl Plug: Design and size of plug to allow insertion with tool to enable plug to elongate and return to original length, and diameter upon removal forming a watertight seal.
 - a. Manufacturer and Product: Dayton Superior Co., Miamisburg, OH; Dayton Sure Plug, or equal.

PART 3 EXECUTION

3.01 SYSTEM DESIGN REQUIREMENTS

- A. Design formwork in accordance with ACI 347R and ACI 318 to provide the concrete finishes specified in Section 03300, CAST-IN-PLACE CONCRETE.
- B. Make joints in forms watertight.
- C. Limit panel deflection to 1/360 of each component span to achieve tolerances specified.

3.02 ERECTION

- A. General: Unless specified otherwise, follow the applicable recommendations of ACI347R.
- B. Forms shall be so constructed and placed that the resulting concrete will be of the shape, lines, dimensions, and to the elevations indicated on the drawings or specified, and exposed concrete will be substantially free from board or grain marks, poorly matched joints, and other irregularities or defects.
- C. Beveled Edges (Chamfer):
 - 1. Form 3/4-inch bevels at concrete edges, unless otherwise shown.
 - 2. Where beveled edges on existing adjacent structures are other than 3/4-inch, obtain ENGINEER's approval of size prior to placement of beveled edge.
- D. Wall Forms:
 - 1. Do not reuse forms with damaged surfaces.
 - 2. Locate form ties and joints in an uninterrupted pattern for smooth and uniform surface.
 - 3. Inspect form surfaces prior to installation to assure conformance with specified tolerances.
- E. Forms for Curbs, Sidewalks, and Driveways:
 - 1. Provide standard steel or wood forms to prevent movement.
 - 2. Set forms to true lines and grades, and securely stake in position.
- F. Form Tolerances: Provide forms in accordance with ACI 347R and ACI 318 and the following tolerances for finishes specified:

1. Wall Tolerances:
 - a. Straight Vertical or Horizontal Wall Surface: Flat planes within tolerance specified.
 - b. Plumb within 1/4-inch to 10-feet.
 - c. Depressions in Wall Surface: Maximum 5/16-inch when 10-foot straightedge is placed on high points in all directions.
 - d. Thicknesses: Maximum 1/4-inch minus or 1/2-inch plus from dimensions shown.
2. Slab Tolerances:
 - a. Exposed Slab Surfaces: Comprise of flat planes as required within tolerances specified.
 - b. Slab Finish Tolerances and Slope Tolerances: Crowns on floor surface not too high as to prevent 10-foot straight edge from resting on end blocks, nor low spots that allow a block of twice the tolerance in thickness to pass under the supported 10-foot straightedge.
 - c. Steel gauge block 5/16-inch thick.
 - d. Slab drainage.
 - 1) Finish Slab Elevation: Slope slabs to floor drain and gutter, and shall adequately drain regardless of tolerances.
 - 2) Thickness: Maximum 1/4-inch minus or 1/2-inch plus from thickness shown, except where thickness tolerance will not affect slope, drainage, or slab elevation.

3.03 FORM SURFACE PREPARATION

- A. Thoroughly clean form surfaces in contact with concrete or previous concrete, dirt, and other surface contaminants prior to coating surface.
- B. Exposed Wood Forms in Contact with Concrete: Apply form sealer as recommended by the sealer material manufacturer.
- C. Steel Forms: Apply form sealer to steel forms as soon as they are cleaned to prevent discoloration of concrete from rust.

3.04 FORM COATINGS

- A. All forms shall be oiled with an acceptable nonstaining oil or liquid form coating before reinforcement is placed.
- B. Before form material is reused, all surfaces that are in contact with the concrete shall be thoroughly cleaned, all damaged pieces repaired, and all projecting nails withdrawn.

3.05 REMOVAL OF FORMS

- A. Except as otherwise specifically authorized by the Engineer, forms shall not be removed until the concrete has aged for the following number of day-degrees*:
 1. Formwork not supporting weight of concrete, (i.e., sides of beams, walls, columns, and similar parts of the Work) may be removed after cumulatively curing at not less than a total of three 50-degree F days after placing concrete,

provided concrete is sufficiently hard to not be damaged by form-removal operations, and provided curing protection operations are maintained.

2. Leave forms and shoring for elevated structural slabs or beams in place, in accordance with ACI 318, Chapter 6, and until concrete has reached compressive strength equal to 80 percent of the specified 28-day compressive strength as determined by test cylinders.
3. *Day-degree: total number of days times average daily air temperature at surface of concrete. For example, 5 days at a daily average temperature of 60 deg. F. equals 300 day-degrees.

3.06 MANUFACTURER'S SERVICES

- A. Provide form manufacturer's representative at site for installation assistance, and inspection.

END OF SECTION

SECTION 03200

CONCRETE REINFORCEMENT

PART 1 GENERAL

1.01 SUMMARY

A. Section Includes

1. Requirements for reinforcing steel bars, wire fabric and accessories as shown on the drawings, specified herein, and as needed for a complete and proper installation.

B. Related Sections

1. Section 03100 - Concrete Formwork.
2. Section 03300 - Cast-In-Place Concrete.

1.02 REFERENCES

A. American Society for Testing and Materials (ASTM).

1. A82, Specification for Steel Wire, Plain for Concrete Reinforcement.
2. A185, Specification for Steel Welded Wire Fabric, Plain, for Concrete Reinforcement.
3. A497, Specification for Steel Welded Wire Fabric, Deformed, for Concrete Reinforcement.
4. A615, Specification for Deformed and Plain Billet Steel Bars for Concrete Reinforcement.
5. A706, Specification for Low-Alloy Steel Deformed Bars for Concrete Reinforcement.
6. A775, Specification for Epoxy-Coated Reinforcing Steel Bars.

B. American Concrete Institute (ACI).

1. ACI 350, Code Requirements for Environmental Engineering Concrete Structures

1.03 SUBMITTALS

- ###### A. In accordance with Section 01300 submit cutting and bending drawings and schedules for all reinforcement to be furnished.

B. Shop Drawings:

1. Prepare in accordance with Concrete Reinforcing Steel Institute (CRSI) Manual of Standard Practice and ACI SP-66 Detailing Manual:
 - a. Bending lists.
 - b. Placing drawings.
2. Welded splice, Cadweld splice, and mechanical threaded splice.

C. Quality Control Submittals:

1. Lab test reports for reinforcing steel showing stress-strain curves and ultimate strengths.
2. Mechanical Threaded Connections:
 - a. Current International Conference of Building Officials (ICBO) Research Report or equivalent code agency report listing findings to include acceptance, special inspection requirements, and restrictions.
 - b. Manufacturer's instructions.
 - c. Verification that device threads have been checked and meet all requirements for thread quality, in accordance with manufacturer's published methods.
3. Epoxy-Coated Reinforcing Bars: Written certification in accordance with paragraph 4.2.1 of ASTM A775.
4. Welding Qualification: Prior to welding, submit welder qualifications and radiographic nondestructive testing procedures.
 - . Test results to field testing.

1.04 QUALITY ASSURANCE

- A. The steel shall be newly rolled stock substantially free from mill scale, rust, dirt, oil, grease, or other foreign matter. Bars shall be of billet steel and, unless otherwise indicated, shall be Grade 60 bars.
- B. Billet steel bars shall conform to ASTM A 615.
- C. All bars shall be rolled by an acceptable mill. The Contractor shall submit at his own expense certified copies of tests of the bars furnished. The tests shall be as specified in the appropriate ASTM Specification referred to above and shall be made by an acceptable laboratory.
- D. Welder Qualifications: Certified in accordance with AWS D1.4-79.

1.05 DELIVERY, STORAGE, AND HANDLING

- A. Unload, store, and handle bars in accordance with CRSI publication "Placing Reinforcing Bars."
- B. Coated Bars:
 1. Protect epoxy-coated bars contact areas from handling equipment.
 2. Lift bundles of coated bars at multiple pickup points to minimize bar-to-bar abrasion from sags in bundles.
 3. Do not drop or drag coated bars or bundles of coated bars.
 4. Store coated bars on protective cribbing.
 5. Color fading of coating is not cause for rejection of epoxy-coated reinforcing bars.

PART 2 PRODUCTS

2.01 MATERIALS

- A. Deformed Billet-Steel Reinforcing Bars:
 - 1. Includes stirrups, ties, and spirals.
 - 2. ASTM A615, Grade 60, including Supplemental Requirements S1 where welding is not required.
 - 3. ASTM A706, Grade 60, including Supplemental Requirements for reinforcing to be welded.

- B. Splices and Mechanical Connections:
 - 1. Metal Sleeve: Furnish with cast filler metal, capable of developing, in tension or compression, 125 percent of minimum tensile strength of the bar.
 - 2. Mechanical Threaded Connections: Furnish metal coupling sleeve for splicing reinforcing in secondary members or in areas of low stress with internal threads engaging threaded ends of bars developing in tension or compression 125 percent of yield strength of bar.
 - a. Manufacturers and Products:
 - 1) Erico Products, Inc., Cleveland, OH; Lenton Reinforcing Steel Couplers.
 - 2) Richmond Screw Anchor Co., Inc. Fort Worth, TX; Richmond DB-SAE Dowel Bar Splicers.
 - 3) Or equal.

- C. Epoxy-Coated Reinforcing Bars: ASTM A775, deformed bars, with bond strength not less than 80 percent of uncoated bars.

- D. Welded Wire Fabric:
 - 1. ASTM A185, or A497, and ACI 318/318R, using ASTM A82, wire of 75 ksi minimum tensile strength.
 - 2. Furnish flat sheets only, rolled sheets not permitted.

- E. Reinforcement shall be accurately formed to the dimensions indicated on the drawings. Stirrups and tie bars shall be bent around a pin having a diameter not less than two times the minimum thickness of the bar. Bends for other bars shall be made around a pin having a diameter not less than six times the minimum thickness except for bars larger than 1 in., in which case the bends shall be made around a pin of eight bar diameters. All bars shall be bent cold.

- F. Bars shall be shipped to the work site with bars of the same size and shape fastened in bundles with securely wired-on metal identification tags giving size and mark.

- G. Deformations on bars for concrete reinforcement shall conform to the requirements of the above-mentioned ASTM Specifications.

2.02 ACCESSORY MATERIALS

- A. Tie Wire:
 - 1. Black, soft-annealed 16-gauge wire.
 - 2. Nylon-, epoxy-, or plastic-coated wire.
- B. Bar Supports and Spacers:
 - 1. Precast concrete bar supports, cementitious fiber-reinforced bar supports, or all-plastic bar supports and side form spacers meeting the requirements of CRSI Manual of Standard Practice. Do not use other types of supports or spacers.
 - 2. In Beams, Columns, Walls, and Slabs Exposed to View After Stripping: Small rectangular concrete blocks made up of same color and strength as concrete being placed around them or all-plastic bar supports and side form spacers.
 - 3. Use supports made of dielectric material for epoxy-coated reinforcing bars supported from formwork.
 - 4. If epoxy-coated reinforcing is used, furnish epoxy-coated reinforcing bars for spreader bars.
 - 5. Precast concrete supports of same strength as concrete for reinforcing in concrete placed on grade.
- C. Welded steel wire fabric shall conform to the ASTM A 185. The gage and spacing of wires shall be as indicated on the drawings.
- D. Soffit Clips: Made galvanized steel wire not lighter than No. 12 Stl. W.C. They shall be shared so that the greater portion of the wire is held about 1 in. from the flange of the steel beam, and shall be spaced not less than 9 in. on centers, the spacing being maintained by suitable longitudinal wires.

2.03 FABRICATION

- A. Follow CRSI Manual of Standard Practice.
- B. Bend all bars cold.

PART 3 EXECUTION

3.01 PREPARATION

- A. Notify ENGINEER when reinforcing is ready for inspection and allow sufficient time for inspection prior to placing concrete.
- B. Repair epoxy coating damaged due to handling, shipment, and placing. Repair with patching material in accordance with ASTM A775, and manufacturer's recommendations.
- C. Clean metal reinforcement of loose mill scale, oil, earth, and other contaminants.

- D. Coat wire projecting from precast concrete bar supports with dielectric material, epoxy, or plastic.
- E. Before being placed in position, reinforcement shall be thoroughly cleaned of loose mill and rust scale, dirt, and other coatings, including ice, that tend to interfere with development of proper bond. Where there is delay in depositing concrete after reinforcement is in place, bars shall be reinspected and cleaned when necessary.
- F. Reinforcement which is to be exposed for a considerable length of time after having been placed shall be painted with a heavy coat of cement grout, if required.

3.02 Reinforcing Bar Installation

- A. Bundle or space bars, instead of bending where construction access through reinforcing is necessary.
- B. Spacing and Positioning: Conform to ACI 350.
- C. Location Tolerances: In accordance with CRSI publication, "Placing Reinforcing Bars".
- D. Splicing:
 - 1. Follow ACI 318/318R.
 - 2. Use lap splices unless otherwise shown or permitted in writing by ENGINEER.
 - 3. Welded Splices: Accomplish by full penetration groove welds and develop at least 125 percent of yield strength of bar.
 - 4. Stagger splices in adjacent bars.
 - 5. Metal sleeves may be used.
- E. Mechanical Splices and Connections:
 - 1. Use only in areas specifically approved in writing by the ENGINEER.
 - 2. Install as required by manufacturer with threads tightened and in accordance with ICBO Research Report.
 - 3. Maintain minimum edge distance and concrete cover.
- F. Tying Deformed Reinforcing Bars:
 - 1. Tie every other intersection on mats made up of Nos. 3, 4, 5, and 6 bars to hold them firmly at required spacing.
 - 2. Bend all noncoated tie wire to prevent tie wire from being closer than 1 inch from the surface of concrete.
 - 3. Epoxy-Coated Bars:
 - a. Use epoxy-coated or nonmetallic clips.
 - b. Repair coating damage at clipped or welded intersection.
- G. Reinforcement Around Openings: Place an equivalent area of steel bars or fabric around pipe or opening and extend as shown, on each side sufficiently to develop bond with each bar. See drawing details.

H. Welding Reinforcement:

1. Only A706/A706M bars may be welded.
2. Do not perform welding until welder qualifications are approved.
3. Provide suitable ventilation when welding epoxy-coated reinforcing bars.
4. After completion of welding on epoxy-coated reinforcing bars, repair coating damage, welds, and steel splice members with same material as used for repair of coating damage.

I. Straightening and Rebending: Field bending of reinforcing steel bars is not permitted.

J. Unless permitted by Engineer, do not cut reinforcing bars in the field. When epoxy-coated reinforcing bars are cut in the field, coat ends of bars with same material used for repair of coating damage.

K. Reinforcement shall be accurately positioned as indicated on the drawings, and secured against displacement by using annealed iron wire ties or suitable clips at intersections. Concrete blocks having a minimum bearing area of 2 in. by 2 in., and equal in quality to that specified for the slab, shall be used for supporting reinforcing bars for slabs on grade. Where the underside of slabs will be exposed to view in the finished work, stainless-steel supports shall be used

L. Furnish and place all concrete reinforcement as indicated on the drawings and as herein specified. Concrete reinforcement in sizes No. 3 (3/8 in.) and larger shall be deformed steel bars of the shapes and sizes indicated on the drawings.

3.03 WELDED WIRE FABRIC INSTALLATION

A. Extend fabric to within 2 inches of edges of slab, and lap splices at least 1-1/2 courses of fabric or minimum 8 inches.

B. Tie laps and splices securely at ends and at least every 24 inches with tie wire.

C. Place welded wire fabric on concrete blocks at correct distance as shown, above bottom of slab and rigidly support equal to that provide for reinforced bars. Do not use broken concrete, brick, or stone.

D. Follow ACI 350 and current Manual of Standard Practice, Welded Wire Fabric.

E. Do not use fabric that has been rolled. Install flat sheets only.

3.04 TESTS AND INSPECTION

A. Test 10 percent of all welds using radiographic, nondestructive testing procedures referenced in AWS D1.4-79.

- B. Inspect each splice and verify each component is in accordance with manufacturer's instructions and ICBO Research Report.

END OF SECTION

(THIS PAGE INTENTIONALLY LEFT BLANK)

SECTION 03250

EXPANSION, CONSTRUCTION, AND CONTROL JOINTS

PART 1 GENERAL

1.01 SUMMARY

A. Section Includes

1. Requirements for making joints in concrete and masonry.

B. Related Sections

1. Section 03200 - Concrete Reinforcing
2. Section 03300 - Cast-In-Place Concrete
3. Section 03604 - Non Shrink Grout
4. Section 07920 - Joint Sealants

1.02 REFERENCES

A. Army Corp. of Engineers.

1. CRD-C-572, Specification for Polyvinyl chloride Waterstop.

B. American Society for Testing and Materials (ASTM)

1. A36, Specification for Carbon Structural Steel.
2. D226, Specification for Asphalt-Saturated Organic Felt used in Roofing and Waterproofing.
3. D227, Specification for Smooth-Surfaced Asphalt Roll Roofing and Waterproofing.
4. D994, Specification for Preformed Expansion Joint Filler for Concrete (Bituminous Type).
5. D1506, Specification for Flexible Cellular Materials-Sponge or Expanded Rubber.
6. D1751, Specification for Preformed Expansion Joint Filler for Concrete Paving and Structural Construction (Nonextruding and Resilient Bituminous Types).

C. National Sanitation Foundation (NSF).

1. 61-90,

1.03 SUBMITTALS

A. Shop Drawings:

1. Plastic Type Water Stops: Details of splices to be used and method of securing water stop in the forms and supporting water stop so as to maintain proper orientation and location during concrete placement.
2. Construction Joints: Layout and location indicating type to be used.
3. Joint fillers for horizontal and sloped joints.
4. Preformed control joints.
5. Water stop.

- B. Samples: Splice, joint, and fabricated cross of each size, shape, and fitting of water stop(s) proposed for use.
- C. Quality Control Submittals:
 - 1. Water stop manufacturer's written instructions for product shipment, storage, handling, installation field splices, and repair.
 - 2. Joint filler and primer. Manufacturer's written instructions for product shipment, storage, handling, application and repair.
 - 3. Preformed Control Joint: Manufacturer's written instructions for product shipment, storage, handling, application, and repair.

1.04 QUALITY ASSURANCE

- A. Regulatory Requirements: Acceptance of pourable joint filler for potable water structures by federal EPA or by a state health agency.
 - 1. Pourable Joint Filler: Certified as meeting NSF 61-90.

1.05 DELIVERY, STORAGE AND HANDLING

- A. Acceptance at Site: Verify that water stops delivered are in accordance with cross-section dimensions as shown and manufacturer's product data prior to unloading and storing on site.

PART 2 PRODUCTS

2.01 PLASTIC WATER STOP

- A. Extruded from an elastomeric plastic compound of which the basic resin shall be polyvinyl chloride (PVC). Reclaimed PVC in the compound is not acceptable.
- B. Specific Gravity: Approximately 1.37.
- C. Shore Durometer Type A Hardness: Approximately 80.
- D. Performance Requirements: Corps of Engineers' Specification CRD-C-572.
- E. Type: Center bulb with a number of parallel ribs or protrusions on each side of strip center.
- F. Corrugated or tapered type water stops are not acceptable.
- G. Thickness: Constant from bulb edge to the outside stop edge.
- H. Minimum Weight per Foot of Water Stop:

1. 0.90 pound for 3/16 inch by 4 inch.
2. 1.62 pounds for 3/8 inch by 6 inch.
3. 2.30 pounds for 3/8 inch by 9 inch.

I. Manufacturers and Catalog Numbers:

1. Vulcan Metal Products, Inc., Construction Materials Division, Birmingham, AL; Catalog No. 3/81-15M: Type 8067 (4 inch by 3/16 inch), Type 8069 (6 inch by 3/8 inch), and Type 8070 (9 inch by 3/8 inch).
2. Vinylex Corp., Knoxville, TN; Catalog No. 03250/VIN (1987): No. RB6-38H (6 inch by 3/8 inch) and No. RB9-38H (9 inch by 3/8 inch).
3. Greenstreak Plastic Products, St. Louis, MO; Catalog No. 03250/GRD (1987): Style 732 (6 inch by 3/8 inch) and Style 735 (9 inch by 3/8 inch).
4. A.C. Horn, Inc., Beltsville, MD; Catalog No. CSP-162 (1987): Type 3 (4 inch by 3/16 inch), Type 9 (6 inch by 3/8 inch), and Type 10 (3/8 inch by 9 inch).

2.02 WIRE LOOPED PLASTIC WATER STOP

- A. Furnish as an alternative to plastic water stops.
- B. Same material and geometry as plastic water stops.
- C. Furnish with continuous galvanized wire looping at edge for convenience in positioning and securing stop in place in the forms.
- D. Manufacturers and Catalog Numbers:
 1. Paul Murphy Plastics, Roseville, MI; "Wire Stop Water Stop"; geometry numbers ACR 6380, ACR 9380, as shown on Paul Murphy Plastics Co. Drawing No. CCP-120-12M dated 12-89.
 2. Or equal.

2.03 BOND BREAKER

- A. Tape for Expansion Joints: Adhesive-backed glazed butyl or polyethylene tape, same width as the joint, that will adhere to the premolded joint material or concrete surface.
- B. Use either bond breaker tape or a bond prevention material as specified in SECTION 03300, except where a tape is specifically called for.

2.04 PREMOLDED JOINT FILLER

- A. Bituminous Type: ASTM D994 or D1751.
- B. Sponge Rubber: Neoprene, closed-cell, expanded; ASTM D1056-85, Type 2C5, with a compression deflection, 25 percent deflection (limits), 119 to 168 kPa (17 to 24 psi) minimum.
 1. Manufacturer and Product:
 - a. Rubatex Corp.; R451N
 - b. Or equal.

2.05 PREFORMED CONTROL JOINT

A. One-Piece, Flexible, Polyvinyl Chloride Joint Former:

1. Manufacturer and Product:
 - a. Vinylex Corp., Knoxville, TN; Kold-Seal Zip-Per Strip KSF-150-50-50.
 - b. Or equal.

B. One-Piece Steel Strip with Preformed Groove:

1. Manufacturer and Product:
 - a. Burke Concrete Accessories, Inc., San Mateo, CA; Keyed Kold Retained Kap.
 - b. Or equal.

C. Furnish in full-length, unspliced pieces.

2.06 POURABLE JOINT FILLERS

A. Filler for Nonpotable Water Structure:

1. Specific Gravity: Greater than 1.0 for cured, in-place filler.
2. Sloped Joints: Furnish Gun Grade material that will remain as placed in joints and will not run down slope.
3. Manufacturers and Products:
 - a. W.R. Meadows, Inc., Elgin, IL: No. 164 Polymeric sealing compound, hot-pour, or Hi-Spec Polymeric joint sealing, hot-pour compound; or
 - b. A.C. Horn, Inc., North Bergen, NJ: No-Track two-component material (Code 2323), cold-applied, self-leveling filler; or
 - c. W.R. Meadows, Elgin, IL: Gardox, two-component, cold-applied compound filler.

2.07 STEEL EXPANSION JOINT DOWELS

A. Dowels: ASTM A36 round smooth steel bars.

B. Bar Coating: Two-coat system, fusion bonded, steel dowel coating, with a factory-applied lubricating coating.

2.08 ACCESSORIES

A. Joint Sealants: As specified in SECTION 07920, JOINT SEALANTS.

B. Nonshrink Grout:

1. As specified in SECTION 03604.
2. Compatible with joint sealant.

C. Roofing Felt: ASTM D226, Type II, 30-pound asphalt-saturated or equal weight of ASTM D227 coal-tar saturated felt.

D. Reinforcing Steel: As specified in SECTION 03200.

- E. Nails: As required for securing bituminous type premolded joint filler.
- F. Masking Tape: As required to temporarily adhere to concrete at each side of joint to receive filler.

PART 3 EXECUTION

3.01 GENERAL

- A. Construct straight joints; make vertical or horizontal, except where walls intersect sloping floors.
- B. Commence concrete placement after the joint preparation is complete.
- C. Time Between Concrete Pours: As specified in SECTION 03300.

3.02 SURFACE PREPARATION

- A. Construction Joints: Prior to placement of abutting concrete, clean contact surface:
 - 1. Remove laitance and spillage from reinforcing steel and dowels.
 - 2. Roughen surface to a minimum of 1/4-inch amplitude:
 - a. Sandblast after the concrete has fully cured.
 - b. Water blast after the concrete has partially cured.
 - c. Green cut fresh concrete with high pressure water and hand tools.
 - 3. Perform cleaning so as not to damage water stop, if one is present.
- B. Expansion Joint with Pourable Filler:
 - 1. Use motorized wire brush or other motorized device to mechanically roughen and thoroughly clean concrete surfaces on each side of joint from plastic water stop to the top of the joint.
 - 2. Use clean and dry high pressure air to remove dust and foreign material, and dry joint.
 - 3. Prime surfaces before placing joint filler.
 - 4. Avoid damage to water stop.
- C. Expansion Joint without Pourable Filler:
 - 1. Coat concrete surfaces above and below plastic water stop with bond breaker.
 - 2. Do not damage water stop.
- D. Control Joint:
 - 1. Coat concrete surfaces above and below plastic water stop with bond breaker.
 - 2. Do not damage water stop.
 - 3. Furnish correct type and size of reinforcing and dowels.

3.03 INSTALLATION OF WATER STOPS

- A. General:

1. Join water stops at intersections to provide continuous seal.
2. Center water stop on joint.
3. Secure water stop in correct position to avoid displacement during concrete placement.
4. Repair or replace damaged water stop.
5. Place concrete and vibrate to obtain impervious concrete in the vicinity of all joints.
6. Joints in Footings and Slabs:
 - a. Ensure that space beneath plastic water stop is completely filled with concrete.
 - b. During concrete placement, make a visual inspection of the entire water stop area.
 - c. Limit concrete placement to elevation of water stop in first pass, vibrate the concrete under the water stop, lift the water stop to confirm full consolidation without voids, then place remaining concrete to full height of slab.
 - d. Apply procedure to full length of plastic water stops.

B. Plastic Water Stop:

1. Install in accordance with manufacturer's written instructions.
2. Splice in accordance with the water stop manufacturer's written instructions using a thermostatically controlled heating iron. Butt splice unless specifically detailed otherwise.
 - a. Allow at least 10 minutes before the new splice is pulled or strained in any way.
 - b. Finished splices shall provide a cross-section that is dense and free of porosity with tensile strength of not less than 80 percent of the unspliced materials.
3. Wire looped plastic water stop may be substituted for plastic water stop.

3.04 EXPANSION JOINT INSTALLATION

A. General:

1. Place bond breaker above and below water stop when premolded joint filler and pourable joint filler is not used.
2. Premolded Joint Filler:
 - a. Sufficient in width to completely fill the joint space where shown.
 - b. If a water stop is in the joint, cut premolded joint filler to butt tightly against the water stop and the side forms.
3. Precut premolded joint filler to the required depth at locations where joint filler or sealant is to be applied.
4. Form cavities for joint filler with either precut, premolded joint filler, or smooth removable accurately shaped material. Entire joint above water stop, in slabs, shall be formed and removed so that entire space down to water stop can be filled with the pourable joint filler.
5. Vibrate concrete thoroughly along the joint form to produce a dense, smooth surface.

B. Bituminous Type Premolded Joint Filler:

1. Drive nails approximately 1 foot 6 inches on center through the filler, prior to installing, to provide anchorage embedment into the concrete during concrete placement.
2. Secure premolded joint filler in forms before concrete is placed.
3. Install in walkways, at changes in direction, at intersections, at each side of driveway entrances, and at 45-foot intervals, maximum.

C. Pourable Joint Filler:

1. General: Install in accordance with the manufacturer's written instructions, except as specified below:
 - a. Apply primer prior to pouring joint filler.
 - b. Fill entire joint above the water stop with joint filler as shown.
 - c. Use masking tape on top of slabs at sides of joints; clean spillage. Remove masking tape afterwards.
2. Rubber Asphalt Type, Hot-Applied:
 - a. Heat filler material in a double-walled boiler.
 - b. Place filler in the joint by means of a nozzle from a portable pouring type container to prevent spillage outside of the joint.
 - c. Begin pouring joint filler at the bottom of the horizontal joint and proceed upwards in a manner that will preclude the possibility of trapping air in the joint.
3. Rubber Asphalt Type, Cold-Applied: Place cold-applied two-component fillers in accordance with manufacturer's written instructions.
4. Multicomponent Type for Potable Water Structures: Install in accordance with manufacturer's written instructions.

D. Steel Expansion Joint Dowels:

1. Install coated and lubricated bars parallel to wall or slab surface and in true horizontal position perpendicular to the joint in both plan and section view, so as to permit joint to expand or contract without bending the dowels.
2. Secure dowels tightly in forms with rigid ties.
3. Install reinforcing steel in the concrete as shown to protect the concrete on each side of the dowels and to resist any forces created by joint movement.

3.05 CONTROL JOINT INSTALLATION

- A. Locate reinforcing and dowels as shown.
- B. Install PVC water stop.
- C. Concrete surfaces shall be dense and smooth.
- D. Install bond breaker to concrete surfaces above and below water stop.

3.06 PREFORMED CONTROL JOINTS

- A. Use only where specifically shown; do not use in water-holding basins.

- B. Locate flush, or slightly below the top of slab.
- C. Install in accordance with manufacturer's written instructions in straight, full-length unspliced pieces.
- D. Steel Strip Type with Preformed Groove: Brace to withstand pressure of concrete during and after placement.

END OF SECTION

SECTION 03300

CAST-IN-PLACE CONCRETE

PART 1 GENERAL

1.01 SECTION INCLUDES

- A. Requirements for furnishing and installing forms, reinforcing steel, concrete and expansion and/or construction joints.
- B. Related Section
 - 1. Section 03100 – Formwork
 - 2. Section 03200 – Reinforcement
 - 3. Section 03250 – Expansion, Construction, And Control Joints

1.02 REFERENCES

- A. American Society for Testing and Materials (ASTM)
 - 1. A185, Specification for Steel Welded Wire Fabric, Plain, for Concrete Reinforcement.
 - 2. A615, Specification for deformed and Plain Billet-Steel Bars for Concrete Reinforcement.
 - 3. C31, Practice for Making and Curing Concrete Test Cylinders in the Field.
 - 4. C33, Specification for Concrete Aggregates.
 - 5. C39, Test Method for Compressive Strength of Cylindrical Concrete Specimens.
 - 6. C42, Test Method for Obtaining and Testing Drilled Cores and Sawed Beams of Concrete.
 - 7. C94, Specification for ready Mixed Concrete.
 - 8. C143, Test Method for Slump of Hydraulic Cement Concrete.
 - 9. C150, Specification for Portland Cement.
 - 10. C172, Practice for Sampling Freshly Mixed Concrete.
 - 11. C231, Test Method for Air Content of Freshly Mixed Concrete by the Pressure Method.
 - 12. C260, Test Method for Air-Entraining Admixtures for Concrete.
 - 13. C494, Specification for Chemical Admixtures for Concrete.
 - 14. C920, Specification for Elastomeric Joint sealants.
 - 15. D994, Specification for Preformed Expansion Joint Filler for Concrete (Bituminous Type)
 - 16. D1056, Specification for Flexible Cellular Materials-Sponge or Expanded Rubber.

17. D1751, Specification for Preformed Expansion Joint Filler for Concrete Paving and Structural Construction (Nonextruding and Resilient Bituminous Types).

B. American Concrete Institute (ACI):

1. ACI 301, Specification for Structural Concrete for Buildings.
2. ACI 304, Recommended Practice for Measuring, Mixing, Transporting, and Placing Concrete.
3. ACI 305, Recommended Practice for Hot Weather Concreting.
4. ACI 306, Recommended Practice for Cold Weather Concreting.
5. ACI 315, Building Code Requirements for Reinforced Concrete.
6. ACI 347, Guide to Formwork for Concrete.

C. Concrete Reinforcing Steel Institute (CRSI):

1. Manual of Standard Practice.

1.03 SUBMITTALS

A. Submit Shop Drawings in accordance with SECTION 01300 for the following:

1. Reinforcing Steel
 - a. Furnish in detail and completeness that all fabrication and placement at the site can be accomplished without the use of contract drawings for reference.
 - b. Include number of pieces, sizes, and grade of reinforcing steel, accessories, and any other information required for fabrication and placement.
 - c. Show joint layout and design
 - d. Check structural and site drawings for anchor bolts, anchors, inserts, conduits, sleeves, and any other items which are required to be embedded in concrete, and make necessary provisions as required so that reinforcing steel will not interfere with the placement of such embedded items.
2. Concrete mix designs.
3. Grout manufacturer/design mix (if included in this section)
4. Manufacturer's data for ancillary materials such as joint fillers and sealants, epoxy bonding compound.

1.04 QUALITY ASSURANCE

A. Selection of testing laboratory in accordance with SECTION 01410.

B. Sample and Test Concrete as follows:

1. Test Specimens: Make, cure and have tested, a minimum of one set of four test specimens from the concrete of each day's pour and for each fifty cubic yards of concrete cast in accordance with ASTM C172, C31 and C39. One cylinder shall be broken after seven days and three cylinders after twenty-eight day.
2. Slump: A slump test shall be made for each truckload of concrete in accordance with ASTM C143. Slumps greater than design mix limit will be grounds for rejection of the concrete.

3. Air Content: An air content test shall be made from each day's pour of concrete by the pressure method in accordance with ASTM C231. Air contents above or below the limits specified will be grounds for rejection of the concrete.
4. In the event the compressive strength of the cylinders, when tested, is below the specified minimum, the Engineer may require test cores of the hardened structure to be taken by the Testing Laboratory in accordance with ASTM C42. If such test indicates that the core specimen is below the required strength, the concrete in question shall be removed and replaced without cost to the Owner. Any other work damaged as a result of this concrete removal shall be replaced with new materials to the satisfaction of the Engineer at no additional cost to the Owner. The cost of coring will be deducted from the contract amount. Where the Testing Laboratory has taken core cylinders and the concrete proves to be satisfactory, core holes shall be filled in a manner satisfactory to the Engineer at no additional cost to the Owner.
5. The Contractor shall coordinate the date and location of tests with the Engineer before any concrete work is started.

1.05 PRODUCT DELIVERY, STORAGE AND HANDLING

A. Reinforcing steel.

1. Transport to the site, store, and cover in a manner which will ensure that no damage shall occur to it from moisture, dirt, grease, or any other cause that might impair bond to concrete, or chip protective epoxy coating if applicable.
2. Store on the site at all times, a supply of approved reinforcing steel to ensure that there will be no delay of the work.
3. Identification of steel shall be maintained after bundles are broken.

PART 2 PRODUCTS

2.01 MATERIALS

A. Portland Cement.

1. Portland Cement used for building footings, base slabs, foundation walls, columns, and beams shall be in accordance with ASTM C150, Type V of U.S. manufacture.
2. All other Portland Cement shall be in accordance with ASTM C150, Type II of U.S. manufacture.

B. Aggregates.

1. Fine aggregate, in accordance with ASTM C33, clean and graded from 1/4 inch to fines.
2. Coarse aggregate, in accordance with ASTM C33, clean and graded from 1/4 inch to maximum sizes hereinafter specified.

C. Air Entraining Agent.

1. In accordance with ASTM C260.

- D. Water Reducing Agent.
 - 1. In accordance with ASTM C494 Type A.
- E. Microsilica Admixture.
 - 1. Packaged in easily dispersing form.
- F. Water.
 - 1. Clean and potable,
 - 2. Free of impurities detrimental to concrete.
- G. Reinforcing Bars.
 - 1. See Section 3200.
- H. Welded Wire Fabric
 - 1. See Section 3200.
- I. Accessories.
 - 1. See Section 3200.
- J. Tie wire.
 - 1. See Section 3200.
- K. Form Ties and Spreaders.
 - 1. See Section 3100.
- L. Form Coatings.
 - 1. Non-grain raising and non-staining type that will not leave residual matter on surface of concrete or adversely affect proper bonding of subsequent application of other material applied to concrete surface.
 - 2. "Nox-Crete Form Coating" as manufactured by Nox-Crete Company, or approved equal.
 - 3. Coatings containing mineral oils or the non-drying ingredients will not be permitted.
- M. Grout.
 - 1. See Section 3604.

2.02 CONCRETE STRENGTHS AND PROPORTIONS

- A. Cast-in-place concrete shall have the minimum compressive strength at 28 days as indicated on the Drawings.
- B. The exact proportions for the mix, including amounts admixture (if any), and water, shall be determined by the concrete supplier.
- C. The proportions of aggregate to cement for any concrete shall be such as to produce a mixture which will work readily into the corners and angles of the forms and around reinforcement, but without permitting the materials to segregate or excess free water to collect on the surface.

D. Air-Entrainment: The air content in all concrete shall be maintained at 5 to 7 percent.

2.03 PREMOLDED JOINT FILLER

1. See Section 3250.

2.04 POURABLE JOINT FILLERS

1. See Section 3250.

2.05 JOINT SEALANTS

A. In slabs.

1. In accordance with ASTM C920 for poured 2-component polyurethane sealant.
2. Sikaflex-2c, as manufactured by Sika Corporation or approved equivalent.

B. In walls.

1. Type II, Class A, compound conforming to Interim Federal Specification TT-S-00227E (3) (COM-NBS) for Sealing Compound; Elastomeric Type, Multi-Component (for Caulking, Sealing, and Glazing in Buildings and Other Structures).
2. Sikaflex-1a, as manufactured by Sika Corporation or approved equivalent.

2.06 EPOXY BONDING COMPOUND

- A. The epoxy bonding compound shall be a three-component, solvent-free, moisture-tolerant, epoxy modified, cementitious product specifically formulated as a bonding agent and anti-corrosion coating. The product shall have suitable contact time, fluidity, and application temperature for this type of application.

2.07 WATERSTOPS

- A. PVC Waterstops shall be in accordance with Section 03250 – Expansion, Construction, and Control Joints.

PART 3 EXECUTION

3.01 FORMWORK

1. See Section 3100.

3.02 REINFORCING STEEL

1. See Section 3200.

3.03 CONCRETE

A. Mixing of Concrete

1. All concrete shall be ready-mixed concrete, and shall be mixed and delivered in accordance with ASTM C 94. The batch plant of the concrete producer shall be certified for compliance with the standards established by the National Ready-Mixed Concrete Association.

2. In the event concrete is mixed at a central batching plant, the delivery shall be arranged so that intervals between batches are kept to a minimum, and in any event not more than thirty (30) minutes. Trucks shall be in first class condition and kept in constant rotation during delivery.
 3. Concrete shall be placed within 90 minutes after cement has been mixed with aggregate or 45 minutes after addition of water and admixtures.
 4. No admixtures, except those mentioned in paragraph 2.1 shall be used. Calcium chloride will not be permitted.
 5. Truck delivery slips of all concrete delivered to the job shall indicate the quantity and quality of concrete, additives, date and time of batching and delivery, and the location of placement. Delivery slips shall be forwarded to the Engineer at the end of each pour.
- B. Cold Weather Concreting.
1. In accordance with ACI 306.
 2. Concrete shall not be mixed or placed when the temperature is below 40 degrees F, or when conditions indicate that the temperature will fall below 40 degrees F within 72 hours unless precautions are taken to protect the concrete.
 3. Concrete temperature shall be maintained, when deposited, at not less than 60 degrees F. Reinforcement, forms, and ground which concrete will contact must be completely free of frost.
 4. Concrete and formwork must be kept at a temperature of not less than 50 degrees F. for not less than 96 hours after placing.
 5. Calcium chloride shall not be used.
- C. Hot Weather Concreting.
1. In accordance with ACI 305.
 2. The maximum temperature of the concrete, when deposited, shall be 85 degrees F. If the weather causes the placing temperature to exceed 85 degrees F., the mix shall be cooled by methods approved by the Engineer.
 3. No concrete shall be deposited when the air temperature is greater than 90 degrees F.
- D. Conveying and Placing Concrete.
1. In accordance with ACI 304.
 2. Notification: Before placing concrete, forms shall be thoroughly inspected. All chips, dirt, etc., shall be removed, all temporary bracing and cleats taken out, all openings for pipes, etc., properly boxed, all forms properly secured in their correct position and made tight, all reinforcement, anchors, and embedded items secured in their proper places. Concrete which may be on the forms or reinforcement, and which is set and dry, shall be cleaned off, and the forms and steel washed off before proceeding. Remove all foreign matter from forms and excavations.

3. Water shall be removed from place of deposit before concrete is placed unless otherwise permitted by the Engineer. Any flow of water into an excavation shall be diverted through proper side drains into a sump, or shall be removed by other approved methods which will avoid washing away the freshly deposited concrete.
4. Soil on which concrete will be poured shall be thoroughly wetted (except in freezing weather).
5. Anchors and Embedded Items: Anchors, bolts, sleeves, inserts, wood blocking, and any other items to be embedded in concrete shall be accurately secured in position before the concrete is placed. Aluminum shall not be embedded in concrete.

E. Handling and Depositing

1. Before any concrete is placed, notify all whose work is in any way connected with or influenced by the concrete work, and give them reasonable time to complete all portions of their work that must be completed before concrete is deposited.
2. Immediately before concrete is placed, inspect all forms to insure that they are in proper position, sufficiently rigid, thoroughly clean, properly oiled and free from foreign materials, and that all reinforcement is in proper position.
3. Concreting, once started, shall be carried on as a continuous operation until the section of approved size and shape is completed.
4. Concrete shall be conveyed as rapidly as practicable from the mixer to the place of final deposit by methods that prevent the separation or loss of ingredients. It shall be deposited, as nearly as practicable, in its final position to avoid rehandling or flowing.
5. Concrete shall not be dropped freely where reinforcement will cause segregation, nor shall it be dropped freely more than six (6) feet. Concrete shall be deposited to maintain a plastic surface approximately horizontal.
6. Concrete that has partially hardened shall not be deposited in the work.

F. Pumping

1. Concrete may be placed by pumping if first approved in writing by the Engineer for the location proposed.
2. Equipment for pumping shall be of such size and design as to ensure a practically continuous flow of concrete at the delivery end without separation of materials.
3. The concrete mix shall be designed to the same requirements as herein before specified, and may be richer in lubricating components in order to allow proper pumping.
4. Concrete shall not be pumped through aluminum pipes.

G. Vibrating and Compacting

1. All concrete shall be thoroughly consolidated and compacted by suitable means during the operation of placing, and shall be thoroughly worked around reinforcement, embedded items, and into the corners of the forms. All concrete against forms shall be thoroughly spaded. Internal vibrators shall be used under

experienced supervision, and shall be kept out of contact with reinforcement and wood forms. Vibrators shall not be used in a manner that forces mortar between individual form members.

2. Vibrators shall be flexible electric type or approved compressed air type, adequately powered and capable of transmitting to the concrete not less than seven thousand (7,000) impulses per minute. Vibration shall be sufficiently intense to cause the concrete to flow or settle readily into place without separation of the ingredients. A sufficient number of vibrators shall be employed so that complete compaction is secured throughout the entire volume of each layer of concrete. At least one (1) vibrator shall be kept in readiness as a spare for emergency use. Vibrators shall be such that the concrete becomes uniformly plastic with their use.
3. Vibration shall be close to the forms but shall not be continued at one spot to the extent that large areas of grout are formed or the heavier aggregates are caused to settle. Care shall be taken to not disturb concrete that has its initial set.
4. Where conditions make compacting difficult, or where the reinforcement is congested, batches of mortar containing the same proportions of cement to sand as used in the concrete shall first be deposited in the forms, to a depth of at least one inch.
5. The responsibility for providing fully filled out, smooth, clean, and properly aligned surfaces free from objectionable pockets shall rest entirely with the Contractor.

H. Construction Joints

1. Construction joints shall be located a maximum of 40 feet apart. If, for any reason, the contractor feels a change is necessary, he shall prepare a placing plan and submit it to the Engineer for approval.
2. Where a joint is to be made, the surface of the concrete shall be sandblasted or thoroughly picked, thoroughly cleaned, and all laitance removed. In addition to the foregoing, joints shall be thoroughly wetted, but not saturated, and slushed with a coat of grout immediately before the placing of new concrete.
3. Approved keys shall be used at all joints, unless detailed otherwise.
4. Forms shall be retightened before placing of concrete is continued. There shall be an interval of at least 48 hours between adjacent pours.

I. Bonding Concrete at Construction Joints

1. To new concrete construction joints:
 - a. Thoroughly clean and saturate joint with water.
 - b. Cover horizontal wall surfaces as specified in this Section, and immediately place concrete.
 - c. Limit concrete lift placed immediately on top of bonding compound to 12 inches thick.
 - d. Thoroughly vibrate to mix and consolidate bonding compound and concrete together.

J. Bonding new concrete to old concrete:

1. Mechanically roughen existing concrete surfaces to a clean, rough surface using appropriate mechanical means to remove the existing concrete surface, and provide a minimum roughness profile of 1/4-inch.
 2. Saturate surface with water for 24 hours, cover with epoxy bonding compound and place concrete as specified for new concrete.
- K. Expansion Joints
1. Expansion joints shall be located as shown on contract drawings.
 2. The joint shall include a joint filler, a bond breaker and joint sealant and installed as indicated on contract drawings.
- L. Joint Sealants.
1. See Section 7920.
- M. Patching
1. Immediately after stripping forms, patch minor defects, form-tie holes, honeycombed areas, etc., before concrete is thoroughly dry.
 2. Repair gravel pockets by cutting out to solid surface, form key, and thoroughly wet before placing patching mortar consisting of 1 part cement to 2 parts fine sand; compact into place and neatly finish. Honeycombed areas or gravel pockets which, in the Engineer's opinion are too large and unsatisfactory for mortar patching as described above, shall be cut out to solid surface, keyed, and packed solids with matching concrete to produce firm bond and surface.
 3. The Contractor shall do all the cutting as required by himself or other trades. All such work shall be of the minimum size required. No excessive cutting will be permitted, or shall any structural members or reinforcement be cut.
 4. The Contractor shall do all patching after work by other trades has been installed, where required, using Portland Cement Mortar 1:2 mix.
- N. Protection and Curing
1. Protect concrete from injurious action of the elements and defacement of any nature during construction operations.
 2. Keep concrete in a thoroughly moist condition from the time it is placed until it has cured, for at least (7) days.
 3. Carefully protect exposed concrete corners from damage.
 4. Allow no slabs to become dry at any time until curing operations are complete. In general, slabs shall be cured with non-staining curing paper, hosing or fog spray; vertical surfaces shall be curing with Burlene or fog spray or an approved curing compound.
 5. Protect fresh concrete from drying winds, rain, damage, or spoiling. Curing paper shall be lapped 4 inches minimum at joints and sealed with waterproof tape.
- O. Finishing Formed Surfaces
1. General: Addition of Material: The addition of cement, sand, water or mortar to slab surfaces while finishing concrete is strictly prohibited.

2. Rough-Formed Finish: This finish has an as-cast texture imparted by the form-facing material with tie holes and defective areas repaired and patched. Remove fins and other projections exceeding the limits specified by ACI 117 for the class of surface specified.
 - a. All surfaces that will be permanently concealed below grade shall have a Rough-Formed Finish.
3. Smooth-Formed Finish: This finish has an as-cast texture imparted by the form-facing material, arranged in an orderly and symmetrical manner with a minimum of seams. Repair and patch tie holes and defective areas. Remove all fins and other projections.
 - a. Apply a Smooth-Formed Finish to all surfaces to be covered with a coating or covering material applied directly to the concrete such as waterproofing, dampproofing, veneer plaster or painting.
 - b. Apply to the interior surfaces of tanks holding process water.
 - c. Apply to baffle walls in the wet well.
 - d. Do not apply rubbed finish to smooth-formed finish.
4. Rubbed Finish:
 - a. Smooth-Rubbed Finish: Not later than one day after form removal, moisten the concrete surfaces and rub with a silicon-carbide brick to produce a uniform color and texture. Do not apply cement grout other than that created by the rubbing process. Apply to the surfaces that will be permanently exposed to view.
 - b. Grout-Cleaned Finish: Wet the concrete surfaces and apply a grout of a consistency of thick paint to coat the surfaces and small holes. Mix one part Portland cement to one and one-half parts fine sand with a 1:1 mixture of bonding admixture and water. When the grout whitens, rub the surface with clean burlap and keep the surface damp with a fog spray for at least 36 hours. Apply Grout-Cleaned Finish to the surfaces of all channels that will carry flowing process water. This requirement is applicable to the concrete surfaces of the wet well.
5. Related Unformed Surfaces:
 - a. At tops of walls, horizontal offsets and similar unformed surfaces adjacent to formed surfaces, strike off smooth and finish with a texture matching the adjacent formed surfaces. Continue the final surface treatment of formed surfaces uniformly across adjacent unformed surfaces unless otherwise specified.
6. Finishing Floors and Slabs
 - a. General: Addition of Material: The addition of cement, sand, water, or mortar to slab surfaces while finishing concrete is strictly prohibited.
 - b. Comply with the recommendations of ACI 302.1R for screeding, restraightening and finishing operations for concrete surfaces.
 - c. Float Finish:
 - 1) Consolidate the surface with power-driven floats or by hand floating if the area is small or inaccessible to power-driven floats. Restraighten, cut down high spots and fill in low spots. Repeat float passes and

restraightening until the surface is left with a uniform, smooth granular texture.

2) Apply float finish surfaces to receive a trowel finish.

d. Trowel Finish:

1) After applying float finish, apply first trowel finish and consolidate concrete by hand or power driven trowel. Continue troweling passes and restraighten until the surface is free of trowel marks and is uniform in texture and appearance. Grind smooth any surface defects that would telegraph through applied coatings or floor coverings.

2) Apply a trowel finish to interior floor and slab surfaces exposed to view or to be covered with resilient flooring, carpet or ceramic tile and the wet well trench floor.

3) Finish surfaces to the following tolerances measured within 24 hours of troweling according to ASTM E 1155 for a randomly trafficked floor surface.

4) Specified overall values of flatness, FF 25; and levelness, FL 20; with minimum local values of flatness, FF 17; and levelness, FL 15.

e. Broom Finish

1) Immediately after float finishing, slightly roughen trafficked surface by brooming with a fiber-bristle broom. Broom transverse to traffic or at right angles to the slope of the slab. Permit surface to harden sufficiently to retain the scoring or ridges.

2) Apply a broom finish to all exterior concrete pads, walkways and slabs on grade.

P. Defective Work

1. The following concrete work shall be considered defective and may be ordered by the Engineer to be removed and replaced at Contractor's expense:

a. Incorrectly formed.

b. Not plumb or level.

c. Not specified strength.

d. Containing rock pockets, voids, honeycomb, or cold joints.

e. Containing wood or foreign matter.

f. Otherwise not in accordance with the intent of the Drawings and Specifications.

END OF SECTION

(THIS PAGE INTENTIONALLY LEFT BLANK)

SECTION 03320

CONCRETE SEALANT

PART 1 GENERAL

1.01 SECTION INCLUDES

- A. Requirements to seal all exposed concrete shown on the drawings or specified herein.

1.02 REFERENCES

- A. American Society for Testing and Materials (ASTM).
 - 1. C309, Specification for Liquid Membrane-Forming Compounds for Curing Concrete.

1.03 SUBMITTALS

- A. In accordance with Section 01300.
- B. Shop Drawings:
 - 1. Curing methods proposed.
 - 2. Manufacturer's data for the following products:
 - a. Exposed aggregate finish retardant on formed surface.
 - b. Evaporation retardant.
 - c. Curing compound.
 - d. Clear sealer.
 - e. Clear floor hardener.
- C. Quality Control Submittals:
 - 1. Curing Compound: Manufacturer's Certificate of Compliance showing moisture retention requirements.
 - 2. Retardants for Exposed Aggregate Finish: Manufacturer's Certification of Compliance.

PART 2 PRODUCTS

2.10 MATERIALS

- A. Curing Compound:
 - 1. Solvent-based, high chlorinated rubber solids content curing compound meeting requirements of ASTM C309.
 - a. Moisture Loss: 0.030 gm/square cm/72 hours maximum.
 - b. Capable of meeting moisture retention with one coat.
 - 2. Manufacturers and Products:

- a. Master Builders Co., Cleveland, OH; Masterkure CR.
 - b. Euclid Chemical Co., Cleveland, OH; Euco Super Floor Coat.
 - c. Or equal.
- B. Evaporation Retardant:
- 1. Optional: Fluorescent color tint that disappears completely upon drying.
 - 2. Manufacturers and Products:
 - a. Master Builders Co., Cleveland, OH; CONFILM.
 - b. Euclid Chemical Co., Cleveland, OH; Eucoar.
 - c. Or equal.
- C. Clear Sealer (One-Component Penetrating Silane Siloxane Sealer):
- 1. Manufacturers and Products:
 - a. Master Builders, Inc.; MASTERSEAL SL.
 - b. Euclid Chemical Co.; Eucoguard 200.
 - c. Or equal.
- D. Clear Floor Hardener:
- 1. Colorless, aqueous premixed solution of zinc and magnesium fluosilicate.
 - 2. Each gallon of fluosilicate solution shall contain minimum 2 pounds of crystals.
- E. Water: Clean and potable, containing less than 50 ppm of chlorides.

PART 3 EXECUTION

3.10 CURING OF CONCRETE

- A. Use one of the following methods as approved by ENGINEER:
- 1. Walls:
 - a. General: Where walls are to receive coatings, painting, cementitious material, or other similar finishes, or where solvent-based coatings are not permitted, use only water curing procedures.
 - b. Method 1: Leave concrete forms in place and keep entire surfaces of forms and concrete wet for 7 days.
 - c. Method 2: Apply curing compound, where allowed, immediately after removal of forms.
 - d. Method 3: Continuously sprinkle with water 100 percent of exposed surfaces for 7 days starting immediately after removal of forms.
 - 2. Slabs and Curbs:
 - a. Method 1: Protect surface by water ponding for 7 days.
 - b. Method 2: Cover with burlap or cotton mats and keep continuously wet for 7 days.
 - c. Method 3: Cover with 1-inch layer of wet sand, earth, or sawdust, and keep continuously wet for 7 days.
 - d. Method 4: Continuously sprinkle exposed surface for 7 days.

- e. Other agreed upon method that will keep moisture present and uniform at all times on surface of slabs. Do not use curing compounds.
 - f. Where water curing for slabs during cold weather is not possible, use an ENGINEER-approved curing compound at manufacturer's recommended coverage per gallon.
 - g. Where curing compound cannot be used, special methods using moisture shall be agreed upon prior to placing the concrete slabs.
 - h. Protect slabs during cold weather with plastic sheets or other materials inside required heated enclosure if foot traffic is permitted on slabs.
- B. Use only water curing on potable water structures.
- C. Use only water curing methods where solvents in the curing compounds are prohibited by state or federal air quality laws.
- D. Use only water curing where additional finishes such as clear sealer, hardeners, painting, and other special coatings are required.

3.20 EVAPORATION RETARDANT APPLICATION

- A. Spray onto surface of fresh flat work concrete immediately after screening to react with surface moisture.
- B. Reapply as needed to ensure a continuous moist surface until final finishing is completed.

3.30 CLEAR SEALER APPLICATION

- A. Apply where indicated in Finish Schedule.
- B. Before application, water cure concrete walls and floors to receive sealer for a minimum of 28 days, keep clean, unpainted, free from membrane curing compounds, with Work above them completed.
- C. Apply with stiff brush, short nap roller, squeegee, garden sprayer, or conventional paint spray equipment.
- D. Apply at a coverage rate of 125 to 200 square feet per gallon and cure the sealer on slabs for the following minimum cure time at the ambient temperatures shown prior to allowing foot traffic:
 - 1. 90 degrees F - 2 hours.
 - 2. 75 degrees F - 4 hours.
 - 3. 50 degrees F - 8 hours.
 - 4. 35 degrees F - 16 hours.

3.40 CLEAR HARDENER APPLICATION

- A. Before application, water cure floors to receive hardener for minimum 28 days, keep clean, unpainted, free to membrane curing compounds, and perfectly dry with all work above them completed.
- B. Apply hardener evenly, using three coats, allowing 24 hours between coats.
 - 1. First coat 1/3 strength, second coat 1/2 strength, and third coat 2/3 strength, mix with water.
 - 2. Apply each coat so as to remain wet on surfaces for 15 minutes.
 - 3. Apply approved hardeners in accordance with manufacturer's instructions.
 - 4. After final coat is completed and dry, remove surplus hardener from surface by scrubbing and mopping with water.

3.50 MANUFACTURER'S SERVICES

- A. Provide manufacturer's representative at site for installation assistance, inspection, and certification of proper installation for products specified.
- B. Provide clear sealer manufacturer's representative to demonstrate proper application of product.
- C. Provide floor hardener manufacturer's representative to demonstrate proper mixing and application of product.
- D. Provide curing compound manufacturer's representative to demonstrate proper application of curing compound to show coverage in one coat.

END OF SECTION

SECTION 03604

NON-SHRINK CONSTRUCTION GROUT

PART 1 GENERAL

1.01 SECTION INCLUDES

- A. This Section specifies furnishing and installing non-shrink grout for interior and exterior use, as indicated.

1.02 REFERENCES

- A. U.S. Corps of Engineers CRP - C - 588
- B. ACI - 305, American Concrete Institute
- C. ACI - 306, American Concrete Institute

1.04 SUBMITTALS

- A. Product Data: Provide data on non-shrink grout.
- B. Submit certificate of compliance attesting to conformance of products to the requirements of this Section.
- C. Submit manufacturers' installation and application instructions for products.

1.05 PRODUCT DELIVERY, STORAGE, AND HANDLING

- A. Deliver materials in original, tightly sealed, polyethylene lined, multiple ply bags, clearly labeled with manufacturer's name, brand name and number, and batch number of the material.

1.06 JOBSITE CONDITIONS

- A. Ensure surfaces to be grouted or patched are clean and sound, and are not feathered at edges. Handle grout as concrete with regard to temperature and curing, as specified in Section 03300.
- B. Observe safety precautions as outlined in the manufacturer's literature and as printed on containers and labels.

PART 2 - PRODUCTS

2.01 GENERAL

- A. Premixed grout comprised of blended portland cements, graded silica aggregates, special plasticizing agents and other ingredients.
- B. Conform to requirements of U.S. Corps of Engineers CRD-C-588 and to the following performance requirements listed in Article 2.02 when tested at the moderate fluidity, flowable, level.
- C. The grout shall exhibit a small but predictable amount of expansion sufficient to counteract the normal shrinkage of cement, and shall be dimensionally stable. The expansion shall

occur after initial set to insure maximum contact between grout and base plates. The grout shall be extremely flowable at low water levels and shall not bleed at the moderate fluidity level specified nor exhibit segregation of aggregates. At a highly flowable consistency, high compressive strength shall be attainable in a 24-hour period with continuous build-up for 28 days. The resulting cured material shall be very hard and highly resistant to penetration and breakdown by oils, water or vibration grout shall contain no iron particles, gypsum, gas forming agents, no added chloride, and shall not react with magnesium.

2.02 PERFORMANCE REQUIREMENTS

- A. When tested as provided herein, grout shall meet the following performance requirements:
 - 1. When tested as provided herein, grout shall meet the following performance requirements:
 - 1. Expansion at 3, 14, and 28 days: 0.4 percent maximum at any of these ages.
 - 2. Expansion at 3 and 14 days: not greater than expansion at 28 days.
 - 3. Shrinkage at 28 days: none, these requirements will be met if expansion tests give a positive value at 28 days.
 - 4. Compressive strength:
 - a. At seven days: 2500 psi min.
 - b. At 28 days: 5000 psi min.
 - 5. Time of final setting: eight hours max.
 - 6. Moderate fluidity, flowable: 124-145 (flow table, 5 drops, CRDC-277).

2.03 DEGREASING AND ETCHING CHEMICAL

- A. Composition and Materials: Blend of organic and inorganic acids with a special solvent system incorporating wetting agents for emulsification.
- B. Color: Water White
- C. Flash Point: Above 150°F
- D. Weight per gallon: 9.0 Pounds

PART 3 EXECUTION

3.01 PREPARATION OF CONCRETE SURFACES

- A. Remove dust, laitance, grease, curing compounds, impregnations, waxes, foreign particles, and disintegrated materials by mechanical abrasion methods such as sandblasting. Sandblast structural and reinforcing steel to remove loose material and expose sound metal.
- B. If the concrete surfaces are sound and it is only necessary to remove laitances, grease or dust, the Contractor may, with the prior written approval of the Engineer, forego sandblasting and wash the concrete with a degreasing and etching chemical applied in accordance with the manufacturer's written instructions and as specified herein.
- C. Application of Degreaser and Etching Compound. Prewet concrete surfaces with clean water. Brush concentrated cleaner onto concrete surface. Let stand three to four minutes and

reapply, brushing stained areas vigorously. Rinse off with fresh water applied at a minimum pressure of 800 psi and a minimum volume of five gallons per minute.

- D. Construct appropriate sturdy forms to contain grout at the fluidity level at which it will be used. Saturate foundations and forms for a minimum of six hours prior to grouting. Remove all standing water or puddles prior to application of grout. Take special care to eliminate water from bolt holes and other cavities.

3.02 MIXING

- A. Mix only with cool, clean, drinkable water. Do not overwater grout. Do not mix more grout than can be properly placed within 20 minutes of mixing.

3.03 APPLICATION

- A. Place grout only from one side of base plates to avoid entrapping air. Provide adequate air vent holes in large base plates. Work or flow grout into place, filling all cavities. Shut down near-by equipment which may cause vibration. Allow adequate curing time for strength development before placing a load on the grout.
- B. Place grout within twenty minutes of the addition of water to the batch.
- C. Reinforce grout pads or applications three inches or more in thickness with wire mesh or reinforcement bars.
- D. Rodding or chaining is acceptable to assist in placement or consolidation of grout. Excessive mechanical vibration may cause segregation of aggregates and will not be permitted.
- E. Cool mixing water and grout when temperature exceeds 80°F. in the area to be grouted. Comply with ACI-305. Cure and seal exposed grout with epoxy membrane curing compound to prevent rapid surfacing drying, shrinkage and cracking, or damp cure the grout.
- F. Heat mixing water and grout when temperature falls below 50°F in the area to be grouted. Do not exceed 80°F. Comply with ACI-306. Do not add accelerators to grout.

3.04 AGGREGATE EXTENSIONS

- A. Where indicated, extend the yield of expansive-cement type grout by utilizing aggregate filler in the size range of 3/8 inch washed pea gravel. Run trial mixes verifying the acceptability of this extended grout mix to the Engineer prior to use.

END OF SECTION

(THIS PAGE INTENTIONALLY LEFT BLANK)

SECTION 04100

MORTAR AND MASONRY GROUT

PART 1 GENERAL

1.01 SUMMARY

A. Section Includes

1. Requirements to furnish, prepare, and protect as a perishable material, mortar and grout, complete with specified admixtures for use in the installation of masonry structures.

B. Related Sections

1. Section 04230 – Reinforced Unit Masonry

1.02 REFERENCES

A. American Society for Testing and Materials (ASTM)

1. C144, Specification for Aggregate for Masonry Mortar.
2. C150, Specification for Portland Cement.
3. C207, Specification for Hydrated Lime for Masonry Purposes.
4. C270, Specification for Mortar for Unit Masonry.
5. C404, Specification for Aggregates for Masonry Grout.
6. C476, Specification for Grout for Masonry.
7. C780, Test Method for Preconstruction and Construction Evaluation of Mortars for Plain and Reinforced Unit Masonry.

1.03 SUBMITTALS

A. In accordance with Section 01300.

B. Product Data

1. Submit manufacturer's product data for each product, including certification that each product complies with the specified requirements.

C. Samples

1. Before the start of work samples of sand shall be submitted to the Engineer for approval.

1.04 DELIVERY, STORAGE AND HANDLING

A. Store cementitious materials off the ground, under cover and in dry location. Store in their original containers, plainly marked with identification of material and maker. Materials in broken containers, or in packages showing water marks or other evidence of damage, shall not be used and shall be removed from the site.

B. All perishable materials included in this Section shall be delivered, stored and handled so as to prevent deterioration, intrusion of foreign matter or moisture, or damage of any nature.

PART 2 PRODUCTS

2.01 MANUFACTURES

- A. Obtain mortar ingredients of uniform quality, including color for exposed masonry, from one manufacturer for each cementitious component and from one source and producer for each aggregate.

2.02 COMPONENTS

A. Portland Cement

- 1. ASTM C150, Type II. The same brand and color of cement shall be used throughout the job to ensure uniformity of color.

B. Hydrated Lime

- 1. ASTM Designation C207, Type S.

C. Aggregate for Mortar

- 1. ASTM Designation C144
- 2. Clean, durable particles, free from injurious amounts of organic matter.

D. Aggregate for Grout

- 1. ASTM Designation C404

E. Water

- 1. Clean and Potable

F. Mortar Color

- 1. Chemically inert, non-fading color, manufactured from alkali fast mineral oxides, finely ground and specifically prepared for use in cement and lime mortars. They shall be added to the mixture where so specified and used in accordance with the manufacturer's recommendations. Colored mortar shall be used on all new building face brick and, as standard of color only, shall be Davis Colors, 7011 Muirkirk Rd., Beltsville, MD 20705; "Chromix" L.M. Schofield Company, 6533 Bandini Blvd., Los Angeles, CA 90040; Solomon Grind-Chem Service, Springfield, Ill. 62705, or equal. Color shall match the existing mortar color.
- 2. Color of mortar joints on both new and existing masonry work is to be the same. Color shall be selected by the Engineer from the manufacturer's full range of standard colors.

2.03 MORTAR AND GROUT MIXES

A. General

- 1. No air-entraining admixtures or cementitious materials containing air-entraining admixtures shall be used in the mortar. No anti-freeze liquids, salts, or other substances shall be used in the mortar or grout to lower the freezing point. Calcium chloride or admixtures containing calcium chloride shall not be used in mortar or grout. Integral water-proofing compounds, accelerators, or other admixtures shall not be used in mortar or grout without approval in writing by the Engineer.

B. Grout

- 1. In accordance with ASTM Designation C476, for grout for use in construction of reinforced and nonreinforced masonry, and shall be mixed 2 1/2 cubic feet of sand to one bag of cement, adding only enough water to make a flowable consistency. Neat grout

shall be composed of cement and water only. Non-staining cement shall be used for non-staining grout.

2. Use grout of the appropriate consistency (fine or course) as follows:
 - a. Fine grout in spaces less than 4 inches in any horizontal dimension.
 - b. Course grout in spaces greater than 4 inches in any horizontal dimension.

C. Mortar

1. In accordance with ASTM C270. (Proportional Specification)
2. The mortar mixtures hereinafter tabulated are standard mixtures for which measurement shall be by volume. For the purposes of these Specifications, the weight of one cubic foot of the respective materials used as ingredients in the mortar shall be as follows:

<u>Materials</u>	<u>Weight, lb per cu ft (kg/m³)</u>
Portland Cement	94(1504)
Hydrated Lime	40(640)
Sand, damp and loose	80(1280) dry sand

3. The Contractor shall use mortar Type M for all masonry work. Quantities of materials in parts by volume shall be in accordance with ASTM C-270.
4. Mortar ingredients shall be accurately measured by volume in boxes especially constructed for the purpose by the Contractor, or by other method approved in writing by the Engineer. Measurement by shovel will not be allowed.
5. Mortar shall be machine mixed in an approved type of mixer in which the quantity of water can be accurately and uniformly controlled. The mixing time shall not be less than 5 minutes, approximately two minutes of which shall be for mixing the dry materials and not less than three minutes for continuing the mixing after the water has been added. Where hydrated lime is used for mortar requiring a lime content, the Contractor will have the option of using the dry-mix method or first converting the hydrated lime into a lime putty as specified below. Where the dry-mix method is employed, the materials for each batch shall be well turned over together until the even color of the mixed, dry materials indicates that cementitious material has been thoroughly distributed throughout the mass, after which the water shall be gradually added until a thoroughly mixed mortar of the required plasticity is obtained.
6. All mortar shall be freshly mixed and the quantity of each batch shall not be in excess of the amount that will be used before the same has started to set. Mortar that has begun to set shall not be used. Retempering will not be permitted. Mixer drums shall be entirely emptied of a batch before charging with a succeeding batch. Mortar boxes shall be cleaned out at the end of each day's work, and all tools shall be kept clean.

PART 3 EXECUTION

3.01 MIXING

- A. Cementitious materials and aggregate shall be mixed between 3 and 5 minutes in a mechanical batch mixer with the maximum amount of water to produce a workable consistency.

3.02 PLACING MORTAR

- A. In accordance with the requirements of Section 04200.

3.03 GROUTING MASONRY CELLS

- A. In accordance with Section 04230.

3.04 TESTING

- A. Construction-site-prepared mortar shall be tested in accordance with ASTM C780
- B. Samples tested during the progress of the work may be accepted on the basis of the 7 day test. The right is reserved to rescind such acceptance if the mortar fails on the 28 day test.
- C. Costs for testing shall be in accordance with Section 01410.

END OF SECTION

SECTION 04200

UNIT MASONRY

PART 1 - GENERAL

1.01 GENERAL PROVISIONS

- A. Attention is directed to the CONTRACT AND GENERAL CONDITIONS and all Sections within DIVISION 01 - GENERAL REQUIREMENTS which are hereby made a part of this Section of the Specifications.

1.02 DESCRIPTION OF WORK

- A. Work Included: Provide labor, materials and equipment necessary to complete the work of this Section, including but not limited to the following:
1. Concrete masonry units.
 2. Face brick.
 3. Embedded and through-wall flashing.
 4. Mortar and grout.
 5. Reinforcing steel, masonry joint reinforcement, ties and anchors.
- B. Items To Be Installed Only:
1. Section 05500 - METAL FABRICATIONS:
 - a. Lintels, miscellaneous metal and iron sleeves, anchors, inserts and plates to be built into masonry walls.
 2. Section 06100 - ROUGH CARPENTRY:
 - a. Wood nailers and blocking built into masonry.
 3. Section 08311 - ACCESS DOORS AND FRAMES
 - a. Access doors and frames in masonry openings.
- C. Items To Be Furnished Only:
1. Section 03300 - CAST-IN-PLACE CONCRETE:
 - a. Dovetail slots for masonry anchors.
 2. Section 05120 - STRUCTURAL STEEL FRAMING:
 - a. Anchor sections of adjustable masonry anchors for connecting to structural frame.
- D. Related Work: The following items are not included in this Section and are specified under the designated Sections:
1. Section 07210 - THERMAL INSULATION for cavity wall insulation.

2. Section 07270 - AIR BARRIERS for membrane air barrier.
3. Section 07844 - FIRE-RESISTIVE JOINT SYSTEMS for fire-resistive joint systems openings in masonry walls and at heads of masonry walls.
4. Section 07920 - JOINT SEALANTS for sealing control and expansion joints in unit masonry.

1.03 SUBMITTALS

- A. Product Data: For each type of product indicated.
- B. Shop Drawings: For the following:
 1. Masonry Units: Show sizes, profiles, coursing, and locations of special shapes.
 2. Reinforcing Steel: Detail bending and placement of unit masonry reinforcing bars. Comply with ACI 315, "Details and Detailing of Concrete Reinforcement."
- C. Samples for Verification: For each type and color of the following:
 1. Exposed concrete masonry units.
 2. Face brick, in the form of straps of five or more bricks.
 3. Pigmented mortar. Make Samples using same sand and mortar ingredients to be used on Project. Label Samples to indicate types and amounts of pigments used.
 4. Weep holes/vents.
 5. Accessories embedded in masonry.
- D. Qualification Data: For testing agency.
- E. Material Certificates: Include statements of material properties indicating compliance with requirements including compliance with standards and type designations within standards. Provide for each type and size of the following:
 1. Masonry units:
 - a. Include material test reports substantiating compliance with requirements.
 - b. For bricks, include size-variation data verifying that actual range of sizes falls within specified tolerances.
 - c. For exposed brick, include material test report for efflorescence according to ASTM C 67.
 - d. For masonry units used in structural masonry, include data and calculations establishing average net-area compressive strength of units.
 2. Cementitious materials. Include brand, type, and name of manufacturer.
 3. Mortar mixes. Include description of type and proportions of ingredients.
 4. Grout mixes. Include description of type and proportions of ingredients.
 5. Reinforcing bars.
 6. Joint reinforcement.
 7. Anchors, ties, and metal accessories.

- F. Mix Designs: For each type of mortar and grout. Include description of type and proportions of ingredients.
 - 1. Include test reports, per ASTM C 780 for mortar mixes required to comply with property specification.
 - 2. Include test reports, per ASTM C 1019 for grout mixes required to comply with compressive strength requirement.
- G. Cold-Weather Procedures: Detailed description of methods, materials, and equipment to be used to comply with cold-weather requirements.

1.04 QUALITY ASSURANCE

- A. Testing Agency Qualifications: An independent agency qualified according to ASTM C 1093 for testing indicated, as documented according to ASTM E 548.
- B. Source Limitations for Masonry Units: Obtain exposed masonry units of a uniform texture and color, or a uniform blend within the ranges accepted for these characteristics, through one source from a single manufacturer for each product required.
- C. Source Limitations for Mortar Materials: Obtain mortar ingredients of a uniform quality, including color for exposed masonry, from a single manufacturer for each cementitious component and from one source or producer for each aggregate.
- D. Preconstruction Testing Service: The Owner will engage a qualified independent testing agency to perform preconstruction testing indicated below. Payment for these services will be made by the Owner. Retesting of materials that fail to meet specified requirements shall be done at Contractor's expense.
 - 1. Prism Test: For each type of construction required, per ASTM C 1314.
- E. Fire-Resistance Ratings: Where indicated, provide materials and construction identical to those of assemblies with fire-resistance ratings determined per ASTM E 119 by a testing and inspecting agency, by equivalent concrete masonry thickness, or by other means, as acceptable to authorities having jurisdiction.
- F. Mock-Up Panels: Build mock-up panels on-site but off the building to verify selections made under sample submittals and to demonstrate aesthetic effects. Comply with requirements in Division 01 for mockups.
 - 1. Build mock-up panels for typical exterior and interior walls in sizes as shown on drawings by full thickness.
 - 2. Clean one-half of exposed faces of panels with masonry cleaner indicated.
 - 3. Protect approved mock-up panels from the elements with weather-resistant membrane.
 - 4. Approval of mock-up panels is for color, texture, and blending of masonry units; relationship of mortar and sealant colors to masonry unit colors; tooling of joints;

aesthetic qualities of workmanship; and other material and construction qualities specifically approved by Engineer in writing.

- a. Approval of mock-up panels does not constitute approval of deviations from the Contract Documents contained in sample panels unless such deviations are specifically approved by Engineer in writing.

- G. Preinstallation Conference: Conduct conference at Project site to comply with requirements in Division 01. Agenda shall include protection of air barrier membrane during construction.

1.05 DELIVERY, STORAGE, AND HANDLING

- A. Store masonry units on elevated platforms in a dry location. If units are not stored in an enclosed location, cover tops and sides of stacks with waterproof sheeting, securely tied. If units become wet, do not install until they are dry.
- B. Store cementitious materials on elevated platforms, under cover, and in a dry location. Do not use cementitious materials that have become damp.
- C. Store aggregates where grading and other required characteristics can be maintained and contamination avoided.
- D. Deliver preblended, dry mortar mix in moisture-resistant containers designed for lifting and emptying into dispensing silo. Store preblended, dry mortar mix in delivery containers on elevated platforms, under cover, and in a dry location or in a metal dispensing silo with weatherproof cover.
- E. Store masonry accessories, including metal items, to prevent corrosion and accumulation of dirt and oil.

1.06 PROJECT CONDITIONS

- A. Protection of Air Barrier Membrane: During construction, protect air barrier membrane from penetrations which allow air to pass through air barrier assemblies. Engage original installer to repair damage promptly using identical materials and methods of installation, and to the satisfaction of the Engineer.
- B. Protection of Masonry: During construction, cover tops of walls, projections, and sills with waterproof sheeting at end of each day's work. Cover partially completed masonry when construction is not in progress.
 1. Extend cover a minimum of 24 inches down both sides and hold cover securely in place.
 2. Where 1 wythe of multiwythe masonry walls is completed in advance of other wythes, secure cover a minimum of 24 inches down face next to unconstructed wythe and hold cover in place.

- C. Do not apply uniform floor or roof loads for at least 12 hours and concentrated loads for at least 3 days after building masonry walls or columns.
- D. Stain Prevention: Prevent grout, mortar, and soil from staining the face of masonry to be left exposed or painted. Immediately remove grout, mortar, and soil that come in contact with such masonry.
 - 1. Protect base of walls from rain-splashed mud and from mortar splatter by spreading coverings on ground and over wall surface.
 - 2. Protect sills, ledges, and projections from mortar droppings.
 - 3. Protect surfaces of window and door frames, as well as similar products with painted and integral finishes, from mortar droppings.
 - 4. Turn scaffold boards near the wall on edge at the end of each day to prevent rain from splashing mortar and dirt onto completed masonry.
- E. Cold-Weather Requirements: Do not use frozen materials or materials mixed or coated with ice or frost. Do not build on frozen substrates. Remove and replace unit masonry damaged by frost or by freezing conditions. Comply with cold-weather construction requirements contained in ACI 530.1/ASCE 6/TMS 602.
 - 1. Cold-Weather Cleaning: Use liquid cleaning methods only when air temperature is 40 deg F and above and will remain so until masonry has dried, but not less than 7 days after completing cleaning.
- F. Hot-Weather Requirements: Comply with hot-weather construction requirements contained in ACI 530.1/ASCE 6/TMS 602.

PART 2 - PRODUCTS

2.01 BRICK

- A. Face brick shall be extruded brick conforming to the applicable requirements of ASTM Designation C216 for Grade SW, Type FBS and shall be "A" quality having a clear face and two clear ends.
 - 1. Trade Reference and Color: As selected by Architect.
 - 2. Face brick shall be modular size, 2-1/4 inches by 7-5/8 inches face by 3-5/8 inches depth except where special brick is noted on Drawings.
 - 3. As standard of color and texture only, color and texture shall match the existing brick of adjacent buildings.
 - 4. Brick will be solid, and shall conform in all respects to the requirements of applicable building codes.
 - 5. Lip bricks shall be provided as shown on Drawing.
 - 6. Brick with absorption greater than 8 percent by weight shall not be accepted.
- B. Building (Common) Brick where Concealed: ASTM C 62, Grade SW.

2.02 CONCRETE MASONRY UNITS (CMUs)

- A. Concrete Masonry Units: ASTM C 90, normal weight unless indicated otherwise manufactured to dimensions 3/8 inch less than nominal dimensions.
- B. Shapes: Provide standard shapes indicated and as required for building configuration. Provide special shapes for lintels, corners, jambs, sashes, movement joints, headers, bonding, and other special conditions.
 - 1. Provide corner blocks at locations and types as indicated on drawing. Includes 4x16x4x8 corner L-block.
- C. Integral Water Repellent: Provide units made with integral water repellent for exterior exposed units.
 - 1. Integral Water Repellent: Liquid polymeric, integral water-repellent admixture that does not reduce flexural bond strength. Units made with integral water repellent, when tested as a wall assembly made with mortar containing integral water-repellent manufacturer's mortar additive according to ASTM E 514, with test period extended to 24 hours, show no visible water or leaks on the back of test specimen. Available products include:
 - a. ACM Chemistries: RainBlock
 - b. Addiment Incorporated, a Div. of Grace Construction Products; Block Plus W-10.
 - c. Grace Construction Products; Dry-Block.
 - d. BASF Construction Chemicals; Rheopel.
- D. Defective Units: Referenced masonry unit standards may allow a certain percentage of units to exceed tolerances and to contain chips, cracks, or other defects exceeding limits stated in the standard. Do not use units where such defects, including dimensions that vary from specified dimensions by more than stated tolerances, will be exposed in the completed Work or will impair the quality of completed masonry.

2.03 MORTAR AND GROUT MATERIALS

- A. Portland Cement: ASTM C 150, Type I or II, except Type III may be used for cold-weather construction. Provide natural color or white cement as required to produce mortar color indicated.
- B. Hydrated Lime: ASTM C 207, Type S.
- C. Mortar Pigments: Natural and synthetic iron oxides and chromium oxides, compounded for use in mortar mixes. Use only pigments with a record of satisfactory performance in masonry mortar.
 - 1. Available Products:
 - a. LanXess; Bayferrox Iron Oxide Pigments.

- b. Davis Colors; True Tone Mortar Colors.
 - c. Solomon Grind-Chem Services, Inc.; SGS Mortar Colors.
- D. Aggregate for Mortar: ASTM C 144. For mortar that is exposed to view, use washed aggregate consisting of natural sand or crushed stone.
- E. Aggregate for Grout: ASTM C 404.
- F. Water-Repellent Admixture: Liquid water-repellent mortar admixture intended for use with concrete masonry units, containing integral water repellent by same manufacturer. Available products include:
- 1. Addiment Incorporated, a Div. of Grace Construction Products; Mortar Tite.
 - 2. Grace Construction Products, a unit of W. R. Grace & Co. - Conn.; Dry-Block Mortar Admixture.
 - 3. BASF Construction Chemicals; Rheopel Mortar Admixture.
- G. Water: Potable.

2.04 REINFORCEMENT

- A. Uncoated Steel Reinforcing Bars: ASTM A 615/A 615M or ASTM A 996/A 996M, Grade 60.
- B. Masonry Joint Reinforcement, General: ASTM A 951.
- 1. Interior Walls: Mill-galvanized, carbon steel.
 - 2. Exterior Walls: Hot-dip galvanized, carbon steel.
 - 3. Wire Size and Spacing: As required by Code.
 - 4. Provide in lengths of not less than 10 feet, with prefabricated corner and tee units.
- C. Masonry Joint Reinforcement for Multiwythe Masonry:
- 1. Ladder type with 1 side rod at each face shell of hollow masonry units more than 4 inches in width, plus 1 side rod at each wythe of masonry 4 inches or less in width.

2.05 TIES AND ANCHORS

- A. Materials: Provide ties and anchors specified in subsequent paragraphs that are made from materials that comply with subparagraphs below, unless otherwise indicated.
- 1. Mill-Galvanized, Carbon-Steel Wire: ASTM A 82; with ASTM A 641/A 641M, Class 1 coating.
 - 2. Hot-Dip Galvanized, Carbon-Steel Wire: ASTM A 82; with ASTM A 153/A 153M, Class B-2 coating.
 - 3. Stainless-Steel Wire: ASTM A 580/A 580M, Type 316.

4. Galvanized Steel Sheet: ASTM A 653/A 653M, Commercial Steel, G60 zinc coating.
5. Steel Plates, Shapes, and Bars: ASTM A 36/A 36M.
6. Stainless Steel Bars: ASTM A 276 or ASTM A 666, Type 304.

B. Anchorage to concrete formwork with Dovetail Slots and Anchors

1. 22 gage hot dip galvanized channel slots, with filler strips.
 - a. Bar type anchor, Manufacturers standard hot dip galvanized anchor with dovetail anchor section formed from 16 gage sheet metal, 7/8 inches wide, corrugated, turned up 1/4 inch at end.
 - b. Wire type anchor, 6 gage wire, triangular shaped.
2. Length shall be as shown on Drawings.
3. Manufactured by Dur-O-Wall, Inc. or equal.

C. Partition Top Anchors: 0.097-inch-thick metal plate with 3/8-inch-diameter metal rod 6 inches long welded to plate and with closed-end plastic tube fitted over rod that allows rod to move in and out of tube. Fabricate from steel, hot-dip galvanized after fabrication.

D. Thermally Broken Adjustable Masonry-Veneer Anchors:

1. General: Provide anchors that allow vertical adjustment but resist tension and compression forces perpendicular to plane of wall, for attachment over sheathing to wood or metal studs, with structural performance capable of withstanding a 100-lbf load in both tension and compression without deforming or developing play in excess of 0.05 inch.
2. Screw-Attached, Thermally Broken Masonry-Veneer Anchors: Units, equal to Thermal Concrete 2-Seal Wing Nut Anchor by Hohmann & Barnard, Inc. consisting of a wire tie, plastic wing nut, and a metal anchor section.
 - a. Anchor Section: Zinc-alloy barrel section with flanged head with plastic wing-nut and corrosion-resistant, self-drilling screw. Eye designed to receive wire tie and to serve as head for drilling fastener into framing. Barrel length to suit sheathing thickness, allowing screw to seat directly against framing with flanged head covering hole in sheathing.
 - b. Wire Ties: Triangular-, rectangular-, or T-shaped wire ties fabricated from 0.188-inch-diameter, hot-dip galvanized steel wire.

2.06 MISCELLANEOUS ANCHORS

- A. Anchor Bolts: L-shaped steel bolts complying with ASTM A 307, Grade A; with ASTM A 563 hex nuts and, where indicated, flat washers; hot-dip galvanized to comply with ASTM A 153/A 153M, Class C; of dimensions indicated.

2.07 EMBEDDED FLASHING MATERIALS

- A. Metal Flashing: Provide metal flashing complying with Section 07620 - SHEET METAL FLASHING AND TRIM and as follows:

1. Stainless Steel: ASTM A 240/A 240M, Type 304, 0.016 inch (0.40 mm) thick.
 2. Configuration: Provide continuous flashing including preformed outside and inside corners, and end dams with smooth uninterrupted soldered seams and hemmed edges to maintain continuity. See drawings for profiles required.
- B. Solder and Sealants for Sheet Metal Flashings: As specified in Section 07620 – SHEET METAL FLASHING AND TRIM.
- C. Adhesives, Primers, and Seam Tapes for Flashings: Flashing manufacturer's standard products or products recommended by flashing manufacturer for bonding flashing sheets to each other and to substrates. Verify compatibility between flashing materials and substrates.
- D. Drip Edge: Provide type 316, 0.016 inch thick stainless steel drip edge plates with factory applied adhesive strip for all through-wall flashing conditions. Provide preformed outside and inside corner drip plate corners with smooth uninterrupted soldered seams and hemmed drip edges to maintain continuity. Custom sizes will be required see drawings for profiles required.

2.08 MISCELLANEOUS MASONRY ACCESSORIES

- A. Compressible Filler: Premolded filler strips complying with ASTM D 1056, Grade 2A1; compressible up to 35 percent; of width and thickness indicated; formulated from neoprene.
- B. Expansion Joints:
1. In accordance with ASTM D1056, Grade RE41E1.
 2. Premolded, flexible cellular neoprene rubber filler strips.
 3. Capable of compression up to 35 percent.
- C. Preformed Control-Joint Gaskets: Polyvinyl chloride in accordance with ASTM D2287, General Purpose Grade, Designation PVC-63506 designed to fit standard sash block and to maintain lateral stability in masonry wall; size and configuration as indicated.
- D. Bond-Breaker Strips: Asphalt-saturated, organic roofing felt complying with ASTM D 226, Type I (No. 15 asphalt felt).
- E. Weep/Vent Products: Free-draining mesh; made from polyethylene strands, full height and width of head joint and depth 1/8 inch less than depth of outer wythe; in color selected from manufacturer's standard.
- F. Cavity Drainage Material: Free-draining mesh, made from polymer strands that will not degrade within the wall cavity. Provide strips, full-depth of cavity and 10 inches wide, with dovetail shaped notches 7 inches deep that prevent mesh from being clogged with mortar droppings or equivalent. Available products:

1. Advanced Building Products Inc.; Mortar Break II.
2. Archovations, Inc.; CavClear Masonry Mat.
3. Hohmann & Barnard, Dur-O-Wal Division; Polytite MortarStop.
4. Mortar Net USA, Ltd.; Mortar Net.

2.09 MASONRY CLEANERS

A. Proprietary Acidic Cleaner: Manufacturer's standard-strength cleaner designed for removing mortar/grout stains, efflorescence, and other new construction stains from new masonry without discoloring or damaging masonry surfaces. Use product expressly approved for intended use by cleaner manufacturer and manufacturer of masonry units being cleaned.

1. Available Manufacturers:
 - a. Diedrich Technologies, Inc.
 - b. EaCo Chem, Inc.
 - c. ProSoCo, Inc.

2.10 MORTAR AND GROUT MIXES

A. General: Do not use admixtures, including pigments, air-entraining agents, accelerators, retarders, water-repellent agents, antifreeze compounds, or other admixtures, unless otherwise indicated.

1. Do not use calcium chloride in mortar or grout.
2. Limit cementitious materials in mortar to portland cement and lime.

B. Mortar for Unit Masonry: Comply with ASTM C 270, Proportion Specification. Provide the following types of mortar for applications stated unless another type is indicated or needed to provide required compressive strength of masonry.

1. For masonry below grade or in contact with earth, use Type M.
2. For reinforced masonry, use Type S.
3. For exterior, above-grade, load-bearing and non-load-bearing walls and parapet walls; for interior load-bearing walls; for interior non-load-bearing partitions; and for other applications where another type is not indicated, use Type N.

C. Pigmented Mortar: Use colored cement product. Pigments shall not exceed 10 percent of portland cement by weight. Two colors required, typically to match color of CMU.

D. Grout for Unit Masonry: Comply with ASTM C 476.

1. Use grout of type indicated or, if not otherwise indicated, of type (fine or coarse) that will comply with Table 1.15.1 in ACI 530.1/ASCE 6/TMS 602 for dimensions of grout spaces and pour height.
2. Provide grout with a slump of 8 to 11 inches as measured according to ASTM C 143/C 143M.

PART 3 - EXECUTION

3.01 EXAMINATION

- A. Examine conditions, with Installer present, for compliance with requirements for installation tolerances and other conditions affecting performance of work.
 - 1. For the record, prepare written report, endorsed by Installer, listing conditions detrimental to performance of work.
 - 2. Verify that foundations are within tolerances specified.
- B. Before installation, examine rough-in and built-in construction for piping systems to verify actual locations of piping connections.
- C. Proceed with installation only after unsatisfactory conditions have been corrected.

3.02 INSTALLATION, GENERAL

- A. Install all items furnished under this Section in the finished work including items to be imbedded in concrete or masonry. Items to be attached to concrete or masonry after such work is completed shall be installed in accordance with the details shown on the Drawings. Fastening to wood plugs in masonry will not be permitted. All dimensions shall be verified at the site before fabrication is started.
- B. No masonry shall be laid when the temperature is below 32 deg F, unless adequate means are provided for maintaining a temperature above 32 deg F during and for 48 hours subsequent to laying. No frozen work shall be built upon. No masonry units having a film of frost on their surface shall be laid in the wall.
- C. Both interior and exterior concrete masonry units, shall be laid from scaffolds on the sides of walls from which the material is being laid. No overhead work will be permitted. Scaffolding shall be constructed and maintained in strict accordance with OSHA standards.
- D. The Contractor shall familiarize the masons with the specifications of other trades that connect with their work and shall otherwise assure that proper cooperation is obtained.
- E. The construction of exterior walls and partitions of rooms shall be scheduled to permit delivery and installation of all equipment, and the continuous operation of the facility without any interruption due to the construction.
- F. All aluminum and steel surfaces to come in contact with exposed concrete or masonry shall receive a protective coating of an approved heavy bitumastic troweling mastic applied in accordance with the manufacturer's instruction prior to installation.
- G.

- H. Thickness: Build cavity and composite walls and other masonry construction to full thickness shown. Build single-wythe walls to actual widths of masonry units, using units of widths indicated.
- I. Build chases and recesses to accommodate items specified in this and other Sections.
- J. Leave openings for equipment to be installed before completing masonry. After installing equipment, complete masonry to match the construction immediately adjacent to opening.
- K. Use full-size units without cutting if possible. If cutting is required to provide a continuous pattern or to fit adjoining construction, cut units with motor-driven saws; provide clean, sharp, unchipped edges. Allow units to dry before laying unless wetting of units is specified. Install cut units with cut surfaces and, where possible, cut edges concealed. Do not use units cut to less than one-half size.
- L. Do not install concrete masonry units with more than 5 percent damage to the face.
- M. Select and arrange units for exposed unit masonry to produce a uniform blend of colors and textures. Mix units from several pallets or cubes as they are placed.
- N. Matching Existing Masonry: Match coursing, bonding, color, and texture of existing masonry.
- O. Comply with construction tolerances in ACI 530.1/ASCE 6/TMS 602 and with the following:
 - 1. For conspicuous vertical lines, such as external corners, door jambs, reveals, and expansion and control joints, do not vary from plumb by more than 1/8 inch in 10 feet, 1/4 inch in 20 feet, or 1/2 inch maximum.
 - 2. For vertical alignment of exposed head joints, do not vary from plumb by more than 1/4 inch in 10 feet, or 1/2 inch maximum.
 - 3. For conspicuous horizontal lines, such as lintels, sills, parapets, and reveals, do not vary from level by more than 1/8 inch in 10 feet, 1/4 inch in 20 feet, or 1/2 inch maximum.
 - 4. For exposed bed joints, do not vary from thickness indicated by more than plus or minus 1/8 inch, with a maximum thickness limited to 1/2 inch. Do not vary from bed-joint thickness of adjacent courses by more than 1/8 inch.
 - 5. For exposed head joints, do not vary from thickness indicated by more than plus or minus 1/8 inch. Do not vary from adjacent bed-joint and head-joint thicknesses by more than 1/8 inch.
 - 6. For faces of adjacent exposed masonry units, do not vary from flush alignment by more than 1/16 inch except due to warpage of masonry units within tolerances specified for warpage of units.

3.03 LAYING MASONRY WALLS

- A. Lay out walls in advance for accurate spacing of surface bond patterns with uniform joint thicknesses and for accurate location of openings, movement-type joints, returns, and offsets. Avoid using less-than-half-size units, particularly at corners, jambs, and, where possible, at other locations. Provide corner blocks as indicated on Drawings.
- B. Before starting walls, pipe coverings or other projections shall be plumbed so that the full thickness of web of units will occur at all such projections. Walls shall be plumb and true to line.
- C. Concrete masonry walls shall be laid out with one stretcher course of the units to define the spaces, location of doors and other openings, and to serve as a guide for other trades in the installation of their work. Sufficient opportunity shall be given to the various trades to install built-in work before proceeding with the walls, leaving openings where required for testing, etc., such openings to be closed up later. The first course of all partition walls shall rest directly on the structural slab and hollow units shall be set with cells vertical and filled with mortar to one-half the height of the block
- D. Bond Pattern for Exposed Masonry: Unless otherwise indicated, lay exposed masonry in bond pattern indicated on Drawings; do not use units with less than nominal 4-inch horizontal face dimensions at corners or jambs. Prior to installation review bond pattern with Engineer.
- E. Stopping and Resuming Work: Stop work by racking back units in each course from those in course below; do not tooth. When resuming work, clean masonry surfaces that are to receive mortar, remove loose masonry units and mortar, and wet brick if required before laying fresh masonry.
- F. Built-in Work: As construction progresses, build in items specified in this and other Sections. Fill in solidly with masonry around built-in items.
- G. Care shall be exercised in setting concrete masonry units around door bucks and window frames in order not to bulge the sides or change the position of the frames.
- H. Fill space between steel frames and masonry solidly with mortar, unless otherwise indicated.
- I. Fill cores in hollow concrete masonry units with grout 24 inches under bearing plates, beams, lintels, posts, and similar items, unless otherwise indicated.
- J. Build non-load-bearing interior partitions full height of story to underside of solid floor or roof structure above, unless otherwise indicated.
 - 1. Install compressible filler in joint between top of partition and underside of structure above.
 - 2. Fasten partition top anchors to structure above and build into top of partition. Grout cells of CMUs solidly around plastic tubes of anchors and push tubes down

into grout to provide 1/2-inch clearance between end of anchor rod and end of tube. Space anchors 48 inches o.c., unless otherwise indicated.

3. Wedge non-load-bearing partitions against structure above with small pieces of tile, slate, or metal. Fill joint with mortar after dead-load deflection of structure above approaches final position.
4. At fire-rated partitions, treat joint between top of partition and underside of structure above to comply with Section 07844 – FIRE-RESISTIVE JOINT SYSTEMS.

3.04 MORTAR BEDDING AND JOINTING

A. Lay concrete masonry units as follows:

1. With face shells fully bedded in mortar and with head joints of depth equal to bed joints.
2. With webs fully bedded in mortar in all courses of piers, columns, and pilasters.
3. With webs fully bedded in mortar in grouted masonry, including starting course on footings.
4. With entire units, including areas under cells, fully bedded in mortar at starting course on footings where cells are not grouted.

B. Lay solid masonry units with completely filled bed and head joints; butter ends with sufficient mortar to fill head joints and shove into place. Do not deeply furrow bed joints or slush head joints.

C. Provide the following joint profiles at locations indicated and as directed by the Engineer:

1. Concave Joints: Tool joints slightly concave when thumbprint hard, using a jointer larger than joint thickness.
2. Flush Joints: Cut joints flush at all interior exposed locations.
3. Raked Joints: Rake joints to a uniform depth acceptable to the Engineer, at all exterior locations.

3.05 CAVITY WALLS

A. Bond wythes of cavity walls together using one of the following methods:

1. Masonry Joint Reinforcement: Installed in horizontal mortar joints. Where one wythe is of clay masonry and the other of concrete masonry, use adjustable (two-piece) type reinforcement with continuous horizontal wire in facing wythe attached to ties to allow for differential movement regardless of whether bed joints align.
2. Masonry Veneer Anchors: Comply with requirements for anchoring masonry veneers.

B. Bond wythes of cavity walls together using bonding system indicated on Drawings.

- C. Keep cavities clean of mortar droppings and other materials during construction. Bevel beds away from cavity, to minimize mortar protrusions into cavity. Do not attempt to trowel or remove mortar fins protruding into cavity.
- D. Coordinate and allow access for air and vapor barrier membrane installed in cavity under Section 07270 - AIR BARRIERS.

3.06 MASONRY JOINT REINFORCEMENT

A. Horizontal Joint Reinforcement, General:

1. Horizontal reinforcement of masonry joints shall be every 8-in. vertically which is equivalent to every course in block masonry.
2. Install entire length of longitudinal side rods in mortar with a minimum cover of 5/8 inch on exterior side of walls, 1/2 inch elsewhere. Lap reinforcement a minimum of 6 inches. Space reinforcement not more than 16 inches o.c.
3. Interrupt joint reinforcement at control and expansion joints, unless otherwise indicated.
4. Provide continuity at wall intersections by using prefabricated T-shaped units.
5. Provide continuity at corners by using prefabricated L-shaped units.

3.07 ANCHORING MASONRY TO STRUCTURAL MEMBERS

A. Anchor masonry to structural members where masonry abuts or faces structural members to comply with the following:

1. Provide an open space not less than 1 inch in width between masonry and structural member, unless otherwise indicated. Keep open space free of mortar and other rigid materials.
2. Anchor masonry to structural members with anchors embedded in masonry joints and attached to structure.
3. Space anchors as indicated, but not more than 24 inches o.c. vertically and 36 inches o.c. horizontally.

3.08 ANCHORING MASONRY VENEERS

A. Anchor masonry veneers with masonry-veneer anchors to comply with the following requirements:

1. Fasten screw-attached anchors through insulation and sheathing to wall framing and to concrete and masonry backup as applicable with metal fasteners of type indicated.
2. Embed tie sections in masonry joints. Provide air space indicated on the Drawings between back of masonry veneer and face of insulation.
3. Locate anchor sections to allow maximum vertical differential movement of ties up and down.
4. Space anchors as required by Code.

3.09 CONTROL AND EXPANSION JOINTS

- A. General: Install control and expansion joint materials in unit masonry as masonry progresses. Do not allow materials to span control and expansion joints without provision to allow for in-plane wall or partition movement.
- B. Form control joints in concrete masonry using one of the following methods:
 - 1. Fit bond-breaker strips into hollow contour in ends of concrete masonry units on one side of control joint. Fill resultant core with grout and rake out joints in exposed faces for application of sealant.
 - 2. Install preformed control-joint gaskets designed to fit standard sash block.
 - 3. Install interlocking units designed for control joints. Install bond-breaker strips at joint. Keep head joints free and clear of mortar or rake out joint for application of sealant.
 - 4. Install temporary foam-plastic filler in head joints and remove filler when unit masonry is complete for application of sealant.
- C. Provide horizontal, pressure-relieving joints by either leaving an air space or inserting a compressible filler of width required for installing sealant and backer rod specified in Section 07920 - JOINT SEALANTS but not less than 3/8 inch.
 - 1. Locate horizontal, pressure-relieving joints beneath shelf angles supporting masonry.

3.10 LINTELS

- A. Install steel lintels where indicated.
- B. Provide minimum bearing of 8 inches at each jamb, unless otherwise indicated.

3.11 FLASHING, WEEP HOLES, CAVITY DRAINAGE, AND VENTS

- A. General: Install embedded flashing and weep holes in masonry at shelf angles, lintels, ledges, other obstructions to downward flow of water in wall, and where indicated.
- B. Install flashing as follows, unless otherwise indicated:
 - 1. Prepare masonry surfaces so they are smooth and free from projections that could puncture flashing. Where flashing is within mortar joint, place through-wall flashing on sloping bed of mortar and cover with mortar. Before covering with mortar, seal penetrations in flashing with adhesive, sealant, or tape as recommended by flashing manufacturer.
 - 2. At multiwythe masonry walls, including cavity walls, extend flashing through outer wythe, turned up a minimum of 8 inches, and 1-1/2 inches into the inner wythe. Form 1/4-inch hook in edge of flashing embedded in inner wythe.

3. At masonry-veneer walls, extend flashing through veneer, across air space behind veneer, and up face of sheathing at least 8 inches; with upper edge covered with elastomeric membrane, lapping at least 4 inches.
 4. At lintels and shelf angles, extend flashing a minimum of 6 inches into masonry at each end. At heads and sills, extend flashing 6 inches at ends and turn up not less than 2 inches to form end dams.
- C. Install reglets and nailers for flashing and other related construction where they are shown to be built into masonry.
 - D. Install metal drip edge plate in accordance with architectural details and manufacturer's requirements.
 - E. Install weep holes in head joints in exterior wythes of first course of masonry immediately above embedded flashing and as follows:
 1. Use specified weep/vent products to form weep holes.
 2. Space weep holes 24 inches o.c., unless otherwise indicated.
 - F. Place cavity drainage material in cavities to comply with configuration requirements for cavity drainage material in Part 2 "Miscellaneous Masonry Accessories" Article.
 - G. Install vents in head joints in exterior wythes at spacing indicated.

3.12 REINFORCED UNIT MASONRY INSTALLATION

- A. Temporary Formwork and Shores: Construct formwork and shores as needed to support reinforced masonry elements during construction.
 1. Construct formwork to provide shape, line, and dimensions of completed masonry as indicated. Make forms sufficiently tight to prevent leakage of mortar and grout. Brace, tie, and support forms to maintain position and shape during construction and curing of reinforced masonry.
 2. Do not remove forms and shores until reinforced masonry members have hardened sufficiently to carry their own weight and other temporary loads that may be placed on them during construction.
- B. Placing Reinforcement: Comply with requirements in ACI 530.1/ASCE 6/TMS 602.
- C. Grouting: Do not place grout until entire height of masonry to be grouted has attained enough strength to resist grout pressure. Comply with requirements in ACI 530.1/ASCE 6/TMS 602 for cleanouts and for grout placement, including minimum grout space and maximum pour height.

3.13 FIELD QUALITY CONTROL

- A. Inspectors: Engage qualified independent inspectors to perform inspections and prepare reports. Allow inspectors access to scaffolding and work areas, as needed to perform

inspections. Place grout only after inspectors have verified compliance of grout spaces and grades, sizes, and locations of reinforcement.

- B. Testing Agency: Engage a qualified independent testing and inspecting agency to perform field tests and inspections indicated below and prepare test reports. Retesting of materials failing to comply with specified requirements shall be done at Contractor's expense.
- C. Testing Frequency: One set of tests for each 5000 sq. ft. of wall area or portion thereof. Test types as determined by the independent testing and inspection agency.

3.14 REPAIRING, POINTING, AND CLEANING

- A. Remove and replace masonry units that are loose, chipped, broken, stained, or otherwise damaged or that do not match adjoining units. Install new units to match adjoining units; install in fresh mortar, pointed to eliminate evidence of replacement.
- B. Pointing: During the tooling of joints, enlarge voids and holes, except weep holes, and completely fill with mortar. Point up joints, including corners, openings, and adjacent construction, to provide a neat, uniform appearance. Prepare joints for sealant application, around penetrations and where indicated.
- C. In-Progress Cleaning: Clean unit masonry as work progresses by dry brushing to remove mortar fins and smears before tooling joints.
- D. Final Cleaning: After mortar is thoroughly set and cured, clean exposed masonry as follows:
 - 1. Remove large mortar particles by hand with wooden paddles and nonmetallic scrape hoes or chisels.
 - 2. Test cleaning methods on sample wall panel; leave one-half of panel uncleaned for comparison purposes. Obtain Engineer's approval of sample cleaning before proceeding with cleaning of masonry.
 - 3. Protect adjacent nonmasonry surfaces from contact with cleaner by covering them with liquid strippable masking agent or polyethylene film and waterproof masking tape.
 - 4. Wet wall surfaces with water before applying cleaners; remove cleaners promptly by rinsing surfaces thoroughly with clear water.
 - 5. Clean concrete masonry by cleaning method indicated in NCMA TEK 8-2A applicable to type of stain on exposed surfaces.

3.15 MASONRY WASTE DISPOSAL

- A. Salvageable Materials: Unless otherwise indicated, excess masonry materials are Contractor's property. At completion of unit masonry work, remove from Project site.

- B. Waste Disposal as Fill Material: Dispose of clean masonry waste, including excess or soil-contaminated sand, waste mortar, and broken masonry units, by crushing and mixing with fill material as fill is placed.
1. Crush masonry waste to less than 4 inches in each dimension.
 2. Mix masonry waste with at least two parts of specified fill material for each part of masonry waste. Fill material is specified in Division 02 - EARTHWORK.
 3. Do not dispose of masonry waste as fill within 18 inches of finished grade.
- C. Excess Masonry Waste: Remove excess clean masonry waste that cannot be used as fill, as described above, and other masonry waste, and legally dispose of off the Site.

END OF SECTION

(THIS PAGE INTENTIONALLY LEFT BLANK)

SECTION 04230

REINFORCED UNIT MASONRY

GENERAL

1.01 SUMMARY

A. Section Includes

1. Requirements for furnishing all required labor, materials, accessories, tools, apparatus and equipment for the reinforced masonry work shown on the Drawings and described in the Specifications.
2. Requirements of Section 04200 – Unit Masonry apply to work in this section.

B. Related Sections

1. Section 04100 - Mortar and Masonry Grout
2. Section 04200 – Unit Masonry

1.02 REFERENCES

A. American Society for Testing Materials (ASTM)

1. A615, Specification for Deformed and Plain Billet-Steel Bars for Concrete Reinforcement.
2. C476, Specification for Grout for Masonry.

1.03 SUBMITTALS

A. In accordance with Section 01300.

1. Submit Shop Drawings for fabrication, bending and placement of reinforcement bars.
2. Comply with ACI 315 “Manual of Standard Practice for Detailing Reinforced Concrete Structures”

PART 2 PRODUCTS

2.01 MATERIALS

A. General

1. Refer to Section 04200 for masonry materials not included in this section.

B. Reinforcing Bars

1. In accordance with ASTM A615, Grade 60, unless indicated otherwise on the Drawings.
2. Size and spacing as indicated on the Structural Drawings.
3. Shop fabricate reinforcing bars which are shown to be bent or hooked.
4. All vertical reinforcing shall be installed using vertical bar positioners, as manufactured by Dur-O-Wall or equal, for locating the reinforcement in the center of the cells.

C. Mortar and Grout in accordance with Section 04100.

PART 3 EXECUTION

3.01 INSTALLATION OF REINFORCEMENT

A. General

1. Clean reinforcement of loose rust, scale, earth, ice or other deleterious material.
2. Do not use reinforcement which is deformed, severely rusted or not as shown on the approved shop drawings.

B. Positioning Reinforcement

1. Position reinforcement accurately as indicated on the Drawings.
2. Securely support bars to avoid displacement during grouting operation.
3. Minimum clearances, unless indicated on Drawings are as follows:
 - a. Where vertical bars are in close proximity, provide a minimum of 1 inch or a nominal bar diameter between bars, whichever is greater.
 - b. Where vertical bars are placed for columns, piers and pilasters, provide a minimum of 1 ½ inches or a 1 ½ times the nominal bar diameter between bars, whichever is greater.

C. Splicing

1. Locations as indicated on the Drawings.
2. Provide laps as indicated.

D. Horizontal Joint Reinforcement

1. Place as the work progresses.
2. Minimum cover of 5/8 inches on exterior faces and ½ inch at other locations.
3. Lap units ends at 6 inches minimum.
4. Use prefabricated "T" and "L" sections at corners and intersections.
5. Field fit sections only as recommended by the manufacturer.
6. Anchor as detailed on the Drawings.

E. Vertical wall reinforcement

1. Place reinforcement before grouting.
2. Installed using in one of two methods as the wall progresses.
 - a. The first method, the vertical reinforcing bars may be installed into the masonry cells after each of 4' of wall is placed, but before grouting, this method will require the bars to pass through a minimum of two bar positioners in the 4' lift.
 - b. The second method requires the upper bars to be installed tied to the lower bars, or foundation dowels, with tie wire as specified under Section 03200 and pass through only one vertical bar positioner located at the bottom of the last course for each lift. The Contractor's attention is directed to the fact that with the second method the masonry blocks will need to be lifted over the rods already in position. Vertical wall reinforcing shall be lapped a minimum of 48 bar diameters (# 5's - 30"; # 6's - 36"; #7's - 42"). Grouting of the masonry cells shall conform to this Section using grout as specified in Section 04100. Masonry wall reinforcing shall be supplied in lengths equal to the maximum grout lift (4') plus the required lap lengths as specified above.

3.02 INSTALLATION OF REINFORCED CONCRETE UNIT MASONRY (CMU)

A. General

1. Install CMU dry without wetting.

2. Lay CMU with full face mortar bed.
 3. Fill joints between CMU solidly with mortar.
 4. Solidly bed cross-webs of starting courses in mortar.
 5. Head and bed joint width to be 3/8 inched unless indicated otherwise on the Drawings.
- B. Walls
1. Lay CMU wall units in 1/2 running bond with vertical joints in each course centered with courses above and below unless indicated otherwise on the Drawings.
 2. Maintain alignment of cells which are to be reinforced and grouted, Provide minimum clearance dimensions indicated, solidly bed webs in mortar where adjacent to reinforced cores. Keep cavities to be grouted free of mortar.
 3. Interlock corners and intersections.
 4. Use special shaped units as required for jambs, sashes, joints, lintels, bond beams or as otherwise indicated on the drawings.
- C. Columns, Piers, Pilasters
1. Use CMU of the size and shape indicated on the Drawings. If not shown use units which provide minimum clearances for the size of reinforcement shown.
 2. Where bonded pilaster construction is indicated, lay wall and pilaster units together.
- D. Grout Selection
1. Use fine grout (ASTM C476) for filling cavities 4 inches or less in any horizontal direction.
 2. Use course grout (ASTM C476) for filling cavities greater than 4 inches in any horizontal direction.
- E. Grout Method
1. Prior to placing grout.
 - a. Inspect and clean cavities to receive grout.
 - b. Clean and adjust reinforcement.
 - c. Clean surface of structural member supporting the masonry to ensure bond with grout.
 - d. Close cleanout holes, and brace to resist grout pressure.
 2. Placing grout will not be allowed until the masonry has attained sufficient strength.
 3. Grout to be placed by pumping unless an alternate method is approved by the Engineer.
 4. The Contractor has the option of using either low-lift or high-lift grouting procedures in accordance with this specification as approved by the Engineer.
 - a. Low Lift Grouting
 - 1) Requires minimum clear dimension of 2 inches and clear area of 8 sq. inches in vertical cores to be grouted
 - 2) Vertical reinforcement to be placed prior to laying CMU. Extend above pour height to allow splicing as required. Support bars at maximum 10 foot intervals.
 - 3) Lay CMU to pour height not to exceed 4 feet or below bond beam, whichever is less.
 - 4) Pour grout using delivery system appropriate for the job, minimizing spillage. Rod or vibrate grout during placement, Place in continuous operation. Fill CMU to 1 1/2 inches below top of course.
 - 5) After grouted masonry has cured, lay masonry and place reinforcement for the next pour before grouting. Repeat as required.
 - b. High Lift Grouting
 - 1) Requires minimum clear dimension of 3 inches and clear area of 10 sq. inches in vertical cores to be grouted
 - 2) Provide clean out holes in first course of all cavities to be filled with grout.

- 3) Construct wall to full height of grout pour as allowed.
- 4) Place grout in 5 foot lifts maximum to a total height of 24 feet for single wythe hollow concrete masonry walls unless indicated otherwise.
- 5) Allow not less than 30 minutes or more than 1 hour between lifts.
- 6) Pour grout using delivery system appropriate for the job, minimizing spillage. Rod or vibrate grout during placement, Place in continuous operation. Fill CMU to 1 ½ inches below top of course.

F. Bond Beams

1. Pour grout to 1 ½ inches below bond beam course.
2. Place horizontal reinforcement in bond beams lapping corners and intersections.
3. Place grout in bond beam before filling vertical cores above bond beam.

END OF SECTION

SECTION 04930

MASONRY AND STUCO CLEANNG

PART 1 - GENERAL

1.01 GENERAL PROVISIONS

- A. Attention is directed to the CONTRACT AND GENERAL CONDITIONS and all Sections within DIVISION 01 - GENERAL REQUIREMENTS which are hereby made a part of this Section of the Specifications.

1.02 DESCRIPTION OF WORK

- A. Work Included: Provide labor, materials and equipment necessary to complete the work of this Section, including but not limited to the following:
 - 1. Power washing existing masonry, stucco and concrete surfaces with hot water, low pressure application.

1.03 SUBMITTALS

- A. Product Data: For each type of product indicated. Include recommendations for application and use. Include test data substantiating that products comply with requirements.
- B. Cleaning Program: Describe cleaning process in detail, including materials, methods, and equipment to be used and protection of surrounding materials on building and Project site, and control of runoff during operations.
 - 1. If materials and methods other than those indicated are proposed for cleaning work, provide a written description, including evidence of successful use on comparable projects, and a testing program to demonstrate their effectiveness for this Project.

1.04 QUALITY ASSURANCE

- A. Source Limitations: Obtain each type of material for masonry restoration (face brick, cement, sand, etc.) from one source with resources to provide materials of consistent quality in appearance and physical properties.
- B. Preinstallation Conference: Conduct conference at Project site to comply with requirements in Division 01.

1.05 DELIVERY, STORAGE, AND HANDLING

- A. Deliver masonry units to Project site strapped together in suitable packs or pallets or in heavy-duty cartons.
- B. Deliver other materials to Project site in manufacturer's original and unopened containers, labeled with manufacturer's name and type of products.

1.06 PROJECT CONDITIONS

- A. Clean masonry surfaces only when air temperature is 40 deg F and above and is predicted to remain so for at least 7 days after completion of cleaning.

PART 2 - PRODUCTS

2.01 CLEANING MATERIALS

- A. Water for Cleaning: Potable.
- B. Hot Water: Heat water to a temperature of 140 to 160 deg F.

PART 3 - EXECUTION

3.01 PROTECTION

- A. Protect persons, motor vehicles, surrounding surfaces of building being restored, building site, plants, and surrounding buildings from harm resulting from masonry restoration work.

3.02 CLEANING MASONRY, GENERAL

- A. Proceed with cleaning in an orderly manner; work from top to bottom of each scaffold width and from one end of each elevation to the other.
- B. Hot-Water Wash: Use hot water applied by low-pressure spray, 100 to 400 psi; 4 to 6 gpm.
- C. Use only those cleaning methods indicated for each masonry material and location.
 - 1. Use spray equipment that provides controlled application at volume and pressure indicated, measured at spray tip. Adjust pressure and volume to ensure that cleaning methods do not damage masonry.
 - a. Equip units with pressure gages.
 - 2. For water spray application, use fan-shaped spray tip that disperses water at an angle of 25 to 50 degrees.

3. For heated water spray application, use equipment capable of maintaining temperature between 140 and 160 deg F at flow rates indicated.
- D. Perform each cleaning method indicated in a manner that results in uniform coverage of all surfaces, including corners, moldings, and interstices, and that produces an even effect without streaking or damaging masonry surfaces.
- E. Water Spray Applications: Unless otherwise indicated, hold spray nozzle at least 6 inches from surface of masonry and apply water in horizontal back and forth sweeping motion, overlapping previous strokes to produce uniform coverage.
- F. After cleaning is complete, remove protection no longer required. Remove tape and adhesive marks.

END OF SECTION

(THIS PAGE INTENTIONALLY LEFT BLANK)

DIVISION 05

(THIS PAGE INTENTIONALLY LEFT BLANK)

SECTION 05120

STRUCTURAL STEEL FRAMING

PART 1 GENERAL

1.01 DESCRIPTION OF WORK

1. Work Included: Provide labor, materials and equipment necessary to complete the work of this Section of the Specifications.
 - a. Structural Steel.
 - b. Architecturally exposed structural steel.
2. Related Work: The following items are not included in this Section and will be performed under the designated Sections:
 - a. Section 05500 – METALS FABRICATION

1.02 DEFINITIONS

Structural Steel: Elements of structural-steel frame, as classified by AISC's "Code of Standard Practice for Steel Buildings and Bridges", that support design loads.

- A. Architecturally Exposed Structural Steel: Structural steel that forms a prominent architectural feature in a building or structure or designated as architecturally exposed structural steel on the Drawings.

1.03 PERFORMANCE REQUIREMENTS

Connections: Provide details of connections required by the Contract Documents to be selected or completed by the structural-steel fabricator to withstand loads indicated and comply with other information and restrictions indicated.

Select and complete connections using the American Institute of Steel Construction's (AISC) "Manual of Steel Construction, Load and Resistance Factor Design", Volume 2, Part 9.

Engineering Responsibility: Fabricator's responsibilities include using a qualified professional engineer to prepare structural analysis data for structural-steel connections.

1.04 SUBMITTALS

- A. Product Data: For each type of product indicated.
- B. Shop Drawings: Show fabrication of structural-steel components.
 1. Include details of cuts, connections, splices, camber, holes, and other pertinent data.
 2. Include embedment drawings.
 3. Indicate welds by standard AWS symbols, distinguishing between shop and field welds, and show size, length and type of each weld.

4. Indicate type, size and length of bolts, distinguishing between shop and field bolts. Identify pre-tensioned and slip-critical high-strength bolted connections.
 5. For structural-steel connections indicated to comply with design loads, include structural analysis data signed and sealed by the qualified professional engineer responsible for their preparation.
- C. Welding Certificates: Certificate from AWS indicating certification in type of welding required for each welder and welding operator.
- D. Welding Records and Data:
1. Before welding, submit the procedure which will be used for qualifying welders and welding procedures. For procedures other than those pre-qualified in accordance with AWS D1.1, submit a copy of procedure qualification test records.
 2. Submit certified copy of qualification test records for each welder, welding operator, and tacker who will be employed in the work.
 3. If field welding is permitted, submit descriptive data for field welding equipment.
 4. Submit all NDE records (radiographs, ultrasonic, magnetic particle) and visual inspection reports upon completion or when otherwise requested by the Engineer.
- E. Qualification Data: For installer, fabricator, professional engineer, testing agency, welding inspectors, NDE inspectors and galvanizer. Submit prior to starting work.
- F. Mill Test Reports: Signed by manufacturers certifying that the following products comply with requirements:
1. Structural steel including chemical and physical properties.
 2. Bolts, nuts, and washers including mechanical properties and chemical analysis.
 3. Direct-tension indicators.
 4. Tension-control, high-strength bolt-nut-washer assemblies.
 5. Shear stud connectors.
 6. Shop primers.
 7. Nonshrink grout.

1.05 QUALITY ASSURANCE

- A. Fabricator Qualifications: A qualified fabricator who participates in the AISC Quality Certification Program and is certified for: Steel Building Structures (STD).
- B. Galvanizer Qualifications: Engage the services of a qualified galvanizer who has demonstrated a minimum of five years experience in the successful application of galvanized coatings specified in this Section in the facility where the work is to be performed and who will apply the coatings within the same facility.
- C. Installer Qualifications: A qualified installer with previous experience in installing structural steel.

D. Welding: Qualify procedures and personnel according to AWS D1.1, "Structural Welding Code--Steel".

E. Comply with applicable provisions of the following specifications and documents:

1. AISC's "Code of Standard Practice for Steel Buildings and Bridges"
2. AISC's "Seismic Provisions for Structural Steel Buildings" and "Supplement No. 2"
3. AISC's "Specification for Structural Steel Buildings--Allowable Stress Design and Plastic Design" and "Load and Resistance Factor Design Specification for Structural Steel Buildings"
4. AISC's "Specification for the Design of Steel Hollow Structural Sections"
5. AISC's "Specification for Allowable Stress Design of Single-Angle Members" and "Specification for Load and Resistance Factor Design of Single-Angle Members"
6. RCSC's "Specification for Structural Joints Using ASTM A 325 or A 490 Bolts"

F. Tests and Inspection

1. The Contractor will test and inspect high-strength bolted connections and welded connections and prepare test reports. Specialty tests shall be performed at no expense to the Owner by an independent testing laboratory approved by the Engineer. Costs of specialty tests shall be borne by the Contractor. Test reports shall be submitted to the Engineer for approval.
2. The Engineer reserves the right to inspect high-strength bolted connections and weld connections. Provide access to places where structural steel work is being fabricated or erected so that required inspection and testing can be accomplished at no change in Contract Price. At times, inspection may require moving or handling of steel to permit proper inspection. Notify Materials Testing Laboratory not less than 48 hours prior to start of fabrication.
3. The Engineer may inspect structural steel at the plant before shipment; however, the Engineer reserves the right, at any time before final acceptance, to reject material not complying with specified requirements.
4. Correct deficiencies in structural steel work that inspections and laboratory test reports have indicated to be not in compliance with requirements at the Contractor's expense. Perform additional tests, at no expense to the Owner, as may be necessary to reconfirm any non-compliance of the original work, and as may be necessary to show compliance of corrected work.
5. Specialty Tests: Nondestructive examination of welds in accordance with provisions of AWS D1.1 and ASTM Standards noted shall be made in accordance with the following schedule:
 - a. Radiographic Examination of Welds, per ASTM E94 and E142:
 - 1) Field, complete joint penetration groove welds:
 - a. 1 out of 5 (20 percent) with thickness equal to or less than 3/4 inch.

- b. 100 percent with thickness greater than 3/4 inch.
- 2) Shop, complete joint penetration groove welds:
- a. 1 out of 10 (10 percent) with thickness equal to or less than 3/4 inch.
 - b. 1 out of 2 (50 percent) with thickness greater than 3/4 inch and equal to or less than 1-1/2 inches.
 - c. 100 percent for thickness greater than 1-1/2 inches.
- b. Ultrasonic Examination, per ASTM E164: Complete joint penetration groove butt welds not accessible for radiographic examination shall be subjected to ultrasonic testing. The extent shall be the same as noted for radiographic examination. Ultrasonic examination shall be made 48 to 72 hours after welding at locations on weldments or welded joints subject to high restraint as indicated in order to check for lamellar tearing. The exact location of the areas to be inspected shall be determined with the Engineer at the time of fabrication. This examination shall be made according to the following schedule unless conditions of tearing require a greater number of tests, as directed:
- 1) 1 out of 10 (10 percent) for thickness equal to or less than 3/4 inch.
 - 2) 1 out of 5 (20 percent) for thickness greater than 3/4 inch and equal to or less than 1-1/4 inches.
 - 3) 1 out of 2 (50 percent) for thickness greater than 1-1/4 inches.
- c. Magnetic Particle Examination, per ASTM E709, field and shop:
- 1) 1 out of 5 (20 percent) of complete joint penetration groove welds of tee and corner joints.
 - 1) 1 out of 10 (10 percent) of partial joint penetration groove and fillet welds.
- d. Penetrant Examination, per ASTM E165: Shall be used for detecting discontinuities that are open to the surface use as appropriate.
6. Visual Examination: All welds whether otherwise examined or not shall be visually examined and faulty joints shall be marked for correction.
7. When any testing, examination or inspection reveals faulty welds, all joints of the same type shall be checked at no expense to the Owner until the integrity of the weld is assured before resuming examination.
8. After faulty welds have been corrected or repaired, they shall each be re-examined at no expense to the Owner in the manner specified for the original joint.
9. It is intended that inspections shall be performed to permit an orderly flow of completed material from the shop. Work with the Engineer to establish a schedule that will permit this.
10. Test result information shall be forwarded to the Engineer immediately after test results are available stating the acceptance or rejection of fabricated pieces in order that the repairs and re-inspection may be made as soon as possible.
- G. Pre-Installation Conference: Contractor shall schedule a meeting to be attended by Contractor, Engineer, fabricator and galvanizer. Agenda shall include the following: Project schedule,

source for each fabrication, coordination between fabricator and galvanizer and adjacent Work, finish of surfaces, application of coatings, submittals, and approvals.

1.06 DELIVERY, STORAGE, AND HANDLING

- A. Store materials to permit easy access for inspection and identification. Keep steel members off ground and spaced by using pallets, dunnage, or other supports and spacers. Protect steel members and packaged materials from erosion and deterioration.
 - 1. Store fasteners in a protected place. Clean and re-lubricate bolts and nuts that become dry or rusty before use.
 - 2. Do not store materials on structure in a manner that might cause distortion, damage, or overload to members or supporting structures. Repair or replace damaged materials or structures as directed.

1.07 COORDINATION

- A. Furnish anchorage items to be embedded in or attached to other construction without delaying the Work. Provide setting diagrams, sheet metal templates, instructions and directions for installation.

PART 2 – PRODUCTS

2.01 STRUCTURAL-STEEL MATERIALS

- A. S-Shapes, W-Shapes: ASTM A 992, Grade 50.
- B. Channels, Angles, Plates and Bar: ASTM A 36.
- C. Cold-Formed Hollow Structural Sections: ASTM A 500, Grade B, structural tubing.
- D. Steel Pipe: ASTM A 53, Type E or S, Grade B.
- E. Medium-Strength Steel Castings: ASTM A 27, Grade 65-35 carbon steel.
- F. High-Strength Steel Castings: ASTM A 148, Grade 80-50, carbon or alloy steel.
- G. Welding Electrodes: Comply with AWS requirements.

2.02 BOLTS, CONNECTORS, AND ANCHORS

- A. High-Strength Bolts, Nuts, and Washers: ASTM A 325, Type 1, heavy hex steel structural bolts; ASTM A 563 heavy hex carbon-steel nuts; and ASTM F 436 hardened carbon-steel washers.
 - 1. Finish: Hot-dip zinc coating, ASTM A 153, Class C.
- B. Tension-Control, High-Strength Bolt-Nut-Washer Assemblies: ASTM F 1852, Type 1, steel structural bolts with splined ends; ASTM A 563 heavy hex carbon-steel nuts; and ASTM F 436 hardened carbon-steel washers. Finish, mechanically deposited zinc coating, ASTM B 695, Class 50.

- C. Shear Connectors: ASTM A 108, Grades 1015 through 1020, headed-stud type, cold-finished carbon steel; AWS D1.1, Type B.
- D. Anchor Rods: ASTM F 1554, grade as applicable, hot-dip zinc coating, ASTM A 153, Class C.
- E. Threaded Rods: ASTM A 193, grade as applicable, hot-dip zinc coating, ASTM A 153, Class C.
- F. Eye Bolts and Nuts: ASTM A 108, Grade 1030, cold-finished carbon steel.
- G. Sleeve Nuts: ASTM A 108, Grade 1018, cold-finished carbon steel.

2.03 MISCELLANEOUS MATERIALS

- A. Galvanizing Repair Paint: Coatings meeting requirements of ASTM A 780.
- B. Nonmetallic, Shrinkage-Resistant Grout: ASTM C 1107, factory-packaged, nonmetallic aggregate grout, noncorrosive, nonstaining, mixed with water to consistency suitable for application and a 30-minute working time.

2.04 FABRICATION

- A. Structural Steel: Fabricate and assemble in shop to greatest extent possible. Fabricate according to AISC's "Code of Standard Practice for Steel Buildings and Bridges" and AISC's "Specification for Structural Steel Buildings--Allowable Stress Design and Plastic Design".
 - 1. Camber structural-steel members where indicated.
 - 2. Identify high-strength structural steel according to ASTM A 6/ A 6M and maintain markings until structural steel has been erected.
 - 3. Mark and match-mark materials for field assembly.
 - 4. Complete structural-steel assemblies, including welding of units, before starting shop-priming operations.
- B. Architecturally Exposed Structural Steel: Comply with fabrication requirements, including tolerance limits, of AISC's "Code of Standard Practice for Steel Buildings and Bridges" for structural steel identified as architecturally exposed structural steel.
 - 1. Fabricate with exposed surfaces smooth, square, and free of surface blemishes including pitting, rust, scale, seam marks, roller marks, rolled trade names, and roughness.
 - 2. Remove blemishes by filling or grinding or by welding and grinding, before cleaning, treating, and shop priming.
- C. Thermal Cutting: Perform thermal cutting by machine to greatest extent possible. Plane thermally cut edges to be welded to comply with requirements in AWS D1.1.
- D. Bolt Holes: Cut, drill, or punch standard bolt holes perpendicular to metal surfaces.
- E. Finishing: Accurately finish ends of columns and other members transmitting bearing loads.

- F. Shear Connectors: Prepare steel surfaces as recommended by manufacturer of shear connectors. Use automatic end welding of headed-stud shear connectors according to AWS D1.1 and manufacturer's written instructions.
- G. Steel Wall-Opening Framing: Select true and straight members for fabricating steel wall-opening framing to be attached to structural steel. Straighten as required to provide uniform, square, and true members in completed wall framing.
- H. Welded Door Frames: Build up welded door frames attached to structural steel. Weld exposed joints continuously and grind smooth. Plug-weld fixed steel bar stops to frames. Secure removable stops to frames with countersunk, cross-recessed head machine screws, uniformly spaced not more than 10 inches o.c., unless otherwise indicated.
- I. Holes: Provide holes required for securing other work to structural steel and for passage of other work through steel framing members.
 - 1. Cut, drill, or punch holes perpendicular to steel surfaces. Do not thermally cut bolt holes or enlarge holes by burning.
 - 2. Base-Plate Holes: Cut, drill, mechanically thermal cut, or punch holes perpendicular to steel surfaces.
 - 3. Weld threaded nuts to framing and other specialty items indicated to receive other work.

2.05 SHOP CONNECTIONS

- A. High-Strength Bolts: Shop install high-strength bolts according to RCSC's "Specification for Structural Joints Using ASTM A 325 or A 490 Bolts" for type of bolt and type of joint specified.
- B. Weld Connections: Comply with AWS D1.1 for welding procedure specifications, tolerances, appearance, and quality of welds and for methods used in correcting welding work. Complete welds in accordance with the Contract Drawings.
 - 1. Remove backing bars or runoff tabs, back gouge, and grind steel smooth.
 - 2. Assemble and weld built-up sections by methods that will maintain true alignment of axes without exceeding tolerances of AISC's "Code of Standard Practice for Steel Buildings and Bridges" for mill material.
 - 3. Insufficient welds shall be rejected and corrected until required profiles are met.
 - 4. Verify that weld sizes, fabrication sequence, and equipment used for architecturally exposed structural steel will limit distortions to allowable tolerances. Prevent weld show-through on exposed steel surfaces.
 - a. Grind butt welds flush.
 - b. Grind or fill exposed fillet welds to smooth profile. Dress exposed welds.
 - 5. No skip welds will be permitted for steel connections to be coated.

2.06 STEEL PRIMERS AND FINISHES

- A. Preparation for Shop Priming: Prepare uncoated ferrous-metal surfaces to comply with minimum requirements indicated below for The Society for Protective Coatings (SSPC) surface preparation specifications and environmental exposure conditions of installed metal fabrications:
1. Exteriors (SSPC Zone 1B) and Items Indicated to Receive Zinc-Rich Primer: SSPC-SP 10/NACE No. 2, "Near White Metal Blast Cleaning"
 2. Interiors (SSPC Zone 1A): SSPC-SP 6, "Commercial Blast Cleaning"
 3. Apply shop primer to uncoated surfaces of metal fabrications, except those with galvanized finishes and those to be field welded, embedded in concrete or masonry, unless otherwise indicated. Extend priming of partially embedded members to a depth of 2 inches.
 4. Comply with SSPC-PA 1, "Paint Application Specification No. 1: Shop, Field, and Maintenance Painting of Steel" for shop painting.
 5. Comply with SSPC-PA 2, "Measurement of Dry Coating Thickness with magnetic Gages"
- B. Zinc-Rich Primer: Urethane zinc rich primer compatible with topcoat Specified in Section 09900. Provide primer with a VOC content of 340 g/L (2.8 lb/gal.) or less per OTC ozone standards. Provide Tnemec Series 394 or Ameron 5105 or equal by DuPont or Carboline for exposed steel to be fireproofed, or Tnemec Series 901K97 Series or 90-97 or Ameron 68HS or equal by DuPont or Carboline for exposed steel to be finish painted at 3.0 mils DFT.
- C. Primer for Exposed Steel to Receive Multi-Coat Shop-Applied Coating: Tnemec Series 901K97 or 90-97 urethane zinc rich primer at 3.0 to 3.5 mils DFT, topcoated in shop with Tnemec Series V73 Endura-Shield, or use Ameron Series 68HS Primer at 3.0 to 5.0 mils DFT topcoated in shop with Ameron's Amercoat 450H, or use or equal primers and finish coats from DuPont or Carboline.
- D. Galvanizing: For steel exposed to the elements, weather or corrosive environments and other steel indicated to be galvanized, provide coating for iron and steel fabrications applied by the hot-dip process. Comply with ASTM A 123 for fabricated products and ASTM A 153 for hardware. Provide thickness of galvanizing specified in referenced standards. The galvanizing bath shall contain high grade zinc and other earthy materials. Fill vent holes and grind smooth after galvanizing.
- E. Hot-Dip Galvanizing And Factory-Applied Primer for Steel: Provide hot-dip galvanizing and factory-applied prime coat, certified OTC/VOC compliant less than 2.8 lbs/gal. and conforming to EPA and Commonwealth of Massachusetts requirements. Apply primer within 12 hours after galvanizing at the galvanizer's plant in a controlled environment meeting applicable environmental regulations and as recommended by the primer coating manufacturer. Blast cleaning of the surface is unacceptable for surface preparation. Primer shall have a minimum two year re-coat window for application of finish coat. Coatings must meet or exceed the following performance criteria:
1. Abrasion: ASTM D 4060, CS17 Wheel, 1,000 gram load.
 2. Adhesion: ASTM D 3359, Method B, 5 mm crosshatch.
 3. Humidity Resistance: ASTM D 4585.

4. Salt Spray (Fog): ASTM B 117.

PART 3 - EXECUTION

3.01 EXAMINATION

- A. Verify elevations of concrete- and masonry-bearing surfaces and locations of anchor rods, bearing plates, and other embedments, with steel erector present, for compliance with requirements. Elevations shall be verified by a surveyor licensed in the Commonwealth of Massachusetts.
- B. Proceed with installation only after unsatisfactory conditions have been corrected.

3.02 PREPARATION

- A. Provide temporary shores, guys, braces, and other supports during erection to keep structural steel secure, plumb, and in alignment against temporary construction loads and loads equal in intensity to design loads. Remove temporary supports when permanent structural steel, connections, and bracing are in place, unless otherwise indicated. Do not remove temporary shoring supporting composite deck construction until cast-in-place concrete has attained its design compressive strength.

3.03 ERECTION

- A. Set structural steel accurately in locations and to elevations indicated and according to AISC's "Code of Standard Practice for Steel Buildings and Bridges".
- B. Base and Bearing Plates: Clean concrete- and masonry-bearing surfaces of bond-reducing materials, and roughen surfaces prior to setting base and bearing plates. Clean bottom surface of base and bearing plates.
 1. Set base and bearing plates for structural members on wedges, shims, or setting nuts as required.
 2. Weld plate washers to top of base plate.
 3. Snug-tighten or pretension anchor rods as applicable after supported members have been positioned and plumbed. Do not remove wedges or shims but, if protruding, cut off flush with edge of base or bearing plate before packing with grout.
 4. Promptly pack grout solidly between bearing surfaces and base or bearing plates so no voids remain. Neatly finish exposed surfaces; protect grout and allow to cure. Comply with manufacturer's written installation instructions for shrinkage-resistant grouts.
- C. Maintain erection tolerances of structural steel and architecturally exposed structural steel within AISC's "Code of Standard Practice for Steel Buildings and Bridges".
- D. Align and adjust various members forming part of complete frame or structure before permanently fastening. Before assembly, clean bearing surfaces and other surfaces that will be in permanent contact with members. Perform necessary adjustments to compensate for discrepancies in elevations and alignment.
 1. Level and plumb individual members of structure.

2. Make allowances for difference between temperature at time of erection and mean temperature when structure is completed and in service.
- E. Splice members only where indicated.
 - F. Remove erection bolts on welded, architecturally exposed structural steel; fill holes with plug welds; and grind smooth at exposed surfaces.
 - G. Do not use thermal cutting during erection unless approved by Engineer. Finish thermally cut sections within smoothness limits in AWS D1.1.
 - H. Do not enlarge unfair holes in members by burning or using drift pins. Ream holes that must be enlarged to admit bolts.
 - I. Shear Connectors: Prepare steel surfaces as recommended by manufacturer of shear connectors. Use automatic end welding of headed-stud shear connectors according to AWS D1.1 and manufacturer's written instructions.

3.04 FIELD CONNECTIONS

- A. High-Strength Bolts: Install high-strength bolts according to RCSC's "Specification for Structural Joints Using ASTM A 325 or A 490 Bolts" for type of bolt and type of joint indicated on the Drawings.
- B. Weld Connections: Comply with AWS D1.1 for welding procedure specifications, tolerances, appearance, and quality of welds and for methods used in correcting welding work.
 1. Comply with AISC's "Code of Standard Practice for Steel Buildings and Bridges" for bearing, adequacy of temporary connections, alignment, and removal of paint on surfaces adjacent to field welds.
 2. Remove backing bars or runoff tabs, back gouge, and grind steel smooth.
 3. Assemble and weld built-up sections by methods that will maintain true alignment of axes without exceeding tolerances of AISC's "Code of Standard Practice for Steel Buildings and Bridges" for mill material.
 4. Verify that weld sizes, fabrication sequence, and equipment used for architecturally exposed structural steel will limit distortions to allowable tolerances. Prevent weld show-through on exposed steel surfaces.
 - a. Grind butt welds flush.
 - b. Grind or fill exposed fillet welds to smooth profile. Dress exposed welds.
 - c. Re-profile all steel surfaces (using needle guns or other profiling methods) that have been welded and ground smooth to assure proper adhesion of primers and topcoats.

3.05 FIELD QUALITY CONTROL

- A. Testing Agency: Engage a qualified independent testing and inspecting agency to inspect field welds and high-strength bolted connections.
- B. Bolted Connections: Bolted connections will be inspected according to RCSC's "Specification for Structural Joints Using ASTM A 325 or A 490 Bolts". When using bolted connections prime with "slip critical class B" primer as specified in this Section. All surfaces of bolted or bearing

connections may be primed. When welding, hold back primer a minimum of 2 inches each side of weld.

- C. Welded Connections: Field welds will be visually inspected according to AWS D1.1. In addition to visual inspection, specialty tests will be performed in accordance with AWS D1.1 and at the frequency stated in Article 1.5.F.5
- D. In addition to visual inspection, test and inspect field-welded shear connectors according to requirements in AWS D1.1 for stud welding and as follows:
 - 1. Perform bend tests if visual inspections reveal either a less-than- continuous 360-degree flash or welding repairs to any shear connector.
 - 2. Conduct tests on additional shear connectors if weld fracture occurs on shear connectors already tested, according to requirements in AWS D1.1.
- E. Correct deficiencies in Work that test reports and inspections indicate do not comply with the Contract Documents.

3.06 REPAIRS AND PROTECTION

- A. Repair damaged galvanized coatings on galvanized items with galvanized repair paint according to ASTM A 780 and manufacturer's written instructions.
- B. Touchup Painting: After installation, promptly clean, prepare, and prime or reprime field connections, rust spots, and abraded surfaces of prime-painted joists and accessories, bearing plates, and abutting structural steel.
 - 1. Clean and prepare surfaces by SSPC-SP 3 power-tool cleaning.
 - 2. Apply a compatible primer of same type as shop primer used on adjacent surfaces.

END OF SECTION

(THIS PAGE INTENTIONALLY LEFT BLANK)

SECTION 05500

METAL FABRICATIONS

PART 1 - GENERAL

1.01 GENERAL PROVISIONS

- A. Attention is directed to the CONTRACT AND GENERAL CONDITIONS and all Sections within DIVISION 01 - GENERAL REQUIREMENTS which are hereby made a part of this Section of the Specifications.

1.02 DESCRIPTION OF WORK

- A. Work Included: Provide labor, materials and equipment necessary to complete the work of this Section, including but not limited to the following. Requirements for materials, hot-dip galvanizing, and shop-applied primers are included with each item as applicable.
1. Aluminum stairs, railings and gratings as indicated on the Drawings; includes brackets, supports and clips as applicable.
 2. Aluminum ladders with railing enclosure to roof; includes guards and fall protection.
 3. Aluminum exterior floor hatches, waterproof type at dry wells; includes guards and fall protection.
 4. Aluminum interior floor hatches, exterior waterproof type at wet wells.
 5. Loose steel bearing and leveling plates, including bearing plates for steel joists, galvanized at exterior locations and in exterior walls.
 6. Galvanized steel lintels with shop-applied primer at exterior locations.
 7. Steel lintels with shop-applied zinc-rich primer at interior locations.
 8. Galvanized shelf angles with shop applied primer at exterior locations.
 9. Shelf angles with zinc-rich shop-applied primer at interior locations.
 10. Miscellaneous steel framing and supports:
 - a. Galvanized steel framing and supports for mechanical and electrical equipment.
 - b. Steel framing and supports for applications where framing and supports are not specified in other Sections; galvanized at exterior locations and in exterior walls.
 - c. Prefinished slotted steel channel support framing.
 11. Galvanized steel bollards with shop-applied primer.
 12. Galvanized pipe guards with shop-applied primer.
 13. Cast gray iron downspout boots.
 14. Metal floor plate.

- B. Items To Be Furnished Only: Furnish the following items for installation by the designated Sections
 - 1. Section 03300 - CAST-IN-PLACE CONCRETE:
 - a. Lintels, sleeves, anchors, inserts, plates and similar items.
 - 2. Section 04200 - UNIT MASONRY and Section 04220 - REINFORCED UNIT MASONRY:
 - a. Lintels, miscellaneous metal and iron sleeves, anchors, inserts and plates to be built into masonry walls.
- C. Related Work: The following items are not included in this Section and are specified under the designated Sections:
 - 1. Section 05120 - STRUCTURAL STEEL FRAMING for structural steel items.
 - 2. Section 09900 - PAINTING AND COATING for field painting work of this section.
 - 3. Section 14650 - MONORAIL AND HOISTS for monorail and hoist.

1.03 PERFORMANCE REQUIREMENTS

- A. Delegated Design: Design stairs, gratings, railings miscellaneous framing and supports, including comprehensive engineering analysis by a qualified professional engineer, using performance requirements and design criteria indicated.
- B. Structural Performance of Stairs: Provide metal stairs capable of withstanding the effects of gravity loads and the following loads and stresses within limits and under conditions indicated:
 - 1. Uniform Load and Concentrated Loads: As required by Code.
 - 2. Stair Framing: Capable of withstanding stresses resulting from railing loads in addition to loads specified above.
 - 3. Limit deflection of treads, platforms, and framing members to $L/360$ or $1/4$ inch, whichever is less.
- C. Structural Performance of Railings: Provide railings capable of withstanding the effects of gravity loads and Code required loads and stresses within limits and under conditions indicated.
- D. Structural Performance of Ladders: Provide ladders capable of withstanding the effects of loads and stresses within limits and under conditions specified in ANSI A14.3.
- E. Thermal Movements: Provide exterior metal fabrications that allow for thermal movements resulting from the following maximum change (range) in ambient and surface temperatures by preventing buckling, opening of joints, overstressing of components, failure of connections, and other detrimental effects. Base engineering calculation on surface temperatures of materials due to both solar heat gain and nighttime-sky heat loss.

1. Temperature Change (Range): 120 deg F (67 deg C), ambient; 180 deg F (100 deg C), material surfaces.

1.04 SUBMITTALS

A. Product Data: For the following:

1. Paint products.
2. Grout.

B. Shop Drawings: Show fabrication and installation details for metal fabrications.

1. Include plans, elevations, sections, and details of metal fabrications and their connections. Show anchorage and accessory items.
2. Provide templates for anchors and bolts specified for installation under other Sections.
3. Where fabrications are to receive sprayed-on fireproofing, include statement that primer is compatible with fireproofing proposed for use.

C. Delegated-Design Submittal: For installed products indicated to comply with performance requirements and design criteria, including analysis data signed and sealed by the qualified professional engineer responsible for their preparation.

D. Welding certificates.

E. Qualification Data: For professional engineer.

1.05 QUALITY ASSURANCE

A. Engineering Responsibility: Preparation of Shop Drawings, design calculations, and other structural data by a qualified professional engineer.

B. Professional Engineer Qualifications: A professional engineer who is legally qualified to practice in the jurisdiction where Project is located and who is experienced in providing engineering services of the kind indicated. Engineering services are defined as those performed for installations of metal fabrications that are similar to those indicated for this Project in material, design, and extent.

C. Welding: Qualify procedures and personnel according to the following:

1. AWS D1.1, "Structural Welding Code - Steel."
2. AWS D1.2, "Structural Welding Code - Aluminum."
3. AWS D1.3, "Structural Welding Code - Sheet Steel."
4. AWS D1.6, "Structural Welding Code - Stainless Steel."

D. Metal Surfaces, General: Provide materials with smooth, flat surfaces, unless otherwise indicated. For metal fabrications exposed to view in the completed Work, provide materials without seam marks, roller marks, rolled trade names, or blemishes.

1.06 DELIVERY STORAGE AND HANDLING

- A. Aluminum to be delivered to the fabricator in accordance with ASTM B 660, complying with the commercial parking and preservation requirements.
- B. Epoxy Adhesive
 - 1. Store epoxy cartridges on pallets or shelving in a covered storage area.
 - 2. Control temperature above 60 degrees F and dispose of cartridges if shelf life has expired.
- C. Vinyl Ester Products
 - 1. Store components on pallets or shelving in a covered storage area with locking door.
 - 2. Control temperature within 41 to 77 degrees F and dispose of product if shelf life has expired.

1.07 PROJECT CONDITIONS

- A. Field Measurements: Verify actual locations of walls and other construction contiguous with metal fabrications by field measurements before fabrication and indicate measurements on Shop Drawings.
 - 1. Established Dimensions: Where field measurements cannot be made without delaying the Work, establish dimensions and proceed with fabricating metal fabrications without field measurements. Coordinate wall and other contiguous construction to ensure that actual dimensions correspond to established dimensions.
 - 2. Provide allowance for trimming and fitting at site.

1.08 COORDINATION

- A. Coordinate installation of anchorages for metal fabrications. Furnish setting drawings, templates, and directions for installing anchorages, including sleeves, concrete inserts, anchor bolts, and items with integral anchors, that are to be embedded in concrete or masonry. Deliver such items to Project site in time for installation.
- B. Coordinate installation of steel weld plates and angles for casting into concrete that are specified in this Section but required for work of another Section. Deliver such items to Project site in time for installation.

PART 2 - PRODUCTS

2.01 METALS

- A. Steel Plates, Shapes, and Bars: ASTM A 36/A 36M.

- B. Steel Tubing: ASTM A 500, cold-formed steel tubing.
- C. Steel Pipe: ASTM A 53/A 53M, standard weight (Schedule 40), unless another weight is indicated or required by structural loads.
 - 1. Provide Schedule 80 pipe for bollards.
- D. Slotted Channel Framing: Cold-formed metal channels with continuous slot complying with MFMA-4.
- E. Cast Iron: ASTM A 48/A 48M, Class 30, unless another class is indicated or required by structural loads.
- F. Aluminum Plate and Sheet: ASTM B 209 (ASTM B 209M), Alloy 6061-T6.
- G. Aluminum Sheet for Stairs: Alcad 3003-H14 and 3003.
- H. Aluminum Extrusions: ASTM B 221 (ASTM B 221M), Alloy 6063-T5, or 6063-T6.
- I. Aluminum-Alloy Rolled Tread Plate: ASTM B 632/B 632M, Alloy 6061-T6.
- J. Aluminum Castings: ASTM B 26/B 26M, Alloy 443.0-F.

2.02 FASTENERS

- A. General: Unless otherwise indicated, provide Type 316 stainless-steel fasteners. Provide stainless-steel fasteners for fastening aluminum. Select fasteners for type, grade, and class required.
- B. Anchor Bolts:
 - 1. Stainless steel in accordance with ASTM F 593, Alloy Group 2, Type 316.
 - 2. CW with hexagonal heads shall be provided for connections.
- C. Cast-in-Place Anchors in Concrete: Anchors capable of sustaining, without failure, a load equal to four times the load imposed, as determined by testing according to ASTM E 488, conducted by a qualified independent testing agency.
 - 1. Threaded or wedge type; ASTM F 593, type 316 stainless steel. Provide bolts, washers, and shims as needed.
- D. Expansion Anchors: Anchor bolt and sleeve assembly with capability to sustain, without failure, a load equal to six times the load imposed when installed in unit masonry and four times the load imposed when installed in concrete, as determined by testing according to ASTM E 488, conducted by a qualified independent testing agency.
 - 1. Acceptable Manufacturers: Kwik-Bolt 3 by Hilti, Inc., TruBolt Wedge Anchor by ITW Red Head or Power-Stud by Powers Fasteners.

- E. Slotted-Channel Inserts: Stainless steel box channels (struts) complying with MFMA-3, 1-5/8 by 7/8 inches by length indicated with anchor straps or studs not less than 3 inches long at not more than 8 inches o.c. Provide with temporary filler and tee-head bolts, complete with washers and nuts, as needed for fastening to inserts.
- F. Machine Screws: Stainless steel in accordance with ASME B18.6.3, Type 316.

2.03 MISCELLANEOUS MATERIALS

- A. Welding Rods and Bare Electrodes: Select according to AWS specifications for metal alloy welded.
- B. Universal Shop Primer: Fast-curing, lead- and chromate-free, universal modified-alkyd primer complying with MPI#79. Use primer containing pigments that make it easily distinguishable from zinc-rich primer.
- C. Zinc-Rich Primer: Complying with SSPC-Paint 20 or SSPC-Paint 29 and compatible with topcoat.
 - 1. Provide interior, field-applied primer with a VOC content of 250 g/L or less, when calculated according to 40 CFR 59, Subpart D (EPA Method 24).
- D. Galvanizing Repair Paint: High-zinc-dust-content paint for regalvanizing welds in steel, complying with SSPC-Paint 20.
 - 1. Provide interior, field-applied paint with a VOC content of 250 g/L or less, when calculated according to 40 CFR 59, Subpart D (EPA Method 24).
- E. Bituminous Paint: Cold-applied asphalt emulsion complying with ASTM D 1187.
- F. Nonshrink, Nonmetallic Grout: Factory-packaged, nonstaining, noncorrosive, nongaseous grout complying with ASTM C 1107. Provide grout specifically recommended by manufacturer for interior and exterior applications.

2.04 FABRICATION, GENERAL

- A. Shop Assembly: Preassemble items in the shop to greatest extent possible. Disassemble units only as necessary for shipping and handling limitations. Use connections that maintain structural value of joined pieces. Clearly mark units for reassembly and coordinated installation.
- B. Stairs: Assemble stairs in shop to greatest extent possible. Disassemble units only as necessary for shipping and handling limitations. Clearly mark units for reassembly and coordinated installation.
- C. Cut, drill, and punch metals cleanly and accurately. Remove burrs and ease edges to a radius of approximately 1/32 inch, unless otherwise indicated. Remove sharp or rough areas on exposed surfaces.

- D. Form bent-metal corners to smallest radius possible without causing grain separation or otherwise impairing work.
- E. Form exposed work true to line and level with accurate angles and surfaces and straight edges.
- F. Weld corners and seams continuously to comply with the following:
 - 1. Use materials and methods that minimize distortion and develop strength and corrosion resistance of base metals.
 - 2. Obtain fusion without undercut or overlap.
 - 3. Remove welding flux immediately.
 - 4. At exposed connections, finish exposed welds and surfaces smooth and blended so no roughness shows after finishing and contour of welded surface matches that of adjacent surface.
- G. Form exposed connections with hairline joints, flush and smooth, using concealed fasteners where possible. Where exposed fasteners are required, use Phillips flat-head (countersunk) screws or bolts, unless otherwise indicated. Locate joints where least conspicuous.
- H. Fabricate seams and other connections that will be exposed to weather in a manner to exclude water. Provide weep holes where water may accumulate.
- I. Cut, reinforce, drill, and tap metal fabrications as indicated to receive finish hardware, screws, and similar items.
- J. Provide for anchorage of type indicated; coordinate with supporting structure. Space anchoring devices to secure metal fabrications rigidly in place and to support indicated loads.

2.05 FLOOR HATCHES

- A. Provide watertight aluminum floor hatches including frames, grating, guards, fall protection and lift assist; Type JD-AL - Channel Frame, 300 PSF, Double Leaf; Bilco or equal.

1.01 STAIR SYSTEMS

A. Aluminum stairs:

- 1. Provide structural aluminum channel stringers and supports, aluminum tread plate treads and platforms, sheet aluminum risers, grating treads and platforms as indicated on the Drawings and in the details.

B. Plate treads:

- 1. Formed from ¼ inch thick aluminum tread plate and the risers shall be formed from 0.080-inch thick sheet aluminum.

2. Treads shall be supported by and attached to 1-1/4 inch by 1-1/4 inch by 3/16 inch aluminum carrier angles bolted to the stringers.
 3. Treads shall be the widths indicated.
 4. Risers shall be bolted to the treads.
- C. Plate platforms:
1. Fabricated of 1/4 inch thick aluminum tread plate and shall be supported on the edges by structural aluminum angles and at the mid spans by structural aluminum tees.
- D. Aluminum tread plate for treads and platforms shall have an acceptable nonskid pattern surface.
- E. Provide all structural aluminum angle hangers, struts, rod hangers, closure plates, and brackets indicated or necessary to complete the stairs as indicated.
- F. Grating stair treads:
1. Welded aluminum safety treads with 1-1/4 inch abrasive or extruded aluminum corrugated nosings.
 2. Punched and slotted integral carrier plates for attaching to the channel stringers.
- G. Grating platforms
1. Constructed of the specified aluminum grating and shall have the same nosings as the treads.
 2. Supported at the ends on structural aluminum angles and at the mid spans by structural aluminum tees.
- B. Metal Bar-Grating Stairs: Form treads and platforms to configurations shown from metal bar grating; fabricate to comply with NAAMM MBG 531, "Metal Bar Grating Manual."
1. Fabricate treads and platforms from welded grating with openings in gratings no more than 1/2 inch in least dimension.
 2. Surface: Serrated.
 3. Fabricate grating treads with floor plate nosing and with angle or plate carrier at each end for stringer connections. Secure treads to stringers with bolts.
 4. Fabricate grating platforms with nosing matching that on grating treads. Provide toeplates at open-sided edges of grating platforms. Weld grating to platform framing.

2.06 TUBE RAILINGS

- A. General: Fabricate railings to comply with requirements indicated for design, dimensions, details, finish, and member sizes, including wall thickness of tube, post spacings, and anchorage, but not less than that needed to withstand indicated loads.

- B. Welded Connections: Fabricate railings with welded connections. Cope components at connections to provide close fit, or use fittings designed for this purpose. Weld all around at connections, including at fittings.
- C. Form changes in direction of railings as detailed on the Drawings.
- D. Form simple and compound curves by bending members in jigs to produce uniform curvature for each repetitive configuration required; maintain cross section of member throughout entire bend without buckling, twisting, cracking, or otherwise deforming exposed surfaces of components.
- E. Close exposed ends of railing members with prefabricated end fittings.
- F. Provide wall returns at ends of wall-mounted handrails, unless otherwise indicated. Close ends of returns unless clearance between end of rail and wall is 1/4 inch or less.
- G. Brackets, Flanges, Fittings, and Anchors: Provide wall brackets, end closures, flanges, miscellaneous fittings, and anchors for interconnecting components and for attaching to other work. Furnish inserts and other anchorage devices for connecting to concrete or masonry work.
 - 1. Connect posts to stair framing by direct welding, unless otherwise indicated.
 - 2. For galvanized railings, provide galvanized fittings, brackets, fasteners, sleeves, and other ferrous-metal components.
 - 3. For nongalvanized railings, provide nongalvanized ferrous-metal fittings, brackets, fasteners, and sleeves, except galvanize anchors embedded in exterior masonry and concrete construction.
- H. Fillers: Provide fillers made from plate, or other suitably crush-resistant material, where needed to transfer wall bracket loads through wall finishes to structural supports. Size fillers to suit wall finish thicknesses and to produce adequate bearing area to prevent bracket rotation and overstressing of substrate.

2.07 BAR GRATING

- A. Extruded Bars and Shapes: ASTM B 221 (ASTM B 221M), alloys as follows:
 - 1. Bearing bars: 6061-T6.
 - 2. Crimp bars: 6063-T6.

2.08 LOOSE BEARING AND LEVELING PLATES

- A. Provide loose bearing and leveling plates for steel items bearing on masonry or concrete construction. Drill plates to receive anchor bolts and for grouting.

2.09 LOOSE STEEL LINTELS

- A. Fabricate loose steel lintels from steel angles and shapes of size indicated for openings and recesses in masonry walls and partitions at locations indicated. Weld adjoining members together to form a single unit where indicated.
- B. Size loose lintels to provide bearing length at each side of openings equal to 1/12 of clear span but not less than 8 inches, unless otherwise indicated.

2.10 SHELF ANGLES

- A. Fabricate shelf angles from steel angles of sizes indicated and for attachment to concrete framing. Provide horizontally slotted holes to receive 3/4-inch bolts, spaced not more than 6 inches from ends and 24 inches o.c., unless otherwise indicated.
 - 1. Provide mitered and welded units at corners.
 - 2. Provide open joints in shelf angles at expansion and control joints. Make open joint approximately 2 inches larger than expansion or control joint.
- B. For cavity walls, provide vertical channel brackets to support angles from backup masonry and concrete.
- C. Furnish wedge-type concrete inserts, complete with fasteners, to attach shelf angles to cast-in-place concrete.

2.11 MISCELLANEOUS FRAMING AND SUPPORTS

- A. General: Provide framing and supports not specified in other Sections as needed to complete the Work.
- B. Fabricate units from shapes, plates, and bars of welded construction, unless otherwise indicated. Fabricate to sizes, shapes, and profiles indicated and as necessary to receive adjacent construction retained by framing and supports. Cut, drill, and tap units to receive hardware, hangers, and similar items.
 - 1. Fabricate units from slotted channel framing where indicated.
 - 2. Furnish inserts if units are installed after concrete is placed.

2.12 STEEL WELD PLATES AND ANGLES

- A. Provide steel weld plates and angles not specified in other Sections, for items supported from concrete construction as needed to complete the Work. Provide each unit with not less than two integrally welded steel strap anchors for embedding in concrete.

2.13 MISCELLANEOUS TRIM

- A. Unless otherwise indicated, fabricate units from shapes, plates, and bars of profiles shown with continuously welded joints and smooth exposed edges. Miter corners and use concealed field splices where possible.
- B. Provide cutouts, fittings, and anchorages as needed to coordinate assembly and installation with other work.
 - 1. Provide with integrally welded steel strap anchors for embedding in concrete or masonry construction.

2.14 METAL BOLLARDS

- A. Fabricate metal bollards from Schedule 80 steel pipe, hot-dip galvanized.
- B. Fabricate bollards with welded metal cap, and in accordance with Drawings.
- C. Provide concrete for placing bollards. Comply with requirements of Division 03 - Concrete, and details indicated on drawings.

2.15 PIPE GUARDS

- A. Fabricate pipe guards from 3/8-inch-thick by 12-inch--wide steel plate, bent to fit flat against the wall or column at both ends and to fit around pipe with 2-inch clearance between pipe and pipe guard. Drill each end for two 3/4-inch anchor bolts.

2.16 METAL DOWNSPOUT BOOTS

- A. Provide downspout boots made from cast gray iron in heights indicated with inlets of size and shape to suit downspouts.

2.17 METAL FLOOR PLATES

- A. Metal Floor Plate: 1/4 inch thick mill finished aluminum diamond plate with beveled edges and 3 inch overlap of opening all around. Provide galvanized steel angle frame and stiffeners, and flush stainless steel bar drop handles for lifting removable plate, one at each end of section.

2.18 FINISHES, GENERAL

- A. Comply with NAAMM's "Metal Finishes Manual for Architectural and Metal Products" for recommendations for applying and designating finishes.
- B. Finish metal fabrications after assembly.

2.19 ALUMINUM FINISHES

- A. As-Fabricated Finish: AA-M12.

2.20 STEEL PRIMERS AND FINISHES

- A. Preparation for Shop Priming: Prepare uncoated ferrous-metal surfaces to comply with minimum requirements indicated below for SSPC surface preparation specifications and environmental exposure conditions of installed metal fabrications:
1. Exteriors (SSPC Zone 1B) and Items Indicated to Receive Zinc-Rich Urethane Primer: SSPC-SP 6/NACE No. 3, "Commercial Blast Cleaning."
 2. Interiors (SSPC Zone 1A): SSPC-SP 7, "Brush Off Blast Cleaning."
 3. Apply shop primer to uncoated surfaces of metal fabrications, except those with galvanized finishes and those to be field welded, embedded in concrete or masonry, unless otherwise indicated. Extend priming of partially embedded members to a depth of 2 inches.
 4. Comply with SSPC-PA 1, "Paint Application Specification No. 1: Shop, Field, and Maintenance Painting of Steel," for shop painting.
 5. Comply with SSPC-PA 2, "Measurement of Dry Coating Thickness with magnetic Gages."
- B. Zinc-Rich Primer: Urethane zinc rich primer compatible with topcoat Specified in Section 09900 - PAINTS AND COATINGS. Provide primer with a VOC content of 340 g/L (2.8 lb/gal.) or less per OTC and HAPS COMPLIANT STANDARDS PER 2007 standards when calculated according to 40 CFR 59, Subpart D (EPA Method 24). Provide Tnemec Series 394 Perimerprime at 3.0 mils DFT or approved equal by DuPont or Carboline.
1. Provide interior, field-applied primer with a VOC content of 250 g/L or less, when calculated according to 40 CFR 59, Subpart D (EPA Method 24).

2.21 HOT-DIP GALVANIZING

- A. Hot-Dip Galvanizing: For steel exposed to the elements, weather or corrosive environments and other steel indicated to be galvanized, provide coating for iron and steel fabrications applied by the hot-dip process.
1. Basis-of-Design: Duragalv by Duncan Galvanizing.
 2. Comply with ASTM A 123 for fabricated products and ASTM A 153 for hardware.
 3. Provide thickness of galvanizing specified in referenced standards.
 4. Galvanizing bath shall contain special high grade zinc and other earthly materials.
 5. Fill vent holes after galvanizing, if applicable, and grind smooth.

2.22 HOT-DIP GALVANIZING AND FACTORY-APPLIED PRIMER

- A. Hot-Dip Galvanizing: For steel exposed to the elements, weather or corrosive environments and other steel indicated to be galvanized, provide coating for iron and steel fabrications applied by the hot-dip process.
1. Basis-of-Design: Duragalv by Duncan Galvanizing.

2. Comply with ASTM A 123 for fabricated products and ASTM A 153 for hardware.
 3. Provide thickness of galvanizing specified in referenced standards.
 4. Galvanizing bath shall contain special high grade zinc and other earthly materials.
 5. Fill vent holes after galvanizing, if applicable, and grind smooth.
- B. Factory-Applied Primer over Galvanized Steel: Provide factory-applied prime coat, certified OTC/VOC compliant less than 2.8 lbs/gal. and conforming to EPA and local requirements. Apply primer within 12 hours after galvanizing at the same galvanizer's plant in a controlled environment meeting applicable environmental regulations and as recommended by the primer coating manufacturer. Primer coat shall exhibit a rugosity (smoothness) not greater than 4 rug (16-20 microns of variation) when measured by a profilometer over a 1 inch straight line on the surface of architectural and structural elements that are less than 24 pounds per running foot. Profilometer shall be capable of operating in 1 micron increments. Blast cleaning of the surface is unacceptable for surface preparation. Primer shall have a minimum two year re-coat window for application of finish coat. Coatings must meet or exceed the following performance criteria as stipulated by the coatings manufacturer:
1. Basis-of-Design: Primergalv by Duncan Galvanizing.
 2. Abrasion Resistance: ASTM D 4060 (CS17 Wheel, 1,000 grams load).1kg load, 200 mg loss.
 3. Adhesion: ASTM D4541, 1050 psi.
 4. Corrosion Weathering: ASTM D5894, 13 cycles, 4,368 hours; rating 10 per ASTM D714 for blistering and rating 7 per ASTM D610 for rusting.
 5. Direct Impact Resistance: ASTM D2794, 160 in. lbs.
 6. Flexibility: Method: ASTM D522, 180 degree bend, 1 inch mandrel, passes.
 7. Pencil Hardness: ASTM D3363, 3B.
 8. Moisture Condensation Resistance: ASTM D4585, 100 degrees F, 2000 hours; passes, no cracking or delamination.
 9. Dry Heat Resistance: Method: ASTM D2485, 250 degrees F.
 10. Warranty: Provide galvanizer's warranty that materials will be free from 10 percent or more visible rust for a period of 20 years.

PART 3 - EXECUTION

3.01 INSTALLATION, GENERAL

- A. Cutting, Fitting, and Placement: Perform cutting, drilling, and fitting required for installing metal fabrications. Set metal fabrications accurately in location, alignment, and elevation; with edges and surfaces level, plumb, true, and free of rack; and measured from established lines and levels.
- B. Fit exposed connections accurately together to form hairline joints. Weld connections that are not to be left as exposed joints but cannot be shop welded because of shipping

size limitations. Do not weld, cut, or abrade surfaces of exterior units that have been hot-dip galvanized after fabrication and are for bolted or screwed field connections.

- C. Field Welding: Comply with the following requirements:
 - 1. Use materials and methods that minimize distortion and develop strength and corrosion resistance of base metals.
 - 2. Obtain fusion without undercut or overlap.
 - 3. Remove welding flux immediately.
 - 4. At exposed connections, finish exposed welds and surfaces smooth and blended so no roughness shows after finishing and contour of welded surface matches that of adjacent surface.
- D. Fastening to In-Place Construction: Provide anchorage devices and fasteners where metal fabrications are required to be fastened to in-place construction. Provide threaded fasteners for use with concrete and masonry inserts, toggle bolts, through bolts, lag bolts, wood screws, and other connectors.
- E. Provide temporary bracing or anchors in formwork for items that are to be built into concrete, masonry, or similar construction.
- F. Corrosion Protection, General: Coat concealed surfaces of steel and aluminum that will come into contact with grout, concrete, masonry, wood, or dissimilar metals with a heavy coat of bituminous paint.

3.02 INSTALLING BEARING AND LEVELING PLATES

- A. Clean concrete and masonry bearing surfaces of bond-reducing materials, and roughen to improve bond to surfaces. Clean bottom surface of plates.
- B. Set bearing and leveling plates on wedges, shims, or leveling nuts. After bearing members have been positioned and plumbed, tighten anchor bolts. Do not remove wedges or shims but, if protruding, cut off flush with edge of bearing plate before packing with grout.
 - 1. Use nonshrink grout, either metallic or nonmetallic, in concealed locations where not exposed to moisture; use nonshrink, nonmetallic grout in exposed locations, unless otherwise indicated.
 - 2. Pack grout solidly between bearing surfaces and plates to ensure that no voids remain.

3.03 INSTALLING MISCELLANEOUS FRAMING AND SUPPORTS

- A. General: Install framing and supports to comply with requirements of items being supported, including manufacturers' written instructions and requirements indicated on Shop Drawings.

3.04 INSTALLING PIPE BOLLARDS

- A. Anchor bollards in place with concrete footings. Center and align bollards in holes 3 inches above bottom of excavation. Place concrete and vibrate or tamp for consolidation. Support and brace bollards in position until concrete has cured.

3.05 INSTALLING PIPE GUARDS

- A. Provide pipe guards at exposed vertical pipes in parking garage where not protected by curbs or other barriers. Install by bolting to wall or column with expansion anchors. Provide four 3/4-inch bolts at each pipe guard. Mount pipe guards with top edge 26 inches above driving surface.

3.06 ALUMINUM WORK PROTECTION

- A. Aluminum surfaces be in contact with concrete or masonry to be protected by a coat of Coal Tar 46-465 H. B. Themecol manufactured by Tnemec Company, North Kansas City, MO; Bitumastic Super Service Black manufactured by KOP-COAT, Inc., Pittsburgh, PA; or an acceptable equivalent product.
- B. Areas where the paint has been damaged by abrasion or other cause shall be cleaned and repainted as directed so that the aluminum will have a complete protective paint film when brought into contact with the material against which it is being protected. Before application of coating, the surface shall be cleaned of all dirt, heavy deposits of grease or oil, and other foreign substances, and shall be immersed in or swabbed with an acceptable solvent. Next, the surfaces shall be rinsed with clear water and thoroughly dried.
- C. Protect against electrolysis where aluminum is to be used in conjunction with dissimilar metals.
- D. Where a shop coating of methacrylate lacquer has been specified on aluminum work to protect the surface from stain, the protective coating of lacquer worn off due to handling or erection shall be replaced in the field by a new coating of lacquer of the same type.
- E. During construction, care shall be taken to prevent damage to the aluminum work from splashing or by the accumulation of paint, concrete, mortar, or other similar materials.

3.07 ADJUSTING AND CLEANING

- A. Touchup Painting: Immediately after erection, clean field welds, bolted connections, and abraded areas. Paint uncoated and abraded areas with the same material as used for shop painting to comply with SSPC-PA 1 for touching up shop-painted surfaces.
 - 1. Apply by brush or spray to provide a minimum 2.0-mil dry film thickness.

- B. Touch-Up and Repair for Galvanized Surfaces: For damaged and field-welded metal coated surfaces, clean welds, bolted connections and abraded areas.
1. For galvanized surfaces, apply organic zinc repair paint complying with requirements of ASTM A 780, modified to 95 percent zinc in dry film. Galvanizing repair paint shall have 95 percent zinc by weight, ZiRP by Duncan Galvanizing. Thickness of applied galvanizing repair paint shall be not less than coating thickness required by ASTM A 123 or A 153 as applicable. Touch-up of galvanized surfaces with silver paint, brite paint, or aluminum paints is not acceptable.
 2. For factory-applied finish coatings, field-touch-up shall be performed by factory approved personnel for warranties to apply. Touch-up shall be such that repair is not visible from a distance of 6 feet. If non factory-approved technicians are used for field touch-up, no warranties shall exist.
 3. A touch-up repair kit or touchup instructions shall be provided to the Owner for each type of factory-applied finish.

END OF SECTION

SECTION 05510

ALUMINUM STAIRS AND LADDERS

PART 1 GENERAL

1.01 SUMMARY

A. Section Includes

1. Requirements for the fabrication and installation of aluminum stair and ladder systems.

B. Related Sections

1. Section 05500 – Metal Fabrications
2. Section 05520 - Aluminum Handrails and Railings.
3. Section 05530 – Metal Grating

1.02 SYSTEM DESCRIPTION

A. Design Requirements

1. Comply with the provisions of the following codes, standards, and specifications, except as otherwise shown or specified.

- a. The Aluminum Association Designations:

Structural rolled or extruded shapes	6061-T6
Extruded shapes	6063-T5
Plates	6061-T6
Gratings (bearing bars)	6061-T6
(crimp bars)	6063-T6
Sheets	Alcad 3003-H14 and 3003
Bolts and nuts	2024-T4

B. Performance Requirements

1. Stairs are to be fabricated to support a live load of 100 lbs. /sq. ft. and a moving concentrated load of not less than 300 lbs.

1.03 SUBMITTALS

A. In accordance with Section 01300 submit the following:

1. Complete shop drawings and design computations, stamped by a Professional Engineer registered in the State of Massachusetts who is experienced in this type of work. All computations shall be in conformance with the Specifications for Aluminum Structures, (SAS) 30, by the American Aluminum Association. This submission will be reviewed by the Engineer but design responsibility remains with the Contractor and the Contractor's Engineer and under no circumstances, does the Engineer assume responsibility for the means, methods, sequences, procedures or techniques in connection with the performance of any of the work of the Contractor.
2. Submit copies of manufacturer's specifications, load tables, dimension diagrams, anchorage, anchor, details and installation instructions for products to be used in the fabrication of aluminum stair work, include coating products. Transmit copy of instructions to the installer.
3. Shop drawings for the fabrication and erection of aluminum stair assemblies and ladders. Include plans and elevations at not less than 1" to 1'-0" scale, and include details of

sections and connections at not less than 3" to 1'-0" scale. Show anchorage and accessory items.

4. Mill certificates and a signed statement from the fabricator that all aluminum work furnished is of the proper alloys as specified herein.

1.04 SEQUENCING

A. Inserts and Anchorages:

1. Furnish inserts and anchoring devices which must be set in concrete or built into masonry for the installation of the stairs, handrails, and railings work.
2. Provide setting drawings, templates, instructions and directions for installation of anchorage devices.
3. Coordinate delivery with other work to avoid delay.

PART 2 PRODUCTS

2.01 STAIR SYSTEMS

A. Aluminum stairs

1. Provide structural aluminum channel stringers and supports, aluminum tread plate treads and platforms, sheet aluminum risers, grating treads and platforms as indicated on the Drawings and in the details.

B. Plate treads

1. Formed from ¼ inch thick aluminum tread plate and the risers shall be formed from 0.080-inch thick sheet aluminum.
2. Treads shall be supported by and attached to 1-1/4 inch by 1-1/4 inch by 3/16 inch aluminum carrier angles bolted to the stringers.
3. Treads shall be the widths indicated.
4. Risers shall be bolted to the treads.

C. Plate platforms

1. Fabricated of ¼ inch thick aluminum tread plate and shall be supported on the edges by structural aluminum angles and at the mid spans by structural aluminum tees.

D. Aluminum tread plate for treads and platforms shall have an acceptable nonskid pattern surface.

E. Provide all structural aluminum angle hangers, struts, rod hangers, closure plates, and brackets indicated or necessary to complete the stairs as indicated.

F. Grating stair treads

1. In accordance with SECTION 05530 and the following:
2. Welded aluminum safety treads with 1-1/4 inch abrasive or extruded aluminum corrugated nosings.
3. Punched and slotted integral carrier plates for attaching to the channel stringers.

G. Grating platforms

1. In accordance with SECTION 05530 and the following:
2. Constructed of the specified aluminum grating and shall have the same nosings as the treads.
3. Supported at the ends on structural aluminum angles and at the mid spans by structural aluminum tees.

2.02 LADDERS

- A. Constructed of pipe uprights with solid round rod rungs mortised and welded to the uprights. Securely anchor to the wall with angles or bent plates, as indicated, welded to the uprights and expansion bolted to the wall. All welds shall be ground smooth.
- B. Interior ladders shall be secured to the floor slabs with floor flanges as indicated.
- C. The uprights of ladders to roofs or platforms shall widen at the top, extend above the roof or platform level, and shall be turned back to form guard rails.
- D. Construct from 1-1/2 inch IPS, Schedule 40 aluminum pipe uprights and 1 inch solid round aluminum rod rungs unless otherwise indicated on the drawings. After fabrication, the aluminum ladders shall be given an Aluminum Association Standard Finish, Designation M12C22A31 followed by a shop coat of methacrylate lacquer.

2.03 HANDRAILS

- A. In accordance with Specification SECTION 05520.

2.04 SHIP LADDER

- A. Constructed of aluminum channel stringers, aluminum pipe handrails and aluminum riveted grating treads. The treads to be Type K manufactured by Borden Metal products Co., Elizabeth, NJ; Reticuline Type M manufactured by IKG Industries, Long Island City, NY; Type KM manufactured by Kerrigan Iron Works, Inc., Nashville, TN; or acceptable equivalent product.
- B. Bearing bars of treads to be 3/16 inch thick by 1-1/4 inch deep and be fabricated of 6061-T6 aluminum alloy.
- C. Crimp bars to be fabricated of 6063-T5 aluminum alloy, riveted on 7 inch centers, and raised slightly above the bearing bars and serrated.
- D. Treads to be provided with integral slotted and punched end plates for attaching to stringers. Treads to be provided with 1-1/4 inch abrasive or extruded aluminum corrugated nosings.
- E. Provide structural aluminum clip angles, brackets and fasteners to complete the ship ladders as detailed on the Drawings.

2.05 FASTENERS

- A. Stainless steel in accordance with SECTION 05500.

2.06 FABRICATION

- A. Shop Assembly
 - 1. Use materials of the size and thickness shown, or if not show, of the required size and thickness to produce adequate strength and durability in the finished product for the intended use. Work to conform to the dimensions shown or accepted on shop drawings, using proven details of fabrication and support. Use the type of materials shown or specified for the various components of work.
 - 2. Form exposed work true to line and level with accurate angles and surfaces and straight sharp edges. Ease exposed edges to a radius of approximately 1/32 of an inch unless otherwise shown. Form bent metal corners to the smallest radius possible without causing grain separation or otherwise impairing the work.

3. Weld corners and seams continuously in accordance with the recommendations of the American Welding Society. Grind exposed welds smooth and flush, to match and blend with adjoining surfaces.
4. Form exposed connections with hairline joints which are flush and smooth, using concealed fasteners wherever possible. Use exposed fasteners of the type shown, or if not shown, use Phillips flathead (countersunk) screws or bolts.
5. Provide for anchorage of the type shown, coordinated with the supporting structure. Fabricate and space anchoring devices as shown and as required to provide adequate support for the intended use of the work.
6. Pre-assemble items in the shop to the greatest extent possible, so as to minimize field splicing and assembly of units at the project site. Disassemble units only to the extent necessary for shipping and handling limitations. Clearly mark units for reassembly and coordinated installation.

PART 3 EXECUTION

3.01 INSTALLATION

A. Anchorages

1. Furnish setting drawings, diagrams, templates instructions and directions for the installation of anchorages, such as concrete inserts, anchor bolts and miscellaneous items having integral anchors.
2. Install inserts and anchorage devices in accordance with Section 05500.
3. The use of impact imbedded fasteners will not be allowed.

3.02 FASTENING TO IN-PLACE CONSTRUCTION

- #### A. Provide anchorage devices and fasteners where necessary for securing stair items to in-place construction; including, threaded fasteners for concrete and masonry inserts, toggle bolts, through-bolts, lag bolts and other connectors as required.

3.03 CUTTING, FITTING AND PLACEMENT

- #### A. Perform all cutting, drilling and fitting required for the installation of the miscellaneous metal items. Set the work accurately in location, alignment and elevation, plumb, level, true and free of rack, measured from established lines and levels. Provide temporary bracing or anchors in framework for items which are to be built into concrete, masonry or similar construction.
- #### B. Fit exposed connections accurately together for form tight hairline joints. Weld connections which are not to be left as exposed joints, but cannot be shop-welded because of shipping size limitations.

3.04 FIELD WELDING

- #### A. Comply with AWS Code for the procedures of manual shielded metalarc welding, the appearance and quality of welds made, and the methods used in correcting welding work.

3.05 ALUMINUM WORK PROTECTION

- #### A. Aluminum surfaces be in contact with concrete or masonry to be protected by a coat of Coal Tar 46-465 H. B. Tnemecol manufactured by Tnemec Company, North Kansas City, MO; or an acceptable equivalent product.

- B. Areas where the paint has been damaged by abrasion or other cause shall be cleaned and repainted as directed so that the aluminum will have a complete protective paint film when brought into contact with the material against which it is being protected. Before application of coating, the surface shall be cleaned of all dirt, heavy deposits of grease or oil, and other foreign substances, and shall be immersed in or swabbed with an acceptable solvent. Next, the surfaces shall be rinsed with clear water and thoroughly dried.
- C. Protect against electrolysis where aluminum is to be used in conjunction with dissimilar metals.
- D. Where a shop coating of methacrylate lacquer has been specified on aluminum work to protect the surface from stain, the protective coating of lacquer worn off due to handling or erection shall be replaced in the field by a new coating of lacquer of the same type.
- E. During construction, care shall be taken to prevent damage to the aluminum work from splashing or by the accumulation of paint, concrete, mortar, or other similar materials.

3.06 CLEANING ALUMINUM WORK

- A. After aluminum has been erected, it shall be cleaned with mild soap and water, followed by a clear water rinse.

END OF SECTION

(THIS PAGE INTENTIONALLY LEFT BLANK)

SECTION 05520

ALUMINUM HANDRAILS AND RAILINGS

PART 1 GENERAL

1.01 SUMMARY

A. Section Includes

1. Requirements for fabrication and installation of aluminum handrails and railing.

B. Related Sections

1. Section 05500 – Metal Fabrications

1.02 PERFORMANCE REQUIREMENTS

- ###### A. Railing assembly including anchoring of posts and framing members shall be capable of withstanding a minimum load of at least 200 lb. applied in any direction at any point on the top rail.

1.03 SUBMITTALS

A. In accordance with Section 01300 submit the following:

1. Manufacturer's specifications, dimension diagrams, anchor details and installation instructions for products to be used in the fabrication of handrails and railings, include coating products. Transmit copy of instructions to the installer.
2. Shop drawings for the fabrication and erection of handrail and railing assemblies. Include plans and elevations at not less than 1" to 1'-0" scale, and include details of sections and connections at not less than 3" to 1'-0" scale. Show anchorage and accessory items.

1.04 QUALITY ASSURANCE

A. Qualification for Welding Work.

1. Confirm welding processes and welding operators in accordance with the American Welding Society, AWS D1.2, Structural Welding Code – Aluminum.

1.05 PROJECT CONDITIONS

A. Field Measurements.

1. Take field measurements prior to preparation of shop drawings and fabrication to ensure proper fitting of the work to existing features and work completed under this Contract.
2. Coordinate fabrication with Construction Schedule.
3. Where field measurements cannot be made without delaying the Work, proceed with fabricating metal fabrications upon receipt of Engineer reviewed and approved shop drawings, without field measurements. Allowance shall be made for trimming and fitting.

1.06 SEQUENCING

A. Inserts and Anchorages:

1. Furnish inserts and anchoring devices which must be set in concrete or built into masonry for the installation of the handrails and railings work.
2. Provide setting drawings, templates, instructions and directions for installation of anchorage devices.
3. Coordinate delivery with other work to avoid delay.

PART 2 PRODUCTS

2.01 HANDRAILS AND RAILINGS

A. General

1. All-welded construction.
2. Fabricated as indicated on the Drawings.
3. Stanchions to be 1-1/2 inch IPS, Schedule 80 aluminum pipe, alloy 6063-T6
4. Top and intermediate rails and returns to be 1-1/2 inch Schedule 40 aluminum pipe, alloy 6063-T6.
5. Fabricate in panels with joints made in a neat and inconspicuous manner.
6. All exposed welds shall be ground smooth.
7. Provide stainless steel anchor bolts and fasteners in accordance with SECTION 05500.

B. Removable pipe railings

1. Fabricated in the same manner as fixed railings.
2. Installed as indicated.

C. Brackets for wall-mounted handrails

1. Cast aluminum pipe rail brackets with curved tops.
2. 3 inch projection from wall to the center of the handrail.

D. Brackets for floor mounted stanchions

1. Cast aluminum of the round, flat base flange configuration.
2. Designed to withstand the required loading and to support and reinforce the post.

E. Brackets for side-mounted stanchions

1. Aluminum brackets as detailed on the Drawings.
2. Provide a 1-3/8 inch projection from wall to the center of the stanchion.

2.02 HANDICAPPED PROVISIONS

- A. Provide knurled, abrasive or other textured finish on portions of handrails, a distance of 4 feet from stairs and other openings, to indicate a danger signal in accordance with applicable ADA requirements.

2.03 FABRICATION

A. Shop Assembly:

1. Form exposed work true to line and elevation with accurate angles and surfaces and straight sharp edges. Ease exposed edges to a radius of approximately 1/32 of an inch, unless otherwise shown. Form bent-metal corners to the smallest radius possible without causing grain separation or otherwise impairing the work.
2. Weld corners and seams continuously in accordance with the recommendations of AWS. Grind exposed welds smooth and flush, to match and blend with adjoining surfaces.

3. Form exposed connections with flush, smooth, hairline joints, using concealed fasteners wherever possible. Use exposed fasteners of the type shown, or if not shown, use Phillips flathead (countersunk) screws or bolts.
4. Provide for anchorage of the type shown, coordinated with the supporting structure. Fabricate and space anchoring devices as shown and as required to provide adequate support.
5. After fabrication, all aluminum pipe railings shall receive an Aluminum Association Standard Anodic Finish, Designation M12C22A31.
6. Preassemble items in the shop to the greatest extent possible, so as to minimize field splicing and assembly of units at the project site. Disassemble units only to the extent necessary for shipping and handling limitations. Clearly mark units for reassembly and coordinated installation.

PART 3 EXECUTION

3.01 INSTALLATION

A. Anchorages

1. Furnish setting drawings, diagrams, templates instructions and directions for the installation of anchorages, such as concrete inserts, anchor bolts and miscellaneous items having integral anchors.
2. Install inserts and anchorage devices in accordance with Section 05500.
3. The use of impact imbedded fasteners will not be allowed.

3.02 FASTENING TO IN-PLACE CONSTRUCTION

A. Provide anchorage devices and fasteners where necessary to secure handrails and railings to in place construction; including, threaded fasteners for concrete and masonry inserts, toggle bolts, through-bolts, lag bolts, wedge anchors and other connectors as required.

3.03 CUTTING, FITTING AND PLACEMENT

- A. Perform all cutting, drilling and fitting required for the installation. Set the work accurately in location, alignment and elevation, plumb, level, true and free of rack, measured from established lines and levels. Provide temporary bracing or anchors in framework for items which are to be built into concrete, masonry or similar construction.
- B. Fit exposed connections accurately together to form tight hairline joints. Weld connections which are not to be left as exposed joints, but cannot be shop-welded because of shipping size limitations.
- C. Adjust railings prior to securing in place to ensure proper matching at butting joints and correct alignment throughout their length. Space posts not more than 8 feet on centers, unless otherwise shown. Plumb posts in each direction. Secure posts and rail ends to building construction as follows:
 1. Handrail stanchions shall be mounted on the top of stair stringers as indicated on the drawings.
 2. The stanchions set into concrete curbs shall be set into preformed holes and secured in place with nonshrinking grout. The holes shall be at least $\frac{3}{4}$ inches greater in diameter than the outside diameter of the stanchions and shall be a minimum of 5 inches deep.
 3. Products offered by manufacturers to comply with the requirements for hydraulic cement include the following:
 - a. Embeco: Master Builder's
 - b. Ferrolith G; Sonneborn Bldg. Products, Inc.

- c. Por-Rok; Halemite Mfg. Co.
- 4. The stanchions to be side-mounted to structure walls shall be attached to brackets anchored to the structure wall with wedge anchors or suitable fasteners providing a system capable of withstanding the minimum load as specified.
- D. Anchor rail ends into concrete and masonry with aluminum round flanges (unless shown otherwise) welded to rail ends and anchored into the wall construction with lead expansion shields and bolts.
- E. Secure handrails to walls as shown, or by means of wall brackets, and wall return fitting at handrail ends.
- F. Provide brackets with not less than 3 inch projection from the finish wall surface to the center of the pipe handrail, and with the wall plate portion of the bracket drilled to receive on 3/8 inch bolt. Locate brackets not more than 60 inches on center. Provide flush-type wall return fittings with the same projection as that specified for wall brackets. Secure wall brackets and wall return fittings to building construction as follows:
 - 1. For concrete and solid masonry anchorage, use bolt anchor expansion shields and lag bolts.
 - 2. For hollow masonry anchorage use toggle bolts having square heads.

3.04 FIELD WELDING

- A. Comply with AWS Code for the procedures of manual shielded metalarc welding, the appearance and quality of welds made, and the methods used in correcting welding work.

3.05 ALUMINUM WORK PROTECTION

- A. Aluminum surfaces be in contact with concrete or masonry to be protected by a coat of Coal Tar 46-465 H.B. Themecol manufactured by Tnemec Company, North Kansas City, MO; or an acceptable equivalent product.
- B. Areas where the paint has been damaged by abrasion or other cause shall be cleaned and repainted as directed so that the aluminum will have a complete protective paint film when brought into contact with the material against which it is being protected. Before application of coating, the surface shall be cleaned of all dirt, heavy deposits of grease or oil, and other foreign substances, and shall be immersed in or swabbed with an acceptable solvent. Next, the surfaces shall be rinsed with clear water and thoroughly dried.
- C. Protect against electrolysis where aluminum is to be used in conjunction with dissimilar metals.
- D. During construction, care shall be taken to prevent damage to the aluminum work from splashing or by the accumulation of paint, concrete, mortar, or other similar materials.

3.06 CLEANING ALUMINUM WORK

- A. After aluminum has been erected it shall be cleaned with mild soap and water followed by a clear water rinse.

END OF SECTION

SECTION 05530

METAL GRATING

PART 1 GENERAL

1.01 SUMMARY

A. Section Includes

1. Requirements for the fabrication and installation of metal gratings and appurtenances.

B. Related Sections

1. Section 05500 - Metal Fabrications.
2. Section 05510 - Aluminum Stairs and Ladders.

1.02 REFERENCES

A. American Society for Testing and Materials (ASTM)

1. A36, Specification for Carbon Structural Steel.
2. A123, Specification for Zinc (Hot-Dipped Galvanized) Coatings on Iron and Steel Products.
3. A153, Specification for Zinc Coating (Hot-Dip) on Iron and Steel Hardware.
4. A167, Specification for Stainless and Heat-Resisting Chromium-Nickel Steel Plate, Sheet, and Strip.
5. A307, Specification for Carbon Steel Bolts and Studs, 60,000 PSI Tensile Strength.
6. A568, Specification for Steel, Sheet, Carbon, and High-Strength, Low-Alloy, Hot-Rolled and Cold Rolled.
7. B221, Specification for Aluminum and Aluminum-Alloy Extruded Bars, Rods, Wire, Profiles, and Tubes.
8. F593, Specification for Stainless Steel Bolts, Hex Cap Screws and Studs.
9. F594, Specification for Stainless Steel Nuts.
10. F844, Specification for Washers, Steel, Plain (Flat), Unhardened for General Use.

B. American National Standards Institute/National Association of Architectural Metal Manufacturers (ANSI/NAAMM)

1. MBG 531, Metal Bar Grating Manual.
2. MBG 532, Heavy Duty Metal Bar Grating Manual.

1.03 SUBMITTALS

A. In accordance with Section 01300 submit the following:

1. Shop Drawings

- a. Grating: Show dimensions, weight, and size, and location of connections to adjacent grating, supports, and other work.
- b. Grating Anchorage: Show structural calculations and details of anchorage to supports to prevent displacement from traffic impact.
- c. Grating Supports: Show dimensions, weight, size, location, and anchorage to supporting structure.
- d. Catalog information and catalog cuts.
- e. Manufacturer's specifications, to include coatings.

B. Samples:

1. Two samples of aluminum grating approximately 4 inches by 8 inches, showing at least four crossbars each and four bearing bars each.
2. One sample will be retained at the site to be used as a basis for acceptance or rejection of grating installed.

C. Quality Control Submittals:

1. Special handling and storage requirements.
2. Installation instructions.
3. Factory test reports.
4. Manufacturer's Certification of Compliance for specified products.
5. Written Test Report that swaged crossbars, if used on grating, meet the requirements of the specified test and additional requirements of these Specifications.

1.04 PREPARATION FOR SHIPMENT

- A. Insofar as is practical, factory assemble items provided.
- B. Package and clearly tag parts and assemblies that are of necessity shipped unassembled and protect the materials from damage, and facilitate identification and final assembly in the field.

PART 2 PRODUCTS

2.01 FOOT TRAFFIC GRATING

A. Design:

1. Uniform Service Load: 200 psf minimum uniform load and 300 pound minimum concentrated load, unless otherwise shown.
2. Maximum Deflection: 1/4 inch, unless otherwise shown.
3. Space bearing bars at 1-3/16-inch center-to-center.
4. Banding: 3/16-inch minimum.

B. Material:

1. Aluminum Bar Type Grating:
 - a. Press-locked rectangular design, as manufactured by IKG/Borden, Clark, NJ; IKG/Borden Type B or Type F.
 - b. Swage locked aluminum grating, rectangular bar type, as manufactured by:
 - 1) IKG/Borden, Clark, NJ; IKG/Borden Type BS or Type FS.
 - 2) Seidelhuber Metal Products, Inc., San Carlos, CA; Type A-2.
 - 3) Ohio Gratings, Inc., Canton, OH; Aluminum Flush Top, Type 19SGF2.
2. Stair Treads:
 - a. In accordance with this SECTION and the applicable requirements of SECTION 05510.

2.02 LIGHT VEHICULAR TRAFFIC GRATING

A. Design:

1. Maximum Load: 2,000 pounds per wheel, minimum wheel base and axle width of 4 feet 0 inch.
2. Space main bars at 1-3/16-inch center-to-center.
3. Banding: 1/4 inch.

B. Material:

1. Aluminum Bar Type Grating: Press-locked deep rectangular crossbar designed as manufactured by IKG/Borden, Clark, NJ, IKG/Borden; Type B or Type F.
2. Galvanized Steel Bar Type Grating:
 - a. After Fabrication: ASTM A123, zinc coating.
 - b. Manufacturer and Product: IKG/Borden, Clark, NJ; IKG/Borden heavy-weld Type HWF or Type HWB or press-locked, rectangular crossbar, Type FJ or BJ.

2.03 HEAVY VEHICULAR TRAFFIC GRATING

A. Design:

1. Loading: AASHTO HS 20-44.
2. Banding: 1/4 inch.

B. Material:

1. Galvanized Steel Bar Type:
 - a. Heavy-duty, main bars spaced at 1-7/8-inch maximum center-to-center.
 - b. After Fabrication: ASTM A123, zinc coating.
 - c. Manufacturer and Product: IKG/Borden, Clark, NJ; KG/Borden heavy-weld Type HWF or HWB or press-locked, rectangular crossbar, Type BJ or FJ.

2.04 ACCESSORIES

A. Anchor Bolts and Nuts:

1. Carbon Steel: ASTM A307 or A36.
2. Stainless Steel: ASTM F593 and ASTM F594, Type 316.
3. Galvanized Steel Bolts and Nuts: ASTM A153, zinc coating for ASTM A307 or A36.

B. Flat Washers

1. Carbon Steel: (Unhardened): ASTM F844; use ASTM A153 for zinc coating.
2. Stainless Steel: see SECTION 05500.

C. Removable Fastener Clips and Bolts:

1. Removable from above grating walkway surface.
2. Hat Bracket: Type 304 stainless steel.
3. Bolt: type 316 stainless steel.
4. Cast iron, galvanized body.
5. Manufacturer and Product: Struct-Fast, Wellesley Hills, MA; Gratefast.

D. Partially Removable Anchor:

1. Bolt: Threaded stud, Type 316 stainless steel.
 - a. Manufacturer: Nelson Stud Welding Co., Lorain, OH.
2. Hat Bracket: Type 304 stainless steel.
 - a. Manufacturer:
 - 1) Struct-Fast, Wellesley Hills, MA.
 - 2) Or equal.

2.05 FABRICATION

A. General:

1. Exposed Surfaces: Smooth finish and sharp, well-defined lines.
2. Furnish necessary rabbets, lugs, and brackets so work can be assembled in a neat, substantial manner.
3. Conceal fastenings where practical.

4. Drill metalwork and countersink holes as required for attaching hardware or other materials.
 5. Weld Connections: Not permitted on grating except at banding bars.
- B. Design:
1. Field measure areas to receive grating, verify dimensions of new fabricated supports, and fabricate to dimension required for specified clearances.
 2. Section Length: Sufficient to prevent its falling down through clear opening when oriented in the span direction when one end is touching either the concrete or the vertical leg of grating support.
 3. Minimum Bearing: ANSI/NAAMM MBG 531.
 4. Metal Crossbar Spacing: 4-inch maximum, unless otherwise shown or specified.
 5. Crossbars: Flush with top of main bar and extend downward a minimum of 50 percent of the main bar depth.
 - a. Swaged Crossbars:
 - 1) Within 1/4 inch of top of grating with 1/2-inch minimum vertical dimension after swaging, and minimum before swaging dimension of 5/16-inch square.
 - 2) Crossbar Dimension After Swaging: Minimum 1/8-inch wider than the opening at minimum of two corners at each side of each square opening in main bar.
 - 3) Crossbars may be a special extruded shape so that after swaging the top will be flat, 3/16 inches wide and will be flush with the top surface of the bearing bars for a minimum of 5/8 inches at center between bearing bars.
 - 4) Flush crossbar meeting all of the above except that after swaging shall overlap one corner by a minimum of 1/8 inch. A sample of one bearing bar and one crossbar shall be tested by holding the bearing bar and pulling on the crossbar. The crossbar to bearing bar shall sustain a minimum of 300 pounds without pullout of the bearing bar.
 - 5) Tightly fit main bars and crossbars allowing no differential movement.
 6. Do not use weld type crossbars.
 7. Banding: Same material as grating: ANSI/NAAMM MBG 531 and ANSI/NAAMM MBG 532.
 8. Furnish stainless steel Type 316 threaded anchor studs, as fasteners for grating attachment to metal supports either not embedded or partially embedded in concrete, as manufactured by Nelson Studs Welding Co., Loraine, OH.
- C. Supports:
1. Seat angles and beams where shown:
 - a. Same material as rectangular bar grating.
 - b. Extruded aluminum frame with slot for recessed grating clips, as manufactured by Thompson Fabricating Co., for aluminum I-Bar type grating.
 2. Coordinate dimensions and fabrication with grating to be supported.
 3. Coordinate dimensions with increased depth due to serrations.
 4. Welded Frames With Anchors: Continuously welded.
- D. Slip-Resistant Surface:
1. Rectangular Steel and Aluminum Bar Grating (as noted): As manufactured by:
 - a. IKG/Borden, Clark NJ; EZ Weldslip-Resistant Coating.
 - b. Seidelhuber Metal Products, Inc., Hayward, CA; Safety Grit Non-Slip System.
 - c. Ohio Gratings, Inc., Canton, OH with "Slip-Not" Safety Surface manufactured by W.S. Molnar Co., Detroit, MI.
 2. I-Bar grating aluminum shall incorporate a striated anti-skid walking surface produced during the extrusion process, as manufactured by:
 - a. IKG/Borden, Clark, NJ.

- b. Seidelhuber Metal Products, Inc., Hayward, CA.
- c. Klemp Corp., Chicago, IL.

E. Aluminum:

- 1. ASTM B221 extruded shapes.
- 2. Fabricate as shown and in accordance with manufacturer's recommendations.
- 3. Grind smooth sheared edges exposed in the finished work.
- 4. Swage crossbars, if used, with equipment strong enough to deform crossbars.
- 5. Eliminate any loose crossbar intersections on swaged grating.

- F. Foot Traffic Grating: Any single grating section, individual plank, or plank assembly shall be not less than 1 foot 6 inches or greater than 3 feet 0 inch in width or weigh more than 150 pounds.

EXECUTION

2.06 PREPARATION

A. Electrolytic Protection:

- 1. Aluminum surfaces in contact with dissimilar metals, other than stainless steel, and embedded or in contact with masonry, grout, and concrete, to be protected by a coat of Bitumastic Super Service Black manufactured by KOP-COAT, Inc., Pittsburgh, PA; 46-465 Heavy Themecol manufactured by Tnemec Company, North Kansas City, MO; or an acceptable equivalent product.

2.07 INSTALLATION

- A. Install supports such that grating sections have a solid bearing on both ends, and that rock and wobble grating movement does not occur under designed traffic loading.
- B. Install plumb or level as applicable.
- C. Install welded frames with anchors to straight plan without offsets.
- D. Anchor grating securely to supports using minimum of four fasteners clips and bolts per grating section.
- E. Use stainless steel anchors and accessories with aluminum gratings.
- F. Completed installation shall be rigid and neat in appearance.
- G. Commercially Manufactured Products:
 - 1. Install in accordance with manufacturer's recommendations.
 - 2. Secure grating to support members with fasteners.
 - 3. Welding is not permitted.
 - 4. Fasteners: Field locate and install.
 - 5. Permit each grating section or plank style grating assembly to be easily removed and replaced.
- H. Protect painted surfaces during installation.
- I. Should coating become marred, prepare and touch up surface in accordance with paint manufacturer's instructions.

END OF SECTION

(THIS PAGE INTENTIONALLY LEFT BLANK)

DIVISION 06

(THIS PAGE INTENTIONALLY LEFT BLANK)

SECTION 06100

ROUGH CARPENTRY

PART 1 - GENERAL

1.01 GENERAL PROVISIONS

- A. Attention is directed to the CONTRACT AND GENERAL CONDITIONS and all Sections within DIVISION 01 - GENERAL REQUIREMENTS which are hereby made a part of this Section of the Specifications.

1.02 DESCRIPTION OF WORK

- A. Work Included: Provide labor, materials and equipment necessary to complete the work of this Section, including but not limited to the following:
 - 1. Wood blocking, cants, and nailers.
- B. Related Work: The following items are not included in this Section and are specified under the designated Sections:
 - 1. Section 06402 - INTERIOR ARCHITECTURAL WOODWORK for interior woodwork not specified in this Section.
 - 2. Section 09211 - GYPSUM BOARD ASSEMBLIES for sheet metal backing.

1.03 SUBMITTALS

- A. Product Data: For each type of process and factory-fabricated product. Indicate component materials and dimensions and include construction and application details.
 - 1. Include data for wood-preservative treatment from chemical treatment manufacturer and certification by treating plant that treated materials comply with requirements. Indicate type of preservative used, net amount of preservative retained, and chemical treatment manufacturer's written instructions for handling, storing, installing, and finishing treated material.
 - 2. Include data for fire-retardant treatment from chemical treatment manufacturer and certification by treating plant that treated materials comply with requirements. Include physical properties of treated materials, both before and after exposure to elevated temperatures when tested according to ASTM D 5516 and ASTM D 5664.
 - 3. For products receiving a waterborne treatment, include statement that moisture content of treated materials was reduced to levels specified before shipment to Project site.
 - 4. Include copies of warranties from chemical treatment manufacturers for each type of treatment.

1.04 QUALITY ASSURANCE

- A. Testing Agency Qualifications: For testing agency providing classification marking for fire-retardant treated material, an inspection agency acceptable to authorities having jurisdiction that periodically performs inspections to verify that the material bearing the classification marking is representative of the material tested.

1.05 DELIVERY, STORAGE, AND HANDLING

- A. Stack lumber; place spacers between each bundle to provide air circulation. Provide for air circulation around stacks and under coverings.

PART 2 - PRODUCTS

2.01 WOOD PRODUCTS, GENERAL

- A. Lumber: DOC PS 20 and applicable rules of lumber grading agencies certified by the American Lumber Standards Committee Board of Review.
 - 1. Factory mark each piece of lumber with grade stamp of grading agency.
 - 2. Where nominal sizes are indicated, provide actual sizes required by DOC PS 20 for moisture content specified. Where actual sizes are indicated, they are minimum dressed sizes for dry lumber.
 - 3. Provide dressed lumber, S4S, unless otherwise indicated.
 - 4. Provide dry lumber with 15 percent maximum moisture content at time of dressing for 2-inch nominal thickness or less, unless otherwise indicated.

2.02 WOOD-PRESERVATIVE-TREATED MATERIALS

- A. Preservative Treatment by Pressure Process: AWPA U1; Use Category UC2 for interior construction not in contact with the ground, Use Category UC3b for exterior construction not in contact with the ground, and Use Category UC4a for items in contact with the ground.
 - 1. Preservative Chemicals: Acceptable to authorities having jurisdiction and containing no arsenic or chromium. Do not use inorganic boron (SBX) for sill plates.
 - 2. For exposed items indicated to receive a stained or natural finish, use chemical formulations that do not require incising, contain colorants, bleed through, or otherwise adversely affect finishes.
- B. Kiln-dry material after treatment to a maximum moisture content of 19 percent for lumber. Do not use material that is warped or does not comply with requirements for untreated material.
- C. Mark each treated item with the treatment quality mark of an inspection agency approved by the American Lumber Standards Committee Board of Review.

D. Application: Treat items indicated on Drawings, and the following:

1. Wood cants, nailers, curbs, equipment support bases, blocking, stripping, and similar members in connection with roofing, flashing, vapor barriers, and waterproofing.
2. Wood sills, sleepers, blocking, furring, stripping, and similar concealed members in contact with masonry or concrete in exterior walls.

2.03 FIRE-RETARDANT-TREATED MATERIALS

A. General: For all interior use materials, provide materials that are fire-retardant treated and comply with performance requirements in AWPAC20 (lumber). Identify fire-retardant-treated wood with appropriate classification marking of UL, U.S. Testing, Timber Products Inspection, or another testing and inspecting agency acceptable to authorities having jurisdiction.

1. Use treatment for which chemical manufacturer publishes physical properties of treated wood after exposure to elevated temperatures, when tested by a qualified independent testing agency according to ASTM D 5664, for lumber.
2. Use treatment that does not promote corrosion of metal fasteners.

2.04 MISCELLANEOUS LUMBER

A. General: Provide lumber for support or attachment of other construction, including the following:

1. Rooftop equipment bases and support curbs, blocking, cants, nailers, furring and grounds.

B. For items of dimension lumber size, provide Construction, Stud, or No. 2 grade lumber with 15 percent moisture content.

2.05 FASTENERS

A. General: Provide fasteners of size and type indicated that comply with requirements specified in this Article for material and manufacture.

1. Where carpentry is exposed to weather, in ground contact, pressure-preservative treated, or in area of high relative humidity, provide fasteners of Type 304 stainless steel.

B. Nails, Wire, Brads, and Staples: FS FF-N-105.

C. Power-Driven Fasteners: CABO NER-272.

D. Wood Screws: ASME B18.6.1.

- E. Screws for Fastening to Cold-Formed Metal Framing: ASTM C 954, except with wafer heads and reamer wings, length as recommended by screw manufacturer for material being fastened.
- F. Bolts: Steel bolts complying with ASTM A 307, Grade A with ASTM A 563 hex nuts and, where indicated, flat washers.
- G. Expansion Anchors: Anchor bolt and sleeve assembly of material indicated below with capability to sustain, without failure, a load equal to 6 times the load imposed when installed in unit masonry assemblies and equal to 4 times the load imposed when installed in concrete as determined by testing per ASTM E 488 conducted by a qualified independent testing and inspecting agency.
 - 1. Material: Carbon-steel components, zinc plated to comply with ASTM B 633, Class Fe/Zn 5; except provide Type 304 stainless steel where in contact with pressure-preservative treated wood.

2.06 MISCELLANEOUS MATERIALS

- A. Adhesive, Including Gluing Furring and Sleepers to Concrete or Masonry: Formulation complying with ASTM D 3498 that is approved for use indicated by adhesive manufacturer.
 - 1. Use adhesives that have a VOC content of 70 g/L or less when calculated according to 40 CFR 59, Subpart D (EPA Method 24).

PART 3 - EXECUTION

3.01 INSTALLATION, GENERAL

- A. Discard units of material with defects that impair quality of carpentry and that are too small to use with minimum number of joints or optimum joint arrangement.
- B. Set carpentry to required levels and lines, with members plumb, true to line, cut, and fitted. Fit carpentry to other construction; scribe and cope as needed for accurate fit. Locate furring, nailers, blocking, grounds, and similar supports to comply with requirements for attaching other construction.
- C. Apply field treatment complying with AWWA M4 to cut surfaces of preservative-treated lumber.
- D. Securely attach carpentry work as indicated and according to applicable codes and recognized standards.
- E. Countersink fastener heads on exposed carpentry work and fill holes with wood filler.

- F. Use fasteners of appropriate type and length. Pre-drill members when necessary to avoid splitting wood.

3.02 WOOD BLOCKING, AND NAILER INSTALLATION

- A. Install where indicated and where required for attaching other work. Form to shapes indicated and cut as required for true line and level of attached work. Coordinate locations with other work involved.
- B. Attach items to substrates to support applied loading. Recess bolts and nuts flush with surfaces, unless otherwise indicated.

END OF SECTION

(THIS PAGE INTENTIONALLY LEFT BLANK)

SECTION 06402

INTERIOR ARCHITECTURAL WOODWORK

PART 1 - GENERAL

1.01 GENERAL PROVISIONS

- A. Attention is directed to the CONTRACT AND GENERAL CONDITIONS and all Sections within DIVISION 01 - GENERAL REQUIREMENTS which are hereby made a part of this Section of the Specifications.

1.02 DESCRIPTION OF WORK

- A. Work Included: Provide labor, materials and equipment necessary to complete the work of this Section, including but not limited to the following:
 - 1. Plastic-laminate window sills.
 - 2. Paint grade trim and casings at windows, including paint grade wood jamb extensions at windows.
- B. Related Work: The following items are not included in this Section and are specified under the designated Sections:
 - 1. Section 06100 - ROUGH CARPENTRY for wood furring, blocking, shims, and hanging strips required for installing woodwork and concealed within other construction before woodwork installation.
 - 2. Section 09900 - PAINTING for field applied finishes on wood.

1.03 SUBMITTALS

- A. Product Data: For each type of product specified.
- B. Shop Drawings: Show location of each item, dimensioned plans and elevations, large-scale details, attachment devices, and other components.
 - 1. Show locations and sizes of furring, blocking, and hanging strips, including concealed blocking and reinforcement specified in other Sections.
 - 2. Show locations and sizes of cutouts and holes for plumbing fixtures, electrical components and other items installed in architectural woodwork.
- C. Samples for Verification:
 - 1. Plastic Laminates, 8 by 10 inches for each type and color.

1.04 QUALITY ASSURANCE

- A. Fabricator Qualifications: Shop that employs skilled workers who custom-fabricate products similar to those required for this Project and whose products have a record of successful in-service performance.
- B. Quality Standard: Unless otherwise indicated, comply with AWI/AWMAC/WI's "Architectural Woodwork Standards," latest edition, including errata, for grades of interior architectural woodwork indicated for construction, finishes, installation, and other requirements.
- C. Preinstallation Conference: Conduct conference at Project site to comply with requirements in Division 01.

1.05 DELIVERY, STORAGE, AND HANDLING

- A. Do not deliver woodwork until painting and similar operations that could damage woodwork have been completed in installation areas. If woodwork must be stored in other than installation areas, store only in areas where environmental conditions comply with requirements specified in "Project Conditions" Article.

1.06 PROJECT CONDITIONS

- A. Environmental Limitations: Do not deliver or install woodwork until building is enclosed, wet work is complete, and HVAC system is operating and maintaining temperature and relative humidity at occupancy levels during the remainder of the construction period.
 - 1. The HVAC systems as specified elsewhere may not provide for humidity controls. The expected ranges of relative humidity are expected to be as high as 55% to a low of uncontrolled during the heating system. Comply with AWS Section 2, Care and Storage.
- B. Field Measurements: Where woodwork is indicated to fit to other construction, verify dimensions of other construction by field measurements before fabrication, and indicate measurements on Shop Drawings. Coordinate fabrication schedule with construction progress to avoid delaying the Work.

1.07 COORDINATION

- A. Coordinate sizes and locations of framing, blocking, furring, reinforcements, and other related units of Work specified in other Sections to ensure that interior architectural woodwork can be supported and installed as indicated.

PART 2 - PRODUCTS

2.01 PLASTIC-LAMINATE WINDOW STOOLS

- A. Grade: Custom.
- B. High-Pressure Decorative Laminate Grade: HGS.
- C. Colors, Patterns, and Finishes: Provide materials and products that result in colors and textures of exposed laminate surfaces complying with the following requirements:
 - 1. As selected by Engineer from manufacturer's full range.
- D. Edge Treatment: As indicated.
- E. Core Material: Exterior-grade plywood.

2.02 INTERIOR FRAMES AND JAMBS FOR OPAQUE FINISH

- A. Grade: Custom.
- B. Wood Species: Any closed-grain hardwood.
- C. Shop Priming: Shop apply the prime coat including backpriming, if any, for opaque-finished items specified to be field finished. Refer to Section 099000 - PAINTING AND COATING for material and application requirements.

2.03 MATERIALS

- A. General: Provide materials that comply with requirements of AWI/AWMAC/WI's "Architectural Woodwork Standards" for each type of woodwork and quality grade specified, unless otherwise indicated.
- B. Wood Species for Opaque Finish: Any closed-grain hardwood.
- C. High-Pressure Decorative Laminate: NEMA LD 3, grades as indicated or, if not indicated, as required by woodwork quality standard.
 - 1. Available Manufacturers: Subject to compliance with requirements, manufacturers offering high-pressure decorative laminates that may be incorporated into the Work include, but are not limited to, the following:
 - a. Arborite; Division of ITW Canada, Inc.
 - b. Formica Corporation.
 - c. Lamin-Art, Inc.
 - d. Nevamar Company; a division of Panolam Industries.
 - e. Wilsonart International; Div. of Premark International, Inc.

2.04 MISCELLANEOUS MATERIALS

- A. Furring, Blocking, Shims, and Hanging Strips: Fire-retardant-treated softwood lumber, kiln dried to less than 15 percent moisture content.
- B. Anchors: Select material, type, size, and finish required for each substrate for secure anchorage. Provide nonferrous-metal or hot-dip galvanized anchors and inserts on inside face of exterior walls and elsewhere as required for corrosion resistance. Provide toothed-steel or lead expansion sleeves for drilled-in-place anchors.
- C. Adhesives, General: Do not use adhesives that contain urea formaldehyde.

2.05 FABRICATION, GENERAL

- A. Wood Moisture Content: Comply with requirements of referenced quality standard for wood moisture content in relation to ambient relative humidity during fabrication and in installation areas.
- B. Fabricate woodwork to dimensions, profiles, and details indicated. Ease edges to radius indicated for the following:

PART 3 - EXECUTION

3.01 PREPARATION

- A. Before installation, condition woodwork to average prevailing humidity conditions in installation areas.
- B. Before installing architectural woodwork, examine shop-fabricated work for completion and complete work as required, including removal of packing and backpriming.

3.02 INSTALLATION

- A. Grade: Install woodwork to comply with requirements for the same grade specified in Part 2 for fabrication of type of woodwork involved.
- B. Assemble woodwork and complete fabrication at Project site to comply with requirements for fabrication in Part 2, to extent that it was not completed in the shop.
- C. Install woodwork level, plumb, true, and straight. Shim as required with concealed shims. Install level and plumb (including tops) to a tolerance of 1/8 inch in 96 inches.
- D. Scribe and cut woodwork to fit adjoining work, refinish cut surfaces, and repair damaged finish at cuts.
- E. Anchor woodwork to anchors or blocking built in or directly attached to substrates. Secure with countersunk, concealed fasteners and blind nailing as required for complete installation. Use fine finishing nails or finishing screws for exposed fastening,

countersunk and filled flush with woodwork and matching final finish if transparent finish is indicated.

- F. Window Stools: Anchor securely by screwing to supports. Calk space between backsplash and wall with sealant specified in Section 07920 - JOINT SEALANTS.
- G. Touch up finishing work specified in this Section after installation of woodwork. Fill nail holes with matching filler where exposed.

3.03 ADJUSTING AND CLEANING

- A. Repair damaged and defective woodwork, where possible, to eliminate functional and visual defects; where not possible to repair, replace woodwork. Adjust joinery for uniform appearance.
- B. Clean woodwork on exposed and semiexposed surfaces. Touch up shop-applied finishes to restore damaged or soiled areas.

END OF SECTION

(THIS PAGE INTENTIONALLY LEFT BLANK)

DIVISION 07

(THIS PAGE INTENTIONALLY LEFT BLANK)

SECTION 07130
WATERPROOFING

PART 1 - GENERAL

1.1 GENERAL PROVISIONS

- A. Attention is directed to the CONTRACT AND GENERAL CONDITIONS and all Sections within DIVISION 01 - GENERAL REQUIREMENTS which are hereby made a part of this Section of the Specifications.

1.2 DESCRIPTION OF WORK

- A. Work Included: Provide labor, materials and equipment necessary to complete the work of this Section, including but not limited to the following:
 - 1. Liquid waterproofing on all interior concrete surfaces of wet well.
- B. Related Work: The following items are not included in this Section and are specified under the designated Sections:
 - 1. Section 07920 - JOINT SEALANTS for joint-sealant materials and installation.

1.3 SUBMITTALS

- A. Product Data: Include manufacturer's written instructions for evaluating, preparing, and treating substrate, technical data, and tested physical and performance properties of waterproofing.
- B. Shop Drawings: Show locations and extent of waterproofing. Include details for substrate joints and cracks, sheet flashings, penetrations, inside and outside corners, tie-ins with adjoining waterproofing, and other termination conditions.
- C. Samples: For each product.
- D. Installer Certificates: Signed by manufacturers certifying that installers comply with requirements.
- E. Sample Warranty: Copy of special waterproofing manufacturer's and Installer's warranty stating obligations, remedies, limitations, and exclusions before starting waterproofing.

1.4 QUALITY ASSURANCE

- A. Installer Qualifications: A qualified installer who is acceptable to waterproofing manufacturer to install manufacturer's products.

- B. Source Limitations: Obtain waterproofing materials, protection course, and molded-sheet drainage panels through one source from a single manufacturer.
- C. Preinstallation Conference: Conduct conference at Project site to comply with requirements in Division 01. Review requirements for waterproofing, including surface preparation specified under other Sections, substrate condition and pretreatment, minimum curing period, forecasted weather conditions, special details and sheet flashings, installation procedures, testing and inspection procedures, and protection and repairs.

1.5 DELIVERY, STORAGE, AND HANDLING

- A. Deliver liquid materials to Project site in original packages with seals unbroken, labeled with manufacturer's name, product brand name and type, date of manufacture, and directions for storing and mixing with other components.
- B. Store liquid materials in their original undamaged packages in a clean, dry, protected location and within temperature range required by waterproofing manufacturer.
- C. Remove and replace liquid materials that cannot be applied within their stated shelf life.
- D. Store rolls according to manufacturer's written instructions.
- E. Protect stored materials from direct sunlight.

1.6 PROJECT CONDITIONS

- A. Environmental Limitations: Apply waterproofing within the range of ambient and substrate temperatures recommended by waterproofing manufacturer. Do not apply waterproofing to a damp or wet substrate.
 - 1. Do not apply waterproofing in snow, rain, fog, or mist.
- B. Maintain adequate ventilation during preparation and application of waterproofing materials.

1.7 WARRANTY

- A. Special Manufacturer's Warranty: Written warranty, signed by waterproofing manufacturer agreeing to replace waterproofing material that does not comply with requirements or that does not remain watertight during specified warranty period.
 - 1. Warranty does not include failure of waterproofing due to failure of substrate not prepared and treated according to requirements or formation of new joints and cracks in substrate exceeding 1/16 inch in width.
 - 2. Warranty Period: Five years after date of Substantial Completion.
 - 3. Warranty includes removing and reinstalling protection board, drainage panels, insulation.

PART 2 - PRODUCTS

2.1 MANUFACTURERS

- A. Available Products: Subject to compliance with requirements, products that may be incorporated into the Work include, but are not limited to, the following:
 - 1. Liquid Waterproofing (At All Wet Well Interior Concrete Surfaces): Sikagard 7600 made by Sika Corporation, Lynhurst, NJ, Gaco Western GacoFlex LM60 acid-resistant or equal.

2.2 AUXILIARY MATERIALS

- A. General: Furnish auxiliary materials recommended by waterproofing manufacturer for intended use and compatible with sheet waterproofing.
 - 1. Furnish liquid-type auxiliary materials that comply with VOC limits of authorities having jurisdiction.
- B. Primer: Liquid primer recommended for substrate by manufacturer of sheet waterproofing material.
- C. Surface Conditioner: Liquid, waterborne surface conditioner recommended for substrate by manufacturer of waterproofing material.
- D. Liquid Membrane: Elastomeric, two-component liquid, cold fluid applied, trowel grade or low viscosity.
- E. Substrate Patching Membrane: Low-viscosity, two-component, asphalt-modified coating.

PART 3 - EXECUTION

3.1 EXAMINATION

- A. Examine substrates, areas, and conditions, with Installer present, for compliance with requirements and other conditions affecting performance.
 - 1. Verify that concrete has cured and aged for minimum time period recommended by waterproofing manufacturer.
 - 2. Verify that concrete is visibly dry and free of moisture. Test for capillary moisture by plastic sheet method according to ASTM D 4263.
 - 3. Proceed with installation only after unsatisfactory conditions have been corrected.

3.2 SURFACE PREPARATION

- A. Clean, prepare, and treat substrates according to manufacturer's written instructions. Provide clean, dust-free, and dry substrates for waterproofing application.

- B. Mask off adjoining surfaces not receiving waterproofing to prevent spillage and overspray affecting other construction.
- C. Remove grease, oil, bitumen, form-release agents, paints, curing compounds, and other penetrating contaminants or film-forming coatings from concrete.
- D. Remove fins, ridges, mortar, and other projections and fill honeycomb, aggregate pockets, holes, and other voids.
- E. Prepare, fill, prime, and treat joints and cracks in substrates. Remove dust and dirt from joints and cracks according to ASTM D 4258.

3.3 LIQUID WATERPROOFING

- A. Preparation of the surface shall be completed in accordance with the interior coating manufacturer's specifications.
- B. A primer coat shall be applied to interior surface of wet well and influent chamber in accordance with the interior coating manufacturer's specifications.
- C. Two coats of the membrane shall be applied in accordance with the interior coating manufacturer's specifications. Minimum total membrane thickness of 60 dry mils shall be provided.

3.4 PROTECTION AND CLEANING

- A. Do not permit foot or vehicular traffic on unprotected membrane.
- B. Protect waterproofing from damage and wear during remainder of construction period.
- C. Protect installed insulation from damage due to ultraviolet light, harmful weather exposures, physical abuse, and other causes. Provide temporary coverings where insulation will be subject to abuse and cannot be concealed and protected by permanent construction immediately after installation.
- D. Clean spillage and soiling from adjacent construction using cleaning agents and procedures recommended by manufacturer of affected construction.

END OF SECTION

SECTION 07180

TRAFFIC COATINGS

(Part of Work of Section 07001 - WATERPROOFING, DAMPPROOFING AND CAULKING,
Filed Sub-Bid Required)

PART 1 - GENERAL

1.01 GENERAL PROVISIONS

- A. Attention is directed to the CONTRACT AND GENERAL CONDITIONS and all Sections within DIVISION 01 - GENERAL REQUIREMENTS, which are hereby made a part of this Section of the Specifications.

1.02 DESCRIPTION OF WORK

- A. Work Included: Provide labor, materials and equipment necessary to complete the work of this Section, including but not limited to the following:
 - 1. Traffic coatings at horizontal surfaces that are walkable surfaces.
- B. Related Work: The following items are not included in this Section and are specified under the designated Sections:
 - 1. Section 03300 - CAST-IN-PLACE CONCRETE for concrete substrates.
 - 2. Section 07920 - JOINT SEALANTS for joint sealants in surfaces to receive traffic coatings.

1.03 SUBMITTALS

- A. Product Data: For each product indicated.
- B. Shop Drawings: Show extent of each traffic coating. Include details for treating substrate joints and cracks, flashings, deck penetrations, and other termination conditions.
- C. Samples for Verification: For each type of traffic coating required, prepared on rigid backing and of same thickness and material indicated for the Work.
 - 1. Provide stepped Samples on backing large enough to illustrate buildup of traffic coatings.
- D. Qualification Data: For Installer.
- E. Material Certificates: For each traffic coating, signed by manufacturers.

- F. Field quality-control test reports.
- G. Maintenance Data: For traffic coatings to include in maintenance manuals. Identify substrates and types of traffic coatings applied. Include recommendations for periodic inspections, cleaning, care, maintenance, and repair of traffic coatings.
- H. Warranty: Special warranty specified in this Section.

1.04 QUALITY ASSURANCE

- A. Installer Qualifications: Manufacturer's authorized representative who is trained and approved for installation of traffic coatings required for this Project.
- B. Source Limitations:
 - 1. Obtain traffic coatings from a single manufacturer.
 - 2. Obtain primary traffic coating materials, including primers, from traffic coating manufacturer. Obtain secondary materials including aggregates, sheet flashings, joint sealants, and substrate repair materials of type and from source recommended in writing by primary material manufacturer.
- C. Mockups: Apply mockups to set quality standards for materials and execution.
 - 1. Architect will select one representative surface for each traffic coating and each substrate to receive traffic coatings. Apply each coating to at least 200 sq. ft. of each substrate to demonstrate surface preparation, joint and crack treatment, thickness, texture, color, and standard of workmanship.
 - 2. Remove and reapply mockups until they are approved by Architect.
 - 3. Approved mockups may become part of the completed Work if undisturbed at time of Substantial Completion.
- D. Preinstallation Conference: Conduct conference at Project site to comply with requirements in Division 1. Review requirements for traffic coatings, including surface preparation specified under other Sections, substrate condition and pretreatment, minimum curing period, forecasted weather conditions, special details and flashings, installation procedures, testing and inspection procedures, and protection and repairs.
 - 1. Before installing traffic coatings, meet with representatives of authorities having jurisdiction, manufacturer's technical representative, Owner, Architect, consultants, independent testing agency, and other concerned entities. Review requirements for traffic coatings. Notify participants at least seven days before conference.

1.05 DELIVERY, STORAGE, AND HANDLING

- A. Deliver materials in original packages and containers with seals unbroken and bearing manufacturer's labels showing the following information:

1. Manufacturer's brand name, Type of material, Directions for storage, Date of manufacture and shelf life, Lot or batch number, Mixing and application instructions, Color.

- B. Store materials in a clean, dry location protected from exposure to direct sunlight. In storage areas, maintain environmental conditions within range recommended in writing by manufacturer.

1.06 PROJECT CONDITIONS

- A. Environmental Limitations: Apply traffic coatings within the range of ambient and substrate temperatures recommended in writing by manufacturer. Do not apply traffic coatings to damp or wet substrates, when temperatures are below 40 deg F, when relative humidity exceeds 85 percent, or when temperatures are less than 5 deg F above dew point.

1. Do not apply traffic coatings in snow, rain, fog, or mist, or when such weather conditions are imminent during the application and curing period. Apply only when frost-free conditions occur throughout the depth of substrate.

- B. Do not install traffic coating until items that will penetrate membrane have been installed.

1.07 WARRANTY

- A. Special Warranty: Manufacturer's standard form in which traffic coating manufacturer agrees to repair or replace traffic coatings that deteriorate during the specified warranty period.

1. Warranty does not include deterioration or failure of traffic coating due to unusual weather phenomena, failure of prepared and treated substrate, formation of new substrate cracks exceeding 1/16 inch in width, fire, vandalism, or abuse by snowplow, maintenance equipment, and truck traffic.

2. Deterioration of traffic coatings includes the following:

- a. Adhesive or cohesive failures.

- b. Abrasion or tearing failures.

- c. Surface crazing or spalling.

- d. Intrusion of water, oils, gasoline, grease, salt, deicer chemicals, or acids into deck substrate.

3. Warranty Period: Five years from date of Substantial Completion.

PART 2 - PRODUCTS

2.01 TRAFFIC COATING

- A. Available Products: Subject to compliance with requirements, products that may be incorporated into the Work include, but are not limited to, the following:
 - 1. AutoGard FC HD-48 or AutoGard E by Neogard.
 - 2. Vulkem 360NF/950NF and 951NF by Tremco.
 - 3. Sikalastic 720 Base and Sikalastic 748 PA Aliphatic by Sika Group.
- B. Primer: Manufacturer's standard factory-formulated primer recommended for substrate and conditions indicated.
- C. Preparatory and Base Coats: Single- or multicomponent, aromatic liquid urethane elastomer.
- D. Intermediate Coat: Single- or multicomponent, aliphatic or aromatic liquid urethane elastomer.
- E. Topcoat: Single- or multicomponent, aliphatic or aromatic liquid urethane elastomer.
 - 1. Color: As selected by Architect from manufacturer's full range.
- F. Component Coat Thicknesses: As recommended by manufacturer for substrate and service conditions indicated, but not less than the following (measured excluding aggregate):
 - 1. Base Coat: 25 mils minimum dry film thickness.
 - 2. Intermediate Coat: 15 mils minimum dry film thickness.
 - 3. Topcoat: 15 mils minimum dry film thickness.
- G. Aggregate: Uniformly graded, washed silicon carbide sand of particle sizes, shape, and minimum hardness recommended in writing by traffic coating manufacturer.
 - 1. Spreading Rate: As recommended by manufacturer for substrate and service conditions indicated.
- H. Traffic Coatings: Complying with ASTM C 957.
- I. Material Compatibility: Provide primers; base, intermediate, and topcoats; and miscellaneous materials that are compatible with one another and with substrate under conditions of service and application, as demonstrated by manufacturer based on testing and field experience.

2.02 MISCELLANEOUS MATERIALS

- A. Joint Sealants: As specified in Section 079200 - JOINT SEALANTS.

- B. Sheet Flashing: Nonstaining.
 - 1. Minimum Thickness: 60 mils.
 - 2. Material: Sheet material recommended in writing by traffic coating manufacturer.
- C. Adhesive: Contact adhesive recommended in writing by traffic coating manufacturer.
- D. Reinforcing Strip: Fiberglass mesh recommended in writing by traffic coating manufacturer.

PART 3 - EXECUTION

3.01 EXAMINATION

- A. Examine substrates, with Installer present, for compliance with requirements and for other conditions affecting performance of traffic coatings.
 - 1. For the record, prepare written report, endorsed by Installer, listing conditions detrimental to performance.
 - 2. Verify compatibility with and suitability of substrates.
 - 3. Begin coating application only after minimum concrete curing and drying period recommended by traffic coating manufacturer has passed, after unsatisfactory conditions have been corrected, and after surfaces are dry.
 - 4. Verify that substrates are visibly dry and free of moisture. Test for moisture vapor transmission by plastic sheet method according to ASTM D 4263.
 - 5. Application of coating indicates acceptance of surfaces and conditions.

3.02 PREPARATION

- A. Clean and prepare substrates according to ASTM C 1127 and manufacturer's written recommendations to produce clean, dust-free, dry substrate for traffic coating application.
- B. Mask adjoining surfaces not receiving traffic coatings, deck drains, and other deck substrate penetrations to prevent spillage, leaking, and migration of coatings.
- C. Concrete Substrates: Mechanically abrade concrete surfaces to a uniform profile according to ASTM D 4259. Do not acid etch.
 - 1. Remove grease, oil, paints, and other penetrating contaminants from concrete.
 - 2. Remove concrete fins, ridges, and other projections.
 - 3. Remove laitance, glaze, efflorescence, curing compounds, concrete hardeners, form-release agents, and other incompatible materials that might affect coating adhesion.
 - 4. Remove remaining loose material to provide a sound surface, and clean surfaces according to ASTM D 4258.

3.03 TERMINATIONS AND PENETRATIONS

- A. Prepare vertical and horizontal surfaces at terminations and penetrations through traffic coatings and at expansion joints, drains, and sleeves according to ASTM C 1127 and manufacturer's written recommendations.
- B. Provide sealant cants at penetrations and at reinforced and nonreinforced, deck-to-wall butt joints.
- C. Terminate edges of deck-to-deck expansion joints with preparatory base-coat strip.
- D. Install sheet flashings at deck-to-wall expansion and dynamic joints, and bond to deck and wall substrates according to manufacturer's written recommendations.

3.04 JOINT AND CRACK TREATMENT

- A. Prepare, treat, rout, and fill joints and cracks in substrates according to ASTM C 1127 and manufacturer's written recommendations. Before coating surfaces, remove dust and dirt from joints and cracks according to ASTM D 4258.
 - 1. Comply with recommendations in ASTM C 1193 for joint-sealant installation.

3.05 TRAFFIC COATING APPLICATION

- A. Apply traffic coating material according to ASTM C 1127 and manufacturer's written recommendations.
 - 1. Start traffic coating application in presence of manufacturer's technical representative.
 - 2. Verify that wet film thickness of each component coat complies with requirements every 100 sq. ft.
- B. Apply traffic coatings to prepared wall terminations and vertical surfaces to height indicated, and omit aggregate on vertical surfaces.
- C. Cure traffic coatings according to manufacturer's written recommendations. Prevent contamination and damage during application and curing stages.

3.06 FIELD QUALITY CONTROL

- A. Final Traffic Coating Inspection: Arrange for traffic coating manufacturer's technical personnel to inspect membrane installation on completion.
 - 1. Notify Architect and Owner 48 hours in advance of date and time of inspection.
- B. Additional testing and inspecting, at Contractor's expense, will be performed to determine compliance of replaced or additional work with specified requirements.

3.07 PROTECTING AND CLEANING

- A. Protect traffic coatings from damage and wear during remainder of construction period.
- B. Clean spillage from adjacent construction using cleaning agents and procedures recommended by manufacturer of affected construction.

END OF SECTION

(THIS PAGE INTENTIONALLY LEFT BLANK)

SECTION 07210
THERMAL INSULATION

PART 1 - GENERAL

1.01 GENERAL PROVISIONS

- A. Attention is directed to the CONTRACT AND GENERAL CONDITIONS and all Sections within DIVISION 01 - GENERAL REQUIREMENTS which are hereby made a part of this Section of the Specifications.

1.02 DESCRIPTION OF WORK

- A. Work Included: Provide labor, materials and equipment necessary to complete the work of this Section, including but not limited to the following:
1. Extruded polystyrene insulation for foundation walls.
 2. Mineral wool cavity wall insulation at masonry rainscreen and metal panels walls at clerestory at furred out stud walls and where indicated.
 3. Spray foam insulation at gaps.
- B. Related Work: The following items are not included in this Section and are specified under the designated Sections:
1. Section 07270 - AIR BARRIERS for air and vapor barrier membrane.
 2. Section 09211 - GYPSUM BOARD ASSEMBLIES for acoustic insulation in gypsum board assemblies.
 3. Section 07530 - SINGLE PLY MEMBRANE ROOFING for roof insulation.
 4. Division 15 - PLUMBING for plumbing insulation.
 5. Division 15 - HEATING, VENTILATING, AND AIR CONDITIONING for mechanical insulation.

1.03 SUBMITTALS

- A. Product Data: For each type of product indicated.

1.04 QUALITY ASSURANCE

- A. Source Limitations: Obtain each type of building insulation through one source from a single manufacturer.
- B. Surface-Burning Characteristics: As determined by testing identical products according to ASTM E 84 by a qualified testing agency. Identify products with appropriate markings of applicable testing agency.

1.05 DELIVERY, STORAGE, AND HANDLING

- A. Protect insulation materials from physical damage and from deterioration by moisture, soiling, and other sources. Store in a dry and secure location. Comply with manufacturer's written instructions for handling, storing, and protecting during installation.
- B. Protect plastic insulation as follows:
 - 1. Do not expose to sunlight, except to extent necessary for period of installation and concealment.
 - 2. Protect against ignition at all times. Do not deliver materials to Project site before installation time.
 - 3. Complete installation and concealment of materials as rapidly as possible in each area of construction.

PART 2 - PRODUCTS

2.01 EXTRUDED POLYSTYRENE INSULATION (Foundation Walls)

- A. Available Manufacturers: Subject to compliance with requirements, manufacturers offering products that may be incorporated into the Work include, but are not limited to, the following:
 - 1. DiversiFoam Products.
 - 2. Dow Chemical Company.
 - 3. Owens Corning.
- B. Board Insulation: Extruded-polystyrene board insulation complying with ASTM C 578, square edged of type, density, and compressive strength indicated below:
 - 1. For vertical applications, Type IV, 1.6-lb/cu. ft. minimum density and 25-psi minimum compressive strength.
- C. Adhesive for Bonding Insulation: Product with demonstrated capability to bond insulation securely to substrates indicated without damaging insulation and substrates.

2.02 CAVITY WALL INSULATION, MINERAL-WOOL BOARD (At Masonry Rainscreen)

- A. Available Manufacturers: Subject to compliance with requirements, manufacturers offering products that may be incorporated into the Work include, but are not limited to, the following:
 - 1. Roxul Inc.
 - 2. Fibrex Insulations Inc.
 - 3. Isolatek International.

4. Owens Corning.
 5. Thermafiber.
- B. Unfaced, Mineral-Wool Board Insulation: ASTM C 612, Type IVB; with maximum flame-spread and smoke-developed indexes of 15 and zero, respectively, per ASTM E 84; passing ASTM E 136 for combustion characteristics.
1. Nominal density of 4 lb/cu. ft. Types IA and IB, thermal resistivity of 4 deg F x h x sq. ft./Btu x in. at 75 deg F minimum.
 2. Fiber Color: Natural, except darkened where visible through joints in cladding.
 3. NFPA 285 Assembly Fire Propagation Characteristics Testing Results: Passing.
- C. Attachment to Substrate, Masonry Veneers: Manufacturer's recommended mechanical attachment clip or disk.
- D. Attachment to Substrate, Panel Veneers: Manufacturer's recommended adhesively attached, spindle-type insulation anchors.

2.03 SPRAYED-FOAM INSULATION AT GAPS

- A. Available Products: Subject to compliance with requirements, products that may be incorporated into the Work include, but are not limited to, the following:
1. Canam Building Envelope Specialists; Zerodraft Z1-24 Foam Sealant.
 2. Dow Chemical; GreatStuff Pro.
 3. Foam-Tech Div. of H.C. Fennell; SuperGreen Foam.
 4. Todol Products; Pur Fill 1G.
- B. Sprayed-Foam Insulation: Water-cure closed cell polyurethane containing no urea-formaldehyde and no CFCs.
1. Minimum density of 0.4 lb/cu. ft., thermal resistivity of 3.4 deg F x h x sq. ft./Btu x in. at 75 deg F.

PART 3 - EXECUTION

3.01 EXAMINATION

- A. Examine substrates and conditions, with Installer present, for compliance with requirements of Sections in which substrates and related work are specified and for other conditions affecting performance.
1. Proceed with installation only after unsatisfactory conditions have been corrected.

3.02 PREPARATION

- A. Clean substrates of substances harmful to insulation or vapor retarders, including removing projections capable of puncturing vapor retarders or of interfering with insulation attachment.

3.03 INSTALLATION, GENERAL

- A. Comply with insulation manufacturer's written instructions applicable to products and application indicated.
- B. Install insulation that is undamaged, dry, and unsoiled and that has not been left exposed at any time to ice, rain, and snow.
- C. Extend insulation in thickness indicated to envelop entire area to be insulated. Cut and fit tightly around obstructions and fill voids with insulation. Remove projections that interfere with placement.
- D. Miscellaneous Voids: Install spray polyurethane foam insulation in miscellaneous voids and cavity spaces where required to prevent gaps in insulation.

3.04 INSTALLATION OF BELOW-GRADE INSULATION

- A. On vertical surfaces, set rigid insulation units in adhesive applied according to manufacturer's written instructions. Use adhesive recommended by insulation manufacturer.
 - 1. If not otherwise indicated, extend insulation a minimum of 60 inches below exterior grade line.
- B. On horizontal surfaces, loosely lay rigid insulation units according to manufacturer's written instructions. Stagger end joints and tightly abut insulation units.

3.05 INSTALLATION OF CAVITY-WALL INSULATION

- A. Install mineral wool board cavity insulation per manufacturer's instructions. Fit insulation with edges butted tightly in both directions. Do not compress insulation. Maintain cavity width of dimension indicated between insulation and cladding material.
 - 1. Masonry Veneers: Secure with clips installed over masonry anchors. Provide at least 6 clips per mineral wool board.
 - 2. Panel Veneers: Secure with adhesively attached, spindle-type insulation anchors. Space anchors according to insulation manufacturer's written instructions.

3.06 FIELD QUALITY CONTROL

- A. Testing Agency: Engage a qualified independent testing and inspecting agency to perform field tests and inspections indicated below and prepare test reports.

- B. Infrared Camera Survey: Perform an infrared camera scan of walls, floors, and ceilings to determine where insulation and air barrier are not continuous, after insulation has been installed, but prior to plaster patching or new gypsum board installation.
 - 1. Provide complete digital report with images of test results with recommendations for repairs.
- C. Repair or replace work where test results and inspections indicate that it does not comply with specified requirements.
- D. Additional testing and inspecting, at Contractor's expense, will be performed to determine compliance of replaced or additional work with specified requirements.

3.07 PROTECTION

- A. Protect installed insulation and vapor retarders from damage due to harmful weather exposures, physical abuse, and other causes. Provide temporary coverings or enclosures where insulation is subject to abuse and cannot be concealed and protected by permanent construction immediately after installation.

END OF SECTION

(THIS PAGE INTENTIONALLY LEFT BLANK)

SECTION 07270

AIR BARRIERS

PART 1 - GENERAL

1.01 GENERAL PROVISIONS

- A. Attention is directed to the CONTRACT AND GENERAL CONDITIONS and all Sections within DIVISION 01 - GENERAL REQUIREMENTS, which are hereby made a part of this Section of the Specifications.

1.02 DESCRIPTION OF WORK

- A. Work Included: Provide labor, materials and equipment necessary to complete the work of this Section, including but not limited to the following:
 - 1. Self-adhering, vapor-retarding, modified bituminous sheet air barrier.
 - 2. Transition strips to adjacent and penetrating materials.
- B. Related Work: The following items are not included in this Section and are specified under the designated Sections:
 - 1. Section 04200 - REINFORCED UNIT MASONRY for masonry substrate.

1.03 DEFINITIONS

- A. Air Barrier Assembly: The collection of air barrier materials and auxiliary materials applied to an opaque wall or soffit, including joints and junctions to abutting construction, to control air movement through the wall.

1.04 PERFORMANCE REQUIREMENTS

- A. General: Air barrier shall be capable of performing as a continuous vapor-retarding air barrier and as a liquid-water drainage plane flashed to discharge to the exterior incidental condensation or water penetration. Air barrier assemblies shall be capable of accommodating substrate movement and of sealing substrate expansion and control joints, construction material changes, penetrations, and transitions at perimeter conditions without deterioration and air leakage exceeding specified limits.
- B. Air Barrier Assembly Air Leakage: Not to exceed 0.03 cfm/sq. ft. of surface area at 1.57 lbf/sq. ft., ASTM E 2357.

- C. Fire Test Performance: Passes NFPA 285, Standard Fire Test Method for Evaluation of Fire Propagation Characteristics of Exterior Non-Load-Bearing Wall Assemblies Containing Combustible Components.

1.05 PRECONSTRUCTION TESTING

- A. Mockup Testing: Air barrier assemblies shall comply with performance requirements indicated, as evidenced by reports based on mockup testing by a qualified testing agency.
 - 1. In addition to the Contractor testing as specified herein below in Part 3, the Owner may engage a qualified testing agency.
 - 2. Quantitative Air Leakage Testing: Testing of the mockup for air leakage will be conducted not to exceed the test pressure differential, positive and negative, indicated in "Performance Requirements" Article for air barrier assembly air leakage when tested according to ASTM E 783.
 - 3. Notify Engineer and the Owner a minimum of seven days in advance of the dates and times when mockup testing will take place.

1.06 SUBMITTALS

- A. Product Data: Include manufacturer's written instructions for evaluating, preparing, and treating substrate; technical data; and tested physical and performance properties of air barrier.
- B. Shop Drawings: Show locations and extent of air barrier. Include details for substrate joints and cracks, counterflashing strip, penetrations, inside and outside corners, terminations, and tie-ins with adjoining construction.
 - 1. Include details of interfaces with other materials that form part of air barrier.
 - 2. Include details of mockups.
- C. Product Certificates: For air barriers, certifying compatibility of air barrier and accessory materials with Project materials that connect to or that come in contact with air barrier; signed by product manufacturer.
- D. Air Barrier Certification: Submit manufacturer's certification that air barrier, as designed in the assemblies indicated on the Drawings, has been tested to meet the requirements of NFPA 285 and passed.
- E. Qualification Data: For Applicator.
- F. Product Test Reports: Based on evaluation of comprehensive tests performed by a qualified testing agency, for air barriers.

1.07 QUALITY ASSURANCE

- A. **Applicator Qualifications:** A firm experienced in applying air barrier materials similar in material, design, and extent to those indicated for this Project, whose work has resulted in applications with a record of successful in-service performance.
- B. **Mockups:** Before beginning installation of air barrier, build mockups of exterior wall assembly 150 sq. ft., incorporating backup wall construction, external cladding, window, door frame and sill, insulation, and flashing to demonstrate surface preparation, crack and joint treatment, and sealing of gaps, terminations, and penetrations of air barrier membrane.
 - 1. Coordinate construction of mockup to permit inspection by Owner's testing agency of air barrier before external insulation and cladding is installed.
 - 2. Include junction with roofing membrane, building corner condition, and foundation wall intersection.
 - 3. If the Engineer determines mockups do not comply with requirements, reconstruct mockups and apply air barrier until mockups are approved.
 - 4. Approved mockups may become part of the completed Work if undisturbed at time of Substantial Completion.
- C. **Preinstallation Conference:** Conduct conference at Project site.
 - 1. Include installers of other construction connecting to air barrier, such as roofing, waterproofing, architectural precast concrete, masonry, joint sealants, windows, glazed curtain walls, and door frames.
 - 2. Review air barrier requirements including surface preparation, substrate condition and pretreatment, minimum substrate curing period, forecasted weather conditions, special details and sheet flashings, mockups, installation procedures, sequence of installation, testing and inspecting procedures, and protection and repairs.

1.08 DELIVERY, STORAGE, AND HANDLING

- A. Store liquid materials in their original undamaged packages in a clean, dry, protected location and within temperature range required by air barrier manufacturer.
- B. Remove and replace liquid materials that cannot be applied within their stated shelf life.
- C. Store rolls according to manufacturer's written instructions.
- D. Protect stored materials from direct sunlight.

1.09 PROJECT CONDITIONS

- A. **Environmental Limitations:** Apply air barrier within the range of ambient and substrate temperatures recommended by air barrier manufacturer. Protect substrates from

environmental conditions that affect performance of air barrier. Do not apply air barrier to a damp or wet substrate or during snow, rain, fog, or mist.

PART 2 - PRODUCTS

2.01 SELF-ADHERING SHEET AIR BARRIER

- A. Sheet-Applied, Vapor-Retarding Modified Bituminous Sheet: 40-mil-thick, self-adhering sheet consisting of 36 mils of rubberized asphalt laminated to a 4-mil-thick, cross-laminated polyethylene film with release liner on adhesive side and formulated for application with primer that complies with VOC limits of authorities having jurisdiction.
1. Available Products: Subject to compliance with requirements, products that may be incorporated into the Work include, but are not limited to, the following:
 - a. Carlisle Coatings & Waterproofing; CCW-705.
 - b. Grace, W. R. & Co.; Perm-A-Barrier.
 - c. Henry Company; Blueskin SA.
 - d. Or approved equal.
 2. Physical and Performance Properties:
 - a. Membrane Air Permeance: Not to exceed 0.004 cfm/sq. ft. of surface area at 1.57-lbf/sq. ft. pressure difference; ASTM E 2178.
 - b. Tensile Strength: 250 psi minimum; ASTM D 412, Die C, modified.
 - c. Ultimate Elongation: 200 percent minimum; ASTM D 412, Die C, modified.
 - d. Low-Temperature Flexibility: Pass at minus 20 deg F, ASTM D 1970.
 - e. Crack Cycling: Unaffected after 100 cycles of 1/8-inch movement; ASTM C 836.
 - f. Puncture Resistance: 40 lbf minimum; ASTM E 154.
 - g. Water Absorption: 0.15 percent weight-gain maximum after 48-hour immersion at 70 deg F; ASTM D 570.
 - h. Vapor Permeance: 0.05 perms, ASTM E 96, Water Method.

2.02 AUXILIARY MATERIALS

- A. General: Auxiliary materials recommended by air barrier manufacturer for intended use and compatible with air barrier. Liquid-type auxiliary materials shall comply with VOC limits of authorities having jurisdiction.
- B. Primer: Liquid waterborne or solvent-borne primer recommended for substrate by manufacturer of air barrier material.

- C. Counterflashing Strip: Modified bituminous 40-mil-thick, self-adhering sheet consisting of 32 mils of rubberized asphalt laminated to an 8-mil-thick, crosslaminated polyethylene film with release liner backing.
- D. Butyl Strip at Termination with EPDM or TPO Roofing Membrane: Vapor-retarding, 30- to 40-mil-thick, self adhering; polyethylene-film-reinforced top surface laminated to layer of butyl adhesive, with release liner backing.
- E. Modified Bituminous Strip To Cover Cracks and Joints and Terminate Air Barrier to Compatible Roofing Membrane: Vapor-retarding, 40-mil-thick, smooth-surfaced, self-adhering; consisting of 36 mils of rubberized asphalt laminated to a 4-mil- polyethylene film with release liner backing.
- F. Termination Mastic: Cold fluid-applied elastomeric liquid; trowel grade.
- G. Substrate Patching Membrane: Manufacturer's standard trowel-grade substrate filler.
- H. Adhesive and Tape: Air barrier manufacturer's standard adhesive and pressure-sensitive adhesive tape.
- I. Stainless-Steel Sheet: ASTM A 240/A 240M, Type 304, 0.0187 inch thick, and Series 300 stainless-steel fasteners.
- J. Sprayed Polyurethane Foam Sealant to Fill Gaps at Penetrations and Openings: 1- or 2-component, foamed-in-place, polyurethane foam sealant, 1.5 to 2.0 lb/cu. ft. density; flame spread index of 25 or less according to ASTM E 162; with primer and noncorrosive substrate cleaner recommended by foam sealant manufacturer.
- K. Modified Bituminous Transition Strip to Seal Air Barrier Terminations with Glazing Systems: Vapor-retarding, 40-mil-thick, smooth-surfaced, self-adhering; consisting of 36 mils of rubberized asphalt laminated to a 4-mil-thick polyethylene or aluminum film with release liner backing.
- L. Preformed Silicone-Sealant Extrusion to Seal Air Barrier Terminations with Glazing Systems: Manufacturer's standard system consisting of cured low-modulus silicone extrusion, sized to fit opening widths, with a single-component, neutral-curing, Class 100/50 (low-modulus) silicone sealant for bonding extrusions to substrates.
 - 1. Available Products: Subject to compliance with requirements, products that may be incorporated into the Work include, but are not limited to, the following:
 - a. Dow Corning Corporation, 123 Silicone Seal.
 - b. GE Silicone, UltraSpan US1100.
 - c. Pecora Corporation, Sil-Span.
 - d. Tremco, Incorporated, Spectrem EZ Simple Seal.
 - e. Or approved equal.

- M. Joint Sealant: ASTM C 920, single-component, neutral-curing silicone; Class 100/50 (low-modulus), Grade NS, Use NT related to exposure, and, as applicable to joint substrates indicated, Use O. Comply with Section 07920 - JOINT SEALANTS.

PART 3 - EXECUTION

3.01 EXAMINATION

- A. Examine substrates, areas, and conditions, with Installer present, for compliance with requirements and other conditions affecting performance.
 - 1. Verify that substrates are sound and free of oil, grease, dirt, excess mortar, or other contaminants.
 - 2. Verify that concrete has cured and aged for minimum time period recommended by air barrier manufacturer.
 - 3. Verify that concrete is visibly dry and free of moisture. Test for capillary moisture by plastic sheet method according to ASTM D 4263.
 - 4. Verify that masonry joints are flush and completely filled with mortar.
 - 5. Proceed with installation only after unsatisfactory conditions have been corrected.

3.02 SURFACE PREPARATION

- A. Clean, prepare, and treat substrate according to manufacturer's written instructions. Provide clean, dust-free, and dry substrate for air barrier application.
- B. Mask off adjoining surfaces not covered by air barrier to prevent spillage and overspray affecting other construction.
- C. Remove grease, oil, bitumen, form-release agents, paints, curing compounds, and other penetrating contaminants or film-forming coatings from concrete.
- D. Remove fins, ridges, mortar, and other projections and fill honeycomb, aggregate pockets, holes, and other voids in concrete with substrate-patching membrane.
- E. Remove excess mortar from masonry ties, shelf angles, and other obstructions.
- F. Prepare, fill, prime, and treat joints and cracks in substrates. Remove dust and dirt from joints and cracks according to ASTM D 4258.
 - 1. Install modified bituminous strips and center over treated construction and contraction joints and cracks exceeding a width of 1/16 inch.
- G. Bridge and cover isolation joints expansion joints and discontinuous deck-to-wall and deck-to-deck joints with overlapping modified bituminous strips.
- H. At changes in substrate plane, apply sealant or termination mastic beads at sharp corners and edges to form a smooth transition from one plane to another.

- I. Cover gaps in substrate plane and form a smooth transition from one substrate plane to another with stainless-steel sheet mechanically fastened to structural framing to provide continuous support for air barrier.

3.03 TRANSITION STRIP INSTALLATION

- A. Install strips, transition strips, and auxiliary materials according to air barrier manufacturer's written instructions to form a seal with adjacent construction and maintain a continuous air barrier.
 1. Coordinate the installation of air barrier with installation of roofing membrane and base flashing to ensure continuity of air barrier with roofing membrane.
 2. Install butyl or modified bituminous strip on roofing membrane or base flashing so that a minimum of 3 inches of coverage is achieved over both substrates.
- B. Apply primer to substrates at required rate and allow to dry. Limit priming to areas that will be covered by air barrier sheet in same day. Reprime areas exposed for more than 24 hours.
 1. Prime glass-fiber-surfaced gypsum sheathing with number of prime coats needed to achieve required bond, with adequate drying time between coats.
- C. Connect and seal exterior wall air barrier membrane continuously to roofing membrane air barrier, concrete below-grade structures, floor-to floor construction, exterior glazing and window systems, glazed curtain-wall systems, storefront systems, exterior louvers, exterior door framing, and other construction used in exterior wall openings, using accessory materials.
- D. At end of each working day, seal top edge of strips and transition strips to substrate with termination mastic.
- E. Apply joint sealants forming part of air barrier assembly within manufacturer's recommended application temperature ranges. Consult manufacturer when sealant cannot be applied within these temperature ranges.
- F. Wall Openings: Prime concealed perimeter frame surfaces of windows, curtain walls, storefronts, and doors. Apply [modified bituminous transition strip] [adhesive-coated transition strip] [elastomeric flashing sheet] [preformed silicone-sealant extrusion] so that a minimum of 3 inches of coverage is achieved over both substrates. Maintain 3 inches of full contact over firm bearing to perimeter frames with not less than 1 inch of full contact.
 1. Transition Strip: Roll firmly to enhance adhesion.
 2. Elastomeric Flashing Sheet: Apply adhesive to wall, frame, and flashing sheet. Install flashing sheet and termination bars, fastened at 6 inches o.c. Apply lap sealant over exposed edges and on cavity side of flashing sheet.
 3. Preformed Silicone-Sealant Extrusion: Set in full bed of silicone sealant applied to walls, frame, and membrane.

- G. Fill gaps in perimeter frame surfaces of windows, curtain walls, storefronts, and doors, and miscellaneous penetrations of air barrier membrane with foam sealant.
- H. Seal strips and transition strips around masonry reinforcing or ties and penetrations with termination mastic.
- I. Seal top of through-wall flashings to air barrier with an additional 6-inch-wide, modified bituminous strip.
- J. Seal exposed edges of strips at seams, cuts, penetrations, and terminations not concealed by metal counterflashings or ending in reglets with termination mastic.
- K. Repair punctures, voids, and deficient lapped seams in strips and transition strips. Slit and flatten fishmouths and blisters. Patch with transition strips extending 6 inches beyond repaired areas in strip direction.

3.04 INSTALLATION OF SELF-ADHERING SHEET MEMBRANE

- A. Install modified bituminous sheets according to air barrier manufacturer's written instructions and according to recommendations in ASTM D 6135.
 - 1. When ambient and substrate temperatures range between 25 and 40 deg F, install self-adhering, modified bituminous air barrier sheets produced for low-temperature application. Do not use low-temperature sheets if ambient or substrate temperature is higher than 60 deg F.
- B. Corners: Prepare, prime, and treat inside and outside corners according to ASTM D 6135.
 - 1. Install modified bituminous strips centered over vertical inside corners. Install 3/4-inch fillets of termination mastic on horizontal inside corners.
- C. Prepare, treat, and seal vertical and horizontal surfaces at terminations and penetrations with termination mastic and according to ASTM D 6135.
- D. Apply primer to substrates at required rate and allow to dry. Limit priming to areas that will be covered by air barrier sheet in same day. Reprime areas exposed for more than 24 hours.
 - 1. Prime glass-fiber-surfaced gypsum sheathing with number of prime coats needed to achieve required bond, with adequate drying time between coats.
- E. Apply and firmly adhere modified bituminous sheets horizontally or vertically over area to receive air barrier sheets. Accurately align sheets and maintain a uniform 2-1/2-inch-minimum lap widths and end laps. Overlap and seal seams and stagger end laps to ensure airtight installation.

1. Apply sheets in a shingled manner to shed water without interception by any exposed sheet edges.
 2. Roll sheets firmly to enhance adhesion to substrate.
 3. Apply termination mastic on any horizontal, field-cut or non-factory edges.
- F. Apply continuous modified bituminous sheets over modified bituminous strips bridging substrate cracks, construction, and contraction joints.
- G. Seal top of non-metallic through-wall flashings to air barrier sheet with an additional 6-inch- wide strip.
- H. Seal exposed edges of metallic sheets at seams, cuts, penetrations, and terminations not concealed by metal counterflashings or ending in reglets with termination mastic.
- I. Install air barrier sheets and auxiliary materials to form a seal with adjacent construction and to maintain a continuous air barrier.
1. Coordinate the installation of air barrier with installation of roofing membrane and base flashing to ensure continuity of air barrier with roofing membrane.
 2. Install compatible strip on roofing membrane or base flashing so that a minimum of 3 inches of coverage is achieved over both substrates.
- J. Connect and seal exterior wall air barrier membrane continuously to roofing membrane air barrier, concrete below-grade structures, floor-to floor construction, exterior glazing and window systems, glazed curtain-wall systems, storefront systems, exterior louvers, exterior door framing, and other construction used in exterior wall openings using accessory materials.
- K. Wall Openings: Prime concealed perimeter frame surfaces of windows, curtain walls, storefronts, and doors. Apply membrane specified below so that a minimum of 3 inches of coverage is achieved over both substrates. Maintain 3 inches of full contact over firm bearing to perimeter frames with not less than 1 inch of full contact.
1. Modified Bituminous Transition Strip: Roll firmly to enhance adhesion.
 2. Elastomeric Flashing Sheet: Apply adhesive to wall, frame, and flashing sheet. Install flashing sheet and termination bars, fastened at 6 inches o.c. Apply lap sealant over exposed edges and on cavity side of flashing sheet.
 3. Preformed Silicone-Sealant Extrusion: Set in full bed of silicone sealant applied to walls, frame, and membrane.
- L. Fill gaps in perimeter frame surfaces of windows, curtain walls, storefronts, doors, and miscellaneous penetrations of air barrier membrane with foam sealant.
- M. At end or each working day, seal top edge of membrane to substrate with termination mastic.

- N. Apply joint sealants forming part of air barrier assembly within manufacturer's recommended application temperature ranges. Consult manufacturer when sealant cannot be applied within these temperature ranges.
- O. Repair punctures, voids, and deficient lapped seams in air barrier. Slit and flatten fishmouths and blisters. Patch with air barrier sheet extending 6 inches beyond repaired areas in all directions.
- P. Do not cover air barrier until it has been tested and inspected by Owner's testing agency.
- Q. Correct deficiencies in or remove air barrier that does not comply with requirements; repair substrates and reapply air barrier components.

3.05 FIELD QUALITY CONTROL

- A. Testing Agency: Engage a qualified testing agency to perform tests and inspections and prepare test reports.
- B. Inspections: Air barrier materials and installation are subject to inspection for compliance with requirements. Inspections may include the following:
 - 1. Continuity of air barrier system has been achieved throughout the building envelope with no gaps or holes.
 - 2. Continuous structural support of air barrier system has been provided.
 - 3. Masonry and concrete surfaces are smooth, clean, and free of cavities, protrusions, and mortar droppings.
 - 4. Site conditions for application temperature and dryness of substrates have been maintained.
 - 5. Maximum exposure time of materials to UV deterioration has not been exceeded.
 - 6. Surfaces have been primed.
 - 7. Laps in sheet materials have complied with the minimum requirements and have been shingled in the correct direction (or mastic applied on exposed edges), with no fishmouths.
 - 8. Termination mastic has been applied on cut edges.
 - 9. Air barrier has been firmly adhered to substrate.
 - 10. Compatible materials have been used.
 - 11. Transitions at changes in direction and structural support at gaps have been provided.
 - 12. Connections between assemblies (membrane and sealants) have complied with requirements for cleanliness, preparation, and priming of surfaces, structural support, integrity, and continuity of seal.
 - 13. All penetrations have been sealed.
- C. Tests:
 - 1. Qualitative Testing: Air barrier assemblies will be tested for evidence of air leakage according to ASTM E 1186.

2. Quantitative Air Leakage Testing: Testing not to exceed the test pressure differential, positive and negative, indicated in "Performance Requirements" Article for air barrier assembly air leakage according to ASTM E 783.

D. Remove and replace deficient air barrier components and retest as specified above.

3.06 CLEANING AND PROTECTION

A. Protect air barrier system from damage during application and remainder of construction period, according to manufacturer's written instructions.

1. Protect air barrier from exposure to UV light and harmful weather exposure as required by manufacturer. Remove and replace air barrier exposed to these conditions for more than 30 days.
2. Protect air barrier from contact with creosote, uncured coal-tar products, TPO, EPDM, flexible PVC membranes, and sealants not approved by air barrier manufacturer.

B. Clean spills, stains, and soiling from adjacent construction that would be exposed in the completed work using cleaning agents and procedures recommended by manufacturer of affected construction.

END OF SECTION

(THIS PAGE INTENTIONALLY LEFT BLANK)

SECTION 07530

SINGLE PLY MEMBRANE ROOFING

(Part of Work of Section 070002 - ROOFING AND FLASHING, Filed Sub-Bid Required)

PART 1 - GENERAL

1.1 GENERAL PROVISIONS

- A. Attention is directed to the CONTRACT AND GENERAL CONDITIONS and all Sections within DIVISION 01 - GENERAL REQUIREMENTS which are hereby made a part of this Section of the Specifications.

1.2 DESCRIPTION OF WORK

- A. Work Included: Provide labor, materials and equipment necessary to complete the work of this Section, including but not limited to the following:

1. Adhered TPO membrane-roofing system.
2. Cover board.
3. Roof insulation.
4. Substrate Board (thermal barrier).
5. Vapor retarder.
6. Metal flashing, including roof edge flashing, gutters and downspouts.
7. Flashing for equipment mounted on roofing and roofing penetrations.

- B. Related Work: The following items are not included in this Section and are specified under the designated Sections:

1. Section 06100 - ROUGH CARPENTRY for wood nailers, curbs, and blocking.
2. Section 07620 - SHEET METAL FLASHING AND TRIM for metal roof penetration flashings, flashings, and counterflashings.
3. Section 07920 - JOINT SEALANTS for sealants.
4. Division 15 - PLUMBING for roof drains.
5. Division 15 - HEATING, VENTILATING, AND AIR CONDITIONING for roof curbs for HVAC equipment.

1.3 DEFINITIONS

- A. Roofing Terminology: Refer to ASTM D 1079 and glossary of NRCA's "The NRCA Roofing and Waterproofing Manual" for definition of terms related to roofing work in this Section.

1.4 PERFORMANCE REQUIREMENTS

- A. General: Provide installed roofing membrane and base flashings that remain watertight; do not permit the passage of water; and resist specified uplift pressures, thermally induced movement, and exposure to weather without failure.
- B. Material Compatibility: Provide roofing materials that are compatible with one another under conditions of service and application required, as demonstrated by roofing manufacturer based on testing and field experience.
- C. Roofing System Design: Roofing system shall be designed to withstand loads indicated on Drawings, but not less than loads required by Code.
- D. Flashings: Provide base flashings, perimeter flashings, detail flashings and component materials that comply with requirements and recommendations in FMG 1-49 Loss Prevention Data Sheet for Perimeter Flashings; FMG 1-29 Loss Prevention Data Sheet for Above Deck Roof Components; NRCA Roofing and Waterproofing Manual (Fourth Edition) for Construction Details and SMACNA Architectural Sheet Metal Manual (Fifth Edition) for Construction Details, as applicable.

1.5 SUBMITTALS

- A. Product Data: For each type of product indicated.
- B. Shop Drawings: For roofing system. Include plans, elevations, sections, details, and attachments to other Work.
 - 1. Base flashings and membrane terminations.
 - 2. Transitions to air barrier membrane.
 - 3. Tapered insulation, including slopes.
 - 4. Insulation fastening patterns.
- C. Installer Certificates: Signed by roofing system manufacturer certifying that Installer is approved, authorized, or licensed by manufacturer to install roofing system.
- D. Qualification Data: For Installer and manufacturer.
- E. Manufacturer Certificates: Signed by roofing manufacturer certifying that roofing system complies with requirements specified in "Performance Requirements" Article.
 - 1. Submit evidence of complying with performance requirements.
- F. Product Test Reports: For components of roofing system, tests performed by manufacturer and witnessed by a qualified testing agency.
- G. Inspection Report: Copy of roofing system manufacturer's inspection report of completed roofing installation.

H. Maintenance Data: For roofing system to include in maintenance manuals.

1.6 QUALITY ASSURANCE

- A. Source Limitations: Obtain components for roofing system from or approved by roofing system manufacturer.
- B. Installer Qualifications: A qualified firm that is approved, authorized, or licensed by roofing system manufacturer to install manufacturer's product and that is eligible to receive manufacturer's special warranty.
- C. Roofing Inspector: Owner may engage a full-time roofing inspector during installation of the deck, insulation assembly, membrane, flashing and other appurtenances, and when a survey of the roof and roof drains is conducted. Cooperate with Owner's roofing inspector and allow unlimited access to roofing during construction.
- D. Preinstallation Conference: Conduct conference at Project site. Comply with requirements in Division 01. Review methods and procedures related to roofing system including, but not limited to, the following:
1. Meet with the Owner, Architect, Owner's insurer if applicable, testing and inspecting agency representative, roofing Installer, roofing system manufacturer's representative, deck Installer, and installers whose work interfaces with or affects roofing including installers of roof accessories and roof-mounted equipment.
 2. Review methods and procedures related to roofing installation, including manufacturer's written instructions.
 3. Review and finalize construction schedule and verify availability of materials, Installer's personnel, equipment, and facilities needed to make progress and avoid delays.
 4. Examine deck substrate conditions and finishes for compliance with requirements, including flatness and fastening.
 5. Review structural loading limitations of roof deck during and after roofing.
 6. Review base flashings, special roofing details, roof drainage, roof penetrations, equipment curbs, and condition of other construction that will affect roofing system.
 7. Review governing regulations and requirements for insurance and certificates if applicable.
 8. Review temporary protection requirements for roofing system during and after installation.
 9. Review roof observation and repair procedures after roofing installation.

1.7 DELIVERY, STORAGE, AND HANDLING

- A. Deliver roofing materials to Project site in original containers with seals unbroken and labeled with manufacturer's name, product brand name and type, date of manufacture, and directions for storing and mixing with other components.

- B. Store liquid materials in their original undamaged containers in a clean, dry, protected location and within the temperature range required by roofing system manufacturer. Protect stored liquid material from direct sunlight.
 - 1. Discard and legally dispose of liquid material that cannot be applied within its stated shelf life.
- C. Protect roof insulation materials from physical damage and from deterioration by sunlight, moisture, soiling, and other sources. Store in a dry location. Comply with insulation manufacturer's written instructions for handling, storing, and protecting during installation.
- D. Handle and store roofing materials and place equipment in a manner to avoid permanent deflection of deck.

1.8 PROJECT CONDITIONS

- A. Weather Limitations: Proceed with installation only when existing and forecasted weather conditions permit roofing system to be installed according to manufacturer's written instructions and warranty requirements.

1.9 WARRANTY

- A. Roofing Contractor's Warranty: The roofing subcontractor shall supply Owner with a minimum two-year workmanship warranty for each roof. In the event any work related to the roofing, flashing, or metalwork is found to be defective within two years of substantial completion, the roofing contractor shall remove and replace such at no additional cost to the Owner. The roofing subcontractor's warranty obligation shall run directly to the Owner, and a copy the roofing signed warranty shall be sent to the roofing system's manufacturer.
 - 1. The duration of the Roofing Contractor's two-year warranty shall run concurrent with the roofing system's manufacturer's 20-year warranty.
- B. Roofing Systems Manufacturer's Warranty: The roofing manufacturer shall guarantee roof areas to be in a watertight condition, for a period of 20 years, from the date of final acceptance of the roofing system. The warranty shall be a 20-year no dollar limit (NDL), non-prorated total system labor and material warranty, for wind speed as required by Code or as indicated on the Drawings. Total system warranty shall include all roofing materials, related components and accessories including, but not limited to the substrate board, vapor retarder, insulation board, cover board, roofing membrane, membrane flashings, fasteners, adhesives, metal roof copings, metal roof edges and termination metals and roof drain assemblies. The manufacturer shall repair defects in materials and workmanship as promptly after observation as weather and site conditions permit.

PART 2 - PRODUCTS

2.1 THERMOPLASTIC POLYOLEFIN ROOFING MEMBRANE

- A. Fabric-Reinforced Thermoplastic Polyolefin Sheet: Uniform, flexible sheet conforming to ASTM D 6878 and formed from a thermoplastic polyolefin, internally fabric or scrim reinforced, and as follows:
1. Manufacturer: UltraPly TPO with IsoGard HD cover board by Firestone or equal by Carlisle SynTec or GAF Materials Corp.
 2. Thickness: 60 mils (1.5 mm) nominal.
 3. Exposed Face Color: White.
 4. Physical Properties:
 - a. Breaking Strength: 225 lbf; ASTM D 751, grab method.
 - b. Elongation at Break: 15 percent; ASTM D 751.
 - c. Tearing Strength: 55 lbf minimum; ASTM D 751, Procedure B.
 - d. Water Absorption: Less than 4 percent mass change after 166 hours' immersion at 158 deg F; ASTM D 471.

2.2 SHEET METAL FLASHING

- A. Aluminum Sheet: ASTM B 209, Alloy 3003, 3004, 3105, or 5005. Thickness as specified in this Section. Temper suitable for forming and structural performance required, but not less than H14, finished as follows:
1. High-Performance Organic Finish (2-Coat Fluoropolymer): AA-C12C40R1x (Chemical Finish: cleaned with inhibited chemicals; Chemical Finish: conversion coating; Organic Coating: manufacturer's standard 2-coat, thermocured system consisting of specially formulated inhibitive primer and fluoropolymer color coat, with color coat containing not less than 70 percent polyvinylidene fluoride resin by weight). Prepare, pretreat, and apply coating to exposed metal surfaces to comply with AAMA 2605 and with coating and resin manufacturers' written instructions.
 - a. Color and Gloss: As selected by Architect from manufacturer's full range.
- B. Underlayment Materials:
1. Felts: ASTM D 226, Type II (No. 30), asphalt-saturated organic felt, nonperforated.
 2. Slip Sheet: Rosin-sized paper, minimum 3 lb/100 sq. ft.
- C. Miscellaneous Materials
1. General: Provide materials and types of fasteners, solder, welding rods, protective coatings, separators, sealants, and other miscellaneous items as required for complete sheet metal flashing and trim installation.

2. Fasteners: Wood screws, annular threaded nails, self-tapping screws, self-locking rivets and bolts, and other suitable fasteners designed to withstand design loads.
 - a. Exposed Fasteners: Heads matching color of sheet metal by means of plastic caps or factory-applied coating.
 - b. Fasteners for Flashing and Trim: Blind fasteners or self-drilling screws, gasketed, with hex washer head.
 - c. Blind Fasteners: High-strength aluminum or stainless-steel rivets.

- D. Roof Edge Flashing (Gravel Stop) and Fascia Caps: Fabricate in minimum 96-inch-long, but not exceeding 10-foot-long, sections. Furnish with 6-inch-wide joint cover plates.
 1. Joint Style: Butt, with 12-inch-wide concealed backup plate.
 2. Fabricate from the following material:
 - a. Aluminum: 0.050 inch thick.

- E. Copings: Fabricate in minimum 96-inch-long, but not exceeding 10-foot-long, sections. Fabricate joint plates of same thickness as copings. Furnish with continuous cleats to support edge of external leg and drill elongated holes for fasteners on interior leg. Miter corners, seal, and solder or weld watertight.
 1. Joint Style: Butt, with 12-inch-wide concealed backup plate.
 2. Fabricate copings from the following material:
 - a. Aluminum: 0.050 inch thick.

- F. Gutters and Downspouts
 1. Manufacturers: Subject to compliance with requirements, provide products by one of the following:
 - a. ATAS International, Inc.
 - b. Hickman Company, W. P.
 - c. Metal-Era, Inc.
 - d. Metal-Fab Manufacturing, LLC.
 - e. MM Systems Corporation.

 2. Gutters: Manufactured in uniform section lengths not exceeding 12 feet, with matching corner units, ends, outlet tubes, and other accessories. Elevate back edge at least 1 inch above front edge. Furnish flat-stock gutter straps, gutter brackets, expansion joints, and expansion-joint covers fabricated from same metal as gutters.
 - a. Fabricate from the following exposed metal:
 - 1) Aluminum: 0.050 inch thick.

- b. Gutter Profile: As indicated according to SMACNA's "Architectural Sheet Metal Manual."
 - c. Corners: Factory mitered and soldered.
 - d. Gutter Supports: As indicated with finish matching the gutters.
 - e. Gutter Accessories: Bronze wire ball downspout strainer,
3. Downspouts: Plain round complete with mitered elbows, manufactured from the following exposed metal. Furnish with metal hangers, from same material as downspouts, and anchors.
- a. Aluminum: 0.040 inch thick.
4. Conductor Heads: Manufactured conductor heads, each with flanged back and stiffened top edge and of dimensions and shape indicated, complete with outlet tube that nests into upper end of downspout.
- a. Fabricate from the following exposed metal:
 - b. Aluminum: 0.040 inch thick.

2.3 AUXILIARY MATERIALS

- A. General: Auxiliary materials recommended by roofing system manufacturer for intended use and compatible with membrane roofing.
 - 1. Liquid-type auxiliary materials shall meet VOC limits of authorities having jurisdiction.
- B. Bonding Adhesive: Manufacturer's recommended bonding adhesive.
- C. Metal Termination Bars: Manufacturer's standard predrilled stainless steel or aluminum bars, approximately 1 by 1/8 inch thick; with anchors.
- D. Fasteners: Factory-coated steel fasteners and metal or plastic plates meeting corrosion-resistance provisions in FMG 4470, designed for fastening membrane to substrate, and acceptable to membrane roofing system manufacturer.
- E. Miscellaneous Accessories: Provide pourable sealers, preformed cone and vent sheet flashings, preformed inside and outside corner sheet flashings, T-joint covers, termination reglets, cover strips, and other accessories.

2.4 VAPOR RETARDER

- A. Self-Adhering Sheet Vapor Retarder: ASTM D 1970, minimum 40-mil- thick film laminated to layer of rubberized asphalt adhesive; maximum permeance rating of 0.1 perm; cold-applied, with slip-resisting surface and release paper backing. Provide primer when recommended by vapor-retarder manufacturer.

2.5 ROOF INSULATION

- A. General: Provide preformed roof insulation boards that comply with requirements and referenced standards, selected from manufacturer's standard sizes and of thicknesses indicated.
- B. Polyisocyanurate Board Insulation: ASTM C 1289, Type II, felt or glass-fiber mat facer on both major surfaces.
 - 1. Products: Subject to compliance with requirements, products that may be incorporated into the Work include, but are not limited to, the following:
 - a. Atlas Roofing Corporation.
 - b. Carlisle SynTec Incorporated.
 - c. Firestone Building Products Company.
 - d. GAF Materials Corp.
 - e. GenFlex Roofing Systems.
 - f. Johns Manville International Inc.
- C. Tapered Insulation: Provide factory-tapered insulation boards fabricated to slope of 1/4 inch per 12 inches unless otherwise indicated.
- D. Provide preformed saddles, crickets, tapered edge strips, and other insulation shapes where indicated for sloping to drain. Fabricate to slopes indicated.

2.6 INSULATION ACCESSORIES

- A. General: Furnish roof insulation accessories recommended by insulation manufacturer for intended use and compatible with membrane roofing.
- B. Fasteners: Factory-coated steel fasteners and metal or plastic plates meeting corrosion-resistance provisions in FMG 4470, designed for fastening roof insulation to substrate, and acceptable to roofing system manufacturer.
- C. Cover Board: Provide one of the following, as required by roofing manufacturer to comply with performance requirements and provide specified warranty.
 - 1. Cover Board: As recommended by manufacturer or ASTM C 1177/C 1177M, glass-mat, water-resistant gypsum substrate, 1/2 or 5/8 inch thick, factory primed.
- D. Substrate Board (Thermal Barrier): ASTM C 1177/C 1177M, glass-mat, water-resistant gypsum substrate, Type X, 5/8 inch (16 mm) thick, factory primed.

2.7 WALKWAYS

- A. Flexible Walkways: Factory-formed, nonporous, heavy-duty, slip-resisting, surface-textured vinyl walkway pads or rolls approximately 3/16 inch thick, and acceptable to membrane roofing system manufacturer.

PART 3 - EXECUTION

3.1 EXAMINATION

- A. Examine substrates, areas, and conditions, with Installer present, for compliance with the following requirements and other conditions affecting performance of roofing system:
 - 1. Verify that roof openings and penetrations are in place and set and braced and that roof drains are securely clamped in place.
 - 2. Verify that wood blocking, curbs, and nailers are securely anchored to roof deck at penetrations and terminations and that nailers match thicknesses of insulation.
 - 3. Verify that surface plane flatness and fastening of steel roof deck comply with requirements in Section 053100 - STEEL DECKING.
 - 4. Verify that minimum concrete drying period recommended by roofing system manufacturer has passed.
 - 5. Verify that concrete substrate is visibly dry and free of moisture. Test for capillary moisture by plastic sheet method according to ASTM D 4263.
 - 6. Verify that concrete curing compounds that will impair adhesion of roofing components to roof deck have been removed.
 - 7. Proceed with installation only after unsatisfactory conditions have been corrected.

3.2 PREPARATION

- A. Clean substrate of dust, debris, moisture, and other substances detrimental to roofing installation according to roofing system manufacturer's written instructions. Remove sharp projections.
- B. Prevent materials from entering and clogging roof drains and conductors and from spilling or migrating onto surfaces of other construction. Remove roof-drain plugs when no work is taking place or when rain is forecast.
- C. Complete terminations and base flashings and provide temporary seals to prevent water from entering completed sections of roofing system at the end of the workday or when rain is forecast. Remove and discard temporary seals before beginning work on adjoining roofing.

3.3 SUBSTRATE BOARD INSTALLATION

- A. Install substrate board with long joints in continuous straight lines, perpendicular to roof slopes with end joints staggered between rows. Tightly butt substrate boards together.
 - 1. Fasten substrate board to top flanges of steel deck to resist uplift pressure at corners, perimeter, and field of roof according to roofing system manufacturers' written instructions and as required to comply with performance requirements.

3.4 VAPOR-RETARDER INSTALLATION

- A. Self-Adhering Sheet Vapor Retarder: Prime substrate if required by manufacturer. Install self-adhering sheet vapor retarder over area to receive vapor retarder, side, and end lapping each sheet a minimum of 3-1/2 inches and 6 inches, respectively. Seal laps by rolling.
- B. Completely seal vapor retarder at side laps, end laps, terminations, obstructions, and penetrations to prevent air movement into roofing system.
- C. Tie vapor retarder to wall air barrier. Coordinate construction sequence to ensure air barrier continuity at roof to wall interfaces.

3.5 INSULATION AND COVERBOARD INSTALLATION

- A. Coordinate installing membrane roofing system components so insulation is not exposed to precipitation or left exposed at the end of the workday.
- B. Comply with membrane roofing system manufacturer's written instructions for installing roof insulation.
- C. Install tapered insulation under area of roofing to conform to slopes indicated.
- D. Install one or more layers of insulation under area of roofing to achieve required thickness. Install 2 or more layers with joints of each succeeding layer staggered from joints of previous layer a minimum of 6 inches in each direction.
- E. Trim surface of insulation where necessary at roof drains so completed surface is flush and does not restrict flow of water.
- F. Install insulation with long joints of insulation in a continuous straight line with end joints staggered between rows, abutting edges and ends between boards. Fill gaps exceeding 1/4 inch with insulation.
 - 1. Cut and fit insulation within 1/4 inch of nailers, projections, and penetrations.
- G. Mechanically Fastened Insulation: Install each layer of insulation and secure to deck using mechanical fasteners specifically designed and sized for fastening specified board-type roof insulation to deck type.
 - 1. Fasten insulation to resist uplift pressure at corners, perimeter, and field of roof.
 - 2. For insulation applied in multiple layers, loose-lay first layer and mechanically fasten top layer.
- H. Mechanically Fastened Cover Boards: Install cover boards over insulation with long joints in continuous straight lines with end joints staggered between rows. Offset joints of insulation below a minimum of 6 inches in each direction. Loosely butt cover boards together and mechanically fasten to roof deck.

1. Mechanically fasten cover boards, unless otherwise indicated.
2. Fasten insulation to resist uplift pressure at corners, perimeter, and field of roof.

3.6 ROOF FLASHING INSTALLATION

- A. General: Install sheet metal roof flashing and trim to comply with performance requirements, sheet metal manufacturer's written installation instructions, and SMACNA's "Architectural Sheet Metal Manual." Provide concealed fasteners where possible, set units true to line, and level as indicated. Install work with laps, joints, and seams that will be permanently watertight.
- B. Pipe or Post Counterflashing: Install counterflashing umbrella with close-fitting collar with top edge flared for elastomeric sealant, extending a minimum of 4 inches over base flashing. Install stainless steel draw band and tighten.
- C. Counterflashing: Coordinate installation of counterflashing with installation of base flashing. Insert counterflashing in reglets or receivers and fit tightly to base flashing. Extend counterflashing 4 inches over base flashing. Lap counterflashing joints a minimum of 4 inches and bed with elastomeric sealant.
 1. Secure in a waterproof manner by means of snap-in installation and sealant.
- D. Roof-Penetration Flashing: Coordinate installation of roof-penetration flashing with installation of roofing and other items penetrating roof. Install flashing as follows:
 1. Seal with elastomeric sealant and clamp flashing to pipes penetrating roof except for flashing on vent piping.

3.7 BASE FLASHING INSTALLATION

- A. Install sheet flashings and preformed flashing accessories and adhere to substrates according to membrane roofing system manufacturer's written instructions.
- B. Apply solvent-based bonding adhesive to substrate and underside of sheet flashing at required rate and allow to partially dry. Do not apply bonding adhesive to seam area of flashing.
- C. Flash penetrations and field-formed inside and outside corners with cured or uncured sheet flashing.
- D. Clean splice areas, apply splicing cement (except for heat-welded application), and firmly roll side and end laps of overlapping sheets to ensure a watertight seam installation. Apply lap sealant and seal exposed edges of sheet flashing terminations.
- E. Terminate and seal top of sheet flashings.

3.8 WALKWAY INSTALLATION

- A. Flexible Walkways: Install walkway products in locations indicated. Heat weld to substrate or adhere walkway products to substrate with compatible adhesive according to roofing system manufacturer's written instructions.

3.9 FIELD QUALITY CONTROL

- A. Testing Agency: Owner will engage a qualified independent testing and inspecting agency to perform roof tests and inspections and to prepare test reports.
- B. Manufacturer's Technical Representative: Engage a qualified manufacturer's technical representative to perform roof tests and inspections and to prepare test reports.
- C. Final Roof Inspection: Engage roofing system manufacturer's technical personnel to inspect roofing installation on completion and submit report to Architect.
 - 1. Notify Architect and the Owner 48 hours in advance of date and time of inspection.
- D. Repair or remove and replace components of membrane roofing system where test results or inspections indicate that they do not comply with specified requirements.
- E. Additional testing and inspecting, at Contractor's expense, will be performed to determine compliance of replaced or additional work with specified requirements.

3.10 PROTECTING AND CLEANING

- A. Protect membrane-roofing system from damage and wear during remainder of construction period. When remaining construction will not affect or endanger roofing, inspect roofing for deterioration and damage, describing its nature and extent in a written report, with copies to Architect and the Owner.
- B. Correct deficiencies in or remove membrane-roofing system that does not comply with requirements, repair substrates, and repair or reinstall membrane-roofing system to a condition free of damage and deterioration at time of Substantial Completion and according to warranty requirements.
- C. Clean overspray and spillage from adjacent construction using cleaning agents and procedures recommended by manufacturer of affected construction.

END OF SECTION

SECTION 07620

SHEET METAL FLASHING AND TRIM

(Part of Work of Section 07002 - ROOFING AND FLASHING, Filed Sub-Bid Required)

PART 1 - GENERAL

1.01 GENERAL PROVISIONS

- A. Attention is directed to the CONTRACT AND GENERAL CONDITIONS and all Sections within DIVISION 01 - GENERAL REQUIREMENTS which are hereby made a part of this Section of the Specifications.

1.02 DESCRIPTION OF WORK

- A. Work Included: Provide labor, materials and equipment necessary to complete the work of this Section, including but not limited to the following:
 - 1. Sheet metal flashing and trim at exterior windows and doors.
- B. Related Work: The following items are not included in this Section and are specified under the designated Sections:
 - 1. Section 04200 - UNIT MASONRY and Section 04220 - REINFORCED UNIT MASONRY for through-wall flashings in masonry.
 - 2. Section 06100 - ROUGH CARPENTRY for wood nailers, curbs, and blocking.
 - 3. Section 07270 - AIR BARRIERS for perimeter terminations at air and vapor barrier assembly.
 - 4. Section 07530 - SINGLE PLY MEMBRANE ROOFING for sheet metal roofing and flashing at roof.
 - 5. Section 07920 - JOINT SEALANTS for field-applied sheet metal flashing and trim sealants.

1.03 PERFORMANCE REQUIREMENTS

- A. General: Install sheet metal flashing and trim to withstand wind loads, structural movement, thermally induced movement, and exposure to weather without failing, rattling, leaking, and fastener disengagement.
- B. Fabricate and install roof edge flashing and copings capable of resisting Wind Zone forces required by Code according to recommendations in FMG Loss Prevention Data Sheet 1-49.
- C. Thermal Movements: Provide sheet metal flashing and trim that allow for thermal movements resulting from the following maximum change (range) in ambient and surface temperatures by preventing buckling, opening of joints, hole elongation,

overstressing of components, failure of joint sealants, failure of connections, and other detrimental effects. Provide clips that resist rotation and avoid shear stress as a result of sheet metal and trim thermal movements. Base engineering calculation on surface temperatures of materials due to both solar heat gain and nighttime-sky heat loss.

1. Temperature Change (Range): 120 deg F, ambient; 180 deg F material surfaces.

D. Water Infiltration: Provide sheet metal flashing and trim that do not allow water infiltration to building interior.

1.04 SUBMITTALS

A. Product Data: For each type of product indicated. Include construction details, material descriptions, dimensions of individual components and profiles, and finishes.

B. Shop Drawings: Show layouts of sheet metal flashing and trim, including plans and elevations. Distinguish between shop- and field-assembled work. Include the following:

1. Identify material, thickness, weight, and finish for each item and location in Project.
2. Details for forming sheet metal flashing and trim, including profiles, shapes, seams, and dimensions.
3. Details for fastening, joining, supporting, and anchoring sheet metal flashing and trim, including fasteners, clips, cleats, and attachments to adjoining work.
4. Details of expansion-joint covers, including showing direction of expansion and contraction.

C. Samples for Verification: For each type of exposed finish required, prepared on Samples of size indicated below:

1. Sheet Metal Flashing: 12 inches long. Include fasteners, cleats, clips, closures, and other attachments.
2. Trim: 12 inches long. Include fasteners and other exposed accessories.
3. Accessories: Full-size Sample.

1.05 QUALITY ASSURANCE

A. Sheet Metal Flashing and Trim Standard: Comply with SMACNA's "Architectural Sheet Metal Manual." Conform to dimensions and profiles shown unless more stringent requirements are indicated.

B. Preinstallation Conference: Conduct conference at Project site to comply with requirements in Division 01.

1. Meet with the Owner, Engineer and Owner's insurer if applicable, Installer, and installers whose work interfaces with or affects sheet metal flashing and trim

including installers of roofing materials, roof accessories, unit skylights, and roof-mounted equipment.

2. Review methods and procedures related to sheet metal flashing and trim.
3. Examine substrate conditions for compliance with requirements, including flatness and attachment to structural members.
4. Document proceedings, including corrective measures and actions required, and furnish copy of record to each participant.

1.06 DELIVERY, STORAGE, AND HANDLING

- A. Deliver sheet metal flashing materials and fabrications undamaged. Protect sheet metal flashing and trim materials and fabrications during transportation and handling.
- B. Unload, store, and install sheet metal flashing materials and fabrications in a manner to prevent bending, warping, twisting, and surface damage.
- C. Stack materials on platforms or pallets, covered with suitable weathertight and ventilated covering. Do not store sheet metal flashing and trim materials in contact with other materials that might cause staining, denting, or other surface damage.

1.07 COORDINATION

- A. Coordinate installation of sheet metal flashing and trim with interfacing and adjoining construction to provide a leakproof, secure, and noncorrosive installation.

PART 2 - PRODUCTS

2.01 SHEET METALS

- A. Stainless-Steel Sheet: ASTM A 240/A 240M, Type 304, with No. 2D dull, cold rolled finish, minimum 0.025 thick.

2.02 UNDERLAYMENT MATERIALS

- A. Felts: ASTM D 226, Type II (No. 30), asphalt-saturated organic felt, nonperforated.
- B. Slip Sheet: Rosin-sized paper, minimum 3 lb/100 sq. ft.

2.03 MISCELLANEOUS MATERIALS

- A. General: Provide materials and types of fasteners, solder, welding rods, protective coatings, separators, sealants, and other miscellaneous items as required for complete sheet metal flashing and trim installation.
- B. Fasteners: Wood screws, annular threaded nails, self-tapping screws, self-locking rivets and bolts, and other suitable fasteners designed to withstand design loads.

1. Exposed Fasteners: Heads matching color of sheet metal by means of plastic caps or factory-applied coating.
 2. Fasteners for Flashing and Trim: Blind fasteners or self-drilling screws, gasketed, with hex washer head.
 3. Blind Fasteners: High-strength stainless-steel rivets.
- C. Solder for Stainless Steel: ASTM B 32, Grade Sn60, with acid flux of type recommended by stainless-steel sheet manufacturer.
- D. Sealing Tape: Pressure-sensitive, 100 percent solids, polyisobutylene compound sealing tape with release-paper backing. Provide permanently elastic, nonsag, nontoxic, nonstaining tape.
- E. Elastomeric Sealant: ASTM C 920, elastomeric polyurethane polymer sealant; of type, grade, class, and use classifications required to seal joints in sheet metal flashing and trim and remain watertight.
- F. Bituminous Coating: Cold-applied asphalt mastic, SSPC-Paint 12, compounded for 15-mil dry film thickness per coat. Provide inert-type noncorrosive compound free of asbestos fibers, sulfur components, and other deleterious impurities.
- G. Asphalt Roofing Cement: ASTM D 4586, asbestos free, of consistency required for application.

2.04 FABRICATION, GENERAL

- A. General: Custom fabricate sheet metal flashing and trim to comply with recommendations in SMACNA's "Architectural Sheet Metal Manual" that apply to design, dimensions, metal, and other characteristics of item indicated. Shop fabricate items where practicable. Obtain field measurements for accurate fit before shop fabrication.
- B. Fabricate sheet metal flashing and trim in thickness or weight needed to comply with performance requirements, but not less than that specified for each application and metal.
- C. Fabricate sheet metal flashing and trim without excessive oil canning, buckling, and tool marks and true to line and levels indicated, with exposed edges folded back to form hems.
1. Seams: Fabricate nonmoving seams in accessories with flat-lock seams. Tin edges to be seamed, form seams, and solder.
- D. Sealed Joints: Form nonexpansion but movable joints in metal to accommodate elastomeric sealant to comply with SMACNA recommendations.
- E. Expansion Provisions: Where lapped or bayonet-type expansion provisions in the Work cannot be used, form expansion joints of intermeshing hooked flanges, not less than 1 inch deep, filled with elastomeric sealant concealed within joints.

- F. Conceal fasteners and expansion provisions where possible on exposed-to-view sheet metal flashing and trim, unless otherwise indicated.
- G. Fabricate cleats and attachment devices from same material as accessory being anchored or from compatible, noncorrosive metal.
 - 1. Thickness: As recommended by SMACNA's "Architectural Sheet Metal Manual" for application but not less than thickness of metal being secured.

2.05 FINISHES

- A. Comply with NAAMM's "Metal Finishes Manual for Architectural and Metal Products" for recommendations for applying and designating finishes.
- B. Protect mechanical and painted finishes on exposed surfaces from damage by applying a strippable, temporary protective covering before shipping.
- C. Appearance of Finished Work: Variations in appearance of abutting or adjacent pieces are acceptable if they are within one-half of the range of approved Samples. Noticeable variations in the same piece are not acceptable. Variations in appearance of other components are acceptable if they are within the range of approved Samples and are assembled or installed to minimize contrast.

PART 3 - EXECUTION

3.01 EXAMINATION

- A. Examine substrates, areas, and conditions, with Installer present, to verify actual locations, dimensions and other conditions affecting performance of work.
 - 1. Verify that substrate is sound, dry, smooth, clean, sloped for drainage, and securely anchored.
 - 2. Proceed with installation only after unsatisfactory conditions have been corrected.

3.02 INSTALLATION, GENERAL

- A. General: Anchor sheet metal flashing and trim and other components of the Work securely in place, with provisions for thermal and structural movement. Use fasteners, solder, welding rods, protective coatings, separators, sealants, and other miscellaneous items as required to complete sheet metal flashing and trim system.
 - 1. Torch cutting of sheet metal flashing and trim is not permitted.
- B. Metal Protection: Where dissimilar metals will contact each other or corrosive substrates, protect against galvanic action by painting contact surfaces with bituminous coating or by other permanent separation as recommended by fabricator or manufacturers of dissimilar metals.

1. Coat side of stainless-steel sheet metal flashing and trim with bituminous coating where flashing and trim will contact wood, ferrous metal, or cementitious construction.
 2. Underlayment: Where installing metal flashing directly on cementitious or wood substrates, install a course of felt underlayment and cover with a slip-sheet or install a course of polyethylene underlayment.
 3. Bed flanges in thick coat of asphalt roofing cement where required for waterproof performance.
- C. Install exposed sheet metal flashing and trim without excessive oil canning, buckling, and tool marks.
- D. Install sheet metal flashing and trim true to line and levels indicated. Provide uniform, neat seams with minimum exposure of solder, welds, and elastomeric sealant.
- E. Install sheet metal flashing and trim to fit substrates and to result in watertight performance. Verify shapes and dimensions of surfaces to be covered before fabricating sheet metal.
1. Space cleats not more than 12 inches apart. Anchor each cleat with two fasteners. Bend tabs over fasteners.
- F. Expansion Provisions: Provide for thermal expansion of exposed flashing and trim. Space movement joints at a maximum of 10 feet with no joints allowed within 24 inches of corner or intersection. Where lapped or bayonet-type expansion provisions cannot be used or would not be sufficiently watertight, form expansion joints of intermeshing hooked flanges, not less than 1 inch deep, filled with elastomeric sealant concealed within joints.
- G. Fasteners: Use fasteners of sizes that will penetrate substrate not less than 1-1/4 inches for nails and not less than 3/4 inch for wood screws.
1. Stainless Steel: Use stainless-steel fasteners.
- H. Seal joints with elastomeric sealant as required for watertight construction.
1. Where sealant-filled joints are used, embed hooked flanges of joint members not less than 1 inch into sealant. Form joints to completely conceal sealant. When ambient temperature at time of installation is moderate, between 40 and 70 deg F set joint members for 50 percent movement either way. Adjust setting proportionately for installation at higher ambient temperatures. Do not install sealant-type joints at temperatures below 40 deg F.
 2. Prepare joints and apply sealants to comply with requirements in Section 07920 - JOINT SEALANTS.
- I. Soldered Joints: Clean surfaces to be soldered, removing oils and foreign matter. Prein edges of sheets to be soldered to a width of 1-1/2 inches except where pretinned surface would show in finished Work.

1. Stainless-Steel Soldering: Prein edges of uncoated sheets to be soldered using solder recommended for stainless steel and phosphoric acid flux. Promptly wash off acid flux residue from metal after soldering.
2. Do not use open-flame torches for soldering. Heat surfaces to receive solder and flow solder into joints. Fill joints completely. Completely remove flux and spatter from exposed surfaces.

3.03 CLEANING AND PROTECTION

- A. Clean exposed metal surfaces of substances that interfere with uniform oxidation and weathering.
- B. Clean and neutralize flux materials. Clean off excess solder and sealants.
- C. Remove temporary protective coverings and strippable films as sheet metal flashing and trim are installed. On completion of installation, clean finished surfaces, including removing unused fasteners, metal filings, pop rivet stems, and pieces of flashing. Maintain in a clean condition during construction.
- D. Replace sheet metal flashing and trim that have been damaged or that have deteriorated beyond successful repair by finish touchup or similar minor repair procedures.

END OF SECTION

(THIS PAGE INTENTIONALLY LEFT BLANK)

SECTION 07841

PENETRATION FIRESTOPPING

PART 1 - GENERAL

1.01 GENERAL PROVISIONS

- A. Attention is directed to the CONTRACT AND GENERAL CONDITIONS and all Sections within DIVISION 01 - GENERAL REQUIREMENTS which are hereby made a part of this Section of the Specifications.

1.02 DESCRIPTION OF WORK

- A. Work Included: Provide labor, materials and equipment necessary to complete the work of this Section, including but not limited to the following:
 - 1. Through-penetration firestop systems for penetrations through fire-resistance-rated constructions, including both empty openings and openings containing penetrating items.
- B. Related Work: The following items are not included in this Section and will be performed under the designated Sections:
 - 1. Section 07844 - FIRE-RESISTIVE JOINT SYSTEMS for fire-resistive joint sealers.
 - 2. Section 07920 - JOINT SEALANTS for standard joint sealers.
 - 3. Division 15 - PLUMBING for piping penetrations.
 - 4. Division 15 - HEATING, VENTILATING AND AIR CONDITIONING for duct and piping penetrations.
 - 5. Division 16 - ELECTRICAL for cable and conduit penetrations.

1.03 COORDINATION

- A. Jobsite conditions of each through-penetration firestop system must meet all details of the UL-Classified System selected. If jobsite conditions do not match any UL-classified systems, contact firestop manufacturer for alternative systems or Engineer Judgment Drawings.
- B. Coordinate work with other trades to assure that penetration-opening sizes are appropriate for penetrant locations.
- C. Verify that the schedule is current at the time of construction, and that each referenced system is suitable for the intended application.

1.04 PERFORMANCE REQUIREMENTS

- A. General: For penetrations through fire-resistance-rated constructions, including both empty openings and openings containing penetrating items, provide through-penetration firestop systems that are produced and installed to resist spread of fire according to requirements indicated, resist passage of smoke and other gases, and maintain original fire-resistance rating of construction penetrated.
- B. Penetrations in Fire-Resistance-Rated Walls: Provide penetration firestopping with ratings determined per ASTM E 814 or UL 1479, based on testing at a positive pressure differential of 0.01-inch wg (2.49 Pa).
 - 1. Fire-resistance-rated walls include fire walls, fire-barrier walls, smoke-barrier walls and fire partitions.
 - 2. F-Rating: Not less than the fire-resistance rating of constructions penetrated.
- C. Penetrations in Horizontal Assemblies: Provide penetration firestopping with ratings determined per ASTM E 814 or UL 1479, based on testing at a positive pressure differential of 0.01-inch wg (2.49 Pa).
 - 1. Horizontal assemblies include floors, floor/ceiling assemblies and ceiling membranes of roof/ceiling assemblies.
 - 2. F-Rating: At least 1 hour, but not less than the fire-resistance rating of constructions penetrated.
 - 3. T-Rating: At least 1 hour, but not less than the fire-resistance rating of constructions penetrated except for floor penetrations within the cavity of a wall.
- D. Penetrations in Smoke Barriers: Provide penetration firestopping with ratings determined per UL 1479.
 - 1. L-Rating: Not exceeding 5.0 cfm/sq. ft. (0.025 cu. m/s per sq. m) of penetration opening at 0.30-inch wg (74.7 Pa) at both ambient and elevated temperatures.
- E. Exposed Penetration Firestopping:
 - 1. Provide products with flame-spread and smoke-developed indexes of less than 25 and 450, respectively, as determined per ASTM E 84.
 - 2. For through-penetration firestop systems exposed to view, traffic, moisture, and physical damage, provide products that, after curing, do not deteriorate when exposed to these conditions both during and after construction.
 - a. For piping penetrations for plumbing and wet-pipe sprinkler systems, provide moisture-resistant through-penetration firestop systems demonstrating no evidence of water leakage when tested according to UL 1479.
 - b. For floor penetrations with annular spaces exceeding 4 inches in width and exposed to possible loading and traffic, provide firestop systems capable of supporting floor loads involved, either by installing floor plates or by other means.

- F. For penetrations involving insulated piping, provide through-penetration firestop systems not requiring removal of insulation.

1.05 SUBMITTALS

- A. Product Data: For each type of product indicated.
- B. Shop Drawings: For each through-penetration firestop system, show each type of construction condition penetrated, relationships to adjoining construction, and type of penetrating item. Include firestop design designation of qualified testing and inspecting agency that evidences compliance with requirements for each condition indicated.
 - 1. Submit documentation, including illustrations, from a qualified testing and inspecting agency that is applicable to each through-penetration firestop system configuration for construction and penetrating items.
- C. Through-Penetration Firestop System Schedule: Indicate locations of each through-penetration firestop system, along with the following information:
 - 1. Types of penetrating items.
 - 2. Types of constructions penetrated, including fire-resistance ratings and, where applicable, thicknesses of construction penetrated.
 - 3. Through-penetration firestop systems for each location identified by firestop design designation of qualified testing and inspecting agency.
- D. Qualification Data: For Installer.

1.06 QUALITY ASSURANCE

- A. Installer Qualifications: Either a firm that has been approved by FMG according to FMG 4991, "Approval of Firestop Contractors" or a firm experienced in installing through-penetration firestop systems similar in material, design, and extent to that indicated for this Project, whose work has resulted in construction of a minimum of five projects with a record of successful performance. Qualifications include having the necessary experience, staff, and training to install manufacturer's products per specified requirements.
- B. Source Limitations: Obtain through-penetration firestop systems, for each kind of penetration and construction condition indicated, through one source from a single manufacturer.
- C. Fire-Test-Response Characteristics: Provide through-penetration firestop systems that comply with the following requirements and those specified in Part 1 "Performance Requirements" Article:
 - 1. Firestopping tests are performed by a qualified testing and inspecting agency. A qualified testing and inspecting agency is UL or another agency performing

testing and follow-up inspection services for firestop systems acceptable to authorities having jurisdiction.

2. Through-penetration firestop systems are identical to those tested per testing standard referenced in "Part 1 Performance Requirements" Article. Provide rated systems complying with the following requirements:
 - a. Through-penetration firestop system products bear classification marking of qualified testing and inspecting agency.
 - b. Through-penetration firestop systems correspond to those indicated by reference to through-penetration firestop system designations listed in the UL "Fire Resistance Directory."

- D. Preinstallation Conference: Conduct conference at Project site to comply with requirements in Division 01.

1.07 DELIVERY, STORAGE, AND HANDLING

- A. Deliver through-penetration firestop system products to Project site in original, unopened containers or packages with intact and legible manufacturers' labels identifying product and manufacturer, date of manufacture, lot number, shelf life if applicable, qualified testing and inspecting agency's classification marking applicable to Project, curing time, and mixing instructions for multicomponent materials.
- B. Store and handle materials for through-penetration firestop systems to prevent their deterioration or damage due to moisture, temperature changes, contaminants, or other causes.

1.08 PROJECT CONDITIONS

- A. Environmental Limitations: Do not install through-penetration firestop systems when ambient or substrate temperatures are outside limits permitted by through-penetration firestop system manufacturers or when substrates are wet due to rain, frost, condensation, or other causes.
- B. Ventilate through-penetration firestop systems per manufacturer's written instructions by natural means or, where this is inadequate, forced-air circulation.

1.09 COORDINATION

- A. Coordinate construction of openings and penetrating items to ensure that through-penetration firestop systems are installed according to specified requirements.
- B. Coordinate sizing of sleeves, openings, core-drilled holes, or cut openings to accommodate through-penetration firestop systems.
- C. Do not cover up through-penetration firestop system installations that will become concealed behind other construction until each installation has been examined building inspector, if required by authorities having jurisdiction.

PART 2 - PRODUCTS

2.01 MANUFACTURERS

- A. Available Products: Subject to compliance with requirements, through-penetration firestop systems that may be incorporated into the Work include, but are not limited to the following:
1. Hilti, Inc.
 2. BioFireshield; RectorSeal Corporation.
 3. Specified Technologies, Inc. (STI).
 4. 3M; Fire Protection Products Division.

2.02 FIRESTOPPING MATERIALS

- A. VOC Content: Penetration firestopping sealants and sealant primers shall comply with the following limits for VOC content when calculated according to 40 CFR 59, Subpart D (EPA Method 24):
1. Sealants: 250 g/L.
 2. Sealant Primers for Nonporous Substrates: 250 g/L.
 3. Sealant Primers for Porous Substrates: 775 g/L.
- B. Compatibility: Provide through-penetration firestop systems that are compatible with one another; with the substrates forming openings; and with the items, if any, penetrating through-penetration firestop systems, under conditions of service and application, as demonstrated by through-penetration firestop system manufacturer based on testing and field experience.
- C. Materials: Provide through-penetration firestop systems containing primary materials and fill materials which are part of the tested assemblies indicated in the approved Through-Penetration Firestop System Schedule submittal. Fill materials are those referred to in directories of referenced testing and inspecting agencies as "fill," "void," or "cavity" materials.
- D. Accessories: Provide components for each through-penetration firestop system that are needed to install fill materials and to comply with Part 1 "Performance Requirements" Article. Use only components specified by through-penetration firestop system manufacturer and approved by qualified testing and inspecting agency for firestop systems indicated

2.03 MIXING

- A. For those products requiring mixing before application, comply with through-penetration firestop system manufacturer's written instructions for accurate proportioning of materials, water (if required), type of mixing equipment, selection of mixer speeds, mixing containers, mixing time, and other items or procedures needed to

produce products of uniform quality with optimum performance characteristics for application indicated.

PART 3 - EXECUTION

3.01 EXAMINATION

- A. Examine substrates and conditions, with Installer present, for compliance with requirements for opening configurations, penetrating items, substrates, and other conditions affecting performance of work. Proceed with installation only after unsatisfactory conditions have been corrected.

3.02 PREPARATION

- A. Surface Cleaning: Clean out openings immediately before installing through-penetration firestop systems to comply with firestop system manufacturer's written instructions and with the following requirements:
 - 1. Remove from surfaces of opening substrates and from penetrating items foreign materials that could interfere with adhesion of through-penetration firestop systems.
 - 2. Clean opening substrates and penetrating items to produce clean, sound surfaces capable of developing optimum bond with through-penetration firestop systems. Remove loose particles remaining from cleaning operation.
 - 3. Remove laitance and form-release agents from concrete.
- B. Priming: Prime substrates where recommended in writing by through-penetration firestop system manufacturer using that manufacturer's recommended products and methods. Confine primers to areas of bond; do not allow spillage and migration onto exposed surfaces.
- C. Masking Tape: Use masking tape to prevent through-penetration firestop systems from contacting adjoining surfaces that will remain exposed on completion of Work and that would otherwise be permanently stained or damaged by such contact or by cleaning methods used to remove smears from firestop system materials. Remove tape as soon as possible without disturbing firestop system's seal with substrates.

3.03 THROUGH-PENETRATION FIRESTOP SYSTEM INSTALLATION

- A. General: Install through-penetration firestop systems to comply with Part 1 "Performance Requirements" Article and with firestop system manufacturer's written installation instructions and published drawings for products and applications indicated.
- B. Install forming/damming/backing materials and other accessories of types required to support fill materials during their application and in the position needed to produce cross-sectional shapes and depths required to achieve fire ratings indicated.

- C. Install fill materials for firestop systems by proven techniques to produce the following results:
 - 1. Fill voids and cavities formed by openings, forming materials, accessories, and penetrating items as required to achieve fire-resistance ratings indicated.
 - 2. Apply materials so they contact and adhere to substrates formed by openings and penetrating items.
 - 3. For fill materials that will remain exposed after completing Work, finish to produce smooth, uniform surfaces that are flush with adjoining finishes.

3.04 FIELD QUALITY CONTROL

- A. Inspecting Agency: Engage a qualified, independent inspecting agency to inspect through-penetration firestops. Independent inspecting agency shall comply with ASTM E 2174 requirements including those related to qualifications, conducting inspections, and preparing test reports.
- B. Where deficiencies are found, repair or replace through-penetration firestop systems so they comply with requirements.
- C. Proceed with enclosing through-penetration firestop systems with other construction only after inspection reports are issued and firestop installations comply with requirements.

3.05 CLEANING AND PROTECTING

- A. Clean off excess fill materials adjacent to openings as Work progresses by methods and with cleaning materials that are approved in writing by through-penetration firestop system manufacturers and that do not damage materials in which openings occur.
- B. Provide final protection and maintain conditions during and after installation that ensure that through-penetration firestop systems are without damage or deterioration at time of Substantial Completion. If, despite such protection, damage or deterioration occurs, cut out and remove damaged or deteriorated through-penetration firestop systems immediately and install new materials to produce systems complying with specified requirements.

END OF SECTION

(THIS PAGE INTENTIONALLY LEFT BLANK)

SECTION 07844

FIRE-RESISTIVE JOINT SYSTEMS

PART 1 - GENERAL

1.01 GENERAL PROVISIONS

- A. Attention is directed to the CONTRACT AND GENERAL CONDITIONS and all Sections within DIVISION 01 - GENERAL REQUIREMENTS which are hereby made a part of this Section of the Specifications.

1.02 DESCRIPTION OF WORK

- A. Work Included: Provide labor, materials and equipment necessary to complete the Work of this Section, including but not limited to fire-resistive joint systems for the following:
 - 1. Floor-to-floor joints.
 - 2. Floor-to-wall joints.
 - 3. Head-of-wall joints.
 - 4. Wall-to-wall joints.
 - 5. Perimeter fire-resistive joint systems consisting of floor-to-wall joints between perimeter edge of fire-resistance-rated floor assemblies and exterior curtain walls.
- B. Related Work: The following items are not included in this Section and will be performed under the designated Sections:
 - 1. Section 07841 - PENETRATION FIRESTOPPING for firestopping.
 - 2. Section 07920 - JOINT SEALANTS for standard joint sealers.
 - 3. Division 15 - PLUMBING for piping penetrations.
 - 4. Division 15 - HEATING, VENTILATING AND AIR CONDITIONING for duct and piping penetrations.
 - 5. Division 16 - ELECTRICAL for cable and conduit penetrations.

1.03 PERFORMANCE REQUIREMENTS

- A. General: Provide fire-resistive joint systems that are produced and installed to resist spread of fire according to requirements indicated, resist passage of smoke and other gases, and maintain original fire-resistance rating of assembly in which fire-resistive joint systems are installed.
- B. For fire-resistive systems exposed to view, provide products with flame-spread and smoke-developed indexes of less than 25 and 450, respectively, as determined per ASTM E 84.

1.04 SUBMITTALS

- A. Product Data: For each type of product indicated.
- B. Shop Drawings: For each fire-resistive joint system, show each kind of construction condition in which joints are installed; also show relationships to adjoining construction. Include fire-resistive joint system design designation of testing and inspecting agency acceptable to authorities having jurisdiction that demonstrates compliance with requirements for each condition indicated.
 - 1. Submit documentation, including illustrations, from a qualified testing and inspecting agency that is applicable to each fire-resistive joint system configuration for construction and penetrating items.
- C. Fire-Resistive Joint Systems Schedule: For each fire-resistive joint system. Include location and design designation of qualified testing agency.
 - 1. Where Project conditions require modification to a qualified testing agency's illustration for a particular fire-resistive joint system condition, submit illustration, with modifications marked, approved by fire-resistive joint system manufacturer's fire-protection engineer as an engineering judgment or equivalent fire-resistance-rated assembly.
- D. Product Certificates: For each type of fire-resistive joint system, signed by product manufacturer.
- E. Qualification Data: For Installer.
- F. Field quality-control test reports.
- G. Research/Evaluation Reports: For each type of fire-resistive joint system.

1.05 QUALITY ASSURANCE

- A. Installer Qualifications: A firm experienced in installing through-penetration fire stop systems similar in material, design, and extent to that indicated for this Project, whose work has resulted in construction of a minimum of five projects with a record of successful performance. Qualifications include having the necessary experience, staff, and training to install manufacturer's products per specified requirements. Evidence of FMG 4991 approval is acceptable for installer qualifications, but not mandatory.
- B. Installation Responsibility: Assign installation of through-penetration firestop systems and fire-resistive joint systems in Project to a single qualified installer.
- C. Source Limitations: Obtain fire-resistive joint systems, for each kind of joint and construction condition indicated, through one source from a single manufacturer.

- D. Fire-Test-Response Characteristics: Provide fire-resistive joint systems that comply with the following requirements and those specified in Part 1 "Performance Requirements" Article:
1. Fire-resistance tests are performed by a qualified testing and inspecting agency. A qualified testing and inspecting agency is UL or another agency performing testing and follow-up inspection services for fire-resistive joint systems acceptable to authorities having jurisdiction.
 2. Fire-resistive joint systems are identical to those tested per methods indicated in Part 1 "Performance Requirements" Article and comply with the following:
 - a. Fire-resistive joint system products bear classification marking of qualified testing and inspecting agency.
 - b. Fire-resistive joint systems correspond to those indicated by referencing system designations of the qualified testing and inspecting agency.

1.06 DELIVERY, STORAGE, AND HANDLING

- A. Deliver fire-resistive joint system products to Project site in original, unopened containers or packages with qualified testing and inspecting agency's classification marking applicable to Project and with intact and legible manufacturers' labels identifying product and manufacturer, date of manufacture, lot number, shelf life, curing time, and mixing instructions for multicomponent materials.
- B. Store and handle materials for fire-resistive joint systems to prevent their deterioration or damage due to moisture, temperature changes, contaminants, or other causes.

1.07 PROJECT CONDITIONS

- A. Environmental Limitations: Do not install fire-resistive joint systems when ambient or substrate temperatures are outside limits permitted by fire-resistive joint system manufacturers or when substrates are wet due to rain, frost, condensation, or other causes.
- B. Ventilate fire-resistive joint systems per manufacturer's written instructions by natural means or, if this is inadequate, forced-air circulation.

1.08 COORDINATION

- A. Coordinate construction of joints to ensure that fire-resistive joint systems are installed according to specified requirements.
- B. Coordinate sizing of joints to accommodate fire-resistive joint systems.
- C. Do not cover up through-penetration firestop system installations that will become concealed behind other construction until each installation has been examined building inspector, if required by authorities having jurisdiction.

PART 2 - PRODUCTS

2.01 MANUFACTURERS

- A. Available Products: Subject to compliance with requirements, fire-resistive joint systems that may be incorporated into the Work include, but are not limited to the following:
1. Hilti, Inc.
 2. BioFireshield; RectorSeal Corporation.
 3. Specified Technologies, Inc. (STI).
 4. 3M; Fire Protection Products Division.

2.02 FIRE-RESISTIVE JOINT SYSTEMS

- A. VOC Content: Fire-resistive joint system sealants shall comply with the following limits for VOC content when calculated according to 40 CFR 59, Subpart D (EPA Method 24):
1. Architectural Sealants: 250 g/L.
 2. Sealant Primers for Nonporous Substrates: 250 g/L.
 3. Sealant Primers for Porous Substrates: 775 g/L.
- B. General: Where required, provide fire-resistive joint systems that are produced and installed to resist spread of fire according to requirements indicated, resist passage of smoke and other gases, and maintain original fire-resistance rating of assemblies in or between which fire-resistive joint systems are installed. Fire-resistive joint systems shall accommodate building movements without impairing their ability to resist the passage of fire and hot gases.
- C. Joints in or between Fire-Resistance-Rated Construction: Provide fire-resistive joint systems with ratings determined per ASTM E 1966 or UL 2079.
- D. Joints at Exterior Curtain-Wall/Floor Intersections: Provide fire-resistive joint systems with rating determined by ASTM E 119 based on testing at a positive pressure differential of 0.01-inch wg (2.49 Pa) or ASTM E 2307.
1. Fire-Resistance Rating: Equal to or exceeding the fire-resistance rating of the floor assembly.
- E. Joints in Smoke Barriers: Provide fire-resistive joint systems with ratings determined per UL 2079.
1. L-Rating: Not exceeding 5.0 cfm/ft (0.00775 cu. m/s x m) of joint at 0.30 inch wg (74.7 Pa) at both ambient and elevated temperatures.

- F. Compatibility: Provide fire-resistive joint systems that are compatible with joint substrates, under conditions of service and application, as demonstrated by fire-resistive joint system manufacturer based on testing and field experience.
- G. Accessories: Provide components of fire-resistive joint systems, including primers and forming materials, that are needed to install fill materials and to comply with Part 1 "Performance Requirements" Article. Use only components specified by fire-resistive joint system manufacturer and approved by the qualified testing and inspecting agency for systems indicated.

PART 3 - EXECUTION

3.01 EXAMINATION

- A. Examine substrates and conditions, with Installer present, for compliance with requirements for joint configurations, substrates, and other conditions affecting performance of work.
 - 1. Proceed with installation only after unsatisfactory conditions have been corrected.

3.02 PREPARATION

- A. Surface Cleaning: Clean joints immediately before installing fire-resistive joint systems to comply with fire-resistive joint system manufacturer's written instructions and the following requirements:
 - 1. Remove from surfaces of joint substrates foreign materials that could interfere with adhesion of fill materials.
 - 2. Clean joint substrates to produce clean, sound surfaces capable of developing optimum bond with fill materials. Remove loose particles remaining from cleaning operation.
 - 3. Remove laitance and form-release agents from concrete.
- B. Priming: Prime substrates where recommended in writing by fire-resistive joint system manufacturer using that manufacturer's recommended products and methods. Confine primers to areas of bond; do not allow spillage and migration onto exposed surfaces.
- C. Masking Tape: Use masking tape to prevent fill materials of fire-resistive joint system from contacting adjoining surfaces that will remain exposed on completion of Work and that would otherwise be permanently stained or damaged by such contact or by cleaning methods used to remove smears from fire-resistive joint system materials. Remove tape as soon as possible without disturbing fire-resistive joint system's seal with substrates or damaging adjoining surfaces.

3.03 INSTALLATION

- A. General: Install fire-resistive joint systems to comply with Part 1 "Performance Requirements" Article and fire-resistive joint system manufacturer's written installation instructions for products and applications indicated.
- B. Install forming/packing/backing materials and other accessories of types required to support fill materials during their application and in position needed to produce cross-sectional shapes and depths required to achieve fire ratings indicated.
- C. Install fill materials for fire-resistive joint systems by proven techniques to produce the following results:
 - 1. Fill voids and cavities formed by openings and forming/packing/backing materials as required to achieve fire-resistance ratings indicated.
 - 2. Apply fill materials so they contact and adhere to substrates formed by joints.
 - 3. For fill materials that will remain exposed after completing Work, finish to produce smooth, uniform surfaces that are flush with adjoining finishes.

3.04 FIELD QUALITY CONTROL

- A. Inspecting Agency: Engage a qualified independent inspecting agency to inspect fire-resistive joint systems and prepare inspection reports.
- B. Testing Services: Inspecting of completed installations of fire-resistive joint systems shall take place in successive stages as installation of fire-resistive joint systems proceeds. Do not proceed with installation of joint systems for the next area until inspecting agency determines completed work shows compliance with requirements.
 - 1. Inspecting agency shall state in each report whether inspected fire-resistive joint systems comply with or deviate from requirements.
- C. Remove and replace fire-resistive joint systems where inspections indicate that they do not comply with specified requirements.
- D. Additional inspecting, at Contractor's expense, will be performed to determine compliance of replaced or additional work with specified requirements.
- E. Proceed with enclosing fire-resistive joint systems with other construction only after inspection reports are issued and fire-resistive joint systems comply with requirements.

3.05 CLEANING AND PROTECTING

- A. Clean off excess fill materials adjacent to joints as Work progresses by methods and with cleaning materials that are approved in writing by fire-resistive joint system manufacturers and that do not damage materials in which openings occur.

- B. Provide final protection and maintain conditions during and after installation that ensure fire-resistive joint systems are without damage or deterioration at time of Substantial Completion. If damage or deterioration occurs despite such protection, cut out and remove damaged or deteriorated fire-resistive joint systems immediately and install new materials to produce fire-resistive joint systems complying with specified requirements.

END OF SECTION

(THIS PAGE INTENTIONALLY LEFT BLANK)

SECTION 07920
JOINT SEALANTS

PART 1 - GENERAL

1.01 GENERAL PROVISIONS

- A. Attention is directed to the CONTRACT AND GENERAL CONDITIONS and all Sections within DIVISION 01 - GENERAL REQUIREMENTS which are hereby made a part of this Section of the Specifications.

1.02 DESCRIPTION OF WORK

- A. Work Included: Provide labor, materials and equipment necessary to complete the work of this Section, including but not limited to the following:
 - 1. Joint sealants and fillers.
- B. This Section includes joint sealants for the applications specified with the products in this Section and as indicated on Drawings.
- C. Related Work: The following items are not included in this Section and are specified under the designated Sections:
 - 1. Section 04200 - UNIT MASONRY and Section 04220 - REINFORCED UNIT MASONRY for masonry control and expansion joint fillers and gaskets.
 - 2. Section 08800 - GLAZING for glazing sealants.
 - 3. Section 09211 - GYPSUM BOARD ASSEMBLIES for sealing perimeter joints of gypsum board partitions to reduce sound transmission.

1.03 PERFORMANCE REQUIREMENTS

- A. Provide elastomeric joint sealants that establish and maintain watertight and airtight continuous joint seals without staining or deteriorating joint substrates.
- B. Provide joint sealants for interior applications that establish and maintain airtight and water-resistant continuous joint seals without staining or deteriorating joint substrates.

1.04 SUBMITTALS

- A. Product Data: For each joint-sealant product indicated.

- B. Samples for Verification: For each type and color of joint sealant required, provide Samples with joint sealants in 1/2-inch- wide joints formed between two 6-inch- long strips of material matching the appearance of exposed surfaces adjacent to joint sealants.
- C. Qualification Data: For Installer.
- D. Preconstruction Field Test Reports: Indicate which sealants and joint preparation methods resulted in optimum adhesion to joint substrates based on preconstruction testing specified in "Quality Assurance" Article.
- E. Compatibility and Adhesion Test Reports: From sealant manufacturer, indicating the following:
 - 1. Materials forming joint substrates and joint-sealant backings have been tested for compatibility and adhesion with joint sealants.
 - 2. Interpretation of test results and written recommendations for primers and substrate preparation needed for adhesion.
- F. Field Test Report Log: For each elastomeric sealant application.
- G. Product Test Reports: Based on comprehensive testing of product formulations performed by a qualified testing agency, indicating that sealants comply with requirements.

1.05 QUALITY ASSURANCE

- A. Installer Qualifications: Manufacturer's authorized Installer who is approved or licensed for installation of elastomeric sealants required for this Project.
- B. Source Limitations: Obtain each type of joint sealant through one source from a single manufacturer.
- C. Preconstruction Compatibility and Adhesion Testing: Submit to joint-sealant manufacturers, for testing indicated below, samples of materials that will contact or affect joint sealants.
 - 1. Use manufacturer's standard test method to determine whether priming and other specific joint preparation techniques are required to obtain rapid, optimum adhesion of joint sealants to joint substrates.
 - 2. Schedule sufficient time for testing and analyzing results to prevent delaying the Work.
 - 3. For materials failing tests, obtain joint-sealant manufacturer's written instructions for corrective measures including use of specially formulated primers.
 - 4. Testing will not be required if joint-sealant manufacturers submit joint preparation data that are based on previous testing of current sealant products for adhesion to, and compatibility with, joint substrates and other materials matching those submitted.

- D. Preconstruction Field-Adhesion Testing: Before installing elastomeric sealants, field test their adhesion to Project joint substrates as follows:
1. Locate test joints where indicated on Project or, if not indicated, as directed by Engineer.
 2. Conduct field tests for each application indicated below:
 - a. Each type of elastomeric sealant and joint substrate indicated.
 - b. Each type of nonelastomeric sealant and joint substrate indicated.
 3. Notify Engineer seven days in advance of dates and times when test joints will be erected.
 - a. Test Method: Test joint sealants according to Method A, Field-Applied Sealant Joint Hand Pull Tab, in Appendix X1 in ASTM C 1193.
 - 1) For joints with dissimilar substrates, verify adhesion to each substrate separately; extend cut along one side, verifying adhesion to opposite side. Repeat procedure for opposite side.
 4. Report whether sealant in joint connected to pulled-out portion failed to adhere to joint substrates or tore cohesively. Include data on pull distance used to test each type of product and joint substrate. For sealants that fail adhesively, retest until satisfactory adhesion is obtained.
 5. Evaluation of Preconstruction Field-Adhesion-Test Results: Sealants not evidencing adhesive failure from testing, in absence of other indications of noncompliance with requirements, will be considered satisfactory. Do not use sealants that fail to adhere to joint substrates during testing.
- E. Preinstallation Conference: Conduct conference at Project site to comply with requirements in Division 01.

1.06 PROJECT CONDITIONS

- A. Do not proceed with installation of joint sealants under the following conditions:
1. When ambient and substrate temperature conditions are outside limits permitted by joint-sealant manufacturer or are below 40 deg F
 2. When joint substrates are wet.
 3. Where joint widths are less than those allowed by joint-sealant manufacturer for applications indicated.
 4. Contaminants capable of interfering with adhesion have not yet been removed from joint substrates.

1.07 WARRANTY

- A. Special Installer's Warranty: Installer's standard form in which Installer agrees to repair or replace elastomeric joint sealants that do not comply with performance and other requirements specified in this Section within specified warranty period.
 - 1. Warranty Period: Two years from date of Substantial Completion.
- B. Special Manufacturer's Warranty: Manufacturer's standard form in which elastomeric sealant manufacturer agrees to furnish elastomeric joint sealants to repair or replace those that do not comply with performance and other requirements specified in this Section within specified warranty period.
 - 1. Warranty Period: Five years from date of Substantial Completion.
- C. Special warranties specified in this Article exclude deterioration or failure of elastomeric joint sealants from the following:
 - 1. Movement of the structure resulting in stresses on the sealant exceeding sealant manufacturer's written specifications for sealant elongation and compression caused by structural settlement or errors attributable to design or construction.
 - 2. Disintegration of joint substrates from natural causes exceeding design specifications.
 - 3. Mechanical damage caused by individuals, tools, or other outside agents.
 - 4. Changes in sealant appearance caused by accumulation of dirt or other atmospheric contaminants.

PART 2 - PRODUCTS

2.01 MATERIALS, GENERAL

- A. Compatibility: Provide joint sealants, backings, and other related materials that are compatible with one another and with joint substrates under conditions of service and application, as demonstrated by sealant manufacturer, based on testing and field experience.
- B. VOC Content of Interior Sealants: Provide interior sealants and sealant primers that comply with the following limits for VOC content when calculated according to 40 CFR 59, Subpart D (EPA Method 24):
 - 1. Architectural Sealants: 250 g/L.
 - 2. Sealant Primers for Nonporous Substrates: 250 g/L.
 - 3. Sealant Primers for Porous Substrates: 775 g/L.
- C. Colors of Exposed Joint Sealants: Provide colors as selected by the Engineer from manufacturer's full range of standard and custom colors; maximum of five colors, three standard colors and two custom colors.

2.02 JOINT SEALANTS

- A. **Elastomeric Sealants:** Comply with ASTM C 920 and other requirements indicated for each liquid-applied chemically curing sealant specified, including those referencing ASTM C 920 classifications for type, grade, class, and uses related to exposure and joint substrates.
- B. **Stain-Test-Response Characteristics:** Elastomeric sealants shall be nonstaining to porous substrates. Provide products that have undergone testing according to ASTM C 1248 and have not stained porous joint substrates indicated for Project.
- C. **Suitability for Contact with Food:** Where elastomeric sealants are indicated for joints that will come in repeated contact with food, provide products that comply with 21 CFR 177.2600.
- D. **Single-Component Neutral-Curing Silicone Sealant:**
 - 1. **Available Products:** Subject to compliance with requirements, products that may be incorporated into the Work include, but are not limited to, the following:
 - a. Dow Corning Corporation; 790.
 - b. GE Silicones; SilPruf LM SCS2700.
 - c. Tremco Inc.; Spectrem 1.
 - d. Pecora Corporation; 864.
 - e. Bondaflex Technologies; Sil 290
 - 2. **Extent of Use:** Joints in exterior vertical and soffit surfaces.
- E. **Multicomponent Pourable Urethane Sealant:**
 - 1. **Available Products:** Subject to compliance with requirements, products that may be incorporated into the Work include, but are not limited to, the following:
 - a. Bostik Findley; Chem-Calk 550.
 - b. Meadows, W. R., Inc.; POURTHANE.
 - c. Pecora Corporation; Urexpan NR-200.
 - d. Tremco Inc.; THC-901.
 - e. Bondaflex Technologies; PUR 2 SL
 - 2. **Extent of Use:** Joints in exterior horizontal surfaces.
- F. **Single-Component Mildew-Resistant Acid-Curing Silicone Sealant:**
 - 1. **Available Products:** Subject to compliance with requirements, products that may be incorporated into the Work include, but are not limited to, the following:
 - a. Dow Corning Corporation; 786 Mildew Resistant.
 - b. GE Silicones; Sanitary SCS1700.

- c. Tremco Inc.; Tremsil 200.
 - d. Bondaflex Technologies; Sil 100 WF
 - 2. Extent of Use: Sanitary joints at toilet fixtures.
- G. Latex Sealant: Comply with ASTM C 834, Type P, Grade NF.
- 1. Available Products: Subject to compliance with requirements, products that may be incorporated into the Work include, but are not limited to, the following:
 - a. Bostik Findley; Chem-Calk 600.
 - b. Pecora Corporation; AC-20+.
 - c. Sonneborn, BASF Building Systems; Sonolac.
 - d. Tremco Inc.; Tremflex 834.
 - e. May National Bondaflex Sil-A 700
 - 2. Extent of Use: Non-moving joints at interior locations.

2.03 JOINT-SEALANT BACKING

- A. General: Provide sealant backings of material and type that are nonstaining; are compatible with joint substrates, sealants, primers, and other joint fillers; and are approved for applications indicated by sealant manufacturer based on field experience and laboratory testing.
- B. Elastomeric Tubing Sealant Backings: Neoprene, butyl, EPDM, or silicone tubing complying with ASTM D 1056, nonabsorbent to water and gas, and capable of remaining resilient at temperatures down to minus 26 deg F. Provide products with low compression set and of size and shape to provide a secondary seal, to control sealant depth, and to otherwise contribute to optimum sealant performance.
- C. Bond-Breaker Tape: Polyethylene tape or other plastic tape recommended by sealant manufacturer for preventing sealant from adhering to rigid, inflexible joint-filler materials or joint surfaces at back of joint where such adhesion would result in sealant failure. Provide self-adhesive tape where applicable.

2.04 MISCELLANEOUS MATERIALS

- A. Primer: Material recommended by joint-sealant manufacturer where required for adhesion of sealant to joint substrates indicated, as determined from preconstruction joint-sealant-substrate tests and field tests.
- B. Cleaners for Nonporous Surfaces: Chemical cleaners acceptable to manufacturers of sealants and sealant backing materials, free of oily residues or other substances capable of staining or harming joint substrates and adjacent nonporous surfaces in any way, and formulated to promote optimum adhesion of sealants to joint substrates.

- C. Masking Tape: Nonstaining, nonabsorbent material compatible with joint sealants and surfaces adjacent to joints.

PART 3 - EXECUTION

3.01 EXAMINATION

- A. Examine joints indicated to receive joint sealants, with Installer present, for compliance with requirements for joint configuration, installation tolerances, and other conditions affecting joint-sealant performance.
- B. Proceed with installation only after unsatisfactory conditions have been corrected.

3.02 PREPARATION

- A. Surface Cleaning of Joints: Clean out joints immediately before installing joint sealants to comply with joint-sealant manufacturer's written instructions and the following requirements:
 - 1. Remove all foreign material from joint substrates that could interfere with adhesion of joint sealant, including dust, paints (except for permanent, protective coatings tested and approved for sealant adhesion and compatibility by sealant manufacturer), old joint sealants, oil, grease, waterproofing, water repellents, water, surface dirt, and frost.
 - 2. Clean porous joint substrate surfaces by brushing, grinding, blast cleaning, mechanical abrading, or a combination of these methods to produce a clean, sound substrate capable of developing optimum bond with joint sealants. Remove loose particles remaining after cleaning operations above by vacuuming or blowing out joints with oil-free compressed air. Porous joint substrates include concrete, masonry and unglazed surfaces of ceramic tile.
 - 3. Remove laitance and form-release agents from concrete.
 - 4. Clean nonporous surfaces with chemical cleaners or other means that do not stain, harm substrates, or leave residues capable of interfering with adhesion of joint sealants. Nonporous joint substrates include the following metal, glass, porcelain enamel and glazed surfaces of ceramic tile.
- B. Joint Priming: Prime joint substrates, where recommended in writing by joint-sealant manufacturer, based on preconstruction joint-sealant-substrate tests or prior experience. Apply primer to comply with joint-sealant manufacturer's written instructions. Confine primers to areas of joint-sealant bond; do not allow spillage or migration onto adjoining surfaces.
- C. Masking Tape: Use masking tape where required to prevent contact of sealant with adjoining surfaces that otherwise would be permanently stained or damaged by such contact or by cleaning methods required to remove sealant smears. Remove tape immediately after tooling without disturbing joint seal.

3.03 INSTALLATION OF JOINT SEALANTS

- A. General: Comply with joint-sealant manufacturer's written installation instructions for products and applications indicated, unless more stringent requirements apply.
- B. Sealant Installation Standard: Comply with recommendations in ASTM C 1193 for use of joint sealants as applicable to materials, applications, and conditions indicated.
- C. Install sealant backings of type indicated to support sealants during application and at position required to produce cross-sectional shapes and depths of installed sealants relative to joint widths that allow optimum sealant movement capability.
 - 1. Do not leave gaps between ends of sealant backings.
 - 2. Do not stretch, twist, puncture, or tear sealant backings.
 - 3. Remove absorbent sealant backings that have become wet before sealant application and replace them with dry materials.
- D. Install bond-breaker tape behind sealants where sealant backings are not used between sealants and backs of joints.
- E. Install sealants using proven techniques that comply with the following and at the same time backings are installed:
 - 1. Place sealants so they directly contact and fully wet joint substrates.
 - 2. Completely fill recesses in each joint configuration.
 - 3. Produce uniform, cross-sectional shapes and depths relative to joint widths that allow optimum sealant movement capability.
- F. Tooling of Nonsag Sealants: Immediately after sealant application and before skinning or curing begins, tool sealants according to requirements specified below to form smooth, uniform beads of configuration indicated; to eliminate air pockets; and to ensure contact and adhesion of sealant with sides of joint.
 - 1. Remove excess sealant from surfaces adjacent to joints.
 - 2. Use tooling agents that are approved in writing by sealant manufacturer and that do not discolor sealants or adjacent surfaces.
 - 3. Provide concave joint configuration per Figure 5A in ASTM C 1193, unless otherwise indicated.

3.04 CLEANING

- A. Clean off excess sealant or sealant smears adjacent to joints as the Work progresses by methods and with cleaning materials approved in writing by manufacturers of joint sealants and of products in which joints occur.

3.05 PROTECTION

- A. Protect joint sealants during and after curing period from contact with contaminating substances and from damage resulting from construction operations or other causes so sealants are without deterioration or damage at time of Substantial Completion. If, despite such protection, damage or deterioration occurs, cut out and remove damaged or deteriorated joint sealants immediately so installations with repaired areas are indistinguishable from original work.

END OF SECTION

(THIS PAGE INTENTIONALLY LEFT BLANK)

DIVISION 08

(THIS PAGE INTENTIONALLY LEFT BLANK)

SECTION 08101

FIBERGLASS DOORS AND FRAMES

PART 1 GENERAL

1.01 SUMMARY

A. Section Includes

1. Requirements to furnish all labor, materials, tools, apparatus and equipment for the installation of all fiberglass swing doors and frames as shown on the drawings and/or described hereunder, and all incidental work necessary to provide a complete installation.

B. Related Sections

1. Section 05500 Metal Fabrication
2. Section 08511 Aluminum Windows
3. Section 08800 Glazing

1.02 SUBMITTALS

- A. Shop drawings of all doors and frames shall be submitted to the Engineer for approval, and no work shall be fabricated until such drawings have been approved.

- B. Shop drawings shall provide pertinent dimensions, hardware locations, lite sizes and dimensions, and door elevations. Mortises for hardware must be molded in at the factory as the door is built. Mortises shall not be routed or cut out of the stile structure or jambs.

- C. Hardware templates shall be furnished to the door manufacturer by the Contractor for correct hardware alignment and reinforcing. All doors and frames shall be prepared at the factory to receive finish hardware.

- D. Provide color chart for standard colors and custom colors which are available.

1.03 PRODUCT HANDLING

- A. All materials shall be delivered to the site in sealed, undamaged containers fully identified with the manufacturer's name, project number, tag location, door type, color and weight. The doors and frames must be shipped in wood crates with wood perimeters. Store materials in original cartons, on edge in such a way to prevent falling or damage to face, corners and edges.

- B. Any imperfections in appearance or quality will be grounds for rejection.

PART 2 PRODUCTS

2.01 MANUFACTURERS

- A. Fiberglass Doors and Frames shall be as manufactured by Chem-Pruf Door Company, Brownsville, Texas or an approved equal.

2.02 MATERIALS

- A. Doors - All doors shall be made of fiberglass reinforced plastic (FRP) using resins tailored to a specific corrosive environment (stated by the purchaser at the time the order is placed) and have a fiberglass content of 25% by weight. The doors shall be flush construction, having no seams or cracks. All mortises shall be molded in at the factory. The doors shall be 1-3/4" thick with a 14 mil (plus or minus 3 mils) color gel coat and have an R-factor of 12. Secondary painting over pultrusions to achieve color is not acceptable.
- B. Stiles and Rails - Stiles and Rails shall be constructed starting from the outside toward the inside, of a 15020 mil gel coat of the color specified followed by a matrix of at least three layers of 1.5 ounce per square foot of fiberglass mat.. The stile and rail shall be molded in one continuous piece to a U-shaped configuration and to the exact dimensions of the door. In this manner there will be no miter joints or disparate materials used to form the one-piece stile and rail. Pultrusions will not be acceptable for stiles and rails as: (1) the color gel is not an integral part of the structure (it must of necessity be applied as a paint when the structure is assembled), and (2) mortises must be cut into the pultrusions, thus weakening the pultrusions by removing as much as two-thirds of its thickness and (3) the practice of mitered joints in pultrusions leaves access areas for penetration of contaminants to the inside of the door.
- C. Door Plates - All door plates shall be molded in one continuous piece, starting with a 15 to 20 mil gel coat of the color specified, integrally molded with at least two layers of 1.5 ounce per square foot fiberglass mat and layer of 16 ounce per square yard unidirectional glass roving.
- D. Reinforcement - Adequate reinforcing and compression members shall be used to accommodate surface hinges, closers, locksets, kickplates, push or pull plates. When engineering considerations dictate, mold steel is buried in the fiberglass matrix to provide enhanced screw holding power. In no case should screws be used into fiberglass matrix to provide holding of hinges, locks or closers or any structural attachment.
 - 1. Thru bolting is recommended for attachment of hinges, and closers in as much as the strength of thru bolting is five to six times as great as edge attaching with screws. When thru bolting is to occur, a compression member is to be located which will provide memory and resistance to the torquing of thru bolts.
 - 2. All voids between the door plates shall be completely filled with the equivalent of 4 to 6 lbs. expanded polyurethane foam, having a flame spread of 25 or less per ASTM E-84. A phenolic-coated kraft honeycomb may be substituted for urethane foam where engineering requirements dictate.
- E. Flame Spread - All reinforced resins shall contain a halogenated additive or core reactant plus Antimony Trioxide to achieve a flame spread of 25 or less per ASTM E-84 and shall be self-extinguishing per ASTM D-635.
- F. Window Lites - All window openings and louver openings in the door schedule should be molded integrally with both door plates so that no moisture may penetrate the door cavity

through the window lite structure. Window lites shall be structurally retained by at least 4 fiberglass glazing pins and sealed in such a manner that the integrity of the seals remain intact.

1. Cutting a window opening in the door and the use of either pultruded shapes for window ledges or the use of externally applied picture frames appliquéd to retain the glass are unacceptable where sanitation and cleanliness are desired.

G. Color - The color of the door or frame shall be integrally molded as the part is made.

H. Frames - Frames shall be similar to the doors in construction and materials except the frames shall be solid fiberglass. The stop and frame will be molded all in one piece. The frame shall be integrally gel coated to the customer's color when molded. Mortises will be molded in. It is not permitted to rout in mortises or remove any material from the head or jambs, to provide mortises.

1. Reinforcement for mounting hinges, closers, etc., shall be of mild steel plates strategically located and buried in the resin-glass matrix so they will not be exposed to the elements.
2. The jamb shall be flat on the backside (against the opening) and uniform in thickness so as to provide a solid, uniform surface against the wall opening. No wood blocks or spacers are permitted.

I. Hardware - All hardware, where applicable (locksets, hinges, closers, etc.) shall be installed at the door manufacturing plant. The hardware manufacturer's warranty shall be included with the hardware installation.

PART 3 EXECUTION

3.01 INSTALLATION

- A. All frames shall be supplied in good time for installation during the construction of walls. They will be built in as the work progresses. Care will be taken to ensure that the surfaces of fiberglass frames are not in any way marred or damaged. Spacers shall remain in place until doors are being hung.
- B. Installation shall be in strict compliance with manufacturer's written instructions using non-corrosive materials and methods.

3.02 ADJUST AND CLEAN

A. Final Adjustments

1. Check and readjust operating finish hardware just prior to final inspection. Leave work in complete and proper operating condition. Remove and replace defective work including doors or frames which are warped, bowed and otherwise damaged.

3.03 GUARANTEE

- A. An unconditional guarantee shall be issued by the manufacturer for 10 years against failure due to corrossions from the specific environment named at the time of purchase.

END OF SECTION

(THIS PAGE INTENTIONALLY LEFT BLANK)

SECTION 08311

ACCESS DOORS AND FRAMES

PART 1 - GENERAL

1.01 GENERAL PROVISIONS

- A. Attention is directed to the CONTRACT AND GENERAL CONDITIONS and all Sections within DIVISION 01 - GENERAL REQUIREMENTS which are hereby made a part of this Section of the Specifications.

1.02 DESCRIPTION OF WORK

- A. Work Included: Provide labor, materials and equipment necessary to complete the work of this Section, including but not limited to the following:
 - 1. Access doors and frames for walls and ceilings. Refer to Section 05500 for floor hatches.
- B. Related Work: The following items are not included in this Section and are specified under the designated Sections:
 - 1. Section 03300 - CAST-IN-PLACE CONCRETE for blocking out openings for access doors and frames in concrete.
 - 2. Section 04200 - REINFORCED UNIT MASONRY for anchoring and grouting access door frames set in masonry construction.
 - 3. Section 05500 - METAL FABRICATIONS for interior and exterior floor hatches.

1.03 SUBMITTALS

- A. Product Data: For each type of access door and frame indicated. Include construction details, fire ratings, materials, individual components and profiles, and finishes.
- B. Shop Drawings: Show fabrication and installation details of access doors and frames for each type of substrate. Include plans, elevations, sections, details, and attachments to other work.
- C. Samples: For each door face material, at least 3 by 5 inches in size, in specified finish.
- D. Access Door and Frame Schedule: Provide complete access door and frame schedule, including types, locations, sizes, latching or locking provisions, and other data pertinent to installation.
- E. Ceiling Coordination Drawings: Reflected ceiling plans, drawn to scale, on which ceiling-mounted items including access doors and frames, lighting fixtures, diffusers,

grilles, speakers, sprinklers, and special trim are shown and coordinated with each other.

1.04 QUALITY ASSURANCE

- A. Source Limitations: Obtain each type of access door and frame through one source from a single manufacturer.
- B. Fire-Rated Access Doors and Frames: Units complying with NFPA 80 that are identical to access door and frame assemblies tested for fire-test-response characteristics per the following test method and that are listed and labeled by UL or another testing and inspecting agency acceptable to authorities having jurisdiction:
 - 1. NFPA 252 for vertical access doors and frames.
 - 2. ASTM E 119 for horizontal access doors and frames.
- C. Size Variations: Obtain Engineer's acceptance of manufacturer's standard-size units, which may vary slightly from sizes indicated.

1.05 COORDINATION

- A. Verification: Determine specific locations and sizes for access doors needed to gain access to concealed plumbing, mechanical, or other concealed work, and indicate in the schedule specified in "Submittals" Article.

PART 2 - PRODUCTS

2.01 STEEL MATERIALS

- A. Steel Plates, Shapes, and Bars: ASTM A 36/A 36M.
 - 1. ASTM A 123/A 123M, for galvanizing steel and iron products.
 - 2. ASTM A 153/A 153M, for galvanizing steel and iron hardware.
- B. Steel Sheet: Electrolytic zinc-coated, ASTM A 879/A 879M with cold-rolled steel sheet substrate complying with ASTM A 1008/A 1008M, Commercial Steel (CS), exposed.
- C. Steel Finishes: Comply with NAAMM's "Metal Finishes Manual for Architectural and Metal Products" for recommendations for applying and designating finishes.
 - 1. Surface Preparation for Steel Sheet: Clean surfaces to comply with SSPC-SP 1, "Solvent Cleaning," to remove dirt, oil, grease, or other contaminants that could impair paint bond. Remove mill scale and rust, if present, from uncoated steel, complying with SSPC-SP 5/NACE No. 1, "White Metal Blast Cleaning," or SSPC-SP 8, "Pickling."

- a. Galvanizing Repair Paint: High-zinc-dust-content paint for regalvanizing welds in steel, complying with SSPC-Paint 20.
2. Factory-Primed Finish: Apply shop primer immediately after cleaning and pretreating.
- D. Drywall Beads: Edge trim formed from 0.0299-inch zinc-coated steel sheet formed to receive joint compound and in size to suit thickness of gypsum board.

2.02 STAINLESS-STEEL MATERIALS

- A. Rolled-Stainless-Steel Floor Plate: ASTM A 793, manufacturer's standard finish.
- B. Stainless-Steel Sheet, Strip, Plate, and Flat Bars: ASTM A 666, Type 316. Remove tool and die marks and stretch lines or blend into finish.
 1. Finish: Directional Satin Finish, No. 4.

2.03 ACCESS DOORS AND FRAMES FOR WALLS AND CEILINGS

- A. Available Manufacturers: Subject to compliance with requirements, manufacturers offering products that may be incorporated into the Work include, but are not limited to, the following:
 1. Acudor Products, Inc.
 2. J. L. Industries, Inc.
 3. Karp Associates, Inc.
 4. Nystrom, Inc.
- B. Flush Access Doors and Trimless Frames: Fabricated from steel sheet at typical areas and from stainless-steel sheet at toilet and wet areas.
 1. Locations: Wall and ceiling surfaces.
 2. Door: Minimum 0.060-inch-thick sheet metal, set flush with surrounding finish surfaces.
 3. Frame: Minimum 0.060-inch-thick sheet metal with drywall bead flange.
 4. Hinges: Continuous piano.
 5. Lock: Cylinder, to match Owner's key system.
 - a. Lock Preparation: Prepare door panel to accept cylinder specified in the Door Schedule on the Drawings.
- C. Recessed Access Doors and Trimless Frames: Fabricated from steel sheet at typical areas and from stainless-steel sheet at toilet and wet areas.
 1. Locations: Wall and ceiling surfaces.
 2. Door: Minimum 0.060-inch-thick sheet metal in the form of a pan recessed 5/8 inch for gypsum board infill.

3. Frame: Minimum 0.060-inch-thick sheet metal with drywall bead for gypsum board surfaces.
 4. Hinges: Concealed pivoting rod hinge.
 5. Lock: Cylinder.
 - a. Lock Preparation: Prepare door panel to accept cylinder specified in the Door Schedule on the Drawings.
- D. Fire Rated, Uninsulated, Flush Access Doors and Frames with Exposed Trim: Fabricated from steel at typical areas and from stainless-steel sheet at toilets and wet areas.
1. Locations: Wall surfaces.
 2. Fire-Resistance Rating: Not less than that of adjacent construction.
 3. Door: Minimum 0.060-inch-thick sheet metal, flush construction.
 4. Frame: Minimum 0.060-inch-thick sheet metal with 1-inch-wide, surface-mounted trim.
 5. Hinges: Continuous piano.
 6. Automatic Closer: Spring type.
 7. Lock: Self-latching device with cylinder lock.
 - a. Lock Preparation: Prepare door panel to accept cylinder specified in the Door Schedule on the Drawings.

2.04 FABRICATION

- A. General: Provide access door and frame assemblies manufactured as integral units ready for installation.
- B. Metal Surfaces: For metal surfaces exposed to view in the completed Work, provide materials with smooth, flat surfaces without blemishes. Do not use materials with exposed pitting, seam marks, roller marks, rolled trade names, or roughness.
- C. Doors and Frames: Grind exposed welds smooth and flush with adjacent surfaces. Furnish attachment devices and fasteners of type required to secure access panels to types of supports indicated.
 1. For trimless frames with drywall bead, provide edge trim for gypsum board and gypsum base securely attached to perimeter of frames.
 2. For trimless frames with plaster bead for full-bed plaster applications, provide zinc-coated expanded metal lath and exposed casing bead welded to perimeter of frames.
 3. Provide mounting holes in frames for attachment of units to metal or wood framing.
 4. Provide mounting holes in frame for attachment of masonry anchors.
- D. Recessed Access Doors: Form face of panel to provide recess for application of applied finish. Reinforce panel as required to prevent buckling.

1. For recessed doors with plaster infill, provide self-furring expanded metal lath attached to door panel.
- E. Latching Mechanisms: Furnish number required to hold doors in flush, smooth plane when closed.
1. For cylinder lock, furnish two keys per lock and key all locks alike.
 2. For recessed panel doors, provide access sleeves for each locking device. Furnish plastic grommets and install in holes cut through finish.

PART 3 - EXECUTION

3.01 INSTALLATION

- A. Comply with manufacturer's written instructions for installing access doors and frames.
- B. Set frames accurately in position and attach securely to supports with plane of face panels aligned with adjacent finish surfaces.
- C. Install doors flush with adjacent finish surfaces or recessed to receive finish material.

3.02 ADJUSTING AND CLEANING

- A. Adjust doors and hardware after installation for proper operation.
- B. Remove and replace doors and frames that are warped, bowed, or otherwise damaged.

END OF SECTION

(THIS PAGE INTENTIONALLY LEFT BLANK)

SECTION 08511

ALUMINUM WINDOWS

PART 1 - GENERAL

1.01 GENERAL PROVISIONS

- A. Attention is directed to the CONTRACT AND GENERAL CONDITIONS and all Sections within DIVISION 01 - GENERAL REQUIREMENTS which are hereby made a part of this Section of the Specifications.

1.02 DESCRIPTION OF WORK

- A. Work Included: Provide labor, materials and equipment necessary to complete the work of this Section, including but not limited to the following:
 - 1. Fixed aluminum-framed windows with factory-installed laminated glass and glazing and custom panning; and replacement windows.
- B. Related Work: The following items are not included in this Section and are specified under the designated Sections:
 - 1. Section 07610 - SHEET METAL FLASHING AND TRIM for flashing at windows.

1.03 PERFORMANCE REQUIREMENTS

- A. General: Provide aluminum windows capable of complying with performance requirements indicated, based on testing manufacturer's windows that are representative of those specified and that are of test size indicated below:
 - 1. Minimum size required by AAMA/NWWDA 101/I.S.2.
- B. AAMA/NWWDA Performance Requirements: Provide aluminum windows of the performance class and grade indicated that comply with AAMA/NWWDA 101/I.S.2.
 - 1. Performance Class: Architectural Grade AW.
 - 2. Performance Grade: Minimum for performance class indicated.
 - 3. Exception to AAMA/NWWDA 101/I.S.2: In addition to requirements for performance class and performance grade, design glass framing system to limit lateral deflections of glass edges to less than 1/175 of glass-edge length or 3/4 inch whichever is less, at design pressure based on the following:

- C. Structural Performance: Provide aluminum windows capable of withstanding the following, including wind loads based on passing AAMA/NWWDA 101/I.S.2, Uniform Load Structural Test, at basic wind speed indicated and as required by Code:
1. Deflection: Design glass framing system to limit lateral deflections of glass edges to less than 1/175 of glass-edge length or 3/4 inch, whichever is less, at design pressure based on structural computations.
 2. Wind and Seismic Loads: As indicated on the Structural Drawings, but not less than that required by Code.
 3. Movements of supporting structure including, but not limited to, story drift and deflection from uniformly distributed and concentrated live loads as required by Code. Deflection may require special considerations including but not limited to head receptors.
- D. Air Infiltration: Maximum rate not more than indicated when tested according to AAMA/NWWDA 101/I.S.2, Air Infiltration Test.
1. Maximum Rate: As required by Code.
- E. Water Resistance: No water leakage as defined in AAMA/NWWDA referenced test methods at a water test pressure equaling that indicated, when tested according to AAMA/NWWDA 101/I.S.2, Water Resistance Test.
1. Test Pressure: 15 percent of positive design pressure, but not less than 2.86 lbf/sq. ft. or more than 12 lbf/sq. ft.
- F. Condensation-Resistance Factor: Provide aluminum windows tested for thermal performance according to AAMA 1503, showing a CRF of 52 where windows are indicated to be "thermally improved."
- G. Thermal Transmittance: Provide aluminum windows with a whole-window U-value maximum indicated at 15-mph exterior wind velocity and winter condition temperatures when tested according to AAMA 1503.
1. U-Value: As required by Code. Submit proof of compliance with submittals as specified.
- H. Thermal Movements: Provide aluminum windows, including anchorage, that accommodate thermal movements of units resulting from the following maximum change (range) in ambient and surface temperatures without buckling, distortion, opening of joints, failure of joint sealants, damaging loads and stresses on glazing and connections, and other detrimental effects. Base engineering calculation on actual surface temperatures of materials due to solar heat gain and nighttime-sky heat loss.
1. Temperature Change (Range): 120 deg F, ambient; 180 deg F material surfaces.

1.04 SUBMITTALS

- A. Product Data: Include construction details, material descriptions, fabrication methods, dimensions of individual components and profiles, hardware, finishes, and operating instructions for each type of aluminum window indicated.
- B. Shop Drawings: Include plans, elevations, sections, details, hardware, attachments to other Work, operational clearances, and the following:
 - 1. Mullion details, including reinforcement and stiffeners.
 - 2. Joinery details.
 - 3. Expansion provisions.
 - 4. Flashing and drainage details.
 - 5. Weather-stripping details.
 - 6. Thermal-break details.
 - 7. Glazing details.
 - 8. Window cleaning provisions.
 - 9. For installed products indicated to comply with design loads, include structural analysis data signed and sealed by the qualified professional engineer responsible for their preparation and used to determine the following:
 - a. Structural test pressures and design pressures from basic wind speeds indicated.
 - b. Deflection limitations of glass framing systems.
- C. Samples for Verification: Full-size window of each type of window.
- D. Qualification Data: For Installer, professional engineer and testing agency.
- E. Field Quality-Control Test Reports: From a qualified testing and inspecting agency engaged by Contractor.
- F. Product Test Reports: Based on evaluation of comprehensive tests performed within the last four years by a qualified testing agency, for each type, grade, and size of aluminum window. Test results based on use of downsized test units will not be accepted.
- G. Performance Reports: Based on systems, components and glazing methods proposed for use on this Project, proof that windows as glazed for this Project meet or exceed Code requirements for the following:
 - 1. U-value.
 - 2. Solar heat-gain coefficient.
- H. Maintenance Data: For window finishes to include in maintenance manuals.

1.05 QUALITY ASSURANCE

- A. **Installer Qualifications:** An installer acceptable to aluminum window manufacturer for installation of units required for this Project.
- B. **Engineering Responsibility:** Preparation of Shop Drawings, design calculations, and other structural data by a qualified professional engineer.
- C. **Professional Engineer Qualifications:** A professional engineer who is legally qualified to practice in the state the project is located, and who is experienced in providing engineering services of the kind indicated. Engineering services are defined as those performed for installations of windows that are similar to those indicated for this Project in material, design, and extent.
- D. **Source Limitations:** Obtain aluminum windows through one source from a single manufacturer.
- E. **Performance:** Miami/Dade Notice of Acceptance.
- F. **Product Options:** Information on Drawings and in Specifications establishes requirements for aluminum windows' aesthetic effects and performance characteristics. Aesthetic effects are indicated by dimensions, arrangements, alignment, and profiles of components and assemblies as they relate to sightlines, to one another, and to adjoining construction. Performance characteristics are indicated by criteria subject to verification by one or more methods including preconstruction testing, field testing, and in-service performance.
- G. **Fenestration Standard:** Comply with AAMA/NWWDA 101/I.S.2, "Voluntary Specifications for Aluminum, Vinyl (PVC) and Wood Windows and Glass Doors," for minimum standards of performance, materials, components, accessories, and fabrication unless more stringent requirements are indicated.
 - 1. Provide AAMA certified aluminum windows with an attached label.
- H. **Glazing Publications:** Comply with published recommendations of glass manufacturers and GANA's "Glazing Manual" unless more stringent requirements are indicated.
- I. **Preinstallation Conference:** Conduct conference at Project site to comply with requirements in Division 01. Review methods and procedures related to aluminum windows including, but not limited to, the following:
 - 1. Inspect and discuss condition of substrate and other preparatory work performed by other trades.
 - 2. Review and finalize construction schedule and verify availability of materials, Installer's personnel, equipment, and facilities needed to make progress and avoid delays.
 - 3. Review required testing and inspecting procedures.

1.06 PROJECT CONDITIONS

- A. Field Measurements: Verify aluminum window openings by field measurements before fabrication and indicate measurements on Shop Drawings.
 - 1. Established Dimensions: Where field measurements cannot be made without delaying the Work, establish opening dimensions and proceed with fabricating aluminum windows without field measurements. Coordinate wall construction to ensure that actual opening dimensions correspond to established dimensions.

1.07 WARRANTY

- A. Special Warranty: Manufacturer's standard form in which manufacturer agrees to repair or replace aluminum windows that fail in materials or workmanship within specified warranty period. Failures include, but are not limited to, the following:
 - 1. Failure to meet performance requirements.
 - 2. Structural failures including excessive deflection.
 - 3. Water leakage, air infiltration, or condensation.
 - 4. Faulty operation of movable sash and hardware.
 - 5. Deterioration of metals, metal finishes, and other materials beyond normal weathering.
 - 6. Insulating glass failure.
- B. Warranty Period: Ten years from date of Substantial Completion.
- C. Warranty Period for Metal Finishes: Ten years from date of Substantial Completion.
- D. Warranty Period for Glass: Ten years from date of Substantial Completion.

PART 2 - PRODUCTS

2.01 MANUFACTURERS

- A. Available Manufacturers: Subject to compliance with requirements, manufacturers offering products that may be incorporated into the Work include, but are not limited to, the following:
 - 1. Aluminum Windows:
 - a. EFCO, a Pella Company.
 - b. Graham Architectural Products Corp.
 - c. Oldcastle BuildingEnvelope.
- B. Basis of Design: Provide EFCO 325X windows or equal by a manufacturer listed above.

- C. Laminated Insulating-Glass Units: Nominal 1 inch thick laminated insulating glass consisting of one lite of 5/16" laminated glass and one lite of 1/4 inch glass, low e coating on the No. 4 surface (inside face of exterior lite) and argon gas filled. Provide one of the following or equal:
1. VE-42 by Viracon.
 - a. Visible Light Transmittance: 36 percent.
 - b. U Value (Winter): 0.30.
 - c. Solar Heat Gain Coefficient: 0.29.
 2. Approved equal by PPG Industries.
 3. Approved equal by Guardian Industries.
- D. Glazing System: Manufacturer's standard factory-glazing system that produces weathertight seal.

2.02 MATERIALS

- A. Aluminum Extrusions: Alloy and temper recommended by aluminum window manufacturer for strength, corrosion resistance, and application of required finish, but not less than 22,000-psi (150-MPa) ultimate tensile strength, not less than 16,000-psi (110-MPa) minimum yield strength, and not less than 0.062-inch (1.6-mm) thickness at any location for the main frame and sash members.
- B. Fasteners: Aluminum, nonmagnetic stainless steel, epoxy adhesive, or other materials warranted by manufacturer to be noncorrosive and compatible with aluminum window members, trim, hardware, anchors, and other components.
1. Reinforcement: Where fasteners screw anchor into aluminum less than 0.125 inch (3.2 mm) thick, reinforce interior with aluminum or nonmagnetic stainless steel to receive screw threads, or provide standard, noncorrosive, pressed-in, splined grommet nuts.
 2. Exposed Fasteners: Unless unavoidable for applying hardware, do not use exposed fasteners. For application of hardware, use fasteners that match finish of member or hardware being fastened, as appropriate.
- C. Anchors, Clips, and Accessories: Aluminum, nonmagnetic stainless steel, or zinc-coated steel or iron complying with ASTM B 633 for SC 3 severe service conditions; provide sufficient strength to withstand design pressure indicated.
- D. Reinforcing Members: Aluminum, nonmagnetic stainless steel, or nickel/chrome-plated steel complying with ASTM B 456 for Type SC 3 severe service conditions, or zinc-coated steel or iron complying with ASTM B 633 for SC 3 severe service conditions; provide sufficient strength to withstand design pressure indicated.
- E. Sealant: For sealants required within fabricated windows, provide window manufacturer's standard, permanently elastic, nonshrinking, and nonmigrating type recommended by sealant manufacturer for joint size and movement.

2.03 FABRICATION

- A. General: Fabricate aluminum windows, in sizes indicated, that comply with AAMA/NWWDA 101/I.S.2 for performance class and performance grade indicated. Include a complete system for assembling components and anchoring windows.
- B. Thermally Improved Construction: Fabricate aluminum windows with an integral, concealed, low-conductance thermal barrier; located between exterior materials and window members exposed on interior side; in a manner that eliminates direct metal-to-metal contact.
- C. Weather Stripping: Provide full-perimeter weather stripping for each operable sash and ventilator.
- D. Weep Holes: Provide concealed weep holes and internal passages to conduct infiltrating water to exterior.
- E. Mullions: Provide mullions and cover plates as shown, matching window units, complete with anchors for support to structure and installation of window units. Allow for erection tolerances and provide for movement of window units due to thermal expansion and building deflections, as indicated. Provide mullions and cover plates capable of withstanding design loads of window units.
- F. Factory-Glazed Fabrication: Glaze aluminum windows in the factory where practical and possible for applications indicated. Comply with AAMA/NWWDA 101/I.S.2.
- G. Window Panning: Provide custom window panning profiles. Refer to drawings for shapes.

2.04 FINISHES

- A. General: Comply with NAAMM's "Metal Finishes Manual for Architectural and Metal Products" for recommendations for applying and designating finishes.
- B. Finish designations prefixed by AA comply with the system established by the Aluminum Association for designating aluminum finishes.
- C. High-Performance Organic Finish: AA-C12C42R1x (Chemical Finish: cleaned with inhibited chemicals; Chemical Finish: acid-chromate-fluoride-phosphate conversion coating; Organic Coating: as specified below). Prepare, pretreat, and apply coating to exposed metal surfaces to comply with coating and resin manufacturers' written instructions.
 - 1. Fluoropolymer Three-Coat System: Manufacturer's standard three-coat, thermocured system consisting of specially formulated inhibitive primer, fluoropolymer color coat, and clear fluoropolymer topcoat, with both color coat and clear topcoat containing not less than 70 percent polyvinylidene fluoride resin by weight; complying with AAMA 2605.

- a. Color and Gloss: As selected by Engineer from manufacturer's full range.

PART 3 - EXECUTION

3.01 EXAMINATION

- A. Examine openings, substrates, structural support, anchorage, and conditions, with Installer present, for compliance with requirements for installation tolerances; rough opening dimensions; levelness of sill plate; coordination with wall flashings, vapor retarders, and other built-in components; operational clearances; and other conditions affecting performance of work.
 - 1. Masonry Surfaces: Visibly dry and free of excess mortar, sand, and other construction debris.
 - 2. Metal Surfaces: Dry; clean; free of grease, oil, dirt, rust, corrosion, and welding slag; without sharp edges or offsets at joints.
- B. Proceed with installation only after unsatisfactory conditions have been corrected.

3.02 INSTALLATION

- A. General: Comply with manufacturer's written instructions for installing windows, hardware, accessories, and other components; Drawings; and Shop Drawings.
- B. Install windows level, plumb, square, true to line, without distortion or impeding thermal movement, anchored securely in place to structural support, and in proper relation to wall flashing and other adjacent construction.
- C. Set sill members in bed of sealant or with gaskets, as indicated, for weathertight construction.
- D. Install windows and components to drain condensation, water penetrating joints, and moisture migrating within windows to the exterior.
- E. Metal Protection: Separate aluminum and other corrodible surfaces from sources of corrosion or electrolytic action at points of contact with other materials by complying with requirements specified in "Dissimilar Materials" Paragraph in Appendix B in AAMA/NWWDA 101/I.S.2.

3.03 FIELD QUALITY CONTROL

- A. Testing Agency: Engage a qualified independent testing and inspecting agency to perform field tests and inspections and to prepare test reports.
- B. Testing Services: Testing and inspecting of installed windows shall take place as follows:

1. Testing Methodology: Testing of windows for air infiltration and water resistance shall be performed according to AAMA 502, Test Method A, by applying same test pressures required to determine compliance with AAMA/NWWDA 101/I.S.2 in Part 1 "Performance Requirements" Article.
 2. Testing Extent: Three windows as selected by Engineer and a qualified independent testing and inspecting agency. Windows shall be tested immediately after installation.
 3. Test Reports: Shall be prepared according to AAMA 502.
- C. Remove and replace windows where test results indicate that they do not comply with specified requirements.
- D. Additional testing and inspecting, at Contractor's expense, will be performed to determine compliance of replaced or additional work with specified requirements.

3.04 ADJUSTING

- A. Adjust operating sashes and ventilators, screens, hardware, operators, and accessories for a tight fit at contact points and weather stripping for smooth operation and weathertight closure. Lubricate hardware and moving parts.

3.05 PROTECTION AND CLEANING

- A. Protect window surfaces from contact with contaminating substances resulting from construction operations. In addition, monitor window surfaces adjacent to and below exterior concrete and masonry surfaces during construction for presence of dirt, scum, alkaline deposits, stains, or other contaminants. If contaminating substances do contact window surfaces, remove contaminants immediately according to manufacturer's written recommendations.
- B. Clean aluminum surfaces immediately after installing windows. Avoid damaging protective coatings and finishes. Remove excess sealants, glazing materials, dirt, and other substances.
- C. Clean factory-glazed glass immediately after installing windows. Comply with manufacturer's written recommendations for final cleaning and maintenance. Remove nonpermanent labels and clean surfaces.
- D. Remove and replace glass that has been broken, chipped, cracked, abraded, or damaged during construction period.

END OF SECTION

(THIS PAGE INTENTIONALLY LEFT BLANK)

SECTION 08800

GLAZING

PART 1 - GENERAL

1.01 GENERAL PROVISIONS

- A. Attention is directed to the CONTRACT AND GENERAL CONDITIONS and all Sections within DIVISION 01 - GENERAL REQUIREMENTS which are hereby made a part of this Section of the Specifications.

1.02 DESCRIPTION OF WORK

- A. Work Included: Provide labor, materials and equipment necessary to complete the work of this Section, including but not limited to the following:
 - 1. Glass and glazing for the following products and applications:
 - a. Fiberglass doors, frames and sidelights specified in Section 08101 - FIBERGLASS DOORS AND FRAMES.
 - b. Interior borrowed lites.
- B. Related Work: The following items are not included in this Section and are specified under the designated Sections:
 - 1. Section 08511 - ALUMINUM WINDOWS for factory glazing for metal windows.

1.03 SUBMITTALS

- A. Product Data: For each glass product and glazing material indicated.

1.04 QUALITY ASSURANCE

- A. Installer Qualifications: An experienced installer who has completed glazing similar in material, design, and extent to that indicated for this Project; whose work has resulted in glass installations with a record of successful in-service performance..
- B. Safety Glazing Products: Comply with testing requirements in 16 CFR 1201.
 - 1. Subject to compliance with requirements, obtain safety glazing products permanently marked with certification label of the Safety Glazing Certification Council or another certification agency] acceptable to authorities having jurisdiction.
 - 2. Where glazing units, including Kind FT glass and laminated glass, are specified in Part 2 articles for glazing lites more than 9 sq. ft. in exposed surface area of one side, provide glazing products that comply with Category II materials, for lites 9

sq. ft. or less in exposed surface area of one side, provide glazing products that comply with Category I or II materials, except for hazardous locations where Category II materials are required by 16 CFR 1201 and regulations of authorities having jurisdiction.

1.05 DELIVERY, STORAGE, AND HANDLING

- A. Protect glazing materials according to manufacturer's written instructions and as needed to prevent damage to glass and glazing materials from condensation, temperature changes, direct exposure to sun, or other causes.

1.06 PROJECT CONDITIONS

- A. Environmental Limitations: Do not proceed with glazing when ambient and substrate temperature conditions are outside limits permitted by glazing material manufacturers and when glazing channel substrates are wet from rain, frost, condensation, or other causes.

PART 2 - PRODUCTS

2.01 GLASS PRODUCTS

- A. Tempered Float Glass: ASTM C 1048; Type I (transparent flat glass); Quality-Q3; Kind FT; 1/4 inch thick unless indicated otherwise.
- B. Back-Bedding Mastic Glazing Tapes: Preformed, butyl-based elastomeric tape with a solids content of 100 percent; nonstaining and nonmigrating in contact with nonporous surfaces; with or without spacer rod as recommended in writing by tape and glass manufacturers for application indicated; packaged on rolls with a release paper backing; and complying with ASTM C 1281 and AAMA 800 for project conditions.

2.02 MISCELLANEOUS GLAZING MATERIALS

- A. General: Provide products of material, size, and shape complying with referenced glazing standard, requirements of manufacturers of glass and other glazing materials for application indicated, and with a proven record of compatibility with surfaces contacted in installation.
- B. Cleaners, Primers, and Sealers: Types recommended by sealant or gasket manufacturer.
- C. Setting Blocks: Elastomeric material with a Shore, Type A durometer hardness of 85, plus or minus 5.
- D. Spacers: Elastomeric blocks or continuous extrusions with a Shore, Type A durometer hardness required by glass manufacturer to maintain glass lites in place for installation indicated.

- E. Edge Blocks: Elastomeric material of hardness needed to limit glass lateral movement (side walking).

2.03 FABRICATION OF GLAZING UNITS

- A. Fabricate glazing units in sizes required to glaze openings indicated for Project, with edge and face clearances, edge and surface conditions, and bite complying with written instructions of product manufacturer and referenced glazing publications, to comply with system performance requirements.
- B. Clean-cut or flat-grind vertical edges of butt-glazed monolithic lites in a manner that produces square edges with slight kerfs at junctions with outdoor and indoor faces.

PART 3 - EXECUTION

3.01 EXAMINATION

- A. Examine framing glazing, with Installer present, for compliance with the following:
 - 1. Manufacturing and installation tolerances, including those for size, squareness, and offsets at corners.
 - 2. Presence and functioning of weep system.
 - 3. Minimum required face or edge clearances.
 - 4. Effective sealing between joints of glass-framing members.
- B. Proceed with installation only after unsatisfactory conditions have been corrected.

3.02 PREPARATION

- A. Clean glazing channels and other framing members receiving glass immediately before glazing. Remove coatings not firmly bonded to substrates.

3.03 GLAZING, GENERAL

- A. Comply with combined written instructions of manufacturers of glass, sealants, gaskets, and other glazing materials, unless more stringent requirements are indicated, including those in referenced glazing publications.
- B. Glazing channel dimensions, as indicated on Drawings, provide necessary bite on glass, minimum edge and face clearances, and adequate sealant thicknesses, with reasonable tolerances. Adjust as required by Project conditions during installation.
- C. Protect glass edges from damage during handling and installation. Remove damaged glass from Project site and legally dispose of off Project site. Damaged glass is glass with edge damage or other imperfections that, when installed, could weaken glass and impair performance and appearance.

- D. Apply primers to joint surfaces where required for adhesion of sealants, as determined by preconstruction sealant-substrate testing.
- E. Install setting blocks in sill rabbets, sized and located to comply with referenced glazing publications, unless otherwise required by glass manufacturer. Set blocks in thin course of compatible sealant suitable for heel bead.
- F. Do not exceed edge pressures stipulated by glass manufacturers for installing glass lites.
- G. Provide spacers for glass lites where length plus width is larger than 50 inches as follows:
 - 1. Locate spacers directly opposite each other on both inside and outside faces of glass. Install correct size and spacing to preserve required face clearances, unless gaskets and glazing tapes are used that have demonstrated ability to maintain required face clearances and to comply with system performance requirements.
 - 2. Provide 1/8-inch minimum bite of spacers on glass and use thickness equal to sealant width. With glazing tape, use thickness slightly less than final compressed thickness of tape.
- H. Provide edge blocking where indicated or needed to prevent glass lites from moving sideways in glazing channel, as recommended in writing by glass manufacturer and according to requirements in referenced glazing publications.
- I. Set glass lites in each series with uniform pattern, draw, bow, and similar characteristics.

3.04 TAPE GLAZING

- A. Position tapes on fixed stops so that, when compressed by glass, their exposed edges are flush with or protrude slightly above sightline of stops.
- B. Install tapes continuously, but not necessarily in one continuous length. Do not stretch tapes to make them fit opening.
- C. Cover vertical framing joints by applying tapes to heads and sills first and then to jambs. Cover horizontal framing joints by applying tapes to jambs and then to heads and sills.
- D. Place joints in tapes at corners of opening with adjoining lengths butted together, not lapped. Seal joints in tapes with compatible sealant approved by tape manufacturer.
- E. Do not remove release paper from tape until just before each glazing unit is installed.
- F. Center glass lites in openings on setting blocks and press firmly against tape by inserting dense compression gaskets formed and installed to lock in place against faces of removable stops. Start gasket applications at corners and work toward centers of openings.

3.05 CLEANING AND PROTECTION

- A. Protect exterior glass from damage immediately after installation by attaching crossed streamers to framing held away from glass. Do not apply markers to glass surface. Remove nonpermanent labels, and clean surfaces.
- B. Protect glass from contact with contaminating substances resulting from construction operations, including weld splatter. If, despite such protection, contaminating substances do come into contact with glass, remove substances immediately as recommended by glass manufacturer.
- C. Examine glass surfaces adjacent to or below exterior concrete and other masonry surfaces at frequent intervals during construction, but not less than once a month, for buildup of dirt, scum, alkaline deposits, or stains; remove as recommended in writing by glass manufacturer.
- D. Remove and replace glass that is broken, chipped, cracked, or abraded or that is damaged from natural causes, accidents, and vandalism, during construction period.

END OF SECTION

(THIS PAGE INTENTIONALLY LEFT BLANK)

DIVISION 09

(THIS PAGE INTENTIONALLY LEFT BLANK)

SECTION 09211

GYPSUM BOARD ASSEMBLIES

PART 1 - GENERAL

1.01 GENERAL PROVISIONS

- A. Attention is directed to the CONTRACT AND GENERAL CONDITIONS and all Sections within DIVISION 01 - GENERAL REQUIREMENTS which are hereby made a part of this Section of the Specifications.

1.02 DESCRIPTION OF WORK

- A. Work Included: Provide labor, materials and equipment necessary to complete the work of this Section, including but not limited to the following:
 - 1. Interior gypsum wallboard.
 - 2. Acoustic insulation in gypsum wallboard assemblies.
 - 3. Non-load-bearing steel framing.
 - 4. Installation of access panels.
 - 5. Marking and identification for fire- and smoke-partitions.
- B. Related Work: The following items are not included in this Section and are specified under the designated Sections:
 - 1. Section 08311 - ACCESS DOORS AND FRAMES for installation in gypsum board assemblies.

1.03 PERFORMANCE REQUIREMENTS

- A. Structural Performance: Provide fire stop tracks capable of withstanding deflection within limits and under conditions indicated.
 - 1. Design framing system to maintain clearances at openings, to allow for construction tolerances, and to accommodate live load deflection of primary building structure.
- B. Marking and Identification for Fire- and Smoke-Partitions: Fire walls, fire barriers, fire partitions, smoke barriers, smoke partitions and other walls required to have protected openings or penetrations shall be effectively and permanently identified with signs or stenciling. Such identification shall:
 - 1. Be located in accessible concealed floor, floor-ceiling or attic spaces; and
 - 2. Be repeated at intervals not exceeding 30 feet measured horizontally along the wall or partition; and

3. Include lettering not less than 0.5 inch in height, incorporating the suggested wording: "FIRE AND/OR SMOKE BARRIER - PROTECT ALL OPENINGS," or other wording.
4. Exception: Walls in Group R-2 occupancies that do not have a removable decorative ceiling allowing access to the concealed space.

1.04 SUBMITTALS

- A. Product Data: For each type of product indicated.
- B. Samples: Full-size Sample in 12-inch-long length for each trim accessory indicated.
- C. Shop Drawings: If materials and systems other than those specified and those indicated on the Drawings are proposed for use, submit shop drawings signed and sealed by a structural engineer licensed in the jurisdiction of the project certifying proposed systems meet code requirements, project requirements and the following deflection criteria:
 1. For gypsum board assemblies without applied rigid finishes L/240. Lateral load 5 psf except at shafts. Lateral load at shafts shall be required based on analysis of equipment and systems using shaft.

1.05 QUALITY ASSURANCE

- A. Fire-Resistance-Rated Assemblies: For fire-resistance-rated assemblies, provide materials and construction identical to those tested in assembly indicated according to ASTM E 119 by an independent testing agency.
- B. STC-Rated Assemblies: For STC-rated assemblies, provide materials and construction identical to those tested in assembly indicated according to ASTM E 90 and classified according to ASTM E 413 by an independent testing agency.
- C. Drywall Recycling: All new paper-faced gypsum wallboard scrap (cuts from construction but not demolition waste) shall be recycled by Gypsum Recycling America LLC or approved equal.
- D. Mockups: Before beginning gypsum board installation, install mockups of at least 100 sq. ft. in surface area to demonstrate aesthetic effects and set quality standards for materials and execution.
 1. Install mockups for the following:
 - a. Each level of gypsum board finish indicated for use in exposed locations.
 - b. Each texture finish indicated.
 2. Apply or install final decoration indicated, including painting and wallcoverings, on exposed surfaces for review of mockups.
 3. Simulate finished lighting conditions for review of mockups.

4. Approved mockups may become part of the completed Work if undisturbed at time of Substantial Completion.

1.06 STORAGE AND HANDLING

- A. Store materials inside under cover and keep them dry and protected against damage from weather, condensation, direct sunlight, construction traffic, and other causes. Stack panels flat to prevent sagging.

1.07 PROJECT CONDITIONS

- A. Environmental Limitations: Comply with ASTM C 840 requirements or gypsum board manufacturer's written recommendations, whichever are more stringent.
- B. Do not install interior products until installation areas are enclosed and conditioned.
- C. Do not install panels that are wet, those that are moisture damaged, and those that are mold damaged.
 1. Indications that panels are wet or moisture damaged include, but are not limited to, discoloration, sagging, or irregular shape.
 2. Indications that panels are mold damaged include, but are not limited to, fuzzy or splotchy surface contamination and discoloration.

PART 2 - PRODUCTS

2.01 NON-LOAD-BEARING STEEL FRAMING, GENERAL

- A. Framing Members, General: Comply with ASTM C 754 for conditions indicated.
 1. Steel Sheet Components: Comply with ASTM C 645 requirements for metal, unless otherwise indicated.
 2. Protective Coating: Manufacturer's standard corrosion-resistant zinc coating, unless otherwise indicated.

2.02 SUSPENSION SYSTEM COMPONENTS

- A. Tie Wire: ASTM A 641/A 641M, Class 1 zinc coating, soft temper, 0.0625-inch-diameter wire, or double strand of 0.0475-inch-diameter wire.
- B. Hanger Attachments to Concrete:
 1. Anchors: Fabricated from corrosion-resistant materials with holes or loops for attaching wire hangers and capable of sustaining, without failure, a load equal to 5 times that imposed by construction as determined by testing according to ASTM E 488 by an independent testing agency.
 - a. Type: Postinstalled, expansion anchor.

- C. Wire Hangers: ASTM A 641/A 641M, Class 1 zinc coating, soft temper, 0.162-inch diameter.
- D. Carrying Channels: Cold-rolled, commercial-steel sheet with a base-metal thickness of 0.0538 inch and minimum 1/2-inch-wide flanges with depth as required for span and loading and indicated on Drawings.
- E. Furring Channels (Furring Members): 0.0538-inch bare-steel thickness, with minimum 1/2-inch- wide flanges, 3/4 inch deep.
- F. Grid Suspension System for Ceilings: ASTM C 645, direct-hung system composed of main beams and cross-furring members that interlock.
 - 1. Available Products: Subject to compliance with requirements, products that may be incorporated into the Work include, but are not limited to, the following:
 - a. Armstrong World Industries, Inc.; Drywall Grid Systems.
 - b. Chicago Metallic Corporation; Drywall Furring System.
 - c. USG Corporation; Drywall Suspension System.

2.03 STEEL FRAMING FOR FRAMED ASSEMBLIES

- A. Steel Studs and Runners: ASTM C 645.
 - 1. Minimum Base-Metal Thickness: 0.0312 inch.
- B. Slip-Type Head Joints: Where indicated, provide one of the following:
 - 1. Single Long-Leg Runner System: ASTM C 645 top runner with 2-inch- deep flanges in thickness not less than indicated for studs, installed with studs friction fit into top runner and with continuous bridging located within 12 inches of the top of studs to provide lateral bracing.
 - 2. Double-Runner System: ASTM C 645 top runners, inside runner with 2-inch-deep flanges in thickness not less than indicated for studs and fastened to studs, and outer runner sized to friction fit inside runner.
 - 3. Deflection Track: Steel sheet top runner manufactured to prevent cracking of finishes applied to interior partition framing resulting from deflection of structure above; in thickness not less than indicated for studs and in width to accommodate depth of studs.
 - a. Available Products: Subject to compliance with requirements, products that may be incorporated into the Work include, but are not limited to, the following:
 - 1) Steel Network Inc. (The); VertiClip Series.
 - 2) Superior Metal Trim; Superior Flex Track System (SFT).

- C. Fire Stop Tracks: Top runner manufactured to allow partition heads to expand and contract with movement of the structure while maintaining continuity of fire-resistance-rated assembly indicated; in thickness compatible with studs and in width to accommodate depth of studs.
 - 1. Grace Construction Products; FlameSafe FlowTrak System.
 - 2. Fire Trak Corp.; Fire Trak attached to studs with Fire Trak Slip Clip.
 - 3. Metal-Lite, Inc.; The System.
- D. Flat Strap and Backing Plate: Steel sheet for blocking and bracing in length and width indicated.
 - 1. Minimum Base-Metal Thickness: 0.0312 inch.
- E. Cold-Rolled Channel Bridging: 0.0538-inch bare-steel thickness, with minimum 1/2-inch- wide flanges.
 - 1. Depth: 1-1/2 inches.
 - 2. Clip Angle: Not less than 1-1/2 by 1-1/2 inches, 0.068-inch-thick, galvanized steel.
- F. Hat-Shaped, Rigid Furring Channels: ASTM C 645.
 - 1. Minimum Base Metal Thickness: 0.0312 inch.
 - 2. Depth: 1-1/2 inches.
- G. Resilient Furring Channels: 1/2-inch-deep, steel sheet members designed to reduce sound transmission.
 - 1. Configuration: Asymmetrical or hat shaped.
- H. Z-Shaped Furring: With slotted or nonslotted web, face flange of 1-1/4 inches wall attachment flange of 7/8 inch, minimum bare-metal thickness of 0.0179 inch, and depth required to fit insulation thickness indicated.
- I. Fasteners for Metal Framing: Of type, material, size, corrosion resistance, holding power, and other properties required to fasten steel members to substrates.
- J. Isolation Strip at Exterior Walls: Adhesive-backed, closed-cell vinyl foam strips that allow fastener penetration without foam displacement, 1/8 inch thick, in width to suit steel stud size.

2.04 INTERIOR GYPSUM BOARD

- A. Manufacturers: Subject to compliance with requirements, available manufacturers offering products that may be incorporated into the Work include, but are not limited to, the following:

1. USG Corporation.
2. Georgia-Pacific (G-P) Gypsum LLC.
3. National Gypsum Company.

B. Fire-Resistant Type X: ASTM C 1396.

1. Thickness: 5/8 inch.
2. Long Edges: Tapered.

2.05 TRIM ACCESSORIES

A. Interior Trim: ASTM C 1047.

1. Material: Galvanized or aluminum-coated steel sheet or rolled zinc.
2. Shapes:
 - a. Cornerbead.
 - b. Bullnose bead.
 - c. LC-Bead: J-shaped; exposed long flange receives joint compound.
 - d. Expansion (control) joint.

B. Aluminum Trim: Extruded accessories of profiles and dimensions indicated.

1. Available Manufacturers: Subject to compliance with requirements, manufacturers offering products that may be incorporated into the Work include, but are not limited to, the following:
 - a. Fry Reglet Corp.
 - b. Gordon, Inc.
 - c. Pittcon Industries.
2. Aluminum: Alloy and temper with not less than the strength and durability properties of ASTM B 221, Alloy 6063-T5.
3. Finish: Corrosion-resistant primer compatible with joint compound and finish materials specified.

2.06 JOINT TREATMENT MATERIALS

A. General: Comply with ASTM C 475/C 475M.

B. Joint Tape:

1. Interior Gypsum Wallboard: Paper.

C. Joint Compound for Interior Gypsum Wallboard: For each coat use formulation that is compatible with other compounds applied on previous or for successive coats.

1. Prefilling: At open joints, rounded or beveled panel edges, and damaged surface areas, use setting-type taping compound.

2. Embedding and First Coat: For embedding tape and first coat on joints, fasteners, and trim flanges, use setting-type taping compound.
3. Fill Coat: For second coat, use setting-type, sandable topping compound.
4. Finish Coat: For third coat, use setting-type, sandable topping compound.
5. Skim Coat: For final coat of Level 5 finish, use setting-type, sandable topping compound.

2.07 AUXILIARY MATERIALS

- A. General: Provide auxiliary materials that comply with referenced installation standards and manufacturer's written recommendations.
- B. Laminating Adhesive: Adhesive or joint compound recommended for directly adhering gypsum panels to continuous substrate.
 1. Use adhesives that have a VOC content of 50 g/L or less when calculated according to 40 CFR 59, Subpart D (EPA Method 24).
- C. Steel Drill Screws: ASTM C 1002, unless otherwise indicated.
 1. Use screws complying with ASTM C 954 for fastening panels to steel members from 0.033 to 0.112 inch thick.
- D. Sound Attenuation Blankets: ASTM C 665, Type I (blankets without membrane facing) produced by combining thermosetting resins with mineral fibers manufactured from glass, slag wool, or rock wool.
 1. Fire-Resistance-Rated Assemblies: Comply with mineral-fiber requirements of assembly.
- E. Acoustical Sealant: Subject to compliance with requirements, products that may be incorporated into the Work include, but are not limited to, the following:
 1. Use sealants that have a VOC content of 250 g/L or less when calculated according to 40 CFR 59, Subpart D (EPA Method 24).
 2. Acoustical Sealant for Exposed and Concealed Joints:
 - a. Pecora Corp.; AC-20 FTR Acoustical and Insulation Sealant.
 - b. USG Corporation.; SHEETROCK Acoustical Sealant.
 3. Acoustical Sealant for Concealed Joints:
 - a. Ohio Sealants, Inc.; Pro-Series SC-170 Rubber Base Sound Sealant.
 - b. Pecora Corp.; BA-98.
 - c. Tremco, Inc.; Tremco Acoustical Sealant.

2.08 IDENTIFICATION LABELS FOR FIRE- AND SMOKE-PARTITIONS

- A. Identification Labels: Vinyl adhesive signs, to comply with applicable local Code.
 - 1. Available Manufacturers: Subject to compliance with requirements, manufacturers offering products that may be incorporated into the Work include, but are not limited to, the following:
 - a. Fire Wall Signs, Inc.
 - b. Safety Supply Warehouse.
 - 2. Text: "FIRE AND SMOKE BARRIER - PROTECT ALL OPENINGS"

PART 3 - EXECUTION

3.01 EXAMINATION

- A. Examine areas and substrates, with Installer present, and including welded hollow-metal frames and framing, for compliance with requirements and other conditions affecting performance.
- B. Examine panels before installation. Reject panels that are wet, moisture damaged, and mold damaged.
- C. Proceed with installation only after unsatisfactory conditions have been corrected.

3.02 PREPARATION

- A. Suspended Assemblies: Coordinate installation of suspension systems with installation of overhead structure to ensure that inserts and other provisions for anchorages to building structure have been installed to receive hangers at spacing required to support the Work and that hangers will develop their full strength.
 - 1. Furnish concrete inserts and other devices indicated to other trades for installation in advance of time needed for coordination and construction.

3.03 INSTALLATION, GENERAL

- A. Installation Standard: ASTM C 754. Also comply with requirements in ASTM C 840 that apply to framing installation.
- B. Install supplementary framing, and blocking to support fixtures, equipment services, heavy trim, grab bars, toilet accessories, furnishings, or similar construction.
- C. Install bracing at terminations in assemblies.
- D. Do not bridge building control and expansion joints with non-load-bearing steel framing members. Frame both sides of joints independently.

3.04 INSTALLING SUSPENSION SYSTEMS

- A. Install suspension system components in sizes and spacings indicated on Drawings, but not less than those required by referenced installation standards for assembly types and other assembly components indicated.
- B. Isolate suspension systems from building structure where they abut or are penetrated by building structure to prevent transfer of loading imposed by structural movement.
- C. Suspend hangers from building structure as follows:
 - 1. Install hangers plumb and free from contact with insulation or other objects within ceiling plenum that are not part of supporting structural or suspension system.
 - a. Splay hangers only where required to miss obstructions and offset resulting horizontal forces by bracing, countersplaying, or other equally effective means.
 - 2. Where width of ducts and other construction within ceiling plenum produces hanger spacings that interfere with locations of hangers required to support standard suspension system members, install supplemental suspension members and hangers in the form of trapezes or equivalent devices.
 - a. Size supplemental suspension members and hangers to support ceiling loads within performance limits established by referenced installation standards.
 - 3. Wire Hangers: Secure by looping and wire tying, either directly to structures or to inserts, eye screws, or other devices and fasteners that are secure and appropriate for substrate, and in a manner that will not cause hangers to deteriorate or otherwise fail.
 - 4. Flat Hangers: Secure to structure, including intermediate framing members, by attaching to inserts, eye screws, or other devices and fasteners that are secure and appropriate for structure and hanger, and in a manner that will not cause hangers to deteriorate or otherwise fail.
 - 5. Do not attach hangers to steel roof deck.
 - 6. Do not attach hangers to permanent metal forms. Furnish cast-in-place hanger inserts that extend through forms.
 - 7. Do not attach hangers to rolled-in hanger tabs of composite steel floor deck.
 - 8. Do not connect or suspend steel framing from ducts, pipes, or conduit.
- D. Fire-Resistance-Rated Assemblies: Wire tie furring channels to supports.
- E. Seismic Bracing: Sway-brace suspension systems with hangers used for support.
- F. Grid Suspension Systems: Attach perimeter wall track or angle where grid suspension systems meet vertical surfaces. Mechanically join main beam and cross-furring members to each other and butt-cut to fit into wall track.

- G. Installation Tolerances: Install suspension systems that are level to within [1/8 inch in 12 feet measured lengthwise on each member that will receive finishes and transversely between parallel members that will receive finishes.

3.05 INSTALLING FRAMED ASSEMBLIES

- A. Where studs are installed directly against exterior masonry walls or dissimilar metals at exterior walls, install isolation strip between studs and exterior wall.
- B. Install studs so flanges within framing system point in same direction.
- C. Install tracks (runners) at floors and overhead supports. Extend framing full height to structural supports or substrates above suspended ceilings, except where partitions are indicated to terminate at suspended ceilings. Continue framing around ducts penetrating partitions above ceiling.
 - 1. Slip-Type Head Joints: Where framing extends to overhead structural supports, install to produce joints at tops of framing systems that prevent axial loading of finished assemblies.
 - 2. Door Openings: Screw vertical studs at jambs to jamb anchor clips on doorframes; install runner track section (for cripple studs) at head and secure to jamb studs.
 - a. Install two studs at each jamb, unless otherwise indicated.
 - b. Install cripple studs at head adjacent to each jamb stud, with a minimum 1/2-inch clearance from jamb stud to allow for installation of control joint in finished assembly.
 - c. Extend jamb studs through suspended ceilings and attach to underside of overhead structure.
 - 3. Other Framed Openings: Frame openings other than door openings the same as required for door openings, unless otherwise indicated. Install framing below sills of openings to match framing required above door heads.
 - 4. Fire-Resistance-Rated Partitions: Install framing to comply with fire-resistance-rated assembly indicated and support closures and to make partitions continuous from floor to underside of solid structure.
 - a. Firestop Track: Where indicated, install to maintain continuity of fire-resistance-rated assembly indicated.
 - 5. Sound-Rated Partitions: Install framing to comply with sound-rated assembly indicated.
- D. Direct Furring: Attach to concrete or masonry with stub nails, screws designed for masonry attachment, or powder-driven fasteners spaced 24 inches o.c.
- E. Z-Furring Members:

1. Erect insulation vertically and hold in place with Z-furring members spaced 24 inches o.c.
2. Except at exterior corners, securely attach narrow flanges of furring members to wall with concrete stub nails, screws designed for masonry attachment, or powder-driven fasteners spaced 24 inches o.c.
3. At exterior corners, attach wide flange of furring members to wall with short flange extending beyond corner; on adjacent wall surface, screw-attach short flange of furring channel to web of attached channel. At interior corners, space second member no more than 12 inches from corner and cut insulation to fit.

3.06 APPLYING AND FINISHING PANELS, GENERAL

- A. Comply with ASTM C 840.
- B. Install ceiling panels across framing to minimize the number of abutting end joints and to avoid abutting end joints in central area of each ceiling. Stagger abutting end joints of adjacent panels not less than one framing member.
- C. Install panels with face side out. Butt panels together for a light contact at edges and ends with not more than 1/16 inch of open space between panels. Do not force into place.
- D. Locate edge and end joints over supports, except in ceiling applications where intermediate supports or gypsum board back blocking is provided behind end joints. Do not place tapered edges against cut edges or ends. Stagger vertical joints on opposite sides of partitions. Do not make joints other than control joints at corners of framed openings.
- E. Form control and expansion joints with space between edges of adjoining gypsum panels.
- F. Cover both faces of support framing with gypsum panels in concealed spaces (above ceilings, etc.), except in chases braced internally.
 1. Unless concealed application is indicated or required for sound, fire, air, or smoke ratings, coverage may be accomplished with scraps of not less than 8 sq. ft. in area.
 2. Fit gypsum panels around ducts, pipes, and conduits.
 3. Where partitions intersect structural members projecting below underside of floor/roof slabs and decks, cut gypsum panels to fit profile formed by structural members; allow 1/4- to 3/8-inch- wide joints to install sealant.
- G. Isolate perimeter of gypsum board applied to non-load-bearing partitions at structural abutments, except floors. Provide 1/4- to 1/2-inch- wide spaces at these locations, and trim edges with edge trim where edges of panels are exposed. Seal joints between edges and abutting structural surfaces with acoustical sealant.

- H. Attachment to Steel Framing: Attach panels so leading edge or end of each panel is attached to open (unsupported) edges of stud flanges first.

3.07 APPLYING INTERIOR GYPSUM BOARD

A. Single-Layer Application:

1. On ceilings, apply gypsum panels before wall/partition board application to greatest extent possible and at right angles to framing, unless otherwise indicated.
2. On partitions/walls, apply gypsum panels to minimize end joints.
3. On Z-furring members, apply gypsum panels vertically (parallel to framing) with no end joints. Locate edge joints over furring members.
4. Fastening Methods: Apply gypsum panels to supports with steel drill screws.

B. Multilayer Application:

1. On ceilings, apply gypsum board indicated for base layers before applying base layers on walls/partitions; apply face layers in same sequence. Apply base layers at right angles to framing members and offset face-layer joints 1 framing member, 16 inches minimum, from parallel base-layer joints, unless otherwise indicated or required by fire-resistance-rated assembly.
2. On partitions/walls, apply gypsum board indicated for base layers and face layers vertically (parallel to framing) with joints of base layers located over stud or furring member and face-layer joints offset at least one stud or furring member with base-layer joints, unless otherwise indicated or required by fire-resistance-rated assembly. Stagger joints on opposite sides of partitions.
3. On Z-furring members, apply base layer vertically (parallel to framing) and face layer either vertically (parallel to framing) or horizontally (perpendicular to framing) with vertical joints offset at least one furring member. Locate edge joints of base layer over furring members.
4. Fastening Methods: Fasten base layers and face layers separately to supports with screws.

- C. Laminating to Substrate: Where gypsum panels are indicated as directly adhered to a substrate (other than studs, joists, furring members, or base layer of gypsum board), comply with gypsum board manufacturer's written recommendations and temporarily brace or fasten gypsum panels until fastening adhesive has set.

3.08 INSTALLING TRIM ACCESSORIES

- A. General: For trim with back flanges intended for fasteners, attach to framing with same fasteners used for panels. Otherwise, attach trim according to manufacturer's written instructions.
- B. Control Joints: Install control joints according to ASTM C 840 and in specific locations approved by Engineer for visual effect.
- C. Interior Trim: Install in the following locations:

1. Cornerbead: Use at outside corners, unless otherwise indicated.
2. LC-Bead: Use at exposed panel edges.

D. Aluminum Trim: Install in locations indicated on Drawings.

3.09 FINISHING GYPSUM BOARD

- A. General: Treat gypsum board joints, interior angles, edge trim, control joints, penetrations, fastener heads, surface defects, and elsewhere as required to prepare gypsum board surfaces for decoration. Promptly remove residual joint compound from adjacent surfaces.
- B. Prefill open joints, rounded or beveled edges, and damaged surface areas.
- C. Apply joint tape over gypsum board joints, except those with trim having flanges not intended for tape.
- D. Gypsum Board Finish Levels: Finish panels to levels indicated below:
 1. Level 1: Ceiling plenum areas and concealed areas not exposed to view.
 2. Level 4: Panel surfaces that will be exposed to view (typical panels).

3.10 INSTALLING IDENTIFICATION FOR FIRE- AND SMOKE-PARTITIONS

- A. Marking and Identification for Fire- and Smoke-Partitions: Permanently install as required by Code.

3.11 PROTECTION

- A. Protect installed products from damage from weather, condensation, direct sunlight, construction, and other causes during remainder of the construction period.
- B. Remove and replace panels that are wet, moisture damaged, or exhibit mold growth. Repair of damaged panels in place is not acceptable.
 1. Indications that panels are wet or moisture damaged include, but are not limited to, discoloration, sagging, or irregular shape.
 2. Indications that panels are mold damaged include, but are not limited to, fuzzy or splotchy surface contamination and discoloration.

END OF SECTION

(THIS PAGE INTENTIONALLY LEFT BLANK)

SECTION 09651

RESILIENT WALL BASE AND ACCESSORIES

PART 1 - GENERAL

1.1 GENERAL PROVISIONS

- A. Attention is directed to the CONTRACT AND GENERAL CONDITIONS and all Sections within DIVISION 01 - GENERAL REQUIREMENTS which are hereby made a part of this Section of the Specifications.

1.2 DESCRIPTION OF WORK

- A. Work Included: Provide labor, materials and equipment necessary to complete the work of this Section, including but not limited to the following:
 - 1. Resilient wall base.

1.3 SUBMITTALS

- A. Product Data: For each type of product indicated.
- B. Samples for Verification: Full-size units of each color and pattern of resilient wall base and accessories required.
 - 1. Resilient Wall Base and Accessories: Manufacturer's standard-size Samples, but not less than 12 inches long, of each resilient product color and pattern required.

1.4 DELIVERY, STORAGE, AND HANDLING

- A. Store resilient products and installation materials in dry spaces protected from the weather, with ambient temperatures maintained within range recommended by manufacturer, but not less than 50 deg F or more than 90 deg F. Store tiles on flat surfaces.

PART 2 - PRODUCTS

2.1 RESILIENT WALL BASE

- A. Resilient Wall Base: ASTM F 1861.
 - 1. Armstrong World Industries, Inc.
 - 2. Burke Flooring Products.
 - 3. Johnsonite, a division of Tarkett.
 - 4. Marley Flexco (USA), Inc.

5. Nora Systems, Inc.
6. Roppe Corporation.

B. Style and Colors: As selected by Architect.

1. Type (Material Requirement): TS (rubber, vulcanized thermoset) or TP (rubber, thermoplastic).
2. Shape: Straight (toeless).
3. Minimum Thickness: 0.125 inch.
4. Height: 4 inches.
5. Lengths: Cut lengths 48 inches long or coils in manufacturer's standard length.
6. Surface: Smooth.

2.2 INSTALLATION MATERIALS

- A. Adhesives: Water-resistant type recommended by manufacturer to suit resilient products and substrate conditions indicated.

PART 3 - EXECUTION

3.1 EXAMINATION

- A. Examine substrates, with Installer present, for compliance with requirements for installation tolerances, moisture content, and other conditions affecting performance.

3.2 PREPARATION

- A. Prepare substrates according to manufacturer's written recommendations to ensure adhesion of resilient products.
- B. Remove substrate coatings and other substances that are incompatible with adhesives and that contain soap, wax, oil, or silicone, using mechanical methods recommended by manufacturer. Do not use solvents.
- C. Move resilient products and installation materials into spaces where they will be installed at least 48 hours in advance of installation.
1. Do not install resilient products until they are same temperature as space where they are to be installed.

3.3 RESILIENT WALL BASE INSTALLATION

- A. Apply wall base to walls, columns, pilasters, casework and cabinets in toe spaces, and other permanent fixtures in rooms and areas where base is required.
- B. Install wall base in lengths as long as practicable without gaps at seams and with tops of adjacent pieces aligned.

- C. Tightly adhere wall base to substrate throughout length of each piece, with base in continuous contact with horizontal and vertical substrates.
- D. Do not stretch wall base during installation.
- E. On masonry surfaces or other similar irregular substrates, fill voids along top edge of wall base with manufacturer's recommended adhesive filler material.

3.4 CLEANING AND PROTECTION

- A. Perform the following operations immediately after completing resilient product installation:
 - 1. Remove adhesive and other blemishes from exposed surfaces.

END OF SECTION

(THIS PAGE INTENTIONALLY LEFT BLANK)

SECTION 09900

PAINTING AND COATING

PART 1 - GENERAL

1.01 GENERAL PROVISIONS

- A. Attention is directed to the CONTRACT AND GENERAL CONDITIONS and all Sections within DIVISION 01 - GENERAL REQUIREMENTS which are hereby made a part of this Section of the Specifications.

1.02 DESCRIPTION OF WORK

- A. Work Included: Provide labor, materials and equipment necessary to complete the work of this Section, including but not limited to the following:
 - 1. Field painting of exposed interior items and surfaces.
 - 2. Field painting of exposed exterior items and surfaces.
 - 3. Surface preparation for painting.
- B. Related Work: The following items are not included in this Section and are specified under the designated Sections:
 - 1. Section 05120 - STRUCTURAL STEEL FRAMING for shop priming structural steel.
 - 2. Section 05500 - METAL FABRICATIONS for shop priming ferrous metal.
 - 3. Section 06402 - INTERIOR ARCHITECTURAL WOODWORK for shop priming interior architectural woodwork.
 - 4. Section 09211 - GYPSUM BOARD ASSEMBLIES for surface preparation of gypsum board.

1.03 DEFINITIONS AND EXTENT

- A. General: Standard coating terms defined in ASTM D 16 apply to this Section.
 - 1. Flat refers to a lusterless or matte finish with a gloss range below 15 when measured at an 85-degree meter.
 - 2. Eggshell refers to low-sheen finish with a gloss range between 20 and 35 when measured at a 60-degree meter.
 - 3. Semigloss refers to medium-sheen finish with a gloss range between 35 and 70 when measured at a 60-degree meter.
 - 4. Full gloss refers to high-sheen finish with a gloss range more than 70 when measured at a 60-degree meter.

- B. This Section includes surface preparation and field painting of exposed exterior and interior items and surfaces.
1. Surface preparation, priming, and finish coats specified in this Section are in addition to shop priming and surface treatment specified in other Sections.
- C. Paint exposed surfaces, except where these Specifications indicate that the surface or material is not to be painted or is to remain natural. If an item or a surface is not specifically mentioned, paint the item or surface the same as similar adjacent materials or surfaces. If a color of finish is not indicated, Engineer will select from standard colors and finishes available.
1. Painting includes field painting of exposed bare and covered pipes and ducts (including color coding), hangers, exposed steel and iron supports, and surfaces of mechanical and electrical equipment that do not have a factory-applied final finish.
- D. Do NOT paint prefinished items, concealed surfaces, finished metal surfaces, operating parts, and labels.
1. Prefinished items include the following factory-finished components:
 - a. Architectural woodwork.
 - b. Finished mechanical and electrical equipment.
 - c. Light fixtures.
 2. Concealed surfaces include walls or ceilings in the following generally inaccessible spaces:
 - a. Foundation spaces.
 - b. Furred areas.
 - c. Ceiling plenums.
 - d. Utility tunnels.
 - e. Pipe spaces.
 - f. Duct shafts.
 - g. Elevator shafts.
 3. Finished metal surfaces include the following:
 - a. Anodized aluminum.
 - b. Stainless steel.
 - c. Chromium plate.
 - d. Copper and copper alloys.
 - e. Bronze and brass.
 4. Operating parts include moving parts of operating equipment and the following:
 - a. Valve and damper operators.

- b. Linkages.
 - c. Sensing devices.
 - d. Motor and fan shafts.
5. Labels: Do not paint over UL, FMG, or other code-required labels or equipment name, identification, performance rating, or nomenclature plates.

1.04 SUBMITTALS

- A. Product Data: For each paint system indicated. Include block fillers and primers.
- 1. Material List: An inclusive list of required coating materials. Indicate each material and cross-reference specific coating, finish system, and application. Identify each material by manufacturer's catalog number and general classification.
 - 2. Manufacturer's Information: Manufacturer's technical information, including label analysis and instructions for handling, storing, and applying each coating material.
- B. Samples for Verification: For each color and material to be applied, with texture to simulate actual conditions, on representative Samples of the actual substrate.
- 1. Provide stepped Samples, defining each separate coat, including block fillers and primers. Use representative colors when preparing Samples for review. Resubmit until required sheen, color, and texture are achieved.
 - 2. Provide a list of materials and applications for each coat of each Sample. Label each Sample for location and application.
 - 3. Submit two eight inch by 12 inch Samples for each type of finish coating for Engineer's review of color and texture only.
- C. Qualification Data: For Applicator.

1.05 QUALITY ASSURANCE

- A. Applicator Qualifications: A firm or individual experienced in applying paints and coatings similar in material, design, and extent to those indicated for this Project, whose work has resulted in applications with a record of successful in-service performance.
- B. Source Limitations: Obtain block fillers and primers for each coating system from the same manufacturer as the finish coats.
- C. Mockups: Provide a full-coat benchmark finish sample for each type of coating and substrate required. Comply with procedures specified in PDCA P5. Duplicate finish of approved sample Submittals.
- 1. Engineer will select one room or surface to represent surfaces and conditions for application of each type of coating and substrate.

- a. Wall Surfaces: Provide samples on at least 100 sq. ft.
 - b. Small Areas and Items: Engineer will designate items or areas required.
2. Apply benchmark samples, according to requirements for the completed Work, after permanent lighting and other environmental services have been activated. Provide required sheen, color, and texture on each surface.
 - a. After finishes are accepted, Engineer will use the room or surface to evaluate coating systems of a similar nature.
 3. Final approval of colors will be from benchmark samples.

1.06 DELIVERY, STORAGE, AND HANDLING

- A. Deliver materials to Project site in manufacturer's original, unopened packages and containers bearing manufacturer's name and label and the following information:
 1. Product name or title of material.
 2. Product description (generic classification or binder type).
 3. Manufacturer's stock number and date of manufacture.
 4. Contents by volume, for pigment and vehicle constituents.
 5. Thinning instructions.
 6. Application instructions.
 7. Color name and number.
 8. VOC content.
- B. Store materials not in use in tightly covered containers in a well-ventilated area at a minimum ambient temperature of 45 deg F. Maintain storage containers in a clean condition, free of foreign materials and residue.
 1. Protect from freezing. Keep storage area neat and orderly. Remove oily rags and waste daily.

1.07 PROJECT CONDITIONS

- A. Apply waterborne paints only when temperatures of surfaces to be painted and surrounding air are between 50 and 90 deg F.
- B. Apply solvent-thinned paints only when temperatures of surfaces to be painted and surrounding air are between 45 and 95 deg F.
- C. Do not apply paint in snow, rain, fog, or mist; or when relative humidity exceeds 85 percent; or at temperatures less than 5 deg F above the dew point; or to damp or wet surfaces.
 1. Painting may continue during inclement weather if surfaces and areas to be painted are enclosed and heated within temperature limits specified by manufacturer during application and drying periods.

1.08 EXTRA MATERIALS

- A. Furnish extra materials that match and are from same production runs as products installed and that are packaged with protective covering for storage and identified with labels describing contents.
 - 1. Paint: Furnish two unopened gallons of each type of paint and coating work, in color and gloss as used for the Project.

PART 2 - PRODUCTS

2.01 MANUFACTURERS

- A. Available Products: Subject to compliance with requirements, products that may be incorporated into the Work are listed in the Finish Schedule at the end of this Section.

2.02 PAINT MATERIALS, GENERAL

- A. Material Compatibility: Provide block fillers, primers, and finish-coat materials that are compatible with one another and with the substrates indicated under conditions of service and application, as demonstrated by manufacturer based on testing and field experience.
- B. Material Quality: Provide manufacturer's best-quality paint material of the various coating types specified that are factory formulated and recommended by manufacturer for application indicated. Paint-material containers not displaying manufacturer's product identification will not be acceptable.
 - 1. Proprietary Names: Use of manufacturer's proprietary product names to designate colors or materials is not intended to imply that products named are required to be used to the exclusion of equivalent products of other manufacturers. Furnish manufacturer's material data and certificates of performance for proposed substitutions.
 - 2. Colors: As selected by Engineer.
- C. VOC Content for Interior Paints and Coatings: Products shall comply with VOC limits of authorities having jurisdiction and, for interior paints and coatings applied at Project site, the following VOC limits, exclusive of colorants added to a tint base, when calculated according to 40 CFR 59, Subpart D (EPA Method 24).
 - 1. Flat Paints and Coatings: 50 g/L.
 - 2. Nonflat Paints and Coatings: 150 g/L.
 - 3. Dry-Fog Coatings: 400 g/L.
 - 4. Primers, Sealers, and Undercoaters: 200 g/L.
 - 5. Anticorrosive and Antirust Paints Applied to Ferrous Metals: 250 g/L.
 - 6. Zinc-Rich Industrial Maintenance Primers: 340 g/L.
 - 7. Pretreatment Wash Primers: 420 g/L.

8. Floor Coatings: 100 g/L.
9. Shellacs, Clear: 730 g/L.
10. Shellacs, Pigmented: 550 g/L.

PART 3 - EXECUTION

3.01 EXAMINATION

- A. Examine substrates, areas, and conditions, with Applicator present, for compliance with requirements for paint application.
 1. Proceed with paint application only after unsatisfactory conditions have been corrected and surfaces receiving paint are thoroughly dry.
 2. Start of painting will be construed as Applicator's acceptance of surfaces and conditions within a particular area.
- B. Coordination of Work: Review other Sections in which primers are provided to ensure compatibility of the total system for various substrates. On request, furnish information on characteristics of finish materials to ensure use of compatible primers.
 1. Notify Engineer about anticipated problems when using the materials specified over substrates primed by others.

3.02 PREPARATION

- A. General: Remove hardware and hardware accessories, plates, machined surfaces, lighting fixtures, and similar items already installed that are not to be painted. If removal is impractical or impossible because of size or weight of the item, provide surface-applied protection before surface preparation and painting.
 1. After completing painting operations in each space or area, reinstall items removed using workers skilled in the trades involved.
- B. Cleaning: Before applying paint or other surface treatments, clean substrates of substances that could impair bond of the various coatings. Remove oil and grease before cleaning.
 1. Schedule cleaning and painting so dust and other contaminants from the cleaning process will not fall on wet, newly painted surfaces.
- C. Surface Preparation: Clean and prepare surfaces to be painted according to manufacturer's written instructions and technical bulletins for each particular substrate condition and as specified.
 1. Provide barrier coats over incompatible primers or remove and reprime.
 2. Cementitious Materials: Prepare concrete, concrete unit masonry, cement plaster, and mineral-fiber-reinforced cement panel surfaces to be painted. Remove

efflorescence, chalk, dust, dirt, grease, oils, and release agents. Roughen as required to remove glaze. If hardeners or sealers have been used to improve curing, use mechanical methods of surface preparation.

- a. Use abrasive blast-cleaning methods if recommended by paint manufacturer.
 - b. Determine alkalinity and moisture content of surfaces by performing appropriate tests. If surfaces are sufficiently alkaline to cause the finish paint to blister and burn, correct this condition before application. Do not paint surfaces if moisture content exceeds that permitted in manufacturer's written instructions.
 - c. Clean concrete floors to be painted with a 5 percent solution of muriatic acid or other etching cleaner. Flush the floor with clean water to remove acid, neutralize with ammonia, rinse, allow to dry, and vacuum before painting.
3. Wood: Clean surfaces of dirt, oil, and other foreign substances with scrapers, mineral spirits, and sandpaper, as required. Sand surfaces exposed to view smooth and dust off.
- a. Scrape and clean small, dry, seasoned knots, and apply a thin coat of white shellac or other recommended knot sealer before applying primer. After priming, fill holes and imperfections in finish surfaces with putty or plastic wood filler. Sand smooth when dried.
 - b. Prime, stain, or seal wood to be painted immediately on delivery. Prime edges, ends, faces, undersides, and back sides of wood, including cabinets, counters, cases, and paneling.
 - c. If transparent finish is required, backprime with spar varnish.
 - d. Backprime paneling on interior partitions where masonry, plaster, or other wet wall construction occurs on back side.
 - e. Seal tops, bottoms, and cutouts of unprimed wood doors with a heavy coat of varnish or sealer immediately on delivery.
4. Ferrous Metals: Clean ungalvanized ferrous-metal surfaces that have not been shop coated; remove oil, grease, dirt, loose mill scale, and other foreign substances. Use solvent or mechanical cleaning methods that comply with SSPC's recommendations.
- a. Exterior Exposed Steel: Clean steel surfaces in accordance with SSPC-SP 6/NACE No. 3 Commercial Blast Cleaning. Abrasive blast cleaned surfaces shall exhibit a uniform, angular profile of 1.5-3.0 mils. Prime cleaned surfaces within 8 hours and prior to surface rusting.
 - b. Interior Exposed Steel, in Humid Environments: Clean steel surfaces in accordance with SSPC-SP 6/NACE No. 3 Commercial Blast Cleaning. Abrasive blast cleaned surfaces shall exhibit a uniform, angular profile of 1.5-3.0 mils. Prime cleaned surfaces within 8 hours and prior to surface rusting.

- c. Interior Exposed Steel, in Dry Environments: Clean steel surfaces in accordance with SSPC-SP2 or SP3 Hand or Power Tool Cleaning.
 5. Galvanized Surfaces: Clean galvanized surfaces in accordance with SSPC-SP16 Brush off Blast Cleaning of Galvanized Steel and NonFerrous Metals, to achieve a minimum 1 mil anchor profile.
- D. Material Preparation: Mix and prepare paint materials according to manufacturer's written instructions.
1. Maintain containers used in mixing and applying paint in a clean condition, free of foreign materials and residue.
 2. Stir material before application to produce a mixture of uniform density. Stir as required during application. Do not stir surface film into material. If necessary, remove surface film and strain material before using.
 3. Use only thinners approved by paint manufacturer and only within recommended limits.
- E. Tinting: Tint each undercoat a lighter shade to simplify identification of each coat when multiple coats of same material are applied. Tint undercoats to match the color of the finish coat, but provide sufficient differences in shade of undercoats to distinguish each separate coat.

3.03 APPLICATION

- A. General: Apply paint according to manufacturer's written instructions. Use applicators and techniques best suited for substrate and type of material being applied.
1. Paint colors, surface treatments, and finishes are indicated in the paint schedules.
 2. Do not paint over dirt, rust, scale, grease, moisture, scuffed surfaces, or conditions detrimental to formation of a durable paint film.
 3. Provide finish coats that are compatible with primers used.
 4. The term "exposed surfaces" includes areas visible when permanent or built-in fixtures, grilles, convector covers, covers for finned-tube radiation, and similar components are in place. Extend coatings in these areas, as required, to maintain system integrity and provide desired protection.
 5. Paint surfaces behind movable equipment and furniture the same as similar exposed surfaces. Before final installation of equipment, paint surfaces behind permanently fixed equipment or furniture with prime coat only.
 6. Paint interior surfaces of ducts with a flat, nonspecular black paint where visible through registers or grilles.
 7. Paint backsides of access panels and removable or hinged covers to match exposed surfaces.
 8. Finish exterior doors and doors in wet areas on tops, bottoms, and side edges the same as exterior faces.
 9. Sand lightly between each succeeding enamel or varnish coat.

- B. Scheduling Painting: Apply first coat to surfaces that have been cleaned, pretreated, or otherwise prepared for painting as soon as practicable after preparation and before subsequent surface deterioration.
1. The number of coats and film thickness required are the same regardless of application method. Do not apply succeeding coats until previous coat has cured as recommended by manufacturer. If sanding is required to produce a smooth, even surface according to manufacturer's written instructions, sand between applications.
 2. Omit primer over metal surfaces that have been shop primed and touchup painted.
 3. If undercoats, stains, or other conditions show through final coat of paint, apply additional coats until paint film is of uniform finish, color, and appearance. Give special attention to ensure that edges, corners, crevices, welds, and exposed fasteners receive a dry film thickness equivalent to that of flat surfaces.
 4. Allow sufficient time between successive coats to permit proper drying. Do not recoat surfaces until paint has dried to where it feels firm, and does not deform or feel sticky under moderate thumb pressure, and until application of another coat of paint does not cause undercoat to lift or lose adhesion.
- C. Application Procedures: Apply paints and coatings by brush, roller, spray, or other applicators according to manufacturer's written instructions.
1. Brushes: Use brushes best suited for type of material applied. Use brush of appropriate size for surface or item being painted.
 2. Rollers: Use rollers of carpet, velvet-back, or high-pile sheep's wool as recommended by manufacturer for material and texture required.
 3. Spray Equipment: Use airless spray equipment with orifice size as recommended by manufacturer for material and texture required.
- D. Minimum Coating Thickness: Apply paint materials no thinner than manufacturer's recommended spreading rate to achieve dry film thickness indicated. Provide total dry film thickness of the entire system as recommended by manufacturer.
- E. Mechanical and Electrical Work: Painting of mechanical and electrical work is limited to items exposed in equipment rooms and occupied spaces.
- F. Mechanical items to be painted include, but are not limited to, the following:
1. Uninsulated metal piping.
 2. Uninsulated plastic piping.
 3. Pipe hangers and supports.
 4. Tanks that do not have factory-applied final finishes.
 5. Visible portions of internal surfaces of metal ducts, without liner, behind air inlets and outlets.
 6. Duct, equipment, and pipe insulation having "all-service jacket" or other paintable jacket material.

7. Mechanical equipment that is indicated to have a factory-primed finish for field painting.
 8. Process pipe.
 9. Ductile iron.
 10. PVC.
- G. Electrical items to be painted include, but are not limited to, the following:
1. Switchgear.
 2. Panelboards.
 3. Electrical equipment that is indicated to have a factory-primed finish for field painting.
- H. Block Fillers: Apply block fillers to concrete masonry block at a rate to ensure complete coverage with pores filled.
- I. Prime Coats: Before applying finish coats, apply a prime coat, as recommended by manufacturer, to material that is required to be painted or finished and that has not been prime coated by others. Recoat primed and sealed surfaces where evidence of suction spots or unsealed areas in first coat appears, to ensure a finish coat with no burn-through or other defects due to insufficient sealing.
- J. Pigmented (Opaque) Finishes: Completely cover surfaces as necessary to provide a smooth, opaque surface of uniform finish, color, appearance, and coverage. Cloudiness, spotting, holidays, laps, brush marks, runs, sags, ropiness, or other surface imperfections will not be acceptable.
- K. Completed Work: Match approved samples for color, texture, and coverage. Remove, refinish, or repaint work not complying with requirements.

3.04 FIELD QUALITY CONTROL

- A. The Owner reserves the right to invoke the following test procedure at any time and as often as the Owner deems necessary during the period when paint is being applied:
1. The Owner will engage a qualified independent testing agency to sample paint material being used. Samples of material delivered to Project will be taken, identified, sealed, and certified in the presence of Contractor.
 2. Testing agency will perform appropriate tests for the following characteristics as required by the Engineer.
 3. The Engineer may direct Contractor to stop painting if test results show material being used does not comply with specified requirements. Contractor shall remove noncomplying paint from Project site, pay for testing, and repaint surfaces previously coated with the noncomplying paint. If necessary, Contractor may be required to remove noncomplying paint from previously painted surfaces if, on repainting with specified paint, the two coatings are incompatible.

3.05 CLEANING

- A. Cleanup: At the end of each workday, remove empty cans, rags, rubbish, and other discarded paint materials from Project site.
 - 1. After completing painting, clean glass and paint-spattered surfaces. Remove spattered paint by washing and scraping without scratching or damaging adjacent finished surfaces.

3.06 PROTECTION

- A. Protect work of other trades, whether being painted or not, against damage from painting. Correct damage by cleaning, repairing or replacing, and repainting, as approved by Engineer.
- B. Provide "Wet Paint" signs to protect newly painted finishes. After completing painting operations, remove temporary protective wrappings provided by others to protect their work.
 - 1. After work of other trades is complete, touch up and restore damaged or defaced painted surfaces. Comply with procedures specified in PDCA P1.

3.07 PAINT SCHEDULE

- A. Schedule: Provide products and number of coats specified. Use of manufacturer's proprietary product names to designate colors, materials, generic class, standard of quality and performance criteria and is not intended to imply that products named are required to be used to the exclusion of equivalent performing products of other manufacturers.

B. COLOR SCHEDULES

- 1. Architectural
 - a. Chosen by Owner.
- 2. Piping
 - a. Water lines
 - Raw.....Olive Green
 - Settled or Clarified.....Aqua
 - Finished or Potable.....Dark Blue
 - b. Chemical Lines
 - Alum.....Orange
 - Caustic.....Yellow with Green Band
 - Chlorine.....Yellow
 - Fluoride.....Light Blue with Red Band
 - Polymers.....Orange with Green Band
 - Potassium Permanganate..Violet
 - c. Waste Lines
 - Raw.....Gray
 - Sludge.....Brown
 - d. Miscellaneous
 - Compressed Air.....Dark Green
 - Fuel Oil.....Red

C. Exterior Paint Schedule:

1. Exterior Galvanized Metal (not shop-finished under Section 05120 - STRUCTURAL STEEL FRAMING, Section 05500 - METAL FABRICATIONS, or Section 08110 - HOLLOW METAL DOORS AND FRAMES), Aliphatic Acrylic Polyurethane System:
 - a. Surface Preparation: SSPC-SP16 Brush-off Blast of Galvanized Steel.
 - b. One Coat:
 - 1) Sherwin Williams Macropoxy 646 + Curing Compound B58 Epoxy
 - 2) Tnemec 66HS Hi-Build Epoxoline at 3.0 mils DFT.
 - 3) PPG PMC Amerlock 400 Hi-Build Epoxy at 4.0-5.0 mils DFT.
 - 4) Dupont 25P High Solids at 4.0 mils DFT.
 - c. And One Coat:
 - 1) Sherwin Williams Acrolon 218 - B65.
 - 2) Tnemec 73 Endura-Shield at 3.0 mils DFT.
 - 3) PPG PMC Amercoat 450H Polyurethane at 3.0 mils DFT.
 - 4) Dupont Imron 2.8 Urethane at 3.0 to 4.0 mils DFT.
2. Exterior Ferrous Metal, Urethane System (includes Exterior Structural Beams):
 - a. Surface Preparation: SSPC-SP6.
 - b. One Coat:
 - 1) Tnemec Zinc-Rich Primer; shop applied under other Sections; use for touch up.
 - 2) PPG PMC Amercoat 68 MCZ at 3 mils DFT; shop applied under other Sections; use for touch up
 - 3) Dupont Urethane Ganicin Zinc Rich Primer 80%zinc load at 3.0 mils DFT.
 - c. And One Coat:
 - 1) Tnemec N69/66HS Hi-Build Epoxoline at 3.0 mils DFT.
 - 2) PPG PMC Amerlock 400 Hi-Build Epoxy at 3.0 to 5.0 mils DFT.
 - 3) Dupont 25P High Solids Epoxy at 4.0 to 6.0 mils DFT.
 - d. And One Coat:
 - 1) Tnemec 73 Endura-Shield at 3.0 mils DFT.
 - 2) PPG PMC Amerlock 450H Polyurethane Topcoat at 3.0 mils DFT.
 - 3) Dupont High Solids Imron Urethane at 4.0 mils DFT.
3. Exterior Aluminum, Painted Finish:

- a. Surface Preparation: Pressure wash with Oakite and sand with 3M Scotch-Brite nylon pads.
- b. One Coat:
 - 1) Tnemec N69/66HS Hi-Build Epoxoline at 2.0 mils DFT.
 - 2) PPG PMC Amerlock 400 Hi-Build Epoxy at 2.0 to 3.0 mils DFT.
 - 3) Dupont 25P High Solids at 4.0 mils DFT.
- c. And One Coat:
 - 1) Tnemec 73 Endura-Shield at 2.0 mils DFT.
 - 2) PPG PMC Amercoat 450H Polyurethane at 3.0 mils DFT.
 - 3) Dupont High Solids Imron 2.8 at 4.0 mils DFT.

D. Interior Paint Schedule:

1. Interior Gypsum Wallboard:

- a. One Coat, Primer:
 - 1) Moore Eco Spec WB Interior Latex Primer 372.
 - 2) Duron Genesis Latex Primer.
 - 3) S-W ProMar 200 Zero-VOC Latex Wall Primer.
 - 4) PPG Pure Performance Latex Primer.
 - 5) California Paint Envirotech Zero VOC Primer 646.
- b. And Two Coats, Eggshell Finish: At walls, and elsewhere as indicated.
 - 1) Moore Eco Spec WB Interior Latex Eggshell 374.
 - 2) Duron Genesis Latex Eggshell.
 - 3) S-W ProMar 200 Zero-VOC Latex Eggshell.
 - 4) PPG Pure Performance Latex Eggshell.
 - 5) California Paint Envirotech Zero VOC Eggshell 631.

2. Interior Woodwork, Finish Carpentry, Latex Paint Finish:

- a. One Coat, Primer:
 - 1) Moore Eco Spec WB Interior Latex Primer 372.
 - 2) Duron Genesis Latex Primer.
 - 3) S-W ProMar 200 Zero-VOC Latex Primer.
 - 4) PPG Pure Performance Latex Primer.
 - 5) California Paint Envirotech Zero VOC Primer 646.
- b. And Two Coats, Semi-Gloss:
 - 1) Moore Eco Spec WB Interior Latex Semi-Gloss 376.
 - 2) Duron Genesis Latex Semi-Gloss.

- 3) S-W ProMar 200 Zero VOC Latex Semi-Gloss.
 - 4) PPG Pure Performance Latex Semi-Gloss.
 - 5) California Paint Envirotech Zero VOC Semi Gloss 663.
3. Interior Concrete Masonry Units, Epoxy/Urethane Coating:
- a. Surface Preparation: Cured, clean and dry, free of surface contaminants.
 - b. One Coat:
 - 1) Tnemec 875 Block Filler at 100 sqft/gal.
 - 2) PPG PMC Nu-Klad 965 at 100 sqft/gal.
 - 3) Dupont 25P at 100 sq/ft/gal.
 - c. And One Coat:
 - 1) Sherwin-Williams Cor-Cote B62.
 - 2) Tnemec 280 Tneme-Glaze at 6.0 8.0 mils DFT.
 - 3) PPG PMC Amercoat 351 6.0 to 8.0 mils DFT.
 - 4) Dupont 100% Solids Epoxy at 7.0 to 9.0 mils DFT.
 - d. And One Coat:
 - 1) Sherwin Williams Waberbased Acroban B65 Polyurethane 100.
 - 2) Tnemec 1080 or 1081 EnduraShield at 3.0 to 4.0 mils DFT.
 - 3) PPG PMC AmerShield VOC at 3.0 to 4.0 mils DFT.
 - 4) Dupont Imron WB Urethane at 3.0 to 4.0 mils DFT.
4. Interior Metals (Not specified to receive other coating systems/not shop finished), Epoxy Painted Finish:
- a. One Coat: Approved primer, in shop under other Sections (where specified). If not shop primed, provide primer recommended by finish coating manufacturer.
 - b. And One Coat:
 - 1) Sherwin Williams Sher-Cryl HPA High Performance Acrylic.
 - 2) Tnemec 1029 Enduratone at 2.0 mils DFT.
 - 3) PPG PMC Amerlock 400 at 2.0 to 4.0 mils DFT.
 - 4) Dupont 25P at 3.0 to 4.0 mils DFT.
 - c. And One Coat:
 - 1) Sherwin Williams Sher-Cryl HPA High Performance Acrylic.
 - 2) Tnemec 1029 Enduratone at 2.0 to 3.0 mils DFT.
 - 3) PPG PMC Amerlock 400 at 2.0 to 4.0 mils DFT.
 - 4) Dupont High Solids Acrylic Coating 3.0 mils DFT.

5. Interior Exposed Steel, Joists, Ductwork, Conduit and Similar Items (where indicated), Dry-Fall or Dry-Fog Spray Applied System:
 - a. One Coat:
 - 1) Tnemec 115 WB Unibond at 2.5 to 3.0 mils DFT.
 - 2) PPG PMC Amercoat 220 Acrylic at 3.0 mils DFT.
 - 3) International Intercryl 530 at 2.5 to 3.0 mils DFT.
 - 4) RD Coatings Muracryl at 2.0 to 3.0 mils DFT.
6. Heavy Duty Concrete Floor, Epoxy Coating System:
 - a. One Coat:
 - 1) Tnemec 201 Epoxoprime at 4.0 to 6.0 mils DFT.
 - 2) Dex-O-Tex C Bond Coat at 6.0-7.0 mils DFT.
 - 3) RD Coatings Unifix at 2.0 mils DFT.
 - b. And One Coat:
 - 1) Tnemec 206 Flexible Epoxy Underlayment at 30 to 50 mils DFT.
 - 2) Dex-O-Tex Cheminert SC Membrane at 70-80 mils DFT.
 - 3) RD Coatings Elasto Deck at 50-80 mils DFT.
 - c. And One Coat:
 - 1) Tnemec 297 at 3.0 mils DFT.
 - 2) Dex-O-Tex Quik-Glaze at 7.0-8.0 mils DFT.
 - 3) RD Coatings Muracryl at 3.0 mils DFT.
7. Concrete Floor, Clear Exposed Sealer:
 - a. One Coat:
 - 1) Sherwin Williams H+C Clear Liquid Hardener and Densifier.
 - 2) Curecrete Chemical; Ashford Formula
 - 3) Chem Probe; CT Denisifyer.
 - 4) WR Meadows; Liqui-Hard.
 - 5) L&M; Sealhard.
8. PVC Piping:
 - a. Surface preparation: Scarify prior to coating.
 - b. 1st coat: Tnemec Series 66 Epoxoline or approved equal, DFT 1.5 to 2.0 mils.
 - c. 2nd coat: Tnemec Series 66 Epoxoline or approved equal, DFT 1.5 to 2.0 mils.

9. Ductile Iron Piping:
 - a. Surface preparation: Immersion Service-SSPC-SP-10
 - b. 1st coat: (Shop Applied) Tnemec Series 66-1211, DFT. 3.0 mils.
 - c. 2nd coat: (Field Applied) Tnemec 66, Color, DFT 4.0 mils.
 - d. 3rd coat (Field Applied) Tnemec Series 66 Color DFT 4.0 mils.

10. Carbon Steel Piping:
 - a. Surface preparation: Immersion Service- SSPC-SP-10.
 - b. 1st coat: (Shop Applied) Tnemec Series 66-1211, DFT. 3.0 mils.
 - c. 2nd coat: (Field Applied) Tnemec 66, Color, DFT 4.0 mils.
 - d. 3rd coat (Field Applied) Tnemec Series 66 Color DFT 4.0 mils.

11. Canvas and Cotton Insulation Coverings.
 - a. 1st coat: Tnemec 51-792 Sealer.
 - b. 2nd coat: Tnemec Series 6 Tneme Cryl.
 - c. 3rd coat: Tnemec Series 6 or Series 7 Tneme Cryl.

12. Miscellaneous Mechanical and Electrical Work: Paint all exposed items throughout the project except factory finished items with factory-applied baked enamel finishes which occur in mechanical rooms or areas (but not in the Mechanical Room itself), and excepting chrome or nickel plating, stainless steel, and aluminum other than mill finished. Paint all exposed ductwork and inner portion of all ductwork. Same as specified for other interior metals, hereinabove.

END OF SECTION

DIVISION 10

(THIS PAGE INTENTIONALLY LEFT BLANK)

SECTION 10140

SIGNAGE

PART 1 - GENERAL

1.01 GENERAL PROVISIONS

- A. Attention is directed to the CONTRACT AND GENERAL CONDITIONS and all Sections within DIVISION 01 - GENERAL REQUIREMENTS which are hereby made a part of this Section of the Specifications.

1.02 DESCRIPTION OF WORK

- A. Work Included: Provide labor, materials and equipment necessary to complete the work of this Section, including but not limited to the following:
 - 1. Code-required interior panel signage, including but not limited to, accessibility signage, toilet room signage and mechanical and electrical room signage.
 - 2. Interior room name and number signs.
 - 3. Exterior cast bronze memorial dedication plaque.
 - 4. Building name and location / address signs including curb cut / street location and building mounted location.
- B. Related Work: The following items are not included in this Section and are specified under the designated Sections:
 - 1. Division 16 - ELECTRICAL for illuminated exit signs.

1.03 SUBMITTALS

- A. Product Data: Include construction details, material descriptions, dimensions of individual components and profiles, and finishes for each type of sign.
- B. Shop Drawings: Include plans, elevations, and large-scale sections of typical members and other components. Show mounting methods, grounds, mounting heights, layout, spacing, reinforcement, accessories, and installation details.
 - 1. Provide message list for each sign, including large-scale details of wording, lettering, artwork, and braille layout.
- C. Samples for Verification: For each type of sign, include the following Samples to verify color selected:
 - 1. Panel Signs: Full-size Samples of each type of sign required.
 - 2. Approved samples will not be returned for installation into Project.

- D. Maintenance Data: For signage cleaning and maintenance requirements to include in maintenance manuals.

1.04 QUALITY ASSURANCE

- A. Source Limitations: Obtain each sign type through one source from a single manufacturer.
- B. Regulatory Requirements: Comply with the Massachusetts Architectural Access Board, Americans with Disabilities Act (ADA) and with code provisions as adopted by authorities having jurisdiction.

1.05 PROJECT CONDITIONS

- A. Field Measurements: Where sizes of signs are determined by dimensions of surfaces on which they are installed, verify dimensions by field measurement before fabrication and indicate measurements on Shop Drawings.

1.06 COORDINATION

- A. For signs supported by or anchored to permanent construction, advise installers of anchorage devices about specific requirements for placement of anchorage devices and similar items to be used for attaching signs.

PART 2 - PRODUCTS

2.01 PANEL SIGNS

- A. General: Provide signs that comply with requirements indicated for materials, thicknesses, finishes, colors, designs, shapes, sizes, and details of construction as indicated. Produce smooth panel sign surfaces constructed to remain flat under installed conditions within tolerance of plus or minus 1/16 inch measured diagonally. Provide the following:
 - 1. Interior Panel Signs:
 - a. Type: Photopolymer on acrylic or printed acrylic as applicable.
 - b. Color: Custom color as selected.
 - c. Type Size: As selected.
 - d. Typeface: As selected.
 - 2. Specialty Signs:
 - a. Dedication Plaques:
 - 1) General: Provide castings free from pits, scale, sand holes, and other defects. Comply with requirements specified for metal, border style, background texture, and finish and in required thickness, size, shape, and copy.
 - 2) Dimensions and Configuration: Refer to drawings.
 - 3) Location: As selected by Engineer.

- 4) Thickness: Not less than 3/8 inch (9 mm).
- 5) Material: Cast bronze.
- 6) Letters: Raised letters with polished faces in type face selected by Engineer.
- 7) Text: Layout and design, including border, will be provided by Engineer in camera-ready form.
- 8) Finish:
 - a) Raised areas: Hand-tool and buff borders and raised copy to produce manufacturer's standard satin finish.
 - b) Background finish: Painted.
- 9) Cast metal plaques shall be installed by means of concealed, vandal-resistant fastening method at interior location selected by Engineer.

B. Tactile and Braille Copy: Manufacturer's standard process for producing copy complying with ADA Accessibility Guidelines and ICC/ANSI A117.1. Text shall be accompanied by Grade 2 braille. Produce precisely formed characters with square cut edges free from burrs and cut marks.

1. Raised-Copy Thickness: Not less than 1/32 inch

C. Symbols of Accessibility: Provide 6-inch- high symbol fabricated from opaque nonreflective vinyl film, 0.0035-inch nominal thickness, with pressure-sensitive adhesive backing suitable for both exterior and interior applications.

2.02 ACCESSORIES

A. Panel Sign Mounting Methods: Use double-sided vinyl tape fabricated from materials that are not corrosive to sign material and mounting surface.

B. Anchors and Inserts: Provide nonferrous-metal or hot-dip galvanized anchors and inserts for exterior installations and elsewhere as required for corrosion resistance. Use toothed steel or lead expansion-bolt devices for drilled-in-place anchors. Furnish inserts, as required, to be set into concrete or masonry work.

PART 3 - EXECUTION

3.01 EXAMINATION

A. Examine substrates, areas, and conditions, with Installer present, for compliance with requirements for installation tolerances and other conditions affecting performance of work.

B. Verify that items provided under other sections of Work are sized and located to accommodate signs.

- C. Examine supporting members to ensure that surfaces are at elevations indicated or required to comply with authorities having jurisdiction and are free from dirt and other deleterious matter.
- D. Proceed with installation only after unsatisfactory conditions have been corrected.

3.02 INSTALLATION, GENERAL

- A. General: Locate signs and accessories where indicated, using mounting methods of types described and in compliance with manufacturer's written instructions.
 - 1. Install signs level, plumb, and at heights indicated, with sign surfaces free from distortion and other defects in appearance.
 - 2. Interior Wall Signs: Install signs on walls adjacent to latch side of door where applicable. Where not indicated or possible, such as double doors, install signs on nearest adjacent walls. Locate to allow approach within 3 inches of sign without encountering protruding objects or standing within swing of door.
- B. Wall-Mounted Panel Signs: Attach panel signs to wall surfaces using methods indicated below:
 - 1. Vinyl-Tape Mounting: Use double-sided foam tape to mount signs to smooth, nonporous surfaces. Do not use this method for vinyl-covered or rough surfaces.

3.03 INSTALLATION OF CAST METAL PLAQUES

- A. Cast-Metal Plaques: Mount plaques using standard concealed fastening methods recommended in writing by manufacturer for type of wall surface indicated.
- B. Concealed Mounting: Mount plaques by inserting threaded studs into tapped lugs on back of plaque. Set in predrilled holes filled with quick-setting cement.

3.04 CLEANING AND PROTECTION

- A. After installation, clean soiled sign surfaces according to manufacturer's written instructions. Protect signs from damage until acceptance by the Engineer.

END OF SECTION

SECTION 10280
TOILET ACCESSORIES

PART 1 - GENERAL

1.01 GENERAL PROVISIONS

- A. Attention is directed to the CONTRACT AND GENERAL CONDITIONS and all Sections within DIVISION 01 - GENERAL REQUIREMENTS which are hereby made a part of this Section of the Specifications.

1.02 DESCRIPTION OF WORK

- A. Work Included: Provide labor, materials and equipment necessary to complete the work of this Section, including but not limited to the following:
 - 1. Toilet accessories as scheduled on the Drawings.
- B. Related Work: The following items are not included in this Section and are specified under the designated Sections:
 - 1. Section 06100 - ROUGH CARPENTRY for blocking.

1.03 SUBMITTALS

- A. Product Data: For each type of product indicated. Include the following:
 - 1. Construction details and dimensions.
 - 2. Anchoring and mounting requirements, including requirements for cutouts in other work and substrate preparation.
 - 3. Material and finish descriptions.
 - 4. Features that will be included for Project.
 - 5. Manufacturer's warranty.
- B. Product Schedule: Indicating types, quantities, sizes, and installation locations by room of each accessory required.
 - 1. Identify locations using room designations indicated on Drawings.
 - 2. Identify products using designations indicated on Drawings.

- C. Maintenance Data: For toilet accessories to include in maintenance manuals.

1.04 QUALITY ASSURANCE

- A. Source Limitations: For products listed together in the same articles in Part 2, provide products of same manufacturer unless otherwise approved by Engineer.

1.05 COORDINATION

- A. Coordinate accessory locations with other work to prevent interference with clearances required for access by people with disabilities, and for proper installation, adjustment, operation, cleaning, and servicing of accessories.
- B. Deliver inserts and anchoring devices set into concrete or masonry as required to prevent delaying the Work.

PART 2 - PRODUCTS

2.01 MANUFACTURERS

- A. Available Manufacturers: Subject to compliance with requirements, manufacturers offering products that may be incorporated into the Work include, but are not limited to, the following:
 - 1. A & J Washroom Accessories, Inc.
 - 2. American Specialties, Inc.
 - 3. Bobrick Washroom Equipment, Inc.
 - 4. Bradley Corporation.

2.02 MATERIALS

- A. Stainless Steel: ASTM A 666, Type 304, 0.0312-inch minimum nominal thickness, unless otherwise indicated.
- B. Steel Sheet: ASTM A 1008/A 1008M, Designation CS (cold rolled, commercial steel), 0.0359-inch (0.9-mm) minimum nominal thickness.
- C. Galvanized Steel Mounting Devices: ASTM A 153/A 153M, hot-dip galvanized after fabrication.
- D. Fasteners: Screws, bolts, and other devices of same material as accessory unit and tamper-and-theft resistant where exposed, and of galvanized steel where concealed.

2.03 FABRICATION

- A. General: Fabricate units with tight seams and joints, and exposed edges rolled. Hang doors and access panels with full-length, continuous hinges. Equip units for concealed anchorage and with corrosion-resistant backing plates.
- B. Keys: Provide universal keys for internal access to accessories for servicing and resupplying. Provide minimum of six keys to the Owner.

PART 3 - EXECUTION

3.01 INSTALLATION

- A. Install accessories according to manufacturers' written instructions, using fasteners appropriate to substrate indicated and recommended by unit manufacturer. Install units level, plumb, and firmly anchored in locations and at heights indicated.
- B. Grab Bars: Install to withstand a downward load of at least 250 lbf, when tested according to method in ASTM F 446.

3.02 ADJUSTING AND CLEANING

- A. Adjust accessories for unencumbered, smooth operation. Replace damaged or defective items.
- B. Remove temporary labels and protective coatings.
- C. Clean and polish exposed surfaces according to manufacturer's written recommendations.

END OF SECTION

(THIS PAGE INTENTIONALLY LEFT BLANK)

SECTION 10410

EMERGENCY ACCESS AND INFORMATION CABINETS

PART 1 - GENERAL

1.01 GENERAL PROVISIONS

- A. Attention is directed to the CONTRACT AND GENERAL CONDITIONS and all Sections within DIVISION 01 - GENERAL REQUIREMENTS which are hereby made a part of this Section of the Specifications.

1.02 DESCRIPTION OF WORK

- A. Work Included: Provide labor, materials and equipment necessary to complete the work of this Section, including but not limited to the following:
 - 1. Fire department key vault box.
- B. Related Work: The following items are not included in this Section and are specified under the designated Sections:
 - 1. SECTION 04200 - UNIT MASONRY and Section 04220 - REINFORCED UNIT MASONRY for substrate.
 - 2. Section 06100 - ROUGH CARPENTRY for wood blocking.

1.03 SUBMITTALS

- A. Product Data: Submit manufacturer's product data, installation instructions, use limitations and recommendations for each product and system used. Provide manufacturer's certifications stating that products and systems comply with requirements.
- B. Shop Drawings: Provide large scale shop drawings for fabrication, installation and erection of all parts of the work. Provide plans, elevations, and details of anchorage, connections and accessory items. Provide installation templates for work installed by others.
- C. Contractor's Review: Before commencing work, submit signed statement that Contract Documents have been reviewed with a qualified representative of supplier/manufacturer, and that selected materials and construction are proper, compatible, and adequate for application shown.

PART 2 - PRODUCTS

2.01 FIRE DEPARTMENT KEY VAULT BOX

- A. Fire Department Key Vault Box: Provide at building entrance; location shall be acceptable to local Fire Department.
 - 1. Basis of Design: Knox Company; Model 3200 Knox-Box, Recessed Mounted Type.
 - 2. Finish: Weather resistant TGIC polyester powder coat, color as selected by Engineer from manufacturer's standard colors.
 - 3. Locking: Provide lock and keys acceptable to local Fire Department.
 - 4. Building Alarm Interface: Provide tamper switch interface with building alarm system.
 - 5. Accessories:
 - a. Provide manufacturer's standard recessed mounting kit, for installation in specified construction.
 - b. Provide alarm tamper switches, UL listed.

PART 3 - EXECUTION

3.01 INSPECTION

- A. Rough-In Work: Examine installation of walls and other conditions under which work is to be installed; verify dimensions of services and substrates before fabricating work.
- B. Notify Contractor of unsatisfactory locations and dimensions of other work and of unsatisfactory conditions for proper installation of equipment. Do not proceed with fabrication and installation until unsatisfactory dimensions and conditions have been corrected in manner satisfactory to Installer.

3.02 FIRE DEPARTMENT KNOX BOX INSTALLATION

- A. General: Set each item of equipment securely in place, level, and adjust to correct height, 4 ft. - 0 in. AFF, unless otherwise required by local Fire Department.
- B. Anchor to supporting substrate where indicated and where required for sustained operation and use without shifting or dislocation. Conceal anchorage where possible. Seal perimeter joints in accordance with Section 07920 - JOINT SEALANTS.

3.03 CLEANING

- A. After completion of installation and other major work remove protective coverings, if any, and clean equipment, internally and externally. Restore exposed and semi-exposed finishes to remove abrasions and other damages; polish exposed-metal surfaces and touch-up painted surfaces. Replace work that cannot be successfully restored.

END OF SECTION

(THIS PAGE INTENTIONALLY LEFT BLANK)

SECTION 10440

FIRE-PROTECTION SPECIALTIES

PART 1 - GENERAL

1.01 GENERAL PROVISIONS

- A. Attention is directed to the CONTRACT AND GENERAL CONDITIONS and all Sections within DIVISION 01 - GENERAL REQUIREMENTS which are hereby made a part of this Section of the Specifications.

1.02 DESCRIPTION OF WORK

- A. Work Included: Provide labor, materials and equipment necessary to complete the work of this Section, including but not limited to the following:
 - 1. Portable fire extinguishers.
 - 2. Mounting brackets for fire extinguishers.
- B. Related Work: The following items are not included in this Section and are specified under the designated Sections:
 - 1. Division 15 - FIRE PROTECTION for fire hose valves and standpipes.

1.03 SUBMITTALS

- A. Product Data: Include construction details, material descriptions, dimensions of individual components and profiles, and finishes for each item.
 - 1. Fire Extinguishers: Include rating and classification.
- B. Maintenance Data: For fire extinguishers to include in maintenance manuals.

1.04 QUALITY ASSURANCE

- A. Source Limitations: Obtain fire extinguishers through one source from a single manufacturer.
- B. NFPA Compliance: Fabricate and label fire extinguishers to comply with NFPA 10, "Portable Fire Extinguishers."
- C. Fire Extinguishers: Listed and labeled for type, rating, and classification by an independent testing agency acceptable to authorities having jurisdiction.

PART 2 - PRODUCTS

2.01 PORTABLE FIRE EXTINGUISHERS

- A. General: Provide fire extinguishers of type, size, and capacity for each fire-protection cabinet and mounting bracket indicated.
- B. Multipurpose Dry-Chemical Type in Steel Container: UL-rated 2-A:10-B:C, 5-lb nominal capacity, with monoammonium phosphate-based dry chemical in enameled-steel container.

2.02 MOUNTING BRACKETS

- A. Mounting Brackets: Manufacturer's standard steel, designed to secure fire extinguisher to wall or structure, of sizes required for types and capacities of fire extinguishers indicated, with plated or baked-enamel finish.
- B. Identification: Lettering complying with authorities having jurisdiction for letter style, size, spacing, and location. Locate as indicated by Engineer.

2.03 FINISHES, GENERAL

- A. Comply with NAAMM's "Metal Finishes Manual for Architectural and Metal Products" for recommendations for applying and designating finishes.
- B. Protect mechanical finishes on exposed surfaces from damage by applying a strippable, temporary protective covering before shipping.
- C. Finish fire-protection cabinets after assembly.
- D. Appearance of Finished Work: Variations in appearance of abutting or adjacent pieces are acceptable if they are within one-half of the range of approved Samples. Noticeable variations in the same piece are not acceptable. Variations in appearance of other components are acceptable if they are within the range of approved Samples and are assembled or installed to minimize contrast.

PART 3 - EXECUTION

3.01 EXAMINATION

- A. Examine walls and partitions for suitable framing depth and blocking where extinguishers will be installed.
- B. Examine fire extinguishers for proper charging and tagging. Contractor shall be responsible for fire extinguisher tagging by a certified service technician located within 75 miles of the project.
 - 1. Remove and replace damaged, defective, or undercharged units.

- C. Proceed with installation only after unsatisfactory conditions have been corrected.

3.02 INSTALLATION

- A. General: Install fire-protection specialties in locations and at mounting heights indicated on the Drawings and acceptable to authorities having jurisdiction.
- B. Mounting Brackets: Fasten mounting brackets to surfaces, square and plumb, at locations indicated.
- C. Identification: Apply vinyl lettering at locations indicated.

3.03 ADJUSTING AND CLEANING

- A. Remove temporary protective coverings and strippable films, if any, as fire-protection specialties are installed, unless otherwise indicated in manufacturer's written installation instructions.
- B. Touch up marred finishes, or replace fire-protection specialties that cannot be restored to factory-finished appearance. Use only materials and procedures recommended or furnished by fire-protection specialty manufacturer.

END OF SECTION

(THIS PAGE INTENTIONALLY LEFT BLANK)

DIVISION 11

(THIS PAGE INTENTIONALLY LEFT BLANK)

SECTION 11282

STAINLESS STEEL SLUICE GATES AND APPURTENANCES

PART 1 - GENERAL

1.1 RELATED DOCUMENTS

- A. Drawings and general provisions of the Contract, including General and Supplementary Conditions and other Division 1 Specification Sections, apply to this Section.

1.2 SUMMARY

- A. Furnish, install and test stainless steel sluice gates and appurtenances as indicated and specified.
 - 1. Sizes are indicated in the gate schedules on the Drawings.
- B. Related Sections: The following sections contain requirements that relate to this Section:
 - 1. Division 1 - General Requirements
 - 2. Section 02050 - Demolition
 - 3. Division 16 – Electrical Work

1.3 SUBMITTALS

- A. Shop Drawings and Product Data:
 - 1. Comply with the requirements of Section 01300 - Submittals.
 - 2. Submit Shop Drawings showing the following:
 - a. Complete description in sufficient detail to permit item-by-item comparison with the Specifications.
 - b. Dimensions.
 - c. Weights.
 - d. Capacity.

- e. Maximum support reactions.
- f. Performance characteristics.
- g. Layout drawing for all equipment showing installation details.
- h. Wiring diagrams for all electrical items (both internal and external)
- i. Deviations from Drawings and Specifications.
- j. Manufacturer's installation and testing instructions.
- m. Affidavits of compliance with referenced standards and codes.
 - 1. Manufacturer's standard guarantee.
- m. Submit Manufacturer's installation report as specified in Part 3.

B. Operation and Maintenance Manuals:

- 1. Comply with the Requirements of Division 1 and the Supplemental Requirements Below.
- 2. Required Operation Data:
 - a. Complete, detailed operating instructions for each piece of equipment.
 - b. Explanations of all safety considerations relating to operation.
- 3. Required Maintenance Data:
 - a. Include all information and instructions required to keep equipment properly lubricated and adjusted so that it functions economically throughout its full design life.
 - b. Explanation with illustrations as necessary for each maintenance task.
 - c. Recommended spare parts lists.
 - d. Recommended schedule of maintenance tasks.
 - e. Lubrication charts and table of alternate lubricants.
 - f. Troubleshooting instructions.

- g. List of special maintenance tools and equipment.
- h. Name, address and phone number of manufacturer and manufacturer's local service.
- i. Include copies of all approved Shop Drawings.

1.4 QUALITY ASSURANCE

A. Manufacturer's Qualifications:

- 1. Manufacturer shall have a minimum of ten years experience in producing similar type equipment, and shall show evidence of ten installations in satisfactory operation upon request.

B. Reference Standards: Comply with applicable provisions and recommendations of the following, except as otherwise shown or specified.

- 1. AWWA C561 Standard for Fabricated Stainless Steel Slide Gates.
- 2. ASTM A276, stainless and heat-resisting steel bars and shapes.
- 3. ASTM A480, stainless steel plate, sheet, and strip.
- 4. ASTM B584, copper alloy and sand castings for general application.
- 5. ASTM D4020, U.H.M.W. polyethylene molding and extrusion material.
- 6. ASTM D2000, standard classification system for rubber products in automotive applications.
- 7. ASTM B26, aluminum alloy sand castings.

1.5 DELIVERY, STORAGE AND HANDLING

A. Provide in accordance with Section 01600 and as specified.

B. Shipping:

- 1. Ship equipment, material and spare parts complete except where partial disassembly is required by transportation regulations or for protection of components.

2. Pack spare parts in containers bearing labels clearly designating contents and pieces of equipment for which intended.
3. Deliver spare parts at same time as pertaining equipment. Deliver to Owner after completion of work.

C. Receiving:

1. Inspect and inventory items upon delivery to site.
2. Store and safeguard equipment, material and spare parts in accordance with manufacturer's recommendations. Store materials to permit easy access for inspection and identification. Keep all items off ground, using pallets, platforms or other supports. Do not store items in a manner that might cause distortion or damage to that item.
3. Unload, haul, and store items.
4. Pay demurrage charges if failed to promptly unload items.
5. Assume responsibility for equipment, material and spare parts just before unloading from carrier at site.

PART 2 - PRODUCTS

2.1 MANUFACTURERS

- A. Whipps, Inc., Athol, MA.
- B. Rodney-Hunt Co., Orange, MA.
- C. Waterman Industries, Exeter, CA.
- D. Or acceptable equivalent product.

2.2 SERVICE CONDITIONS

- A. Stainless steel sluice gate sizes and other pertinent data are included in the gate schedules on the drawings.

2.3 GENERAL

- A. All gates produced by a single manufacturer and designed for installation in the structures as indicated on the drawings.

2.4 GATE ASSEMBLIES

- A. Type: self-contained, rising stem unless otherwise specified.
- B. Leakage not to exceed 0.025 gpm per foot of seal perimeter.
- C. Unless otherwise specified, all stainless steel parts, including fasteners shall be type 316 stainless steel.

2.5 MANUAL CRANK ACTUATORS

- A. Indicate the direction of operation.
- B. See Paragraph 2.15.

2.6 FRAMES

- A. Formed or extruded stainless steel construction consisting of guides, an invert member and a top member where top closure is required. Suitable reinforcements will be provided to resist all operating loads.
- B. The guide members, invert members and yoke members shall be constructed of formed stainless steel plate with a minimum thickness of 1/4-inch.
- C. Self-contained frames shall be provided with a support yoke for mounting the actuator.
 - 1. The support yoke shall consist of structural members welded or bolted to the extended guide members.
 - 2. The support yoke shall be located as required to provide full travel of the gate slide unless otherwise specified.
 - 3. The yoke shall be designed so that the maximum deflection is limited to 1/360th of the span when operating at maximum specified head.
 - 4. For gates with powered actuators, the yoke shall be designed to limit the maximum yoke stress to 18,000 PSI at operator stall.
- D. Frames that are attached with epoxy doweled anchor bolts shall be provided with bolts conforming to ICBO report 4285 regarding number of bolts, size, and placement.

2.7 SEALS

- A. The frames shall be equipped with seats/seals to prevent metal-to-metal contact and restrict leakage.
 - 1. The guides of all gates shall incorporate ultra high molecular weight polyethylene (UHMW) seat/seals on both the upstream and downstream sides of the gate slide. Each seat/seal will be shaped to act as both a bearing surface and a seal. The top seal, where required on upward opening gates, shall be mounted on the frame and be of low friction polymer construction.
 - 2. All upward opening gates shall contain a replaceable, flush bottom neoprene invert seal, mounted on the slide.
 - 3. All downward opening gates (weir gates) shall have low friction polymer seals mounted on the frame member at the invert of the waterway.
 - 4. All seals shall be attached to the frame with stainless steel retainers and/or stainless steel bolts.
 - 5. To minimize leakage, seal-to-slide pressure shall be adjustable by means of frame mounted wedges, which do not impinge the waterway opening.

2.8 SLIDES

- A. Stainless steel construction, reinforced with angle, channel, or plate stiffeners as required to limit the deflection at maximum specified head to $1/320$ of the span or $1/16$ " whichever is smaller.
- B. All structural component shall have a material thickness of $1/4$ ".
- C. Stem connectors shall consist of two vertical members welded to the slide. Each stem shall be bolted to the stem connector with two stainless steel attachment bolts.
- D. Edge of slide shall be $1/2$ " thick minimum.

2.9 STEMS

- A. The entire stem shall be from solid stainless steel rod.
- B. The stem shall have a minimum diameter of $1-1/2$ ".
- C. The threaded portion of the stem shall have rolled or machine cut acme threads polished to a 63 micro inch finish.

- D. The stem shall be of a size to safely withstand without buckling or permanent distortion the stresses induced by normal operating forces.
- E. The stem shall be designed to transmit in compression at least 2.5 times the output of the manual actuator with an 80 lb. effort or 1.43 times the stall thrust on electric motor actuators.
- F. A field adjusted threaded cast aluminum stop collar shall be provided on all stems with manual actuators to limit downward travel of the slide.
- G. A field-adjusted aluminum split collar upstop shall be provided on all submerged gates and weir gates to limit the upward travel of the slide.
- H. The maximum L/r ratio for the unsupported portion of the stem shall not exceed 200.

2.10 STEM GUIDES

- A. Provide integral frame mounted stem guides to limit the L/r ratio of the operating stem to 200 or less.
- B. Stem guides shall be bronze bushed and adjustable in two directions.

2.11 STEM COVERS

- A. All rising stem stainless steel sluice gates shall be provided with clear lexan or butyrate stem covers.
- B. The stem covers shall be properly vented and closed at the top with a plastic cap.
- C. The stem covers shall be provided with field mounted mylar travel indicator strips.

2.12 ANCHOR BOLTS

- A. Provide Type 316 stainless steel, epoxy doweled anchor bolts.
- B. Provide anchor bolts of no less than 1/2" diameter.
- C. Provide all anchor bolts with ample cross section to withstand the force created by operation of the gate.
- D. Install anchor bolts per manufacturer's instructions.

2.13 WALL THIMBLES

- A. Wall thimbles shall be a heavy one-piece stainless steel 316L construction of the type indicated on the gate schedule and shown on the contract drawings. Depth of the thimble shall be the same thickness as the wall.

Minimum material thickness shall not be less than 3/16". All parts of wall thimble including the gussets and stiffeners shall be stainless steel 316L. The vertical centerlines shall be clearly marked at top and bottom to permit alignment of the front face into vertical plane.

- B. Wall thimbles shall be internally braced during concrete placement to prevent warping. Square thimbles shall be provided with holes in the invert to allow satisfactory concrete placement beneath the thimble, and shall be on centers of 24" or less. A suitable mastic or gasket shall be used to form a seal between the front face of the thimble and the back of the gate frame. "E" type thimbles shall have the back flange drilled for mounting to pipe flange.

2.14 PAINTING

- A. All cast iron and carbon steel parts shall be completely shop primed and painted. Field painting, other than touch up, shall not be required.

2.15 MANUAL ACTUATORS

- A. The actuator shall be as shown in the Contract Drawings, provided that the effort to operate does not exceed a 40 lb. pull when the gate is subjected to the maximum unbalanced head.
- B. All manual actuators will be enclosed in a high strength cast aluminum or cast iron housing with a bronze operating nut.
- C. Non-Geared Handwheel Actuators
 1. Roller-type bearings shall be provided above and below the operating nut.
 2. Mechanical seals shall be provided above and below the operating nut.
 3. The handwheel shall have a minimum diameter of 15" and a maximum diameter of 24".
- D. Geared Crank Actuators
 1. Gearboxes shall have a 1" minimum diameter stainless steel pinion shaft.
 2. Roller-type bearings shall be provided above and below the operating nut.
 3. Mechanical seals shall be provided on the top and bottom of the

actuator housing and around the pinion shaft.

4. All gears are to be steel or bronze.
5. The crank shall have a minimum radius of 12" and a maximum radius of 15".

E. Interconnected Actuators

1. All stainless steel sluice gates 72" wide or larger or those with widths greater than twice their height shall be provided with two stems and two gearboxes connected by an aluminum or stainless steel interconnecting shaft for simultaneous operation via crank.
2. Gates shall also be equipped with dual actuators if deemed necessary for proper operation by the gate manufacturer.

F. Remote Actuator Drives

1. Remote actuator drives shall be provided in cases where the centerline of the handwheel (mounted on non-gearred actuator) will be located 48" or greater from the operating floor, where the centerline of the handwheel (mounted on geared actuator) will be 54" or greater from the operating floor, or where the centerline of the crank will be located 48" or greater from the operating floor.
2. Remote drives shall be of the chain and sprocket type with an aluminum cover.
3. Remote drives shall be used in conjunction with geared crank actuators. The centerline of the crank shall be positioned 30" above the operating floor.

2.16 ELECTRIC MOTOR OPERATORS

A. Manufacturers:

1. Limitorque Corp. Lynchburg, VA.
2. Rotork Controls Inc., Rochester, NY.
3. Emerson Process Management, Missouri City, TX.
4. AUMA Actuators, Cannonsburg, PA.
5. Or acceptable equivalent product.

- B. Motor operators shall be furnished by gate manufacturer.
- C. Each operator includes electric motor, reduction gearing, reversing starter, thermal overloads, drive bushing or stem nut, control transformer and limit controls. Gears totally enclosed in NEMA 4X housing with integrally cast mounting for motor, and removable cover for limit controls.
 - 1. Provide strip heater in electrical compartment.
 - 2. Equip each operator with a handwheel for manual operation and hammerblow device, which permits motor to come up to speed before picking up load and unseating gate.
 - 3. Actuators shall be so designated that they are suitable for future operation by Instrumentation and Control SCADA system via hardware I/Os.
 - 4. Stem coupling shall be accomplished by means of a high tensile, manganese bronze stem nut. The nut shall be of the 2-piece design, permitting installation and removal without disassembly of the actuator, uncoupling of the actuator from the valve, or removal of the external power and control wiring conduit.
- D. Provide opening and closing speeds of approximately 12-in. per minute for motor operators.
- E. Mount operator for stainless steel sluice gates on a pedestal with flanged bases drilled for anchor bolts.
- F. Provide internal clutch that cannot engage handwheel operating mechanism and motor-operating mechanism at same time.
 - 1. Provide handwheel with arrow and word OPEN cast on wheel to indicate turning direction to open. The handwheel shall operate in the clockwise direction to close.
 - 2. Design for handwheel to not rotate during power operation. Design for motor not to rotate during manual operation.
 - 3. Provide 18-in. maximum diameter handwheel and gear ratio to give maximum rate of movement possible with 40-lb. pull on hand wheel.
 - 4. Should power be returned to the motor while the handwheel is in use, the design of the unit shall prevent transmission of the motor

torque to the handwheel. Use of the handwheel shall not negate the hammer-blow feature.

- G. Reduction Unit of worm-gear type, worm and planetary spur type, modified planetary type, or acceptable reduction unit of spur-gear type.
 - 1. Provide spur gears with cut teeth.
 - 2. If worm gears are used, operate worm shaft in ball or roller bearings and provide machine cut, ground, and highly polished; bronze worm with large contact area.
 - 3. Accurately machine worm, spur gears, and all shafts of heat-treated steel.
 - 4. Operate output or driving shaft in bronze bearings or in ball or roller bearings.
 - 5. Make provisions to take thrust in both directions.
 - 6. Lubricate gearing at all times.
- H. Fully wire electric motor operators at factory and furnish complete with terminal strips for external power and control connections as specified under appropriate electrical sections.
- I. Provide manual or automatic control as indicated or specified.
- J. Manual Control: Provide OPEN, STOP, and CLOSE push-button at operator.
- K. Remote Position Indication
 - 1. Provide open and closed position switches with I/O to be hardwired to RTU PLC
- L. Manufacture contacts and operating parts of non-corrodible metal.
- M. Starter panel and push-button station integral part of, or separate enclosure attached to side of each pedestal, or on adjacent structure for units without pedestals.
 - 1. Provide each unit with an unfused disconnect switch enclosed with contactor or in separate enclosure.

2. Each actuator shall be supplied complete with open-stop-close push buttons. Push buttons shall be furnished integral.
3. Enclosure: NEMA 4X (316 stainless steel/fiberglass).
4. Red and green LED indicating lights furnished on operator. Green light on when gate is completely opened; red light on, when gate is completely closed. Both red and green lights on during operation at intermediate positions or when operator is stopped at any intermediate position. Provide a set of dry 10A, 120 VAC contacts for future remote indication.
5. Control circuits: 120-volt, single-phase, 60-Hertz current, supplied by control transformer.
6. Position indication shall be accomplished by means of an indicator dial in full step at all times with gate travel, whether in power or manual operation. The indicator dial shall be graduated in 25 percent increments as a minimum; closed, quarter open, half open, three-quarters open, and open.
7. Terminal strips, space heater, limit and torque switches shall be housed in compartment(s) integral to the actuator. As a minimum, the compartment(s) shall be available to meet NEMA 4X requirements.
8. Provide inverse time element overload relays.
9. Provide control transformer.

N. Limit Controls:

1. Positive in action ensuring tight seating and full openings.
2. Mechanism designed to minimize drift or over travel and to open or close gate to fixed, predetermined point at every operation.
3. Provide controls to disconnect driving mechanism from stem. Geared-limit or torque-limit type as required, but capable of ready adjustment for predetermined limits of opening and closing travel.
4. Provide torque switches for both directions of travel to break the control power circuit when the gate has reached the stops in the open or closed position or when an obstruction has been encountered in

either direction of travel. Open and close torque switches shall be adjustable by means of individually calibrated dials (marked open and close). Provide high torque pilot light in the push-button station.

5. Friction devices or setscrew arrangements shall not be used to maintain the setting.
6. The switches shall be of the adjustable type, capable of being set either fully open, fully closed, or at any intermediate point. Limit switch gearing shall be totally enclosed to prevent entrance of foreign matter or loss of lubricant.

O. Motor Provisions:

1. Specifically designed for service intended, NEMA 4X minimum weatherproof construction.
2. 460-volt, 3-phase, 60-Hertz, squirrel-cage, reversible, high-torque motors of standard make with grease packed ball bearings.
3. Motors shall be capable of operating through one complete cycle, open-close-open or close-open-close, under the maximum specified operating conditions when voltage to the motor is ± 10 percent of the specified voltage.
4. Service factor: 1.15.
5. Enclosure: TENV.
6. Insulation: Class B minimum.
7. Maximum Speed: 1800 rpm.
8. Provide motor starters with overload protection on all three phases.

2.17 ACTUATOR MOUNTING

- A. The actuator shall be mounted to the gate yoke on self-contained gates. The yoke shall consist of two channel members that are welded or bolted to the top of the gate frame. The actuator shall be pedestal mounted on non self-contained gates. Pedestals shall be concentric, offset, or wall bracket mounted. Pedestal assemblies shall be fabricated stainless or carbon steel.

2.18 SHOP TESTS

- A. Shop testing shall be performed. Before final assembly, all seating and wedging surfaces shall be cleaned thoroughly of all foreign materials and final adjustments made. With the gate fully assembled and closed, the clearance between seating faces shall be checked with a 0.0040-inch thickness gauge. If the thickness gauge can be inserted between seating faces, the wedging devices shall be readjusted or the gate slide or gate frame or both shall be remachined until insertion is no longer possible. In the event of remachining, clearances shall be checked again as stated above.
- B. After completion, all seating and wedging surfaces shall be cleaned thoroughly of all foreign materials, and final adjustments shall be made. The stainless steel sluice gate shall then be shop operated from the fully closed to the fully open position to verify that the assembly is workable.
- C. Operate floorstands and benchstands to insure proper assembly and operation.

PART 3 - EXECUTION

3.1 GENERAL

- A. It shall be the Contractor's responsibility to handle, store, and install the gate, actuator mechanism, stem, stem guides, and accessories in accordance with the manufacturer's drawings, installation manual and recommendations. Care shall be taken to avoid warping the gate frame and to maintain tolerances between seating faces. All gates, stems, and actuators shall be plumbed, shimmed, bolted and aligned accurately. All gates shall be installed in a dry environment and in strict accordance with manufacturer's published instructions.
 - 1. Chemical Adhesive anchors for attaching stainless steel sluice gate components to wall material are specified.
- B. Prior to installation, protect stored gates and appurtenances from damage due to exposure to sunlight, heat, dirt, debris, freezing and thawing, vandalism, etc.
 - 1. Store gates and appurtenances in accordance with manufacturer's written recommendations.

- C. Clean debris, dirt, and gravel, from inside of gates and channels before placing gates.
- D. Install stainless steel sluice gates in completely assembled condition with discs wedged lightly but firmly into seats with nuts pulled up tight.
- E. Erect and support gates in respective positions free from distortion and strain on appurtenances during handling and installation.
- F. Inspect material for defects in workmanship and material.
- G. Clean out debris and foreign material from gate opening and seats, test operating mechanisms to check proper functioning, and check nuts and bolts for tightness. Repair, gates and other equipment that does not operate easily or are otherwise defective.

3.2 FLOORSTAND OPERATORS AND STEM GUIDES

- A. Set floorstand operators and stem guides so stems run smoothly in true alignment. Anchor guides firmly to walls. Check distances from centerlines of gates to operating level or base of floorstand and adjust if necessary to suit actual conditions of installation.

3.3 ACCEPTANCE TESTS

- A. After installation of equipment, and after completion of the services of manufacturer's representative as stated in Section 01735, operate each gate to demonstrate its ability to operate smoothly and without jamming.
- B. Leakage Test:
 - 1. Seating Heads: Leakage not to exceed 0.025 gpm per foot of seating perimeter.
 - 2. Unseating Heads: Leakage not to exceed 0.025 gpm per foot of seating perimeter.
 - 3. Conduct tests at heads shown in the gate schedule.
- C. Correct or replace defects and defective equipment at no additional compensation.

3.4 FIELD TOUCH-UP

- A. After installation and testing of stainless steel sluice gates and approval of Engineer, provide field touch-up to all damaged and abraded surfaces. Engineer to determine surfaces to receive field touch-up.
- B. Touch-up coating shall be similar to type, color and mil thickness applied in shop application.

3.5 CONTRACT CLOSEOUT

- A. Provide in accordance with Section 01700.

END OF SECTION 11282

SECTION 11310

SEWAGE PUMP AND APPURTENANCES (BID PACKAGE #3)

PART 1 GENERAL

1.01 SUMMARY

- A. Furnish, install, test and place into satisfactory operating condition Dry Pit Submersible sewage pumps, each designed for pumping raw wastewater with minimum spherical diameter solids passage of 3”.

1.02 RELATED WORK

- A. Division 1 – General Requirements
 - 1. 01300 - Submittals
 - 2. Section 01665 – Services of Manufacturer’s Representatives
 - 3. Section 01680 – Equipment and System Checkout, Certification, and Testing
 - 4. Section 01730 – Operation and Maintenance Manuals
- B. Division 9 - Finishes
- C. Division 13 - Instrumentation
- D. Division 15 - Mechanical
- E. Division 16 - Electrical Work

1.03 DESIGN REQUIREMENTS

- A. The work shall include all accessories, and appurtenances necessary to make a complete system. Work shall conform to requirements for installation, materials, and equipment approvals of state, local, Underwriters' Laboratories, Inc., or other applicable codes, whether or not called for in detail on the drawings or in these specifications.
- B. All openings, internal passages, and internal recirculation ports shall be large enough to permit the passage of a sphere 3" in diameter, and any trash or stringy material which may pass through the average house collection system. Screens or any internal devices that create a maintenance nuisance or interfere with priming and performance of the pump shall not be permitted.
- C. Pump shall be capable of operating in a continuous non submerged condition in vertical position in a dry pit installation, permanently connected to inlet and outlet pipes. Pump shall be of submersible construction and will continue to operate satisfactorily should the dry pit be subjected to flooding.

- D. Certified dimensional drawings indicating size and locations of the priming recirculation port or ports shall be submitted to the engineer prior to shipment.
- E. New pumps shall be capable of performing under the following operating conditions:

Main Lift Pumping Station*
5-Pumps

Pumps	Capacity (gpm)	TDH (ft)	Motor Horsepower	Speed (RPM)	Run-out Point	Min Eff	Shut-off Head
Single Pump Operation	4,700	59	115	1,200	7,300 gpm at 10 feet	74%	124
Parallel Pump Operation	4,375	63	Operating condition for each pump				

* Motors rated 460 volts, 3 phase, Inverter duty rated.

- F. The pumping units shall be designed to pump raw domestic sewage and discharge into a force main.

1.04 QUALITY ASSURANCE

- A. At each pumping station, pumps shall be the product of a single manufacturer with a minimum of ten years experience with equipment of the size and type specified operating in a similar arrangement.
- B. Equipment and accessories shall be the standard cataloged products of the manufacturer except as otherwise specified or indicated.
- C. Pump manufacturer to provide the pump, pump base, suction elbow and appurtenances regardless of the manufacturer, as a complete and integrated package to insure proper coordination and compatibility of equipment.

1.05 SHOP TESTS

A. Motor Tests

- 1. Motor factory shop tests shall be in accordance with IEEE Standard 112, Appendix A, plus the factories standard routine tests for the specified motor horse power.

B. Pump Tests

- 1. Certified Performance Tests: Conduct performance tests on each pump to determine head, capacity, speed, and brake horsepower at not less than six points on the operating curve including rating point and best efficiency point. Test data

shall be sufficiently comprehensive to produce guaranteed performance curves showing head versus capacity, efficiency, and brake horsepower for the rated speed. Engineer shall be supplied with the complete test procedure in advance of the testing. Test shall be witnessed and certified by a Professional Engineer.

2. Hydrostatic Pressure Tests: Conduct hydrostatic pressure tests on each pump.
3. Demonstrate that all equipment is capable of continuous operation in satisfactory manner without mechanical or electrical defects or operational difficulties.
4. Repeat tests, if necessary, until satisfactory results are obtained.
5. Correct or replace all defects or defective equipment revealed by or noted during tests at no additional cost to the Owner.
6. Conduct all tests in accordance with the latest standards of the Hydraulic Institute.
7. If the specified tests indicate the pump or motor will not meet the specifications, the Engineer has the right to require complete tests for all pumps and motors at no additional cost to the Owner.

1.06 REFERENCES

- A. ASTM A48 - Standard Specification for Gray Iron Castings.
- B. ASTM A276 - Specification for Stainless and Heat-Resisting Steel Bars and Shapes.
- C. AFBMA
- D. Hydraulic Institute Standards.
- E. National Electrical Manufacturer's Association.

1.07 SUBMITTALS

- A. Submit during bidding to the Engineer for approval as provided in Section 01300, shop drawings showing details of construction and installation of all equipment furnished under this Section. The following shall be included:
 1. Shop drawings and materials of construction and performance of electric motors, pumps, controls, pipes, valves and fittings, equipment, conduit, wiring, wiring devices, transformer and access manhole, rails and bracket.
 2. Manufacturer's rating curves showing pump characteristics of pressure, capacity, brake horsepower, and efficiency. This information shall be prepared specifically for the pump proposed. Catalog sheet showing a family of curves will not be

acceptable.

3. Literature and dimensional drawings describing the equipment in sufficient detail, including materials of construction and parts list, to indicate full conformance with the detail specifications.
 4. Complete parts list for equipment furnished.
 5. Motor data such as HP, Volts, RPM, FLC, Efficiency, and p.f. as described herein.
 6. Complete wiring diagrams and schematics of all controllers, control panels, control devices, and operators furnished under this Section.
 7. Complete wiring diagrams and schematics of all power and control systems.
 8. Floor plans, sections and elevations showing a complete layout to scale of all equipment, piping, electrical conduits and wall sleeve installation locations and methods to provide watertight seals.
 9. Motor wiring diagrams for power and high temperature switches.
 10. Services of manufacturer's representative and warranties.
 11. Drawings and calculations indicating pipe support material, locations, and engineering data of support scheme.
- B. In the event that it is impossible to conform to certain details of the specifications due to different manufacturing techniques, describe completely all non-conforming aspects.
- C. Submit under provisions of Section 01300.
- D. Pump and Motor Characteristics and Performance Data:
1. Provide guaranteed performance curves based on actual shop tests of mechanically duplicate pumping units, showing they meet specified requirements for capacity, head, horsepower, efficiency, and NPSH. For units of same size and type, provide curves for a single unit.
 2. Catalog performance curves at required speed showing maximum and minimum impeller diameters available.
- E. Manufacturer's written warranty.
- F. Shop Test Results: Provide six (6) certified copies of pump performance test data, pump performance curves, hydrostatic test results and motor test results.

G. Field Inspection Reports: Submit under provisions of Section 01700.

1.08 OPERATION AND MAINTENANCE INSTRUCTIONS

A. Provide operation and maintenance instructions as specified in Section 01730. Note, both “Paper” and “Electronic” manuals are required.

1.09 DELIVERY, STORAGE, AND HANDLING

A. Ship equipment, material, and spare parts complete except where partial disassembly is required by transportation regulations or for protection of equipment.

B. Pack spare parts in containers bearing labels clearly designating contents and pieces of equipment for which intended.

C. Deliver spare parts at same time as pertaining equipment.

D. Inspect and inventory items upon delivery to site and provide Engineer with inventory list.

E. Store and safeguard equipment, material, and spare parts in accordance with manufacturer's instructions and deliver to Owner after completion of the work.

1.10 WARRANTY

A. Manufacturer shall fully warrant the pumps and motors to the Owner against defects and workmanship and materials for a period of five (5) years under normal use and service. If any pump part, including the motor requires replacement, the part shall be replaced at no charge to the City.

A copy of each warranty shall be provided to the Owner at start-up.

PART 2 PRODUCTS

2.01 ACCEPTABLE MANUFACTURERS

A. The overall pump station design is based on the pumps shown and specified to be Sulzer/ABS Model XFP 306M-CB2 PE860/6-M-60.

B. The following manufacturers may be considered acceptable alternative pump manufacturers. Documentation shall be submitted with Bids for review and approval by the Engineer that demonstrates compliance with project specifications, including dimensions, process mechanical, electrical, instrumentation and control.

1. KSB, Richmond, VA
2. Wilo USA, Cedarburg, WI

3. Xylem/Flygt, Scottsdale, AZ

- C. Should equipment which differs from the first named in this Section 2.01.A be offered and determined to be the equal of that specified, such equipment shall be acceptable only on the basis that any revision in the design and/or construction of the structure, piping, appurtenant equipment, electrical work, etc. required to accommodate such a substitution shall be made at no additional cost to the Owner and be as approved by the Engineer.

2.02 PUMP CONSTRUCTION

- A. The casing shall be designed for handling raw sewage and shall be of cast iron conforming to ASTM A48, Class 35 or better, with smooth surfaces devoid of blow holes or other irregularities. All exposed fasteners shall be of stainless steel, 1.4401 (AISI 316). All metal surfaces coming into contact with the pumped media (other than the stainless steel components) shall be protected by a factory applied spray coating of zinc phosphate primer followed by a high solids two-part epoxy paint finish on the exterior of the pump. The pump shall be equipped with an open lifting hoop suitable for attachment of standard chain fittings. The hoop shall be of ductile iron, EN-GJS-400-18 (ASTM A-536, Grade 60-40-18), and shall be rated to lift a minimum of four times the pump weight.

Sealing design for the pump/motor assembly shall incorporate machined surfaces fitted with Nitrile (Buna-N) rubber O-rings. Sealing will be the result of controlled compression of rubber O-rings in two planes of the sealing interface. Housing interfaces shall meet with metal-to-metal contact between machined surfaces, and sealing shall be accomplished without requiring a specific torque on the securing fasteners. Rectangular cross sectioned gaskets requiring specific torque limits to achieve compression shall not be considered equal. No secondary sealing compounds shall be required or used.

- B. Impeller: The Sulzer Contrablock Plus impeller shall be of gray cast iron, EN-GJL-250 (ASTM A-48, Class 35B). The impeller shall receive a tungsten carbide coating. The coating shall be applied using high velocity oxygen fuel (HVOF) thermal spray technique. Hardness shall be 55-60 Rc.

The impeller shall be of the semi-open, non-clogging, two-vane design. The impeller shall be capable of passing a minimum of 4.1 x 4.7 inch oblong solids. The impeller shall have a slip fit connection onto the motor shaft, driven by a shaft key, and shall be securely fastened to the shaft by a stainless steel screw. A positively engaged, ratcheting washer assembly shall prevent the screw from loosening. The head of the impeller screw shall be effectively recessed within the impeller bore to prevent disruption of the flow stream and loss of hydraulic efficiency. The impeller shall be dynamically balanced to the ISO 10816 standard to provide smooth, vibration-free operation.

- C. Self-Cleaning Wear Plate: The Sulzer Contrablock Plus wear plate shall be of gray cast iron, EN-GJL-250 (ASTM A-48, Class 35B). The wear plate shall receive a tungsten carbide coating. The coating shall be applied using high velocity oxygen fuel (HVOF) thermal spray technique. Hardness shall be 55-60 Rc.

The wear plate shall be designed with a smooth surface incorporating strategically placed intercepting slots on the side facing the impeller, to shred and force any stringy solids which attempt to become lodged between the impeller and wear plate outward from the impeller and through the pump discharge. The wear plate shall be mounted to the volute with four stainless steel securing screws and four stainless steel adjusting screws to permit close tolerance adjustment between the wear plate and impeller for maximum pump efficiency. Adjustment to allow for wear and restore peak pumping performance shall be easily accomplished using standard tools, and without requiring disassembly of the pump. The use of fixed or non-adjustable wear plates or rings, or systems that require disassembly of the pump or shimming of the impeller to facilitate adjustment, shall not be considered equal. The suction flange shall be integrated into the wear plate and its bolt holes shall be drilled and tapped to accept standard 12-inch ANSI class 125/150 flanged fittings.

- D. Volute: The pump volute shall be a single-piece, gray cast iron, EN-GJL-250 (ASTM A-48, Class 35B), non-concentric design with centerline discharge. Passages shall be smooth and large enough to pass any solids which may enter through the impeller. The discharge size shall be 12 inches. The discharge flange design shall permit attachment to standard ANSI and DIN flanges/appurtenances. The discharge flange shall be drilled to accept either 12 inch ANSI class 125/150 or metric DN300 flanged fittings. Proprietary or nonstandard flange dimensions shall not be considered acceptable. The minimum working pressure of the volute and pump assembly shall be 10 bar (145 psi).

- D. Mechanical Seal: Each pump shall be equipped with a triple seal system consisting of tandem mechanical shaft seals, plus a radial lip seal; providing three complete levels of sealing between the pump wet end and the motor. The mechanical seal system shall consist of two totally independent seal assemblies operating in a lubricant reservoir that hydro-dynamically lubricates the lapped seal faces at a constant rate. The mechanical seals shall be of nonproprietary design, and shall be manufactured by a major independent manufacturer specializing in the design and manufacture of mechanical seals. The lower, primary seal unit, located between the pump and the lubricant chamber, shall contain one stationary industrial duty solid silicon-carbide seal ring and one rotating industrial duty solid silicon-carbide seal ring. The stationary ring of the primary seal shall be installed in a seal holding plate of gray cast iron EN-GJL-250 (ASTM A-48, Class 35B). The seal holding plate shall be equipped with swirl disruption ribs to prevent abrasive material from prematurely wearing the seal plate. The upper, secondary seal unit, located between the lubricant chamber and the sensing chamber, shall contain one stationary industrial duty solid silicon-carbide seal ring, and one rotating industrial duty solid silicon-carbide seal ring. Each seal interface shall be held in contact by its own spring system. A radial lip seal shall be

positioned above the sensing chamber, preventing any liquid that accumulates in the sensing chamber from entering the lower bearing and motor. The seals shall not require routine maintenance, or adjustment, and shall not be dependent on the direction of rotation for proper sealing. Each pump shall be provided with a lubricant chamber for the shaft sealing system which shall provide superior heat transfer and maximum seal cooling. The lubricant chamber shall be designed to prevent overfilling, and to provide lubricant expansion capacity. The drain and inspection plug shall have a positive anti-leak seal, and shall be easily accessible from the outside of the pump. The seal system shall not rely upon the pumped media for lubrication and shall not be damaged when the pump is run dry. Lubricant in the chamber shall be environmentally safe nontoxic material.

The following seal types shall not be considered equal: Seal systems with less than three complete levels of sealing between the pump wet end and the motor. Seals of proprietary design, or seals manufactured by other than major independent seal manufacturing companies. Seals requiring set screws, pins, or other mechanical locking devices to hold the seal in place, conventional double mechanical seals containing either a common single or double spring acting between the upper and lower seal faces, or any system requiring a pressure differential to seat the seal and ensure sealing.

- E. Mechanical Seal Protection System: The primary mechanical seal shall be protected from interference by particles in the wastewater, including fibrous materials, by an active Seal Protection System integrated into the impeller. The back side of the impeller shall be equipped with a sinusoidal cutting ring, forming a close clearance cutting system with the lower submersible motor housing or seal plate. This sinusoidal cutting ring shall spin with the pump impeller providing a minimum of 75 shearing actions per pump revolution. Large particles or fibrous material which attempt to lodge behind the impeller or wrap around the mechanical seal, shall be effectively sheared by the active cutting system into particles small enough to prevent interference with the mechanical seal. The Seal Protection System shall operate whenever the pump operates, and shall not require adjustment or maintenance in order to function. Submersible pump designs which do not incorporate an active cutting system to protect the primary mechanical seal shall not be considered acceptable for wastewater service.

- F. Moisture Detection Probes: The integrity of the mechanical seal system shall be continuously monitored during pump operation and standby time. An electrical probe shall be provided in a sensing chamber positioned above the mechanical seals for detecting the presence of water contamination within the chamber. The sensing chamber shall be oil-filled, and shall have a drain/inspection plug with a positive anti-leak seal which is easily accessible from the outside of the pump. A solid-state relay mounted in the Variable Frequency Drive Panel or in a separate enclosure shall send a low voltage, low amperage signal to the probe, continuously monitoring the conductivity of the liquid in the sensing chamber. If sufficient water enters the sensing chamber, the probe shall sense the increase in conductivity and signal the

solid state relay in the control panel. This system shall provide an early warning of mechanical seal leakage, thereby preventing damage to the submersible motor, and allowing scheduled, rather than emergency, maintenance. Systems utilizing float switches or any other monitoring devices located in the stator housing rather than in a sensing chamber are not considered to be early warning systems, and shall not be considered equal.

Two additional moisture sensing probes shall be provided: one in the electrical connection chamber and one in the motor chamber. These probes shall send separate signals to the control panel.

- G. Pump Shaft: The pump shaft and motor shaft shall be an integral, one piece unit adequately designed to meet the maximum torque required at any normal start-up condition or operating point in the system. The shaft shall have a full shutoff head design safety factor of 1.7, and the maximum shaft deflection shall not exceed .05 mm (.002 inch) at the lower seal during normal pump operation. Each shaft shall be of stainless steel, 1.4021 (AISI 420), and shall have a polished finish with accurately machined shoulders to accommodate bearings, seals and impeller. Carbon steel, chrome plated, or multi-piece welded shafts shall not be considered adequate or equal.
- H. Pump Bearings: Each pump shaft shall rotate on high quality, permanently lubricated, greased bearings. The upper bearing shall be a cylindrical roller bearing. The upper bearing shall be electrically isolated from the bearing housing to prevent bearing damage from circulating currents when the pump is operated on a variable frequency drive. The lower bearings shall be a matched set of at least three heavy duty bearings; two angular contact ball bearings and one cylindrical roller bearing. All three lower bearings shall have identical outer race diameters to provide maximum bearing load capacity. Bearings shall be of sufficient size and properly spaced to transfer all radial and axial loads to the pump housing and minimize shaft deflection. L-10 bearing life shall be a minimum of 100,000 hours at flows ranging from 50% of best efficiency point (BEP) flow to 150% times BEP flow. The bearings shall be manufactured by a major internationally known manufacturer of high quality bearings, and shall be stamped with the manufacturer's name and size designation on the race. Generic or unbranded bearings from other than major bearing manufacturers shall not be considered acceptable.
- I. Pump Support: Each pump shall be secured to a steel support stand attached to cast concrete support piers of suitable strength to support the weight of the pump and resist any expected torsion, bending, or vibration forces.

2.03 MOTORS

- A. The Premium Efficiency motor shall meet efficiency standards in accordance with IEC 60034-30:2008, level IE3 and NEMA Premium. Motor rating tests shall be conducted in accordance with IEC 60034-2-1 requirements and shall be certified

accurate and correct by a third party certifying agency. A certificate shall be available upon request.

- B. The motor shall be housed in a watertight gray cast iron, EN-GJL-250 (ASTM A-48, Class 35B), enclosure, capable of continuous submerged operation underwater to a depth of 20 meters (65 feet) and shall have an IP68 protection rating. The motor shall be of the squirrel-cage induction design, NEMA type B. The copper stator windings shall be insulated with moisture resistant, Class H insulation material, rated for 180°C (356°F). The stator shall be press fitted into the stator housing. The use of bolts, pins, or other fastening devices requiring penetration of the stator housing is unacceptable. The rotor bars and short circuit rings shall be made of cast aluminum.
- C. The motor shall be designed for continuous duty. The maximum continuous temperature of the pumped liquid shall be 40 deg C (104 deg F), and intermittently up to 50 deg C (122 deg F). The motor shall be capable of handling up to 10 evenly spaced starts per hour without overheating. The service factor (as defined by the NEMA MG1 standard) shall be 1.3. The motor shall have a voltage tolerance of +/- 10% from nominal, and a phase-to-phase voltage imbalance tolerance of 1%. The motor shall have a NEMA Class A temperature rise, providing cool operation under all operating conditions. The motor shall be FM approved for use in NEC Class I, Division I, Groups C & D hazardous locations. The surface temperature rating shall be T3C. The motor shall meet the requirements of NEMA MG1 Part 30 and 31 for operation on PWM type Variable Frequency Drives.
- D. Closed Loop Cooling System: The factory installed closed-loop cooling system shall be of steel, 1.0036 (ASTM A-570, Grade D), adequately designed to allow the motor to run continuously under full load while in an unsubmerged (dry-pit) or minimally submerged condition without the need for de-rating or reduced duty cycle. A cooling jacket shall surround the stator housing, and an environmentally safe nontoxic propylene glycol solution shall be circulated through the jacket by an axial flow circulating impeller attached to the main motor shaft. The coolant shall be pumped through an integrated heat exchanger in the base of the motor whenever the motor is running, allowing excess heat to be transferred to the process liquid. Cooling systems that circulate the pumped medium through the cooling jacket, or those that use a toxic cooling liquid shall not be acceptable. The use of external heat exchangers, fans, or the supply of supplemental cooling liquid shall not be required.
- E. Thermal Protection: Each phase of the motor shall contain a normally closed bi-metallic temperature monitor switch imbedded in the motor windings. These thermal switches shall be connected in series and set to open at 140 deg C +/- 5 deg C (284 deg F). They shall be connected to the control panel to provide a high stator temperature shutdown signal, and are used in conjunction with external motor overload protection.

- F. Temperature Monitoring: RTD (PT100) type temperature measuring devices shall be supplied for the motor winding and bearings to provide actual temperature measurement at these locations.
- G. Power Cable: The power cables shall be sized according to NEC and CSA standards and shall be of sufficient length to reach the junction box without requiring splices. The outer jacket of the cable shall be of chlorinated polyethylene (CPE) and be oil, water, and UV resistant, capable of continuous submerged operation underwater to a depth of 65 feet.
- H. Cable Entry / Junction Chamber: The cable entry design shall not require a specific torque to insure a watertight seal. The cable entry shall consist of cylindrical elastomer grommets, flanked by stainless steel washers. A cable cap incorporating a strain relief and bend radius limiter shall mount to the cable entry boss, compressing the grommet ID to the cable while the grommet OD seals against the bore of the cable entry. The junction chamber shall be isolated and sealed from the motor by means of sealing glands. Electrical connections between the power cables and motor leads shall be made via a compression or post type terminal board, allowing for easy disconnection and maintenance.

2.05 PAINTING

- A. Prime and finish paints for pumps and motors shall be factory applied. Paint shall be applied so as to obtain the coverage per gallon and the dry film thickness recommended by the manufacturer.
- B. Ferrous surfaces obviously not to be painted shall be given a shop coat of grease or other suitable rust-resistant coating.
- C. Coatings damaged in shipment or installation shall be cleaned to white metal and touched up in the field with the same materials as original coatings.

2.06 CONTROLS

- A. Pumping System Control Panel shall be provided under Division 17 – Instrumentation.
- B. Pump manufacturer shall provide and deliver stator winding thermal sensor relays for each pump to the Electrical Contractor for incorporation into the motor controllers.

2.05 MISCELLANEOUS

- A. Manufacturer shall provide a dolly designed to maneuver the pumps above grade.
- B. Submit design for Engineer's review.

PART 3 EXECUTION

3.01 INSTALLATION

- A. Install items in accordance with manufacturer's instructions.
- B. Install pumping units in the bottom floor of the dry well structure and provide supports as required.
- C. After alignment is correct, grout as specified in Section 03300.
 - 1. Fill entire base and leave no gaps or voids.
 - 2. Do not embed leveling nuts in grout.

3.02 MANUFACTURER'S FIELD SERVICES

- A. Provide services of factory trained service engineer to assist in location of anchor bolts; setting, leveling, field erection, etc.; and coordination of piping, electrical and miscellaneous utility connections. Provide in accordance with Section 01665.
- B. Provide services of manufacturer's representative as specified in Section 01665.
- C. Provide operation and maintenance training as specified in Section 01665.

3.03 FIELD TESTING

- A. Certified Performance Tests: Conduct performance tests on each pump to determine head, capacity, speed, and brake horsepower at not less than six points on the operating curve including rating point and best efficiency point. Test data shall be sufficiently comprehensive to produce guaranteed performance curves showing head versus capacity, efficiency, and brake horsepower for the rated speed.
- B. Hydrostatic Pressure Tests: Conduct hydrostatic pressure tests on each pump.
- C. The Contractor shall conduct a running pump test for a minimum of 4 hours, in the presence of the Engineer. The test shall indicate that the pumps conform to the head and capacities specified. The contractor/supplier shall field measure the pump's operating voltage, starting amperes and running amperes including the pressure/flow readings with 0%, 25%, 50%, 75% and 100% discharge valve positions.
- D. The contractor/supplier shall provide both factory and field acceptance testing of the Variable Frequency Drives, RVNR Starters, I&C pumps control and alarm panels as specified in Division 17.

- E. A 14-day operating period of the pumps will be required before acceptance. If pump performance does not meet the Specifications, the Contractor shall take corrective measures or the pumps shall be removed and replaced with pumps that satisfy the conditions specified. The decision of the Engineer shall be final.
- F. The manufacturer shall furnish the services in the presence of the Engineer, of a qualified factory representative for a minimum of 8 hours to confirm the completed pump installation to be satisfactory. Compensation for such services shall be paid for by the Contractor.
- G. The pumps supplier, after successfully completing the pumps and I&C panels field testing, shall issue a letter of certification on the equipment's installation and operation with regards to its acceptability for its guarantee.
- H. Pump tests include all I & C testing. Test will include the testing of all associated controls.
- I. The pump motors shall also be field tested by the electrical contractor's NETA Testing Firm for acceptance prior to being placed into service.

3.04 SPARE PARTS

- A. Furnish one set of all special tools required for the proper servicing of all equipment supplied under these Specifications, packed in a suitable steel tool chest with a lock. Special tools shall include any tools not available in ordinary hardware stores.
- B. Furnish the manufacturer's standard set of spare parts including at least the following:
 - Two (2) Basic Repair Kit,
 - mechanical seals,
 - bearings, and
 - O-ring kit.
 - Two (2) Impeller Kits, Tungsten Carbide Coated
 - Two (2) wear plates, Tungsten Carbide Coated

END OF SECTION

(THIS PAGE INTENTIONALLY LEFT BLANK)

SECTION 11330

LARGE BUBBLE MIXING SYSTEM

PART 1 – GENERAL

1.01 DESCRIPTION OF WORK

- A. Furnish, install, test and place into satisfactory operating condition a large bubble air wet well mixing system.

1.02 RELATED WORK

- A. Division 1 – General Requirements
 - 1. Section 01665 – Services of Manufacturer’s Representatives
- B. Division 15 – Mechanical
- C. Division 16 – Electrical
- D. Division 17 – Instrumentation

1.03 DESIGN REQUIREMENTS

- A. The work shall include all accessories, and appurtenances necessary to make a complete system. Work shall conform to requirements for installation, materials, and equipment approvals of state, local, Underwriters' Laboratories, Inc., or other applicable codes, whether or not called for in detail on the drawings or in these specifications.
- B. Mixing system shall provide variable speed mixing through injection of compressed air through a piping system to specifically spaced bubble forming plates anchored to the bottom of the tank. A factory programmed controller shall operate the injection process.
- C. Compressed air shall be injected as a short duration pulse or burst in order to form an air mass or bubble, which, as it rises to the surface, provides thorough mixing action within the tank. Each injection valve may be connected to one or more bubble forming plates.

1.04 QUALITY ASSURANCE

- A. The mixing system shall be provided as a complete, and integrated package to insure proper coordination and compatibility of equipment and shall include the air source, air pulsing components, bubble forming plate(s), and accessory equipment including tubing, piping, filters and other ancillary equipment.

- B. Equipment and accessories shall be the standard cataloged products of the manufacturers except as otherwise specified or indicated.

1.05 SUBMITTALS

- A. Submit to the Engineer for approval as provided in Section 01300, shop drawings showing details of construction and installation of all equipment furnished under this Section. The following shall be included:
 - 1. Shop drawings and materials of construction and performance of compressor, controls, pipes, valves and fittings, equipment, conduit, wiring, wiring devices.
 - 2. Literature and drawings describing the equipment in sufficient detail, including materials of construction and parts list, to indicate full conformance with the detail specifications.
 - 3. Complete parts list for equipment furnished.
 - 4. Motor data such as HP, Volts, RPM, FLC, Efficiency, and p.f. as described herein.
 - 5. Complete wiring diagrams and schematics of all controllers, control panels, control devices, and operators furnished under this Section.
 - 6. Complete wiring diagrams and schematics of all power and control systems.
 - 7. Floor plans, sections and elevations showing a complete layout to scale of all equipment, piping, electrical conduits and wall sleeve installation locations and methods to provide watertight seals.
 - 8. Motor wiring diagrams for power and high temperature switches.
 - 9. Services of manufacturer's representative and warranties.
- B. In the event that it is impossible to conform to certain details of the specifications due to different manufacturing techniques, describe completely all non-conforming aspects.
- C. Manufacturer's written warranty.
- D. Field Inspection Reports: Submit under provisions of Section 01700.

1.06 OPERATION AND MAINTENANCE INSTRUCTIONS

- A. Provide operation and maintenance instructions as specified in Section 01730. Note, both “Paper” and “Electronic” manuals are required.

1.07 DELIVERY, STORAGE, AND HANDLING

- A. Ship equipment, material, and spare parts complete except where partial disassembly is required by transportation regulations or for protection of equipment.
- B. Pack spare parts in containers bearing labels clearly designating contents and pieces of equipment for which intended.
- C. Deliver spare parts at same time as pertaining equipment.
- D. Inspect and inventory items upon delivery to site and provide Engineer with inventory list.
- E. Store and safeguard equipment, material, and spare parts in accordance with manufacturer's instructions and deliver to Owner after completion of the work.

1.08 WARRANTY

- A. Manufacturer shall fully warrant the mixing system to the Owner against defects and workmanship and materials for a period of one (1) year under normal use and service. If any part or component requires replacement, the item shall be replaced, including the labor required to do so, at no charge to the Owner.

A copy of each warranty shall be provided to the Owner at start-up.

PART 2 – PRODUCTS

2.01 EQUIPMENT

- A. Mixing system shown and specified is based on a package provided by the Blake Group and the primary component of the system is the PHI 300 controller, manufactured by Pulsed Hydraulics Inc., 15 Oro Beach Drive, Oroville, WA.
- B. PHI 300 Mixing Valve Enclosures (MVEs)
 - 1. A NEMA 4X FRP enclosure shall be provided to house the air pulsing components. The enclosure door will have a 3-position HOA switch, a 3-position pulse rate switch and run / fail indicator lights. The enclosure requires a 20 amp, 115 Volt, single phase, 60 Hz service

2. A PHI Controller with Ethernet and RS485 ports shall be provided.
3. Pulsing valve(s) will be solenoid controlled and pilot air assisted. They shall be capable of achieving pulse durations (opening / closing cycles) at operator selectable settings between 20 milliseconds and 80 milliseconds at supply air pressures between 40 and 80 psig. Valves shall have a manifold base and a valve body made of anodized aluminum. They shall be positive sealing poppet valves designed to be self-compensating for wear and non-lubed service. The valves shall be manufactured by Ross Controls.
4. An air filter with a 25-micron element and an auto-drain is provided to remove particulates and water to protect the regulator and pulsing valves.
5. A manually adjustable pressure regulator with pressure gauge provides constant pressure for proper air flow to the pulsing valves. It shall allow air pressure adjustment between 40 and 80 psig. Compressed air pressure supplied to this regulator from the air source shall not exceed 125 psig.
6. A heater will be provided for MVEs installed outdoors in cold climates.
7. Components are pre-piped with stainless steel pipe and fittings and are tested for leaks and function. Pipe unions are provided for servicing components.

C. Compressor System

1. Compressor shall be a single stage rotary screw type.
2. Compressor shall be model SM 10T as manufactured by Kaeser, or approved equivalent.
3. Compressor shall be rated for discharge pressure of 160 psi at a discharge rate of 27 cfm.
4. Motor shall be 10 HP, induction type with an ODP enclosure.
5. Compressor shall be equipped with a Motor starter, low oil shut off switch, pneumatic tank drain, after cooler
6. Transmission shall be belt driven
7. Accessories shall include a coalescing filter package, consisting of PD,DD, QD filters, and FD Cycling dryer.

D. Air Delivery Elements

1. Pipe from the compressed air system to the PHI 300(s) shall have an internal diameter of at least one inch or larger to ensure that the velocity of the compressed does not exceed 35 fps. The pipe, pipe supports and hardware shall be 316 stainless steel.
2. One (1) stainless steel shut-off ball valve per pulsing system valve (for a total of three) to be located near to the compressed air entrance and exit port(s) on the PHI 300 enclosure(s).
3. The stainless steel piping from the PHI 300(s) to the bubble forming plate shall have an internal diameter of one inch.
4. Bubble forming plates shall consist of two stainless steel disks separated approximately ½-inch apart by internal spacers. Air is injected through a

1-inch NPT threaded nipple in the top disk to the space between the disks where it is forced laterally to form the air mixing air mass.

- E. The mixing system shall not include any components located in the tank that pivot, rotate, oscillate or otherwise move to create the mixing action.

PART 3 – EXECUTION

3.01 INSTALLATION

- A. Install items in accordance with manufacturer's instructions.
- B. Install Air Mixing System components including the compressor, mixing valve enclosure, interconnecting piping, compressed air treatment accessories and appurtenance in the new building enclosure located on the top level of the Silver Creek Pumping Station. Piping and bubble forming plates to extend into the wet well, with supports as required.

3.02 MANUFACTURER'S FIELD SERVICES

- A. Provide services of factory trained service engineer to assist in location of anchor bolts; setting, leveling, field erection, etc.; and coordination of piping, electrical and miscellaneous utility connections. Provide in accordance with Section 01665.
- B. Provide services of manufacturer's representative as specified in Section 01665.
- C. Provide operation and maintenance training as specified in Section 01665.

3.03 FIELD TESTING

- A. The Contractor shall conduct a running system test for a minimum of 4 hours, in the presence of the Engineer. The test shall indicate that the system functions as it was intended.
- B. The contractor/supplier shall provide both factory and field acceptance testing of the control and alarm panels as specified in Section 13321.
- C. A 14-day operating period of the system will be required before acceptance. If pump performance does not meet the Specifications, the Contractor shall take corrective measures.
- D. The manufacturer shall furnish the services in the presence of the Engineer, of a qualified factory representative for a minimum of 8 hours to confirm the completed system installation to be satisfactory. Compensation for such services shall be paid for by the Contractor.

- E. The system supplier, after successful completion of field testing, shall issue a letter of certification on the equipment's installation and operation with regards to its acceptability for its guarantee.

3.04 SPARE PARTS

- A. Furnish the manufacturer's standard set of spare parts including at least the following:
 - 1. Filters – air filter for the PHi controller and filter elements for DD, PD and QD filters
 - 2. Compressor belts, two sets of each
 - 3. Two (2) quarts oil for compressor

END OF SECTION

DIVISION 12

(THIS PAGE INTENTIONALLY LEFT BLANK)

SECTION 12481

ENTRANCE FLOOR MATS

PART 1 - GENERAL

1.01 GENERAL PROVISIONS

- A. Attention is directed to the CONTRACT AND GENERAL CONDITIONS and all Sections within DIVISION 01 - GENERAL REQUIREMENTS which are hereby made a part of this Section of the Specifications.

1.02 DESCRIPTION OF WORK

- A. Work Included: Provide labor, materials and equipment necessary to complete the work of this Section, including but not limited to the following:
 - 1. Surface mounted walk-off mats.

1.03 SUBMITTALS

- A. Product Data: Include construction details, material descriptions, dimensions of individual components and profiles, and finishes.
- B. Verification Samples: For each type of product indicated.

1.04 QUALITY ASSURANCE

- A. Accessibility Requirements: Provide installed floor mats that comply with Section 4.5 in the U.S. Architectural & Transportation Barriers Compliance Board's "Americans with Disabilities Act (ADA), Accessibility Guidelines for Buildings and Facilities (ADAAG)" and the Massachusetts Architectural Access Board.

1.05 EXTRA MATERIALS

- A. Furnish three additional full-size entrance mats for Owner attic stock..

PART 2 - PRODUCTS

2.01 MANUFACTURERS

- A. Manufacturers: Berber RB by Mats Inc. or equal by Balco or Durable Corp.
- B. Material: One-piece, 3/8 inch thick, 100% solution-dyed UV stabilized polypropylene fibers with rubber backing. Color as selected by Engineer from manufacturer's standard colors.

PART 3 - EXECUTION

3.01 INSTALLATION

- A. Install mats to comply with manufacturer's written instructions. Coordinate top of mat surfaces with bottom of doors that swing across mats to provide clearance between door and mat.
- B. Defer installation of floor mats until Project is near Substantial Completion.

END OF SECTION

DIVISION 13

(THIS PAGE INTENTIONALLY LEFT BLANK)

SECTION 13300

INSTRUMENTATION AND CONTROLS

PART 1 – GENERAL

1.01 DESCRIPTION

- A. The work of this section includes furnishing all labor, materials, tools and equipment required to furnish and install a complete pump station RTU control panel, laptop computer, pendant operator stations, and instrumentation and implement into the existing town wide SCADA system. The system shall include instrumentation equipment, a new remote telemetry unit panel (RTU-1) and modification to the existing SCADA system located at located at the Taunton Wastewater Treatment Facility.
- B. The work required by this section shall include all primary instrumentation equipment and devices necessary to provide process data and monitoring as shown and as specified. The particular requirements of this section are specific in that this system supplier must furnish and install a system which will provide for a future input/output SCADA interface. All input/outputs (I/O) shall be collected as noted in the I/O lists of this project. The loop descriptions provide a functional description for the process portion of the system.
- C. The system supplier shall carefully review all requirements of this section in order to fully understand the limit of responsibility and the extent of what must be done to complete this portion of the system. It shall be understood that this system supplier will provide for a complete and operational I/O system that shall be completely documented and coordinated in order to provide for a complete system interface. Data collection shall be accomplished through hard-wired inputs to the PLC. All input/outputs (I/O) shall terminate at each of the respective panels.
- D. The capacity and quality of instruments and equipment shall be provided such that they perform the function described in the LOOP DESCRIPTION, as shown on the Contract Drawings and as listed in the Instrumentation List at the end of this section. It is the intent of this section of the specifications to specify a complete instrumentation and monitoring system. Anything that is not shown on the drawings but is mentioned anywhere in the specifications or vice versa, or anything not expressly set forth in either but which is reasonably implied, shall be furnished and performed as though specified, shown and mentioned in both. If an item appears in one area of the contract documents but not in another, it shall be provided in its entirety. This system supplier shall obtain and review complete set of the specifications and drawings prior to submitting final costs for the work of this section and/or any related sections.
- E. Equipment under this section shall be fabricated, assembled, installed, and placed in proper operating condition in full compliance with details, drawings, specifications, engineering data, instructions and recommendations of the equipment manufacturer as approved by the Engineer.
- F. The Instrumentation and Controls System supplier under this Section shall insure total compatibility where interfacing between equipment is required and shall initiate and

maintain close communication and cooperation with the supplier of the equipment throughout the shop drawing and equipment start-up and testing phases of the work and insure total compatibility of all required interfacing at no extra cost to the Owner.

- G. This Instrumentation and Controls System supplier shall be responsible for all input/output information transfer and communication between equipment PLC's. A Ethernet based fiber optic network shall be configured with this Instrumentation/Controls system and the existing SCADA system. A PLC to PLC network shall be established. All HMI screen configurations shall be the responsibility of this Instrumentation System Supplier. Provide all necessary man-hours as part of the final bid price for the work of this section to perform this work. Failure to do so and any associated additional costs shall be incurred by this system supplier and not the Owner.
- H. Due to the complexity of the work of this and other related sections and in order to establish a basis of bid for the equipment designed herein, a specific PLC manufacturer has been named within this section of the specifications. This has been done to match existing PLC equipment at the Treatment Plant Facility and other pump stations. In order to properly establish the requirements of this and other related sections, all system equipment and components for this PLC (Programmable Logic Controller) system as designed shall be as manufactured by Allen Bradley. Any deviation or substitutions at this time which requires any direct additional costs or additional work and results in additional costs for the requirements of this section shall be incurred by this Contractor and not the Owner. Also, any cabling data exchange changes, equipment changes, etc. shall be the responsibility of this system supplier to coordinate and provide as necessary to allow acceptability of the approved system. This shall be completely understood and there shall be no additional costs incurred due to failure to provide these requirements as noted. It shall be noted that all applicable DIVISION 11 sections and Section 13300 must provide the same manufacturer of PLC equipment for a compatible and complete system.
- I. Provide and configure a new fiber optic network telemetry control panel that shall include, but not be limited to, PLC, instrumentation, UPS system, power distribution equipment, power supplies, Fiber Optic Patch Panel, Ethernet Switch, CAT6 interface cable. The new fiber optic network telemetry control panel shall be implemented into an existing city wide fiber optic network SCADA system.
- J. At the Wastewater Treatment Facility configure the existing SCADA system master PLC and SCADA system software to implement the new pump station RTU as specified herein and within contract documents. The master PLC and RTU-1 PLC shall be configured with hand shaking logic to monitor the status of the RTU-1 PLC and a failure of the RTU-1 PLC shall be alarmed at the existing SCADA HMI. The existing main pump station SCADA screens may be copied and utilized as the base for the new pump station screens.

1.02 SUBMITTALS

- A. Submit the following in accordance with Section 01300 - Submittals:
 - 1. Manufacturer's data, order sheet or equivalent for each individual instrument or device being supplied. The information shall include but not be limited to model number, exact chart, scale or calibration range, type of enclosure and mounting,

input/output and power data and the instrument tag number (or loop number for auxiliary equipment). Sales literature will not be accepted.

2. Manufacturer's outline and mounting dimensions for all field mounted devices, and scaled layout drawings for primary and supplemental control panels, including interfacing details for equipment to be supplied under DIVISION 11.
3. Manufacturer's panel color selection with color samples.
4. Complete master wiring diagrams including field wiring requirement, elementary or control schematics including coordination with other electrical devices operating in conjunction with the instrument control panels. Suitable outline drawings shall be furnished for approval before proceeding with manufacture and shall include number of conduits and wires, size, tubing and mounting. It shall be required that this system supplier also refer to all other interrelated specifications and drawings. Therefore it is imperative that this system supplier obtains a complete set of contract specifications and drawings as part of the work and requirements of this portion of the system. Due to the complexity of the control functions, it is imperative the above drawings be clear and carefully prepared to facilitate interconnections with other equipment. Standard preprinted sheets or drawings simply marked to indicate applicability to this contract will not be acceptable.
5. The system supplier shall clearly identify any exception to the specification or drawings. Failure to do this will be grounds for rejection of the submittal.
6. The services of the instrumentation system vendor's factory engineer shall be included as part of the bid price to meet with the Engineer at his office for a minimum of two, 8-hour days to review shop drawings for this Section prior to approval by the Engineer.

B. For approval before release for manufacturing:

1. Instrument and control panel layout to scale or dimensioned with overall size mounting and field entries dimensioned.
2. Preliminary loop diagrams and logic diagrams in the I.S.A. & NEMA standard and shall include piping and wiring requirements for each loop.
3. All equipment to be furnished under this Section must be approved prior to any of this equipment being released for manufacturing unless otherwise noted by the Engineer.

C. Prior to final acceptance:

1. Final loop diagrams containing start-up data (to I.S.A. standard).

D. Shop drawings shall be submitted in accordance with Section 01300 - Submittals and include the following special conditions:

1. All material submitted for review shall be contained in one submission. The material shall be furnished in bound volumes as required for a complete submittal. Loose material submitted will not be reviewed. Partial submittals unless agreed to by the Engineer will not be reviewed. Sales bulletins or other general publications are not acceptable as submittals.
 2. One set of reproducible drawings, size 2 feet x 3 feet. The Engineer reserves the right to accept or reject half size (11" x 17") reproducibles in lieu of 2 feet by 3 feet size. Half size copies shall be bound with each copy of the submittal.
 3. If more than two submittals (initial submittal and one re-submittal) are required for approval, the system supplier shall be liable for back charges for the Engineer's services to review additional submittals.
 4. The instrumentation manufacturer shall furnish a complete set of the final approved wiring diagrams to the Electrical Contractor and supplier of filtration equipment.
- E. Shop drawing review period for this section shall extend beyond the specified period as defined in Section 01300 - Submittals. Due to the complexity of the system the review period allowed shall be a minimum of forty-five (45) days unless otherwise agreed to by the Engineer.
- F. Operation and Maintenance Manuals shall be submitted in accordance with the requirements of Section 01730 - Submittals.

1.03 RESPONSIBILITY FOR EQUIPMENT

- A. The Instrumentation Contractor shall be responsible for furnishing, installing, and placing in satisfactory operation all instruments, appurtenant process equipment, piping, and accessories, and shall coordinate all instrumentation, telephone modems, and Ethernet communication system equipment, analytical equipment, computer hardware, software, and peripherals, etc., to guarantee a complete and operational system. All panels, instruments, signal conditioners, switches and other devices, including computer equipment and software, shall be furnished by the same supplier.
- B. System responsibility, under Section 13300 (Instrumentation and Control System) shall be by a single Instrumentation Contractor. All instruments, equipment, panels, and computer hardware and software shall be provided by a single instrument system supplier. The system supplier shall be responsible to the Instrumentation Contractor for satisfactory startup, testing, calibration, operator training and successful operation of the entire integrated system.
- C. The Instrumentation Contractor shall coordinate the work of the system supplier's service personnel during construction, testing, start-up, calibration and acceptance of the system.
- D. The Instrumentation Contractor shall have in his employ the capable personnel for detail engineering, coordination, drafting, procurement and expediting, scheduling, construction inspection, installation, start-up service for calibration and commissioning, as specified and warranty compliance for the period specified.

- E. The Instrumentation Contractor shall provide for complete operation of all signals from "point to point" and shall assure complete compatibility of all equipment specified herein in DIVISION 11 - EQUIPMENT. It shall be the instrumentation and control system supplier's sole responsibility to resolve any and all interconnecting and interfacing problems in order to provide a completely integrated and operational system. The instrumentation and control system supplier shall provide all necessary coordination with DIVISION 16 - ELECTRICAL in providing the proper I/O (Input/Output) required at all locations for a complete system.
- F. The supervisory service of a factory-trained service engineer, specifically trained on the type of equipment specified herein, shall be provided during construction to assist the General and Electrical Contractors in the location of sleeves, method of installing conduit and special cable, mounting, piping and wiring of each type of device and the method of protecting all of the equipment prior to placing it into service.
- G. It is the responsibility of the Instrumentation Contractor to assure that all instrumentation furnished under DIVISION 11 - EQUIPMENT is coordinated with equipment, hardware and software furnished under this Section. All primary sensing elements, transmitters, analyzers, and associated instruments being furnished under DIVISION 11 - EQUIPMENT shall be of the same manufacturer. It shall be this Contractor's responsibility, at the time of the bidding, to coordinate with the suppliers of each of these sections in order to assure that this requirement is upheld. Both suppliers shall agree, at the time of submitting their bids, that their bid prices reflect this requirement. Failure to meet this requirement, which results in any additional costs for this equipment, shall be the responsibility of this Contractor at no additional cost to the Owner. No exceptions shall be allowed.

1.04 DESIGN CRITERIA

- A. All instrumentation shall meet or exceed I.S.A. Standards and Recommended Practices, ANSI, National Electrical Code, OSHA, and any other applicable code or local regulation. All panel instruments shall be of the same manufacturer and model type to provide uniform appearance.

1.05 SYSTEM DESCRIPTION

- A. Each loop description contains the basic functional description of the process. All components necessary to complete these functions shall be provided to satisfy the requirements of this section.
- B. Contacts referred to in the Loop Descriptions shall be "dry" type either normally open or normally closed as required for the function described. All contacts shall be rated 10 ampere at 120 volts.
- C. The scales of instruments and devices described in the instrument loop descriptions shall be as specified and noted in the Instrument List. All indicator scales shall read out in appropriate "Engineering" units. In cases where this information is not provided this shall be clarified and coordinated with the Engineer.
- D. Loop descriptions (and associated Loop Drawings) are intended to provide a conceptual

overview of required system operation. Each of the loops may or may not show all specific components necessary for each system operation. The instrumentation system supplier shall provide all necessary equipment, devices, components, signal conditioners, software, and other requirements for complete and satisfactory system operation. The system supplier shall provide all necessary current-to-current converters (I/I's) required by loop description to provide proper signal loading.

- E. All signal interfacing compatibility is the responsibility of the supplier of equipment under Section 13300 (Instrumentation and Control System) and requires close coordination and cooperation with the supplier of equipment under DIVISION 11 - EQUIPMENT. In the loop description, any equipment or device which is not noted but shown elsewhere on loop drawings, specifications, etc. shall be provided by this system supplier in its entirety. Anything that is not shown on the drawings but is mentioned anywhere in the specifications or vice versa, or anything not expressly set forth in either but which is reasonably implied, shall be furnished and performed as though specified, shown and mentioned in both. If an item appears in one area of the contract documents but not in another, it shall be provided in its entirety. This system supplier shall obtain and review complete copies of both the specifications and drawings prior to submitting final costs for the work of this section and/or any related sections. Any discrepancies shall be brought to the attention of the Engineer prior to submission of the final bid price in order to clarify any and all issues.

1.06 INSTRUMENTATION AND CONTROL SYSTEM SUPPLIER

- A. The Instrumentation and Control System Supplier shall be the following with no substitutions allowed as the City has standardized on this supplier for their SCADA can controls systems.
 - 1. R. E. Erickson Co., Inc.
Walpole, Massachusetts
508-668-9330

1.07 GENERAL MONITORING AND CONTROL REQUIREMENTS

- A. PLC programs shall be configured to allow operators, with the appropriate security clearance, to modify set points, pump sequencing, timer settings, etc. readily using the OITs or SCADA display screen. PLC programs shall be configured to allow logic modification by an operator, with the appropriate security clearance, using the programming devices and software provided under this Contract.
- B. Control logic, alarm logic and totalization calculations shall be executed via the PLC programs and not the OIT or SCADA graphic display software.
- C. Discrete alarms shall be configured with adjustable time delays (initially set at 3 seconds). Each discrete alarm time delay shall be independently adjustable.
- D. Analog inputs shall be provided with high and low alarm set points initially set at 80% and 20% of span, respectively, unless otherwise noted. High alarm set point dead bands shall default to a range from the set point to 3% of span below the set point unless plant personnel enter a different value. Low alarm set point dead bands shall default to a range

from the set point to 3% of span above the set point unless plant personnel enter a different value. Each alarm dead band shall be independently adjustable.

- E. Alarms shall have the capability of being disabled from a security accessed only alarm enable screen located on the main SCADA computer only.
- F. Controlled equipment shall require only one positive selection of the control action by an operator before the command is executed.
- G. Sequential operations and sequential logic shall incorporate timers to alarm an incomplete sequence or malfunction. An alarm shall be generated if a required action or sequence of actions is not completed within an adjustable time period.
- H. Alarm set points, dead bands and time delays shall be accessible from the OITs or SCADA display screen by an operator with the appropriate security clearance.
- I. An operator must acknowledge an alarm displayed at the OITs or SCADA display screen before it clears. Alarm and acknowledgement logic shall follow the ISA S18.1 standard for manual reset (sequence M, Manual Reset).
- J. All motors, valves and mechanical equipment shall have an “available” status indicator when the device is available for remote automatic or manual control. Provide an alarm to notify plant personnel when a component becomes “unavailable.”
- K. Equipment shall be restarted either automatically or manually, as determined by the Engineer and Owner. Equipment shall fail in last position, or an Owner and Engineer determined safe position.
- L. Equipment shall be manually controlled either locally or remotely through the OIT and SCADA display screen unless otherwise indicated.
- M. Communication status between all PLCs shall be monitored and displayed. Communication failures shall be alarmed.

1.08 LOOP DESCRIPTIONS

A. LOOP 100: WET WELL LEVEL MONITORING

1. Wet Well #1 and Wet Well #3 levels shall be measured by two submersible level transducers (LT-100A, LT-100B) one in each of the wet wells and hardwired through an intrinsically safe isolator into the RTU-1 PLC. Level shall be indicated and trended at the SCADA HMI and the OIT. The SCADA system shall record the levels (LIR-100A, LIR-100B).
2. The level transmitters (LT-100A, LT-100B) shall provide a 4-20 mA DC output signals proportional to the wet well levels to the PLC. This signal shall be the primary means for automatic pump control, refer to Loop 101. The Levels shall trigger high and low level alarms that are to be displayed at the SCADA HMI and the OIT.

3. High and Low Level float switches (LSH-100A, LSH-100B, LSH-100C, LSH-100D, LSH-100E, LSH-100A, LSL-100B, LSL-100C) shall be installed in the wet wells. These switches shall provide backup alarms to the level transducers as well as providing a hardwired control of the pumps in case of a PLC, UPS, or transducer failure. The float switches shall be wired through intrinsically safe relays. A contact from each intrinsically safe relay shall be wired to the RTU-1 PLC, to RTU Control Panel LED pilot lights for high and low level alarms and to back-up level control as described in Loop 101. Alarms shall be displayed at the SCADA HMI and the OIT

B. LOOP 101: SEWAGE PUMP #1

1. The Sewage Pump #1 is controlled via a floor mounted variable frequency drive. Operation of Sewage Pump #1 shall be monitored and controlled automatically through the RTU-1 PLC via hardwired I/O. The Pump has a Hand/Off/Auto selector switch at the VFD. When in the "Auto" position the remote automatic control and remote manual control through the OIT and SCADA HMI is enabled.
2. The following control, status and alarm signals shall be wired to the PLC I/O and displayed at the OIT and SCADA HMI:
 - a. Sewage Pump #1 HOA switch in "Auto" position (YI-101A)
 - b. Sewage Pump #1 run status (YI-101B)
 - c. Sewage Pump #1 Start/Stop (YS-101)
 - d. Sewage Pump #1 VFD alarm (YA-101A)
 - e. Sewage Pump #1 VFD speed feedback (SI-101)
 - f. Sewage Pump #1 VFD speed command (SC-101)
 - g. Sewage Pump #1 by-pass status (YI-101C)
 - h. Sewage Pump #1 soft starter alarm (YA-101B)
 - i. Sewage Pump #1 high motor temperature alarm (TSH-101)
 - j. Sewage Pump #1 seal chamber leak detection alarm (MSH-101A)
 - k. Sewage Pump #1 motor chamber leak detection alarm (MSH-101B)
 - l. Sewage Pump #1 electrical chamber leak detection alarm (MSH-101C)
 - m. Sewage Pump #1 emergency stop (HS-101)
 - n. Sewage Pump #1 check valve failure (ZSA-101)
3. Non-resettable elapsed time meter shall be displayed at the OIT and SCADA HMI (KQI-101B).

4. A pump state disparity alarm shall be displayed at the OIT and SCADA HMI if the called state of the motor and the state of the run status contact do not agree after a preset adjustable time (YA-101C). The disagreement alarm is enabled if the H/O/A switch is in the “Auto” position. The disagreement alarm must be manually reset through the OIT or SCADA HMI before Remote Automatic Control and Remote Manual Control is enabled.
5. Remote Automatic: The pumps shall be controlled by a PID loop to maintain a constant, operator adjustable level set point in operator selected Wet Well #1 or Wet Well #2. It shall be possible to select any combination of Pump #1, Pump #2, Pump #3, Pump #4, and Pump #5 as Lead, First Lag, Second Lag, Third Lag and Standby through the OIT or SCADA HMI. The Lead Pump shall come on at 100% speed for 5 seconds and then drop to an operator adjustable start speed (initially set at 85%) when the level in the Wet Well #1 or Wet Well #2 exceeds an operator configurable level set point. If the PID loop maintains a speed command of 90% or greater for an operator adjustable time delay (initially set for 2 minutes), the First Lag Pump shall start at 100% speed for 5 seconds and then both pumps shall be sent an operator adjustable speed command (initially set at 85%) and the PID control shall be restarted. If the speed command drops below an operator adjustable minimum speed command (initially set at 75%) the First Lag Pump shall be shut off and the Lead Pump sent a 90% speed command before the PID control is restarted.

If the PID loop maintains 90% or greater speed command with two pump running for an operator adjustable time delay (initially set for 2 minutes), the Second Lag Pump shall start at 100% speed for 5 seconds and all three pumps shall be sent an operator adjustable speed command (initially set at 85%) and the PID control is restarted. If the speed command drops below an operator adjustable minimum speed command (initially set at 75%) the Second Lag Pump shall be shut off and the Lead Pump and First Lag Pump sent a 90% speed command and the PID control is restarted.

If the PID loop maintains 90% or greater speed command for an operator adjustable time delay (initially set for 2 minutes), the Third Lag Pump shall start at 100% speed for 5 seconds and all four pumps shall be sent an operator adjustable speed command (initially set at 85%) and the PID control is restarted. If the speed command drops below an operator adjustable minimum speed command (initially set at 75%) the Third Lag Pump shall be shut off and the Lead Pump, First Lag Pump, and Second Lag Pump sent a 90% speed command and the PID control is restarted.

All pumps maximum speed commands shall be limited to maintain a pump station combined effluent flow less than an operator selected maximum station effluent flow set point (initially set for 22MGD). As the station’s effluent flow approaches the maximum flow set point the level PID control output speed command upper limit of 100% speed shall be reduced to maintain the effluent flow just below the maximum set point. If the wet well level continues to rise and exceeds an operator selected high-high level the overflow gate shall open (YO-115) allowing wastewater to flow into the Wet Weather Pump Station wet

well (Refer to Loop 115) and a high-high level alarm will be activated and displayed at the OIT and SCADA HMI.

The Lead and the Three lag pumps shall automatically alternate between Lead and the Lag designations at an operator adjustable time period ranging from 15 minutes to 45 minutes of Lead pump runtime.

6. Remote Manual Control: The pump is manually start/stopped (YS-101) and VFD speed command (SC-101) is manually entered via the SCADA HMI and OITs.
7. Either in Remote Automatic or Remote Manual Control Pump #1 and Pump #2 shall be automatically stopped if the Wet Well #1 level drops below and operator configurable set points for an operator configurable time period. Pump #3 shall also be automatically stopped if the Sluice Gate SG-111 is not in the closed position.
8. Either in Remote Automatic or Remote Manual Control Pump #4 and Pump #5 shall be automatically stopped if the Wet Well #3 level drops below and operator configurable set points for an operator configurable time period. Pump #3 shall also be automatically stopped if the Sluice Gate SG-112 is not in the closed position.
9. If a pump experience a seal chamber leak alarm that pump shall be designated as the standby pump.
10. If a pump is not available for service because of the following, the standby pump shall take over for the unavailable pump. The pump shall be locked out upon a disparity alarm or system protection alarm and must be manually reset before it can resume operation.
 - a. Disparity alarm (see below),
 - b. Motor over temperature alarm.
 - c. Motor chamber leak alarm.
 - d. Motor electrical chamber leak alarm.
 - e. HOA switch is not in "Auto".
11. Back Up Level Control
 - a. Back-up hardwired pump control logic utilizing the High and Low Level switches (LSH-100A, LSL-100A) in Wet Well #1, (LSH-100C, LSL-100B) in Wet Well #2, (LSH-100D, LSL-100C) in Wet Well #3.
 - b. If the wet well level reaches the high float switch level it is assumed that there has been a failure of the primary level instrumentation and/or the PLC and therefore the float switches and hardwired pump control logic shall be used for automatic pump control.

- c. When the Wet Well #1 level exceeds the high level float switch level (LSH-100A), Pump #1 shall be started and shall run at 95% speed via the VFD full speed override signal. If the wet well continues to rise and exceeds the high level float switch level (LSH-100B), Pump #2 shall be started and shall run at 95% speed via the VFD full speed override signal. When the Wet Well level drops below the float switch low level (LSL-100A) both pumps shall be stopped.
- d. When the Wet Well #2 level exceeds the high level float switch level (LSH-100C), Pump #3 shall be started and shall run at 95% speed via the VFD full speed override signal. When the Wet Well level drops below the float switch low level (LSL-100B) the pump shall be stopped.
- e. When the Wet Well #3 level exceeds the high level float switch level (LSH-100D), Pump #3 shall be started and shall run at 95% speed via the VFD full speed override signal. If the wet well continues to rise and exceeds the high level float switch level (LSH-100E), Pump #5 shall be started and shall run at 95% speed via the VFD full speed override signal. When the Wet Well level drops below the float switch low level (LSL-100C) both pumps shall be stopped.
- f. Automatic control shall continue in this manner until manually reset by an operator at the OIT and then automatic pump control shall revert to the primary level instrument.
- g. A Primary Level Control Enable Switch shall be provided to enable and disable the PLC level control in order to test the hardwired float switch back up level control.

12. Ethernet/IP Data Exchange

- a. The VFD drive shall have a RJ45 Ethernet port that allow for complete data exchange of all VFD parameters over an Ethernet/IP network. The PLC shall poll the VFD parameter and indicate them on the SCADA HMI.

C. LOOP 102: SEWAGE PUMP #2

- 1. Functionally identical to Loop 101.

D. LOOP 103: SEWAGE PUMP #3

- 1. Functionally identical to Loop 101.

E. LOOP 104: SEWAGE PUMP #4

- 1. Functionally identical to Loop 101.

F. LOOP 105: SEWAGE PUMP #5

1. Functionally identical to Loop 101.
- G. LOOP 106: FORCE MAIN A FLOW
1. The Force Main A effluent flow shall be measured by a magnetic type flow transducer (FE-106) that will be mounted into the pump station effluent pipe. The flow transducer shall be connected to a flow transmitter (FIT-106) that is hardwired into the RTU-1 PLC and will provide a 4-20ma signal proportional to the flow rate. The flow rate shall be indicated and trended at the OIT and SCADA HMI. The SCADA system shall record the signal (FIR-106).
 2. Four flow totals shall be computed and displayed at the OIT and SCADA HMI.
 - a. Non-resettable total (FQI-106A)
 - b. Previous days total (FQI-106B)
 - c. Current days total (FQI-106C), automatically reset daily
 - d. Resettable total (FQI-106D)
 3. Low flow alarms shall not be active if all of the five pump check valves are in the closed position.
- H. LOOP 107: FORCE MAIN B FLOW
1. Functionally identical to Loop 106.
- I. LOOP 111: WET WELL #1 INFLUENT SLUICE GATE SG-111
1. The influent flow into Wet Well #1 can be blocked via a motorized sluice gate (SG-111) that shall be monitored through RTU-1 PLC via hardwired I/O.
 2. The following status signals shall be wired to the PLC I/O and displayed at the SCADA HMI and OIT:
 - a. Gate Opened Status (ZSO-111)
 - b. Gate Closed Status (ZSC-111)
- J. LOOP 112: WET WELL #3 INFLUENT SLUICE GATE SG-112
1. Functionally identical to Loop 111 except for the following.
 2. An alarm shall be generated and indicated at the SCADA HMI and OIT if both SG-111 and SG-112 are in the closed position.
- K. LOOP 113: WET WELL #2 INFLUENT FROM WET WELL #1 SLUICE GATE SG-113
1. Functionally identical to Loop 111.
- L. LOOP 114: WET WELL #2 INFLUENT FROM WET WELL #3 SLUICE GATE SG-114

1. Functionally identical to Loop 111.

M. LOOP 115: STATION INFLUENT DIVERSION TO WET WEATHER PUMP STATION SLUICE GATE

1. The influent flow into the pump station can be diverted to the wet weather pump station via a motorized sluice gate (SG-115) that shall be monitored and controlled through RTU-1 PLC via hardwired I/O.
2. The following control and status signals shall be wired to the PLC I/O and displayed at the SCADA HMI and OIT:
 - a. Gate Opened Status (ZSO-115)
 - b. Gate Closed Status (ZSC-115)
 - c. Gate Open Command (YO-115)
 - d. Gate Close Command (YC-115)
3. Automatic Control: If the wet well level is greater than an operator adjustable overflow activate high level for an operator adjustable time delay, the overflow gate shall open (YO-115) allowing wastewater to flow into the Wet Weather Pump Station wet well. If the wet well level drops below an operator adjustable overflow deactivate low level for an operator adjustable time delay, the overflow gate shall close (YC-115).
4. Manual Control: The valve is manually open/closed (YO-115, YC-115) via the SCADA HMI and OIT.
5. A motor state disagreement open and closed alarms (YAO-115, YAC-115) shall be displayed at the SCADA HMI and OITs if the called state of the valve does not agree with the position after a preset adjustable.

N. LOOP 120: GENERATOR MONITORING

1. The following status and alarms shall be hardwired into the RTU-1 PLC and displayed/annunciated at the OIT and the SCADA HMI:
 - a. Generator on (YI-120A)
 - b. Generator not in auto (YI-120B)
 - c. Generator failure (YA-120A)
 - c. Generator alarm (YA-120B)
 - d. Generator Low Fuel Tank Level (YA-120C)

- e. Generator Fuel Tank Leak (YA-120D)
- O. LOOP 121: TRANSFER SWITCH MONITORING
 - 1. The following status and alarms shall be hardwired into the RTU-1 PLC and displayed/annunciated at the OIT and the SCADA HMI:
 - a. Transfer switch in normal position (YI-121A)
 - b. Transfer switch in emergency position (YI-120B)
- P. LOOP 130: RTU-1 PANEL POWER FAILURE
 - 1. Loss of 120 VAC power to the new RTU-1 control panel (JAL-130) shall be annunciated at the SCADA HMI.
- Q. LOOP 131: RTU-1 24VDC POWER SUPPLY FAILURE:
 - 1. A 24 VDC power supply failure in the new RTU-1 control panel (JAL-131) shall be annunciated at the OIT and SCADA HMI.
- R. LOOP 132: RTU-1 UPS FAILURE:
 - 1. The UPS failure in the new RTU-1 control panel (JAL-132) shall be annunciated at the OIT and SCADA HMI.
- S. LOOP 140: SECURITY SYSTEM ALARMS
 - 1. The following security alarms shall be hardwired into the RTU-1 PLC and displayed/annunciated at the OIT and the SCADA HMI:
 - a. Wet well intrusion alarm (YA-140A)
 - b. Pump Station intrusion alarm (YA-140B)
 - c. Generator enclosure intrusion alarm (YA-140C)
 - d. Pump Station Lower Level fire alarm (YA-141A)
 - e. Pump Station Ground Floor fire alarm (YA-141B)
 - f. Pump Station Attic fire alarm (YA-141C)
- T. LOOP 145: DRY WELL FLOOD ALARM
 - 1. A float switch (LSH-145) will be located in the dry and shall be hardwired into the RTU-1 PLC and when activated displayed/annunciated at the OIT and the SCADA HMI:
- U. LOOP 150: VENTILATION SYSTEM MONITORING

1. The following ventilation system status and alarms shall be hardwired into the RTU-1 PLC and displayed/annunciated at the OIT and the SCADA HMI:
 - a. ERV-1, Ventilation Unit running (YI-150)
 - b. ERV-1, Ventilation Unit Alarm (YA-150)

V. LOOP 160: COMPRESSOR MONITORING

1. The following status and alarms shall be hardwired into the RTU-1 PLC and displayed/annunciated at the OIT and the SCADA HMI:
 - a. Compressor running (YI-160)
 - b. Compressor Alarm (YA-160)

PART 2 – PRODUCTS

2.01 GENERAL

- A. The INSTRUMENT LOOP DESCRIPTION, DIAGRAMS, AND INSTRUMENT LIST included at the end of this section indicate the intent of the process and interconnection between INSTRUMENTS. EQUIPMENT specified herein does not purport to cover all equipment that may be required to complete the process intent. Numbering identification is based on ISA standard. The instrument index sheets included within this section of the specifications have been furnished to summarize the system equipment and to list the operating parameters for this equipment. This list may not completely include all the required equipment necessary for a completely operational system. The instrument supplier shall provide all necessary equipment required in order to perform the function for the system.
- B. All equipment shall be of the latest proven design. First generation equipment with less than three years general use shall have documentation on construction operation, field test and user list.
- C. All equipment shall be suitable for operation in the environment of the Project.
- D. Transmission to and from analog devices shall be 4-20 mAdc.
- E. All signal converters, isolation transformers, uninterruptible power supplies (UPS), power regulators, or power converters shall be the responsibility of the instrument supplier. The loop descriptions herein do not specify all hardware required for proper operation. It is the responsibility of the Instrumentation supplier to furnish and install all necessary equipment for complete systems.
- F. All equipment necessary to complete the functional requirements of this Section shall be supplied by the Instrumentation and Control System Supplier and be of the same manufacturer unless otherwise specified (e.g. signal converters, integrators, computing devices alarm trips etc.) shall be of the same manufacturer as the recorders, controllers and indicators.

- G. All necessary fuses or switches required by the Instrumentation and Control System Supplier for his equipment shall be provided with the equipment. All instruments requiring an external power supply shall have an internal ON-OFF switch.
- H. Indicator, recorders, controllers, integrators, relays, and other receiving devices, when operating in a loop shall be of a design such that a failure of an individual device shall not effect the operation and integrity of the remaining loop functions. All indicators, recorders either remote or panel mounted shall have an individual internal on/off switch.
- I. Electronic transmitting equipment shall provide loop power. True 2-wire transmitter may have its loop power supplied in the receiving instrument, if available, or by a plug in power supply mounted in the receiving instrument panel.
- J. All conductors running from the field to the control panel shall be of a single, continuous length, without splices except at approved junction boxes. The junction boxes shall have terminal blocks with 20 percent spares in addition to terminals for all wires including spare wires. Special care shall be exercised to carry grounding lines through such junction boxes with the least possible resistance.
- K. Multi-conductor cable may be used between junction boxes and control panels.
- L. All shielded cable shall be grounded at the control panel end only. Shields shall be carried through junction boxes with the least possible resistance and kept isolated from ground at these points. The field end of the shield shall be insulated to prevent grounding.
- M. All field electronics and outdoor control panel equipment shall be suitable for operation in ambient temperatures of -40 degrees F to 140 degrees F. All indoor control panel located electronics shall be suitable for operation in ambient temperatures of 40 degrees F to 120 degrees F.
- N. All external connection points shall be made at terminal blocks with No. 6-32 or larger screws.
- O. Nameplates shall be provided on all field mounted transmitters, level relays, control panels, indicators, etc. Nameplates shall be identical to those specified for Control Panels.

2.02 CONTROL PANELS

- A. Control panels as noted in the table at the end of this Section shall be furnished under SECTION 13300, INSTRUMENTATION AND CONTROL SYSTEM.
- B. The instrumentation system supplier shall provide all instrument devices necessary for proper input/output (I/O) operation. This shall include all signal conditioning, isolation and operation equipment.
- C. The above panels shall be completely assembled and wired at the factory. See contract drawings and specifications for exact location of each of the control panels.
- D. All equipment shall be designed to operate on a 60-Hertz alternating current power

source of 105 to 135 volts except as noted. All regulators and power supplies required for compliance with the above shall be provided between supply and interconnected instrument loop. Where equipment requires voltage regulation, constant voltage transformers shall be supplied. Materials and equipment used shall be U.L. approved wherever such approved equipment and materials are available.

- E. All controls for electrically operated or motor-driven equipment shall be complete, including all necessary auxiliary relays so as to require only wiring and connections to the equipment control circuit. All contacts for control of motor-operated or electrically operated equipment shall be rated not less than 120 VA unless otherwise specified herein.
- F. NAMEPLATES AND NAMETAGS
 1. Nameplates shall be provided for all flush mounted equipment. The nameplates shall be approximately 1 inch x 3 inch constructed of black and white laminated, phenolic material having engraved letters approximately 1/4 inch high extending through the black face into the white layer. Nameplates may be omitted if a nameplate of approximately the same dimension is more conveniently and suitable located on the instrument door or face. Nameplates shall be attached to panels by self-tapping stainless steel screws or rivets. Nameplates shall be provided for each control panel identifying the panel and shall be located at the top center of the panel. Size of nameplate shall be as required for proper visual identification.
 2. Nametags shall be provided for all equipment located within the control panel. Each and every device shall be tagged with embossing tape nametags with identification reference which shall correspond to all drawings and wiring diagrams for the system. The nametags shall be neatly installed and shall be clearly visible for service and maintenance of the equipment.
- G. All panel equipment shall be pre-piped and/or pre-wired on or within the cabinet. All wiring shall comply with local and National Electrical Code in open bundles wired to numbered terminals. Each cabinet shall have at least an additional 25 percent spare terminals. A plug-in header with convenience outlets and flexible plug-in leads shall be supplied for each instrument power supply. Two spare convenience outlets shall be provided, and an overhead internal gasketed fluorescent light shall be provided as specified. Cabinet layouts shall be submitted to the Engineer for approval. Materials and equipment used shall be U.L. approved wherever such approved equipment and materials are available.
- H. All equipment shall be designed and constructed so that in the event of a power interruption, the equipment specified hereunder shall resume normal operation without manual resetting of alarms or power source when power is restored.
- I. All interconnecting wire and wiring to terminals for external connections shall be not less than No. 16 AWG copper insulated for not less than 600 volts with a moisture and heat resistant material and flame retardant nonmetallic covering. Terminal blocks for No. 12 AWG external connections shall be furnished complete with marking strip, covers, and pressure connectors similar to G.F. Company Type BB-6 terminal boards. All wiring shall be grouped or cabled and firmly supported to the panel. All wiring shall be completely tagged and numbered throughout the panel. The number designation shall be

the same throughout the panel and each wire shall be tagged with number strips at intervals of no less than 12 inches. Not less than 8-inch clearance shall be provided between the terminal strips and the base for conduit and wiring space. All instruments and devices shall be separately fused as required to protect the equipment. Shielded conductor pairs to control modules, and analog equipment shall be brought directly to terminals provided.

- J. Terminal strips shall be provided for the purpose of connecting all control, power, and signal wiring. Provide separate terminal strips for each in order to isolate the different wiring types (power, control, and signal). All terminal strips shall be completely labeled and numbered throughout for each and every unit. Direct inter-wiring between equipment will not be allowed.
- K. Control Panels shall receive an electrical service as specified herein and controls shall receive their power from this power source. Refer to these specifications further for details. The control panel shall be provided with the required fuse protection. Provide a lug for grounding connection up to a No. 1/0 AWG conductor. Fuses shall not be in excess of 15 amperes. Panels shall be provided with a separate main circuit breaker and electrical panelboard with individual circuit breakers for feeding equipment located within the panel. Panelboard shall be arranged as required in this section.
- L. Only one side of a terminal block row shall be used for internal wiring. The field wiring side of the terminal shall not be within 6 inches of the side panel or adjacent terminal. Wiring troughs shall not be filled to more than 60 percent visible fill. Wiring trough covers shall be match marked to identify placement. If component identification is shown on covers for visibility, the I.D. shall also appear on the mounting sub-panel.
- M. UNINTERRUPTIBLE POWER SUPPLY (UPS)
 - 1. The Instrumentation and Control System Supplier shall provide UPSs, including internal/external batteries, for maintaining power to the control system devices and instrumentation as specified herein.
 - a. A UPS shall be provided within each control panel.
 - 2. Each UPS shall protect the system from noise, dips, spikes and planned reductions in voltage by utility companies. The UPS shall meet ANSI C62.41/IEEE 578 A&B standards for transients/lightning protection.
 - 3. Each UPS shall be true type that continuously operate from the inverter (zero transfer time) and shall output a true high quality low distortion sinusoidal waveform synchronized to the AC utility.
 - 4. The batteries shall be sealed, maintenance free lead-acid type. The batteries shall provide 30 minutes of backup power at full load when fully charged.
 - 5. Each UPS shall have a fail-safe transfer to bypass for UPS internal electronic failures.
 - 6. A UPS installed in a control panel shall be wired into the control panel power distribution circuit so that the UPS can be easily and quickly bypassed while

maintaining AC utility power to panel devices and instruments. A UPS installed in a control panel shall be DIN-rail or shelf mounted so that the UPS is above the bottom of the control panel.

7. Each UPS shall have dry contact failure alarm that shall be wired into the PLC as an alarm input.
- N. All miscellaneous components shall be heavy-duty industrial type, or equal. Mounting hardware shall be stainless steel. All cutouts shall be made true and square with no ragged cuts. The finished cutout shall be deburred, with no sharp edges. All welds shall be ground smooth and be deburred with no sharp edges. Welding on the panel face should be minimized. Adequate stiffness and supports shall be provided to insure a rigid stable structure.
- O. The finished enclosure shall be properly degreased; prime painted (2 coats) and finish painted (2 coats) in accordance with the paint manufacturer's instructions, prior to the installation of equipment. The final finish shall be smooth, free of runs, and uniform in tone and thickness. Two, 1-pint containers of each color used shall be supplied with the panel for field touch up. Unless otherwise noted on the drawing or data sheets the colors to be used shall be selected by the Owner from color chips supplied by the panel manufacturer.
- P. Brushed anodized aluminum; stainless steel and F.R.P. panels with color gel coat will not require a paint finish.
- Q. The individual control panels shall be further identified within this section.
- R. CONTROL PANEL
 1. Control panel shall be per the control panel list at the end of this Section. The unit shall be properly sized to handle all equipment and instrumentation devices with sufficient spacing between all devices. Doors shall be hinged panel type for front access. The manufacturer of the panel shall provide all ventilation required to maintain proper operating temperature within the panel for all system components.
 2. The panel shall be properly sized to handle all input/output and instrumentation devices with sufficient spacing between all devices. This shall include all terminal points and separation between signal and discrete I/O points.
 3. The panel shall be properly sized to handle all internally mounted devices. This shall include PLC system, I/O rack, current to current converters, PLC telemetry equipment, terminals, current trip relays, etc., and all other equipment described in this section and as shown on the drawings.
 4. The panel shall be free of dents or other defects.
 5. Provide Ethernet switch to create an Ethernet network between equipment as specified herein.
 6. Provide with a front door mounted data interface port with a CAT6 Ethernet port

and a GFCI receptacle.

- a. The data port shall be UL listed for outdoor use and have a lockable clear weather tight cover.
 - b. The Ethernet port shall be connected to the control panel's Ethernet switch.
 - c. The GFCI receptacles shall be powered from the control panel's incoming 120V AC power via fuses or a circuit breaker.
7. Provide redundant 24VDC power supplies, power isolation and an uninterruptible power supply (UPS) system within the control panel.
 8. Provide ventilation equipment as required to properly maintain equipment operation and heat dissipation.
 9. Provide LED lighting fixtures inside at top of panel with light switch. Number of fixtures as required for sufficient lighting to perform maintenance and troubleshooting.
 10. Provide ground lug.
 11. Provide one duplex receptacle on either end of the control panel for convenience of 120 volt power during service and maintenance of equipment.
 12. Print storage pockets shall be provided on the inside of each panel and shall be of sufficient size to hold all of the prints required to service the equipment.

2.03 PROGRAMMABLE LOGIC CONTROLLERS (PLC's)

A. GENERAL

1. Furnish and install a complete modular PLC based control system at the pump station. This section of the specifications shall provide the hardware requirements for each of the PLC's to be provided for this project. In order to provide a complete and compatible system, this section of the specifications shall be referred to by other related sections. This has been done in order to provide equipment to be supplied by others, which is of the same manufacturer as this section for a completely compatible system architecture and structure.
2. The PLC system provided in the control panel shall come equipped with 20 percent spare I/O of each type utilized and the capability for an additional 20 percent future I/O of each type utilized.

B. PLC PLATFORM

1. Furnish and install the control system in accordance with the Performance Criteria Section of this specification and as detailed on the Contract Drawings. Each PLC shall include but not to be limited to: processor module (CPU), communications interface module, power supplies, software for PLC programming, operator interface system diagnostics, communications, data

acquisition, and module racks. The PLC shall collect data, process control functions, communicate with other PLCs, distribute process information along the data highway, and may have their program down loaded from programmer's terminal, and be locally programmed from a portable laptop computer messages (report by exception) to an operator interface to reduce network traffic.

2. The PLC system shall be furnished by a single vendor who has actively been manufacturing programmable logic controllers of the required specified capabilities and whose products have operated successfully for a period of at least eight years. All PLC equipment shall have the following agency approval: UL, CSA, FM Class 1, Div. 2. All PLC equipment shall have a three (3) year factory warranty.
3. The PLC system manufacturer shall maintain, as part of a national network, engineering service facilities within 200 miles of the Project, to provide start-up service, emergency service calls, repair work, service contracts, maintenance, and training of Department personnel. Emergency service shall be available within twenty-four hours of notification.
4. PLC equipment and related hardware shall be CompactLogix by Allen Bradley.

C. CONSTRUCTION

1. The programmable logic controller and operator workstation shall be designed, manufactured and tested to the latest applicable NEMA, IEC, ANSI, and IEEE standards. The programmable logic controller shall meet or exceed the following industry standard specifications:
 - a. RFI Immunity: ICS 2-230
2. The PLC and operator workstation shall be solid state, modular, and field expandable design allowing the system to be tailored to meet the application. The design shall have the capacity to allow for the expansion of the system by the addition of hardware and/or software.
3. The PLC and all of its components shall be capable of operating in an ambient temperature of 0 to 60 degrees Celsius (32 to 140 degrees Fahrenheit) and shall function continuously in the relative humidity range of 0-95 percent non-condensing.
4. Each PLC system shall include, but not be limited to, the following:
 - a. I/O chassis
 - b. Local I/O modules
 - c. Power Supply
 - d. Processor modules

- e. Remote I/O scanner module
 - f. Remote I/O module
 - g. Cables
5. Each unit shall be capable of handling the required number of process inputs and outputs as specified herein and shown on the Contract Drawings, plus 15 percent active spares, plus capacity to accommodate 20 percent future inputs and outputs by the addition of the required circuit cards.
 6. The PLC shall be capable of stand-alone operation in the event of a communication link failure.
 7. All system modules, main and expansion chassis shall be designed to provide for free airflow convection cooling. No internal fans or other means of cooling, except heat sinks, shall be permitted.
 8. Nameplates shall be provided for each module, device and equipment with appropriate data such as equipment number, rating, serial number, and manufacturer.

D. CENTRAL PROCESSING UNIT (CPU)

1. The CPU shall read the inputs, perform all system logic, conduct on-line diagnostics, and control the outputs. Diagnostics shall include memory checks, communications monitoring, I/O bus monitoring, watchdog timing, and user program validation. If an I/O module fault is detected, the processor shall turn off the affected module.
2. The CPU shall be a self-contained unit, and shall provide ladder rung program execution and support remote or local programming. The CPU shall provide I/O scanning and inter-processor and peripheral communication functions.
3. The CPU shall give visual indication by illuminating an indicator when no fault is detected and an indicator when a fault is detected.
4. The main CPU front panel shall include three communication ports, one USB for local programming and two Ethernet ports for connection into the Ethernet switch to allow programming, data transfer, and SCADA connections. The Ethernet connector shall support communication to as many as 60 nodes.
5. The main chassis front panel shall include, but not be limited to the following:
 - a. Run mode of the CPU
 - b. Fault status of the CPU
 - c. Forced I/O

- d. Battery Low Condition
 - e. If a remote device is communicating via the inter-processor communications link
6. A minimum of 3MB solid-state RAM user memory shall be provided for storage of the control program. The full memory of the CPU shall be useable for program or data storage.
 7. Program back-up shall be battery backed RAM along with EEPROM for reliable program back-up.
 8. Program functions shall include standard functions: contacts, coils, timers, counters, math functions, (add, subtract, multiply, divide) shift registers, bit, and word operations; and advanced functions: floating point math calculations including integer to floating point conversion, floating point to integer conversion, add, subtract, multiply, divide, square root, compare, and trigonometric functions.
 9. Program functions shall include PID closed loop and cascaded PID loop control. The PID loop shall perform:
 - a. Output tracking for bumpless transfer between auto and manual mode.
 - b. Reset windup limiting.
 - c. Process variable alarming.
 - d. Output preloading or bias.
 - e. Adjustable rate filtering.
 - f. Adjustable solution time base of 0.1 to 20.0 seconds.
 10. The CPU shall include an integral real-time clock, backed up by an internal lithium or long term type battery, which can be accessed from the control program. The clock shall include functions for time of day (year, month, day, hour, minute, second, and day of the week), alarm, and operation hours counter.
 11. The CPU shall permit changing ladder program and data values while running.
 12. The CPU shall permit the addition of application specific instructions, created in a high level language, to augment the standard instruction set.

E. POWER SUPPLY

1. The programmable controller shall operate in compliance with a nominal electrical service of 85 to 132 VAC, single phase, and in the frequency range from 47 to 63 Hz.

2. The PLC power supply shall be of sufficient capacity to provide all required DC power to all PLC equipment, discrete and analog input/output circuitry under full load, and chassis-mounted communications equipment. The power supply shall be capable of providing 5 VDC, 12 VDC, 24 VDC or other required power to the CPU, I/O modules, chassis-mounted communication devices, and to other elements within the PLC.

F. PLC MODULES

1. All field wiring shall be to a removable terminal block, which will permit prewiring of the module, or removal and replacement of a module without disturbing the field wiring or any other I/O modules. All I/O modules shall be firmly attached to the I/O chassis.
2. All discrete I/O wiring shall be minimum No 14 AWG, RHW-2, 600 volt.
3. All modules shall be enclosed in rugged plastic, or metallic housings.
4. Input and output modules shall have faceplates which shall be marked or labeled in accordance with the Contract Drawings.
5. Inputs shall be optically isolated to protect bus circuits from transients and surges. Light emitting diodes, one adjacent to each pair of input terminals shall be provided to indicate a closed contact, conducting transistor switch; a low positive logic level, or AC line voltage on conditions.
6. All DC output circuits shall incorporate reverse voltage protection and AC output circuits shall include fuses. Dry contact output contacts shall be rated for 10 amperes at 120 volts AC minimum. Isolation resistance shall be 1000 ohms minimum at 300 volts DC between any set of field terminals and any other set or earth ground. Isolation voltage shall be 1500 VAC rms. minimum between any set field terminals and any other set or earth ground. Light emitting diodes shall be provided adjacent to each pair of output terminals for on status indication. Dry output contacts shall be provided for all field device digital output control.
7. The analog input modules shall have a maximum of four isolated differential channels per module and shall accept 4-20 mADC from field-mounted transmitters. Over voltage protection shall be 7.5 Vac RMS. Input signal conversion shall be a minimum of 14-bit resolution.
8. Analog output modules shall have a maximum of four isolated differential channels per module and shall convert 14-bit data words into proportional, isolated 4-20 mA DC analog output signal. Output load drive capability shall be 500 ohms minimum for each output. Accuracy shall be +0.298 percent of full-scale output span. Analog output modules shall be selectable on a point per point basis to either hold the last state or to return to zero upon reset or stop of the programmable controller.

G. PLC PROGRAMMING

1. The programming format shall be traditional relay ladder diagram.

2. It shall be possible to program a maximum instruction matrix of eleven wide by seven deep containing as many as 70 examine instructions.
3. The capability shall exist to change a contact from normally open to normally closed, add instructions, change addresses, etc. It shall not be necessary to delete and re-program the entire rung.
4. It shall be possible to insert relay ladder diagram rungs anywhere in the program, even between existing rungs, in so far as there is accommodated these additions.
5. Timer instructions shall include selectable time bases in increments of 1.0 second and 10 milliseconds. The timing range of each timer shall be from 0 to 65,535 increments. It shall be possible to program and display separately the timer's preset and accumulated values.
6. The programmable controller shall store data in the following formats:
 - a. Single integer numbers ranging from 0 to 65,535.
 - b. Floating point numbers conforming to IEEE floating point format
 - c. Decimal numbers ranging from 0 to 9,999
7. At the request of the programmer, data contained in system memory shall be displayed on the CRT programming panel. This monitoring feature shall be provided for input/output status, timer/counter data, files, and system status. Ladder logic rungs shall be displayed on the CRT with rung numbers in sequential order.
8. The system shall have the capability to enter address comments and symbols.
9. The programming software shall also provide the following functions:
 - a. Full on-line and off line capabilities from one integrated software package.
 - b. Hot Keys: Keys for short cut to software functions.
 - c. File Management: Create, Delete, rename, and merge program files.
 - d. Memory Map: Display processor memory usage.
 - e. Data Monitor: Display the contents of data files.
 - f. Save & Restore: Save processor memory files to disk; restore processor memory files from disk.
 - g. I/O Configuration: Configure intelligent I/O modules.
 - h. General Utility: Display general system information and clear faults.

- i. Forcing: Force I/O on and off.
- j. Import & Export: Convert database files (which contain symbols, rung comments, instruction comments, and address comments) and processor memory files to ASCII and from ASCII to the programming software.
- k. Display I/O module health status.
- l. Password Protection: Allow up to eight password protected levels of functionality with each level increasing the capability to monitor, troubleshoot, and program.

2.04 OPERATOR INTERFACE TERMINAL (OIT)

- A. An operator interface terminal shall be configured to enable operators to monitor and control the OEM equipment processes. Communications between the operator interface and the PLC shall be completely transparent to an operator.
- B. The operator interface shall have a Windows-based graphic editor.
- C. The operator interface shall be powered from a 120 VAC, 60 Hz power supply. The operator interface shall be capable of operating in a temperature range of 0 to 55 C, and 5 to 95% relative humidity, non-condensing. The operator interface display shall be an Allen Bradley Panelview Plus 10" color touch screen or equal by other manufactures.

2.05 LAPTOP COMPUTER

- A. The laptop computer shall be fully IBM PC compatible. The computer shall be manufactured by Dell, Lenevo, or Hewlett Packard. The laptop computer shall meet the following minimum requirements:
 - 1. Core i3-7100U, 3M Cache, 2.4GHz Dual Core
 - 2. 8 GB, 2133MHz, DDR4 Memory
 - 3. Intel HD Graphics 620
 - 4. M.2 128GB SATA Class 20 Solid State Drive
 - 5. 802.11ac Dual Band (2x) Wireless Adapter+Bluetooth 4.1
 - 6. 8 Hr battery
 - 7. Internal Keyboard
 - 8. 14" HD (1366 x 768) Anti-Glare Non-Touch Screen.
 - 9. Input/Output Ports: Audio Combo, U-SD, U-SIM, (3) USB3.0, RJ45, Nobel Wedge lock slot, USB Type-C Port, HDMI, SC
 - 10. 4G USB cellular broadband modem.

11. AC power adapter
 12. Nylon carrying case
 13. Sound card
 14. 3-year hardware service warranty
- B. Software installed on the laptop computer shall include the latest versions of the following:
1. Windows 10 Pro
 2. Latest McAfee, Norton, or approved equal, anti-virus software with 1-year subscription
 3. Microsoft Office 2016 Professional
- C. Software to be installed on the existing SCADA computer at the Wastewater Treatment Facility shall include the latest versions of the following:
1. Log-Me-In remote access software

2.06 PENDANT CORD OPERATOR STATION

- A. UL Listed NEMA 6 Rated pendant cord operator with an emergency stop maintained pushbutton and a spring return run pushbutton.
- B. Operator station housing and cover shall be constructed of steel reinforced neoprene with a safety yellow color.
- C. Cable stress relief shall be built into the housing.
- D. Provide a 50 foot cable, the outer jacket of the cable shall be of chlorinated polyethylene (CPE) and be oil, water, and UV resistant, capable of continuous submerged operation underwater to a depth of 65 feet.

2.07 MAGNETIC FLOW METER

- A. Flow Element (FE)
 1. Type:
 - a. 316 SS self-cleaning bullet nose electrodes
 - b. Steel with Polyurethane Liner
 - c. Connections - ANSI Class 150, RF carbon steel flange
 2. Operation:
 - a. Purpose - To produce a low-level voltage output signal proportional to

flow rate.

- b. Operating Principle - Induced voltage proportional to flow rate is produced by the measured fluid (conductor) moving through a magnetic field. Voltage sensed across a pair of diametrically opposed electrodes in a pipe section.

3. Functional:

- a. Power Requirement - supplied by magnetic flow converter.
- b. Max Power Consumption - 1 Watt per 5 mm (diameter).
- c. Electrical Class - NEMA 4X plus temporary submergence at 25-ft for 48 hours.

4. Physical:

- a. Electrodes - Type 316 SS, field replaceable, configuration for periodic electrode inspection or cleaning.
- b. Body - Carbon Steel.
- c. Liner - Polyurethane.
- d. Coils - Completely potted with epoxy-based compound.
- e. Ends - Carbon Steel flanges
- f. Exterior Surface - Epoxy coated.
- g. Grounding rings - Stainless steel grounding rings with grounding strap.
- h. Approvals - FM.

5. Performance:

- a. Accuracy - ± 0.5 percent of rate between 10 percent and 100 percent of flow (including transmitter).
- b. Documentation Required - Certified hydraulic lab calibration data.

B. Flow Transmitter (FIT)

1. Type:

- a. Liquid crystal display with rate and total.
- b. 4-20 mA DC Output.
- c. NEMA 4X Enclosure.

2. Operation:

- a. Purpose - Provides coil drive current to the flow tube and convert the electrode signal from the flow tube into 4-20 mA signal linear with flow.
- b. Circuitry - Microprocessor-based with data stored in nonvolatile EEPROM memory, performing continuous self-diagnostics. Solid-state integrated circuitry, feedback electronically controlled. External contacts shall initiate circuitry that clamps the output to 4 mA under no flow conditions.

- 3. Functional:
 - a. Input - Low level input from electromagnetic flow element.
 - b. Power Requirement - 120 VAC \pm 10 percent, 60 Hz.
 - c. Output - 4-20 mA DC into 0 to 750 ohms.
 - d. Indicator - LCD.
- 4. Physical:
 - a. Case Material - Cast aluminum.
 - b. Case Type - NEMA 4X.
 - c. Mounting - Wall mounted.
- C. Performance:
 - 1. Systems Accuracy - \pm 0.5 percent of rate between 10 percent and 100 percent of flow (including flow element).
- D. Manufacturer: Endress & Hauser, Krohne, ABB, Foxboro or equal.

2.08 LEVEL ELEMENT/TRANSMITTER (SUBMERSIBLE PRESSURE TRANSMITTER)

- A. Type: Submersible pressure transmitter for waste water applications with vented cable, two-wire, piezoresistive pressure sensing technology with welded 316 stainless steel diaphragm.
- B. Operation Purpose: To sense pressure and produce a standard 4-20 mA DC output signal linear with level; sensing element -piezoresistive pressure sensor.
- C. Functional: Pressure ranges - 0 to 5 through 0 to 300 psig; proof pressure limit 1.5 times full scale; burst pressure limit - 2.0 times full scale; power supply - DC (loop powered); output - 4-20 mA DC.
- D. Physical: Wetted parts - 316 stainless steel, fluorocarbon; operating temperature range - minus 10° to plus 60°C; compensated temperature range - 0° to 50°C; cable - polyurethane jacketed, shielded with polyurethane vent tube and vent filter/vapor trap; mounting - suitable for mounting in a 4-in stilling well, suspended from cable.
- E. Provide aneroid bellows venting accessories with connection to transducer, din-rail mounted terminal blocks for termination of transducer signal wire and control panel signal wire, and din-rail mounted surge protection devices; Accessories - vent-hole or breather element to maintain atmospheric pressure within enclosure.
- F. Performance: Static accuracy - \pm 0.50 percent of best fit straight line (BFSL), including the combined errors due to nonlinearity, hysteresis, and non-repeatability at 25°C; thermal error - \pm 0.05 percent full scale output per degree Celsius (maximum deviation from a BFSL).

- G. Provide and mount a perforated PVC stilling well for each transducer to minimize interference with rags and solids.

2.09 LEVEL SWITCH - FLOAT TYPE

1. Float switches shall be of non-mercury type, 3½-in diameter hermetically sealed, molded polypropylene construction and include a Form C, tilt-type, switch rated for switching 10 ampere resistive loads at 120 VAC. Switches shall include 40 feet of nitrile PVC jacketed, Type SO, 3-conductor, No. 14 AWG cable suitable for underwater service. Switches shall be rated for the NEMA area in which installed. Switches shall also include Type 316 stainless steel mounting hardware and weighted cord collar. Switches shall be installed per the manufacturer's requirements.
2. Level switches shall be manufactured by Consolidated Electric Co., Flygt, Magnetrol, or equal.

2.10 MISCELLANEOUS EQUIPMENT

A. INDUSTRIAL ETHERNET SWITCH

1. The industrial Ethernet switch shall have minimum eight 10BASE-T/100BASE-TX RJ-45 ports and two 100Mbps fiber optic ports. RJ-45 ports shall support auto negotiation or manual configuration for 10/100 MHz or full/half duplex.
2. The industrial Ethernet switch shall be IEEE 802.3 compliant. The switch shall support 10BASE-T, 100BASE-TX and 100BASE-FX standards. The switch shall support IEEE 802.3x flow control. Port setting controls shall include enable/disable and speed selection. The switch shall use store-and-forward switching mode.
3. The industrial Ethernet switch shall have an LED power indicator and shall operate from a 24 VDC power source if panel mounted and 120 VAC otherwise. The switch shall have LEDs for link status. The switch shall have a fault relay contact. The switch shall be suitable for operating from 0°C to 50°C and from 10 percent to 95 percent non-condensing relative humidity. The switch shall be UL approved. The switch shall be suitable for DIN-rail mounting if mounted within a control panel.
4. The industrial Ethernet switch shall support a tree or ring network topology. The switch shall support SNMPv3 and IP addressing via BootP/DHCP. The port configurations shall be accessible through a standard Web browser.
5. The industrial Ethernet switch security features shall include capability to disable ports and password security for configuration. The switch shall support multicast messaging via IGMP protocol and shall utilize IGMP snooping. The switch shall support port based virtual LAN (VLAN) configuration. The switch shall support the IEEE 802.1p standard for QoS traffic prioritization. The switch shall come supplied with configuration and management software for installation on a Windows-based PC. The switch shall come supplied with all necessary cables to connect the switch to a Windows-based PC for configuration.

B. ELECTRICAL RELAYS

1. Electrical relays for handling power circuits shall be general purpose equal to IDEC, Omron, Allen-Bradley, Potter & Brumfield, or approved equal. Relays handling control, telemetering or alarm functions shall be general-duty, plug-in type, complete with dust and moisture proof enclosure equal to IDEC, Omron, Allen-Bradley, Phoenix Contact, Potter & Brumfield, or approved equal. Units shall be provided with integral indicating light to indicate if relay is energized. Units shall have DPDT relay contacts and be rated for 10 A at 120 VAC, 10 A at 24 VDC
2. Time delay relays shall have DPDT relay contacts and be suitable for on-delay or off-delay operation. Rated load shall be 10 A at 120 VAC, 10 A at 24 VDC. Units shall be provided with integral time-delay adjustment knob. Relays shall be provided with dust and moisture resistant covers. Relays shall be suitable for operating in a temperature range from -30° to 55° C. Units shall be adjustable and available in a single range or multiple ranges from 0.1 second to 10 hours. Time delay relays shall be UL listed. Mounting sockets matched to relay and mounting rails/holders shall be provided as required. Time delay relays shall be as manufactured by IDEC, Allen Bradley, or Engineer-approved equal.

C. CURRENT-TO-CURRENT CONVERTERS

1. Current to current converters shall transform a current input signal (1-5, 4-20, or 10-50 mA) to a proportional 4-20 mA current output signal. The unit shall be of solid state electronic circuitry sealed in a protective epoxy compound, and shall be for surface or rear of panel mounting.
2. Current to current converters shall provide signal conversion capabilities, input/output isolation and output power boosting.
3. Signal output drive capability shall be 4-20 mA into 600 ohms load.
4. Accuracy shall be 0.25 percent of span.

D. INTRINSICALLY SAFE PANEL

1. Provide a panel to house intrinsically safe current isolators and intrinsically safe relays. The panel shall have din-rail mounting terminal strips for all wiring and shall receive power from the RTU control panel.
2. Intrinsically Safe Current Isolators
 - a. Din rail mounted intrinsically safe current isolators shall be furnished for interconnection of each wetwell level transmitters.
 - b. Operating voltage shall be 115 VAC, 60 Hz.

- c. The intrinsically safe control circuit shall be approved by Factory Mutual and the Canadian Standards Association for Class 1, 119 111; Division 1; Groups A, B, C, D, E, F, G hazardous locations.
 3. Intrinsically Safe Relays (IS Relays)
 - a. Din rail mounted intrinsically safe relays shall be furnished for interconnection of each float switch located in the wet well.
 - b. Operating voltage shall be 115 or 230 VAC, 50/60 Hz.
 - c. Load contacts shall be double pole, double throw and shall be rated for 10 amperes resistive load or 3 amperes inductive load at 120 VAC.
 - d. The intrinsically safe control circuit shall be approved by Factory Mutual and the Canadian Standards Association for Class 1, 119 111; Division 1; Groups A, B, C, D, E, F, G hazardous locations.

E. LIGHTNING/SURGE PROTECTION

1. Lightning/surge protection shall be provided to protect the instrumentation system from induced surges propagating along the signal and power supply lines. The protection systems shall be such that the protective level shall not interfere with normal operation, but shall be lower than the instrument surge withstand level, and be maintenance free and self-restoring. Ground wires for all surge protectors shall be connected to a good earth ground and where practical each ground wire run individually and insulated from each other.
2. Protection of all 120 volt ac instrument cabinet power supply lines and individual field instruments shall be provided. Cabinets shall be protected by isolation transformers and surge suppressers.
3. The unit shall be back panel mounted and is to be connected between the telephone line and the telemetry and control equipment. Transient voltages above 90V line to ground or 180V line to line will cause the gas discharge tubes to short to ground. If the peak lasts more than an instant, 1/4 amp fast blow fuses will open the line.
4. Protection of circuits connected over leased or private telephone lines shall be provided with surge and lightning protectors at signal terminal in addition to the normal fused lightning arrestor supplied by the telephone company.
5. Lightning/surge protection units shall be as manufactured by Joslyn Industries or equal.
6. All remote loop powered transmitters shall be provided with close-nippled lightning/surge protection units. The loop shall be terminated at the receiving device/panel with a receiving end lightning/surge protection unit. This shall be provided to all remote equipment for this project.

F. POWER SUPPLIES

1. All two-wire loop powered equipment and all devices requiring 24 VDC power

shall be provided with individual power supplies or shall be powered from a redundant power supply configuration such that there is no interruption in power supplied upon a failure of one of the redundant power supplies.

2. The final requirements and exact locations for the power supplies shall be the responsibility of the Instrumentation and Control System Supplier. These units shall be provided and sized to handle all possible load conditions with sufficient capacity.
3. All power supplies shall be of the same manufacturer and of the same type wherever possible. Power supplies shall be DIN-rail mounted.
4. All power supplies shall be regulated and shall be suitably protected during the operation of the unit and also incorporate protection to the equipment it serves.
5. Each power supply shall have a Form C dry contact wired to the PLC I/O for indication of power supply failure.
6. Power supplies shall be a manufactured by Sola, Phoenix Contact, Omron, or equal.

2.11 EXISTING SCADA SYSTEM

- A. The existing SCADA system, including screens, report generations, software alarm dialer, historical trending, data archiving, alarm management, and ect. shall be modified for the additional of the new pump station monitoring, alarming, control, data collection/data archiving and report generation.
- B. SCADA system software shall be fully customized and configured by the Instrumentation and Control System Supplier to perform the functions described in this Section. The system software shall be configured to provide all features including: equipment monitoring, process monitoring and control, data acquisition/data archiving, alarming and alarm management, alarm and event logging, real time and historical trending, report generation, security, application integration, cross-platform integration and all other features as specified herein for this SCADA system.
- C. The SCADA system shall be configured to collect, process, store, and report process variable data and user entered data, and automatically load such data into specifically designed Microsoft Excel spreadsheet files and/or pre-designed numerical, graph and report templates.
- D. The Instrumentation and Control System Supplier shall be responsible for arranging any necessary coordination for the SCADA system and shall insure and guarantee a complete, operational, and acceptable system.
- E. The SCADA system shall automatically collect and store a variety of measured process variable data, accept user entered data and shall be programmed to

automatically generate daily, weekly, monthly, and annual hardcopy text reports and selected graphic reports.

2.12 SPARE PARTS

- A. Spare parts shall be provided as a part of the start-up services during the initial start-up and phase-in period. These items shall include accessories such as fuses, circuit breakers, power supplies, I/O cards, lights, etc. required to start-up and operate the system for a period of 60 days. These items shall be packaged in separate containers and shipped to the job site with the instruments and shall be tagged "INSTRUMENT START-UP EQUIPMENT".
- B. Spare parts above and beyond those being provided for start-up services shall be provided under this Section. All spare parts shall be packaged and shipped at one time. Separate shipment of spare parts shall not be acceptable. The Engineer shall be notified of the shipment release in writing indicating that all items have been shipped. Each item shall be checked by the Engineer as being received and that all components have been provided as specified.
- C. Furnish one box of spare fuses of each type supplied. A box shall consist of a minimum of 12 fuses.

PART 3 – EXECUTION

3.01 INSTALLATION

- A. Instrumentation and accessory equipment shall be installed in accordance with the best field and shop practices.
- B. The workmanship shall be in accordance with the best field shop practices for the instrument and control systems.
- C. All workmen shall be skilled in the work to which they are assigned and all work shall be performed under the direct supervision of an experienced and competent instrument foreman.
- D. All wiring and piping shall be constructed perfectly plumb, square, level, and true to lines and surfaces indicated in a neat, substantial and workmanlike manner, and in such a way as to properly serve for the purpose intended. All members and parts, upon installation, shall be properly framed, secured together and anchored in place. All cuts shall be deburred and immediately cleaned from opposite end before connecting.
- E. All instruments shall be mounted, piped and connected in strict accordance with the manufacturer's instructions.
- F. All internal wiring of the instrument panel shall be done by the panel manufacturer in accordance with the drawings and instrument manufacturer's instructions.
- G. The loops on the drawings and the instrument specifications and index sheets indicate the

intent of the interconnections between and the type of individual instrument. The proposed equipment shall be complete with all mounting hardware and accessories to satisfy the functional requirements.

- H. All work shall be executed in full accordance with codes and local rulings. Should any work be performed contrary to said rulings, ordinances and regulations, the Instrumentation Contractor shall bear full responsibility for such violations and assume all costs arising therefrom.
- I. All piping to and from field instrumentation shall be provided with necessary unions, test tees and shut-offs.
- J. Interfacing fixtures shall be compatible with the equipment to which they are attached and shall comply with the applicable specifications.
- K. In-line devices, flow or level elements, specified herein shall be installed under DIVISION 15 - MECHANICAL.
- L. Wiring of in-line devices, flow or level elements, specified herein shall be installed under DIVISION 16 - ELECTRICAL.
- M. Coordination with the process and equipment in addition to standard quoted fixtures require to conform the instrumentation to the process shall be the responsibility of the General Contractor. The Instrumentation Contractor shall provide detail information on the fixtures being supplied and the extent of the field installation required.
- N. Brackets and hangers required for mounting of equipment shall be provided as noted on the drawings or as required. They shall be done in a workmanlike manner and not interfere with any other equipment.
- O. Investigate each space in the building through which equipment must pass to reach its final location. If necessary, the manufacturer shall be required to ship his material in sections sized to permit passing through such restricted areas in the building.
- P. The shield on each process instrumentation cable shall be grounded as directed by the manufacturer of the instrumentation equipment but in no case shall more than one ground be employed for each shield.
- Q. Maximum practical separation shall be maintained between signal (analog, alarm, and status) conduits and power feeders and AC systems.
- R. All conductors running from the field to the control panel shall be a single, continuous length without splices, except at approved junction boxes. The junction boxes shall have terminal blocks with 20% spare in addition to terminals for all wires including spare wires. Special care shall be exercised to carry grounding lines through such junction boxes with the least possible resistance.
- S. Multi-conductor cable may be used between junction boxes and control panels.
- T. All field conductors shall terminate at the control panel terminal board. Millivolt signal

wires (i.e., thermocouple) may be connected direct to the input terminals of the receiving instrument if so specified.

- U. All wire ends shall be terminated with hook fork type non-split compression lugs.
- V. All wire ends shall be identified at both ends with wire markers.
- W. Entry to field enclosures shall be through the back, side, or bottom (not top) with weatherproof hubs. Wiring shall enter near the terminal point and not obstruct access to removal of components.
- X. Lifting rings from cabinets/assemblies shall be removed. Hole plugs shall be provided for the holes of the same color as the cabinet.

3.02 START-UP

- A. Prior to final connection to the main instrument control panel, the Instrumentation Contractor shall thoroughly clean all work completed including the interior of all panelboards; and remove all dirt, trash, and foreign material. The outside of all instrument panelboards are to be cleaned and damaged painted surfaces touched up as required to leave the equipment in an acceptable condition. This shall include all nameplates, tags, and identification of equipment and devices within or on the front of the panels.
- B. It shall be the responsibility of the vendor to provide a factory trained and qualified serviceman from the manufacturer's of the equipment to TEST AND CALIBRATE ALL EQUIPMENT and to INSTRUCT the Contractor on EQUIPMENT INSTALLATION and the ENGINEER on operation of the equipment.
- C. No other instrumentation system manufacturer's personnel other than those persons directly from the service department of the manufacturer of the equipment shall be acceptable to perform this work.
- D. The start-up services shall be performed by qualified personnel from the service department of the equipment manufacturer with a minimum of five years experience on the equipment being provided by this contract, or equal.
- E. During the start-up, the Instrumentation shall provide sufficient personnel to aid with the start-up of the instrument and control equipment to be provided and installed by this Section and by this Contract. This shall include services to correct any faults and to make the necessary adjustments for the proper operation of the equipment and installation.

3.03 TESTING AND CALIBRATING

- A. Testing and calibration of equipment shall be done in the presence of the Engineer.
- B. Prior to electrical check out all breakers, switches and similar disconnect devices shall be placed in the off position.
- C. The panel and other equipment grounding shall be verified.

- D. Visual inspection and continuity testing shall be made to verify that no damaging wiring errors occur between power and signal wiring.
- E. The systems shall be checked for improper or accidental grounding.
- F. Each system and component shall be energized and their inputs simulated. The output shall be checked to verify the proper calibration and interaction with associated hardware.
- G. Hypotting shall not be permitted on instrument systems unless specific instructions are given to safeguard electronic equipment from damage.
- H. Prior to actuating a final control element (valve, level actuator, or variable frequency drive) the Instrumentation Contractor shall obtain the permission of the General Contractor and any other involved contractors to prevent damage to associated equipment.
- I. The factory serviceman shall verify the calibration and direction of the final control element in accordance with the requirements for each portion of the system.
- J. Instrument and control calibration and control loop checkout shall be the responsibility of the manufacturer of the equipment.
- K. The Instrumentation Contractor shall arrange for and obtain the services of a factory trained service qualified engineer from the manufacturer's of the equipment to perform the calibration and commissioning of the entire system.
- L. Each instrument shall be calibrated at 10 percent, 50 percent, and 90 percent using test instruments that are rated to an accuracy of at least five times greater than the instrument being checked. The test instrument shall have its accuracy traceable to the National Bureau of Standard as applicable.
- M. Upon completion of the work, the Instrumentation Contractor shall demonstrate to the Owner the proper operation of all equipment and systems.
- N. The Instrumentation Contractor submit to the Engineer all test data, inspection test certificates, manufacturers' warranties certified calibration data, certified prints, manufacturers' installation, operation and maintenance manuals, electrical wiring and control diagrams with all noted field modification for an as-built record for the system, and required and suggested spare parts lists.
- O. A factory test shall be scheduled by the instrumentation system manufacturer for the entire system. A simulated system layout which shall include all equipment and interconnections shall be arranged to perform all system functions. The testing shall be performed in the presence of the Engineer. A two week written notification shall be provided to the Engineer to allow for scheduling the testing.
- P. Upon completion and satisfactory performance an approval notification shall be provided for this portion of the work for this Section. No equipment shall be allowed to be shipped from the factory without approval for this portion of the work.

3.04 USER INTERFACE

- A. Graphic screens shall be configured so that an operator can access the Main Menu screen with one action from any SCADA or OIT system screen, not including pop-up screens. Each screen, excluding pop-up screens, shall bear the screen title at the top with date/time information and user login information. Each screen, excluding pop-up screens, shall have an alarm banner that displays at least the three most current alarms and contains the following information: acknowledged/unacknowledged, time/date in, alarm description/message and value. Each screen, excluding pop-up screens, shall contain navigation buttons or a pull-down menu to enable operators to quickly access related screens.

- B. The Instrumentation and Control System Supplier shall follow the guidelines listed below when animating the graphic screens. The Instrumentation and Control System Supplier shall furnish, as part of the Software Submittal a animation plan addressing the items listed below for review by the Engineer and Owner prior to developing HMI graphic screens, historical trend charts and pop-up screens.
 - 1. Colors. HMI screen background color shall be muted. Equipment without conditional visibility shall be depicted in a muted color. Safe or off conditions shall use a vibrant green color. On, running or open conditions shall use a vibrant red color. Status indicators and process variables shall be black/blue text in a recessed white box. Alarm and warning messages shall be a vibrant red text, either stand-alone or in a non-recessed white box, and shall flash on/off until acknowledged. All equipment shall be identified with black/blue text. All process variables shall be identified by tag number and function with black/blue text.

 - 2. Visibility. Conditional visibility shall be used to indicate the current state of all process equipment and valves that have status inputs to the system. The HMI graphic for motorized equipment and valves shall change to a vibrant red cooler when the motorized equipment is operating or the valve is open; the HMI graphic for motorized equipment and valves shall change to a vibrant green color when the motorized equipment is not operating or the valve is closed. Pushbuttons shall change color to indicate position (e.g., vibrant red when pushed to start equipment, vibrant green when pushed to stop equipment). Selector switches shall change position to indicate and highlight the selection (e.g., Hand, Off or Auto). Motorized equipment, valves, pushbuttons and selector switches shall also have text status indicators in addition to conditional visibility.

 - 3. Storage vessels (tanks, wet wells, etc.) shall be animated to indicate current level and shall have dynamic level indication with the appropriate engineering units. Level indication shall be black/blue text in a recessed white box. Level instrument tag number shall be black/blue text.

 - 4. All analog process variables shall have dynamic indication with the appropriate engineering units. Process variable indication shall be black/blue text in a recessed white box. Process variable instrument tag number shall be black/blue text.

5. Motorized equipment with a run status input to the system shall display accumulated runtime in black/blue text in a recessed white box.
 6. New alarms shall be annunciated audibly at the SCADA computers and OIT.
- C. The Instrumentation and Control System Supplier shall follow the guidelines listed below when creating pop-up screens for process equipment and valve control, and alarm and PID loop set point entry.
1. A pop up screen shall be superimposed on the HMI graphic screen when an operator uses the mouse to click on a piece of process equipment, a valve or an instrument. The pop up shall have a "RETURN" button to enable the operator to return to the HMI graphic screen without performing any control actions or set point changes.
 2. The pop up shall contain information about the equipment, instrument or devices current status such as on/off, local/remote, hand/off/auto, manual/auto, service designation (e.g., lead, lag, standby, etc.) alarm set points, PID loop set points and PID parameters, etc. as defined in the loop descriptions.
 3. The pop up shall also contain any interlock status information as defined in the loop descriptions.
- D. The Instrumentation and Control System Supplier shall modify and create as needed the following screens. This list is not comprehensive and the Instrumentation and Control System Supplier shall create additional screens as necessary to provide SCADA system functionality as specified and shown in the Contract Documents. Each screen shall have navigation buttons to access the Process Overview, Master Display, Alarm Summary, Help and Main Menu screens by one mouse click.
1. Main Menu - Listing of all process-related SCADA system screens with navigation buttons to access any of the screens with one mouse click
 2. Process Overview - Geographic representation with links to remote site screens
 3. Master Display - All process variables and major equipment operating states
 4. Network and Remote Site Communication Status - status for office network and for each remote site and enable/disable communications for each remote site
 5. Pump Station Screen with Real Time Trends
 6. Process Equipment Runtimes
 7. Flow Totalizations
 8. Help - Explanation of the meaning of graphic symbols and text appearance
 9. Alarm Summary that contains the following information: Acknowledged/Unacknowledged, Date/Time In, Node (if applicable), Tag Name

and Description/Message (overall and one screen for each designated process, plant or system). The screen shall have a pushbutton that enables an operator to acknowledge all alarms with one mouse click.

10. Alarm Configuration (ability to set time delays, enable/disable individual alarms, set alarm priority) and Alarm Dialer operation
11. Historical Trends - up to four analog points per trend, grouped per the Owner's and Engineer's instructions
12. Analog Registers (process set points, alarm set points, time delays, etc. with tag number and description)
13. Reports/Manual Text Entry for Reports/Printing Reports

3.05 MANUFACTURER'S SERVICES

- A. The supervisory service of a factory-trained service engineer who is specifically trained on the type of equipment herein specified shall be provided for a period of not less than four 8-hour days during construction to assist the Instrumentation and Electrical Contractors in equipment installation, the location of sleeves, methods of installing conduit and special cable, mounting, piping and wiring of one of each type of device, and the methods of protecting all of the equipment prior to placing it into service. Upon completion of the installation, the services of the above service engineer shall be provided for a period of not less than six 8-hour days for calibration, testing and start-up of the equipment. The instrumentation system supplier shall conduct a group training program on the operation and routine maintenance of the system. The training shall be conducted at the installation site and consist of five classroom and field training sessions, 8 hours a day during normal working hours. The text shall be the loop diagrams, operation and maintenance manual and shall concentrate on the operation of the equipment as applied to this process. The minimum days specified above do not relieve the manufacturer of providing sufficient service to place the system in satisfactory operation.

3.06 PRODUCT HANDLING

- A. Upon completion of shop assembly and testing, all control panels shall be enclosed in heavy-duty polyethylene envelopes or secured sheeting to provide complete protection from dust and moisture. Dehumidifiers shall be placed inside the polyethylene coverings. The equipment shall then be skid-mounted for final transport. Lifting rings shall be provided for moving the equipment without removing protective covering. Boxed weights shall be shown on shipping tags together with instructions for unloading, transporting, storing and handling at the job site.
- B. Special instructions for proper field handling and installation required by the manufacturer for proper protection shall be securely attached to each piece of equipment prior to shipment.
- C. Each package shall be tagged to identify its location, tag number and function in the system. Identification shall be prominently displayed on the outside of the package.

- D. A permanent stainless steel or other noncorrosive material tag firmly attached and permanently and indelibly marked with the instrument tag number as given in the tabulation shall be provided on each piece of equipment supplied under this section.
- E. Equipment shall not be stored out-of-doors. Equipment shall be stored in dry permanent shelters and, including in-line equipment, shall be adequately protected against mechanical injury. If any apparatus has been damaged, such damage shall be repaired or the damaged equipment replaced by the Instrumentation Contractor at his own cost and expense. If any apparatus has been subject to possible injury by water, it shall be thoroughly dried out and put through such tests as directed by the Engineer. This shall be at the cost and expense of the Instrumentation Contractor or the apparatus shall be replaced by the Instrumentation Contractor at his own expense.

3.07 GUARANTEE

- A. For guarantee, refer to General Conditions.

CONTROL PANEL AND OPERATOR STATION LIST										
Designation	Description	Location	NEMA Rating	Material	Min. Height	Min. Width	Min. Depth	Mounting	UPS	OIT
RTU-1	Main Lift Pump Station SCADA RTU	Main Lift Station	12	Galvanized Steel	48-in	30-in	12-in	Wall	YES	YES
OS-101	Sewage Pump #1 Operator Station	Main Lift Station Basement	6	Steel Reinforced Neoprene	4-in	2-in	2-in	Pendant Cord	NO	NO
OS-102	Sewage Pump #2 Operator Station	Main Lift Station Basement	6	Steel Reinforced Neoprene	4-in	2-in	2-in	Pendant Cord	NO	NO
OS-103	Sewage Pump #3 Operator Station	Main Lift Station Basement	6	Steel Reinforced Neoprene	4-in	2-in	2-in	Pendant Cord	NO	NO
OS-104	Sewage Pump #4 Operator Station	Main Lift Station Basement	6	Steel Reinforced Neoprene	4-in	2-in	2-in	Pendant Cord	NO	NO
OS-105	Sewage Pump #5 Operator Station	Main Lift Station Basement	6	Steel Reinforced Neoprene	4-in	2-in	2-in	Pendant Cord	NO	NO

INSTRUMENTATION LIST								
TAG #	FACILITY	FUNCTION	INSTRUMENT	TYPE	LOCATION	RANGE	UNITS	REMARKS
LT-100A	Main Lift Pump Station	Wet Well #1 Level	Level Transmitter	Submersible Pressure	Wet Well #1	0-40	FT	Provide Intrinsically Safe Current Barrier
LT-100B	Main Lift Pump Station	Wet Well #3 Level	Level Transmitter	Submersible Pressure	Wet Well #3	0-40	FT	Provide Intrinsically Safe Current Barrier
LSH-100A	Main Lift Pump Station	Wet Well #1 High Level	Level Switch	Float Switch	Wet Well #1	N/A	N/A	Provide Intrinsically Safe Relay Barrier
LSH-100B	Main Lift Pump Station	Wet Well #1 High High Level	Level Switch	Float Switch	Wet Well #1	N/A	N/A	Provide Intrinsically Safe Relay Barrier
LSH-100C	Main Lift Pump Station	Wet Well #2 High Level	Level Switch	Float Switch	Wet Well #2	N/A	N/A	Provide Intrinsically Safe Relay Barrier
LSH-100D	Main Lift Pump Station	Wet Well #3 High Level	Level Switch	Float Switch	Wet Well #3	N/A	N/A	Provide Intrinsically Safe Relay Barrier
LSH-100E	Main Lift Pump Station	Wet Well #3 High High Level	Level Switch	Float Switch	Wet Well #3	N/A	N/A	Provide Intrinsically Safe Relay Barrier
LSL-100A	Main Lift Pump Station	Wet Well #1 Low Level	Level Switch	Float Switch	Wet Well #1	N/A	N/A	Provide Intrinsically Safe Relay Barrier
LSL-100B	Main Lift Pump Station	Wet Well #2 Low Level	Level Switch	Float Switch	Wet Well #2	N/A	N/A	Provide Intrinsically Safe Relay Barrier
LSL-100C	Main Lift Pump Station	Wet Well #3 Low Level	Level Switch	Float Switch	Wet Well #3	N/A	N/A	Provide Intrinsically Safe Relay Barrier
FE-106	Main Lift Pump Station	Force Main A Effluent Flow	Flow Element	Magnetic Meter	Pump Station Force Main A Effluent Line	0-x000	GPM	--
FIT-106	Main Lift Pump Station	Force Main A Effluent Flow	Flow Transmitter	Electronic	Pump Station Force Main A Effluent Line	0-x000	GPM	--

INSTRUMENTATION LIST								
TAG #	FACILITY	FUNCTION	INSTRUMENT	TYPE	LOCATION	RANGE	UNITS	REMARKS
FE-107	Main Lift Pump Station	Force Main B Effluent Flow	Flow Element	Magnetic Meter	Pump Station Force Main B Effluent Line	0-x000	GPM	--
FIT-107	Main Lift Pump Station	Force Main B Effluent Flow	Flow Transmitter	Electronic	Pump Station Force Main B Effluent Line	0-x000	GPM	--
LSH-145	Main Lift Pump Station	Dry Well High	Level Switch	Float Switch	Basement	N/A	N/A	--

IO AND ALARM LIST

IO Tag No	Service	Location	IO Description	IO Type	IO Signal Range	CP Termination	LRL	URL	Units	Alarm List	Remarks
LT-100A	Main Lift Station Wet Well #1 Level	Main Lift Pump Station Wet Well #1	Wet Well #1 Level	AI	4-20 mA DC	RTU-1	0	40	Feet	TRUE	LAHH, LAH, LAL, LALL,
LT-100B	Main Lift Station Wet Well #3 Level	Main Lift Pump Station Wet Well #3	Wet Well #3 Level	AI	4-20 mA DC	RTU-1	0	40	Feet	TRUE	LAHH, LAH, LAL, LALL,
LSH-100A	Main Lift Station Wet Well #1 Level	Main Lift Pump Station Wet Well #1	Wet Well #1 Level High	DI	--	RTU-1	--	--	--	TRUE	--
LSH-100B	Main Lift Station Wet Well #1 Level	Main Lift Pump Station Wet Well #1	Wet Well #1 Level High High	DI	--	RTU-1	--	--	--	TRUE	--
LSH-100C	Main Lift Station Wet Well #2 Level	Main Lift Pump Station Wet Well #2	Wet Well #2 Level High	DI	--	RTU-1	--	--	--	TRUE	--
LSH-100D	Main Lift Station Wet Well #3 Level	Main Lift Pump Station Wet Well #3	Wet Well #3 Level High	DI	--	RTU-1	--	--	--	TRUE	--
LSH-100E	Main Lift Station Wet Well #3 Level	Main Lift Pump Station Wet Well #3	Wet Well #3 Level High High	DI	--	RTU-1	--	--	--	TRUE	--
LSL-100A	Main Lift Station Wet Well #1 Level	Main Lift Pump Station Wet Well #1	Wet Well #1 Level Low	DI	--	RTU-1	--	--	--	FALSE	--
LSL-100B	Main Lift Station Wet Well #2 Level	Main Lift Pump Station Wet Well #2	Wet Well #2 Level Low	DI	--	RTU-1	--	--	--	FALSE	--
LSL-100C	Main Lift Station Wet Well #3 Level	Main Lift Pump Station Wet Well #3	Wet Well #3 Level Low	DI	--	RTU-1	--	--	--	FALSE	--
YI-101A	Main Lift Station Sewage Pump #1	Main Lift Pump Station	Pump #1 HOA in Auto	DI	--	RTU-1	--	--	--	FALSE	--
YI-101B	Main Lift Station Sewage Pump #1	Main Lift Pump Station	Pump #1 Run Status	DI	--	RTU-1	--	--	--	FALSE	--
YI-101C	Main Lift Station Sewage Pump #1	Main Lift Pump Station	Pump #1 in Bypass	DI	--	RTU-1	--	--	--	FALSE	--
MSH-101A	Main Lift Station Sewage Pump #1	Main Lift Pump Station	Pump #1 Seal Chamber Leak	DI	--	RTU-1	--	--	--	TRUE	--
MSH-101B	Main Lift Station Sewage Pump #1	Main Lift Pump Station	Pump #1 Motor Chamber Leak	DI	--	RTU-1	--	--	--	TRUE	--
MSH-101C	Main Lift Station Sewage Pump #1	Main Lift Pump Station	Pump #1 Elec. Chamber Leak	DI	--	RTU-1	--	--	--	TRUE	--

IO AND ALARM LIST

IO Tag No	Service	Location	IO Description	IO Type	IO Signal Range	CP Termination	LRL	URL	Units	Alarm List	Remarks
TAH-101	Main Lift Station Sewage Pump #1	Main Lift Pump Station	Pump #1 High Motor Temperature	DI	--	RTU-1	--	--	--	TRUE	--
YA-101A	Main Lift Station Sewage Pump #1	Main Lift Pump Station	Pump #1 VFD Alarm	DI	--	RTU-1	--	--	--	TRUE	--
YA-101B	Main Lift Station Sewage Pump #1	Main Lift Pump Station	Pump #1 Soft Starter Alarm	DI	--	RTU-1	--	--	--	TRUE	--
OS-101	Main Lift Station Sewage Pump #1	Main Lift Pump Station	Pump #1 Emergency Stop	DI	--	RTU-1	--	--	--	TRUE	--
ZSA-101	Main Lift Station Sewage Pump #1	Main Lift Pump Station	Pump #1 Check Valve Failure	DI	--	RTU-1	--	--	--	TRUE	--
SI-101	Main Lift Station Sewage Pump #1	Main Lift Pump Station	FBPS Pump #1 VFD Speed	AI	4-20 mA DC	RTU-1	0	100	%	FALSE	--
YS-101	Main Lift Station Sewage Pump #1	Main Lift Pump Station	Pump #1 Start/Stop	DO	--	RTU-1	--	--	--	FALSE	--
SC-101	Main Lift Station Sewage Pump #1	Main Lift Pump Station	Pump #1 VFD Speed Command	AO	4-20 mA DC	RTU-1	30	100	%	FALSE	--
YI-102A	Main Lift Station Sewage Pump #2	Main Lift Pump Station	Pump #2 HOA in Auto	DI	--	RTU-1	--	--	--	FALSE	--
YI-102B	Main Lift Station Sewage Pump #2	Main Lift Pump Station	Pump #2 Run Status	DI	--	RTU-1	--	--	--	FALSE	--
YI-102C	Main Lift Station Sewage Pump #2	Main Lift Pump Station	Pump #2 in Bypass	DI	--	RTU-1	--	--	--	FALSE	--
MSH-102A	Main Lift Station Sewage Pump #2	Main Lift Pump Station	Pump #2 Seal Chamber Leak	DI	--	RTU-1	--	--	--	TRUE	--
MSH-102B	Main Lift Station Sewage Pump #2	Main Lift Pump Station	Pump #2 Motor Chamber Leak	DI	--	RTU-1	--	--	--	TRUE	--
MSH-102C	Main Lift Station Sewage Pump #2	Main Lift Pump Station	Pump #2 Elec. Chamber Leak	DI	--	RTU-1	--	--	--	TRUE	--
TAH-102	Main Lift Station Sewage Pump #2	Main Lift Pump Station	Pump #2 High Motor Temperature	DI	--	RTU-1	--	--	--	TRUE	--
YA-102A	Main Lift Station Sewage Pump #2	Main Lift Pump Station	Pump #2 VFD Alarm	DI	--	RTU-1	--	--	--	TRUE	--
YA-102B	Main Lift Station Sewage Pump #2	Main Lift Pump Station	Pump #2 Soft Starter Alarm	DI	--	RTU-1	--	--	--	TRUE	--

IO AND ALARM LIST

IO Tag No	Service	Location	IO Description	IO Type	IO Signal Range	CP Termination	LRL	URL	Units	Alarm List	Remarks
OS-102	Main Lift Station Sewage Pump #2	Main Lift Pump Station	Pump #2 Emergency Stop	DI	--	RTU-1	--	--	--	TRUE	--
ZSA-102	Main Lift Station Sewage Pump #2	Main Lift Pump Station	Pump #2 Check Valve Failure	DI	--	RTU-1	--	--	--	TRUE	--
SI-102	Main Lift Station Sewage Pump #2	Main Lift Pump Station	Pump #2 VFD Speed	AI	4-20 mA DC	RTU-1	0	100	%	FALSE	--
YS-102	Main Lift Station Sewage Pump #2	Main Lift Pump Station	Pump #2 Start/Stop	DO	--	RTU-1	--	--	--	FALSE	--
SC-102	Main Lift Station Sewage Pump #2	Main Lift Pump Station	Pump #2 VFD Speed Command	AO	4-20 mA DC	RTU-1	30	100	%	FALSE	--
YI-103A	Main Lift Station Sewage Pump #3	Main Lift Pump Station	Pump #3 HOA in Auto	DI	--	RTU-1	--	--	--	FALSE	--
YI-103B	Main Lift Station Sewage Pump #3	Main Lift Pump Station	Pump #3 Run Status	DI	--	RTU-1	--	--	--	FALSE	--
YI-103C	Main Lift Station Sewage Pump #3	Main Lift Pump Station	Pump #3 in Bypass	DI	--	RTU-1	--	--	--	FALSE	--
MSH-103A	Main Lift Station Sewage Pump #3	Main Lift Pump Station	Pump #3 Seal Chamber Leak	DI	--	RTU-1	--	--	--	TRUE	--
MSH-103B	Main Lift Station Sewage Pump #3	Main Lift Pump Station	Pump #3 Motor Chamber Leak	DI	--	RTU-1	--	--	--	TRUE	--
MSH-103C	Main Lift Station Sewage Pump #3	Main Lift Pump Station	Pump #3 Elec. Chamber Leak	DI	--	RTU-1	--	--	--	TRUE	--
TAH-103	Main Lift Station Sewage Pump #3	Main Lift Pump Station	Pump #3 High Motor Temperature	DI	--	RTU-1	--	--	--	TRUE	--
YA-103A	Main Lift Station Sewage Pump #3	Main Lift Pump Station	Pump #3 VFD Alarm	DI	--	RTU-1	--	--	--	TRUE	--
YA-103B	Main Lift Station Sewage Pump #3	Main Lift Pump Station	Pump #3 Soft Starter Alarm	DI	--	RTU-1	--	--	--	TRUE	--
OS-103	Main Lift Station Sewage Pump #3	Main Lift Pump Station	Pump #3 Emergency Stop	DI	--	RTU-1	--	--	--	TRUE	--
ZSA-103	Main Lift Station Sewage Pump #3	Main Lift Pump Station	Pump #3 Check Valve Failure	DI	--	RTU-1	--	--	--	TRUE	--
SI-103	Main Lift Station Sewage Pump #3	Main Lift Pump Station	Pump #3 VFD Speed	AI	4-20 mA DC	RTU-1	0	100	%	FALSE	--

IO AND ALARM LIST

IO Tag No	Service	Location	IO Description	IO Type	IO Signal Range	CP Termination	LRL	URL	Units	Alarm List	Remarks
YS-103	Main Lift Station Sewage Pump #3	Main Lift Pump Station	Pump #3 Start/Stop	DO	--	RTU-1	--	--	--	FALSE	--
SC-103	Main Lift Station Sewage Pump #3	Main Lift Pump Station	Pump #3 VFD Speed Command	AO	4-20 mA DC	RTU-1	30	100	%	FALSE	--
YI-104A	Main Lift Station Sewage Pump #4	Main Lift Pump Station	Pump #4 HOA in Auto	DI	--	RTU-1	--	--	--	FALSE	--
YI-104B	Main Lift Station Sewage Pump #4	Main Lift Pump Station	Pump #4 Run Status	DI	--	RTU-1	--	--	--	FALSE	--
YI-104C	Main Lift Station Sewage Pump #4	Main Lift Pump Station	Pump #4 in Bypass	DI	--	RTU-1	--	--	--	FALSE	--
MSH-104A	Main Lift Station Sewage Pump #4	Main Lift Pump Station	Pump #4 Seal Chamber Leak	DI	--	RTU-1	--	--	--	TRUE	--
MSH-104B	Main Lift Station Sewage Pump #4	Main Lift Pump Station	Pump #4 Motor Chamber Leak	DI	--	RTU-1	--	--	--	TRUE	--
MSH-104C	Main Lift Station Sewage Pump #4	Main Lift Pump Station	Pump #4 Elec. Chamber Leak	DI	--	RTU-1	--	--	--	TRUE	--
TAH-104	Main Lift Station Sewage Pump #4	Main Lift Pump Station	Pump #4 High Motor Temperature	DI	--	RTU-1	--	--	--	TRUE	--
YA-104A	Main Lift Station Sewage Pump #4	Main Lift Pump Station	Pump #4 VFD Alarm	DI	--	RTU-1	--	--	--	TRUE	--
YA-104B	Main Lift Station Sewage Pump #4	Main Lift Pump Station	Pump #4 Soft Starter Alarm	DI	--	RTU-1	--	--	--	TRUE	--
OS-104	Main Lift Station Sewage Pump #4	Main Lift Pump Station	Pump #4 Emergency Stop	DI	--	RTU-1	--	--	--	TRUE	--
ZSA-104	Main Lift Station Sewage Pump #4	Main Lift Pump Station	Pump #4 Check Valve Failure	DI	--	RTU-1	--	--	--	TRUE	--
SI-104	Main Lift Station Sewage Pump #4	Main Lift Pump Station	Pump #4 VFD Speed	AI	4-20 mA DC	RTU-1	0	100	%	FALSE	--
YS-104	Main Lift Station Sewage Pump #4	Main Lift Pump Station	Pump #4 Start/Stop	DO	--	RTU-1	--	--	--	FALSE	--
SC-104	Main Lift Station Sewage Pump #4	Main Lift Pump Station	Pump #4 VFD Speed Command	AO	4-20 mA DC	RTU-1	30	100	%	FALSE	--
YI-105A	Main Lift Station Sewage Pump #5	Main Lift Pump Station	Pump #5 HOA in Auto	DI	--	RTU-1	--	--	--	FALSE	--

IO AND ALARM LIST

IO Tag No	Service	Location	IO Description	IO Type	IO Signal Range	CP Termination	LRL	URL	Units	Alarm List	Remarks
YI-105B	Main Lift Station Sewage Pump #5	Main Lift Pump Station	Pump #5 Run Status	DI	--	RTU-1	--	--	--	FALSE	--
YI-105C	Main Lift Station Sewage Pump #5	Main Lift Pump Station	Pump #5 in Bypass	DI	--	RTU-1	--	--	--	FALSE	--
MSH-105A	Main Lift Station Sewage Pump #5	Main Lift Pump Station	Pump #5 Seal Chamber Leak	DI	--	RTU-1	--	--	--	TRUE	--
MSH-105B	Main Lift Station Sewage Pump #5	Main Lift Pump Station	Pump #5 Motor Chamber Leak	DI	--	RTU-1	--	--	--	TRUE	--
MSH-105C	Main Lift Station Sewage Pump #5	Main Lift Pump Station	Pump #5 Elec. Chamber Leak	DI	--	RTU-1	--	--	--	TRUE	--
TAH-105	Main Lift Station Sewage Pump #5	Main Lift Pump Station	Pump #5 High Motor Temperature	DI	--	RTU-1	--	--	--	TRUE	--
YA-105A	Main Lift Station Sewage Pump #5	Main Lift Pump Station	Pump #5 VFD Alarm	DI	--	RTU-1	--	--	--	TRUE	--
YA-105B	Main Lift Station Sewage Pump #5	Main Lift Pump Station	Pump #5 Soft Starter Alarm	DI	--	RTU-1	--	--	--	TRUE	--
OS-105	Main Lift Station Sewage Pump #5	Main Lift Pump Station	Pump #5 Emergency Stop	DI	--	RTU-1	--	--	--	TRUE	--
ZSA-105	Main Lift Station Sewage Pump #5	Main Lift Pump Station	Pump #5 Check Valve Failure	DI	--	RTU-1	--	--	--	TRUE	--
SI-105	Main Lift Station Sewage Pump #5	Main Lift Pump Station	Pump #5 VFD Speed	AI	4-20 mA DC	RTU-1	0	100	%	FALSE	--
YS-105	Main Lift Station Sewage Pump #5	Main Lift Pump Station	Pump #5 Start/Stop	DO	--	RTU-1	--	--	--	FALSE	--
SC-105	Main Lift Station Sewage Pump #5	Main Lift Pump Station	Pump #5 VFD Speed Command	AO	4-20 mA DC	RTU-1	30	100	%	FALSE	--
FIT-106	Main Lift Pump Station Force Main A Effluent Flow	Main Lift Pump Station Force Main A Line	Force Main A Effluent Flow Rate	AI	4-20 mA DC	RTU-1	0	xx	GPM	TRUE	FAHH, FAH, FAL, FALL
FIT-107	Main Lift Pump Station Force Main B Effluent Flow	Main Lift Pump Station Force Main B Line	Force Main B Effluent Flow Rate	AI	4-20 mA DC	RTU-1	0	xx	GPM	TRUE	FAHH, FAH, FAL, FALL
ZSO-111	Main Lift Station Wet Well #1 Influent Sluice Gate	Main Lift Station Wet Well #1 Influent Line	Wet Well #1 Influent Sluice Gate Opened	DI	--	RTU-1	--	--	--	FALSE	--

IO AND ALARM LIST

IO Tag No	Service	Location	IO Description	IO Type	IO Signal Range	CP Termination	LRL	URL	Units	Alarm List	Remarks
ZSC-111	Main Lift Station Wet Well #1 Influent Sluice Gate	Main Lift Station Wet Well #1 Influent Line	Wet Well #1 Influent Sluice Gate Closed	DI	--	RTU-1	--	--	--	FALSE	--
ZSO-112	Main Lift Station Wet Well #3 Influent Sluice Gate	Main Lift Station Wet Well #3 Influent Line	Wet Well #3 Influent Sluice Gate Opened	DI	--	RTU-1	--	--	--	FALSE	--
ZSC-112	Main Lift Station Wet Well #3 Influent Sluice Gate	Main Lift Station Wet Well #3 Influent Line	Wet Well #3 Influent Sluice Gate Closed	DI	--	RTU-1	--	--	--	FALSE	--
ZSO-113	Main Lift Station Wet Well #2 Influent From Wet Well #1 Sluice Gate	Wet Well #2 Influent From Wet Well #1	Wet Well #2 Influent From Wet Well #1 Sluice Gate Opened	DI	--	RTU-1	--	--	--	FALSE	--
ZSC-113	Main Lift Station Wet Well #2 Influent From Wet Well #1 Sluice Gate	Wet Well #2 Influent From Wet Well #1	Wet Well #2 Influent From Wet Well #1 Sluice Gate Closed	DI	--	RTU-1	--	--	--	FALSE	--
ZSO-114	Main Lift Station Wet Well #2 Influent From Wet Well #3 Sluice Gate	Wet Well #2 Influent From Wet Well #3	Wet Well #2 Influent From Wet Well #3 Sluice Gate Opened	DI	--	RTU-1	--	--	--	FALSE	--
ZSC-114	Main Lift Station Wet Well #2 Influent From Wet Well #3 Sluice Gate	Wet Well #2 Influent From Wet Well #3	Wet Well #2 Influent From Wet Well #3 Sluice Gate Closed	DI	--	RTU-1	--	--	--	FALSE	--
ZSO-115	Main Lift Station Influent Diversion To Wet Weather Pump Station Sluice Gate	Main Lift Station Influent Diversion Line To Wet Weather Pump Station	Station Influent Diversion To Wet Weather Pump Station Sluice Gate Opened	DI	--	RTU-1	--	--	--	FALSE	--

IO AND ALARM LIST

IO Tag No	Service	Location	IO Description	IO Type	IO Signal Range	CP Termination	LRL	URL	Units	Alarm List	Remarks
ZSC-115	Main Lift Station Influent Diversion To Wet Weather Pump Station Sluice Gate	Main Lift Station Influent Diversion Line To Wet Weather Pump Station	Station Influent Diversion To Wet Weather Pump Station Sluice Gate Closed	DI	--	RTU-1	--	--	--	FALSE	--
YO-115	Main Lift Station Influent Diversion To Wet Weather Pump Station Sluice Gate	Main Lift Station Influent Diversion Line To Wet Weather Pump Station	Station Influent Diversion To Wet Weather Pump Station Sluice Gate Open	DO	--	RTU-1	--	--	--	FALSE	--
YC-115	Main Lift Station Influent Diversion To Wet Weather Pump Station Sluice Gate	Main Lift Station Influent Diversion Line To Wet Weather Pump Station	Station Influent Diversion To Wet Weather Pump Station Sluice Gate Close	DO	--	RTU-1	--	--	--	FALSE	--
YA-120A	Main Lift Station Generator	Main Lift Pump Station	Generator Failure	DI		RTU-1	--	--	--	TRUE	--
YA-120B	Main Lift Station Generator	Main Lift Pump Station	Generator Alarm	DI		RTU-1	--	--	--	TRUE	--
YA-120C	Main Lift Station Generator	Main Lift Pump Station	Generator Low Fuel Level	DI		RTU-1	--	--	--	TRUE	--
YA-120D	Main Lift Station Generator	Main Lift Pump Station	Generator Fuel Tank Leak	DI		RTU-1	--	--	--	TRUE	--
YI-120A	Main Lift Station Generator	Main Lift Pump Station	Generator On	DI		RTU-1	--	--	--	FALSE	--
YI-120B	Main Lift Station Generator	Main Lift Pump Station	Generator Not in Auto	DI		RTU-1	--	--	--	FALSE	--
YI-121A	Main Lift Station Transfer Switch	Main Lift Pump Station	Normal Position	DI		RTU-1	--	--	--	FALSE	--
YI-121B	Main Lift Station Transfer Switch	Main Lift Pump Station	Emergency Position	DI		RTU-1	--	--	--	FALSE	--
JAL-130	Main Lift Station SCADA RTU	Main Lift Pump Station SCADA RTU	120VAC Power Failure	DI	--	RTU-1	--	--	--	TRUE	--

IO AND ALARM LIST

IO Tag No	Service	Location	IO Description	IO Type	IO Signal Range	CP Termination	LRL	URL	Units	Alarm List	Remarks
JAL-131	Main Lift Station SCADA RTU	Main Lift Pump Station SCADA RTU	Power Supply Failure	DI	--	RTU-1	--	--	--	TRUE	Power Supply Alarms are wired in series.
JAL-132	Main Lift Station SCADA RTU	Main Lift Pump Station SCADA RTU	UPS Failure	DI	--	RTU-1	--	--	--	TRUE	--
YA-140A	Main Lift Pump Station Wet Well	Wet Well Hatch	Wet Well Intrusion	DI		RTU-1	--	--	--	TRUE	--
YA-140B	Main Lift Pump Station Building Intrusion	Main Lift Pump Station Doors	Pump Station Intrusion	DI		RTU-1	--	--	--	TRUE	--
YA-140C	Main Lift Pump Station Generator Intrusion	Main Lift Pump Station Generator	Generator Enclosure Intrusion	DI		RTU-1	--	--	--	TRUE	--
YA-141A	Main Lift Pump Station	Main Lift Pump Station Ground Level	Ground Level Fire	DI		RTU-1	--	--	--	TRUE	--
YA-141B	Main Lift Pump Station	Main Lift Pump Station Mezzanine Level	Mezzanine Level Fire	DI		RTU-1	--	--	--	TRUE	--
YA-141C	Main Lift Pump Station	Main Lift Pump Station Basement	Basement Fire	DI		RTU-1	--	--	--	TRUE	--
LSH-145	Main Lift Station Dry Well Level	Main Lift Pump Station Basement	Dry Well Level High	DI	--	RTU-1	--	--	--	TRUE	--
YI-150A	Main Lift Pump Station ERV-1	Main Lift Pump Station ERV-1	ERV-1 Running	DI		RTU-1	--	--	--	FALSE	--
YA-150A	Main Lift Pump Station ERV-1	Main Lift Pump Station ERV-1	ERV-1 Alarm	DI		RTU-1	--	--	--	TRUE	--
YI-160A	Main Lift Pump Station Air Compressor	Main Lift Pump Station Air Compressor	Air Compressor Running	DI		RTU-1	--	--	--	FALSE	--
YA-160A	Main Lift Pump Station Air Compressor	Main Lift Pump Station Air Compressor	Air Compressor Alarm	DI		RTU-1	--	--	--	TRUE	--

Notes:

- The IO and Alarm List contains a list of the physical IO points. Refer to the Loop Descriptions in this Section for additional IO points. For example, elapsed time meters (KQI-xxx), flow totalizers (FQI-xxx), motor state disagreement alarms (YA-xxx), software-based selector switches, start/stop or reset pushbuttons (HS-xxx), software-based timers (KC-xxx), level set points (LS-xxx), etc.
- The IO point has one or more alarm points when “TRUE” appears in the “Alarm List” column. If no ISA identification letters appear in the “Alarm Remarks” column, then the alarm tag is the same as the tag in the “IO Tag No” column. When multiple sets of ISA identification letters appear in the “Alarm Remarks” column, create an alarm point for each set of ISA identification letters. Refer to the

examples below. IO points with multiple alarm points are typical for *IT or *T ISA identification letters in the “IO Tag No” column, where * = first letter(s) of the set of ISA identification letters. Refer to the “Alarm Remarks” column for the specific alarms.

*AHH = * alarm high high. Initially set at LRL + 90% of span rising, adjustable
*AH = * alarm high. Initially set at LRL + 80% of span rising, adjustable
*AL = * alarm low. Initially set at LRL + 20% of span falling, adjustable
*ALL = * alarm low low. Initially set at LRL + 10% of span falling, adjustable
d*/dt = high rate of change alarm. Initially set at 5% of span/second, adjustable
*DAH = set point deviation alarm. Initially set at 5% of set point, adjustable

- END OF SECTION -

(THIS PAGE INTENTIONALLY LEFT BLANK)

DIVISION 14

(THIS PAGE INTENTIONALLY LEFT BLANK)

SECTION 14600

HOISTING EQUIPMENT

PART 1 GENERAL

1.1 WORK INCLUDED

- A. Furnish, install, test and place in satisfactory operation the hoisting equipment, complete with all supports, fastenings, and other appurtenances, as indicated on the drawings and as herein specified.
- B. The specifications and drawings direct attention to certain required features of the equipment but do not purport to cover all details entering into its design and construction. Nevertheless, the Contractor shall furnish, shop test, deliver, install and field test all materials, equipment and appurtenances for the hoisting equipment complete in all details and ready for operation as specified herein, whether specifically mentioned in these specifications or not.

1.2 RELATED WORK

- A. Division 1 – General Requirements
- B. Division 5 - Metals
- C. Division 9 - Finishes
- D. Division 11 - Equipment
- E. Division 15 – Mechanical
- F. Division 16 – Electrical

1.3 QUALITY ASSURANCE

- A. The hoisting systems shall conform to the location, capacity, critical dimensions and other pertinent data listed in the “Equipment Schedule” included herein.
- B. All structural steel members of the handling system shall be designed in accordance with the specifications of American Institute of Steel Construction, current edition, and any welded construction shall be in accordance with the standards of the American Welding Society.

- 1.4 C. Castings, forgings, stampings, etc., shall have a safety factor of at least 5.
- Submittals
 - A. Product Data: For each type of product indicated.
 - B. Maintenance Data: For each product to include in maintenance manuals.
 - C. Warranties: Special warranties specified in this Section.

PART 2 PRODUCTS

2.1 GENERAL

- A. All hoisting equipment shall conform to the current standards set forth by the following:
 - 1. Hoist Manufacturers Institute - HMI 100, HMI 200 and HMI 400.
 - 2. American National Standard Institute ANSI B30.11, ANSI B30.16 and ANSI C1.
 - 3. American Institute of Steel Construction
 - 4. American Welding Society
 - 5. Crane Manufacturers Association of American Inc., (C.M.A.A.)
- B. All hoisting equipment parts shall be proportioned so that all stresses and vertical or lateral deflections will be within conservative limits with minimum vibration. Rated load safety factors of at least five, based upon ultimate strength of the materials used, shall be employed.
- C. The Contractor shall verify all dimensions and clearances in the field prior to erection of the hoisting equipment and shall be responsible for the proper fitting and operation of the equipment.
- D. The capacity of each hoist and trolley shall be permanently marked in a conspicuous manner.
- E. Safety Devices: Comply with applicable safety codes, as directed by local authority having jurisdiction, and as follows.
 - 1. Equip with end stops to limit movement of trolley.
 - 2. All hooks shall be safety type.
- F. Align structural beam with the monorail; determine hanger locations according to loading requirements.

2.2 ACCEPTABLE MANUFACTURERS

- A. Motor Operated Hoist: Hoisting equipment shall be manufactured by Shepard-Niles, Inc., Montour Falls, NY; Yale Hoisting Equipment Division, Forest City, AR; Harnischfeger Corp., Milwaukee, WI, Harrington, or be an acceptable equivalent product.
- B. Cable Reels: Cable reels shall be manufactured by Gleason Reel, Aero-Motive Manufacturing Company, Woodhead or be an acceptable equivalent product.
- C. Portable Davit Crane and Retrieval Winch: The davit crane shall be the Adjustable Offset Davit Mast and Retrieval Winch, as manufactured by DBI SALA, MSA Xtirpa, or approved equal.

2.3 EQUIPMENT

- A. Portable Davit Crane and Retrieval Winch
 - 1. Capacity of winch operated davit crane shall be as listed below and shall have the following properties:
 - i. Provide one (1) Digital Winch with removable handle.
 - ii. Provide one (1) 3-Way Self-Retracting Lifeline.
 - 2. Fasteners
 - i. a. Studs, nuts, washers, and fasteners shall be Type 304 stainless steel and shall be furnished with the hoisting equipment.
 - 3. Cable
 - i. Cable shall be 90 feet of Galvanized steel wire rope.
 - 4. Crane
 - i. The davit mast shall be adjustable from 23.5” to 42.5”.
 - ii. Three (3) Floor Mount Sleeve Bases
 - iii. Three base covers.
- B. Motor Operated Hoist
 - 1. System shall be equipped with a four button, push button operator with ballast resistors to cushion the start. Push Button Station shall be NEMA 4X.
 - 2. Hooks shall be of high grade, forged steel, and shall have swivel, antifriction bearings.
 - 3. Power cord length specified is based on required travel distance. Additional cord shall be provided based on manufacturer’s requirements.

C. EQUIPMENT SCHEDULE

Hoist Location	Basement Level	Ground Level	Wet Well Davit
Number Required	1	1	1
Rate Use	Indoor	Indoor/Outdoor	Outdoor
Clearance Req.	Low Headroom	Low Headroom	--
Suspension Type	Hook	Hook	Hook
Capacity	3 Ton	3 Ton	450 pounds
Lifting Speed	20 ft/min variable	20 ft/min variable	--
Hoist Type	Motorized Wire Rope	Motorized Wire Rope	Davit Crane
Distance from Hook to Operating Floor	15 feet	48 feet	90 feet
Trolley	Motorized	Motorized	--
Travel Distances	50 feet	70 feet	--
Power	460V, 3-phase, 60 Hz	460V, 3-phase, 60 Hz	--
Hoist HP	5	5	--
Trolley HP	0.5	0.5	--

A. Pushbutton Control

1. The control provided shall have sufficient buttons to control all functions of the hoist and trolley operations.
2. Each button shall be clearly marked with its function.
3. The control cable shall be long enough to reach within 4-feet of the operating level. Provide support arm if required so controls will be kept readily available to the operator.

B. Safety Stops

1. Safety stops shall be provided for both ends of the trolley tracks. The stops shall be capable of safely stopping the trolley and hoist when in motion under full load.

C. Fasteners

1. Studs, nuts, washers, and fasteners shall be Type 304 stainless steel and shall be furnished with the hoisting equipment.

D. Cable Reels:

1. Power cable for the electric hoist and trolley shall be a self-winding spring operated reel installed at the approximate midpoint of travel. The reel shall have a fixed base and roller outlet

2.4 PAINTING

- A. **Primer and Finished Paint:** All steelwork and machinery except bearing surfaces, shafts, chain, cable, and stainless steel shall be painted. Surfaces

to be painted shall be thoroughly dry and free from rust, grease or dirt. Primer and high solids epoxy shall be shop applied.

- B. Ferrous surfaces obviously not to be painted shall be given a shop coat of grease or other suitable rust-resistant coating.
- C. Field painting as specified in Section 09900 - Painting.

PART 3 EXECUTION

3.1 INSTALLATION

- A. All equipment shall be installed in accordance with the manufacturer's written instructions, as approved, and all equipment and materials required for proper installation shall be provided.
- B. It shall be the responsibility of the Contractor to coordinate the work included under this section of the specifications with other related work specified herein to insure that all the equipment shall operate to perform the designated functions in a proper and acceptable manner.
- C. Anchor bolts, expansion bolts, studs, nuts, washers and fasteners shall be set as per manufacturer's recommendations.

3.2 ADJUSTING

- A. Adjust hoists to operate smoothly under all load conditions, without malfunction.

3.3 FIELD ACCEPTANCE TESTS

- A. Test hoists, at the rated load, in the presence of the Engineer.

3.4 TOOLS AND LUBRICANTS

- A. Furnish a complete set of any special tools required for the maintenance and operation of this equipment, as designated by the equipment manufacturer.
- B. A one-year supply of each type of lubricant required for each piece of equipment and one grease gun for each type lubricant required shall be furnished under this Section.

END OF SECTION

DIVISION 15

(THIS PAGE INTENTIONALLY LEFT BLANK)

SECTION 15050

PIPE PENETRATIONS

PART 1 GENERAL

1.01 SECTION INCLUDES

- A. Requirements for furnishing and installing pipe penetration assemblies. This Section covers materials for various pipe penetration configurations. Refer to the Contract Drawings for details of assembly and for location.

1.02 REFERENCES

- A. American Society for Testing and Materials (ASTM)
 - 1. ASTM A53, Standard Specification for Pipe, Steel, Black, and Hot-Dipped, Zinc-Coated, Welded and Seamless.
- B. American National Std. Institute (ANSI)/American Water Works Assoc. (AWWA)
 - 1. ANSI/AWWA C151/A21.51, Ductile Iron Pipe, Centrifugally Cast in Metal Molds or Sand Lined Molds for Water or Other Liquids

1.03 SUBMITTALS

- A. Submit to in accordance with SECTION 01300, manufacturers' literature on all items to be furnished, installation instructions, and where applicable, fire rating and certified test results of the various components.

PART 2 PRODUCTS

2.01 PIPE SLEEVES

- A. Unless otherwise shown all pipe sleeves shall be Schedule 40 galvanized steel pipe conforming to ASTM A53. Provide a 2-in minimum circumferential water stop welded to exterior of sleeve at its midpoint. Ends of sleeves shall be cut, ground smooth, and shall be flush with the wall or ceiling and extend 2-in above finished floors. Sleeves required to be sealed by caulking shall be sized as required. Sleeves required to be sealed with mechanical seals shall be sized in accordance with the seal manufacturer's recommendations, and shall be a single seal for wall thicknesses up to and including 12-in; two mechanical seals shall be provided for wall thicknesses greater than 12-in. Sleeves for insulated piping shall be sized to accommodate the approved insulation.

2.02 WALL CASTINGS

- A. Unless otherwise shown, wall castings shall be ductile iron conforming to ANSI/AWWA C151/A21.51, thickness Class 53, diameter as required. Flanges and/or mechanical joint bells shall be drilled and tapped for studs where flush with the wall. Castings shall be

provided with an intermediate ½-in thick by 2-in minimum circumferential flange/waterstop, integrally cast with or welded to the casting, located such that it falls within the middle third of the wall.

2.03 SEALING MATERIALS

- A. Mechanical seals shall be modular, adjustable, bolted, mechanical type consisting of interlocking synthetic rubber links shaped to continuously fill the annular space between the pipe and sleeve. The seal shall be rated by the manufacturer for 40 feet of head or 20 psig. Mechanical seals shall be Link-Seal, manufactured by Thunderline Corp., Wayne, MI., or equal.
- B. Caulking for iron, steel and copper piping shall consist of braided oakum packing followed by poured molten soft virgin lead. Minimum length of lead segment shall be one half of pipe diameter, or six inches, whichever is less. Lead shall be flush with end of sleeve. Cooled lead shall be expanded with a caulking iron to form a water seal.
- C. Sealant shall be a two part foamed silicone elastomer as manufactured by Dow Corning Co., product No. 3-6548 silicone R.T.V.; 3M brand fire barrier products caulk C.P. 25 and 3M brand putty 303; or Flame-Safe fire stop systems Fig. No. FS-500 by Thomas & Betts Corporation. Packing shall be a fire retardant pliable material, Fig. 310 by Sealtite Co., White Oakum W.S.-600 by American Manufacturing Co., or equal. Sealant bead configuration, depth and width shall be in accordance with manufacturer's recommendations.

2.04 MISCELLANEOUS MATERIALS

- A. Bonding compound shall be Sikadur Hi-Mod epoxy by Sika Corporation, equal by Euclid Chemical Corporation; Master Buildings Company or equal.
- B. Non-shrink grout shall be Masterflow 713 by Master Builders Company, Euco N-S by Euclid Chemical Co.; Five Star Grout by U.S. Grout Corp. or equal.
- C. Galvanized escutcheon plates shall be provided for all exterior sleeved wall penetrations above finished grade.

PART 3 EXECUTION

3.01 INSTALLATION

- A. Assemble and install components of pipe penetration assemblies as detailed in the Contract Documents.

END OF SECTION

SECTION 15060

PROCESS PIPING

PART 1 GENERAL

1.01 SUMMARY

A. Section Includes

1. Requirements to furnish, install, joint and test miscellaneous pipe, fittings, and appurtenances, (including special castings), indicated on the Drawings and specified in this Section.

B. Related Sections

1. Section 02200 - Earth Excavation, Backfill, Fill and Grading
2. Section 02622 - Polyvinyl Chloride Gravity Sewer Pipe
3. Section 09900 - Painting
4. Section 15050 - Pipe Penetrations
5. Section 15140 - Hangers and Supports
6. Section 15260 – Exterior Piping Insulation

1.02 REFERENCES

A. American Society for Testing and Materials (ASTM)

1. A47, Specification for Ferric Malleable Iron Castings.
2. A53, Specification for Pipe, Steel, Black, and Hot-Dipped, Zinc-Coated, Welded and Seamless.
3. A182, Specification for Forged or Rolled Alloy Steel Pipe Flanges, Forged Fittings, and Valves and Parts for High Temperature Service.
4. A183, Specification for Carbon Steel Track Bolts and Nuts.
5. A193, Specification for Alloy Steel and Stainless Steel Bolting Materials for High Temperature Service.
6. A194, Specification for Carbon and Alloy Steel Nuts for Bolts for High Pressure or High Temperature Service.
7. A307, Specification for Carbon Steel Bolts and Studs, 60,000 PSI Tensile Strength.
8. A312, Specification for Seamless and Welded Austenitic Stainless Steel Pipes.
9. A320, Specification for Alloy/Steel Bolting Materials for Low Temperature Service.
10. A403, Specification for Wrought Austenitic Stainless Steel Piping Fittings.
11. A536, Specification for Ductile Iron Castings.
12. A563, Specification for Carbon and Alloy Steel Nuts.
13. B88, Specification for Seamless Copper Water Tube.
14. B135, Specification for Seamless Brass Tube.
15. C552, Specification for Cellular Glass Thermal Insulation.
16. D1785, Specification for Poly (Vinyl Chloride) (PVC) Plastic Pipe, Schedules 40, 80, and 120.
17. D2513, Specification for Thermoplastic Gas Pressure Pipe, Tubing, and Fittings.
18. D2992, Practice for Obtaining Hydrostatic or Pressure Design Basis for “Fiberglass” (Glass-Fiber-Reinforced Thermosetting-Resin) Pipe and Fittings.
19. D2996, Specification for Filament-Wound “Fiberglass” (Glass-Fiber-Reinforced Thermosetting-Resin) Pipe.

- B. American Water Works Association (AWWA)
 - 1. C606, Standard for Grooved and Shouldered Joints.
 - 2. C651, Standard for Disinfecting Water Mains.
- C. American National Standards Institute (ANSI)
 - 1. A21.4, Standard for Cement-Mortar Lining for Ductile-Iron and Gray-Iron Pipe and Fittings for Water.
 - 2. A21.10, Standard for Gray-Iron and Ductile-Iron Fittings, 3-inch. through 48-inch., for Water and Other Liquids.
 - 3. A21.11, Standard for Rubber-Gasket Joints for Ductile-Iron and Gray-Iron Pressure Pipe and Fittings.
 - 4. A21.15, Standard for Flanged Cast-Iron and Ductile-Iron Pipe with Threaded Flanges
 - 5. A21.50, Standard for Thickness Design of Ductile-Iron Pipe.
 - 6. A21.51, Standard for Ductile-Iron Pipe, Centrifugally Cast in Metal Molds, or Sand-Lined Molds, for Water or Other Liquids.
 - 7. A21.53, Ductile Iron Compact Fittings for Water and Other Liquids.
 - 8. B16.1, Standard for Ductile Iron Pipe Flanges and Flanged Fittings.
 - 9. B 16.3, Malleable Iron Threaded Fittings, Class 150 and 300.
 - 10. B16.5, Pipe Flanges and Flanged Fittings, Steel Nickel Alloy and Other Special Alloys.
 - 11. B 16.9, Factory-Made Wrought Steel Butt Weld Fittings.

1.03 SUBMITTALS

- A. In accordance with SECTION 01300 submit the following:
- B. Shop Drawings
 - 1. Piping layouts in full detail.
 - 2. Location of pipe hangers and supports.
 - 3. Location and type of backup block or device to prevent separation.
 - 4. Large scale details of all wall penetrations and special castings.
 - 5. Schedules showing the material and thickness or class of all pipe, fittings, special castings, couplings, expansion joints, and other appurtenances.
 - 6. Details of pipe lining, coating, wrapping, insulation and painting of all pipe lines.
 - 7. Points of location of piping identification signs.
 - 8. Other piping appurtenances and data pertinent to the layout of pipe lines whether specifically mentioned in the Specifications or shown on the Drawings.
- C. Certificates
 - 1. Sworn certificates in duplicate of shop tests showing compliance with appropriate standard.
 - 2. Design Computations shall be included in the submittal, for the purpose of record only, and certified by piping manufacturer.
- D. Submit manufacturer's certificates of conformance.
- E. Submit certified copies of test reports.

1.04 QUALITY ASSURANCE

- A. Ductile Iron Pipe

1. Inspect and test at foundry according to ANSI Standards.
2. Owner reserves right to inspect and/or test by independent service at manufacturer's plant or elsewhere at his own expense.
3. Owner reserves right to perform visual inspection and hammer test before installation.

PART 2 PRODUCTS

2.01 PIPE SCHEDULE

A. General

1. Unless otherwise called for by the Contract Drawings or elsewhere in these specifications, the following is a guide as to types of materials and jointing required for piping under this contract.
2. The lack of mention of any specific pipe shall not relieve the Contractor from the responsibility of furnishing and installing all piping required for completion of the Work.
3. Piping listed is exposed unless stated otherwise.

B. Potable Water

1. Three inches and smaller
 - a. Type L (medium wall) hard temper copper with soldered fittings. Red brass pipe required around equipment, and in other locations where vibration may occur.
 - b. Buried service - Type K, soft temper.
2. Greater than three inches
 - a. Ductile-Iron pipe and fittings, flanged joint, cement lined.
 - b. Buried service – use restrained mechanical joint.

C. Process Wastewater, Vent,

1. Three inches and smaller – na.
2. Greater than three inches
 - a. Ductile-Iron pipe and fittings, flanged joint, cement lined.
 - b. Buried service – use restrained mechanical joint.

D. Compressed Air

1. All compressed air piping - (except as noted below) copper Type K heavy wall, hard temper with soldered fittings.

E. Wet Well Mixing (Compressed Air)

1. Stainless Steel,
 - a. 2 inches and smaller, Schedule 40S, Butt welded, Socket weld or flanged as indicated.

F. Sump Pump Piping

1. Schedule 80 PVC. All fittings shall be of the same material and classification and shall be of the solvent-socket weld type unless noted otherwise on the Contract Drawings.
2. Tubing as recommended by the pump manufacturer, as detailed on the Contract Drawings or as specified.

G. Gravity Sewers

1. In accordance with SECTION 02622.

2.02 DUCTILE-IRON PIPE AND FITTINGS

- A. In accordance with Specification Section 15070.

2.03 EXTERIOR DUCTILE IRON PIPE FOR BURIED SERVICE

- A. In accordance with Specification Section 02618

2.04 COPPER PIPE AND FITTINGS

A. Pipe

- 1. In accordance with ASTM B 88.

B. Fittings

- 1. Cast bronze or wrought copper and bronze solder-joint pressure fittings.
- 2. Manufactured by Mueller Company, NIBCO, Inc.; or equal.

C. Unions

- 1. Solder type, with brass-to-brass seats. Gasketed unions are not acceptable.

D. Solder

- 1. Silver solder shall be used for making all buried joints.
- 2. For air piping, solder shall be 95 percent tin and 5 percent antimony.

E. Insulating Union, where copper piping is connected to steel pipe.

- 1. Manufactured by EPCO Sales, Incorporated, or Capital Manufacturing Co., or equal.

F. Tapped Cap, where copper pipe is connected to ductile iron pipe, furnish and install a tapped cap, Flow F-1402, or ACIPCO Type A-338 or equal, and a brass corporation stop, Type H15025 by Mueller Co., or equal.

G. Where more rigidity is required in erecting and supporting copper pipe, the Contractor may, at his option or when so directed by the Engineer, substitute brass pipe.

2.05 BRASS PIPE AND FITTINGS

- A. Pipe in accordance with ASTM B 135, drawn temper. Fittings shall be brass.

2.06 STEEL PIPE AND FITTINGS

A. Pipe

- 1. Black steel and Steel pipe to be in accordance with ASTM A53. Steel pipe shall be Schedule 40 and Schedule 80 as specified and shown in the Contract Drawings.

B. Fittings

- 1. Fittings used on black steel pipe lines two and one-half (2-1/2) inches or less in diameter, unless otherwise specifically called for, shall be standard weight, one hundred fifty (150) pound, beaded, malleable iron.
- 2. Fittings used on black steel pipe lines three (3) inches and larger shall be of the long radius design of standard weights in accordance with ANSI B16.9.

3. Fittings for compressed air shall be 300 lb. black malleable iron screwed fittings.
4. Malleable iron screwed fittings to be in accordance with ANSI B16.3.
5. Hot-dipped galvanized malleable iron fittings shall be used on all galvanized steel pipe lines. Malleable iron grooved end fittings to be in accordance with ASTM A47 and be hot-dipped galvanized.

C. Couplings

1. Couplings, used on black steel pipe lines three (3) inches and larger in diameter, shall be,
 - a. Exposed pipe: Style 38 steel compression couplings as manufactured by Dresser Industries.
 - b. Buried pipe: Type 411 cast compression couplings as manufactured by Smith-Blair, Inc.,
 - c. or equal.

D. Protective Coatings

1. All natural gas, and vent pipes shall be wrapped with a protective coal tar tape or heavily coated with Koppers Bitumastic No. 50 or equal. After testing, all joints shall be wrapped or heavily coated with Bitumastic No. 50 or equal.
2. All ungalvanized (black) steel piping for interior use, that is not covered by insulation, shall be primed and painted as specified under painting schedule of SECTION 09900.

2.07 SEAMLESS CARBON STEEL PIPE AND FITTINGS

A. Pipe and Fittings

1. In accordance with ASTM A53, Grade A.
2. Wall thickness 0.134 inches, minimum.

B. Fittings

1. Malleable Iron, 150 lb. service rating with threaded joints
2. Reducers and Increases to be concentric style.

2.08 STAINLESS STEEL PIPE AND FITTINGS

A. Pipe

1. In accordance with ASTM A312, Type 304 or Type 316 as specified, seamless annealed, pickled and passivated.
2. Type 304L or Type 316L for welded joints.

B. Fittings

1. Threaded Forged, in accordance with ASTM A182, Grade F304 or F316, 3,000 pound WOG.
2. Socket Weld Forger, in accordance with ASTM A182 Grade F304L of F316L, 2,000 pound WOG.
3. Butt Welded in accordance with ASTM A403 Grade WP304L or WP316L conforming to ANSI B16.9, fitting wall thickness to match adjoining pipe.
4. Long radius elbows unless indicated otherwise.

C. Flanges

1. Forged in accordance with ASTM A182 Grade F304L or F316L, Class 150 or 300, slip on welding neck, 1/16 inch raised face conforming to ANSI B16.5.

D. Gaskets

1. 1/16 inch, of material to suit intended use, and appropriate configuration for raised face or flat face flanges.

E. Bolting

1. General conditions, Type 316 in accordance with ASTM A193 Grade B8M hex head bolts and ASTM A194 Grade 8M hex head nuts.
2. Corrosive conditions, Type 304 stainless steel bolts in accordance with ASTM A320 Grade B8 with Copper silicon hex head nuts in accordance with ASTM B98 Grade A.
3. Mating to cast iron, and flat gasket, provide ASTM A307 Grade B hex head bolts and ASTM A563 Grade A heavy hex nuts.

F. Thread Lubricant

1. Teflon tape or Anti seize type.

2.09 STAINLESS STEEL TUBING AND FITTINGS

A. Tubing

1. In accordance with ASTM A312, Type 316 seamless, soft annealed, 0.083 inch, minimum wall thickness.

B. Fittings

1. Flareless Compression Forged in accordance with ASTM A182 Grade F304 or F316.
2. Socket Welded in accordance with ASTM A182 Grade F304L or F316L.

2.10 POLYVINYL CHLORIDE (PVC) PIPE AND FITTINGS

A. Pipe

1. Rigid, unplasticized, and in accordance with ASTM D1785, Type 1, Class 1220.
2. Suitable for field cutting, welding, bending and couplings, and shall be Scheduled 80 unless otherwise shown on the Drawings.
3. Sizes shall be as shown on the Drawings.
4. Bundled or packaged in such a manner as to provide adequate protection for the ends, or plain, during transportation from the manufacturer to the Contractor.

B. Fittings and Appurtenances

1. Fittings to be solvent-socket weld type, or flanged as shown on the Contract Drawings.
2. Union connections and connection to pipe of other material shall be made with pipe flanges and 1/16 inch rubber gaskets.
3. Gaskets shall be resistant for the type of service intended.

2.11 AIR SERVICE HOSE

- A. 3/8-inch inside diameter synthetic rubber hose with inner and outer tubes of oil resistant synthetic rubber with two braids of rayon rated for 300 psi.
- B. Hose end shall have saflowmatic adapter with male thread and a reusable fitting between hose and adapter.
- C. Each air station shall have a pistol grip blow gun made of die cast aluminum with hang up hook and standard brass nozzle.

- D. Provide at each air station a prep-air full size 3/8-inch T-bar lub-air-ator with transparent bowls and bowl guards.
- E. Air station pipe end shall have quick connect couplings saflowmatic with female thread or approved equal.

2.12 ADAPTERS

- A. Where it is necessary to joint pipes of different type, furnish and install the necessary adapters unless solid sleeves are indicated on the drawings or permitted. Adapters shall have ends, conforming to the above specifications for the appropriate type of joint, to receive the adjoining pipe. Adapters joining two classes of pipe may be of the lighter class provided that the annular space in bell-and-spigot type joints will be sufficient for proper jointing.

2.13 FLEXIBLE PIPE COUPLINGS

- A. Where flexible connections in the piping are indicated on the drawings, they shall be obtained by the use of sleeve-type couplings, split couplings or non metallic couplings.
- B. Non-metallic coupling
 - 1. Suitable for 200 psi working pressure.
 - 2. Coupling body to be EDPM construction.
 - 3. Retaining rings to be 316 stainless steel.
 - 4. Minimum of 4 tie rods connecting flanges of the coupling.
 - 5. Type J-1W, Wide Arch Expansion Joint manufactured by RedFlex or equal.
- C. Sleeve-Type Couplings
 - 1. Pressure rating at least equal to that of the pipeline in which they are to be installed.
 - 2. For sizes 2 1/2 to 16-inch diameter, up to 250 psi working pressure:
 - a. Provide style 442 Long Sleeve, Cast Coupling by Smith Blair, Inc., Texarkana, Texas, or be acceptable equivalent products.
 - 3. For sizes greater than 16-inch diameter, up to 150 psi working pressure:
 - a. Provide style 411, with 10-inch long sleeve minimum, Steel Coupling by Smith Blair, Inc., Texarkana, Texas, or be acceptable equivalent products.
 - 4. Nuts and Bolts to be **[galvanized-steel] [high strength, low alloy steel] [stainless steel]**, unless noted otherwise.
 - 5. Provided with gaskets of a composition suitable for exposure to the liquid within the pipe.
 - 6. Provide with fusion bonded epoxy finish.
 - 7. Conform to requirements of AWWA C219.
- D. Split Couplings
 - 1. Split couplings may be used for connecting ductile-iron pipe. If split couplings are used with grooved pipe, the minimum pipe wall thickness shall be as specified under AWWA C606.
 - 2. Split couplings shall be made of malleable iron and shall be NAPPCO couplings made by North American Pipe Products Co.; or acceptable equivalent products.
 - 3. Where split couplings are furnished in lieu of flanged joints the joint shall be of the rigid type with pipe grooves cut to bring the ends of the pipe solidly together. The beam strength of the joint shall be equal to or greater than that of a flanged joint.

4. Where split couplings are indicated to provide for expansion or flexibility, the pipe grooves shall be cut to provide the necessary expansion or flexibility.

2.14 FILLING RINGS

- A. Provide suitable filling rings where the layout of the flanged piping is such as to necessitate their use. In materials, workmanship, facing, and drilling, such rings shall conform to ANSI Class 125 standard.
- B. Filling rings shall be of suitable length with nonparallel faces and corresponding drilling, if necessary, to ensure correct assembly of the adjoining piping or equipment.

2.15 WALL CASTINGS

- A. Wall castings shall be of the sizes and types indicated on the drawings. Flanges, facing and drilling shall conform to ANS A21.10 except that where required, as where a flange is substantially flush with the face of a masonry wall, flanges shall be drilled and tapped for studs. Other dimensions shall be substantially equal to corresponding parts of standard fittings. A central fin not less than 1/2-inch thick and 1-1/2-inch to 2-inch high shall be cast on the barrel at a point that will locate it midway through the wall to form a water stop.

2.16 RESTRAINTS

A. General

1. All valves and fittings shall be restrained, so that all thrusts shall be supported independent of the piping system.
2. All restraints shall conform to pipe manufacturer's recommendation.

B. For interior piping, restraints shall be located as follows:

1. Anchors shall be placed so all forces will be balanced.
2. Tie downs shall be used to hold the pipe in position where velocity and surge forces will cause pipe movement. They shall control stress due to thermal expansion at wall pipes, sleeves and equipment.
3. Guides shall be used to prevent transverse motion at flexible couplings used as expansion joints.

C. Tie Rods

1. On piping, where flexible couplings are located near fittings or valves, stainless steel tie rods shall span the coupling from the two adjacent flanges.
2. Where the Engineer intends to have flexible couplings used as expansion couplings, tie rods may be omitted.
3. All tie rods shall be sized, spaced and installed according to the manufacturer's recommended procedure, or as directed by the Engineer.

D. Thrust Blocks

1. Constructed at all exterior pipe fittings 22-1/2° and over, and valves, unless specifically ordered otherwise by the Engineer.
2. The blocks shall be placed against undisturbed soil or against soil which has been compacted as specified in Division 2 for structures and pipes.
3. Concrete used for thrust blocks shall be 3000 psi strength.

2.17 HANGERS AND SUPPORTS

- A. In accordance with SECTION 15140.
- B. In addition to the hangers and supports spaced as specified elsewhere in this specification, furnish and install additional hangers and supports at all valves, fittings and pipe line equipment. Holding devices for valves and other pipe line appurtenances shall be designed and constructed to hold each unit securely.
- C. Where indicated on the Drawings or otherwise required, piping supports shall consist of concrete piers or fabricated steel supports. In these instances, materials and workmanship shall be in full compliance with Division 3 of these specifications.
- D. Furnish and install all supports necessary to hold the piping and appurtenances in a firm, substantial manner (as determined and/or directed by the Engineer) at the lines and grades indicated on the drawings or specified. The design and fabrication of such supports shall be the responsibility of the Contractor as part of the work.
- E. All pipe and appurtenances connected to equipment shall be supported in such a manner as to prevent any strain being imposed on the equipment. When manufacturers have indicated requirements that piping loads shall not be transmitted to their equipment, the Contractor shall submit a certification from the manufacturer stating that such requirements have been complied with.

2.18 PIPE PENETRATIONS

- A. In accordance with SECTION 15050.

2.19 PIPE INSULATION (FOR EXPOSED WATER AND FORCE MAINS)

- A. Buried or exposed Service
 - 1. Cellular glass type made specifically for thermal insulation of underground piping and is compatible with the piping material.
 - 2. Insulation composed of all glass sealed cells having no binders or fillers.
 - 3. The completed product shall be rigid and impermeable with ultimate compressive strength shall be at least 100 psi.
 - 4. Thermal conductivity of the cellular glass shall be no higher than 0.40 BTU/sq ft/F°/in.
 - 5. Cellular glass thickness shall be 2-inches thick and comply with all requirements of federal specification HH-1-551 and ASTM C552.
 - 6. Bands for securing the insulation to the pipe shall be 0.5 inches wide by 0.020 inches thick and shall be made of stainless steel.
 - 7. Jacketing for buried insulation
 - a. Flexible laminate consisting of asphalt and glass fabric.
 - b. Fabricated so that it can be wrapped around the insulation and easily secured in place.
 - c. Flexible and tough enough to be wrapped tightly around the insulation and secured without tearing or cracking.
 - 8. Jacketing for above ground insulation
 - a. Standard gauge aluminum jacketing with stainless steel bands.

2.20 PAINTING AND IDENTIFICATION

- A. In accordance with SECTION 09900.

PART 3 EXECUTION

3.01 INSTALLATION

A. General

1. Coordinate work with the other trades, so that interferences between piping, duct, equipment, architectural and structural features, and other work will be avoided.
2. Anchors, bolts, inserts, supports, wall fittings, sleeves and all other appurtenances required to be built in to the work prior to the installation of pipe work shall be furnished and installed accurately and maintained in position during placement of the surrounding concrete and or masonry.
3. Drawing are diagrammatic and do not attempt to show all offsets or fittings. Install piping to conform to structures, equipment, approved shop drawings and fit work of other trades as approved by the Engineer at no additional expense to the Owner.
4. Install piping as closely as possible to walls, ceilings, columns, and other structural parts (consistent with proper space for covering, removal of pipe and access to equipment) so as to occupy the minimum of space, and all offsets and fittings required to accomplish this must be furnished by the Contractor without additional expense to the Owner.
5. In case interference develops, the Engineer will decide which work is to be relocated regardless of which was first installed.

B. Protection Against Settling

1. Where a cast pipe passes through a concrete structure into fill, whether shown or otherwise, there shall be a flexible pipe coupling at or within 12-inches of the concrete face. A second flexible joint (flexible pipe coupling or bell and spigot) shall be provided within 3 feet of the first, whether shown or not.

C. Ductile-Iron Pipe

1. Care shall be taken in handling and installing pipe and fittings to avoid damaging the pipe, scratching or marring machined surfaces, and abrasion of the pipe coatings.
2. Any fitting showing a crack and any fitting or pipe which has received a severe blow that may have caused an incipient fracture, even though no such fracture can be seen, shall be marked as rejected and removed at once from the Work.
3. In any pipe showing a distinct crack and in which it is believed there is no incipient fracture beyond the limits of the visible crack, the cracked portions, if so approved, may be cut off by and at the expense of the Contractor before the pipe is installed so that the pipe used is perfectly sound. The cut shall be made in the sound barrel at a point at least 12-inches from the visible limits of the crack.
4. Cutting shall be done with a machine having rolling wheel cutters, knives, or saws adapted to the purpose. Hammer and chisel or so-called wheel span cutters shall not be used to cut pipe. All cut ends shall be examined for possible cracks caused by cutting.
5. Castings to be encased in masonry shall be thoroughly cleaned of all rust, scale and other foreign material. Then accurately set with the bolt holes, if any, carefully aligned.
6. Appurtenances shall be set and jointed as indicated on the drawings.
7. Before the pieces are assembled, rust-preventive coatings shall be removed from machined surfaces.

8. Pipe ends, sockets, sleeves, housings, and gaskets shall be thoroughly cleaned and all burrs and other defects shall be carefully smoothed.
9. Flanged joints shall be made up tight, care being taken to prevent undue strain upon pump nozzles, valves, and other pieces of equipment.

D. Tapped Connections in Ductile Iron Pipe

1. Tapped connections shall be made in such manner as to provide a watertight joint and adequate strength against pullout. The maximum size of taps in pipe or fittings without bosses, shall not exceed the listed size in the appropriate table of the Appendix to the above-mentioned ANS A21.51 based on 3 full threads for cast iron and 2 full threads for ductile iron.
2. Where the size of the connections exceeds that given above for the pipe in question, the connection shall be made by means of a tapped tee, branch fitting and tapped plug or reducing flange, or tapping tee and tapping valve, all as indicated or permitted by the Engineer.
3. All drilling and tapping shall be done normal to the longitudinal axis of the pipe; fitting shall be drilled and tapped similarly, as appropriate. Drilling and tapping shall be done only by skilled mechanics. Tools shall be adapted to the work and in good condition so as to produce good, clean-cut threads of the correct size, pitch, and taper.

E. Copper Pipe

1. Joints for piping except where buried shall be made up with 95-5 solder.
2. Joints for supply piping buried or installed below slab shall be made up with at least 1000 degree silver solder, and installed with minimum amount of buried joints.

F. Brass Pipe

1. Install in place of copper pipe when more rigidity is required as stated in article 2.02, B, 7.

G. Black Steel Pipe

1. All threads to be clean, machine cut, and all pipe to be reamed before erection. Each length of pipe as erected shall be up-ended and rapped to dislodge dirt and scale.
2. Screwed joints to be made up with good quality thread compound and applied to the male thread only. After having been set up, a joint must not be backed off unless the joint is completely broken, the threads cleaned, and the new compound applied. All joints shall be airtight.
3. All interior steel piping to have a sufficient number of unions to allow convenient removal of piping. Install rigid joint and flexible couplings as required.

H. Seamless Carbon Steel

1. Maximum length of pipe to be twenty feet.
2. Joint broken after thread compound has set will be cleaned and new compound applied.
3. Joints to be air tight.
4. Install a sufficient number of unions to allow convenient removal of piping.

I. Stainless Steel Pipe

1. Install in accordance with the manufacturer's technical data and printed instructions.
2. Weld joints except flanged where required or screwed where shown on the Drawing.

J. Polyvinyl Chloride (PVC) Pipe

1. Install in accordance with the manufacturer's technical data and printed instructions.

2. Solvent weld joints except flanged where required or screwed where shown on the Drawing. In making solvent welded connections, clean dirt and moisture from pipe and fittings, bevel pipe ends slightly with emery cloth if necessary, and apply solvent cement of the proper grade.
3. Install expansion joints every 50 feet on straight runs in accordance with the manufacturer's recommendations and Engineers approval. Expansion joints shall be used outside adjacent to the structures. Exterior expansion joints shall be installed within an approved sleeve to keep joint free from dirt.
4. Install valves and fittings in accordance with the manufacturer's instructions. Particular care shall be taken not to overstress threaded connections at sleeves. In making solvent weld connections, the solvent should not be spilled on valves or allowed to run from joints.
5. All compete pipelines shall remain undisturbed for 24 hours to develop complete strength at all joints after which they shall be tested as specified.
6. Where PVC passes through wall sleeves, joints shall be caulked with a sealing element or link type seal as shown on the Contract drawings.
7. Install flexible couplings in accordance with the manufacturer's instructions.

K. Fiberglass Reinforced Plastic (FRP) Pipe

1. Cut, fabricate and install in accordance with the manufacturers written instructions.
2. Provide manufacturer's representative for instructing workers with proper jointing procedures.

3.02 SLEEVE-TYPE COUPLINGS

- A. Prior to the installation of sleeve-type couplings, the pipe ends shall be cleaned thoroughly for a distance of 8-inches.
- B. Soapy water may be used as a gasket lubricant.
- C. A follower and gasket, in that order, shall be slipped over each pipe to a distance of about 6-inches from the end, and the middle ring shall be placed on the already laid pipe end until it is properly centered over the joint.
- D. The other pipe end shall be inserted into the middle ring and brought to proper position in relation to the pipe already laid.
- E. The gaskets and followers shall then be pressed evenly and firmly into the middle ring flares.
- F. After the bolts have been inserted and all nuts have been made up finger tight, diametrically opposite nuts shall be progressively and uniformly tightened all around the joint, preferably by use of a torque wrench of the appropriate size and torque for the bolts.
- G. The correct torque as indicated by a torque wrench shall not exceed the values indicated in the tabulation titled TORQUE.

TORQUE

Nominal pipe size, <u>in.</u>	Bolt diameter, <u>in.</u>	Maximum torque, <u>ft.-lb.</u>
3-24	5/8	75
30-36 (1/2 in. mid ring)	5/8	65

30-36 (3/8 in. mid. ring)	5/8	70
30-48	3/4	80
48-72	3/4	70

3.03 HANGERS AND SUPPORTS

A. In accordance with SECTION 15140.

3.04 TRENCHING AND BACKFILL FOR BURIED PIPELINES

A. In accordance with SECTION 02200.

3.05 CLEANING

A. Prior to the pressure and leakage tests, the piping shall be thoroughly cleaned of all dirt, dust, oil, grease and other foreign material. This work shall be done with care to avoid damage to linings and coatings.

3.06 TESTING

A. General

1. All piping and piping systems are to be pressure or leak tested by the Contractor in the presence of the Engineer.
2. Leak testing (exfiltration test) shall be performed on all lines designated for gravity service.
3. Pressure testing shall be performed on all lines designed to transfer product under pressure.
4. No leakage will be permitted.
5. Piping not passing pressure or leak testing shall be repaired or replaced by the Contractor and retested to the satisfaction of the Engineer at no additional expense to the Owner and without extension of time for completion of the Work.
6. Furnish and install suitable temporary testing plugs or caps; pressure pumps, pipe connections, meters, gages, relief valves, blow offs and other necessary equipment; and all labor required, to test the pipe specified in this Section.
7. Subject to approval and provided that the tests are made within a reasonable time considering the progress of the project as a whole, and the need to put the section into service, the Contractor may make the tests when he desires with the following exceptions:
 - a. Pipelines embedded in concrete shall be tested prior to placing of the concrete.
 - b. Exposed piping shall be tested prior to field painting.

B. Ductile Iron Pipe

1. Section of pipe to be tested shall be filled with water of approved quality, and all air shall be expelled from the pipe. If hydrants or blow offs are not available at high points for releasing air the Contractor shall make the necessary taps at such points and shall plug said holes after completion of the test.
2. The section under test shall be maintained full of water for a period of 24 hours prior to the combined pressure and leakage test being applied.
3. The pressure and leakage test shall consist of first raising the water pressure (based on the elevation of the lowest point of the section under test and corrected to the gage location) to a pressure in pounds per square inch numerically equal to the pressure rating of the

pipe but not to exceed 200 psi. Care shall be taken not to apply this pressure to items of equipment known to be incapable of withstanding such pressure.

4. If the specified pressure cannot be achieved and maintain it for a period of **one (1) hour with no additional pumping**, the section shall be considered as having failed to pass the test.
5. If, in the judgment of the Engineer, it is impracticable to follow the foregoing procedure exactly for any reason, modifications in the procedure may be made as required and approved by the Engineer, but in any event the Contractor shall be fully responsible for the ultimate tightness of the line within the above leakage and pressure requirements.

C. Copper Pipe and Carbon Steel Pipe

1. After installation, the piping shall be tested for **one (1) hour at 1.5 times the designed operating pressure**.

D. PVC Pipe

1. Pipe lines shall be subject to a hydrostatic pressure test for **one (1) hour at 1.5 times the designed operating pressure** or as required by the Engineer.

3.07 DISINFECTING AND FLUSHING

A. Pipe lines carrying potable water shall be disinfected

1. Furnish all equipment and materials necessary to do the work of disinfecting, and shall perform the work in accordance with the procedure outlined in AWWA C651, except as otherwise specified herein.
2. The dosage shall be such as to produce not less than 10 PPM after a contact period of not less than 24 hours.
3. After treatment, the main shall be flushed with clean water until the residual chlorine content does not exceed 0.2 PPM.
4. During the disinfection period, care shall be exercised to prevent contamination of water in existing mains.
5. Dispose of the water used in disinfecting and flushing in an approved manner.
6. If, in the opinion of the Engineer and/or owner of the above method of disinfection is deemed impractical, the lines carrying potable water shall be disinfected by the method outlined in AWWA Standard C651, Section 9.

END OF SECTION

SECTION 15070

DUCTILE-IRON PIPE AND FITTINGS

PART 1 GENERAL

1.01 SECTION INCLUDES

- A. Requirements to furnish, install, joint, and test ductile-iron pressure pipe, fittings (including special castings), and appurtenant materials and equipment indicated on the Drawings and specified in this Section.
- B. This Section covers Ductile-Iron Piping not buried in earth.

1.02 REFERENCES

- A. American National Standards Institute (ANSI)
 - 1. A21.4, Standard for Cement-Mortar Lining for Ductile-Iron and Gray-Iron Pipe and Fittings for Water.
 - 2. A21.10, Standard for Gray-Iron and Ductile-Iron Fittings, 3-inch. through 48-inch., for Water and Other Liquids.
 - 3. A21.11, Standard for Rubber-Gasket Joints for Ductile-Iron and Gray-Iron Pressure Pipe and Fittings.
 - 4. A21.15, Standard for Flanged Cast-Iron and Ductile-Iron Pipe with Threaded Flanges
 - 5. A21.50, Standard for Thickness Design of Ductile-Iron Pipe.
 - 6. A21.51, Standard for Ductile-Iron Pipe, Centrifugally Cast in Metal Molds, or Sand-Lined Molds, for Water or Other Liquids.
 - 7. B16.1, Standard for Ductile Iron Pipe Flanges and Flanged Fittings.
- C. American Water Works Association (AWWA)
 - 1 C606, Standard for Grooved and Shouldered Joints.
 - 2 C651, Standard for Disinfecting Water Mains.
- D. American Society for Testing Materials (ASTM)
 - 1. A307, Specification for Carbon Steel Bolts and Studs, 60,000 PSI Tensile Strength.

1.03 SUBMITTALS

- A. In accordance with SECTION 01300 submit the following:
- B. Shop Drawings
 - 1. Piping layouts in full detail.
 - 2. Location of pipe hangers and supports.
 - 3. Location and type of backup block or device to prevent separation.
 - 4. Large scale details of all wall penetrations and special castings.
 - 5. Schedules of all pipe, fittings, special castings, couplings, expansion joints, and other appurtenances.
- C. Certificates

1. Sworn certificates in duplicate of shop tests showing compliance with appropriate standard.
- D. Manufacturer's Literature
1. Catalog cuts of joints, couplings, harnesses, expansion joints, gaskets, fasteners and other accessories.
 2. Brochures and technical data of coatings and lining's and proposed method of application.

1.04 QUALITY ASSURANCE

- A. Inspect and test at foundry according to ANSI Standards.
- B. Owner reserves right to inspect and/or test by independent service at manufacturer's plant or elsewhere at his own expense.
- C. Owner reserves right to perform visual inspection and hammer test before installation.

PART 2 PRODUCTS

2.01 PIPE

A. Ductile-Iron Pipe

1. Designed in accordance with ANS A21.50.
2. Manufactured in accordance with ANS A21.15 or ANS A21.51.
3. Ductile-iron pipe shall be at least thickness **Class 52** for pipe 4-inch and smaller and at least thickness **Class 53** for pipe 6-inch and larger, unless stated otherwise.
4. Ductile-iron pipe for use with split couplings shall have a thickness as specified in this Section.

B. Pipe For Use With Couplings

1. Pipe for use with sleeve-type couplings shall be as specified above except that the ends shall be plain (without bells or beads). The end shall be cast or machined at right angles to the axis.
2. Pipe for use with split couplings shall be as specified above except that the ends shall not have bells or beads but shall have cast or machined shoulders or grooves conforming to AWWA C606.

2.02 FITTINGS

A. Flanged Fittings

1. Provide with working pressure of 250 psi.
2. Faced and drilled in accordance with ANS A21.10 except that special drilling or tapping shall be provided as necessary to ensure correct alignment and bolting.
3. Flanged fittings which are not available under ANS A21.10 (e.g. laterals or reducing ells) shall be furnished to conform to the requirements of ANS B16.1, class 125.

B. Base Elbows

1. Fittings shall be provided with standard bases in accordance with ANSI/AWWA C110/A21.10 where so indicated.

C. Grooved Fittings

1. In accordance with ANS A21.10 in all respects except minimum wall thickness as follows:

<u>Nominal Pipe size, in.</u>	<u>Minimum wall thickness, in.</u>
3	0.40
4	0.40
6	0.45
8	0.53
10	0.55
12	0.60

D. Nonstandard Fittings

1. Fittings having nonstandard dimensions and cast especially for this project shall be of acceptable design. They shall be manufactured to meet the requirements of the same specifications and shall have the same diameter and thickness as standard fittings, but their laying lengths and types of ends shall be determined by their positions in the pipelines and by the particular piping to which they connect.

2.03 ADAPTERS

- A. Where it is necessary to joint pipes of different type, furnish and install the necessary adapters unless solid sleeves are indicated on the Drawings or permitted. Adapters shall have ends, conforming to the above specifications for the appropriate type of joint, to receive the adjoining pipe. Adapters joining two classes of pipe may be of the lighter class provided that the annular space in bell-and-spigot type joints will be sufficient for proper jointing.

2.04 JOINTS

A. Gaskets

1. Gaskets shall be of a composition suitable for exposure to the product which the pipe is intended.

B. Flanges

1. Flanges for flanged pipe shall conform to ANS A21.15 except that special drilling or tapping shall be done as necessary to ensure correct alignment and bolting.

2.05 COUPLINGS

A. Flexible Connections

1. Where flexible connections in the piping are specified or indicated on the drawings, they shall be obtained by the use of sleeve-type couplings or split couplings.

B. Sleeve Type Couplings

1. Pressure rating at least equal to that of the pipeline in which they are to be installed.

2. For sizes 2 1/2 to 16-inch diameter, up to 250 psi working pressure:
 - a. Provide style 442 Long Sleeve, Cast Coupling by Smith Blair, Inc., Texarkana, Texas, or be acceptable equivalent products.
3. For sizes greater than 16-inch diameter, up to 150 psi working pressure:
 - a. Provide style 411, with 10-inch long sleeve minimum, Steel Coupling by Smith Blair, Inc., Texarkana, Texas, or be acceptable equivalent products.
4. Nuts and Bolts to be high strength, low alloy steel, unless noted otherwise.
5. Provided with gaskets of a composition suitable for exposure to the liquid within the pipe.
6. Provide with fusion bonded epoxy finish.
7. Conform to requirements of AWWA C219.

C. Split Couplings

1. Split couplings may be used for connecting ductile-iron pipe. If split couplings are used with grooved pipe, the minimum pipe wall thickness shall be as specified under AWWA C606.
2. Split couplings shall be made of malleable iron and shall be NAPPCO couplings made by North American Pipe Products Co.; or acceptable equivalent products.
3. Where split couplings are furnished in lieu of flanged joints the joint shall be of the rigid type with pipe grooves cut to bring the ends of the pipe solidly together. The beam strength of the joint shall be equal to or greater than that of a flanged joint.
4. Where split couplings are indicated to provide for expansion or flexibility, the pipe grooves shall be cut to provide the necessary expansion or flexibility.

D. Dismantling Couplings

1. Pressure rating at least equal to that of the pipeline in which they are to be installed.
2. For sizes 14 to 72 inch diameter, up to 150 psi working pressure:
 - a. Provide DJ400 Dismantling Joint 14 to 72 inch with tie rods by Romac Industries, inc. Bothell, Washington, or acceptable equivalent products.
3. Coupling shall meet the specifications set forth in the AWWA Standard C219.
4. Flanged spool shall be AWWA Class D Steel Ring Flanges, compatible with ANSI Class 125 bolt circles.
5. The end ring body shall be made from ASTM A36 Steel.
6. Gaskets shall be compounded for water and sewer service. Meeting the requirements of ASTM D 2000.
7. Bolts shall be stainless steel Type 316.
8. Tie rods shall be stainless steel Type 316.
9. Provide with fusion bonded epoxy, NSF 61 certified.

2.06 Accessories

A. Filling Rings

1. Provide suitable filling rings where the layout of the flanged piping is such as to necessitate their use. In materials, workmanship, facing, and drilling, such rings shall conform to ANSI Class 125 standard.

2. Filling rings shall be of suitable length with nonparallel faces and corresponding drilling, if necessary, to ensure correct assembly of the adjoining piping or equipment.

B. Gaskets, Bolts, And Nuts

1. For flanged joints, gaskets shall be ring gaskets of rubber with cloth insertion. Gaskets 12-inch diameter and smaller shall be 1/16-inch thick; larger than 12-inch, to be 1/8-inch thick.
2. Flanged joints shall be made with bolts, bolt studs with a nut on each end, or studs with nuts where the flange is tapped. The number and size of bolts shall conform to the same American National Standard as the flanges.
3. Bolts and nuts shall, except as otherwise specified or noted on the drawings, be Grade B conforming to ASTM, A307.
4. Bolt studs and studs shall be of the same quality as machine bolts.
5. Submerged flanged joints shall be made up with Type 316 stainless steel stud bolts and nuts.

C. Tapped Connections

1. Tapped connections in pipe and fittings shall be made in such manner as to provide a watertight joint and adequate strength against pullout. The maximum size of taps in pipe or fittings without bosses, shall not exceed the listed size in the appropriate table of the Appendix to the above-mentioned ANS A21.51 based on 3 full threads for cast iron and 2 full threads for ductile iron.
2. Where the size of the connections exceeds that given above for the pipe in question, a boss shall be provided on the pipe barrel, the tap shall be made in the flat part of the intersection of the run and branch of a tee or cross, or the connection shall be made by means of a tapped tee, branch fitting and tapped plug or reducing flange, or tapping tee and tapping valve, all as indicated or permitted by the Engineer.
3. All drilling and tapping of cast-iron pipe shall be done normal to the longitudinal axis of the pipe; fitting shall be drilled and tapped similarly, as appropriate. Drilling and tapping shall be done only by skilled mechanics. Tools shall be adapted to the work and in good condition so as to produce good, clean-cut threads of the correct size, pitch, and taper.

D. Wall Castings

1. Wall castings shall be of the sizes and types indicated on the drawings. Flanges, facing and drilling shall conform to ANS A21.10 except that where required, as where a flange is substantially flush with the face of a masonry wall, flanges shall be drilled and tapped for studs. Other dimensions shall be substantially equal to corresponding parts of standard fittings. A central fin not less than 1/2-inch thick and 1-1/2-inch to 2-inch high shall be cast on the barrel at a point that will locate it midway through the wall to form a water stop.

2.07 FINISHES

A. Lining

1. Inside of pipe and fittings shall be coated with double thickness cement lining and bituminous seal coat conforming to AN A21.4. The standard bituminous coating is specified under the appropriate AN Standard for the pipe and fittings.

B. Coating

1. The outside of pipe and fittings within structures shall not be coated with the

bituminous coating, but shall be thoroughly cleaned and given one shop coat of Intertol Rustinhibitive Primer 621 made by Koppers Co., Inc., Pittsburgh, Pa.; Multiprime made by PPG Industries, Inc., Pittsburgh, Pa.; Chromox 13R50 Primer made by Mobil Chemical Co., Edison, NJ; or an acceptable equivalent product.

2. Outside surfaces of castings to be encased in concrete shall not be coated.
3. Machined surfaces shall be cleaned and coated with a suitable rust-preventative coating at the shop immediately after being machined.

PART 3 EXECUTION

3.01 HANDLING

A. Pipe and Fittings

1. Care shall be taken in handling and installing pipe and fittings to avoid damaging the pipe, scratching or marring machined surfaces, and abrasion of the pipe coatings.
2. Any fitting showing a crack and any fitting or pipe which has received a severe blow that may have caused an incipient fracture, even though no such fracture can be seen, shall be marked as rejected and removed at once from the Work.
3. In any pipe showing a distinct crack and in which it is believed there is no incipient fracture beyond the limits of the visible crack, the cracked portions, if so approved, may be cut off by and at the expense of the Contractor before the pipe is installed so that the pipe used is perfectly sound. The cut shall be made in the sound barrel at a point at least 12-inches from the visible limits of the crack.

3.02 CUTTING

A. Pipe

1. Except as otherwise approved, all cutting shall be done with a machine having rolling wheel cutters, knives, or saws adapted to the purpose. Hammer and chisel or so-called wheel span cutters shall not be used to cut pipe. All cut ends shall be examined for possible cracks caused by cutting.

3.03 INSTALLATION

A. Pipe and Fittings

1. No defective pipe or fittings shall be installed or placed in the Work, and any piece discovered to be defective after having been installed or placed shall be removed and replaced by a sound and satisfactory piece.
2. Each pipe and fitting shall be cleared of all debris, dirt, etc., before being installed and shall be kept clean until accepted in the complete work.
3. Pipe and fittings shall be installed accurately to the lines and elevations indicated on the drawings or required. Care shall be taken to ensure a good alignment both horizontally and vertically.

B. Castings

1. Castings to be encased in masonry shall be accurately set with the bolt holes, if any, carefully aligned.
2. Immediately prior to being set, castings shall be thoroughly cleaned of all rust, scale and other foreign material.

C. Appurtenances

1. All valves, fittings and appurtenances shall be set and jointed as indicated on the drawings.

3.04 ASSEMBLING

A. Bolted Joints

1. Before the pieces are assembled, rust-preventive coatings shall be removed from machined surfaces.
2. Pipe ends, sockets, sleeves, housings, and gaskets shall be thoroughly cleaned and all burrs and other defects shall be carefully smoothed.

B. Flanged Joints

1. Flanged joints shall be made up tight, care being taken to prevent undue strain upon pump nozzles, valves, and other pieces of equipment.

C. Sleeve-Type Couplings

1. Prior to the installation of sleeve-type couplings, the pipe ends shall be cleaned thoroughly for a distance of 8-inches.
2. Soapy water may be used as a gasket lubricant.
3. A follower and gasket, in that order, shall be slipped over each pipe to a distance of about 6-inches from the end, and the middle ring shall be placed on the already laid pipe end until it is properly centered over the joint.
4. The other pipe end shall be inserted into the middle ring and brought to proper position in relation to the pipe already laid.
5. The gaskets and followers shall then be pressed evenly and firmly into the middle ring flares.
6. After the bolts have been inserted and all nuts have been made up finger tight, diametrically opposite nuts shall be progressively and uniformly tightened all around the joint, preferably by use of a torque wrench of the appropriate size and torque for the bolts.
7. The correct torque as indicated by a torque wrench shall not exceed the values indicated in the tabulation titled TORQUE.

TORQUE

<u>Nominal pipe size, in.</u>	<u>Bolt diameter, in.</u>	<u>Maximum torque, ft.-lb.</u>
3-24	5/8	75
30-36 (1/2 in. mid ring)	5/8	65
30-36 (3/8 in. mid. ring)	5/8	70
30-48	3/4	80
48-72	3/4	70

3.06 PIPING SUPPORT

- A. The Contractor shall furnish and install all supports necessary to hold the piping and appurtenances in a firm, substantial manner (as determined and/or directed by the Engineer) at the lines and grades indicated on the drawings or specified. The design and fabrication of such supports shall be the responsibility of the Contractor as part of the work.

- B. All pipe and appurtenances connected to equipment shall be supported in such a manner as to prevent any strain being imposed on the equipment. When manufacturers have indicated requirements that piping loads shall not be transmitted to their equipment, the Contractor shall submit a certification from the manufacturer stating that such requirements have been complied with.
- C. Piping within buildings and structures shall be adequately supported from floors, walls, ceilings and beams. Supports from the floor shall be by approved saddle stands or suitable concrete or brick piers as indicated or approved by the Engineer. Pipe saddles shall be shaped to fit the pipe with which they will be used and shall be capable of screw adjustment. Concrete piers shall conform accurately to the bottom one-third to one-half of the pipe. Piping along walls shall be supported by approved wall brackets with attached pipe rolls or saddles or by wall brackets with adjustable hanger rods. For piping supported from the ceiling, approved rod hangers of a type capable of screw adjustment after erection of the piping and with suitable adjustable concrete inserts or beam clamps shall be used.

3.07 CLEANING

- A. Prior to the pressure and leakage tests, the piping shall be thoroughly cleaned of all dirt, dust, oil, grease and other foreign material. This work shall be done with care to avoid damage to linings and coatings.

3.08 PRESSURE AND LEAKAGE TESTS

- A. Except as otherwise directed, all pipelines shall be given combined pressure and leakage tests in sections of approved length.
- B. The Contractor shall furnish and install suitable temporary testing plugs or caps; all necessary pressure pumps, pipe connections, meters, gages, relief valves, and other necessary equipment; and all labor required, to test the pipe specified in this Section.
- C. Subject to approval and provided that the tests are made within a reasonable time considering the progress of the project as a whole, and the need to put the section into service, the Contractor may make the tests when he desires.
- D. However, pipelines embedded in concrete shall be tested prior to placing of the concrete and exposed piping shall be tested prior to field painting.
- E. Unless it has already been done, the section of pipe to be tested shall be filled with water of approved quality, and all air shall be expelled from the pipe. If hydrants or blow offs are not available at high points for releasing air the Contractor shall make the necessary taps at such points and shall plug said holes after completion of the test.
- F. The section under test shall be maintained full of water for a period of 24 hours prior to the combined pressure and leakage test being applied.
- G. The pressure and leakage test shall consist of first raising the water pressure (based on the elevation of the lowest point of the section under test and corrected to the gage location) to a pressure in pounds per square inch numerically equal to the pressure rating of the pipe but not to exceed 200 psi. Care shall be taken not to apply this pressure to items of equipment known to be incapable of withstanding such pressure.

- H. If the Contractor cannot achieve the specified pressure and maintain it for a period of one hour with no additional pumping, the section shall be considered as having failed to pass the test.
- I. If the section fails to pass the pressure and leakage test, the Contractor shall do everything necessary to locate, uncover, and repair or replace the defective pipe, fitting, or joint, all at his own expense and without extension of time for completion of the work. Additional tests and repairs shall be made until the section passes the specified test and is considered acceptable by the Engineer.
- J. If, in the judgment of the Engineer, it is impracticable to follow the foregoing procedure exactly for any reason, modifications in the procedure may be made as required and approved by the Engineer, but in any event the Contractor shall be fully responsible for the ultimate tightness of the line within the above leakage and pressure requirements.

3.09 DISINFECTING AND FLUSHING

- A. The Contractor shall disinfect the lines carrying potable water.
- B. The Contractor shall furnish all equipment and materials necessary to do the work of disinfecting, and shall perform the work in accordance with the procedure outlined in AWWA C651, except as otherwise specified herein.
- C. The dosage shall be such as to produce not less than 10 PPM. after a contact period of not less than 24 hours.
- D. After treatment, the main shall be flushed with clean water until the residual chlorine content does not exceed 0.2 PPM.
- E. During the disinfection period, care shall be exercised to prevent contamination of water in existing mains.
- F. The Contractor shall dispose of the water used in disinfecting and flushing in an approved manner.
- G. If, in the opinion of the Engineer and/or owner of the above method of disinfection is deemed impractical, the lines carrying potable water shall be disinfected by the method outlined in AWWA Standard C651, Section 9.

3.10 PAINTING

- A. The shop coats to be given pipe and fittings are specified under article 2.06 FINISHES.
- B. Field painting is Specified in SECTION 09900 - FIELD PAINTING.

END OF SECTION

SECTION 15100

VALVES, GATES, HYDRANTS AND APPURTENANCES

PART 1 GENERAL

1.01 SUMMARY

A. Section Includes

1. Requirements for furnishing and installing valves, gates, hydrants, and miscellaneous piping appurtenances, as indicated on the Drawings and as specified.
2. The Drawings and Specifications direct attention to certain features of the equipment, but may not cover all the details of their design. The equipment furnished shall be designed and constructed equal to the high quality equipment manufactured by such firms as mentioned, or as permitted by the Engineer. The Contractor shall furnish and install the equipment complete in all details and ready for operation.

B. Related Work

1. Section 09900 - Painting

1.02 DESIGN REQUIREMENTS

- ###### A. Enclosures shall be suitable for the atmosphere in which they are installed.

1.03 REFERENCES

A. American Society for Testing and Materials (ASTM)

1. A126, Standard Specification for Gray Iron Castings for Valves, Flanges, and Pipe Fittings
2. A536, Standard Specification for Ductile Iron Castings
3. B62, Standard Specification for Composition Bronze or Ounce Metal Castings

B. American Water Works Association (AWWA)/American National Standards Institute (ANSI)

1. ANSI/AWWA C110/A21.10, Standard for Ductile Iron & Gray-Iron Fittings 3 in through 48 in for Water and Other Liquids
2. ANSI/AWWA C111/C21.11, Standard for Rubber-Gasket Joints for Ductile-Iron and Pressure Pipe and Fittings
3. ANSI/AWWA C500, Standard for Metal-Seated Gate Valves for Water Supply Service.
4. ANSI/AWWA C504, Rubber-Sealed Butterfly Valves
5. ANSI/AWWA C509, Resilient-Seated Gate Valves for Water-Supply Service
6. ANSI/AWWA C515, Reduced-Wall, Resilient-Seated Gate Valves for Water-Supply Service
7. ANSI/AWWA C517, Resilient-Seated Cast-Iron Eccentric Plug Valves
8. ASME/ANSI B16.1/B16.5, Cast Iron Pipe Flanges and Flanged Fittings/ Pipe Flanges and Flanged Fittings
9. AWWA C550, Protective Epoxy Interior Coatings for Valves and Hydrants
10. AWWA C606, Grooved and Shouldered Joints

1.04 SUBMITTALS

- A. Submit in accordance with Section 01300 – Submittals
 - 1. Manufacturer's specifications, catalog data, descriptive matter, illustrations, diagrams etc.

PART 2 PRODUCTS

2.01 MANUFACTURERS

- A. All gate, globe, angle, and check valves shall be the product of one manufacturer.

2.02 GATE VALVES

- A. Valves smaller than 2-inches.
 - 1. 200 lb. WOG minimum bronze valves with screwed ends to suit the piping in which they are installed.
 - 2. Body material shall conform to ASTM B62.
 - 3. Valves shall have union bonnet, rising stem, inside screw, and solid wedge gate.
- B. Valves 2-inches and larger.
 - 1. Iron-body, resilient-wedge or double disk as specified.
 - 2. Mechanical joint or flanged ends as indicated on the Drawings or herein specified.
 - 3. All valves shall be designed for a minimum of 250 psi working pressure.
 - 4. Face-to-face dimensions of flanged valves shall conform to the ANS B16.10.
 - 5. Stem material shall be silicon bronze or an acceptable equivalent having high resistance to dezincification.
 - 6. All exposed nuts, bolts and washers shall be stainless steel.
 - 7. Valves shall be capable of being repacked under line pressure.
 - 8. Sewer Valves shall be turned to the **left (counterclockwise)** to open
 - 9. Water Valves shall be turned to the **right (clockwise)]** to open.
 - 10. Coatings
 - a. Exterior and interior surfaces of all valves shall be coated by the valve manufacturer prior to shipment.
 - b. The coating shall be applied and cured in strict conformance with the coating manufacturer's cautions and instructions.
 - c. The coating shall be applied by the valve manufacturer under controlled factory conditions, and field application is strictly prohibited.
 - d. The coating shall be a fusion bonded epoxy-protective coating system which meet all requirements of AWWA C550.
- C. Process Valves
 - 1. In accordance with AWWA Specification C-500.
 - 2. Iron body, bronze trim, **[solid wedge with tapered seat or double revolving disc, parallel seat]** construction.
 - 3. If of the parallel seat type, the discs and wedges shall be free of pockets and rib.
- D. Potable Water Valves 4-inches through 12-inches

1. Gate valves shall be resilient seated wedge type in accordance with AWWA [**C509 or C515**].
 2. Valve bodies to be of ductile iron.
 3. All valves shall be allowed replacement of upper “O” rings while the valve is under pressure in a fully-opened position.
 4. Valves shall have a two-inch operating nut or hand-wheel as required for the particular application and as shown on the Drawings.
 5. Coating
 - a. The AWWA C550 epoxy coating shall not impart taste or odors to the water. The coating shall be a product acceptable to the NSF for use in potable water and shall be so listed in the most current NSF summary of approved products (ANSI/NSF Standard 61).
- E. Valves greater than 12-inches.
1. Shall meet the requirements of AWWA [**C500 or C509, or C515**] as indicated on the Drawings and meet requirements of the applicable sections of this specification.
- F. Buried/Exterior Valves
1. O-ring seals at stuffing box and bonnet to body flanges
 2. Mechanical joint ends.
 3. Non rising stem, inside-screw, two (2) inch operating nut and suitable coupling to connect to valve stem.
 4. Suitable for buried service.
 5. Operating wrench.
- G. Interior Valves
1. Stuffing box follower bolts shall be of steel and the nuts shall be of bronze.
 2. O.S. & Y. except where N.R.S. is called for, and have a packing seal.
 3. Flanged unless otherwise shown on the Drawings.
 4. Flanges shall be drilled to the ANSI 125/150 pound standard.
- H. Actuators
1. Means of actuation by wheel, lever, tee wrench, gear actuator or motorized actuator, as specified or as indicated on the Drawings.
 2. Interior Gate Valves
 - a. Hand-wheel operated.
 - b. Hand wheels shall be of ample size for ease of operation and shall have an arrow and the work OPEN cast thereon to indicate the direction of opening.
 - c. Chain operator for valves with operating stem height six (6) feet above finished floor.
 - d. Supply actuators to operate valve as required.
 3. Buried/Exterior Valves
 - a. Provide extension stem with two-inch operating nut, to terminate 18 inches below finish grade.
 - b. Provide valve boxes.
 - c. All buried valves shall be equipped with the specified actuator and shall be suitable for buried service.
 4. Valves 12 inches and larger
 - a. Equip with gear actuators.
 - b. Actuator gear box shall be of totally enclosed oil or grease bath lubricated type, suitable for operation at any angle and provided with the appropriate filling and drain plugs.

- c. Shaft bearings furnished with permanently lubricated bronze bearing bushings.
 - d. Actuator shall clearly indicate valve position and an adjustable stop shall be provided.
 - e. Construction of actuator housing shall be semi-steel with exposed nuts, bolts, and washers to be zinc plated.
 - f. All valve actuators shall be as recommended by the valve manufacturer.
5. Valves shall be manufactured by American Flow Control, Birmingham, AL; Kennedy Valve, Elmira, N.Y. or acceptable equivalent.

2.03 CHECK VALVES

A. Check valves 3 inches and larger

- 1. Iron-body, bronze-mounted, full-opening, swing-type check valves with bolted covers and flanged ends.
- 2. Flanges shall be faced and drilled in accordance with the 125-lb. AN Standard.
- 3. Valves shall have bronze faced cast iron disc plate suspended at the top from a stainless steel shaft.
- 4. Valve shaft shall be supported by bronze bushings and bearings and shall be packed through externally accessible stuffing box.
- 5. Disc shall seat against resilient seat installed in the valve body.
- 6. Valve closure shall be assured by means of outside lever and weight.
- 7. Shop primed on the outside with a rust inhibitive priming system.

B. Check valves smaller than 3-inches

- 1. 300 pounds bronze curving design with screwed-in bonnet, regrinding bronze disc, and screwed ends.
- 2. Disc shall be suspended at the top with a stainless steel shaft.
- 3. All check valves shall be horizontally mounted.

2.04 PLUG VALVES

A. General

- 1. Valves shall be in full conformance to AWWA C517.
- 2. Nonlubricated eccentric type with resilient faced plugs for service in sewage and sludge piping.
- 3. Valves shall provide bi-directional sealing at 175 psi differential in sizes up to 12 inches and 150 psi differential for sizes 14 inches and larger.
- 4. Valve seating shall provide a consistent opening/closing torque that is not dependent on adjustment of stop. Resilient seating shall be field replaceable on the existing plug.
- 5. Valves shall be of the bolted bonnet, top entry design, capable of repacking without removing the bonnet or valve from the pipe line.
- 6. All exposed nuts, bolts and washers shall be stainless steel.
- 7. Valves shall be DeZurik Model PEF Eccentric Plug Valves, or approved equal. All valves furnished shall be by the same manufacturer.
- 8. Valves shall open Left

B. End Connections

- 1. Flanged ends to be in full compliance with ANSI B16.1-125 lb. /ANSI B16.5 - 150 lb standards including facing, drilling and thickness.
- 2. Mechanical Joint ends to be in accordance with AWWA C111.

3. Grooved ends to be in accordance with AWWA C606.
 4. Screwed ends to be NPT Standard.
- C. Port areas
1. Unobstructed when open and have smoothly shaped waterways of not less than 100 percent of full pipe area.
- D. Valve body
1. Cast iron conforming to ASTM A-126 Class B.
- E. Plug
1. ASTM A536, shall be solid, one piece ductile iron with cylindrical seating surface eccentrically offset from the center of the shaft. The plug shall be resilient faced with neoprene, or other resilient material suitable for use with sewage.
 2. Bearing to be sleeve type, stainless steel and be isolated from solid particulates.
- F. Coatings
1. All surfaces are to be protected, both internally and externally, with a factory coated heat fused thermoset epoxy or thermoplastic nylon complying fully with AWWA Standard C-550.
 2. Epoxy coatings are also acceptable.
- G. Actuators
1. Valves larger than eight inches.
 - a. Provided with manual gear operators having a maximum rim pull of 80 pounds as per AWWA C-504.
 - 1) Gear operators shall be enclosed and provided with seals on all shafts to prevent entry of water, allow submerging of the operator and suitable for running the gears in oil.
 - 2) All shaft bearings shall be furnished with permanently lubricated bronze bearing bushings. Adjustable stops shall be provided.
 - b. Provide with hand wheels.
 2. Valves above six feet from the finish floor or in inaccessible locations.
 - 1) Operated by a chain operator and chain wheel provided by the valve manufacturer to operate that particular valve.
 3. Valves eight inches and smaller located within six feet six inches of the finished floor in accessible locations.
 - 1) Operated by a portable lever.
 - 2) One portable level shall be provided for 50 percent of the valves or 15 portable levers whichever is less.
 4. Valves in inaccessible locations shall be operated by extension stem, stem guides, 2-inch operating nut with mounting bracket or floor box, or floor stand, and lever or hand wheel as appropriate.
 5. The plug valve manufacturer shall provide all operator accessories as required to make each operator system completely operational.
 6. Extension stem, stem guides and 2-inch operating nut as manufactured by Penn-Troy Manufacturing of Troy, PA, Kennedy Valve, Elmira, N.Y. or acceptable equivalent.
 7. Buried or submerged service valves

- 1) Seals on all shafts and gaskets on the valve and actuator covers shall prevent the entry of water.
 - 2) Actuator mounting brackets for buried or submerged service shall be totally enclosed and shall have gasket seals.
 - 3) All exposed nuts, bolts, springs and washers used in buried service shall be stainless steel.
8. Actuator shall clearly indicate valve position.

2.05 BALL VALVES

A. General

1. Straight-through passageway, and shall be of the full-port design.
2. Rated for 150-psi service.

B. Construction

1. Type 316 stainless steel, except for those valves specified PVC construction or installed in PVC piping.
2. Body shall be of rigid construction and symmetrically cast.
3. The shaft and ball shall be integrally cast.
4. Seats and seals shall be Teflon and shall be recessed in a machined groove.
5. Shaft packing
 - a. Braided band.
 - b. Tightened by means of a gland bearing strip.
 - c. Replacement of the packing shall be accomplished without removing the actuator.

C. Valves shall be by Apollo or equal.

2.06 PVC VALVES

A. General

1. Polyvinyl Chloride (PVC) valves shall be manufactured of the same PVC Type 1 Grade 1 molding compound used for the fittings to assure proper compatibility of system components.

B. Ball valves and ball check valves

1. True union PVC valves.
2. Design to allow for entire valve body removal by turning back the union nut at both ends of the valve.
3. Teflon seats and packing.
4. Pressure rating of 150 psi at 75 degrees F water.

C. Diaphragm Valves

1. Constructed of PVC, except diaphragm, including bonnet and hand wheel.
2. Diaphragm shall be replaceable and fully supported in any position.
3. Non-rising stem with a diaphragm position indicator.
4. Diaphragm constructed of Teflon and be replaceable without removing valve from the line.
5. Valve shall be socket ends.
6. Valves shall be by Nibco or equal.

- D. The valves shall be pneumatically or manually operated as shown on the drawings. Valve operators shall be supplied as specified under the valve operation Section 2.10.

2.07 VALVE OPERATORS

- A. Valve operators shall be designed in accordance with the requirements of AWWA Specifications, C504-80 and shall furnish sufficient torque to open and close at 125 percent of the rated working pressure for the valve.
- B. Valves 6 inches and larger shall be gear operated with hand wheels and valves smaller than 6-inches shall be wrench operated, except as hereinafter specified or indicated on the Drawings.
- C. Where there is a lack of space for the valve wrench to operate gear-operators, hand wheels shall be provided in lieu of the wrench.
- D. Chain operators, consisting of sprocket wheels, chain guides and operating chains shall be provided for all valves with operator centerlines located more than 6 feet - 6 inches above the operating level. Operating chain shall be galvanized and shall extend within 3 feet of the operating level. Operators shall develop their maximum capacity with not greater than a 40-lb. pull on the wheel.
- E. Gear operators shall be totally enclosed, worm-gear type, permanently lubricated, and shall be watertight and dust tight.
- F. Gear operators shall be provided with adjustable stops for the open and closed position to prevent over travel, and shall have a valve disk position indicator.
- G. A suitable lever or wrench shall be provided for each six wrench-operated valves and at least one wrench for each operating station. Wrenches or wheels and chains shall be of suitable size and sufficient length for easy operation of the valves at their rated working pressure.
- H. The valve assembly including valve and operator shall be tested to requirements specified herein at the valve manufacturer's factory.

2.08 CHAIN OPERATORS

- A. Valve hand wheel centerlines located more than 6 feet above the floor or operating platforms shall be considered as being inaccessible and shall be provided with chain operators.
- B. Chain wheels and chains shall be provided by the valve manufacturer to operate the particular valve.
- C. Where indicated on the drawings or inaccessible due to size or location, valves shall be provided with chain operators and, where required, angle drives with chains extending to within 3 feet of the floor or operating platform.
- D. Chains shall be galvanized.
- E. Sprocket wheels shall be provided with chain guides.

2.09 TELESCOPING VALVE ASSEMBLIES

A. General

1. Sized to fit riser pipe and penetrate the riser pipe a minimum of 9" in the up position.
2. Unit shall be guaranteed against defects in material and workmanship for a period of three (3) years.

B. Construction

1. The unit shall have a floor stand of 4" square stainless steel tube with 1/8" wall and mounted to 1/2" thick stainless steel base plate.
2. The hand wheel shall be 16" diameter cast aluminum and work in conjunction with a 1 inch square stainless steel rack, 2 inch stainless steel spur gear and oil-impregnated sintered bronze bushings, requiring a maximum of 2 turns for one foot of travel.
3. The sliptube shall be a minimum of 16 ga. stainless steel and incorporate a 150 lbs. stainless steel companion flange and 1/4" thick Neoprene wipe gasket.

C. Provide Series V4R manufactured by Halliday Products, Inc. of Orlando, Florida

2.10 VALVE EXTENSION STEMS

A. General

1. Furnish as required and as shown on the Drawings.
2. Shaft lengths shall suit the particular installation.
3. All exterior valves shall be provided with valve extension stems and valve boxes.
4. Stems shall have a two-inch operating nut and a two-inch coupling for connection of the valves.
5. All operating nuts shall be located 18 inches below finished grade.

2.11 T-HANDLE OPERATING WRENCH

- ### A. Provide in the number and lengths to operate buried valves by workers of average height working in normal position.

2.12 SOLENOID VALVES

A. General

1. Direct acting packless two-way solenoid valve for water service.
2. Normally closed, unless otherwise shown.
3. Provide for operation with 120 volt, 60 Hertz power and have continuous duty Class A insulation.
4. Valve body to be forged brass with safe body working pressure of at least 250 psi.
5. NPT connections unless indicated otherwise.
6. Buna-N seat.
7. Wetted parts to be stainless steel.

B. Valves shall operate satisfactorily when mounted in any position.

C. Valves shall be by ASCO or equal.

- D. Provide [general purpose enclosure.] [enclosures to meet NEMA Type 4X requirements with coils epoxy encapsulated and suitable for high ambient temperatures (140 degrees F).]**

2.13 AIR RELEASE VALVES

A. General

1. Allow for the admission or release of large quantities of air during the fill up or drainage of pipelines and shall be specially designed for use with raw sewage.
2. The valve shall open when the operating pressure falls below atmospheric pressure, and shall close and remain closed when the operating pressure is above atmospheric pressure.

B. Construction

1. Valves shall consist of a compact tubular all stainless steel fabricated body.
2. HDPE hollow direct acting float.
3. HDPE solid large orifice float.
4. Stainless steel nozzle and woven dirt inhibitor screen.
5. Nitrile rubber seals and natural rubber seat.
6. Integral anti-surge orifice mechanism which shall operate automatically to limit surge pressures rise or shock induced by closure to less than 2 times the valve rated working pressure.
7. The intake orifice area shall be equal to the nominal size of the valve i.e., a 6" valve shall have a 6" intake orifice.
8. Large orifice sealing shall be by the flat face of the control float seating against a nitrile rubber O-ring housed in a dovetail groove circumferentially surrounding the orifice.
9. The seating & unseating of a small orifice nozzle on a natural rubber seal affixed into the control float shall control discharge of pressurized air. The nozzle shall have a flat seating land surrounding the orifice so that damage to the rubber seal is prevented.
10. The valve construction shall be proportioned with regard to material strength characteristics, so that deformation, leaking or damage of any kind does not occur by submission to twice the designed working pressure.

C. Connections

1. Flanged ends conforming ANSI B16.1 Class 125.
2. Flanged ends shall be supplied with type 316 stainless steel screwed studs inserted for alignment to the specified standard.
3. Provide type 316 stainless steel nuts and washers.

- D. Air and vacuum valves shall be Series RGX by Vent-O-Mat© and sized as indicated on the Drawings.

2.14 PRESSURE REDUCING VALVES (LARGER THAN TWO INCH)

A. General

1. Flanged globe body, bronze mounted, external pilot operated with a free floating piston and shall operate without springs, diaphragms or levers.
2. Single seat with the seat bore equal to the size of the valve.
3. Piston travel shall be a minimum of 25 percent of the seat diameter. The piston shall be guided above and below the seat no less than a length equal to 75 percent of the seat diameter. The piston shall be cushioned and designed to insure positive closure.

4. The valve shall be suitable for 150 pound flanged service and shall conform to AWWA standards for flange thickness, drilling and the wall thickness of the body and caps. The valve body shall be constructed of gray iron, free from cold shuts and defects and having a minimum tensile strength of 35,000 psi.
5. The valve shall be hydrostatically tested at a minimum of two times the rated service pressure. All iron castings shall be coated on all surfaces with two coats of asphaltic base metal paint.

B. Construction

1. Packed with leather and shall be furnished with an indicator rod to show the piston position.
2. Gauge petcocks shall be furnished on the valve body.
3. The pilot valve
 - a. Easily accessible and shall be removable from the main valve under pressure.
 - b. Adjustable without special tools or the removal of springs or weights.
4. The main valve shall be designed to facilitate repairs internally without removing the valve from the line.
5. The valve shall be designed to maintain a preadjusted downstream pressure for varying rates of flow by piston positioning without water hammer.

2.15 PRESSURE REDUCING VALVES (TWO INCHES AND SMALLER)

A. General

1. Single seated balanced design type globe body with threaded inlet and outlet ports.
2. Valves shall be diaphragm operated, spring loaded, and permitting convenient adjustment.

B. Construction

1. The body shall be of bronze construction with stainless steel stem.
2. Furnished with a replaceable rubber seat.

C. Valves shall be G-A Industries Figure 43-D, Watts No. 223, or equal.

2.16 PRESSURE RELIEF VALVE

A. Construction

1. Cast iron frame and cover with a bronze body ring and rubber flap ring.
2. Hinge pin shall be bronze and secured with cotter pins.
3. Valve shall have two pivot points and shall have a flanged end.

B. No leakage shall occur on a valve with at least 18 inches of water cover above the installed valve.

2.17 VALVE BOXES

A. General

1. Each buried stop and valve shall be provided with a suitable valve box.

B. Construction

1. Adjustable, telescoping, heavy-pattern type with the lower and the upper part of cast iron.
 2. Designed and constructed as to prevent the direct transmission of traffic loads to the pipe or valve.
 3. The upper or sliding section of the box shall be provided with a flange having sufficient bearing area to prevent undue settlement.
 4. The lower section of the box shall be designed to enclose the operating nut and stuffing box of the valve and rest on the valve bonnet.
 5. Adjustable through at least 6 inches vertically without reduction of the lap between sections to less than 4 inches.
 6. The inside diameter of boxes for valves shall be at least 4-1/2 inches, and the lengths shall be as necessary for the depths of the valves or stops with which the boxes are to be used.
 7. Covers
 - a. Cast iron close fitting and substantially dirt-tight.
 - b. The top of the cover shall be flush with the top of the box rim.
 - c. An arrow and the word OPEN to indicate the direction of turning to open the valve shall be cast in the top of the valve covers.
 - or**
 - d. Letters to indicate the service similar to "WATER" or "SEWER" shall be cast in the top of the valve covers as appropriate.
- C. Boxes for curb stops shall be threaded internally to fit the threads on the bonnet of the curb stop.

2.18 FIRE HYDRANTS

A. General

1. Designed for 175 psi working pressure.
2. Conform to the latest specifications for hydrants by the AWWA.
3. Listed by Underwriters Laboratories, Inc. and Factory Mutual Research.

B. Construction

1. Provide with **two 2 ½ inch hose nozzles and one 4 ½ inch pumper nozzle**, unless required otherwise by the Owner.
2. Inlet connections to be mechanical joint.
3. Provide one operating wrench with each hydrant.
4. Drainage wells of 1/2 cubic yard capacity of two-inch crushed stone shall be placed in the excavation below the hydrant bottom.
5. Concrete thrust block shall be used to back up the hydrant and in no way shall block the hydrant drains.
6. Painting shall be in accordance with Specification Section 09900 – Painting, colors to match Owners standard.

- C. Provide model Modern Centurion® as manufactured by Mueller Company, Decatur, IL or equal.

2.19 HOSE BIBS

A. General

1. 3/4 inch bronze gate valve with a 3/4 inch NPT discharge connection.

2. A cap and chain shall be supplied for the outlet.
3. Provide Model 372 as made by Jenkins or similar models from Lunkenheimer or Crane or equal.

2.20 QUICK DISCONNECT COUPLINGS

A. General

1. Couplings and adapters shall be furnished in the quantities, types and sizes as shown on the Drawings or specified herein.
2. The couplings and adapters shall be designed for a working pressure of 200 psig.
3. Couplings and adapters shall be of **[aluminum] [stainless steel]** and shall utilize a cam-type mechanism for connecting the coupler and adapter pieces to provide a leak proof connection.
4. No springs, ball bearings or snaps shall be used to make the connection.
5. The couplings shall be fitted with Buna-N gaskets recessed into the coupling to prevent the gasket from falling out.
6. The disengagement handle pins shall be of stainless steel and stainless steel rings shall be furnished on the handles.

2.21 POLYVINYL CHLORIDE TUBING (FLEXIBLE PVC)

A. Construction

1. Nylon braiding incorporated within the walls of the tubing.
2. The nylon braiding shall be completely protected by a smooth outside covering of PVC, thus shielding the mesh from conditions detrimental to exterior mesh tubing.
3. The tubing shall have a working temperature of minus five degrees F to 175 degrees F.

2.22 VALVE TAGS

A. General

1. 1 ½ inch, square, brass.
2. Stamped ½ inch characters to be black filled.
3. Numbered to owners identification system, if no system is required then number sequentially.
4. Provide each tag with No. 16 brass jack chain in suitable length to attach tag to valve.

2.23 TAPPING SLEEVE AND VALVE

Note to Specifier, this spec is for a ductile iron body. Other less expensive models are available.

A. General

1. Tapping sleeves, including outlet flanges shall be as dimensioned and thicknesses shall be as required by ANSI/AWWA C110/A21.10.
2. Designed to withstand working pressure of at least 200 PSI.
3. Furnish with tee head bolts and gaskets conforming with ANSI/AWWA C111/A21.11
4. Conform to the latest specifications adopted by the AWWA and be of the specific size to suit the existing conditions.

B. Construction

1. Mechanical joint, two part castings flanged on the vertical centerline, and come complete with all joint accessories.
2. The surface area of each flange shall be thoroughly machined, and the tapping sleeve flanges shall be fitted with gaskets.
3. Each gasket shall cover the entire surface area of each joint for the full length of the tapping sleeve.
4. Bolts used to assemble the tapping sleeves shall pass directly through each flange and through each gasket and be properly spaced to insure uniform gasket pressure and compression.
5. Tapping sleeve outlets shall have counter bored flange to insure proper centering of the tapping valve.
6. Tapping sleeve and valve assembly to satisfactorily pass air test prior to coring main.
7. All tapping valves shall be flanged by mechanical joint.
8. Tapping valves shall conform to the specifications for gate valves (Potable Water Valves).

PART 3 EXECUTION

3.01 GENERAL

- A. Valves shall be installed as nearly as possible in the positions indicated on the drawings consistent with conveniences of operating the hand wheel or wrench. All valves shall be carefully erected and supported in their respective position free from all distortion and strain in appurtenances during handling and installation. All material shall be carefully inspected for defects in workmanship and material, all debris and foreign material cleaned out of valve openings and seats, all operating mechanisms operated to check their proper functioning, and all nuts and bolts checked for tightness. Valves and other equipment which do not operate easily or are otherwise defective shall be repaired or replaced at the Contractor's expense.
- B. Valves shall not be installed with stems below the horizontal.
- C. Valves shall be set plumb and supported adequately in conformance with the instructions of the manufacturer. Valves mounted on the face of concrete shall be shimmed vertically and grouted in place. Valves in the control piping shall be installed so as to be easily accessible.
- D. Where chain wheels are provided for remote operation of valves two S-shaped hooks shall be provided for each valve to enable the chains to be hooked so as not to interfere with personnel traffic.
- E. Valves shall be provided with extension stems where required for convenience of operation. Extension stems shall be provided for valves installed underground so that operating nuts are located 18 inches below finished grade and elsewhere so that the operating wrench does not exceed 8 feet in length.
- F. A permanent type gasket of uniform thickness shall be provided between flanges of valves and sluice gates and their wall thimble.
- G. Wall thimbles shall be accurately set in the concrete walls so that the gates can be mounted in their respective positions without distortion or strain.

3.02 PLUG VALVES

- A. Plug valves in horizontal sewage and sludge piping shall be installed with the shaft horizontal such that when in the open position, the plug is located in the upper part of the valve body. Valves shall be oriented so that in the closed position, the plug is at the upstream end of the valve.

3.03 VALVE TAGS

- A. Tag valve in visible location, free from interference with operating device, other equipment and personnel.
- B. Develop and provide to Owner, valve chart indicating all valves with corresponding identification number.

3.04 SUPPORTS FOR TERMINAL CLEAN-OUT PIPING

- A. Support to maintain required pitch, prevent vibration, and provide for expansion and contraction.

3.05 FIRE HYDRANTS

- A. Fire hydrants and appurtenances shall be installed in accordance with the local municipal fire codes.

3.06 PAINTING

- A. Shop and Field Painting shall be as specified under SECTION 09900.

END OF SECTION

SECTION 15130

GAUGES

PART 1 GENERAL

1.01 SECTION INCLUDES

- A. Requirements to furnish and install gauges at locations indicated on the Drawings and as specified.

PART 2 PRODUCTS

2.01 GENERAL

- A. Gauges include pressure, vacuum and compound gauges of the dial indicating Bourdon tube-type.
- B. Gauges shall be Helicoid Gauges as manufactured by the American Chain and Cable Co., Ashcroft Duragauges by Manning, Maxwell and Moore, Inc., or approved equal.
- C. Pressure gauges shall be designed to indicate pressures above atmospheric pressure only.
- D. Vacuum gauges shall be designed to indicate pressures below atmospheric pressure only.
- E. Compound gauges shall be designed to indicate pressures above and below atmospheric pressure.

2.02 LOCATION

- A. Gauges shall be provided where shown on the Drawings, specified in the Specifications or required for a complete installation. Indicating pressure gauges shall be provided downstream of each pressure regulating valve where shown, specified or required; in the seal water piping of each pump; and on both the suction and discharge piping of each pump except where otherwise specified.

2.03 ACCURACY

- A. Grades of accuracy shall conform to the requirements of American Standard A.S.A. B40.1. The Contractor shall submit manufacturer's certifications indicating that the gauges provided have met the accuracy requirements specified.
- B. Pressure, vacuum and compound gauges shall be Grade AA gauges with an error not exceeding $\frac{1}{2}$ of 1 percent of full-scale range.
- C. Gauges with a flexible seal between the Bourdon tube and the medium to be measured shall have an overall accuracy of Grade A with an error not exceeding one percent of scale range for the middle half and 1-1/2 percent for the remainder of the scale.

2.04 GAUGE CONSTRUCTION

- A. Gauges shall be weatherproof, designed and constructed to meet all requirements for satisfactory operation.
- B. Pressure, vacuum and compound gauges shall be constructed of sound, durable material, free from all defects and imperfections that in any way may affect the accuracy and serviceability of the gauges.
- C. Gauge cases shall be of aluminum, phenolic or polypropylene. Dial shall be 4 1/2 inches nominal diameter with black lettering and scales on a white background, and shall bear a legend showing service and units of graduation. Gauge dial shall be clear and blemish free and sealed to prevent entrance of moist air. Bourdon tube shall be phosphor bronze with forged brass socket. Set point shall be of stainless steel. Socket stem shall extend at least 1-1/4 inches below the gauge case and shall have a large wrench flat.
- D. Pressure gauges shall be graduated in psi unless otherwise specified. Vacuum gauges shall be graduated in inches of mercury; compound gauges shall be graduated in inches of mercury, psi or feet of water as specified.
- E. Maximum scale reading for pressure and compound gauges shall be approximately twice the maximum operating pressure of the fluid to be measured. Vacuum and compound gauges shall have minimum scale readings at 30 inches of mercury unless otherwise shown or specified.
- F. Unless otherwise shown or specified, all pressure, vacuum and compound gauges shall have bottom 1/2-inch NPT male connections.

2.05 DIAPHRAGM PROTECTED GAUGES

- A. The Contractor shall provide diaphragm seals on sludge gauges to prevent the fluid to be measured from clogging or corroding the Bourdon tube of pressure, vacuum and compound gauges.
- B. Diaphragm seals shall be suitable for the gauge furnished; gauges to be used with diaphragm seals shall be Grade AA gauges conforming to the requirements specified herein. Chemical gauges shall have the diaphragm seal as an integral part. Overall accuracy for diaphragm protected units shall be Grade A.
- C. Diaphragms shall have an overall diameter of not less than 2-1/2 inches and shall be made of a material that is corrosion resistant and compatible with the process fluid. Diaphragm protected gauges shall be factory filled with Glycerin oil or approved equal and calibrated by the gauge manufacturer. Unless specified otherwise, diaphragm protected gauges shall be provided with sintered metal snubbers or pulsation dampers.
- D. Diaphragm housing assembly shall be of durable stainless or cadmium plated with a 3/4 inch NPT process connection. The lower housing shall have a 1/4 inch NPT flushing connection and 1/4 inch NPT plug, to allow venting or the introduction of cleaning fluid on the process side of the diaphragm seal. The bottom housing shall be made of a material that is corrosion resistant and compatible with the process fluid. A clean out ring shall be provided to hold the diaphragm captive in the upper housing so that the assembly may be removed for

recalibration or cleaning of the process side without loss of instrument fluid. Diaphragm protected gauges and seals shall be ACCO Helicoid Diaphragm Seal Type 100 HACF, Ashcroft Diaphragm Seal Type 101, or equal.

2.06 GAUGE PROTECTION AND ACCESSORIES

- A. Unless otherwise shown or specified, pressure gauges shall have under pressure protection and vacuum gauges shall have overpressure protection. For helical roller type pressure gauges, the gauge shall have a left hand movement for under pressure protection; for all other gauges, under pressure protection stops shall be provided. For vacuum gauges with helical roller movement, gauges shall have right hand movement for overpressure protection; all other gauges shall have suitable overpressure protection stops.
- B. Unless otherwise shown or specified, all pressure, vacuum and compound gauges shall be provided with stainless steel sintered metal snubbers of porosity suitable for this service. Snubbers shall be ACCO Helicoid No. S-2 or S-4, Ashcroft Chemquip No. 1112S or equal.
- C. Diaphragm protected gauges for normal service shall be provided with rough plumbing 3/4 inch stop valves for shut-off cocks, and 3/4 inch red brass pipe. Valves shall have a bronze body, stainless steel ball, and teflon seats, valves shall have a spring-closing handle.
- D. Gauges other than diaphragm protected gauges shall be installed complete with incidental shut-off cock and tees with test cock with a female outlet. All pipe and fittings shall be brass. The gauge shall be mounted directly in the outlet of the tee-bearing test cock.

END OF SECTION

(THIS PAGE INTENTIONALLY LEFT BLANK)

SECTION 15140

PIPE HANGERS AND SUPPORTS

PART 1 GENERAL

1.01 SUMMARY

A. Section Includes

1. Furnish all labor, materials, equipment and incidentals required to install, and make completely ready for operation, pipe hangers, supports, concrete inserts, and anchor bolts including, metallic hanging and supporting devices as specified herein and as shown on the Drawings.

B. Related work

1. Section 03300 – Cast-In-Place Concrete
2. Section 09900 – Painting

1.02 REFERENCES

A. American Society of Mechanical Engineers (ASME)

1. ASME B31.1, Power Piping

B. Manufacturers Standardization Society Standard Practice (MSS-SP)

1. MSS-SP-58, Pipe Hangers and Supports, Materials, Design and Manufacture.
2. MSS-SP-69, Pipe Hangers and Supports, Selection and Application.

1.03 REQUIREMENTS

A. Design Requirements

1. The equipment specified herein is intended to support the various types of pipe and piping systems required for the Work.
2. The details shown on the Drawings are intended to indicate the generally desired methods of support under normal conditions.
3. All supports shall be designed to adequately secure the pipe against excessive dislocation due to thermal expansion and contraction, internal flow forces, and all probable external forces such as equipment, pipe, and personnel contact through 360 degrees in all three dimensions.
4. It shall be the responsibility of the Contractor to provide a Professional Mechanical Engineer licensed in the **State of Massachusetts**, with a minimum of 5 years of demonstrated experience in the design of supports and connections, to design the supports and connections for all equipment for all weights and applied pressures as indicated on the Drawings.
5. In the design of hangers, supports and anchors, pipe pressures shall be taken as the maximum rated pressure specified for pipe lines carrying gases and air and twice the maximum rated pressure specified for pipe lines carrying liquids.
6. Payment for such design services shall be included in the Prices bid for furnishing and installing pipe lines.

7. Hangers and supports shall be of approved standard design where possible and shall be adequate to maintain the supported load in proper position under all operating conditions.
8. All supporting equipment, with the exception of springs, shall be designed with a minimum working factor of safety of five based on the ultimate tensile strength of the material.
9. Where additional structural members are required, they shall be designed for the specific loads they are to support in accordance with the requirements of Massachusetts Building Code.

B. Performance Requirements

1. All hangers, supports and appurtenances shall conform to the latest requirements of the following listed references except as supplemented or modified by the requirements of this Specification.
 - a. ANSI B 31.1.
 - b. MSS-SP-58.
 - c. MSS-SP-69.

1.04 SUBMITTALS

A. In accordance with SECTION 01300.

1. Representative catalog cut for each different type of pipe hanger or support indicating the materials of construction, important dimensions and range of pipe sizes for which that hanger is suitable. Where standard hangers are not suitable, submit detailed drawings showing materials and details of construction for each type.
 2. Complete piping drawings indicating type of hanger, location, and magnitude of load transmitted to the structure. Submittals shall use detail numbers as shown on the Drawings to indicate type of support proposed wherever possible.
- B. Design computations shall not be submitted for review. Any design computations submitted shall be returned without comment. A design certificate shall be submitted prior to installation of any piping.

1.05 DELIVERY, STORAGE AND HANDLING

- A. All supports and hangers shall be crated, delivered and uncrated so as to protect against any damage.
- B. All parts shall be properly protected so that no damage or deterioration shall occur during a prolonged delay from the time of shipment until installation is completed.
- C. Finished iron or steel surfaces not galvanized or painted shall be properly protected to prevent rust and corrosion.

PART 2 PRODUCTS

2.01 MANUFACTURERS

- A. Unless otherwise specified herein, pipe hangers and supports shall be as manufactured by the following:

1. Grinnell Corp., Providence, Rhode Island.
 2. Carpenter & Patterson, Inc., Woburn, Massachusetts.
 3. F&S Central, Brooklyn, New York.
 4. Elcen Metal Products Co., Franklin Park, Illinois.
 5. Unistrut Northeast, Woburn, Massachusetts
- B. Any reference to a specific figure number of a specific manufacturer is for the purpose of establishing a type and quality of product and shall not be considered as proprietary. Any item comparable in type, style, quality, design and performance shall be considered as equal.
- C. The Drawings and Specifications indicate general and specific methods and details of supporting the various piping systems. Any changes to the support details shown shall be submitted to the Engineer for review.
- D. All uninsulated non-metallic piping such as PVC, fiberglass, etc. shall be protected from local stress concentrations, at each support point by galvanized steel protection shields or other method as approved by the Engineer where pipes are bottom supported 180 degree arc shields shall be furnished. Where 360 degree arc support is required, such as U Bolts, protection shields shall have a 50 mils minimum thickness, not be less than 12 inches in length and be securely fastened to pipe with stainless steel or galvanized metal straps not less than 1/2 inch wide.
- E. All insulated pipe shall be furnished with a rigid foam insulating saddle at each pipe support location as specified under insulation. Provide galvanized protection shields as specified in Paragraph 2.01D above at each location.
- F. Where pipe hangers and supports come in contact with copper piping provide protection from galvanic corrosion by the following:
1. Wrap pipe with 60 mils thick neoprene sheet material and galvanized protection shield.
 2. Provide isolators similar to Elcen figure number 228.
 3. Provide copper plated or PVC coated hangers and supports.
- G. Pipe supports shall be provided as follows:
1. Cast iron soil pipe: maximum support spacing of 5.0 feet with a minimum of one support per pipe section at the joints.
 2. Steel pipe: maximum support spacing of 10 feet with a minimum of one support per pipe section at the joints.
 3. Fiberglass pipe: as recommended by the manufacturer except that support spacing shall not exceed 5 feet.
 4. PVC pipe: as recommended by the manufacturer except that support spacing shall not exceed 3 feet. For pipe equal to or less than I inch in diameter and 5 feet for all other pipe sizes.
 5. Support spacing for steel pipe 2 inches and smaller and copper tubing shall not exceed 5 feet.
 6. Ductile iron pipe: maximum support spacing of 10 feet with a minimum of one support per pipe section at the joints.
 7. All vertical pipe shall be supported at each floor or at intervals of not more than 12 feet by approved pipe collars, clamps, brackets, or wall rests, and at all points necessary to insure rigid construction.
 8. Pipe supports shall not induce point loadings but shall distribute pipe loads evenly along the pipe circumference.

9. Effects of thermal expansion and contraction of the pipe shall be accounted for in the pipe support selection and installation.

2.02 SINGLE PIPE HANGERS

- A. Single pipes shall be supported by hangers suspended by galvanized steel rods from structural steel members, concrete ceilings and beams, bottom of trapeze hangers and wall mounted steel angle brackets.
- B. Hanger rods shall be hot rolled steel, machine threaded and galvanized after fabrication. The strength of the rod shall be based on its root diameter.
- C. Except as otherwise specified herein, pipe hangers shall be adjustable clevis type similar to Grinnell Figure Numbers 65, 260, and 590 as required. Hangers shall be carbon steel with a galvanized finish.
- D. Hanger rods shall be attached to concrete structures using concrete inserts similar to F&S Figures 180, 571 or 150. Inserts shall be malleable iron, or steel with galvanized finish. Beam damps, C clamps or welded beam attachments shall be used for attaching hanger rods to structural steel members. Where necessary and approved by the Engineer double expansion shields shall be used for attaching to concrete structures.
- E. Where pipes are near walls, beams, columns, etc. and located an excessive distance from ceilings or underside of beams, welded steel wall brackets similar to Carpenter and Patterson Figure numbers 69-68, 84 or 139 shall be used for hanging pipe. Brackets shall be galvanized. Where single pipes rest on top of bracket pipe supports, attachments shall meet requirements as specified under multiple pipe hangers.

2.03 MULTIPLE PIPE HANGERS

- A. Suspended multiple pipes, running parallel in the same horizontal plane, which are adjacent to each other shall be suspended by trapeze type hangers or wall brackets. Trapeze hangers shall consist of galvanized structural steel channel supported from galvanized threaded rod or attached to concrete walls, columns or structural steel support members as required to meet the intent of this specification. Channel shall be similar to F&S Figure 710, rods, concrete inserts, "C" Clamps, beam clamps, welded beam attachments, and expansion shields shall be as specified in 2.02 Single Pipe Hangers.
- B. Except as otherwise specified herein pipe anchors used for attaching pipe to trapeze or multiple pipe wall brackets shall be anchor or pipe chair similar to F&S Figures 158, 419, 160A, 160B as required. Materials of construction shall be galvanized steel. Chair "U" bolts shall be tightened to allow freedom of movement for normal expansion and contraction except when pipe must be anchored to control direction of movement or act as a thrust anchor.

2.04 SINGLE AND MULTIPLE PIPE SUPPORTS

- A. Single pipes located in a horizontal plane close to the floor shall be supported by one of the methods specified herein or as shown on the Drawings.

- B. Pipes 3-inch diameter and larger shall be supported by adjustable stanchions similar to F&S Figure 427, constructed of galvanized steel. Stanchions shall provide at least 4-inch adjustment and be flange mounted to floor,
- C. Pipes less than 3-inches in diameter shall be held in position by supports fabricated from steel "C" channel, welded post base similar to Unistrut Figure P2072A and pipe clamps similar to Unistrut Figures P1109 thru P1126. Where required to assure adequate support, fabricate supports using two vertical members and post bases connected together by horizontal member of sufficient load capacity to support pipe. Wherever possible supports shall be fastened to nearby walls or other structural member to provide horizontal rigidity. More than one pipe may be supported from a common fabricated support. All supports unless specified elsewhere shall be galvanized.
- D. Where required, pipe shall be supported using concrete anchor posts constructed in accordance with SECTION 03300. Pipe shall be securely fastened to concrete anchor posts using suitable metal straps as required and approved by the Engineer.

2.05 WALL SUPPORTED PIPES

- A. Single or multiple pipes located adjacent to walls, columns or other structural members shall whenever deemed necessary shall be supported using welded steel wall brackets similar to Carpenter and Patterson Figure numbers 69-78, 84, or 134; or "C" Channel with steel brackets similar to Unistrut pipe clamps. All members shall be securely fastened to wall, column, etc. using double expansion shields or other method as approved by the Engineer.
- B. Pipe shall be attached to supports using methods hereinbefore specified to meet the intent of this Specification.
- C. All supports shall be galvanized.

2.06 BASE ANCHOR SUPPORT

- A. Where pipes change direction from horizontal to vertical via a bend, a welded or cast base anchor support shall be installed at the bend to carry the load. The bend anchor shall be fastened to the floor with double expansion shields or other method as approved by the Engineer.
- B. Where shown on the Drawings, pipe bends shall be supported using concrete anchor posts. Pipes shall be securely fastened to concrete supports with suitable metal bands as required and approved by the Engineer.

2.07 VERTICAL PIPE SUPPORTS

- A. Where vertical pipes are not supported by a Unistrut system as specified in Paragraph 2.08, they shall be supported in one of the following methods.
 - 1. For pipes 1/4-inch to 2-inch in diameter, an extension hanger ring shall be provided with an extension rod and hanger flange. The rod diameter shall be as recommended by the manufacturer for the type of pipe be supported. The hanger ring shall be galvanized steel or PVC clad depending, on the supported pipe. The hanger ring shall be equal to

- Carpenter & Peterson Figure number 81 or 81CT. The anchor flange shall be galvanized malleable iron similar to Carpenter & Patterson Figure number 85.
2. For pipes equal to or greater than 1/2-inch in diameter extended pipe clamps similar to Carpenter and Patterson Figure number 267 may be used. The hanger shall be attached to concrete structures using double expansion shields, or to steel support numbers using welding lugs similar to Carpenter & Patterson Figure number 220.
 3. Pipe riser clamps shall be used to support all vertical pipes extending, through floor slabs. Riser clamps shall be galvanized steel similar to Carpenter & Patterson Figure number 126. Copper clad or PVC coated clamps shall be used on copper pipes. Insulation shall be removed from insulated pipes prior to installing riser damp.
 4. Unless otherwise specified, shown, or specifically approved by the Engineer, vertical runs exceeding 11 feet, pipes shall be supported by approved pipe collars, clamps, brackets or wall rests at all points required to insure a rigid installation.

2.08 SPECIAL SUPPORTS

- A. Pipe supports shall be provided for closely spaced vertical piping systems as shown on the Drawings or as otherwise required to provide a rigid installation. The support system shall consist of a framework suitably anchored to floors, ceilings and walls and be as manufactured by the Unistrut Corporation, Globe-Strut as manufactured by the Metal Products Division of U.S. Gypsum, or equal.
- B. Vertical and horizontal supporting members shall be U shaped channels similar to Unistrut Series P1000. Vertical piping shall be secured to the horizontal members by pipe clamps or pipe straps equal to Unistrut series P1100M and series P2558. All components shall be of mild steel.
- C. The assemblies shall be furnished complete with all nuts, bolts, and fittings required for a complete assembly including end caps for all members.
- D. The design of each individual framing system shall be the responsibility of the Contractor. Shop drawings, as specified above shall be submitted and shall show all details of the installation, including dimensions and types of supports. In all instances the completed frame shall be adequately braced to provide a complete rigid structure when all the piping has been attached.
- E. Any required pipe supports for which the supports specified in this Section are not applicable shall be fabricated or constructed from standard structural steel shapes in accordance with AISC Specifications, have anchor hardware similar to items previously specified herein, shall meet the minimum requirements listed below and be subject to the approval of the Engineer.
 1. Pipe support systems shall meet all requirements of this Section and all related Sections of the Specification.
 2. Complete design details of the entire pipe support systems shall be provided, for review by the Engineer.
 3. The pipe support system shall not impose loads on the supporting structures in excess of the loads for which the supporting structure is designed.

2.09 SURFACE PREPARATION AND SHOP PAINTING

- A. All surfaces shall be prepared and shop painted as part of the work of this Section. Surface preparation and shop painting shall be as specified in SECTION 09900.

PART 3 EXECUTION

3.01 INSTALLATION

- A. Pipe and appurtenances connected to the equipment shall be supported in a manner to prevent any strain from being imposed on the equipment or piping system.
- B. Pipe and tubing shall be supported as required to prevent damaging stresses in the pipe or tubing material, valves and fittings, and to support and secure the pipe in the intended position and alignment. Supports shall be sufficiently close together such that the sag of the pipe is within limits that will permit drainage and avoid excessive bending stresses from concentrated loads between supports.
- C. Pipes, horizontal and vertical, requiring rigid support shall be supported from the building structure by approved methods. Supports shall be provided at changes in direction and elsewhere as shown in the Drawings or specific herein. No piping shall be supported from metal stairs, ladders and walkways unless specifically directed or authorized by the engineer.
- D. Where flexible couplings are required at equipment, tanks, etc. the end Opposite to the piece of equipment, tank, etc. shall be rigidly supported.
- E. Pipe supports shall be installed to minimize, lateral forces through valves, both sides of split type couplings and sleeve type couplings, and to minimize all pipe forces on pump housings. Pump housings shall not be utilized to support connection pipes.

END OF SECTION

CERTIFICATE OF DESIGN FOR PIPE HANGERS AND SUPPORTS

(Owner)

Contract Reference: _____

_____, dated _____.

In accordance with the provisions of the above referenced Contract, as the designated Contractor,

(Contractor's Name and Address)

hereby certifies that _____

(Contractor's Name and Address)

- (1) Is properly licensed and currently registered as a Professional Engineer in the State (or Commonwealth) of _____;
- (2) Is fully qualified to design and supervise the _____

(Item of work and location)

In accordance with the provision specified under the appropriate Section and/or Subsections of the Contract Documents:

- (3) Has successfully designed and supervised _____

(Item of work)

before and demonstrates a minimum of ten (10) documented years of proven experience in such field;

- (4) Has personally examined the type(s) and locations(s) of the Work required under this Contract, and the overall conditions associated therewith, to the extent necessary to fully satisfy his or her professional responsibilities for designing and supervising the above referenced work;

- (5) Has prepared the attached design in full compliance with the applications and requirements of the Contract Documents, sound engineering practice, modern accepted principles of construction, and all applicable federal, state and local laws, regulations, rules and codes having jurisdiction over the Work;
- (6) Will provide sufficient supervision and technical guidance to the Contractor throughout the Work to ensure compliance with the design and all quality assurances necessary to successfully complete the Work;
- (7) Hereby indemnifies and holds harmless the _____
 _____ and BETA Group, Inc.,
 (name of owner)
 and their agents, employees and representatives, from and against any and all claims, whether directly or indirectly, arising out of, relating to or in connection with the Work; and
- (8) This "Certificate of Design" together with all applicable designs, drawings, details, specifications on other related documents necessary to complete the Work as specified, have been signed and sealed pursuant to applicable state law.

In recognition and observance of the above referenced statements, the undersigned parties hereby acknowledge and accept the responsibilities and obligations associated therewith.

CONTRACTOR:CONTRACTOR'S ENGINEER

(Contractor's Name)

(Engineer's Name)

By: _____

By: _____

(Name and Title)

(Name and Title)

Date: _____
(SEAL)

Date: _____
(P.E. STAMP)

(Note: Contractor to fully reference all attachments below)

END OF SECTION

SECTION 15400

PLUMBING

PART 1 GENERAL

1.01 SCOPE

- A. The Work of this section includes all labor, tools, material, fittings, accessories and equipment necessary to provide plumbing system(s), complete and operable.
- B. Attention is directed to the DOCUMENT 00700, GENERAL CONDITIONS and all sections within DIVISION 1 – GENERAL REQUIREMENTS, which are hereby made a part of this section of the Specifications.
- C. The Work includes, without limiting the generality thereof:
 - 1. Water supply system
 - 2. Domestic cold water distribution system.
 - 3. Domestic hot water and water heater.
 - 4. Natural gas supply system.
 - 5. Plumbing Fixtures.
 - 5. Floor drains.
 - 6. Hose bibs and wall hydrants.
 - 7. Sump pumps

1.02 SUBMITTALS

- A. Shop drawings, brochures and samples, as listed, shall be submitted for all items to be furnished in accordance with the provisions of DOCUMENT 01300, SUBMITTALS.
- B. Provide submittals for the following items consisting of manufacturer's published data. All submittals shall show compliance with the referenced specification.
 - 1. Water and drain piping and fittings
 - 2. Gas piping, fittings and specialties for a complete natural gas system.
 - 3. Hangers and supports
 - 4. Sleeves and escutcheons

5. Plumbing Fixtures
6. Plumbing specialties
7. Valves
8. Domestic water heater
9. Floor drains
10. Mixing valve
11. Cleanouts
12. Piping insulation
13. Sump pumps with wall bracket mounted float switches and control panels

1.03 RELATED WORK SPECIFIED ELSEWHERE

- A. SECTION 02220, EARTHWORK - Excavation, filling, sheeting, shoring, pumping, dewatering.
- B. SECTION 03300, CAST-IN-PLACE CONCRETE - for trench drains.
- C. SECTION 07002, ROOF AND FLASHING - for roof penetrations.
- D. SECTION 07841, PENETRATION FIRE STOPPING - for sleeves in floors and walls.
- E. SECTION 07920, JOINT SEALANTS – caulking for sleeves in floors and walls.
- F. SECTION 16120, WIRE AND CABLES - Power wiring.

1.04 ITEMS INSTALLED BUT NOT FURNISHED

- A. Install water meter as furnished by the Owner.

1.05 ITEM FURNISHED BUT NOT INSTALLED

- A. Furnish pipe sleeves for placement in concrete and masonry construction.

1.06 DESIGN CRITERIA

- A. The Work of this section shall comply with the requirements of the Massachusetts Uniform Plumbing Code (248 CMR) and of any other authorities having jurisdiction.
- B. The equipment covered by the Specifications is intended to be standard equipment of proven quality as manufactured by reputable concerns. Equipment shall be designed, constructed and installed in accordance with the best practice of the industry and shall

operate satisfactorily when installed in accordance with the Contract Documents. The Specifications call attention to certain details, but do not purport to cover all details entering into the construction of the equipment.

- C. All material shall be new and shall bear the manufacturer's full identification.
- D. Requirements of the Regulatory Agencies
 - 1. The final, complete installation shall comply with all state and local statutory requirements having jurisdiction. Arrange for all necessary permits, pay all fees and arrange for all required inspections by local authorities. In general, all Work shall comply with the requirements of the rules, regulations, standards, codes, ordinances and laws of local, state and federal governments, and other authorities that have legal jurisdiction over the Project. Materials and equipment shall be manufactured, installed and tested as specified in latest editions of applicable publications, standards, rulings and determinations of:
 - a. Local and state building, plumbing, mechanical, electrical, fire and health department codes.
 - b. American Gas Association (AGA).
 - c. National Fire Protection Association (NFPA).
 - d. Occupational Safety and Health Act (OSHA).
 - e. Underwriter's Laboratories (UL).
 - f. Material and equipment shall be listed by Underwriter's Laboratories (UL) and approved by ASME and AGA for intended service.
 - 2. When requirements cited in the Specifications conflict with each other or with Contract Documents, most stringent shall govern Work.
 - 3. Most recent editions of applicable specifications and publications of the following organizations form part of Contract Documents:
 - a. American National Standards Institute (ANSI).
 - b. American Society of Mechanical Engineers (ASME).
 - c. National Electric Manufacturers Association (NEMA).
 - d. American Society for Testing and Materials (ASTM).
 - e. American Water Works Association (AWWA).
 - f. American Society for Heating, Refrigerating and Air Conditioning Engineers (ASHRAE).

- g. American Society of Plumbing Engineers (ASPE).
- h. Thermal Insulation Manufacturers Association (TIMA).
- i. Institute of Electrical and Electronics Engineers (IEEE).
- j. Insulated Cable Engineers Association (ICEA).
- k. Cast Iron Soil Pipe Institute (CISPI).
- l. Plumbing and Drainage Institute (PDI).
- m. National Association of Plumbing-Heating Cooling Sub-Contractors (NAPHCC).

1.07 PRODUCT HANDLING

- A. All materials and equipment shall be shipped, stored, handled and installed in such manner as not to degrade quality, serviceability, or appearance.
- B. Store all materials and equipment on site in a location approved by the Engineer.
- C. Protect all Work, the Owner's property and the property of others from injury or loss caused by operations associated with the Work of this section. Make good any such injury or loss, at no cost to the party suffering the injury or loss.

1.08 PROCEDURE

- A. Secure all permits, inspection, and approvals and pay all costs and fees.
- B. Unless the Specifications state "No Substitutions", substitutions will be considered for any specified item.
- C. Coordinate safety program with that of the Contractor. Cooperate with other trades to establish lines, levels, openings, chases, clearances, and locations to avoid interference, and to protect the Work.
- D. Deliver all materials as needed to avoid delaying any other contractor.
- E. Store all materials and equipment on the Project Site in a location approved by the Engineer.

1.09 INTERPRETATION OF DRAWINGS

- A. Listing of Contract Drawings does not limit responsibility of determining full extent of Work required by Contract Documents. Refer to Architectural, Plumbing, Electrical, Structural and other Contract Drawings and other sections that indicate types of

construction in which Work shall be installed and Work of other trades with which Work of this section must be coordinated.

- B. Except where modified by a specific notation to the contrary, it shall be understood that the indication and/or description of any item, in the Contract Drawings or Specifications or both, carries with it the instruction to provide the item, regardless of whether or not this instruction is explicitly stated as part of the indication or description.
- C. Item referred to in singular number in Contract Drawings shall be provided in quantities necessary to complete Work.
- D. Contract Drawings are diagrammatic. They are not intended to be absolutely precise; they are not intended to specify or to show every offset, fitting and component. The purpose of the Contract Drawings is to indicate a systems concept, the main components of the system, and the approximate geometrical relationships, the Subcontractor shall provide all other components and materials necessary to make the systems fully complete and operational.
- E. Information and components shown on riser diagrams but not shown on the Contract Drawings and vice versa, shall be provided as if expressly required on both.
- F. Data that may be furnished electronically by the Engineer (on computer tape, diskette, or otherwise) is diagrammatic. Such electronically furnished information is subject to the same limitation of precision as heretofore described. If furnished, such data is for convenience and generalized reference, and shall not substitute for Engineer's sealed or stamped construction documents.

1.10 DISCREPANCIES IN DOCUMENTS

- A. Where Contract Drawings or Specifications conflict or are unclear, advise the Engineer in writing before Award of Contract. Otherwise the Engineer interpretation of Contract Documents shall be final, and no additional compensation shall be permitted due to discrepancies or incongruities thus resolved.
- B. Where Contract Drawings or Specifications do not coincide with manufacturers' recommendations, or with applicable codes and standards, alert the Engineer in writing before installation. Otherwise, make changes in installed Work as the Engineer requires at no additional cost to the Owner.
- C. If the required material, installation or Work can be interpreted differently from drawing to drawing, or between Contract Drawings and Specifications, the Subcontractor shall provide that material, installation, or Work which is of the higher standard.
- D. Provide systems and components that are fully complete and operational and fully suitable for the intended use. There may be situations in the Contract Documents where insufficient information exists to precisely describe a certain component or subsystem, or the routing of a component. In cases such as this, where the Subcontractor has failed to notify the Engineer of the situation in accordance with the Specifications, the Subcontractor shall provide the specific component or subsystem with all parts necessary

for the intended use, fully complete and operational, and installed in workmanlike manner either concealed or exposed per the design intent.

- E. In cases covered by the Contract Documents, where the Subcontractor needs engineering guidance, submit a sketch identifying the proposed solution to the Engineer for approval.

1.11 MODIFICATIONS IN LAYOUT

- A. HVAC, Plumbing, and Electrical Drawings are diagrammatic. They indicate general arrangements of mechanical and electrical systems and other Work. They do not show all offsets required for coordination nor do they show the exact routings and locations needed to coordinate with structure and other trades and to meet Architectural requirements.
- B. In all spaces, prior to installation of visible material and equipment, including access panels, review Architectural Drawings for exact locations and where not definitely indicated, request information from the Engineer.
- C. Check Contract Drawings as well as Shop Drawings of all trades to verify and coordinate spaces in which Work of this section will be installed.
- D. Maintain maximum headroom at all locations. All piping and associated components to be as tight to underside of structure as possible.
- E. Make reasonable modifications in layout and components needed to prevent conflict with Work of other trades and to coordinate as specified herein. Systems shall be run in a rectilinear fashion.
- F. Where conflicts or potential conflicts exist and engineering guidance is desired, submit sketch of proposed resolution to the Engineer for review and approval.

1.12 RECORD DRAWINGS

- A. Refer to SECTION 01700, CONTRACT CLOSEOUT for record drawing requirements.
- B. As Work progresses and for duration of Contract, maintain complete and separate set of prints of Contract Drawings at Project Site at all times. Record Work completed and all changes from original Contract Drawings clearly and accurately including Work installed as a modification or addition to the original design.
- C. At Completion of Work prepare a complete set of reproducible record drawings.
- D. The Engineer will not certify the accuracy of the record drawings; this is the sole responsibility of the Contractor.
- E. Submit the record set for approval by the building department in a form acceptable to the department, when required by jurisdiction.

- F. Record drawings shall show record condition of details and corrections to schedules. Schedules shall show actual manufacturer and make and model numbers of final equipment installation.

1.13 MATERIAL LIST

- A. Within 4 weeks of Award of Contract, the Subcontractor through the Contractor shall submit a "Plumbing Equipment and Material List".
- B. The list shall contain all categories of material required with names of intended manufacturers. The list does not replace submittals specified herein.

1.14 WARRANTIES

- A. Submit manufacturer's standard replacement warranties for material and equipment furnished under this section. Such warranties shall be in addition to and not in lieu of all liabilities, which the manufacturer and the Subcontractor may have by law or by provisions of the Contract Documents.
- B. All materials, equipment and Work furnished under this section shall be guaranteed against all defects in materials and workmanship for a minimum period of one year commencing with the Date of Substantial Completion. Any failure due to defective material, equipment or workmanship which may develop shall be corrected at no expense to the Owner including all damage to areas, materials and other systems resulting from such failures.
- C. Guarantee that all elements of each system meet the specified performance requirements as set forth herein or as indicated on the Contract Drawings.
- D. Upon receipt of notice from the Owner of the failure of any part of the systems during the guarantee period, the affected parts shall be replaced. Any equipment requiring excessive service shall be considered defective and shall be replaced.

1.15 SURVEY AND MEASUREMENTS

- A. Base all required measurements, horizontal and vertical, from referenced points established by the Contractor and be responsible for correctly laying out the Work required under this section of the Specifications.
- B. In the event of discrepancy between actual measurements and those indicated, notify the Contractor, in writing, and do not proceed with the related Work until instructions have been issued.

1.16 DELIVERY, STORAGE AND HANDLING

- A. Provide in accordance with Section 01600 MATERIALS AND EQUIPMENT.
- B. All manufactured materials shall be delivered to the Project Site in original packages or containers bearing the manufacturer's labels and product identification.

- C. Protect materials against dampness. Store off floors, under cover, and adequately protected from damage.
- D. Deliver products to the Project Site and store and protect same as recommended by the manufacturers'.
- E. Inspect all Plumbing equipment and materials, upon receipt at the Project Site, for damage and correctness.

1.17 PROTECTION OF WORK AND PROPERTY

- A. Care and protect all Work included under this section until it has been tested and accepted.
- B. Protect all equipment and materials from damage from all causes including theft. All materials and equipment damaged or stolen shall be repaired or replaced with equal material or equipment.
- C. Protect all equipment, outlets and openings with temporary plugs, caps and covers. Protect work and materials of other trades from damage that might be caused by Work or workmen under this section and make good damage thus caused.

1.18 SUPERVISION

- A. Supply the service of an experienced and competent supervisor who shall be in charge of the plumbing work at the Project Site.

1.19 SAFETY PRECAUTIONS

- A. Comply with all of the safety requirements of OSHA throughout the entire construction period of the Project.
- B. Provide and maintain proper guards for prevention of accidents and any other necessary construction required to secure safety of life and/or property.

1.20 SPARE PARTS

- A. Furnish spare parts data for each different item of equipment furnished. The data shall include a complete list of parts and supplies, with current unit prices and source of supply; a list of parts and supplies that are either normally furnished at no extra cost with the purchase of the equipment, or specified hereinafter to be furnished as part of the contract; and a list of additional items recommended by the manufacturer to assure efficient operation for a period of 180 days at the particular installation. The foregoing shall not relieve the Subcontractor of any responsibilities under the guarantees specified herein.

1.21 HOISTING, SCAFFOLDING AND PLANKING

- A. The Work shall include the furnishing, set-up and maintenance of all derricks, hoisting machinery, scaffolds, staging, planking, ladders, etc. as required for the Work.

1.22 SLEEVES, INSERTS, ANCHOR BOLTS, AND PLATES

- A. Be responsible for the location of and the maintaining in proper position all sleeves, inserts and anchor bolts supplied and/or set in place. In the event that failure to do so requires cutting and patching of finished work, it shall be done at this Subcontractor's expense without any additional cost to the Owner.

1.23 SUPPLEMENTARY STEEL, CHANNELS AND SUPPORTS

- A. Provide all supplementary steel, channels and supports required for the proper installation, mounting and support of all plumbing equipment, piping, etc., required by the Specifications.
- B. Supplementary steel and channels shall be firmly connected to building construction in a manner approved by the Engineer.
- C. The type and size of the supporting channels and supplementary steel shall be determined by the Sub-contractor and shall be of sufficient strength and size to allow only a minimum deflection in conformance with the manufacturer's requirements for loading.

1.24 CERTIFICATES OF INSPECTION/APPROVAL

- A. Furnish upon completion of all Work, certificates of inspections from the manufacturers stating that authorized factory engineers have inspected and tested the operation of their respective equipment and found same to be in satisfactory operating conditions.

1.25 ACCESSIBILITY

- A. All Work shall be installed so that parts requiring inspection, operation, maintenance and repair are readily accessible. Minor deviations from the drawings may be made to accomplish this, but changes of substantial magnitude shall not be made prior to written approval from the Engineer.

1.26 DEFINITIONS

- A. As used in this section, the following terms are understood to have the following meanings:
 - 1. "Furnish" shall mean purchase and deliver to the project site, complete with every necessary accessory and support.
 - 2. "Install" shall mean unload at the delivery point at the site and perform all work necessary to establish secure mounting, proper location and operation in the project.
 - 3. "Provide" shall mean furnish and install.
 - 4. "Work" shall mean all labor, materials, equipment, apparatus, controls, accessories, and all other items required for a proper and complete installation.

5. "Piping" shall mean, in addition to pipe or tubing, all fittings, flanges, unions, valves, strainers, drains, hangers and other accessories relative to such piping.
6. "Concealed" shall mean hidden from sight in chases, furred spaces, shafts, embedded in construction or in crawl space.
7. "Exposed" shall mean not installed underground or concealed as defined above.
8. "Furnished by others" shall mean materials or equipment purchased and set in place under other sections of the general contract and connected to the systems covered by this section of the specifications by this trade contractor.
9. "Coordinate" shall mean all work provided under this section of the specification shall be in compliance with work of other trades.

PART 2 MATERIALS

2.01 WATER PIPE AND FITTINGS

- A. Above floor piping shall be Type L copper tubing, ASTM B88, hard tempered, with wrought copper fittings and unions, joints made up with 95/5 tin antimony solder and non-corrosive flux.
- B. Under ground and under slab piping shall be Type K copper tubing, soft annealed copper tubing with ANSI B16.18 or ASME B16.22 solder joint fittings. Provide minimum number of joints in buried copper tubing. Joints shall be brazed. Brazing filler metal shall conform to AWS A5.8, Type BAg-5 with AWS Type 3 flux, except Type BCuP-5 or BCuP-6 may be used for brazing copper-to-copper joints. Braze joint fittings shall be specifically designed for brazing.

2.02 DRAIN WASTE AND PUMPED DISCHARGE PIPE AND FITTINGS

- A. Below grade shall be service weight cast iron soil pipe and fittings, ASTM A74, coated with tar or asphaltum, resilient gasket joints.
- B. Above grade shall be service weight cast-iron with no hub joints, except piping two inch or smaller may be schedule 40 galvanized steel with 150 lb. galvanized malleable iron drainage fittings, or type DWV copper with wrought copper drainage fittings.
- C. Pumped discharge piping shall be schedule 40 galvanized steel with Class 125 galvanized cast iron fittings. Piping and fittings shall be joined by threaded connections.
- D. Cleanouts
 1. ANSI A112.36.2M; provide threaded bronze cleanout plugs.
 2. Floor Cleanouts

- a. Provide cast-iron or ductile-iron floor cleanout with anchor flange, adjustable height polished bronze, nickel bronze, stainless steel, or chromium-plated copper alloy rim and scoriated floor plate with "CO" cast in the plate, and countersunk screws for installing floor plate flush with finished floor.

2.03 NATURAL GAS PIPING AND GAS RELIEF VENTS

- A. 2 inches and smaller shall be Schedule 40 black steel pipe with malleable iron threaded cast fittings ASTM B16.3, Class 150.
- B. 2-1/2 inches and larger shall be schedule 40 black steel pipe in accordance with ASTM A.53 with butt welding fittings in accordance with ANSI B16.9.
- C. Gas piping at equipment shall be provided with additional supports.
- D. All work shall be installed in strict accordance with the Massachusetts State Gas Code.
- E. Welders Qualifications (Natural Gas System): Qualifications of the procedure and of the welding operations and welders shall be as specified in American Welding Society, AWS D10.9-80, "Specification for Qualification of Welding Procedures and Welders for Pipe and Tubing"; ANSI B31.1 and ASME Boiler Code, Section 1X.
 1. The contractor shall provide certification in writing that the operator or welder has met the above prescribed standard. The owner reserves the right to radio graphically test a minimum of 5% of the welds.

2.04 HANGERS AND SUPPORTS

- A. Pipe hangers shall conform to MSS SP 58 and SP 69. Pipe hangers for piping 4 inch and larger shall have rolls either of the Harvard type or 2 rod type. Pipe hangers for 3 inch pipe and under shall be clevis type. Pipe hangers for pipe less than 2 inch may be 1A band type in lieu of clevis type. Hangers in contact with copper tubing shall be copper plated.
- B. All hangers on insulated piping shall be sized to fit the outside of the covering. Provide spacer blocks and 16 gauge galvanized protection shields (12 inches long) at hangers, when pipe is installed.
- C. All hanger rods shall be hung from wood frame ceiling structure using wood screws designed for use with threaded rod adapters or through-bolted with double nuts and flat washers.
- D. Where support points are required to avoid other Work, provide a system of channels and angles between support points as required. Provide all necessary supports and cross framing. No part of piping, ductwork, equipment, and the building shall be stressed beyond its normal allowable working strength.
- E. Gas piping installed on the roof shall be set on rubber pipe supports as manufactured by "The Rubber Triangle Co." or an approved equal.

2.05 SLEEVES

- A. Sleeves shall be sized to allow 1/2 inch of annular space between the covering (or bare pipe) and the inside of the sleeve.
- B. Pipe penetrations through floors and exterior walls shall be sleeved and sealed using Thunderline Link-Seal wall sleeves and seals or approved equal.
- C. In other areas, pack the annular space with non-combustible (as defined by ASTM E136) fire stopping material, and seal with non-combustible caulking flush with finish surface.
- D. Sleeves in concrete construction shall be galvanized steel pipe, except where passing through exterior walls they shall be ductile iron. Sleeves passing through floors shall project 1 inch above the finish floor. Sleeves in frame and dry wall construction shall be 18 gauge galvanized steel sheet metal.
- E. Provide escutcheons at all exposed pipe penetrations in finished areas. Escutcheons shall be chrome plated, sized to cover the sleeve, with set screw.

2.06 PLUMBING SPECIALTIES

- A. Pressure reducing valves shall be Watts, U5BLP (or 223 SB) with integral removable stainless steel strainer, nickel alloy seat, and bronze body. Provide a 0-100 psi pressure gauge immediately downstream of the valve.
- B. Relief valves (for hot water heaters) shall be combination pressure/temperature relief valves, AGA rated and ASME labeled.
- D. Reduced pressure backflow preventers shall be Watts Series 909, Hersey Beeco, ITT Lawlor, or approved equal bronze body reduced pressure zone back flow type, 175 psi maximum working pressure, complete with replaceable seats, strainer, test cocks, shut off valves, union ends, and air gap fitting. Backflow preventers shall be ASSE, AWWA, and FCCCHR or USC approved.
- E. Vacuum breakers: Shall be provided in all domestic water heater cold water inlets, in hose bibb and wall hydrant outlets, and in all other locations specified and as directed by the authority having jurisdiction.
- F. Water hammer arrestors shall be certified per PDI Standard WH-201 and have stainless steel shell and bellows, 250 psi rated as manufactured by Josam, Zurn, J.R. Smith, or approved equal.
- G. Provide dielectric couplings at all ferrous to non-ferrous joints.
- H. Pressure gauges shall be ASME B 40.1, liquid filled type, 1% accuracy or better, minimum 2 1/2 inch diameter casing, 0 to 100 psig range, with ball valve shutoff and snubber.

2.07 VALVES

- A. Gate Valves 2 inch and Smaller: MSS SP-80, Class 125, with bronze body and integral bronze seat, rising stem, screwed bonnet, solid wedge disk, and threaded ends as manufactured by Jenkins, Crane, Stockham, or approved equal.
- B. Ball Valves 2 inch and Smaller: MSS SP-110, 150 psi WSP, with 2 piece bronze body, PTFE seats and seals, full port, blowout proof pressure retaining stem, threaded ends, and vinyl covered carbon steel quarter-turn lever handle. Provide stainless steel ball and stem, with stem extension to accommodate thickness of pipe insulation.
- C. Check Valves 2 inch and Smaller: MSS SP-80, Class 150, with bronze body, swing check, thread-in cap, and threaded ends, designed for horizontal or vertical mounting.
- D. Gas Valves Interior
 - 1. Ball Valves: Ball valves shall be the fire-seal type, conforming to UL 842 and UL 125.
 - 2. Valves shall be rated for service at not less than 200 psi at 200 degrees F.
 - 3. Valve bodies in sizes 1-inch ips and smaller shall be screwed-end type constructed of ductile iron, carbon steel, or cast steel.
 - 4. Valve bodies in sizes 1-1/4-inch ips and larger shall be flanged-end type constructed of ductile iron, carbon steel, or cast steel unless otherwise specified.
 - 5. Valve bodies shall have socket weld ends or butt weld ends where indicated to be welded, and body shall be constructed of carbon steel or cast steel.
 - 6. Balls and stems shall be Type 316 corrosion-resistant steel.
 - 7. Valves shall be suitable for flow from either direction and shall seal tightly in either direction.
 - 8. Valves shall have full pipe size flow areas where indicated.
 - 9. Valve seats and seals shall be tetrafluoroethylene; seats shall have secondary corrosion-resistant steel seating surfaces to effect shutoff should resin be burned out.

2.08 MIXING VALVE

- A. Mixing valves shall be of lead free brass body constructions with thermal actuator, adjustable temperature selection with lock down, union connections, integral checks and screens. Provide Powers model LFLM490 or approved equal by Symmons or Lawler.

2.09 PLUMBING FIXTURES

A Water Closet (P-1)

1. Sloan, Toto, American Standard, or approved equal.
 - a. Fixture: SLOAN model ST-2059-A elongated wall hung, vitreous china, 1.28 gpf siphon jet bowl with 1-1/2 inch top spud.
 - b. Flushometer: SLOAN Solis model 8111-1.28, 1.28GPF Automatic Flush Valve
 - c. Seat: Church
 - d. Support: Jay R. Smith Series 200, Watts ISCA-131D, or Zurn 1203-N4.

B. Lavatory (P-2)

1. Sloan, Toto, American Standard or approved equal.
 - a. Fixture: SLOAN model SS3004, 20 inch x 27 inch wall hung, vitreous china and 4 inch centers.
 - b. Faucet: Sloan Solis EAF-275-ISM with 4 inch cover plate and 10 second time-out.
 - c. Offset Drain: American Standard 7723.018 1-1/4 off set drain.
 - d. Supports: Jay R Smith series 0700 (-27-M31) concealed arms.
 - e. Miscellaneous: Stops, supplies, p-trap and handicap insulators.

C. Hose Bibb (HB)

1. Hose Bibbs shall be 1/2 inch size X 3/4" garden hose connection, polycarbonate or metallic handle, female 1/2" NPT inlet with wall mounting flange, male hose thread outlet complete with bronze vacuum breaker. Hose bibb shall have rough chrome finish. Support hose bibb supply pipe 3" max above mounting height of hose bib.

D. Nonfreeze Wall Hydrant (WH)

1. ASSE 1019, cast bronze, with lockshield and handwheel, 3/4" male IPS inlet, 0.75 inch external hose thread outlet with automatic draining vacuum breaker. Hydrant shall be of sufficient length to extend through walls and place the valve seat inside the building. Bonnet and valve stem shall be removable from outside of the building. Wall hydrant shall be installed so that water can drain to the exterior when valve is closed.

2.10 FLOOR DRAINS AND ELECTRONIC TRAP PRIMERS

A. General: Floor drains shall be Froet, Jay R. Smith, Josam, Zurn, or approved equal. Manufacturer's catalog numbers specified herein for drains are intended only as a guide for the type and quality to be furnished under this Section of the Specifications.

1. Floor Drain "A" (FD "A" Finished Areas) shall be equal to Jay R. Smith Figure

#2005Y-A-B-P050 with sediment bucket and trap primer connection.

2. Floor Drain "B" (FD "B" Mechanical Rooms) shall be equal to Jay R. Smith Figure #2130-B-U-PB-P with sediment bucket, trap primer connection and ductile iron grate.

B. General: Electronic trap primers shall be PPP Inc, Zurn, Sioux Chief, or approved equal. Manufacturer's catalog numbers specified herein for trap primers are intended only as a guide for the type and quality to be furnished under this Section of the Specifications.

1. Electronic Trap Primer (ETP) shall be equal to PPP Inc MPB-500-115V mini-prime electronic trap priming manifold with box, 120V, single phase, integral stainless steel screen, solenoid valve, 1 inch air gap, and ½ inch inlet and outlet. Install per manufacturer's requirements and recommendations.

2.11 PIPING INSULATION

A. General

1. The pipe covering specified herein for piping system shall be provided to strict accordance with the manufacturer's printed instructions, the best practice of the trade and to the full intent of this Specification.
2. Flame/Smoke Ratings: Provide complete fibrous glass pipe insulation (insulation, jackets, coverings, sealers, mastics and adhesives) with flame spread index of 25 or less, and smoke developed index of 50 or less, as tested by ASTM E 84 (NFPA 255) method.
3. Manufacturer: Subject to compliance with requirements, provide products of Armstrong World Industries, Inc., Knauf Fiber-Glass, Owens Corning or approved equal.
4. Apply insulation after systems have been tested, proved tight and approved by Architect. Remove dirt, scale, oil, rust and foreign matter prior to installation of insulation.
5. No leaks in vapor barrier or voids in insulation will be accepted.
6. Insulation and vapor barrier on piping which passes through walls or partitions shall pass continuously through sleeve, except that piping between floors and through fire walls or smoke partitions shall have space allowed for application of approved packing between sleeves and piping, to provide firestop as required by NFPA. Seal ends to provide continuous vapor barrier where insulation is interrupted.

B. Interior Cold, Hot Water, and Non-Potable Water Systems:

1. 1 inch thickness fiberglass piping insulation (hot water pipe size up to 1½ inch)
2. 1½ inch thickness fiberglass piping insulation (hot water pipe size 2 inch and

above)

- a. ASTM E-547, Class I
3. Fire retardant foil face jackets for piping insulation: ASTM C-921, Type I for piping with temperatures below ambient, Type II for piping with temperatures above ambient. Type I may be used for all piping at installation option.
4. Encase piping fittings insulation with one piece premolded PVC fitting covers, fastened as per manufacturer's recommendations.
5. Staples, Bands, Wires, and Cement: As recommended by insulation manufacturer for applications indicated.

2.12 ELECTRIC WATER HEATER

- A. Electric water heater shall be as manufactured by RHEEM, State, Bradford-White, or approved equals.
- B. EW-1: Water heater shall be model EGSP-10, manufactured by RHEEM, having electrical input of 3KW, 480V, 1 phase and a recovery rate of 12 GPH at a 100°F temperature rise. Water heater shall have a storage capacity of 10 gallons. Water heater shall have the UL seal of certification and be factory equipped with an AGA/ASME rated temperature and pressure relief valve. Tank interior shall be coated with a high temperature porcelain enamel and furnished with an R-Tech resistored magnesium anode rod rigidly supported. Water heater shall meet or exceed the energy factor requirement of ASHRAE. Tanks shall have working pressure rating of 150 psi, and shall be completely assembled. Water heater shall be equipped with copper, resistored, "screw-in" type elements. Tanks shall be insulated with 2 ½" of rigid polyurethane foam insulation. Water heater shall be equipped with surface mounted thermostat each with an integral, manual reset, high limit control. Water heater shall be covered by a three year limited warranty against tank leaks. Included shall be ELBI DTS-8, 2 gallon thermal expansion tank.

2.13 SUMP PUMPS

- A. This Plumbing Contractor shall furnish and install two 2 inch submersible sump pumps as shown on the drawings. The sump pumps shall have a capacity of 20 GPM against a TDH of 40 feet. The sump pump shall be WEIL model 2443 series 2400, or approved equal by Liberty or Zoeller.
 1. Motors shall be not less than 1/2 HP, 480 volts, 3 phase, 3450 RPM.
 2. Pumps shall have a 20 foot cord.
 3. Motor(s) shall be housed in watertight cast iron shell. Oil filled motors will not be considered equal. Motor(s) shall have Class 'F' insulation and permanently lubricated double seal ball bearings. Motor(s) using sleeve type bearing will not be considered equal. Mating surfaces between the motor and bell, motor shell and seal housing shall be sealed by means of 'O' rings. The motor shaft shall be Series

300 stainless steel with keyway for positive positioning of the impeller. Carbon steel and 400 series stainless steel shafts are not considered equal.

4. Impeller shall be multi-vane, semi-open type and accurately machined to the proper diameter. The impeller is to be trimmed to suit job conditions and then dynamically balanced.
5. Controls to include:
 - a. 3-Float switches suspended from wall bracket
 - b. 1-8111 NEMA 4X Simplex control panel to include:
 - 1) Comb. Manual disconnect switches & motor circuit protectors
 - 2) Magnetic starters
 - 3) H/O/A Selector switches
 - 4) On/Off Pilot lights
 - 5) Control circuit transformer
 - 6) Alarm bell with silencer
 - 7) Numbered & wired terminal strip
 - 8) Set of isolated dry contacts for remote alarm.
 - 9) Through door main disconnect switch.
6. Pit by others

PART 3 EXECUTION

3.01 OPENINGS

- A. The responsibility for determining the exact size and location of openings is part of the Work of this section. If this responsibility is not met, cutting and patching to achieve the correct size and location of openings and chases is part of the Work of this section.

3.02 CUTTING AND PATCHING

- A. Do all cutting and patching required for the Work of the section, except cutting and patching of finish (visible) materials. Cutting and patching of masonry walls, partitions, ceilings and floors is included. Concrete cutting shall be done with abrasive wheels or saws, and coring with a diamond core bit. The use of jackhammers is prohibited.

3.03 INSTALLATION OF EQUIPMENT

- A. Equipment shall be installed in strict accordance with manufacturer's instructions, unless otherwise specified herein, or on the Contract Drawings. In case of discrepancies, contact the Engineer for instructions.

3.04 INSTALLATION OF PIPING

- A. Provide a shutoff valve on each pressure piping connection at each item of equipment, except vent and overflow connections.
- B. Do not install valves with the stem below horizontal.
- C. Provide a union or flange at each connection at each item of equipment.
- D. Install piping parallel to or perpendicular to the lines of the building.
- E. Pitch all pressurized water piping up 1 inch in 80 feet or run dead level and provide an air vent every 40 feet.
- F. Installation of Natural Gas Piping
 - 1. General: Install natural gas piping as shown on the drawings in accordance with the State of Massachusetts Uniform Plumbing/Gas Code as follows:
 - a. Unless otherwise indicated, gas piping shall be run exposed. Where concealed piping is indicated, it shall be installed in a location to permit access to the piping with a minimum amount of damage to the building.
 - b. The connection to the gas piping at the meter installation shall be in accordance with local gas utility requirements. Gas piping shall begin at the outlet of the regulator and shall run to the connection at all gas fired equipment.
 - c. The gas supply pipe shall be of the size indicated on the drawings.
 - d. Joints shall be made with graphite and oil or an approved graphite compound applied to the male thread only. After cutting, and before threading, pipe shall be reamed and all burrs shall be removed. Threads shall be accurately cut, and not more than three threads shall remain exposed outside each fitting after the joint has been made up. Each length of pipe shall be hammered and all scale shall be blown out before assembling. Threaded joints shall not be caulked to prevent or stop leaks.
 - e. An approved type gas cock shall be installed at the base of each riser, and near each appliance. Plugged or capped outlets for future extensions or connections shall be provided where noted on drawings.
 - f. Piping shall be graded not less than 1-inch in 40 feet of length to prevent trapping. Horizontal lines from the meter to the risers shall grade down toward the risers and branches from risers to appliances shall grade up toward the risers and branches from risers to appliances shall grade up toward the appliances.
 - g. A full size tee fitting and a 6-inch long capped drip pocket shall be installed at the bottom of each riser or drop and at each low point in a horizontal gas line.

- h. Uncovered, exposed pipes shall be provided with plates at the point where they pass through floors, finished walls, and finished ceilings. Where necessary to cover beads of fittings, special deep escutcheons shall be provided in lieu of plates. Plates shall be not less than 0.018-inch thick. Wall and ceiling plates shall be secured with round head set screws, not with spring clips. Unless otherwise specified, plates shall be of the one-piece types. Wall and ceiling plates may be flat, hinged pattern.
 - i. (As applicable) Exterior gas piping shall have a cover of 30 inches and shall be a minimum of 3 feet from other structures such as other site piping.
 - j. (As applicable) Connections between metallic and plastic piping shall be made only underground, exterior and with an approved transition fitting.
2. Installation of Valves
- a. Gas Valves: Provide and install gas valves at connection to gas train for each gas-fired equipment item; and on risers and branches where indicated on the drawings. Locate gas valves where easily accessible and where they will be protected from possible injury.
 - b. Pressure Regulating Valves: Install pressure regulating valves in accordance with local utility company's requirements and manufacturer's installation instructions. Install gas shutoff valve upstream of each pressure regulating valve.
3. Equipment Connections
- a. General: Connect gas piping to each gas-fired equipment item, with drip leg (in heated spaces) and shutoff gas cock. Comply with equipment manufacturer's instructions. Drip legs shall not be installed on the exterior of the building.
4. Testing
- a. General: Inspect, test, and purge natural gas systems in accordance local code requirements and NFPA 54 requirements and as follows.
 - 1) Visually examine natural gas system after installation.
 - 2) Pressure test natural gas system with dry air or nitrogen at 100 psig for 2 hours. Soap test all joints to detect leaks.
 - 3) Flush and purge natural gas system and charge with gas in accordance with local utility requirements and NFPA 54.

3.05 CLEANING

- A. Clean all debris resulting from the work of the section, and remove it from the Project Site, daily.
- B. Close pipe openings with caps or plugs during installation. Tightly cover and protect fixtures and equipment against dirt, water and chemical or mechanical injury. At completion of all Work, thoroughly clean all fixtures, exposed materials and equipment.

3.06 TESTS

- A. Test water piping at 100 psi hydrostatic pressure before any covering is installed. Blank off or remove items which may be damaged by the test pressure. Correct all defects and retest as many times as is necessary to verify that all defects have been remedied. Neither peening nor the use of leak seals is permitted.
- B. Test drain-waste piping by tightly plugging all openings except for the highest opening in the system. Fill all systems to overflowing. Systems shall be tight throughout with no drop in water level for a minimum period of 2 hours.
- C. See above paragraphs for testing of natural gas piping systems.

3.07 DISINFECTION OF WATER SUPPLY SYSTEM

- A. Fill all systems with a water and chlorine solution which contains 50 parts per million of available chlorine and allow it to stand 6 hours before flushing. Fill each system with a solution which contains 100 parts per million of available chlorine; allow it to stand 2 hours and flush it.

3.08 PAINTING

- A. Clean all surfaces free of dirt, oil, grease, etc. Surfaces shall be clean and dry before any paint is applied.
- B. Restore to original condition and appearance any equipment which has sustained damage to the manufacturer's prime and/or finish coat.

3.09 OPERATING AND MAINTENANCE MANUALS

- A. Furnish to the Owner operations and maintenance instructions of all mechanical, electrical and manually operated equipment furnished and/or installed under the Contract, as specified. See SECTION 01730, OPERATION AND MAINTENANCE MANUALS.

END OF SECTION

SECTION 15500

HEATING, VENTILATION AND AIR CONDITIONING

PART 1 - GENERAL

1.01 DESCRIPTION

- A. The Work of this section includes all labor, tools, material, fittings, accessories and equipment necessary to provide the heating, ventilating and air conditioning systems, complete and operable.
- B. The Work includes, without limiting the generality thereof:
 - 1. Energy recovery ventilation system
 - 2. Electric unit heaters
 - 3. Ductless Split System Heat Pump (Process Cooling for VFDs)
 - 4. Supply and exhaust ventilation ductwork.
 - 5. Dehumidifiers.
 - 6. Condensate Pumps
 - 7. Testing, adjusting and balancing.

1.02 SUBMITTALS

- A. Submit the following in accordance with Section 01300:
 - 1. Energy recovery unit
 - 2. Electric unit heaters
 - 3. Ductless Split System Heat Pump (Process Cooling for VFDs)
 - 4. Ductwork
 - 5. Ductwork accessories
 - 6. Insulation
 - 7. Dehumidifiers
 - 8. Condensate Pumps

1.03 RELATED WORK SPECIFIED ELSEWHERE

- A. Section 03300, Cast-In-Place Concrete
- B. Section 05500, Metal Fabrications
- C. Section 09900, Painting
- D. Section 16085, Miscellaneous Equipment
- E. Section 16120, Wire and Cables

1.04 ITEMS INSTALLED BUT NOT FURNISHED

- A. None

1.05 ITEMS FURNISHED BUT NOT INSTALLED

- A. Thermostats for unit heaters – SECTION 16 – ELECTRICAL.

1.06 DESIGN CRITERIA

- A. The Work of this section shall comply with the requirements of the Massachusetts State Building Code and of all other authorities having jurisdiction.
- B. The equipment covered by the Specifications is intended to be standard equipment of proven quality as manufactured by reputable concerns. Equipment shall be designed, constructed and installed in accordance with the best practice of the industry and shall operate satisfactorily when installed in accordance with the Contract Documents. The Specifications call attention to certain details, but do not purport to cover all details entering into the construction of the equipment.
- C. All material shall be new and shall bear the manufacturer's full identification.
- D. Requirements of Regulatory Agencies
 - 1. The final, complete installation shall comply with all state and local statutory requirements having jurisdiction. Arrange for all necessary permits, pay all fees and arrange for all required inspections by state and local authorities.
 - 2. In general, all Work shall comply with the requirements of rules, regulations, standards, codes, ordinances, and laws of local, state, and federal governments, and other authorities that have legal jurisdiction over the Project Site. Materials and equipment shall be manufactured, installed and tested as specified in latest editions of applicable publications, standards, rulings and determinations of:
 - a. Local and state building, HVAC, plumbing, mechanical, energy conservation, electrical, fire and health department codes.
 - b. National Fire Protection Association (NFPA).
 - c. Occupational Safety and Health Act (OSHA).
 - d. Underwriters' Laboratories (UL).
 - e. Material and equipment shall be listed by Underwriters' Laboratories (UL), and approved by ASME for intended service.
 - 3. When requirements cited in the Specifications conflict with each other or with Contract Documents, most stringent shall govern Work.
 - 4. Most recent editions of applicable specifications and publications of the following organizations form part of Contract Documents:
 - a. American National Standards Institute (ANSI).
 - b. American Society of Mechanical Engineers (ASME).

- c. National Electric Manufacturers Association (NEMA).
- d. American Society for Testing and Materials (ASTM).
- e. American Society for Heating, Refrigerating and Air Conditioning Engineers (ASHRAE).
- f. Air Moving and Conditioning Association (AMCA).
- g. Sheet Metal and Air Conditioning Contractors National Association (SMACNA).
- h. Thermal Insulation Manufacturers Association (TIMA).
- i. Institute of Electrical and Electronics Engineers (IEEE).
- j. Insulated Cable Engineers Association (ICEA).

E. Tests, Adjusting and Balancing

- 1. Test all systems furnished under this section and repair or replace all defective Work. Make all necessary adjustments to the systems and instruct the Owner's personnel in the proper operation of all systems.
- 2. Defined to include, but not necessarily limited to, air distribution systems, and associated equipment and apparatus of mechanical Work. Work consists of setting speed and volume (flow) adjusting facilities provided for systems, recording data, conducting tests, preparing and submitting reports, and recommending modifications to Work as required by the Contract Documents.
- 3. Startup the following pieces of equipment in strict accordance with manufacturer instructions and with the manufacturer's representative.
 - a. Energy Recovery Unit
- 4. Submit certified test reports signed by test and balance supervisor performing TAB Work.
- 5. Include identification and types of instruments used and most recent calibration date with submission of final test report.
- 6. Shop Drawings
 - a. Submit sample test data forms complete with certifying agency logo, identifying required test data, date, page number, system designation, system location, Project name, and balancer's name.
- 7. Tester's Qualifications: Firm with at least 3 years successful testing, adjusting, and balancing experience on projects with testing and balancing requirements

similar to those required for the Project, not installer of system to be tested, and otherwise independent of the Project.

8. NEBB or AABC Compliance: Comply with either National Environmental Balancing Bureau (NEBB) or Associated Air Balance Council (AABC) Procedural Standards for Testing, Adjusting, and Balancing of Environmental Systems, as applicable to mechanical air distribution systems and associated equipment and apparatus.
9. Industry Standards: Comply with ASHRAE recommendations pertaining to measurements, instruments, and testing, adjusting, and balancing except as otherwise indicated.
10. Do not proceed with testing, adjusting, and balancing Work until each system is complete and operable. Ensure no later residual Work still to be completed.
11. Do not proceed until Work scheduled for testing, adjusting, and balancing is clean and free from debris, dirt, and discarded building materials.
12. The Engineer shall be immediately notified of any unfavorable test results or indication of faulty equipment. No piece of equipment shall be energized until the test data is evaluated and the equipment is proven acceptable.
13. Upon completion of the work herein described, the Testing Firm shall submit Test and Inspection Reports to the Engineer.
14. If the test and inspection data submitted should indicate deficiencies in the operation of the electrical apparatus or in the manufacturer thereof, promptly implement the necessary adjustments, corrections, modifications and/or replacements necessary to be made to meet the specified requirements.
15. Upon completion of the remedial work, the Testing Firm shall repeat all of the tests on components previously found deficient on the first test or any additional test if they be required. Have all remedial Work accomplished as may be required by second and/or additional tests.

1.07 DELIVERY, STORAGE AND HANDLING

- A. Provide in accordance with Section 01600.
- B. All materials and equipment shall be shipped, stored, handled and installed in such manner as not to degrade quality, serviceability, or appearance.
- C. Protect all work, the Owner's property and the property of others from injury or loss caused by operations associated with the Work of this section. Make good any such injury or loss, at no cost to the party suffering the injury or loss.

1.08 PROCEDURE

- A. Secure all required permits, inspections, and approvals and pay all costs and fees.

- B. Unless the Specifications state "No Substitutions", substitutions will be considered for any specified item.
- C. Coordinate safety program with that of the Contractor. Cooperate with other Subcontractors to establish lines, levels, openings, chases, clearances, and locations to avoid interference; and to protect the Work.
- D. Deliver all materials as needed to avoid delays.

1.09 INTERPRETATION OF DRAWINGS

- A. Listing of Drawings does not limit responsibility of determining full extent of Work required by the Contract Documents. Refer to Architectural, HVAC, Electrical, Structural, and other Contract Drawings and other sections that indicate types of construction in which Work shall be installed and Work of other trades with which Work of this section must be coordinated.
- B. Except where modified by a specific notation to the contrary, the indication and/or description of any item, in the Contract Drawings or Specifications or both, carries with it the instruction to provide the item, regardless of whether or not this instruction is explicitly stated as part of the indication or description.
- C. Items referred to in singular number in Contract Documents shall be provided in quantities necessary to complete Work.
- D. Drawings are diagrammatic. They are not intended to be absolutely precise; they are not intended to specify or to show every offset, fitting, and component. The purpose of the Contract Drawings is to indicate a systems concept, the main components of the systems, and the approximate geometrical relationships. Based on the systems concept, the main components, and the approximate geometrical relationships, the contractor shall provide all other components and materials necessary to make the systems fully complete and operational.
- E. Data that may be furnished electronically by the Engineer (on computer tape, diskette, or otherwise) is diagrammatic. Such electronically furnished information is subject to the same limitation of precision as heretofore described. If furnished, such data is for convenience and generalized reference, and shall not substitute for the Engineer's sealed or stamped construction documents.

1.10 DISCREPANCIES IN DOCUMENTS

- A. Where Contract Drawings or Specifications conflict or are unclear, advise the Engineer in writing before Award of Contract. Otherwise, the Engineer's interpretation of Contract Documents shall be final, and no additional compensation shall be permitted due to discrepancies thus resolved.
- B. Where Contract Drawings or Specifications do not coincide with manufacturers' recommendations or with applicable codes and standards, alert the Engineer in writing

before installation. Otherwise, make changes in installed Work as the Engineer requires at no additional cost to the Owner.

- C. If the required material, installation, or Work can be interpreted differently from drawing to drawing, or between Contract Drawings and Specifications, the Subcontractor shall provide that material, installation, or Work which is of the higher standard.
- D. Provide systems and components that are fully complete and operational and fully suitable for the intended use. There may be situations in the documents where insufficient information exists to precisely describe a certain component or subsystem, or the routing of a component. In cases such as this, where the Subcontractor has failed to notify the Engineer of the situation as specified, provide the specific component or subsystem with all parts necessary for the intended use, fully complete and operational, and installed in workmanlike manner either concealed or exposed per the design intent.
- E. In cases covered by Paragraph (D) above, where the Subcontractor needs engineering guidance, submit a sketch identifying his proposed solution and the Engineer shall review, note if necessary, and approve the sketch.

1.11 MODIFICATIONS IN LAYOUT

- A. Drawings are diagrammatic. They indicate general arrangements of mechanical and electrical systems and other Work. They do not show all offsets required for coordination nor do they show the exact routings and locations needed to coordinate with structure and other trades and to meet Architectural requirements.
- B. Check Contract Drawings as well as Shop Drawings of all trades to verify and coordinate spaces in which Work of this section will be installed.
- C. Maintain maximum headroom at all locations. All piping, duct, conduit, and associated components to be as tight to underside of structure as possible.
- D. Make reasonable modifications in layout and components needed to prevent conflict with Work of other trades and to coordinate as specified. Systems shall be run in a rectilinear fashion.
- E. Where conflicts or potential conflicts exist and engineering guidance is desired, submit sketch of proposed resolution to the Engineer for review and approval.

1.12 RECORD DRAWINGS

- A. Record drawings shall be provided under this Section in accordance with Section 01780 and as specified herein.
- B. As Work progresses and for duration of the Contract, maintain complete and separate set of prints of Contract Drawings at the Project Site at all times. Record Work completed and all changes from original Contract Drawings clearly and accurately including Work installed as a modification or addition to the original design.

- C. At completion of Work prepare a complete set of reproducible record drawings showing all systems as actually installed.
- D. The Engineer will not certify the accuracy of the Record Drawings. This is the responsibility of the Subcontractor.
- E. This trade shall submit the record set for approval by the building department in a form acceptable to the department, when required by the jurisdiction.
- F. Drawings shall show record condition of details, sections, control changes and corrections to schedules. Schedules shall show actual manufacturer and make and model numbers of final equipment installation.

1.13 MANUFACTURER'S SERVICES

- A. Provide manufacturer's services for testing, training and start-up of the following equipment:
 - 1. Heat Recovery Unit
- B. The time required for each system shall be as specified in this section. The time specified shall be used as directed by the Engineer and shall not be used by the manufacturer or Subcontractor for field adjustments due to manufacturing or shipping defects.

1.14 ELECTRICAL WORK

- A. Except for electrical apparatus specifically called for as part of this Section, all switches and controllers required will be provided under DIVISION 16 - ELECTRICAL.
- B. All electrical apparatus and controls furnished as a part of the Work of this section shall conform to applicable requirements under DIVISION 16 - ELECTRICAL. Enclosure types shall be as indicated on the Contract Drawings.
- C. All motors furnished under this section shall be furnished by the manufacturer of the equipment served and shall be mounted and aligned so as to run free and true. Each motor shall be built to conform to the latest applicable NEMA, ANSI and IEEE standards for the type and duty of service it is to perform.
- D. Each motor shall be designed to operate on 60 Hz., and each shall be expressly wound for the voltage specified. Each motor shall operate successfully as rated load and frequency with a voltage variation of plus or minus 10% of voltage specified.
- E. All motors shall be provided with adequate starting and protective equipment as specified, and each shall have a terminal box of adequate size to accommodate the required conduit and wires.
- F. All electrical apparatus furnished under this section shall be approved by UL and shall be labeled or listed where such is applicable.

1.15 WARRANTIES

- A. Submit manufacturer's standard replacement warranties for material and equipment furnished under this section. Such warranties shall be in addition to and not in lieu of all liabilities, which the manufacturer and the Subcontractor may have by law or by provisions of the Contract Documents.
- B. All materials, equipment and work furnished under this section shall be guaranteed against all defects in materials and workmanship for a minimum period of 1 year commencing with the Date of Substantial Completion and Final Acceptance by the Owner. Any failure due to defective material, equipment or workmanship which may develop, shall be corrected at no expense to the Owner including all damage to areas, materials and other systems resulting from such failures.
- C. Guarantee that all elements of each system meet the specified performance requirements as set forth herein or as indicated on the Contract Drawings.
- D. Upon receipt of notice from the Owner of the failure of any part of the systems during the guarantee period, the affected parts shall be replaced. Any equipment requiring excessive service shall be considered defective and shall be placed.

1.16 SURVEY AND MEASUREMENTS

- A. Base all required measurements, horizontal and vertical, from referenced points established by the Contractor and be responsible for correctly laying out the Work required under this section of the Specification.

1.17 DELIVERY, STORAGE AND HANDLING

- A. Provide in accordance with Section 01610 and as specified herein.
- B. All manufactured materials shall be delivered to the Project Site in original packages or containers bearing the manufacturer's labels and product identification.
- C. Protect materials against dampness. Store off floors, under cover, and adequately protected from damage.
- D. Deliver products to the Project Site and store and protect same as recommended by the manufacturers'.
- E. Inspect all HVAC equipment and materials, upon receipt at the Project Site, for damage and correctness.

1.18 PROTECTION OF WORK AND PROPERTY

- A. Care and protect for all Work included under this section until it has been tested and accepted.

- B. Protect all equipment and materials from damage from all causes including theft. All materials and equipment damaged or stolen shall be repaired or replaced with equal material or equipment.
- C. Protect all equipment, outlets and openings with temporary plugs, caps and covers. Protect work and materials of other trades from damage that might be caused by work or workmen under this section and make good damage thus caused.

1.19 SAFETY PRECAUTIONS

- A. Comply with all of the safety requirements of OSHA throughout the entire construction period of the Project.
- B. Provide and maintain proper guards for prevention of accidents and any other necessary construction required to secure safety of life and/or property.

1.20 SPARE PARTS

- A. Furnish spare-parts data for every component that is required to be maintained for normal service of equipment furnished. The data shall include a complete list of parts and supplies, with current unit prices and source of supply; a list of parts and supplies that are either normally furnished at no extra cost with the purchase of the equipment, or specified hereinafter to be furnished as part of the Contract; and a list of additional items recommended by the manufacturer to assure efficient operation for a period of 180 days at the particular installation. The foregoing shall not relieve the Subcontractor of any responsibilities under the guarantees specified herein.

1.21 HOISTING, SCAFFOLDING AND PLANKING

- A. The Work to be done under this section of the Specifications shall include the furnishing, set-up and maintenance of all derricks, hoisting machinery, scaffolds, staging, planking, ladders, etc. as required for the Work.

1.22 SLEEVES, INSERTS, ANCHOR BOLTS, AND PLATES

- A. Be responsible for the location of and the maintaining in proper position all sleeves, inserts and anchor bolts supplied and/or set in place. In the event that failure to do so requires cutting and patching of finished Work, it shall be done at this Subcontractor's expense without any additional cost to the Owner.

1.23 SUPPLEMENTARY STEEL, CHANNELS AND SUPPORTS

- A. Provide all supplementary steel, channels and supports required for the proper installation, mounting and support of all HVAC equipment, piping, etc., required by the Specifications.
- B. Supplementary steel and channels shall be firmly connected to building construction in a manner approved by the Engineer.

- C. The type and size of the supporting channels and supplementary steel shall be determined by the Subcontractor and shall be of sufficient strength and size to allow only a minimum deflection in conformance with the manufacturer's requirements for loading.
- D. All steel used for supplementary steel, channels and supports shall be 316 stainless steel.

1.24 CERTIFICATES OF INSPECTION/APPROVAL

- A. Furnish upon completion of all Work, certificates of inspections from the manufacturers stating that authorized factory engineers have inspected and tested the operation of their respective equipment and found same to be in satisfactory operating conditions.

1.25 ACCESSIBILITY

- A. All Work shall be installed so that parts requiring inspection, operation, maintenance and repair are readily accessible. Minor deviations from the Contract Drawings may be made to accomplish this, but changes of substantial magnitude shall not be made prior to receipt of written approval from the Engineer.

1.26 DEFINITIONS

- A. As used in this section, the following terms are understood to have the following meanings:
 - 1. "Furnish" shall mean purchase and deliver to the project site, complete with every necessary accessory and support.
 - 2. "Install" shall mean unload at the delivery point at the site and perform all work necessary to establish secure mounting, proper location and operation in the project.
 - 3. "Provide" shall mean furnish and install.
 - 4. "Work" shall mean all labor, materials, equipment, apparatus,, controls, accessories, and all other items required for a proper and complete installation.
 - 5. "Piping" shall mean, in addition to pipe or tubing, all fittings, flanges, unions, valves, strainers, drains, hangers and other accessories relative to such piping.
 - 6. "Concealed" shall mean hidden from sight in chases, furred spaces, shafts, embedded in construction or in crawl space.
 - 7. "Exposed" shall mean not installed underground or concealed as defined above.
 - 8. "Furnished by others" shall mean materials or equipment purchased and set in place under other sections of the general contract and connected to the systems covered by this section of the specifications by this trade contractor.
 - 9. "Coordinate" shall mean all work provided under this section of the specification shall be in compliance with work of other trades.

PART 2 - MATERIALS

2.01 PIPE AND FITTINGS

- A. Refrigerant piping shall be type ACR copper tubing with silver brazed joints and wrought copper fittings.
- B. Condensate drain piping shall be Type 1, Grade 1, Class 12454-B, Schedule 40 polyvinyl chloride (PVC) pipe conforming to ASTM D-1785. Drain piping shall have Schedule 40 PVC socket fittings conforming to ASTM D-2466. All joints between pipe and fittings shall be solvent cemented joints conforming to ASTM D-2235 and ASTM D-402. Provide protection for PVC piping exposed to weather from ultraviolet radiation.

2.02 HANGERS AND SUPPORTS

- A. All hangers and supports shall be 316 stainless steel (SS).
- B. Pipe hangers shall conform to MSS SP 58 and SP 69. Pipe hangers for piping 4 inch and larger shall have rolls either of the Harvard type or 2 rod type. Pipe hangers for 3 inch pipe and under shall be clevis type. Pipe hangers for pipe less than 2 inch may be 1A band type in lieu of clevis type. Hangers in contact with copper tubing shall be copper plated.
- C. All hangers on insulated piping shall be sized to fit the outside of the covering. Provide spacer blocks and 16 gauge SS protection shields (12 inches long) at hangers, when pipe is installed.
- D. Duct hangers shall be in accordance with the "HVAC Duct Construction Standards" published by the Sheet Metal and Air Conditioning Contractors National Association, Incorporated (SMACNA).
- E. Where support points are required to avoid other Work, provide a system of channels and angles between support points as required. Provide all necessary supports and cross framing. No part of piping, ductwork, equipment, and the building shall be stressed beyond its normal allowable working strength.

2.03 UNIONS

- A. Unions for PVC pipe 2 inch and smaller shall be Schedule 40 PVC.

2.04 PIPING SPECIALTIES

- A. Provide dielectric couplings or flanges in all copper to ferrous transitions.
- B. Sleeves

1. Provide sleeves at all penetrations. Sleeves shall be aluminum or 316 stainless steel except in concrete as noted below. Sleeves shall be sized to allow 1/2 inch of annular space between the covering (or bare pipe) and the inside of the sleeve.
2. Pipe penetrations of walls below grade shall be sleeved and sealed using Thunderline Link-Seal wall sleeves and seals.
3. Pack the annular space with non-combustible (as defined by ASTM E136) fire stopping material, and seal with non-combustible caulking flush with finished surface.
4. Sleeves in concrete construction shall be 316L steel pipe, except where passing through exterior walls and slabs-on-grade they shall be ductile iron. Sleeves passing through floors shall project two inches above the finish floor and sleeves passing through walls shall be trimmed flush with the wall surface.

2.05 ENERGY RECOVERY UNIT

A. Provide an outdoor mounted, rotary air-to-air energy recovery ventilator as manufactured by Haakon, Climate Craft, Daikin Applied Custom, or equal. Contractor shall carefully note that custom units were selected and specified for this installation due to weight and service clearance requirements. Unit shall be manufactured for outdoor construction because of wet environment. The unit shall include a rotary exchanger, supply air and exhaust air blowers, motors with starters and relays, air filters, gas heating section, and specified options.

B. References

- | | | |
|----|------------|---|
| 1. | ASTM E90 | Standard Test Method for Laboratory Measurement of Airborne Sound Transmission Loss of Building Partitions and Elements |
| 2. | ASTM E1332 | Standard Classification for Determination of Outdoor-Indoor Transmission Class |
| 3. | SMACNA | HVAC Duct Construction Standards—Metal and Flexible |
| 4. | ARI 1060 | Rating Air-To-Air Energy Recovery Ventilation Heat Exchangers |
| 5. | AMCA 210 | Laboratory Methods of Testing Fans for Rating Purposes |
| 6. | NEMA MG1 | Motors and Generators |
| 7. | AFBMA 9 | Load Ratings and Fatigue Life for Ball Bearings |
| 8. | ARI 410 | Forced-Circulation Air-Cooling and Air-Heating Coils |
| 9. | UL 1995 | Heating and Cooling Equipment |

10. ASHRAE 52-76 Method of Testing General Ventilation Air-Cleaning Devices for Removal Efficiency by Particle Size (ANSI/ASHRAE Approved) (for Filters)
 11. ASHRAE 62.1 Ventilation for Acceptable Indoor Air Quality
- C. Service for the unit shall be available locally either directly from the manufacturer or from the manufacturer's certified local representative. Provide two hours of on-site startup service and instruction.
- D. Submittals
1. Drawings shall include accurately scaled CAD drawings of the entire unit with plan and elevation views and any required sub section or component thereof. Drawings shall be made available in electronic format either electronically or on disk.
 2. Product performance data shall include unit dimensions, weights, capacities, component performance data, electrical data, construction details, required clearances and service access dimensions, field connection requirements and data, static pressure drops, methods of vibration isolation, included gages, performance data for each blower, and unit surface material and finish.
 3. The submittal shall provide information on filters including pressure drop, efficiency, media description, frame details, and filter gage information.
 4. Submittal shall include electrical data for the unit including full load amps for each unit component, maximum circuit ampacity, breaker and disconnect size, transformer size, and wiring diagrams for control panel wiring and unit component wiring that indicates factory and field installed wiring.
 5. Submittal shall include the manufacturers recommended installation instructions.
- E. Construction
1. Unit base shall be constructed from 8-inch structural steel beam or channel as appropriate around the perimeter of the unit with intermediate channel and angle iron supports.
 2. A 0.12" thick aluminum checker floor plate shall be installed on the base frame. Floor shall be flat reinforced from below, with all seams continuously welded. The floor shall be insulated with 3" thick fiberglass insulation and consist of a load-bearing, rigid, closed-cell foam core laminated to a black glass reinforced mat facer.
 3. All cabinet walls, access doors, floor and roof shall be fabricated of double wall, impact resistant, panels insulated with fiberglass or foam.

4. Walls and roofs shall be constructed of 12-gauge aluminum acoustic thermal panels. The inner liner shall be washdown aluminum 22-gauge solid aluminum. Insulation shall be R-12 comprised of built-up layers of 3 lbs/cf density fiberglass. Provide neoprene and mylar liner to seal insulation. Insulation shall meet flame spread rating of less than 25 and a smoke developed rating of less than 50 when measured in accordance with ASTM E84. All permanently joined flanged panel surfaces shall be sealed with an individual strip of 1/8" x 3/8" tape sealer. Wall (and roof) seams shall be turned inward to provide a clean flush exterior finish. All panel seams shall be sealed during assembly to produce an airtight tight.
- F. Insulation: Insulation shall be at least R-12-thickness, have a minimum density of 3 pounds/cubic foot and have a minimum R-value of 7.5 per inch. Foam insulation shall be tested in accordance with ASTM D-1929 for a minimum flash ignition temperature of 610°F. Insulation shall meet the flame and smoke generation requirements of NFPA-90A.
- G. Rotary Air-To-Air Heat Exchanger
1. Rotary air-to-air heat exchanger sensible recovery performance and leakage must be clearly measured and certified by AHRI in accordance with AHRI Standard 1060. The wheel's Exhaust Air Transfer Ratio, as measured and certified by AHRI, shall be 2.0 or lower. Exchanger shall be hygroscopic, mounted in housing with purge sector, variable speed drive, multifunction control system, and full season operational control.
 2. The unit must be provided with a factory set, field adjustable purge sector. The purge sector shall be designed such that, as measured according to AHRI Standard 1060, the Outdoor Air Correction Factor is less than 1.11 at a pressure differential of 0.00 inches w.g. This performance shall be certified and published by AHRI.
- H. Non-Scrolled Fans—Plenum Type
1. Fans shall be manufactured by Haakon, Twin City, Barry Blower or Mechanovent. Fans shall be airfoil as indicated in the schedule or the fans shall be centrifugal plenum (plug) type, designed without a scroll type housing. Fans shall incorporate a wheel, heavy gauge reinforced steel inlet plate with removable spun inlet cone, structural steel frame, and shaft and bearings in AMCA Arrangement 3 configuration as an entire assembly.
 2. All fan wheels shall have tapered spun wheel cones or shrouds providing stable flow and high rigidity. The wheels shall be non-overloading type.
 3. The blades shall be continuously-welded, die-formed Airfoil type, designed for maximum efficiency and quiet operation. Partial welding will not be acceptable on airfoil blades.
 4. Impellers shall be statically and dynamically balanced and complete fan assembly shall be test balanced at the operating speed prior to shipment.

5. Shafts to be sized for first critical speed of at least 1.43 times the maximum speed for the class. Bearings are to be heavy duty, grease lubricated, anti-friction ball or roller, self-aligning, pillow block type and selected for an L10 200,000 hour life at the maximum class RPM.
6. When specified, the fans shall be supplied with internal or nested type variable inlet vanes for wheel diameter 16 ½” and larger.
7. Cantilevered vane blades are to be used through Size 490 to minimum air performance insertion losses and noise. Operating mechanism shall be out of the inlet airstream.
8. Provide OSHA approved fully enclosed metal belt guard sides of galvanized steel and expanded metal face. Belt guard shall be sized to allow either sheave to be increased by two sizes.
9. Plenum fan assembly must have an enclosed safety screen as per OSHA Standards.
10. Fans shall have inlet OSHA approved inlet screens.

I. Drive System/Speed Control

1. The rotor drive system shall consist of an adjustable belt around the rotor perimeter driven by an AC motor with gear reduction. The variable speed drive shall be specifically designed for heat wheel applications and include: an AC inverter, soft start/stop, rotation detection w/alarm contacts, automatic self cleaning function, and self testing capability.
2. The speed controller shall be capable of accepting a potentiometer, VDC, or MA control signal.
3. Motors shall be premium efficient, ODP, T-frame, 1750 rpm nominal with a minimum service factor of 1.15 mounted on an adjustable base.
4. Motors, blowers, and frames shall be coated with rust inhibiting paint.
5. Supply and Exhaust air blowers shall be forward curved DWDI class I for quiet efficient operation arranged in a draw through configuration relative to exchanger. Motors and blowers are to be mounted on common frame, isolated from the unit case with seismic restrained and flexible duct connections. Motors and blowers shall have V-belt drives with variable pitch sheaves.

J. Gas Heater

1. Provide a self-contained, indirect fired, minimum 79% efficient, automatically controlled gas fired heater with output capacity as specified. The combustion chamber shall be fabricated of type 409 stainless steel. The flue gases shall pass

through a stainless steel one pass tubular economizer. Gas heater shall be U.L. and E.T.L. listed.

2. All economizer tubes shall be accessible for cleaning through an external access panel. Access shall be located at the same end of the unit as the burner and flue outlet.
 3. Motor starter, relays, transformer, switches, fuse holders, and sequencing controls shall be factory wired in conduit and mounted in enclosures. The entire unit shall operate automatically in accordance with the sequence of operations. A combination fan and limit control shall control the main blowers and operate to de-energize the burner if discharge air temperature becomes excessive.
 4. Factory installed induced draft blower shall be independently driven by single purpose self-ventilating motor and controlled separately from the main blowers. The design shall be such that cooling air is drawn over the inboard motor bearing and shaft.
 5. The power gas burner equivalent to Gordon Piat shall be factory mounted and wired. Provide high tension spark ignited gas pilot, electronic primary safety control, automatic gas control valve, main gas regulator, pilot gas regulator, pilot gas cock, pilot assembly, and all components necessary to make a complete unitary burner assembly.
 6. Provide 4:1 modulated firing including damper motor, gas metering valve, proportioning air damper and necessary linkage to assure proper air-fuel ratio at all rates. All components of the burner to be mounted, wired and fire tested prior to shipment from the manufacturer.
- K. Air Filters: Outside and Return air filters shall be MERV 8 when evaluated under the guidelines of ASHRAE Standard 52.2-2007. Initial resistance to airflow shall not exceed 0.31" w.g. at an airflow of 500 fpm. The filter shall be classified by Underwriters Laboratories as UL Class 2. Filters shall be mounted within unit in galvanized holding frames upstream of exchanger and accessible through access panels or doors
- L. Dampers:
1. Actuated Dampers shall have heavy duty extruded aluminum frames, 4" extruded aluminum air-foil blades mounted on brass shafts, supported and inter-connected by fiberglass reinforced nylon gears.
 2. Low leakage dampers shall have hollow (thermoplastic elastomer (TPE)) rubber jamb seals built into both the blades and the frame. The side casings shall enclose the gears with ABS plastic covers that also serve as seals in the closed position.
 3. Outside Air Shut-Off Dampers: Outside air dampers shall be mounted on the inlet of the unit and operated by a spring return, direct-coupled on-off actuator with an end switch to be interlocked with the supply air motor relay. Dampers shall have parallel blades.

4. Exhaust Air Shut-Off Dampers: Exhaust air damper shall be mounted on the outlet of the unit and operated by a spring return, direct-coupled on-off actuator with an end switch to be interlocked with the return air motor relay. Dampers shall have parallel blades.
5. Two Position Spring Return Actuators shall be direct coupled type which require no crankarm and linkage and be capable of direct mounting to the damper jackshaft. The actuators must be designed so that they may be used for either clockwise or counterclockwise fail-safe operation. Actuators shall use a brushless DC motor and be protected from overload at all angles of rotation. Actuators shall have reversing switch and manual override on the cover, and be protected from overload at all angles of rotation. As required, 1 or 2 SPDT auxiliary switches shall be provided having the capability of being adjustable. Actuators with auxiliary switches must be constructed to meet the requirements for Double Insulation so an electrical ground is not required to meet agency listings. Run time shall be constant and independent of torque. Actuators shall be UL listed and CSA certified, have a 5 year warranty, and be manufactured under ISO 9001 International Quality Control Standards.

M. Electrical

1. Electrical controls shall include for belt drive units: motor starters with overloads, fused branch circuit breakers, control transformer for low voltage controls, service switch, and terminal points/blocks all contained in a NEMA 3R, unit-mounted control panel.
2. A single main un-fused disconnect switch for single point power connection shall be provided. The disconnect switch shall be mounted through the access panel so that power will have to be shut-off before the access door can be opened.
3. The motor power and branch circuits shall be protected by circuit breakers so replaceable fuses will not be necessary.
4. All wiring and controls shall be factory tested before shipment.
5. The unit wiring diagram shall be provided in the panel.

N. Controls

1. Integral standalone microprocessor controller, programmable and adjustable with both Ethernet and RS-485 communication ports.
2. A panel-mounted Touch-Screen Human-Machine Interface (HMI) device shall also be installed inside the unit and will allow users to change all unit operating parameters, execute schedules, and change control program variables.
3. Furnish, install and wire a remote panel-mounted Touch-Screen Human-Machine Interface. (HMI) This device shall allow users to change all unit operating

parameters, execute schedules, and change control program variables. The panel shall be wall-mounted and NEMA 4 construction.

4. Units with heat wheels shall come with factory mounted electronic speed control providing soft-start/stop, rotation detection and alarm, and self-cleaning jog functions.
5. The operational control system shall use remote temperature sensors mounted in the entering and leaving sides of both airstreams to monitor exchanger performance. Setpoints shall be adjustable at the provided HMI. The DDC controller shall modulate rotor speed to:
 - a. Prevent frost build-up. The controller shall monitor the temperature in the exhaust airstream leaving the exchanger and modulate wheel rotational speed to prevent the temperature from dropping below an adjustable, pre-programmed setpoint.
 - b. Outside Air and Exhaust Air Shut-Off dampers shall be operated by a two position spring return direct-coupled actuators with end switches to be interlocked with the supply and exhaust air motor relay or relays, respectively. Actuators to be controlled by the DDC control board.
 - c. Gas Heater shall be provided with 4:1 stepped controls by the DDC control board. The heater shall control supply air temperature in sequence with the heat recovery wheel.
 - d. Blowers shall be provided with motor starters with overloads controlled by the microprocessor.
6. Sequence of Operation
 - a. The following sequence of control shall be programmed into the controller by the manufacturer at the factory.
 - b. The unit shall be started manually and run continuously until manually shut off.
 - c. The unit's programmable DDC controller shall modulate the heat recovery wheel and gas heat in sequence to control supply air temperature. Supply air temperature is reset between occupied (60-degrees) or unoccupied (50-degrees) temperature setpoints by a remote two-position switch.
 - d. Refer to the specifications for internal control sequences for dampers and the heat recovery wheel that can be accessed through the unit's panel mounted touch screen.

2.06 SPLIT SYSTEM DIRECT EXPANSION HEAT PUMP (SMALL)

- A. The variable capacity, heat pump system shall be a ductless split system as indicated. The system shall consist of multiple evaporators, a two-pipe refrigeration distribution system using PID control. The outdoor unit is a direct expansion (DX), air-cooled air-conditioning system with variable speed driven compressors using R-410A refrigerant. LG, Climatemaster, Mitsubishi or approved equal. Unit shall be furnished with all required accessories for low ambient heating and cooling operation. Daikin is not acceptable. Unit cabinet shall be 20-gauge galvanized steel, with prime coat and two part epoxy finish.
- B. Provide interconnecting piping.
- C. Provide 24-inch high elevated stand for outdoor condensing unit to mitigate impact of snow blockage.
- D. Integrated inverter driven compressor in the outdoor unit and the electronic linear expansion valve (LEV) position for precise capacity control.
- E. Provide contactor, 24 V control transformer, blower relay, lockout relay and low voltage terminal board and remote mounted deadband-type day-night thermostat with sub base.
- F. Provide circuit to lock compressor off when safety controls have been activated. Unit shall not be restartable until room thermostat has been turned off and on.
- G. Provide factory mounted air filters.
- H. The drain pan shall be constructed to inhibit corrosion and fully insulated. Drain outlet shall be located on pan as to allow complete and unobstructed drainage of condensate. The unit as standard shall be supplied with solid-state electronic condensate overflow protection conforming to UL 508 that shuts off the unit when the primary drain is blocked. Mechanical float switches will not be accepted.
- I. Insulate evaporator and compressor compartment panels with 1 1/2 lb. fibrous glass insulation.
- J. Provide either direct drive ECM or belt driven evaporator blowers with common shaft and three sealed ball bearings. Belt-driven evaporator blower motor shall be 1750 rpm, three phase, with inherent overload protection or starter with quick trip heaters and sealed ball bearings.
- K. Provide compressors with crankcase heater to prevent oil dilution on off cycle, and suction line thermostat to stop compressor when suction line temperature falls below setpoint.
- L. The unit shall have controls provided by the manufacturer to perform input functions necessary to operate the system.
- M. Wall mounted, hard wired, programmable remote controller kit.
- N. Install piping according to manufacturer's recommendations.
- O. Both refrigerant lines shall be insulated from the outdoor unit to the indoor Fan Coils.
- P. Provide factory inspection of the installation and correction of the installation as required to satisfy the factory's recommendations.
- Q. Install piping according to manufacturer's recommendations.
- R. Both refrigerant lines shall be insulated from the outdoor unit.

- S. Provide factory startup.
- T. Provide factory trained inspection of the installation and correction of the installation as required to satisfy the factory's recommendations.

2.07 ELECTRIC UNIT HEATERS

- A. Provide Electric unit heaters as manufactured by Indeeco, Qmark, Electromode, or approved equal.
- B. Washdown heater shall be a reliable, rugged, self-contained, U.L. and CSA listed, corrosion resistant unit heater. This unit offers both corrosion protection in harsh environments and the ability to be hosed down for cleaning.
 - 1. All components are designed to be moisture and corrosion resistant. A sturdy stainless steel case surrounds industrial grade 316 stainless steel finned tubular elements. The motor is a totally enclosed, permanently lubricated, ball bearing type which is epoxy painted for moisture and corrosion resistance. The junction box which houses the built-in controls and element terminals is rated NEMA 4X. Air flow comes from a spark resistant, epoxy coated aluminum fan. Accessories: Power contactor, motor contactor, epoxy sealed automatic over-temperature cutout, remote thermostat, pilot light to indicate when unit is in operation mode, and selector switch are standard (heater on, off, fan only).
 - 2. Accessories:
 - a. Disconnect Switch Rated 40 amps (factory mounted).
 - b. Secondary manual reset limit (factory mounted).
 - c. Monel elements (factory mounted).
 - d. Stainless steel universal type swivel mounting bracket.
 - e. Fans shall have delay on both start and stop. Upon call for heat, fan start shall be delayed until heating element is warm. When thermostat is satisfied, fan stop shall be delayed until heating element is cool.

2.08 WALL MOUNTED ELECTRIC HEATERS

- A. Provide wall mounted electric heaters as manufactured by Broan, Qmark, Electromode, or approved equal. Basis of design is Q Mark Model CWH1101DSF.
- B. Heaters shall consist of the following:
 - 1. Steel enclosure with heavy steel grille.
 - 2. Integral thermostat with a range of 40 to 85 deg F.
 - 3. Manual reset thermal overload.

4. On-off power switch for service.
5. Permanently lubricated fan motor.

2.09 DUCTWORK

- A. Provide all sheet metal ductwork required for the various supply and exhaust air systems. **Unless otherwise indicated on the Contract Drawings ductwork shall be 316 stainless steel and all ductwork and sheet metal plenums shall be constructed meeting the requirements of ASTM A 480, lock-forming quality.** All ductwork, except where specified otherwise herein, shall be fabricated in accordance with the "HVAC Duct Construction Standards for Metal Ducts" published by the Sheet Metal and Air Conditioning Contractors National Association, Incorporated (SMACNA), 2 inch water gauge Pressure Class.
- B. Ducts shall be true to the inside dimensions indicated on the Contract Drawings. Cross break all duct panels over 12 inches wide. Support ducts rigidly and securely. Support horizontal ducts not over 8 feet on center. Ducts shall be straight and smooth on the inside with neatly finished joints and all transverse joints and longitudinal seams of all low pressure ducts shall be sealed in conformance with SMACNA seal classification B.
- C. Elbows narrower than 16 inches shall be full radius elbows with inside radius equal to the dimension of the duct in the plane of the elbow or offset. Elbows wider than 16 inches may be full radius elbows or square elbows with air foil section turning vanes (Duct Manual Figure 2-3) and 6 inch inside radius. Vanes shall be "Runner" Type 2, 3 1/4 inches on centers. Install outside vane flush against the outside of the elbow.
- D. Transitions in duct mains and branches shall be made with sides sloping at not more than 1 inch in 7 inches on the side of the transformation for diverging transitions and 1 inch in 4 inches for converging transitions. Transitions in ductwork to pieces of equipment shall be made with a 20 degree maximum angle projected from the straight duct side on a diverging transition and a 30 degree maximum angle projected from the straight duct side on a converging transition. Any conditions requiring deviations from the above shall be brought to the attention of the Engineer for approval.
- E. All notches for connecting sections of duct, including longitudinal seam notches, shall not be cut any deeper than 1 7/8 inches to insure tight corners in 2 inch deep slip joints.
- F. Slips shall be at least 2 gauges heavier than the duct and all joints shall be made in a neat and workmanlike manner and in all cases shall be tight. All ducts shall have all joints sealed with EC-800 as manufactured by 3M, Hardcast or approved equal.

2.10 DUCTWORK ACCESSORIES

- A. Duct Flexible Connections: Provide 6 inch metal edge ventglas or thermafab flexible connections at fan and unit inlets and outlets. Leave 1 inch minimum slack, (this means 1/2 inch standing fold). Duct openings shall be lined up on either side of flexible connections.

- B. Wire Mesh Screen: 1/2 inch x 1/2 inch 316 series stainless steel welded wire mesh.
- C. Volume Dampers
1. Provide volume dampers where indicated on the Contract Drawings.
 2. Dampers less than 12 inches in height shall be Young Regulator manual adjustable rectangular opposed blade dampers.
 3. Dampers 12 inch and larger in height shall be opposed multi-blade equal to Greenheck, Nailor, or Vent Products.
 4. Damper frame shall be constructed of 316 series stainless steel channel with minimum thickness of .050 inches. Opposed damper blades shall be 316 series stainless steel with minimum thickness of .050 inches and shall include reinforcing ribs. Each blade shall be supported in the damper frame by individual Teflon axle bearings, and shall be driven by stainless steel connecting slide linkage controlled by 3/8 inch square steel control shaft.
 5. Damper blades shall be 2 gauges heavier than adjoining ductwork, and shall be riveting to supporting rods. Hem over edges parallel to rods.
 6. Brackets shall be galvanized metal, secured to ductwork with sheet metal screw with locking quadrant arms. Provide 2 inch handle extension for all dampers on externally insulated ductwork.
- D. Sheet Metal Access Panels
1. Provide access panels of the proper size and at all locations in ductwork necessary to service control devices, fan bearings and as required to service all systems.
 2. Access panels shall have foam gasketing, fixed hinges and compression type latches as manufactured by Ventlock, Duro-Dyne or approved equal. Access doors for insulated ducts shall be insulated with 1-inch thick 1 1/2 lb density coated duct liner.
- E. Diffusers, Registers and Grilles
1. Supply Grille, Supply Register:
 - a. Minimum 22 gauge type 316 stainless steel construction.
 - b. 1 1/4-inch margins, mitered corners, and countersunk mounting holes.
 - c. Double deflection.
 - d. Vertical front blades and horizontal rear blades.
 - e. Individual adjustable front and rear blades on 3/4-inch centers.
 - f. Mill finish.
 - g. Register to be provided with integral opposed blade type 316 stainless steel damper adjustable from face.

h. Tuttle & Bailey, T64SS.

2. Exhaust Registers, Exhaust Grilles:

- a. Minimum 22 gauge type 316 stainless steel construction.
- b. 1 1/4-inch margins, mitered corners, and countersunk mounting holes.
- c. Fixed vertical zero deflection bars.
- d. Mill finish.
- e. Register to be provided with integral opposed blade type 316 stainless steel damper adjustable from face.
- f. Tuttle & Bailey, T80SS.

F. Control Dampers

- 1. Damper Assembly: Damper shall conform to SMACNA HVAC Duct Construction Standards. A single damper section shall have blades no longer than 48 inches and shall be no higher than 72 inches. Maximum damper blade width shall be 8 inches. Larger sizes shall consist of a combination of sections. Damper shall be 316 stainless steel. Flat blades shall be made rigid by folding the edges. Provide blades with compressible seals at points of contact. Provide channel frames of dampers with jamb seals to minimize air leakage. Dampers shall not leak in excess of 10 cfm per square foot at 4 inches water gage static pressure when closed. Seals shall be suitable for an operating temperature range of minus 40 degrees F to 200 degrees F. Dampers shall be rated at not less than 2000 fpm air velocity. Moving parts of operating linkage in contact with each other shall consist of dissimilar materials. Damper axles shall be 0.5 inches minimum plated steel rods supported in the damper frame by stainless steel or bronze bearings. Blades mounted vertically shall be supported by non-ferrous dissimilar thrust bearings. Pressure drop through dampers shall not exceed 0.05 inch water gage at 1,000 fpm in the wide-open position. Frames shall not be less than 2 inches wide. Dampers shall be tested in accordance with AMCA 500-D.
- 2. Operating Links: Operating links external to dampers, such as crank arms, connecting rods, and line shafting for transmitting motion from damper actuators or dampers, shall withstand a load equal to at least twice the maximum required damper-operating force. Rod lengths shall be adjustable. Links shall be brass, bronze, or stainless steel. Mating parts shall consist of dissimilar materials. Working parts of joints and clevises shall be brass, bronze, or stainless steel. Adjustments of crank arms shall control the open and closed positions of dampers.

2.11 VIBRATION ISOLATION

A. Manufacturer Responsibility

- 1. Manufacturer of vibration equipment shall have the following responsibilities:
 - a. Guarantee specified isolation system deflections.

- b. Provide installation instructions, drawings and field supervision to ensure proper installation and performance of systems.

B. Quality Assurance

1. All vibration isolators shall have calibration markings or some method to determine adjustment, the actual deflection under the imposed load after installation and adjustment.
2. All isolators shall operate within the linear position of their load vs. deflection curves. Load vs. deflection curves shall be furnished by the manufacturer and must be linear over a deflection range of not less than 50% above the design deflection.
3. The theoretical vertical natural frequency for each support point, based upon load per isolator and isolator stiffness, shall not differ from the design objectives for the equipment as a whole by more than $\nabla 10\%$.
4. Substitution of internally isolated equipment in lieu of the isolation specified in this section, is acceptable provided all conditions of this section are met. The equipment manufacture shall provide a letter of guarantee stating that the specified noise and vibration levels will be obtained or the cost of converting to the specified external vibration isolation shall be born by the equipment manufacturer.
5. The following specifications describe spring hanger with 30 degree misalignment feature. This requirement is mandatory. Replace any hangers without the 30 degree capability at no additional cost to the Owner.

C. Description

1. All vibration isolation devices shall be the product of a single manufacturer. Products of other manufacturers are acceptable provided their systems strictly comply with intent, structural design, performance, and deflections of the base manufacturer.
2. Acceptable manufacturers of vibration isolation products shall be: Mason Industries, Amber Booth Company, Peabody Noise Control, Korfund Dynamics Corporation, Vibration Mountings and Equipment, Vibration Eliminator Co., provided they meet the requirements of the Specifications. Mason Industries model numbers have been used in the Specifications to establish quality of components, but are in no way to limit competitive bidding by other manufacturers.
3. Refer to Table A at the end of this Article for application of the various types listed to appropriate equipment and efficiency level.

D. Vibration Isolation Types

1. Vibration Isolators

- a. Type A: Spring Isolator Mason Industries Type SLF
 - (1) Having a minimum OD to OH of 0.8:1.
 - (2) Springs cadmium plated, hardware cadmium plated and all other metal parts hot-dip galvanized.
 - (3) Reserve deflection (from loaded to solid height) of 50% of rated deflection.
 - (4) Minimum ¼ inch thick neoprene acoustical base pad on underside.
 - (5) Designed and installed so that ends of springs remain parallel.
 - (6) Non-resonant with equipment forcing frequencies or support structure natural frequency.

2. Mason Ind. Type ND or Rails Type DNR

- a. Type E: Elastomer hanger rod isolator.
 - (1) Molded (min. 1 ¾ inch thick) neoprene element with projecting bushing lining the rod clearance hole. Static deflection at rated load shall be a minimum of 0.35 inches.
 - (2) Steel retainer box encasing neoprene mounting capable of supporting equipment up to four times the rated capacity of the element.

3. Mason Ind. Type WF

- a. Type J: Steel Rails.
 - (1) Steel members of sufficient strength to prevent equipment flexure during operation.
 - (2) Height saving brackets as required to reduce operating height and cradle the unit.

E. Execution

- 1. General: Isolation systems just be installed in strict accordance with the manufacturer's written instructions. Vibration isolator shall not cause any change of position of equipment resulting in stress on equipment connections.
- 2. Equipment Installation

- a. Equipment shall be isolated as per Table A below.
- b. Additional requirements:
 - (1) After the entire installation is complete, and under full operational load, the isolators shall be properly adjusted. Verify that there are no short circuits of the isolation. The equipment shall be free in all directions.
 - (2) Install equipment with flexibility in wiring.

TABLE A

Equipment	MTNG	ISOL	DEFL	BASE
Heat Recovery Unit	Flr	A	0.75	J
Unit Heaters	Clg	E	0.30	

NOTES:

- 1. "ISOL" and "BASE" column indicates letter type as it appears in the Specifications.
- 2. "MTNG" refers to method of support of equipment from the structure.

2.12 INSULATION

- A. All insulation, adhesives, tape, etc. shall conform to NFPA 90A. No voids in insulation will be permitted.
- B. Pipe Insulation.
 - 1. Suction lines, hot gas bypass lines, and outdoor liquid lines shall be insulated with 3/4" thick rigid closed cell foam insulation, AP/Armaflex, Manville, Owens Corning or approved equal.
 - 2. Insulation shall comply with ASTM E84 or UL 723.
 - 3. Insulation shall have a thermal conductivity of 0.245 at 75 deg. F mean temperature and shall have a 25/50 Flame Spread and Smoke Developed Index.
 - 4. Insulation shall include antimicrobial protection for the inhibition of mold and mildew growth.
 - 5. Installation shall meet manufacturer's recommendations. Seal butt joints with insulation manufacturers approved adhesive.
 - 6. Outside above ground insulation shall be protected with two coats of approved vinyl lacquer coating over woven glass mesh adhered to insulation with

Insulcolor or approved equal lagging adhesive, as recommended by manufacturer.

C. Duct Insulation

1. All supply ductwork inside the building and all supply, return and exhaust ductwork outdoors shall be covered with 2" thick, semi rigid fibrous glass boards. Multiple layers shall be applied to result in an insulating value of R-12. Duct insulation inside the building shall be covered with factory applied fire retardant foil reinforced kraft vapor barrier facing. Duct insulation outside the building shall be covered with a weather proof jacket equal to 3M Venture Clad Insulation Jacketing System.
2. Insulation density shall be 3 lb./cf with maximum K factor of 0.23 at 75°F mean temperature.
3. Impale insulation on mechanical fasteners applied to duct surface on 12" centers. Use at least two rows of fasteners on each side of duct. Provide fastener rows within 3" of seams and edges. Secure insulation with suitable speed washers or clips firmly embedded in insulation. Provide additional fasteners as necessary on cross broken ducts.
4. Extend insulation to standing seams, reinforcing, and other vertical projections 1" and less; do not carry over. Vapor barrier jacket shall be continuous across seams, reinforcing and projections. Insulation and jacket shall be carried over projections that exceed insulation thickness.
5. Transverse joints shall be butted tightly. Longitudinal joints shall be butted, ship lapped or 45°mitered. Seal joints with 4" wide strips of approved vapor barrier patch material and adhesive, or with approved pressure sensitive vapor barrier tape.
6. Cover breaks, ribs and standing seam penetrations with patch of jacket material no less than 2" beyond break; secure with adhesive and staple. Seal staples and joints with brush coat of vapor barrier coating.
7. Fill voids in insulation at jacket penetrations and seal with vapor barrier coating.
8. Seal and flash terminations and punctures with fibrous glass cloth between two coats of vapor barrier coating.
9. Terminate vapor barrier and extend insulation at standoff brackets.

2.13 AUTOMATIC CONTROLS

- A. The HVAC Sub Contractor shall furnish, install or provide electric automatic control devices as indicated on the drawings and in these specifications.
- B. Provide:

1. Automatic damper actuators.
- C. Furnish:
1. Thermostats for unit heaters.
 2. Controller for ERV-1.
- C. Install:
1. Duct sensors, etc. for ERV-1.
- D. Submittals
1. The following shall be submitted for approval:
 - a. Data sheets for control system components.
- E. Instruction and Adjustment
1. Upon Completion of the Work, the HVAC Sub Contractor shall:
 - a. Completely adjust and ready for use: thermostats, controllers, actuators and other components and equipment provided under this section.
 - b. Furnish operation and maintenance manuals covering function and operation of control systems on project for use by Owner's operating personnel. Competent technician shall be provided for instruction purposes.
 - c. Provide adequate instruction (not less than 2 hours) to the Owners personnel by means of a competent technician. Obtain written confirmation from the Owner that adequate instructions for each system has been provided in an acceptable manner.
- F. All wiring, wiring connections and rigid conduit shall be provided by DIVISION 16 - ELECTRICAL. All control wiring shall be run in rigid conduit. Conduit and wiring for power connections will be provided under DIVISION 16 - ELECTRICAL.
- G. Provide components factory ordered for this project. Rebuilt equipment, warehoused equipment, or earlier generation equipment shall not be acceptable. Electrical and electronic shall have a NEMA 250 Type 4 enclosure in accordance with NEMA 250 unless otherwise indicated on the Contract Drawings. Actuators shall operate within limit ratings of minus 35 to 150 degrees F.
- H. Actuators. Provide electric spring return actuators. Actuators shall function as required within 85% to 110% of their power supply rating. Actuators shall fail to their spring return positions on signal or power failure. Actuators shall have visible position indicators. Actuators shall open or close the devices to which they are applied within 60 seconds after a full scale signal input change.

1. Damper actuators shall be rated for at least 125% of the motive power necessary to operate the connected damper. The actuator stroke shall be limited by an adjustable stop in the direction of the return stroke. Actuators shall be provided with mounting and connecting hardware.
2. Confirm voltage with DIVISION16 prior to ordering actuators.

I. Thermostats

1. 25-Amps, 120 - 240 VAC
2. 22 - Amps, 277 VAC
3. Positive Snap-Action Switch for Heating Control
4. SPDT Contacts
5. NEMA 4X Weatherproof Enclosure
6. 40 - 100°F Temperature Range
7. 2.5°F Differential
8. Chromalox model WCRT-100

J. Humidistats

1. Honeywell model H46 model humidistat.
2. Fully enclosed, dust free, SPST, snap-acting switch
3. Impact- resistant, molded plastic cover mounts on wall
4. Positive on and off settings permit manual operation of controlled equipment.
5. 120 VAC, 7.5 A
6. 240 VAC, 15.0 A
7. Differential: 4 To 6 Percent RH
8. 50 To 125 Degrees F
9. Operating Humidity Range: 20 To 80 Percent RH
10. Dial Control

2.14 CONTROL SEQUENCES

A. Control sequences of operation shall be as indicated as follows:

1. On the Contract Drawings
2. Article: ENERGY RECOVERY UNIT

2.15 CONDENSATE PUMPS

- A. Furnish and install a condensate pump for each dehumidifier. Condensate pumps shall be equal to Little Giant VCMA-15 and shall include a ½ gallon tank, automatic start/stop control, 115 VAC pump motor and a six foot electrical cord and plug.

PART 3 - EXECUTION

3.01 GENERAL

- A. Install all items specified under this section according to the manufacturer's requirements, shop drawings, the details as shown on the Contract Drawings and/or as specified.
- B. Install all Work so that parts requiring inspection, replacements, maintenance and repair shall be readily accessible. Minor deviations from the Contract Drawings may be made to accomplish this, but any substantial change shall not be made without prior written approval from the Owner.
- C. Equipment bases mounted on concrete slabs and pads, or mounted on stands, gratings, platforms, or other, shall not be set in any manner, except on the finished and permanent support.
- D. Support of equipment on studs or other means, and the placing or building of the supporting slab, pad, pier, stand, grating, or other "to the equipment", is prohibited.
- E. Concrete supporting structures shall have been constructed and cured a minimum of 14 days before equipment is mounted.

3.02 OPENINGS

- A. The responsibility for determining the exact size and location of openings is part of the Work of this section. If this responsibility is not met, cutting and patching to achieve the correct size and location of openings and chases is part of the work of this section.

3.03 CUTTING AND PATCHING

- A. Do all cutting and patching required except cutting and patching of finish (visible) materials. Cutting and patching of masonry walls, partitions, ceilings and floors is included. Concrete cutting shall be done with abrasive wheels or saws, and coring with a diamond core bit. Jackhammers are prohibited.

3.04 CONNECTIONS TO EQUIPMENT

- A. Connections shall be provided by the Subcontractor unless otherwise indicated. Unless otherwise indicated, the size of the connections to each piece of equipment shall be not smaller than the connections on the equipment. No bushed connections shall be permitted. Change in sizes shall be made with reducers or increasers only.

3.05 SUPPORTS

- A. General
 - 1. Hangers used to support piping 2 inches and larger shall be fabricated to permit adequate adjustment after erection while supporting the load.
- B. Pipe Hangers and Supports
 - 1. Pipe hangers and supports shall conform to MSS SP-58 and MSS SP-69, except as specified as follows:

- a. Types 5, 12, and 26 shall not be used.
- b. Type 3 shall not be used on insulated pipe which has a vapor barrier. Type 3 may be used on insulated pipe that does not have a vapor barrier if clamped directly to the pipe and if the clamp bottom does not extend through the insulation and the top clamp attachment does not contact the insulation during pipe movement.
- c. Type 19 and 23 C-clamps shall be torqued per MSS SP-69 and have both locknuts and retaining devices, furnished by the manufacturer. Field-fabricated C-clamp bodies or retaining devices are not acceptable.
- d. Type 20 attachments used on angles and channels shall be furnished with an added malleable iron heel plate or adapter.
- e. Type 24 may be used only on trapeze hanger systems or on fabricated frames.
- f. Horizontal pipe supports shall be spaced as specified in MSS SP-69 and a support shall be installed not over 1 foot from the pipe fitting joint at each change in direction of the piping. Pipe supports shall be spaced not over 5 feet apart at valves.
- g. Vertical pipe shall be supported at intervals of not more than 15 feet, except that pipe shall be supported not more than 8 feet from end of risers, and at vent terminations.
- h. Except for Type 3, pipe hangers on horizontal insulated pipe shall be the size of the outside diameter of the insulation.

3.06 PIPE EXPANSION

- A. The expansion of pipes shall be provided for by changes in the direction of the run of pipe.

3.07 DUCTWORK

- A. Installation shall be according to SMACNA HVAC DUCT CONSTRUCTION STANDARDS, latest edition unless otherwise indicated. Duct supports for sheet metal ductwork shall be according to SMACNA HVAC DUCT CONSTRUCTION STANDARDS, latest edition unless otherwise specified. Friction beam clamps indicated in SMACNA HVAC DUCT CONSTRUCTION STANDARDS, latest edition unless otherwise indicated shall not be used. Supports shall be attached only to structural framing members. Supports shall not be anchored to metal decking unless a means is provided and approved for preventing the anchor from puncturing the metal decking. Where supports are required between structural framing members, suitable intermediate metal framing shall be provided. Where C-clamps are used, retainer clips shall be provided.

- B. Dust Control: To prevent the accumulation of dust, debris and foreign material during construction, temporary dust control protection shall be provided. The distribution system (supply and return) shall be protected with temporary seal-offs at all inlets and outlets at the end of each day's Work. Temporary protection shall remain in place until system is ready for startup.
- C. Power Transmission Components Adjustment: V-belts and sheaves shall be tested for proper alignment and tension prior to operation and after 72 hours of operation at final speed. Belts on drive side shall be uniformly loaded, not bouncing. Alignment of direct driven couplings shall be to within 50 percent of manufacturer's maximum allowable range of misalignment.

3.08 AIR SYSTEMS BALANCING

- A. The building shall be essentially complete with final ceiling, walls, windows, doors and partitions in place. Doors and windows surrounding each area to be balanced shall be closed during testing and balancing operations. Air systems shall be complete and operable with registers, ducting, diffusers, returns, and control components in place. Fans shall be operational. Air motion and distribution from air terminals shall be as shown. All data including deficiencies encountered and corrective action taken shall be recorded. If a system cannot be adjusted to meet the design requirements, promptly notify the Engineer in writing.
- B. Air Systems
 - 1. Each system shall be adjusted until all flow quantities are within plus 10% and minus 0%. Dampers shall be checked for tight shutoff. Air leakage around dampers shall be verified. Fans shall be checked for correct direction of rotation and proper speed shall be verified.
 - 2. General Balancing Methods
 - a. Air flow adjustments shall be made by first adjusting the fan speed to meet the design flow conditions. Flows shall be checked at all supply and exhaust outlets. All flows shall be recorded before and after each adjustment.
- C. Control Systems
 - 1. Testing, adjusting, and balancing of the systems shall be coordinated with the control system installation. All control components shall be verified to be properly installed and operating as specified before proceeding with testing, adjusting, and balancing. Verification shall be in accordance with AABC MN-1.
 - 2. Adjustment of the temperature controls shall be coordinated by the person in charge of the balancing and adjusting and shall be performed coincidental therewith. Simulate a complete cycle of operation for each system.

3.09 BASES AND SUPPORTS

- A. In addition to supports and hangers as mentioned in Section 05500, provide all bases and supports not part of the building structure, of required size, type, and strength, as approved by the Engineer, for all equipment and materials furnished by him. All equipment, bases and supports shall be adequately anchored to the building structure to prevent shifting of position under operating conditions.
- B. All concrete foundations and all concrete supports will be provided by the General Contractor. Furnish shop drawings and templates for all concrete foundations and supports for setting all required hanger and foundation bolts and other appurtenances necessary for the proper installation of his equipment.

3.10 MISCELLANEOUS IRON AND STEEL

- A. All Work shall be cut, assembled, welded and finished by skilled mechanics. Welds shall be ground smooth. Stands, brackets, and framework shall be properly sized and firmly constructed.
- B. Measurements shall be taken on the job and worked out to suit adjoining and connecting Work. All Work shall be by experienced metal working mechanics. Members shall be straight and true and accurately fitted. Scale, rust, and burrs shall be removed. Welded joints shall be ground smooth where exposed. Drilling, cutting and fitting shall be done as required to properly install the work and accommodate the work of other trades as directed by them.
- C. Members shall be generally welded, except that bolting may be used for field assembly where welding would be impractical.
- D. All shop fabricated iron and steel work shall be cleaned and dried and given a shop coat of paint on all surfaces and in all openings and crevices.

3.11 PLACING IN SERVICE

- A. At the completion of performance tests and following approval of test result, recheck all equipment to see that each item is adequately lubricated and functioning correctly.

3.12 CLEANING AND ADJUSTING

- A. During the progress of the Work, clean up and remove all oil, grease, and other debris caused by the Work performed under this section.
- B. At the conclusion of the Project, clean and repair all areas and finishes as installed or affected by this installation of Work under this section.
- C. Equipment: Equipment shall be wiped clean, with all traces of oil, dust, dirt, or paint spots removed. System shall be maintained in this clean condition until final acceptance. Bearings shall be properly lubricated with oil or grease as recommended by the manufacturer. Belts shall be tightened to proper tension.

3.13 INSULATION

A. Application - General

1. Installation: Except as otherwise specified, material shall be installed in accordance with the manufacturer's written instructions. Insulation materials shall not be applied until tests specified in other sections of the Specifications are completed. Material such as rust, scale, dirt and moisture shall be removed from surfaces to receive insulation. Insulation shall be kept clean and dry. Insulation shall not be removed from its shipping containers until the day it is ready to use and shall be returned to like containers or equally protected from dirt and moisture at the end of each workday. Insulation that becomes dirty shall be thoroughly cleaned prior to use. If insulation becomes wet or if aforementioned cleaning does not restore the surfaces to like new condition, the insulation may be rejected, and if rejected, shall be immediately removed from the jobsite. Joints shall be staggered on multilayer insulation. Mineral fiber thermal insulating cement shall be mixed with demineralized water when used on stainless steel surfaces. Insulation, jacketing and accessories shall be installed in accordance with MICA-01 standard plates except where modified herein or on the Contract Drawings.
2. Firestopping: Where pipes pass through fire walls and fire partitions, the penetration shall be sealed with firestopping materials as specified.
3. Flexible Cellular Insulation: Flexible cellular insulation shall be installed with seams and joints sealed with a contact adhesive. Flexible cellular insulation shall not be used on surfaces greater than 200 degrees F.

B. Pipe Insulation Installation

1. General: Pipe insulation shall be continuous and installed on fittings and appurtenances unless specified otherwise. Installation shall be with full length units of insulation and using a single cut piece to complete a run. Cut pieces or scraps abutting each other shall not be used.
2. Pipes Passing Through Sleeves
 - a. Pipe insulation shall be continuous through the sleeve.
 - b. An aluminum jacket with factory applied moisture barrier shall be provided over the insulation wherever penetrations require sealing.
 - c. Where penetrating interior walls, the aluminum jacket shall extend 2 inches beyond either side of the wall and shall be secured on each end with a band.
 - d. Where penetrating floors, the aluminum jacket shall extend from a point below the backup material to a point 10 inches above the floor with one band at the floor and one not more than 1 inch from the end of the aluminum jacket.

- e. Where penetrating exterior walls, the aluminum jacket required for pipe exposed to weather shall continue through the sleeve to a point 2 inches beyond the interior surface of the wall.
3. Pipes Passing Through Hangers
- a. Insulation, whether hot or cold application, shall be continuous through hangers. All horizontal pipes 2 inches and smaller shall be supported on hangers with the addition of a Type 40 protection shield to protect the insulation in accordance with MSS SP-69 whenever insulation shows signs of being compressed, or when the insulation or jacket shows visible signs of distortion at or near the support shield, insulation inserts as specified below for piping larger than 2 inches shall be installed.
 - b. Inserts shall be covered with a jacket material of the same appearance and quality as the adjoining pipe insulation jacket, shall overlap the adjoining pipe jacket 1-1/2 inches, and shall be sealed as required for the pipe jacket. The jacket material used to cover inserts in flexible cellular insulation shall conform to ASTM C 921, Type 1, and is allowed to be of a different material than the adjoining insulation material.
4. Flexible Cellular Pipe Insulation: Flexible cellular pipe insulation shall be tubular form. Sweat fittings shall be insulated with miter cut pieces the same size as on adjacent piping.

C. Duct Insulation Installation

- 1. Insulate supply, return and exhaust ductwork outdoors from the roof penetration to ERV-1 to a value of R-12. Cover ductwork with weatherproof jacketing equal to VentureClad.
- 2. Insulation shall be attached by applying Class 2 adhesive around the entire perimeter of the duct in 6 inch wide strips on 12 inch centers.
- 3. For ducts and plena, 24 inches and larger insulation shall be additionally secured to bottom of ducts by the use of mechanical fasteners. Fasteners shall be spaced on 18-inch centers and not more than 18 inches from duct corners.
- 4. Insulation shall be impaled on the mechanical fasteners where used and shall be pressed thoroughly into the adhesive. Care shall be taken to ensure vapor barrier jacket joints overlap 2 inches. The insulation shall not be compressed to a thickness less than that specified. Insulation shall be carried over standing seams and trapeze-type duct hanger. Self-locking washers shall be installed where mechanical fasteners are used. The pin shall be trimmed back and bent over.
- 5. Jacket overlaps shall be secured under the overlap with Class 2 adhesive and stapled on 4 inch centers. Staples and seams shall be coated with a brush coat of vapor barrier coating.

6. Breaks in the jacket material shall be covered with patches of the same material as the vapor barrier. The patches shall extend not less than 2 inches beyond the break or penetration in all directions and shall be secured with Class 2 adhesive and staples. Staples and joints shall be sealed with a brush coat of vapor barrier coating.
 7. At jacket penetrations such as hangers and damper operating rods, voids in the insulation shall be filled and the penetration sealed with a brush coat of vapor barrier coating.
 8. Insulation terminations and pin punctures shall be sealed and flashed with a reinforced vapor barrier coating finish. The coating shall overlap the adjoining insulation and uninsulated surface 2 inches. Pin puncture coatings shall extend 2 inches from the puncture in all directions.
 9. Where insulation standoff brackets occur, insulation shall be extended under the bracket and the jacket terminated at the bracket.
- D. Duct Test Holes: after duct systems have been tested, adjusted, and balanced, breaks in the insulation and jacket shall be repaired in accordance with the applicable section of this specification for the type of duct insulation to be repaired.

3.14 OPERATING AND MAINTENANCE INSTRUCTIONS

- A. Operation and Maintenance Manuals shall be provided in accordance with Section 01730.
- B. All operating equipment installed under this section shall be placed in operation and shall function continuously in an operating test for a period of one week without shutdown due to mechanical failure or necessity of adjustment. Prior to scheduling the Project Final Inspection and after completion of all installation and running adjustments, perform all work required to place the equipment in complete operating condition to meet all requirements under the Specifications.
- C. During this running test period, deliver to the designated representative of the Owner, through the Engineer, 6 complete sets of operating, service and replacement data for all equipment which will require operating maintenance or replacement and one copy of this literature shall be available during the instruction of the operating personnel while the other is checked for completeness by the Engineer.

3.15 TRAINING

- A. Conduct a training course for the maintenance and operating staff. The training period of eight (8) hours normal working time shall start after the system is functionally complete but before the final acceptance tests. The training shall include all of the items contained in the operating and maintenance instructions as well as demonstrations of routine maintenance operations. The Engineer shall be given at least 2 weeks advance notice of such training.
- B. During all working hours of the one-week operating test, instruction personnel shall be available for and provide thorough and detailed training to the Owner's operating and

maintenance personnel in operation, maintenance and adjustment of all equipment installed.

- C. Give sufficient notice to the designated operating personnel of the owner in advance of this period. Upon completion of instruction, obtain from such representatives written verification on that which the above-mentioned instruction has been performed, such verification to be forwarded to the Engineer.

END OF SECTION

(THIS PAGE INTENTIONALLY LEFT BLANK)

DIVISION 16

(THIS PAGE INTENTIONALLY LEFT BLANK)

SECTION 16000

BASIC ELECTRICAL REQUIREMENTS

PART 1 – GENERAL

1.01 DESCRIPTION

- A. The work of this section includes all labor, materials, tools, equipment, and accessory items and performing all operations necessary to furnish and install the complete electrical work in accordance with this section of these specifications, the drawings and the standards of the applicable codes listed herein.
- B. The work shall include, but not be limited to, furnishing and installation of equipment and items listed below and installation only of items furnished under other sections of these specifications.
 - 1. Complete electrical building service as hereinafter specified.
 - 2. Conduit, wire and electrical connections are required on certain items specified in sections of these specifications other than the electrical section. This Contractor shall examine all sections of these specifications to determine the complete scope of the electrical work.
 - 3. Raceways and fittings
 - 4. Wires and cables
 - 5. Variable Frequency Drives
 - 6. Miscellaneous equipment
 - 7. Panelboards
 - 8. Lighting systems
 - 9. Generator
 - 10. Grounding systems
 - 11. Underground system
 - 12. Security Alarm system
 - 13. Demolition of existing electrical systems.
- C. Mount and wire operator's stations, power conversion equipment, and motor control systems furnished under other Divisions of these Specifications.
- D. Install and make all field connections to variable frequency drives, process instrument panels and other control panels furnished under other Divisions of these Specifications.

- E. Mount and wire process instruments and control cabinets furnished under other Divisions of these Specifications. Furnish and install all conduit, wire and interconnections between process instrumentation primary elements, transmitters, local indicators and receivers. Mount and wire all lightning and surge protection equipment at process instrumentation transmitters and receivers.
- F. Mount and make field connections to “packaged” equipment furnished under other Divisions of these Specifications.
- G. Provide conduit and power/control wiring for all HVAC (Heating, Ventilation and Air Conditioning) and Plumbing equipment furnished under other Divisions of these Specifications.
- H. Install and wire all thermostats, controllers and other devices furnished under other Divisions of these specifications which directly control HVAC equipment.
- I. Documents Applicable to the Work of this Section:
 - 1. Division 0 of the Contract Documents (Contract Forms and Requirements).
 - 2. Division 1 of the Technical Specifications.
 - 3. Technical Specifications: Section 16000 - Basic Electrical Requirements, and the following sub-sections:
 - a. Section 16060 – GROUNDING SYSTEM
 - c. Section 16080 – UNDERGROUND SYSTEMS
 - b. Section 16085 – MISCELLANEOUS EQUIPMENT
 - c. Section 16120 – WIRE AND CABLES
 - d. Section 16130 – RACEWAYS AND FITTINGS
 - e. Section 16442 – PANELBOARDS
 - f. Section 16495 – VARIABLE FREQUENCY DRIVES
 - g. Section 16500 – LIGHTING SYSTEM
 - i. Section 16612 – ENGINE GENERATOR
 - j. Section 16720 – SECURITY ALARM SYSTEMS
 - k. Section 17300 – INSTRUMENTATION AND CONTROLS
- J. Drawings: Work specifically required under this Section includes all Electrical work shown on or required by Contract Drawings E-1 thru E-14.

1.02 SUBMITTALS

- A. Submit the following in accordance with Section 01300:
 - 1. Circuit breakers
 - 2. Variable Frequency Drives
 - 3. Dry type transformers
 - 4. Panelboards
 - 5. Generator
 - 6. Automatic transfer switch

7. Lighting fixtures
 8. Disconnect switches
 9. Control stations
 10. Miscellaneous equipment
 11. Security Alarm System
- B. The manufacturer's data sheets with product designation or catalog numbers shall be submitted for the following material:
1. Wire
 2. Conduit
 3. Receptacles
 4. Boxes and fittings
- C. Submit all other data as specified herein.
- D. The responsibility for all dimensions to be confirmed and correlated at the job site and for coordination of this work with the work of all other trades is also included under the work of this Section 16000.
- E. No material shall be ordered or shop work started until the Engineer's approval of shop drawings has been given.
- F. Prior to submitting shop drawings for lighting fixtures, verify the type of ceiling suspension systems being installed. Notify Engineer of any discrepancies between fixture type specified and suspension system. Additional cost rising from failure to notify the Engineer will be the responsibility of the Contractor.
- G. Operation and Maintenance Manuals - Prepare manuals in accordance with Section 01730.
- H. Record Drawings - Prepare as specified in Part 1 of this Section.

1.03 DELIVERY, STORAGE AND HANDLING

- A. Provide in accordance with Section 01600 and as specified herein.
- B. Electrical equipment shall at all times during construction be adequately protected against mechanical injury or damage by water. Electrical equipment shall not be stored out-of-doors. Electrical equipment shall be stored in dry permanent shelters. If stored for more than two weeks, the equipment shall receive all maintenance considerations required by the manufacturer for the proper storage of equipment. Proper storage in this context shall include the provision of heaters and dehumidifiers to keep the equipment dry at all times. If any apparatus has been damaged, such damage shall be repaired at no additional cost to the Owner. If any apparatus has been subject to possible injury by water, it shall be thoroughly dried out and put through such special tests as directed by the Engineer, or shall be replaced at no additional cost to the Owner.

1.04 DESIGN CRITERIA

A. Service Characteristics

1. Primary Utility Voltage: 13.8KV
2. Secondary Building Voltage - High Level: 480/277 V
3. Secondary Building Voltage - Low Level: 120/208V
4. All equipment and wiring shall be suitable for the applied voltage.

B. Service and Metering

1. The power company serving this project is Taunton Municipal Light and Power (TMLP).
2. For the new pump station, a new service that will be obtained at 480/277Volts, 3-phase, 4-wire from new utility pole and pad mounted transformer provided by the utility company.
3. For the new pump station furnish and install the primary service conduit, primary service 15KV cable, 15KV terminations, and transformer mounting pad. TMLP shall install contractor supplied terminators at the utility pole.
3. Coordinate with TMLP to facilitate the replacement of the existing pump station's electrical service.
4. For both the existing and new pump stations furnish and install the secondary service conduit, wire and connectors.
5. TMLP will provide the meter, the contractor shall provide the meter socket in accordance to the utility company requirements. TMLP shall provide and install all metering transformers and associated wiring.
6. All work and material for the electrical service shall be in accordance with the requirements of each utility company.
7. Make all arrangements with the power utility company for obtaining the service and furnish all labor and material for the service. Submit any utility fee invoice(s) associated with the service replacement to the Owner. The Owner shall make direct payment(s) for the fee(s) to Taunton Municipal Light and Power.

C. Requirements of the Regulatory Agencies

1. The final, complete installation shall comply with all state and local statutory requirements having jurisdiction. The Contractor shall arrange for all necessary permits, pay all fees and arrange for all required inspections by local authorities. In general, all work shall comply with the requirements of the National Electrical

Code, all state codes and the codes and ordinances of the city or town in which the work is to be done.

D. Tests and Settings

1. Test all systems furnished under DIVISION 16 - ELECTRICAL and repair or replace all defective work. Make all necessary adjustments to the systems and instruct the Owner's personnel in the proper operation of the system.
2. Make all circuit breaker and motor circuit protector settings based on the connected equipment manufacture's recommendations.
3. The following minimum tests and checks shall be made prior to the energizing of electrical equipment. A certified test report shall be submitted stating that the equipment meets and operates in accordance with manufacturer's and job specifications, and that equipment and installation conforms to all applicable standards and specifications.
 - a. Testing of protective relays, static devices, transfer switches, circuit breakers and motor circuit protectors for calibration and proper operation and settings.
 - b. Over potential, high potential, insulation resistance and shield continuity tests for cables.
 - c. Mechanical inspection of switches, transfer switches and circuit breakers.
4. The Engineer shall be immediately notified of any unfavorable test results or indication of faulty equipment. No piece of equipment shall be energized until the test data is evaluated and the equipment is proven acceptable.
5. If the test and inspection data submitted should indicate deficiencies in the operation of the electrical apparatus or in the manufacturer thereof, the Contractor shall promptly implement the necessary adjustments, corrections, modifications and/or replacements necessary to be made to meet the specified requirements.

1.05 RELATED WORK NOT INCLUDED

- A. Excavation and backfilling, including gravel or sand bedding for underground electrical work is included under DIVISION 2 - SITE WORK of these Specifications.
- B. Concrete work, including concrete electrical duct encasement, is included under DIVISION 3 - CONCRETE of these Specifications.

1.06 SLEEVES AND FORMS FOR OPENINGS

- A. Provide and place all sleeves for conduits penetrating floors, walls, partitions etc. When located in formed concrete walls locate all necessary slots for electrical work and form before concrete is poured.
- B. Provide waterproof sealing for the penetrations through exterior walls, etc.
- C. Provide fireproof sealing for penetrations through fireproof walls, etc.
- D. Foam type fire and water proofing is not allowed.

1.07 CORING

- A. Provide all coring for conduits penetrating floors, walls, partitions etc.
- B. Provide waterproof sealing for the penetrations through exterior walls, etc.
- C. Provide fireproof sealing for penetrations through fireproof walls, etc.
- D. Foam type fire and water proofing is not allowed.

1.08 SUPPLEMENTARY SUPPORTING STEEL

- A. Provide all supplementary steelwork required for mounting or supporting equipment and materials.
- B. Steelwork shall be firmly connected to building construction as required.
- C. Steelwork shall be of sufficient strength to allow only minimum deflection in conformity with manufacturer's published requirements.
- D. All supplementary steelwork shall be installed in a neat and workmanlike manner parallel to floor, wall and ceiling construction; all turns shall be made at forty-five and ninety degrees, and/or as dictated by construction and installation conditions.
- E. All manufactured steel parts and fittings shall be galvanized steel for NEMA 12 Areas and stainless steel for NEMA 4X and NEMA 7 areas.

1.09 ELECTRICAL HAZZARDOUS CLASSIFCATION AND NEMA RATINGS FOR ELECTRICAL INSTALATION AND ENCLOSURES

- A. Unclassified, NEMA Type 12 for Building's Ground Floor level
- B. Unclassified, NEMA Type 4 for Building Mezzanine and Basement levels.
- C. Unclassified, NEMA Type 4X for Building exterior.

- D. Class 1, Division I, NEMA Type 7 for Wet Well.

1.10 INTERPRETATION OF DRAWINGS

- A. The Drawings are not intended to show exact routing of conduit runs or terminations. Contractor shall determine exact location of conduit terminations by examinations of approved shop drawings. The Contractor shall not reduce the size or number of conduit runs indicated on the drawings.
- B. The final routing of raceways shall be determined by structural conditions, interferences with other trades and by terminal locations on apparatus. The Engineer reserves the right of a reasonable amount of shifting at no extra cost up until time of roughing in the work.
- C. Locate pull boxes, panelboards, control pushbuttons, terminal cabinets, safety switches and such other apparatus as may require periodic maintenance, operation, or inspection, so that they are easily accessible. If such items are shown on the drawings in locations which are found to be inaccessible, advise the Engineer of the situation before work is advanced to the point where extra costs will be involved.
- D. Each three-phase circuit shall be run in a separate conduit unless otherwise shown on the drawings.
- E. Unless otherwise approved by the Engineer conduits shown exposed shall be installed exposed; conduits shown concealed shall be installed concealed.
- F. Where circuits are shown as “home-runs” all necessary fittings and boxes shall be provided for a complete raceway installation.
- G. In general, wiring and raceway systems for lighting, receptacles, fire alarm, telephone and intercommunications systems are not indicated on the drawings but shall be furnished and installed under this section.
- H. Each branch circuit shall have its own neutral, dedicated to that circuit. A common neutral for more than one single phase circuit is not allowed.
- I. Verify with the Engineer the exact locations and mounting heights of lighting fixtures, switches and receptacles prior to installation.
- J. Any work installed contrary to drawings shall be subject to change as directed by the Engineer, and no extra compensation will be allowed for making these changes.
- K. The locations of equipment, fixtures, outlets, and similar devices shown on the drawings are approximate only. Exact locations shall be as approved by the Engineer during construction. Obtain in the field all information relevant to the placing of electrical work and in case of any interference with other work, proceed as directed by the Engineer and furnish all labor and materials necessary to complete the work in an approved manner.
- L. Circuits on three phase panelboards shall be field connected to result in evenly balanced loads on each phase.

- M. Surface mounted panel boxes, junction boxes, conduit, etc., shall be supported by spacers to provide a clearance between wall and equipment.
- N. Circuit layouts are not intended to show the number of fittings, or other installation details. Furnish all labor and materials necessary to install and place in satisfactory operation all power, lighting, and other electrical system shown. Additional circuits shall be wherever needed to conform to the specific requirements of the equipment.
- O. All connections to equipment shall be made as required, and in accordance with the approved shop and setting drawings.
- P. Schematic diagrams shown on the drawings indicate the required functions only. Standard circuits of the particular manufacturer may be used to accomplish the functions indicated without exact adherence to the schematic drawings shown. Additional wiring or conduit required for such deviations shall be furnished at Contractor's expense. Contractor must ensure that all components necessary to accomplish the required function are provided.

1.11 SIZE OF EQUIPMENT

- A. Investigate each space in the structure through which equipment must pass to reach its final location. If necessary, the manufacturer shall be required to ship his material in sections sized to permit passing through such restricted areas in the structure.
- B. The equipment shall be kept upright at all times. When equipment has to be tilted for ease of passage through restricted areas during transportation, the manufacturer shall be required to brace the equipment suitable, to insure that the tilting does not impair the functional integrity of the equipment.

1.12 WORK IN EXISTING STRUCTURES

- A. Each bidder or his authorized representatives shall, before preparing his proposal, visit all areas of the existing structures in which work under this bid is to be performed and inspect carefully the present installation. The submission of the proposal by this bidder shall be considered evidence that he or his representative has visited the buildings and structures and noted the locations and conditions under which the work will be performed and that he takes full responsibility for a complete knowledge of all factors governing his work.
- B. In general, any or all existing electrical equipment and services are to remain in operation and shall not be disturbed unless otherwise noted in these Specifications and/or on the drawings or as required for the proper execution of the work.
- C. In each area of the work, disconnect and carefully remove the existing electrical equipment and devices so noted. With the exception of items indicated as having to be re-used, all such existing equipment and device shall be turned over to the Owner. If not required by the Owner, remove them from the premises and site. All existing electrical equipment and devices indicated as not removed or abandoned are to be maintained in

operation and any circuits disturbed by the construction shall be restored.

- D. Maintain existing electrical services and systems to and in the buildings throughout the project and all “down-time” shall be scheduled at least three weeks in advance with the permission of the Owner and such scheduling shall be rigidly adhered to.

1.13 TEMPORARY POWER AND LIGHTING

- A. The Electrical Subcontractor shall furnish and install feeders of sufficient size from the utility company for the electric light and power requirements for the project while under construction and until the permanent feeders and related equipment have been installed and are in operation. Temporary lighting shall be based on a minimum of one watt per square foot covering each and every square foot in the building. Sufficient wiring, lamps, and outlets shall be installed to insure proper lighting in all rooms, space, and stairwells. Minimum sized lamp used shall be 1500 lumens. Where higher lighting intensities are required by Federal or State Standards of Laws or otherwise specified, the above specified lumens shall be increased to provide these increased intensities.
- B. All necessary transformers, meters, cables, panelboards, switches, temporary lamp replacements and accessories required for the temporary light and power installation shall be provided by the Electrical Subcontractor.
- C. The Electrical Subcontractor shall provide and maintain in each area of the building and the building exterior, a feeder or feeders of sufficient capacity for the requirements of the entire floor and he shall provide a sufficient number of outlets, located at convenient points, so that extension cords of not over 50 ft. in length will reach all work requiring temporary light or power.
- D. The Electrical Subcontractor shall install and maintain the wiring and accessories for the portable trailer office of the General Contractor.
- E. All temporary electrical work shall meet the requirements of the National Electrical Code Article 305 Temporary Wiring, the Local Utility Company, and all Federal Standards and Laws.
- F. All temporary wiring and accessories thereto installed by the Electrical Subcontractor shall be removed after their purposes have been served.
- G. The General Contractor will pay for the cost of electric energy consumed by himself and by all of his Subcontractors, unless otherwise indicated.
- H. Provide all temporary lighting and power required above during the normal working hours of the project or a total of ten (10) hours per normal working day; Saturdays, Sundays and legal holidays are excluded. The ten hours per day shall include manning the temporary power and lighting 2 hour before and 2 hour after a normal eight (8) hour working day. In addition to the above, provide and maintain, to the satisfaction of the local authorities having jurisdiction, all temporary lighting and power that may be required for safety purposes. The Electrical Subcontractor will be compensated by the General Contractor for any additional standby time, materials or equipment required by

the General Contractor or other Subcontractors beyond the normal working hours, as defined above.

1.14 RECORD DRAWINGS

- A. Record drawings shall be provided under this Section in accordance with Section 01780 and as specified herein.
- B. As work progresses and for the duration of the Contract, maintain a complete and separate set of prints of Contract Drawings at the job site at all times. On a daily basis, record work completed and all changes from original Contract Drawings clearly and accurately, including work installed as a modification or addition to the original design such as change orders, instructions issued by the Engineer, or conditions encountered in the field.
- C. Drawings shall show record condition of details, sections, and riser diagrams, and control changes. Schedules shall show actual manufacturer and make and model numbers of final equipment installation. Remove all superceded data to show the completed work. Accurately indicate the location, size, type, and elevation of new utilities and their relationship to other utilities.
- D. The Record Drawings will be used as a guide for determining the progress of the Work installed. They shall be inspected on a regular basis and shall be corrected immediately if found inaccurate or incomplete. Requisitions for payment will not be approved until the Drawings are accurate and up-to-date.
- E. At completion of Work prepare a complete set of Record Drawings showing all systems as actually installed. The Contract Drawing electronic CAD files will be made available for this Contractor's copying, at his expense, into reproducibles to serve as backgrounds for the Record Drawings. Provide all drawings necessary to show the required as-built information. Submit three sets of prints to the Engineer for comments as to compliance with this Section. Make all modifications so noted by the Engineer.
- F. Certify the accuracy of the record drawings. Record Drawings shall become the property of the Owner.
- G. When required by jurisdiction, submit the record set for approval by the Authority Having Jurisdiction in a form acceptable to the jurisdiction.

1.15 COMPONENT INTERCONNECTIONS

- A. Components of equipment furnished under this Specification will not be furnished as integrated systems.
- B. Analyze all systems components and their shop drawings; identify all terminals and prepare drawings or wiring tables necessary for component interconnection.
- C. Furnish and install all component interconnections.

1.16 MANUFACTURER'S SERVICES

- A. Provide manufacturer's services for testing, training and start-up of the following equipment:
 - 1. Generator.
 - 2. Automatic Transfer Switch.
 - 3. Variable Frequency Drives.
 - 4. The time required for each system shall be as hereinafter specified. The time specified shall be used as directed by the Engineer and shall not be used by the manufacturer or Contractor for field adjustments due to manufacturing or shipping defects.

1.17 MATERIALS

- A. Materials and equipment used shall be Underwriters Laboratories, Inc. listed wherever standards have been established by that agency. Written approval by the Engineer and local inspecting authority is required wherever UL Listed approval is not available.
- B. Manufacturer of Principal Equipment
 - 1. All lighting and power panelboards shall be made by one manufacturer.
 - 2. All conduit of a given type shall be made by one manufacturer.
 - 3. All wire and cables of a given type shall be made by one manufacturer.
 - 4. All three phase magnetic motor starters furnished shall be made by one manufacturer.

1.18 WARRANTY

- A. Provide warranty and guarantee on all equipment furnished and work performed for a period of one (1) year from the date of substantial completion.

PART 2 (NOT USED)

PART 3 (NOT USED)

- END OF SECTION -

(THIS PAGE INTENTIONALLY LEFT BLANK)

SECTION 16060

GROUNDING SYSTEMS

PART 1 – GENERAL

1.01 DESCRIPTION

- A. The work of this section includes the furnishing and installing of a complete grounding system in strict accordance with Article 250 of the National Electrical Code and as specified herein and as shown on the drawings.

1.02 SUBMITTALS

- A. Submit the following in accordance with Section 01300:
 - 1. Conduit
 - 2. Wire
 - 3. Ground rods
 - 4. Ground bus bars

1.03 DELIVERY, STORAGE AND HANDLING

- A. Provide in accordance with Section 01600.
- B. All materials shall be shipped, stored, handled and installed in such a manner as not to degrade quality, serviceability, or appearance.

PART 2 – PRODUCTS

2.01 CONDUIT

- A. Conduit shall be as specified under Section 16130 (Raceways and Fittings).

2.02 WIRE

- A. Wire shall be as specified under Section 16120 (Wire and Cables).

2.03 GROUND RODS

- A. Ground rods shall be copper clad steel 3/4 inch in diameter and 10 feet in length unless otherwise shown on the drawings. Rods shall one 10 foot length rod. Ground rods shall be Copperweld, equal by A.B. Chance Co., or equal.

2.04 GROUNDING BUS BARS

- A. Provide a grounding bus bar next to or below the main distribution board or main disconnect, ground bus bar to be approximately 8" above finished floor.

- B. Grounding bus bars shall be copper, not less than ¼ inch by 2 inch by 24 inch.
- C. All lugs, bolts and nuts shall be silicon bronze.
- D. Buses shall be mounted to the room wall with standoff isolators, standoff brackets, and mounting bolts.

PART 3 – EXECUTION

3.01 INSTALLATION

- A. Grounding electrode conductors shall be run in rigid steel conduits. Protecting conduits shall be bonded to the grounding electrode conductors at both ends.
- B. Grounding conductors shall be run with feeders where shown on the drawings or hereinafter specified.
- C. Liquid tight flexible metal conduit in sizes 1 inch and larger shall have bonding jumpers. Bonding jumpers shall be external, run parallel (not spiraled) and fastened with plastic tie wraps. Tie wraps shall be installed 12 inches apart and not more than 6 inches from ends.
- D. Connect the following equipment by separate wire or cable directly to the grounding grid system:
 - 1. Frame of each transformer
 - 2. Neutral of each transformer
 - 3. Service entrance circuit breaker
 - 4. Ground buses
 - 5. Metal Fencing
 - 6. Generator Enclosure
 - 7. Door frames and railings.
- E. Connect the following equipment by separate wire or cable to the ground bus in the distribution equipment servicing the equipment:
 - 1. Switchboard
 - 2. Panelboards
 - 3. 480 Volt motors
 - 4. Control panels
 - 5. All feeders and branch circuits
 - 6. Receptacle circuits
- F. The following equipment shall be grounded through the metallic raceway systems with permanent and effective ground connections:
 - 1. All metal cases and support frames
 - 2. Lighting system
 - 3. 120 Volt motors

- G. Bond the following N.E.C. approved electrodes together to form a ground grid system:
1. Metallic water main
 2. Building steel frame
 3. Steel reinforcing rods within concrete at 4 ft. intervals.
 4. Grounding rods and buses
 5. Buried bare copper conductors
- H. Grounding electrodes shall be driven where shown on the drawings. Spacing between electrodes shall be twice the length of the electrodes.
- I. All grounding connections shall be made by means of approved bronze clamps. Exposed connections between different metals shall be sealed with No-Oxide Paint Grade A, or equal.
- J. All buried connections shall be made by a thermic welding process equal to Cadweld. Molds used for the welding process shall be new having no prior usage. Molds shall be the specific type for the connection to be made.
- K. Light fixture bases shall be furnished with a grounding point.
- L. All buried conductors shall be laid slack in trenches. The earth surrounding the cables shall be void of sharp objects which may injure the cables. Backfill material shall be natural earth. Where cables are exposed to mechanical injury they shall be protected by pipes or other substantial guards. If guards are iron pipe or other magnetic material, conductors shall be electrically connected to both ends of the guard. Connections shall be made as hereinbefore specified.
- M. Do not allow water main connection to be painted. If the connections are painted, they shall be disassembled and remade with new fittings.

3.02 TESTING

- A. The grounding system shall be tested under this section.
- B. The equipment grounding shall be checked to insure continuity of the ground return path.
- C. The ground grid systems shall be tested using the three terminal fall in potential method. A minimum of eight test points for each ground grid system shall be submitted for review by the Engineer. The test points shall be made along a straight line from the grid system to the reference terminal. The distance between the grid system and the reference terminal shall be consistent with normal practices for ground testing.
- D. All test equipment shall be furnished hereunder and shall be similar to Biddle Earth Tester No. 250220 or equal.
- E. These tests shall be performed during the dry season. Tests shall be performed before loaming and seeding or paving work has been performed.

- F. The Contractor shall notify the Engineer immediately if the ground grid system exceeds 5 ohms.

3.03 CLOSEOUT ACTIVITIES

- A. Provide in accordance with Section 01700.

- END OF SECTION -

SECTION 16080

UNDERGROUND SYSTEMS

1.00 PART 1 – GENERAL

1.01 SCOPE

- A. The work of this section includes furnishing and installing of a complete underground system of raceways, handholes, and frames and covers as specified herein and as shown on the drawings.

1.02 SUBMITTALS

- A. Submit the following in accordance with Section 01300:
 - 1. Raceways
 - 2. Handhole frames and covers
 - 3. Warning Tape

1.03 DELIVERY, STORAGE AND HANDLING

- A. Provide in accordance with Section 01600.
- B. All materials shall be shipped, stored, handled and installed in such a manner as not to degrade quality, serviceability, or appearance.

2.00 PART 2 – PRODUCTS

2.01 RACEWAYS

- A. Raceways shall be PVC schedule 40 conduit. Raceway materials shall be in accordance with Section 16130 (Raceways and Fittings).

2.02 HANDHOLES

- A. Non-Utility Hand holes shall be UL listed, made of Polymer Concrete with Polymer Concrete Cover and open bottom.
- B. The polymer concrete shall be molded of sand and aggregate, bound together with a polymer resin, and reinforced with steel or fiberglass or a combination of the two.
- C. Impact resistant tested per ASTM D-2444.
- D. Hand hole enclosure and covers shall meet or exceed the Tier 22 load requirements set forth in the American National Standards Institute's ANSI/SCTE 77 2010
- E. Hand holes shall be a minimum 11"x18".

- F. Covers shall be securely bolted to enclosure with stainless steel bolts and be on type and be embedded with the following logs:
 - 1. "ELECTRICAL" logo for electrical power applications
 - 2. "COMMUNICATIONS" logo telecommunication applications.
 - 3. "CONTROL" logo low voltage applications.
- G. Provide 12 inches of compacted crushed stone under all hand holes

2.03 POLYETHYLENE WARNING TAPE

- A. Warning tape shall be red polyethylene film, 6 inch minimum width, Type XB-720 by W.H. Brady Co., or equal.

3.00 PART 3 – EXECUTION

3.01 INSTALLATION

- A. Raceways shall be installed to drain away from buildings. Raceways between handholes shall drain toward the handholes. Raceway slopes shall not be less than 3 inches per one hundred feet.
- B. Raceway banks shall be encased in concrete. Concrete shall be reinforced with steel rods.
- C. Plastic spacers shall be used to hold raceways in place. Spacers shall provide not less than two inch clearance between raceways.
- D. The minimum cover for raceway banks shall be 30 inches unless otherwise permitted by the Engineer.
- E. Raceway entrances to buildings and structures shall be made with steel conduit not less than ten feet long.
- F. Conduits in duct banks entering buildings and structures shall be spread to allow adequate room for conduit wall seals, pull and terminal boxes.
- G. Where bends in raceways are required, long radius elbows, sweeps and offsets shall be used. Sweeps at riser pole shall be rigid steel encased in concrete.
- H. All raceways shall be swabbed clean before cable installation.
- I. Spare raceways shall be plugged and sealed watertight at all buildings and structures.
- J. Raceways in use shall be sealed watertight at all buildings and structures.
- K. Rigid steel conduit shall be used for risers at the service pole and other locations shown on the drawings. Conduit sweep at pole base shall be rigid steel conduit.
- L. Raceway terminations at manholes shall be with end bells.

- M. Pulling-in irons shall be installed opposite all raceway entrances to manholes.
- N. All underground metallic conduit run underground in direct contact with earth shall be coated with asphaltum or bitumastic varnish or similar corrosion protection the entire length of the run.
- O. All underground raceways/ductbanks shall be marked with warning tape located approximately 12 inches below grade above the raceway/ductbank.
- P. Refer to paragraph titled "Conduit Embedded in Slabs" in Section 16050 (Electrical General Conditions).

- END OF SECTION -

(THIS PAGE INTENTIONALLY LEFT BLANK)

SECTION 16085

MISCELLANEOUS EQUIPMENT

PART 1 – GENERAL

1.01 DESCRIPTION

- A. The work of this section includes the furnishing and installing of all miscellaneous equipment as specified herein and as shown on the drawings.

1.02 SUBMITTALS

- A. Submit the following in accordance with Section 01300:
 - 1. Automatic transfer switch
 - 2. Surge Suppression Devices
 - 3. Disconnect switches
 - 4. Motor starters
 - 5. Dry type transformers
 - 6. Control stations
 - 7. Circuit breakers
 - 8. Enclosure types
 - 9. Wireway
 - 10. Relays
 - 11. Nameplates
 - 12. Meter Socket
 - 13. Fiber Patch Panel
 - 14. Floor Mats
 - 15. Warning Signs
- B. Operation and Maintenance Manuals - Prepare manuals in accordance with Section 01730.
- C. Record Drawings - Prepare as specified in Section 16000.

1.03 DELIVERY, STORAGE AND HANDLING

- A. Provide in accordance with Section 01600.
- B. All materials shall be shipped, stored, handled and installed in such a manner as not to degrade quality, serviceability, or appearance.

1.04 DESIGN CRITERIA

- A. All circuit breakers, magnetic motor starters, and fuses furnished under this section shall be of the same manufacturer for each type of equipment.

PART 2 – PRODUCTS

2.01 AUTOMATIC TRANSFER SWITCH

- A. The automatic transfer switch shall be true 3-pole, solid neutral type, microprocessor based control designed for an emergency and normal source of 480 Volts, 3 Phase, 4 Wire, 60 Hertz. Current ratings shall be as indicated on the drawings.
- B. The complete switch assembly including accessories shall be listed under UL-1008 for use on emergency systems.
- C. The complete transfer switch assembly shall be factory tested to ensure proper operation and compliance with the specification requirements. A copy of the factory test report shall be available upon request.
- D. System Operation
 - 1. When the voltage on any phase of the normal source drops below 80% or increases to 120%, or frequency drops below 90%, or increase to 110%, or 20% voltage differential between phases occurs, after a programmable time delay period of 0-9999 seconds factory set at 3 seconds to allow for momentary dips, the engine starting contacts shall close to start the generating plant.
 - 2. The transfer switch shall transfer to emergency when the emergency source has reached specified voltage and frequency on all phases.
 - 3. After restoration of normal power on all phases to a preset value of at least 90% to 110% of rated voltage, and at least 95% to 105% of rated frequency, and voltage differential is below 20%, an adjustable time delay period of 0-9999 seconds (factory set at 300 seconds) shall delay retransfer to allow stabilization of normal power. If the emergency power source should fail during this time delay period, the switch shall automatically return to the normal source.
 - 4. After retransfer to normal, the engine generator shall be allowed to operate at no load for a programmable period of 0-9999 seconds, factory set at 300 seconds.
- E. Construction
 - 1. The transfer switch shall be double throw, actuated by two electric operators momentarily energized, and connected to the transfer mechanism by a simple over center type linkage. Dual circuit breaker or movable beam construction is not acceptable. Minimum transfer time shall be 400 milliseconds.
 - 2. The normal and emergency contacts shall be positively interlocked mechanically and electrically to prevent simultaneous closing. Main contacts shall be mechanically locked in both the normal and emergency positions without the use of hooks, latches, magnets, or springs, and shall be silver-tungsten alloy. Separate arcing contacts with magnetic blowouts shall be provided on all transfer

switches. Interlocked, molded case circuit breakers or contactors are not acceptable.

3. The transfer switch shall be equipped with a safe manual operator, designed to prevent injury to operating personnel. The manual operator shall provide the same contact to contact transfer speed as the electrical operator to prevent a flashover from switching the main contacts slowly.
4. Transfer switch shall be adequately constructed to carry its full rated current on a continuous 24 hour basis in all approved enclosures and shall not show excessive heating or be subject to de-rating.
5. The minimum withstand and close-in current rating in symmetrical amperes shall be equal to or greater than the interrupting rating of the normal power source circuit breaker. In no case shall this rating be less than 20 times the transfer switch full load current rating. The switch contacts shall not weld or be damaged in any way as a result of a fault of up to the withstand and close-in rating.
6. The main contacts shall be visible for inspection without any major disassembly of the transfer switch.
7. A fully rated solid neutral bus bar with required AL-CU neutral lugs shall be provided.
8. Control components and wiring shall be front accessible. All control wires shall be multiconductor 18 gauge 600-volt SIS switchboard type point to point harness. All control wire terminations shall be identified with tubular sleeve-type markers.
9. The switch shall be equipped with 90 degrees C rated copper/aluminum solderless mechanical type lugs.

F. Controls

1. The transfer switch shall be equipped with a microprocessor based control system, to provide all the operational functions of the automatic transfer switch. The controller shall have two asynchronous serial ports. The controller shall have a real time clock with NiCad battery back up.
2. The CPU shall be equipped with self diagnostics which perform periodic checks of the memory I/O and communication circuits, with a watchdog/power fail circuit
3. A door mounted controller with a 20 character, LCD display, with a keypad, which allows access to the system shall be provided. The controller shall have password protection required to limit access to qualified and authorized personnel.

4. The controller shall include three-phase over/under voltage, over/under frequency, phase sequence detection and phase differential monitoring on both normal and emergency sources.
5. The controller shall be capable of storing the following records in memory for access either locally or remotely:
 - a. Number of hours transfer switch is in the emergency position (total since record reset).
 - b. Number of hours emergency power is available (total since record reset).
 - c. Total transfer in either direction (total since record reset).
 - d. Date, time, and description of the last four source failures.
 - e. Date of the last exercise period.
 - f. Date of record reset.

G. Accessories

1. Programmable three phase sensing of the normal source set to pickup at 90% and dropout at 80% of rated voltage and overvoltage to pickup at 120% and dropout out at 110% of rated voltage. Programmable frequency pickup at 95% and dropout at 90% and over frequency to pickup at 110% and dropout at 105% of rated frequency. Programmable voltage differential between phases, set at 20%, and phase sequence monitoring.
2. Programmable three phase sensing of the emergency source set to pickup at 90% and dropout at 80% of rated voltage and overvoltage to pickup at 120% and dropout out at 110% of rated voltage programmable frequency pickup at 95% and dropout at 90% and over frequency to pickup at 110% and dropout at 105% of rated frequency. Programmable voltage differential between phases set at 20%, and phase sequence monitoring.
3. Time delay for override of momentary normal source power outages (delays engine start signal and transfer switch operation). Programmable 0-9999 seconds. Factory set at 3 seconds, if not otherwise specified.
4. Time delay to control contact transition time on transfer to either source. Programmable 0-9999 seconds, factory set at 3 seconds.
5. Time delay on retransfer to normal, programmable 0-9999 seconds, factory set at 300 seconds if not otherwise specified, with overrun to provide programmable 0-9999 second time delay, factory set at 300 seconds, unloaded engine operation after retransfer to normal.

6. Time delay on transfer to emergency, programmable 0-9999 seconds, factory set at 3 seconds.
7. A maintained type load test switch shall be included to simulate a normal power failure, keypad initiated.
8. A remote type load test switch shall be included to simulate a normal power failure, remote switch initiated.
9. A time delay bypass on retransfer to normal shall be included. Keypad initiated.
10. Dry contact, rated 10 Amps 120 volts AC, to close on failure of normal source to initiate engine starting.
11. Dry contact, rated 10 Amps 120 volts AC, to open on failure of normal source for customer functions.
12. Light emitting diodes shall be mounted on the microprocessor panel to indicate: switch is in normal position, switch is in emergency position and controller is running.
13. An exerciser shall be provided with (10) 7-day events, programmable for any day of the week and (24) calendar events, programmable for any month/day, to automatically exercise generating plant programmable in one-minute increments. Also include selection of either "no load" (switch will not transfer) or "load" (switch will transfer) exercise period. Keypad initiated.
14. Provision to select either "no commit" or "commit" to transfer operation in the event of a normal power failure shall be included. In the "no commit position," the load will transfer to the emergency position unless normal power returns before the emergency source has reach 90% of it's rated values (switch will remain in normal). In the "commit position" the load will transfer to the emergency position after any normal power failure. Keypad initiated.
15. Two auxiliary contacts rated 10 Amp, 120 volts AC , shall be mounted on the main shaft, one closed on normal, the other closed on emergency. Both contacts will be wired to a terminal strip..
16. A three phase digital LCD voltage readout, with 1% accuracy shall display all three separate phase to phase voltages simultaneously, for both the normal and emergency source.
17. A digital LCD frequency readout with 1% accuracy shall display frequency for both normal and emergency source.
18. An LCD readout shall display normal source and emergency source availability.

19. Include (2) time delay contacts that open simultaneously just (milliseconds) prior to transfer in either direction. These contacts close after a time delay upon transfer. Programmable 0-9999 seconds after transfer.

2.02 SURGE PROTECTION DEVICE (SPD)

A. Electrical Service SPD

1. Certify unit listed to UL 1449, 3rd Edition and UL 1283.
2. SPD shall be UL labeled as Type 1, intended for use without need for external or supplemental overcurrent devices. Every suppression component of every mode, including N-G, shall be protected by internal overcurrent and thermal over-temperature controls. SPDs relying upon external or supplementary installed safety disconnectors do not meet the intent of this specification.
3. SPD to be enclosed, surfaced mount and to include surge counter, audible alarm and dry contact for remote status.
4. Minimum surge current capability (single pulse rated) per phase shall be 200kA
5. Voltage Protection Ratings (VPRs) shall not exceed the following:

System Voltage	L-N	L-G	L-L	N-G
208Y/120	700V	700V	1000V	600V
480Y/277	1200V	1200V	2000V	1200V

6. Maximum Continuous Operating Voltage (MCOV) (verifiable at UL.com):

System Voltage	Allowable System Voltage Fluctuation (%)	MCOV
208Y/120	25%	150V
480Y/277	15%	320V

7. SPD shall be installed per manufacturer's installation instructions with lead lengths as short (less than 24") and straight as possible. Gently twist conductors together.

B. Telephone Service TVSS

1. Telephone system protection, high speed, fused, solid state design shall be provided on the incoming telephone service line.
2. UL 497A listed, low capacitance type, with female jacks, input and output.

2.03 DISCONNECT SWITCHES (VISIBLE BLADE TYPE)

- A. Visible blade type disconnect switches shall be heavy-duty, quick-make, quick-break, visible blades, 600 Volt, 3 pole with full cover interlock.

- B. Enclosure shall meet the area NEMA designation for which they are located.
- C. NEMA Type 12, 4X and 7 enclosures shall be as specified herein.
- D. Provide service entrance rated disconnect switches for all feeders originating from an outdoor generator source.
- E. Disconnect switches shall be as manufactured by Eaton Co., Square D, or General Electric Co.

2.04 DISCONNECT SWITCHES (TOGGLE TYPE)

- A. Toggle type disconnect switches shall be quick-make, quick-break with handle guard and lock-off feature.
- B. Switches shall be provided for resistance, non-motor type loads only. Switches shall not be installed where full load current of utilization equipment exceeds 18 Amperes.
- C. Switches shall be rated 20 Amperes at 600 Volts and 30 Amperes at 250 Volts, 60 Hertz, 2 or 3 pole.
- D. Enclosure shall meet the area NEMA designation for which they are located.
- E. NEMA Type 12, 4X and 7 enclosures shall be as specified herein.
- F. Disconnect switches shall be provided by Eaton Co., Square D., or General Electric Company.

2.05 MANUAL MOTOR STARTERS

- A. Manual starters shall be non-reversing, reversing or two speed type as shown on the drawings. Built-in control stations shall be provided where shown on the drawings.
- B. Enclosure shall meet the area NEMA designation for which they are located.
- C. NEMA Type 12, 4X and 7 enclosures shall be as specified herein.
- D. Provide handle guard kit with padlock provisions.
- E. Manual motor starters shall be as manufactured by the Eaton Co., Square D, or General Electric Co.

2.06 COMBINATION MAGNETIC MOTOR STARTERS FOR WALL MOUNTING

- A. Combination magnetic motor starters shall be a combination motor circuit protector and contactor. Contactors shall be three pole, three phase, 60 Hertz, 600 Volt, magnetically operated, full voltage non-reversing except as shown on the drawings. NEMA sizes shall

be as required for the horsepowers shown on the drawings. Disconnect switches shall be quick-make, quick-break with operating mechanism mounted on a fixed portion of the enclosure. Door mounted mechanisms will not be acceptable.

- B. Each motor starter shall have a 120 Volt operating coil and control power transformer. Three phase starters shall have three overload relays. Auxiliary contacts shall be provided as required.
- C. Overload relays shall be adjustable and manually reset.
- D. Control power transformers shall be sized for additional load where shown on the drawings. Transformer secondaries shall be equipped with time-delay fuses.
- E. Built-in control stations and indicating lights shall be furnished where shown on the drawings.
- F. Enclosure shall meet the area NEMA designation for which they are located.
- G. NEMA Type 12, 4X and 7 enclosures shall be as specified herein.
- H. Provide handle guard kit with padlock provisions.
- I. Combination magnetic motor starters shall be as manufactured by Eaton Co., Siemens Corp., or General Electric Co..

2.07 DRY TYPE TRANSFORMERS

- A. Dry type transformers shall be dry type, copper, two-winding with KVA and voltage ratings as shown on the drawings.
- B. Transformers shall be furnished with full capacity primary voltage taps as follows:
 - 1. 0.25 KVA to 2 KVA - None
 - 2. 3 KVA to 10 KVA - Two - 5 percent below normal.
 - 3. 11 KVA to 500 KVA - Two - 2-1/2 percent below normal and two 2-1/2 percent above normal.
- C. Transformers shall be designed for indoor or outdoor service as required for the locations shown on the drawings.
- D. Transformers shall be designed in accordance with ANSI, IEEE and NEMA standards.
- E. Normal efficiency transformers shall be furnished in sized to 15 KVA. Maximum temperature rise of transformers as measured by resistance above a 40 degree C ambient shall not exceed:
 - 1. 115 degree C for transformers rated up to 25 KVA.

- 2. 80 degree C for transformers rated up to 500 KVA.
- F. Energy efficient transformers shall be furnished in ratings 30 KVA and larger and certified to meet DOE 10 CFR Part 431:2016. Temperature rise of transformers above a 40 degree C ambient shall not exceed 80 degree C.
- G. All insulating materials shall be in accordance with NEMA standards for a 220 degree C UL component recognized insulation system.
- H. Transformers shall be manufactured by Square D Co., General Electric Co., Hammond Corp., or equal.

2.08 CONTROL STATIONS

- A. Control stations shall be heavy-duty type, 30 mm, with full size operators.
- B. All control stations located at motors and where shown on the drawings shall have a padlock attachment for locking out the stop button or position.
- C. Enclosure shall meet the area NEMA designation for which they are located.
- D. NEMA Type 12, 4X and 7 enclosures shall be as specified herein.
- E. Control stations shall be CR104 Series by General Electric Co., or equal by Eaton Co. or Siemens Corp.

2.09 ENCLOSED CIRCUIT BREAKERS

- A. Circuit breakers shall be molded case, three pole unless otherwise noted, with voltage rating as required. Ampere rating shall be as shown on the drawings. Provide with service entrance rating where required.
- B. Main breaker shall be solid state with digital trip and adjustable trip setting with LED on face of breaker providing amps per phase. Provide auxiliary contacts for trip status to remote alarm.
- C. The interrupting capacity shall be not less than 65,000 Amperes, RMS symmetrical at 480V AC.
- D. All circuit breakers with 225 Ampere frames and larger shall have interchangeable trips.
- E. Enclosure shall meet the area NEMA designation for which they are located.
- F. NEMA Type 12, 4X and 7 enclosures shall be as specified herein.

2.10 ENCLOSURE TYPE

- A. NEMA Type 12 enclosure shall be general purpose sheet steel.

- B. NEMA Type 4X enclosures shall be cast iron or stainless steel.
- C. NEMA Type 7 shall be cast iron.
- D. All metal enclosures shall be finish painted over a rust inhibiting primer.

2.11 WIREWAY

- A. Wireway shall be steel.
- B. Wireway shall be manufactured by General Electric Co., or equal by Siemens Corp or Hoffman Enclosures.

2.12 RELAYS

- A. Control relays shall be heavy duty machine tool type, with 10 Ampere, 300 Volt convertible contacts. Time delay relays shall be pneumatic, adjustable 0.2 to 180 seconds. Relays shall be Catalog No. 1CR122A as manufactured by the General Electric Co., equal by Eaton Company, or Allen Bradley Co.

2.13 NAMEPLATES

- A. Nameplates shall be provided for all special purpose tumbler switches, disconnect switches, remote control stations, motor starters, time clocks, panelboards, terminal cabinet, etc. to designate the equipment controlled and function.
- B. Nameplates shall be black and white laminated, phenolic material having engraved letters approximately 1/4 inch high, extending through the black face into the white layer.
- C. Nameplates shall be attached to the panel by self-tapping stainless steel screws or rivets.

2.14 METER SOCKET

- A. Provide a utility meter socket in a NEMA 3R enclosure with HASP cover provision of the type approved by the utility company.
- B. Meter Socket shall be 13 Jaw with 10 pole FT switch terminal block form 9s transformer rated.

2.15 FIBER OPTIC PATCH PANELS

- A. Wall mounted enclosed pre-loaded patch panels with a minimum 12 ports, SC connectors, cable spools, and hinged lockable door.

2.16 FLOOR MATS

- A. Provide 1/4" x 36" corrugated all rubber insulating matting in front of new 480V power distribution equipment.
- B. Matting shall be proof tested to 20,000 volts and conform to ASTM D178-93.
- C. Matting to be manufactured by Biltrite or equal.

2.17 WARNING SIGNS

- A. Switchboards, power distribution panelboards, transformers, pull boxes, electric rooms, closets and similar locations and pieces of equipment shall be furnished with a warning sign. Sign shall read "DANGER HIGH VOLTAGE KEEP OUT!". Signs shall be as manufactured by Thomas & Betts, Seton, or equal.

PART 3 – EXECUTION

3.01 INSTALLATION

- A. All field mounted devices shall be mounted four feet-six inches above the finished floor or grade. Devices shall be adequately supported on walls, columns or other supports. The Contractor shall furnish and install channel iron imbedded in the ground or floor to support devices where necessary.
- B. All control equipment shall be identified as to the equipment it controls. Provide lamacoid nameplates at all equipment.

3.02 TESTS AND CHECKS

- A. The following minimum tests and checks shall be made before energizing the automatic transfer switch.
 - 1. Perform insulation resistance tests phase-to-phase and phase-to-ground with switch in both source positions. The Insulation resistance test voltages and minimum values to be in accordance with manufacturer's published data.
 - 2. Measure contact resistance in normal and alternate source position.
 - 3. Determine contact resistance in micro-ohms. Investigate any value exceeding 500 micro-ohms or any values which deviate from adjacent poles by more than fifty percent (50%).

- END OF SECTION -

(THIS PAGE INTENTIONALLY LEFT BLANK)

SECTION 16120

WIRES AND CABLES

PART 1 – GENERAL

1.01 DESCRIPTION

- A. The work of this section includes the furnishing, installing and testing of all wire, cable and appurtenances as specified herein and as shown on the drawings. All wiring of a given type shall be the product of one manufacturer.

1.02 SUBMITTALS

- A. Submit the following in accordance with Section 01300:
 - 1. Wire
 - 2. Cable
 - 3. Terminations
 - 4. Lugs
 - 5. Wire and Cable Markers

1.03 DELIVERY, STORAGE AND HANDLING

- A. Provide in accordance with Section 01600.
- B. All materials shall be shipped, stored, handled and installed in such a manner as not to degrade quality, serviceability, or appearance.

1.04 DESIGN CRITERIA

- A. Wire for single phase circuits shall be Type XHHW or THWN-THHN.
- B. Wire for three phase circuits shall be Type XHHW.
- C. Single conductor wire for control, indication and metering shall be Type THWN/THHN No. 12 or 14 AWG, stranded.
- D. Multi-conductor control cable shall be used for the underground system and shall be No. 12 or 14 AWG, stranded with an overall jacket.
- E. Wire for process instrumentation shall be twisted shielded pairs No. 16 AWG, stranded.
- F. Ground wires shall be Type THW, green. Bare ground wires shall be soft drawn copper, 98 percent conductivity.

1.05 MINIMUM SIZES

- A. Except for control and signal wiring, no wire smaller than number 12 AWG shall be used.

PART 2 – PRODUCTS

2.01 MATERIALS

- A. Wires and cables shall be of annealed, 98 percent conductivity, soft drawn copper.
- B. All conductors No. 8 AWG and larger sizes shall be stranded.

2.02 600 VOLT WIRE

- A. Type XHHW shall be cross-linked polyethylene, as manufactured by Prysmian Cable Corp., Collyer Insulated Wire Co., The Okonite Co. or equal.
- B. Type THWN/THHN shall be as manufactured by Prysmian Cable Corp., Collyer Insulated Wire Co., The Okonite Co. or equal.
- C. Multi-conductor control cable shall be stranded, 600 Volt, cross-linked polyethylene insulated, neoprene jacketed, as manufactured by Allied Wire and Cable, or equal.

2.03 INSULATED 15KV RATED WIRE.

- A. 15KV wire shall be single aluminum conductor, MV-105 type, ethylene-propylene rubber 133% insulated, polyvinyl chloride jacketed, 133% insulated, shielded by Okonite Company, Pirelli Cables & Systems, Southwire Company or equal.
- B. Shielding: Copper tape, helically applied over semiconducting insulation shield.
- C. Preformed stress cones shall be used for terminating 15 KV cable.
- D. Exterior of the cables shall bear repetitive markings along their entire length indicating conductor size, insulation type and voltage rating.

2.04 INSTRUMENTATION CABLE

- A. Process instrumentation wire shall be twisted pair, 600 Volts, polyethylene insulated, aluminum tape, tinned copper braid shielded, polyvinyl chloride jacketed, as manufactured by Okonite Co., Belden Corp., or equal.

2.05 CAT 6 CABLE

- A. Cable shall be CAT 6 type having four each individually twisted pair, 22 AWG conductors with a blue PVC jacket.

2.06 FIBER OPTIC CABLE

- A. 50uM Multi Mode OM3 Type, ANSI/ICEA S-104-696 listed, Loose Tube, Gel-Free Plenum Cable, 12-Strand (OM3) and 6-Strand (OM3).
- B. Provide all end connectors and test complete cable end to end, all terminations and testing shall be by a certified fiber optic technician.

2.07 CONNECTORS AND TERMINAL LUGS

- A. Splices for No. 10 or No. 12 A.W.G. solid wires, such as for lighting branch circuits, shall be made with insulated wire connectors.
- B. Connectors and terminal lugs on wires No. 8 A.W.G. and larger shall be of the mechanical or clamp type.

2.08 15KV TERMINATIONS

- A. Provide all 15KV terminations consisting of Load Break Elbows, Insulated Parking Stands, and Insulated Caps. Install all primary and secondary terminations at the transformer, TMLP shall install the contractor supplied terminators at the utility pole.
- B. Load Break Elbows shall be 1/0 Elbow with test point type 166LR-B-5240 by Elastimold or approved TMLP equal.
- C. Insulated Cap with ground shall be type 160DRG by Elastimold or approved TMLP equal.
- D. Insulated Parking Strand shall be type 161SOP by Elastimold or approved TMLP equal.

2.09 WIRE AND CABLE MARKERS

- A. Wire and cable markers shall be "Omni-Grip" as manufactured by W.H. Brady Co., or equal.
- B. Wire and cables with diameters exceeding the capacity of the "Omni-Grip" shall be marked with pre-printed, self-adhesive vinyl tapes as manufactured by W.H. Brady Co., T&B Fasteners Inc., or equal.
- C. The "to" and "from" destinations shall be clearly identified on each cable at each termination and within manholes, pull boxes and junction boxes.

PART 3 – EXECUTION

3.01 INSTALLATION

- A. All conductors shall be carefully handled to avoid kinks or damage to insulation.
- B. All wires, cables and each conductor of multi-conductor cables (except lighting and receptacle wiring) shall be uniquely identified at each end with wire and cable markers.

1. Where wiring originates from a motor control center or process control panel the wire identification number shall incorporate the terminal numbers used in the control center or panel and a number to identify the motor control center or panel.
 2. Wires shall be identified at both ends and at intermediate junction boxes, terminal cabinets, etc. Wire identification numbers shall be unique.
 3. A typed list of the numbers used at each motor control center and control cabinet shall be submitted with the as built drawings.
- C. Lubrications shall be used to facilitate wire pulling. Lubricants shall be U.L. approved for use with the insulation specified.
- D. Shielded instrumentation wire shall be installed from terminal to terminal with no splicing at any intermediate point.
- E. Shielded instrumentation wire shall be installed in rigid steel conduit and pull boxes that contain only shielded instrumentation wire.
- F. Shielding on instrumentation wire shall be grounded at the transmitter end only.
- G. Each branch circuit shall have a dedicated neutral.
- H. Cables penetrating fire rated floors, walls, etc. shall be fireproofed. Fireproofing material shall be U.L. classified for three hour fire rating. Fire-proofing system shall be as manufactured by 3M Co., Thomas & Betts, or equal.
- I. Power conductors (other than lighting & receptacle) shall be run continuous and splicing should be kept to a minimum. The Engineer should be informed of where splices will occur.

3.02 TESTS

- A. All 600 Volt wire insulation shall be tested with a megohm meter after installation. Tests shall be made at not less than 500 Volts. Submit a written test report of the results to the Engineer.

- END OF SECTION -

SECTION 16130

RACEWAYS AND FITTINGS

PART 1 – GENERAL

1.01 DESCRIPTION

- A. The work of this section includes the furnishing and installing of complete raceway systems as specified herein and as shown on the drawings.
- B. All raceway systems shall be complete with fittings, boxes or cabinets, and necessary connections to result in a complete system.
- C. Aluminum materials shall not be used.

1.02 SUBMITTALS

- A. Submit the following in accordance with Section 01300:
 - 1. Raceways.
 - 2. Boxes and Fittings.

1.03 DELIVERY, STORAGE AND HANDLING

- A. Provide in accordance with Section 01600.
- B. All materials shall be shipped, stored, handled and installed in such a manner as not to degrade quality, serviceability, or appearance.

1.04 DESIGN CRITERIA

- A. Except where otherwise shown on the drawings, or hereinafter specified, all raceways installed exposed shall be rigid heavy wall galvanized steel conduit.
- B. PVC coated galvanized rigid steel conduit shall be used within all wet wells.
- C. PVC Schedule 40 conduit shall be used underground except as specified herein and where otherwise indicated on the drawings.
- D. When routing signal cables in raceways, maintain 12” spacing from power raceways and only cross at a 90 degree angle. All VFD power feeds to motors shall be routed in rigid steel material, NO EXCEPTION.

- E. Unless otherwise hereinafter specified or shown on the drawings, all boxes shall be metal.
- F. Exposed switch, outlet and control station boxes and fittings shall be cast or malleable iron.
- G. Concealed switch, outlet and control station boxes in dry-wall finished areas shall be pressed steel.
- H. Terminal boxes, cabinets, junction boxes, pull boxes and wireways used in areas designated as NEMA 4X shall be stainless steel 316, gasketed.
- I. Combination expansion-deflection fittings shall be used where conduits cross structure expansion joints. Refer to Structural drawings for expansion joint locations.
- J. Conduit wall seals shall be used where underground conduits penetrate walls or at other locations shown on the drawings.
- K. Fire stops shall be used where cables or conduits penetrate through fire resistant rated walls, floors, ceilings or partitions, including the wall, floor and ceiling openings of the electrical room.
- L. PVC coated rigid steel conduit sweeps shall be used where concealed PVC conduits rise up out of floor slabs.

PART 2 – PRODUCTS

2.01 MATERIALS

- A. Rigid Conduit
 - 1. Rigid heavy wall steel conduit shall be hot-dipped galvanized as manufactured by the Youngstown Sheet and Tube Co., Allied Tube and Conduit Corp., Wheeling-Pittsburgh Steel Corp., or equal.
 - 2. PVC conduit, up to 4 inch in diameter, where installed concealed in floor slabs, walls or underground shall be rigid polyvinyl chloride Schedule 40 as manufactured by Carlon, Phillips Petroleum Co., Triangle Pipe & Tube Co., Inc., or equal.
 - 3. PVC conduit, 5 inch in diameter and larger, used underground and at other locations shown on the Drawings shall be rigid polyvinyl chloride schedule 40 as manufactured by Carlon, Phillips Petroleum Co., Triangle Pipe & Tube Co., Inc., or equal.

4. PVC coated rigid steel conduit shall have a 0.040 inch thick, polyvinyl chloride coating permanently bonded to hot-dipped galvanized steel conduit, as manufactured by Calbond, Ocal, Robroy Industries, or equal.
- B. Liquidtight, Flexible Metal Conduit, Couplings and Fittings.
1. Liquidtight, flexible metal conduit shall be Sealtite, Type UA, as manufactured by Anaconda American Brass Co., or equal by American Flexible Conduit Co., Inc., or equal.
 2. Fittings used with flexible conduit shall be of the screw-in type as manufactured by Thomas and Betts Co., Crouse-Hinds Co., O.Z. Manufacturing Co., or equal.
- C. Flexible couplings shall be as manufactured by Crouse-Hinds Co., Appleton Electric Co., O.Z. Manufacturing Co., or equal.
- D. Boxes and Fittings
1. Pressed steel switch and outlet boxes shall be hot-dipped galvanized as manufactured by Raco Manufacturing Co., Adalet Co., O.Z. Manufacturing Co., or equal.
 2. All boxes including, but not limited to, terminal boxes, junction boxes and pull boxes shall be sheet steel unless otherwise shown on the drawings. Boxes shall be galvanized and have continuously welded seams. Welds shall be ground smooth and galvanized. Box bodies shall be flanged and shall not have holes or knockouts. Box bodies shall not be less than 14 gauge metal and covers shall not be less than 12 gauge metal. Covers shall be gasketed and fastened with stainless steel screws. Boxes shall be as manufactured by Hoffman Engineering Co. or equal.
 3. All boxes and fittings used with PVC coated conduit shall be furnished with a PVC coating bonded to the metal. The tensile strength of the bond shall be not less than 2,000 pounds.
 4. All boxes and fittings used with PVC coated conduit shall be furnished with a PVC coating bonded to the metal, the same thickness as used on the coated steel conduit.
 5. Cast or malleable iron boxes and fittings shall be galvanized with cast galvanized covers and corrosion-proof screws as manufactured by the Crouse-Hinds Co., Appleton Electric Co., O.Z. Manufacturing Co., or equal.
 6. PVC boxes and fittings shall be as manufactured by Carlon, An Indian Head Co., O.Z. Manufacturing Co., or equal.
 7. Steel elbows and couplings shall be hot-dipped galvanized. Elbows and couplings used with PVC coated conduit shall be furnished with a PVC coating bonded to the steel, the same thickness as used on the coated steel conduit.

8. Conduit hubs shall be as manufactured by Myers Electric Products, Inc., Raco Div., O.Z. Manufacturing Co., or equal.
9. Conduit wall seals shall be Type WSK as manufactured by O.Z. Manufacturing, Co., or equal by Link Seal Co.
10. Combination expansion-deflection fittings shall be Type XD as manufactured by Crouse-Hinds Co., or equal by Appleton Electric Co., O.Z. Manufacturing Co.
11. Conduit seal bushings shall be Type CSB as manufactured by O.Z. Manufacturing Co., or equal by Crouse-Hinds Co.
12. Fire stops shall be Type CFSF as manufactured by O.Z. Manufacturing Co., or equal by Crouse-Hinds Co., Appleton Electric Co.
13. Explosion proof conduit seals shall be Type EYS as manufactured by O.Z. Manufacturing Co., or equal by Crouse-Hinds Co. and Appleton Electric Co.

E. Cable Tray System

1. Cable tray shall be aluminum ladder type with 6 inch rung spacing and no cover.
2. Unless otherwise noted, all cable tray system components including, but not limited to, straight sections, fittings, hangers, splice plates and reducers shall be aluminum.
3. The cable tray shall be capable of supporting the total cable load with a maximum deflection of not more than 1/200 of the span with a safety factor of 1.5 based on the destructive load, regardless of the location of splice plates or type of span.
4. Cable trays shall be four inches in depth.
5. Standard rigid fittings shall be aluminum and used at all changes in direction or size of the cable tray system.
6. Cable trays and accessories shall be supplied by a single manufacturer and shall be as manufactured by Globe Metal Products Division of United States Gypsum Company, B-Line Systems, Inc., Chalfant Cable Tray Systems, or equal.
7. All fastening hardware (nuts, bolts, hangers, rods, washers, etc.) shall be stainless steel.
8. Ninety degree sweeps shall have the following minimum radius:
 - a. For trays 9 inch to 18 inch in width - 12 inch radius.

- b. For trays 24 inch in width - 18 inch radius.
 - c. For trays 30 inch and greater - 24 inch radius.
9. Provide ladder drop out fittings at all pump cable entry locations.
- F. Conduit Mounting Equipment. Hangers, rods, backplates, beam clamps, fasteners, etc. shall be hot-dipped galvanized iron or steel for all areas except for the wet well. Mounting equipment shall be as manufactured by B-Line Co., Thomas and Betts Co., Unistrut Corp., or equal.
- G. Conduit Mounting Equipment. Hangers, rods, backplates, beam clamps, fasteners, etc. shall be stainless steel for within the wet well. Mounting equipment shall be as manufactured by B-Line Co., Thomas and Betts Co., Unistrut Corp., or equal.
- H. Corrosion Protection for Galvanized Conduit located exterior to buildings shall be provided. Corrosion protection for galvanized conduit shall be cold galvanized zinc based paint as manufactured by L.P.S. Co., Los Angeles, California, CRS Chemicals, Drecher, Pennsylvania, or equal.

PART 3 – EXECUTION

3.01 INSTALLATION

- A. No conduit smaller than 3/4 inch electrical trade size shall be used, nor shall any have more than three 90 degree bends in any one run. Approved factory elbows shall be used when sharper bends are necessary. Pull boxes shall be provided as required or directed.
- B. No wire shall be pulled until the conduit system is complete in all details; in the case of concealed work, until all rough plastering or masonry has been completed; in the case of exposed work, until the conduit system has been completed in every detail.
- C. The ends of all conduits shall be tightly plugged to exclude dust and moisture while the buildings are under construction.
- D. Conduit supports shall be spaced at intervals of eight feet or less, as required to obtain rigid construction.
- E. Single conduits shall be supported by means of one-hole pipe clamps in combination with one-screw back plates, to raise conduits from the surface. Plastic "CLIC" system supports are not acceptable. Multiple runs of conduits shall be supported on trapeze type hangers with steel horizontal members and threaded hanger rods. The rods shall be not less than 3/8 inch diameter. Wire hangers will not be accepted.
- F. Conduit hangers shall be attached to structural steel by means of beam or channel clamps. Where attached to concrete surfaces, concrete inserts of the spot type shall be provided.
- G. All conduits on exposed work and concealed above hung ceilings shall be run at right angles to or parallel with surrounding wall and shall conform to the form of the ceiling.

Diagonal runs will not be allowed. Bends in parallel conduit runs shall be concentric. All conduit shall be run perfectly straight and true.

- H. Conduit terminating in pressed steel boxes shall have double locknuts and insulated bushings.
- I. PVC conduits shall be installed using a fusing cement process. Conduits shall be water tight.
- J. Conduit terminating in gasketed enclosures shall be terminated with conduit hubs.
- K. Metallic heavy wall conduits shall be installed using threaded fittings. Threadless fittings may be used in isolated instances when approved by the Engineer.
- L. Liquidtight flexible metal conduit shall be used for all motor terminations and other equipment where vibration is present.
- M. PVC coated rigid steel conduits shall extend a minimum of 12 inches above finished slabs. Conduits penetrating walls shall be caulked gas tight on both sides.
- N. When a conduit has to be cut in the field, it shall be cut square using a hand or power hacksaw cutter, or an approved pipe cutter using knives. The use of pipe cutter wheels will not be permitted. The cut ends of the field cut conduit shall be reamed to remove burrs and sharp edges. Where threads have to be cut on conduit, the threads shall have the same effective length and shall have the same thread dimensions and taper as specified for factory cut threads on conduits. Field cut threads shall be protected by a field applied cold galvanizing compound.
- O. Conduits entering buildings below grade shall be furnished with a conduit seal bushing.
- P. Concealed conduits in floor slabs and walls and encased in concrete envelope shall be run in direct line with bends of largest possible radius.
- Q. Ducts installed in concrete slabs shall be installed as specified in Section 03300 (Cast-In-Place Concrete). Ducts shall be arranged to minimize crossings.
- R. Ducts shall not be installed in slabs where the slab is below the highest known groundwater level.
- S. Where ducts terminate at panelboards, terminal cabinets, etc. panel of sufficient width and depth shall be provided to maintain the 2 inch spacing between ducts or wireways shall be provided below panels, cabinets, etc.
- T. A ground wire shall be run in all runs of electric metallic tubing and PVC conduit.
- U. All bends in PVC conduit shall be made using a hotbox and bending guide tool.

- V. Conduits run underground below the highest known ground water level shall not enter buildings below this groundwater level without first being run through a drain manhole, handhole, or exterior pull box.

- END OF SECTION -

THIS PAGE LEFT INTENTIONALLY BLANK

SECTION 16442

PANELBOARDS

PART 1 – GENERAL

1.01 DESCRIPTION

- A. The work of this section includes the furnishing and installing of all panelboards as specified herein and as shown on the drawings. All panelboards shall be provided with the applicable NEMA enclosure in accordance with the Electrical Contract Drawings.

1.02 SUBMITTALS

- A. Submit the following in accordance with Section 01300:
 - 1. Panelboards, including construction details and enclosures
 - 2. Terminals and lugs
 - 3. Trim
 - 4. Buses
 - 5. Circuit Breakers
 - 6. Groundfault Circuit Interrupter
 - 7. Metering

1.03 DELIVERY, STORAGE AND HANDLING

- A. Provide in accordance with Section 01600.
- B. All materials shall be shipped, stored, handled and installed in such a manner as not to degrade quality, serviceability, or appearance.

1.04 DESIGN CRITERIA

- A. Panelboard ratings shall be as shown on the drawings. All panelboards shall be rated for the intended voltage.
- B. Panelboards shall be in accordance with the Underwriter Laboratories, Inc. “Standard for Panelboards” and “Standard for Cabinets and Boxes” and shall be so labeled where procedures exist. Panelboards shall also comply with NEMA Standard for Panelboards and the National Electrical Code.

PART 2 – PRODUCTS

2.01 PANELBOARD CONSTRUCTION

- A. Interiors
 - 1. All interiors shall be completely factory assembled with circuit breakers, wire connectors, and buses. All wire connectors, except screw terminals, shall be of

the anti-turn solderless type and all shall be suitable for copper wire of the sizes indicated.

2. Interiors shall be designed such that circuit breakers can be replaced without disturbing adjacent units and without removing the main bus connectors and shall be such that circuits may be changed without machining, drilling or tapping.
3. Branch circuits shall be arranged using double row construction except when narrow column panels are indicated. Branch circuits shall be numbered by the manufacturer.
4. A factory provided label shall be provided listing panel type, number of circuit breakers and ratings.
5. The main breaker shall be at the top or bottom of the bus construction and not a branch breaker.

B. Buses

1. Main bus shall be copper. Full size neutral bars shall be included. Phase bussing shall be full height without reduction. Cross connectors shall be copper. All buses shall be tinned.
2. Main bus shall be distribution phase sequence type configuration to allow installation of two or three pole circuit breakers at any location.
3. Neutral bussing shall have a suitable lug for each outgoing feeder requiring a neutral connection.
4. Spaces for future circuit breakers shall be bussed for the maximum device that can be fitted into them.
5. Solderless main lugs or main circuit breakers shall be furnished as shown on the drawings.
6. Bus bracing to be at least equal to the interrupting rating of lowest rated circuit breaker installed in panel. Series rated breakers and panels shall not be acceptable.

C. Boxes

1. Recessed boxes shall be made from galvanized code gauge steel having multiple knockouts unless otherwise noted. Surface mounted boxes shall be painted to match the trim. Boxes shall be of sufficient size to provide a minimum gutter space of four inches on all sides.
2. Surface mounted boxes shall have an internal and external finish as specified herein. Surface mounted boxes shall be field punched for conduit entrances.
3. At least four interior mounting studs shall be provided.
4. Panelboards shall be "door-in-door" construction.

D. Trim

1. Hinged door-in-door construction shall enclose all circuit breaker handles and shall be included in all panel trims.
2. Doors shall have semi flush type cylinder lock and catch, except that doors over 48 inch in height shall have a vault handle and three point catch, complete with lock, arranged to fasten door at top, bottom and center. Door hinges shall be concealed. Two keys shall be supplied for each lock. All locks shall be keyed alike. A directory frame and card having a transparent cover shall be furnished on each door.
3. Trims shall be fabricated from code gauge sheet steel.
4. All exterior and interior steel surfaces of NEMA 1, 1A, 3R and 12 panelboards shall be properly cleaned and finished with ANSI Z55.1, No. 61 light gray paint over a rust-inhibiting phosphatized coating. The finish paint shall be of a type to which field applied paint will adhere.
5. Trims for flush panels shall overlap the box by at least 3/4 inch all around. Surface trims shall have the same width and height as the box. Trims shall be fastened with quarter turn clamps.

E. Manufacturer

1. 208 Volt, three phase, 4 wire panelboards shall be type NF Series as manufactured by the Square D, equal by Eaton, or General Electric.
2. 480 Volt, three phase, 3 or 4 wire distribution panelboards shall be type I-Line Series as manufactured by the Square D, equal by Eaton, or General Electric.

2.02 CIRCUIT BREAKERS

- A. Panelboards shall be equipped with circuit breakers with frame size and trip settings as shown on the drawings. Circuit breaker mounting shall not exceed 78 inches above floor.
- B. Circuit breakers shall be molded case, bolt-in type.
- C. Circuit breakers installed in 120/240 Volt and 120/208 Volt panelboards shall have an interrupting capacity of not less than 10,000 Amperes, RMS symmetrical.
- D. Circuit breakers installed in 277/480 Volt panelboards shall have an interrupting capacity as shown on the Electrical Contract Drawings.
- E. Main circuit breaker shall be attached to the main vertical bus.
- F. Circuit breakers with frame rating of 250 Amps and greater shall have a solid state digital trip unit with adjustable long, short, instantaneous, and ground fault (where indicated) trip settings. Provide auxiliary contacts for trip status to remote alarm.

2.03 GROUND FAULT CIRCUIT INTERRUPTER (GFCI)

- A. GFCI shall be provided for circuits where indicated on the drawings. GFCI units shall be molded case, bolt-on breakers, incorporating a solid state ground fault interrupter circuit insulated and isolated from the breaker mechanism. The unit shall be U.L. listed Class A Group I device (5 milliamp sensitivity, 25 millisecond trip time), and an interrupting capacity matching the circuit breakers in the panelboards.

2.04 DIGITAL POWER METER

- A. Main Distribution panelboard shall be metered with a digital power meter.
- B. Digital Power Meter
 - 1. Digital power meter shall be true RMS type power monitor with features to data log (30 days) and communicate remotely the AC amperes on each phase, voltage, harmonic distortion, watts, volt amperes, bars, power factor, frequency, demand watts, demand volt ampere and watt hours; and capable of providing alarm status for phase loss, phase on balance, phase reversal and provides all data to remote monitoring systems.
 - 2. The power meter shall communicate using Modbus RTU via a RS-485 port and Ethernet protocol via a RJ-45 port and be able connect to any host devices.
- C. Provide small control wiring, necessary fuse blocks, suitable numbering strips and terminal blocks as required
- D. Provide current transformers for each meter. Current transformers shall be wired to shorting type terminal blocks. All transformers used for metering shall meet the requirements of IEEE C12.11 and IEEE C57.13.

PART 3 – EXECUTION

3.01 INSTALLATION

- A. Boxes for surface mounted panelboards shall be mounted so there is at least ½ inch air space between the box and the wall.
- B. Circuit directories shall be typed identifying location and nature of load served.
- C. Panelboards installed in areas with finished walls shall be installed recessed into the wall with the front of the panel flush with the finished wall.

- END OF SECTION -

SECTION 16495

VARIABLE FREQUENCY DRIVES

PART 1 – GENERAL

1.01 DESCRIPTION

- A. The work of this section includes furnishing all labor, materials, tools and equipment necessary to furnish and install Variable Frequency Drives (VFD) as shown on drawings, specified herein, or evidently required to complete the work.
- B. Refer to various DIVISION 11 – EQUIPMENT sections and contract drawing motor wiring diagrams for field device interface.

1.02 SUBMITTALS

- A. Shop Drawings and/or brochures shall be submitted to the Engineer in accordance with Section 01300.
- B. Submittals required under this section include, but are not limited to the following:
 - 1. Shop drawings showing complete fabrication and construction details, materials, electrical components, enclosures, input line reactors, harmonic filters, weights, dimensions, clearances, anchorage locations, piping and utility requirements, and step by step sequence of controls.
 - 2. Certified Performance and Efficiency Characteristics.
 - 3. The Contractor shall provide the VFD manufacturer with copies of all motor shop drawing submittals and or nameplate data. The VFD manufacturer shall review this data and shall certify in writing that the equipment has been coordinated with the variable frequency drives and motors for complete compatibility.
 - 4. Harmonic Analysis and written summary report.
 - 5. Complete master wiring diagrams, VFD layout drawings and control schematics, including required coordination with other electrical control devices operating in conjunction with each VFD and suitable outline drawings shall be furnished for each VFD being supplied for approval before proceeding with manufacture. Due to the complexity of the control functions, it is imperative the above drawings be clear and carefully prepared to facilitate interconnections with other equipment. Standard preprinted sheets or drawings simply marked to indicate applicability to this contract will not be acceptable.

1.03 DELIVERY, STORAGE AND HANDLING

- A. All materials and equipment shall be shipped, stored, and handled in accordance with Section 01600.
- B. The materials and components shall be stored on a flat, clean surface to prevent damage and shall be covered to prevent exposure to adverse conditions prior to installation.
- C. All materials shall be shipped, stored, handled and installed in such a manner as not to degrade quality, serviceability, or appearance.

1.04 DESIGN CRITERIA

- A. The materials and equipment covered by this specification are intended to be standard materials and equipment of demonstrated successful performance, as manufactured by reputable concerns. Equipment shall be designed and constructed in accordance with the highest standards of the industry and shall be installed in accordance with the manufacturer's recommendations and the Contract Documents. The specifications call attention to certain features but do not purport to cover all details entering into the construction of the equipment.
- B. Provide individual constant torque VFD's with LCL line filters, low harmonic drives, and soft starter by-pass. Each individual VFD requires all these devices to be factory mounted within its enclosure. Field mounting of drive related accessories is unacceptable.
- C. All equipment submitted shall be provided with enclosures that can be installed in the spaces shown on the drawings. Enclosures that exceed the allowable space provided shall be subject to rejection.
- D. Heat dissipation from VFD enclosures shall meet all requirements of the specifications.
- E. All VFDs shall be low harmonic drives for the wastewater and water industry meeting the requirements of IEEE-519 as manufactured by ABB, Eaton or General Electric.
- F. Each VFD unit shall be U.L. listed or labeled.

1.05 HARMONIC REQUIREMENTS

- A. Under normal operating conditions, the line harmonics introduced into the power system from the AC VFD unit(s) shall be within the distortion limits as defined in IEEE 519 and less than %5 Ithd. The point of common coupling shall be the main distribution panel.

PART 2 – PRODUCTS

2.01 DRIVES

- A. This specification is intended to outline the overall physical features, performance and functional requirements of the VFD equipment required under this section, consisting of a variable speed adjustable frequency converter, by-pass contactors, filters, accessories,

and enclosure. The VFD system shall be fully tested by the manufacturer before initial startup with all components compatible in function and appearance.

B. Variable Speed Adjustable Frequency Converter. The adjustable frequency drive shall be UL Listed solid state type in a NEMA 12 filtered enclosure and blower cooled. The filter element shall be of the removable and replaceable type for each drive unit. Front access shall be provided. Top, rear and side access shall not be required. The enclosure shall be coated with an epoxy resin base and acrylic resin enamel finish. The drive shall meet applicable provisions of DIVISION 16, ELECTRICAL, the National Electric Code and NEMA. The drive shall be arranged for 480 Volts plus 10 percent to minus 5 percent, three phase, 57 to 63 Hertz input converted into adjustable frequency/Voltage output in an ambient temperature of -10 to 40 degrees C. The VFD shall be capable of sustaining operation with a line voltage dip of 15 percent of normal operating voltage on a constant torque or variable torque load. During line dip the VFD shall automatically provide a speed drop allowing maximum capable speed for the duration of the input voltage dip. Each individual drive shall be mounted in a separate enclosure. The drive efficiency shall be 97 percent or better at full speed and full load. Fundamental power factor shall be 0.98 at all speeds and loads. Each individual drive and associated equipment shall be mounted in a single and individual enclosure unless otherwise specified. The following features shall be included with each adjustable frequency drive:

1. Control. The control method shall be sinusoidal Pulse Width Modulation. Output Voltage shall be three phase, 480 Volts and output frequency shall be 0.1 to 66 Hz when shipped. Frequency shall be selectable by a digital keypad. The frequency resolution shall be 0.1 Hz and the accuracy shall be within 1.0 percent of the maximum frequency at 25 degrees plus or minus 10 degrees C. Voltage/frequency (V/f) characteristics shall be characterized by selectable patterns. Up to 82 control functions shall be programmed. The overload capacity shall be 110 percent continuous and a minimum two minute rating of 150 percent of rated current. The frequency setting signal shall be 4 to 20 mA. The VFD shall employ a full wave rectifier to prevent input line notching, DC bus choke, DC bus capacitors, and Insulated Gate Bipolar Transistors (IGBT's) as the output switching device. SCRs, GTOs and Darlingtion transistors are not acceptable.
2. Function. The adjustable parameters consisting of: accelerating time, decelerating time, upper and lower limit of output frequency, and 4 to 20 mA reference bias and reference gain shall be indicated on a digital display. Braking shall be achieved through capacitor charging and starting shall be achieved by external contact. The VFD shall be software configurable to automatically restart following power outage, overcurrent and overvoltage detection. Soft stall shall occur when motor runs continuously at overload.
3. Protection. The drive shall be protected from stalling, overcurrent, overload, short circuit, overvoltage, undervoltage, loss of one (1) phase of input power, instantaneous power failure (approximately 30 msec), overheating, fuse burnout protection and earth (ground) fault detection. The fault cause shall be displayed (flickering) for overcurrent, short circuit, overload, overvoltage, overheating and earth (ground) fault. There shall be a main capacitor charging indicator for

internal circuit. Fault shall be reset by a reset push button on the printed circuit board and an external reset contact.

4. Displays. The digital display shall be a 2 line, 40 character unit with readout in plain English. Display shall be located on the door of the VFD enclosure.
5. Internally mounted set point control shall be provided to receive either a 4 to 20 mA or 0 to 10 vdc analog input control signal from a process panel to control the speed of the motor. An external digital display shall be provided outside of the inverter. The following control devices shall be available for external control of the inverter; frequency/speed meter, frequency setting variable resistor, knob for frequency setting variable resistor and drive switch. The drive shall be capable of receiving a dry contact input to override the analog input control signal and control the flow rate to 95%.
6. A bypass motor starter and VFD VFD/Bypass switch shall be provided to allow VFD bypass and straight in line full load motor operation. A solid state bypass soft start style motor starter shall be provided for all motors 30HP and greater. The line and load sides of the soft start motor starter shall be electrically isolated from incoming power and motor respectively with contactors in which will not close until the bypass switch is in the bypass position.
7. A lockable main load break disconnect switch interlocked with the enclosure door with through the door handle to provide positive disconnect of incoming AC power shall be furnished for each individual drive and enclosure. The circuit breaker shall be rated at a minimum 25,000 amperes at 480 volts, RMS symmetrical.
8. Each drive shall be provided with the following accessories:
 - a. "Local-Off-Remote" keypad switch for local/remote speed control. In the "Remote" mode, the motor speed shall be adjusted in response to the related remote 4 to 20 mA pacing signal. In "Local" mode the motor speed shall be adjusted in response to keypad entry speed and the VFD shall run when the "Hand-Off-Auto" selector switch is in "HAND". . In "Off" mode the VFD shall not run.
 - b. Provide a 4-20 mA speed feedback output signal.
 - c. Provide four (4) Type C dry contacts at each VFD for remote indication of motor running status.
 - d. "Hand-Off-Auto" selector switch located on the door of the VFD enclosure. In the "Auto" position the VFD shall be started and stopped remote via an external dry contact. In the "Hand" position the VFD shall run. In "Off" mode the VFD shall not run.
 - e. Elapsed time meters located on the door of the VFD enclosure.
 - f. Provide two (2) type C contacts at each VFD for remote indication of VFD run and fault conditions.

- g. Motor running indicating light located on the door of the VFD enclosure.
- h. Motor off indicating light located on the door of the VFD enclosure.
- i. Drive failure indicating light located on the door of the VFD enclosure.
- j. Provide a bypass contractor operation indicating light located on the door of the VFD enclosure.
- k. All indication lights shall be LED push to test type.
- l. All time delay relays shall be true on and true off type that utilize the control signal for relay power.
 - i. Provide all controls and accessories as shown on the equipment motor wiring diagrams in the contract drawings. Specialized interface relays supplied by the equipment manufacture shall be installed in the VFD cabinet by the VFD manufacture at the VFD manufacturing plant. Coordinate with the equipment manufacture for space requirements and delivery of the relays.
 - j. The VFD drive shall have a RJ45 Ethernet port to allow for complete data exchange of all VFD parameters over an Ethernet/IP network.

PART 3 – EXECUTION

3.01 VERIFICATION OF CONDITIONS

- A. Before the start of the work of this Section, verify that the project is ready for this work.
- B. Verify that field measurements are as shown on approved shop drawings and/or manufacturer's instructions.
- C. Verify that the equipment or material is in conformance with the approved shop drawings and specifications and resolve any deviations.
- D. Notify subcontractors involved or affected by this work and coordinate the work with them.

3.02 INSTALLATION

- A. All materials and equipment shall be installed in a neat, workmanlike manner.
- B. Minimum requirements of all wiring of the equipment shall be as specified under DIVISION 16 -ELECTRICAL of these specifications.
- C. Installation of the equipment shall be in accordance with written instructions provided by the manufacturer and as approved.

3.03 PAINTING

- A. Shop painting and the surface preparation is a part of the work specified herein. Enclosures shall be coated with an electrostatically-applied epoxy enamel.

3.04 CLEAN UP

- A. Prior to start-up and field testing, all foreign matter shall be removed from the equipment. Spillage of lubricants used in servicing the system shall be cleaned from all equipment and concrete surfaces.

3.05 MANUFACTURER'S FIELD SERVICES

- A. Manufacturer's Field Services shall be provided for field programming and startup for all the VFDs provided.

3.06 MANUFACTURER'S TRAINING

- A. Manufacturer's training shall be provided for training of Owner's personnel for each type of VFD provided in accordance with Section 01700.
- C. Manufacturer's Training of Owner's Personnel shall be a minimum of two (2) calendar days performed at the project site.

3.07 SPARE PARTS

- A. One set of spare parts shall be provided for each VFD size.
- B. Spare parts for each VFD Size:
 - 1. One (1) control interface.
 - 2. Three (3) fuses.
 - 3. One (1) VFD module each size provided without enclosure

3.08 WARRANTY

- A. A manufacturer's warranty for three years shall be provided for each VFD.

- END OF SECTION -

SECTION 16500

LIGHTING SYSTEMS

PART 1 – GENERAL

1.01 DESCRIPTION

- A. The work of this section includes the furnishing and installing of complete lighting systems including panelboards, transformers, lighting fixtures, receptacles, switches, contactors, clocks and all accessories and appurtenances required as specified herein and as shown on the drawings.

1.02 SUBMITTALS

- A. Submit the following in accordance with Section 01300:
 - 1. Light Switches
 - 2. Receptacles
 - 3. Astronomical Time Clock Switch
 - 4. Lighting Fixtures
 - 5. Device Plates
 - 6. Emergency Lighting Battery Units and Exit Lights

1.03 DELIVERY, STORAGE AND HANDLING

- A. Provide in accordance with Section 01600.
- B. All materials shall be shipped, stored, handled and installed in such a manner as not to degrade quality, serviceability, or appearance.

1.04 DESIGN CRITERIA

- A. All lighting fixtures shall be in accordance with the National Electrical Code and shall be constructed in accordance with the Underwriters Laboratories “Standards for Safety, Electric Lighting Fixtures.” All lighting fixtures shall be Underwriters Laboratories labeled.

PART 2 – PRODUCTS

2.01 WIRE:

- A. Wire shall be as specified under Section 16120, Wire and Cables.

2.02 CONDUIT

- A. Conduit shall be as specified under Section 16130, Raceways and Fittings.

2.03 PANELBOARDS

- A. Panelboards shall be as specified under Section 16442, Panelboards.

2.04 LIGHT SWITCHES

- A. NEMA WD 1, UL 20, Heavy-Duty, AC only general-use toggle switch.
- B. Rated 20 Amperes, 120/277 Volts for inductive and resistive loads.
- C. Motor rated up to 80 percent of ampere rating.
- D. Totally enclosed in a phenolic base and cover.
- E. U.L. and CSA Listed.

2.05 RECEPTACLES

- A. NEMA WD 1, UL 498, Heavy-duty general use receptacle.
- B. GFCI Receptacle: UL 943, Convenience receptacle with integral ground fault circuit interrupter and indication light that is lighted when device is not tripped.
- C. NEMA WD 6, straight blade type for rated current and phases as indicated on drawings.
- D. Weatherproof Cover Plate: NEMA 3R, thermoplastic white use type covers by Hubbell or equal.

2.06. ASTRONOMICAL TIME CLOCK SWITCH

- A. Astronomical Time Clock Switch shall be programmable astronomically controlled switch front LCD time display and programmable buttons mounted in a standard back box.
- B. The switch shall be 1-pole, 15 Amp rated and capable of 7-day week time scheduling, equal to Leviton VPT24-1PZ Vizia by Leviton or equal by Hubbell or Legrand.
- C. Operation: Exterior lights shall be energized when the astronomical dusk time of day dial is past time. The lights shall remain energized until either the "Off" time of day or astronomical dawn time of day is past time.

2.07 DEVICE PLATES

- A. Plates for shall be of the required number of gangs for the application involved and shall be Type 302 (18-8) high nickel stainless steel of the same manufacturer as the device.

2.08 LIGHTING FIXTURES

- A. Lighting fixture shall be LED illuminated and of type as shown on the drawings. The catalog numbers listed are given as a guide to the design and quality of fixture desired. Equivalent designs and equal quality fixtures of other manufacturers will be acceptable.
- B. The fixture shall be tested to IESNA LM-79-08 and LM-80 Testing Standards at 25° C ambient temperature
- C. The LED package shall be designed around the lumen maintenance of 87% at 60,000 hrs. and is to be expected to achieve L70 at 100,000 hrs.
- D. The Light Engine shall be a high efficacy LED light engine equipped with brand-name LEDs available in outputs of 100%, 85%, 70% and 55%.
- E. The LED Drivers shall be Electronic Class 2, high efficiency, with the following power factor correction (PFC):
 - 1. Standard Non-Dimming Driver (PFC>0.95).
 - 2. Dimming Drivers (PFC>0.90).

2.09 EMERGENCY LIGHTING BATTERY UNITS AND EXIT SIGNS

- A. Emergency lighting units shall be fully automatic with 12 Volt nickel cadmium batteries. The wattage of the unit shall be sufficient to power the remote lamps as shown on the Contract Drawings, plus 20% spare capacity, for 1-1/2 hour upon loss of AC power. Units shall be designed for 120 Volt, 60 Hertz input and have an automatic clock timer and solid state charger, ready/off switch, press-to-test switch, amber "ready" light, red "charge" light and required number of supervisory relays.
- B. Provide Holophane DeSoto M802 series emergency lighting units with dual lighting heads. Units manufactured by Hubbell, Dual Lite or approved equal are also acceptable. Lighten heads shall be 12 volts, 20 watts, halogen type.
- C. Provide Holophane QM-LED series exit signs with LED lamps, nickel cadmium battery, and battery charger. White background with red lettering. Equivalent units manufactured by Dual Lite, Sure Lite or approved equal are acceptable.
- D. In NEMA 1, 12, 4, and 4x areas, provide remote wall mounted lamp heads ELA-DM802 sealed thermoplastic, 12 volts, 12 watts, halogen type with weatherproof mounting base by Holophane. Equivalent units manufactured by Hubbell, Dual Lite or approved equal are acceptable.
- E. In NEMA 7 areas, provide emergency lighting remote lamp heads Series DSHR, 12 volts, 12 watts halogen, by Holophane. Equivalent units manufactured by Hubbell, Dual Lite or approved equal are acceptable.

PART 3 – EXECUTION

3.01 INSTALLATION

- A. Each fixture shall be a completely finished unit with all components, mounting and/or hanging devices necessary, for the proper installation of the particular fixture in its designated location and shall be completely wired ready for Connection to the branch circuit wires at the outlet. All pendant mounted fixtures shall be mounted plumb with floors and walls.
- B. When fixtures are noted to be installed flush, they shall be complete with the proper accessories for installing in the particular ceiling involved. All flush mounted fixtures shall be supported from the structure and shall not be dependent on the hung ceilings for their support.
- C. Flexible fixture hangers shall be used for all pendant mounted fixtures. Pendant mounted fixtures shall be supported from 3/4 inch galvanized rigid steel conduit.
- D. Receptacles and switches shall be mounted at 45" above finished floor.
- E. Mounting heights given are to the bottom of the fixture. When "mount up" is indicated, fixture is to be mounted the stated distance off the finished floor.

3.02 CLEANING UP

- A. All fixtures shall be left in a clean condition, free of dirt and defects, before acceptance by the Engineer.

- END OF SECTION -

SECTION 16612

ENGINE GENERATOR

PART 1 – GENERAL

1.01 DESCRIPTION

- A. The work of this section includes all labor, materials, tools, equipment and incidentals necessary to furnish and install, put in operation and field test a diesel engine driven generator unit with sound attenuated weatherproof enclosure and doubled wall base tank of the size and rating as specified herein and on the Drawings.

1.02 SUBMITTALS

- A. Shop Drawings and/or brochures shall be submitted to the Engineer in accordance with Section 01300.
- B. Submit all pertinent technical data including but not limited, to the following:
 - 1. Manufacturer and model of engine and generator
 - 2. Rated capacity B.H.P.
 - 3. Generator
 - 4. Generator KVA, KW and P.F. rating
 - 5. Voltage
 - 6. Class insulation
 - 7. Temperature rise above 40 degree C ambient
 - 8. Generator efficiency and fuel consumption at full load, 3/4 load and 1/2 load
 - 9. Operating weight of complete unit
 - 10. Exhaust piping
 - 11. Double walled base tank
 - 12. Battery and charger
 - 13. Auxiliary system power requirements and wiring diagrams
 - 14. Enclosure with all conduit openings for system operation identified.

- C. Manufacturer's certified test record. The test record shall show the generator performance and frequency regulation to satisfy the requirements specified herein, and shall also show fuel consumption rates at 1/2 load, 3/4 load and full rated load.
- D. Submit all other data specified in this section and as outlined in Section 01300.

1.03 DELIVERY, STORAGE AND HANDLING

- A. Provide in accordance with Section 01600.
- B. All materials shall be shipped, stored, handled and installed in such a manner as not to degrade quality, serviceability, or appearance.

1.04 DESIGN CRITERIA

- A. The engine generator unit shall comply with the requirements of the Federal Environmental Protection Agency, State of Massachusetts Department of Environmental Protection, and NFPA 70.
- B. The engine generator unit shall be arranged for automatic starting and stopping on failure of, and restoration of the normal source of power, and for automatic load transfer, but not including the automatic load transfer switch which will be furnished separately.
- C. The engine generator unit shall include, but not be limited to excitation system, controls, keep warm system, cooling system, silencer, starting batteries, charger, and all essential and desirable appurtenances whether specifically mentioned in this specification or not.
- D. The system described herein, including but not necessarily limited to the engine generator set, engine auxiliaries, batteries and engine generator control panels shall be furnished by a single supplier who is regularly engaged in the production of diesel fueled engine driven generators.
- E. The voltage regulation shall be within plus or minus two percent from no load to full rated load. On application or removal of full rated load in one step, the transient voltage dip or overshoot shall not exceed twenty percent of rated voltage. Frequency regulation shall be within 3 Hertz from no load to full load.
- F. The voltage regulator shall be insensitive to severe load induced waveshape distortion from SCR or thyristor circuits such as those used in battery charging (UPS) and motor speed control equipment. This SCR immune regulator shall not reduce the motor starting capabilities as specified herein.
- G. Engine generator units of not less than KW rating indicated on the contract drawings, 0.8 power factor capacity with 3 phase, 60 Hertz, 480/277 Volts, 4 wire alternating current generator shall be furnished.
- H. The engine generator units shall be completely prewired and piped so that only field connections to a master terminal strip for control, auxiliaries and alarms, and power connections to a molded case line circuit breaker and fuel fill and vent line connections will be required.

- I. The engine generator unit and associated auxiliaries systems and components shall be skid mounted and installed outdoors.

1.05 QUALIFICATIONS

- A. The generator units shall be the standard product, as modified by these Specifications, of one of the following manufacturer listed below. Engine generator unit shall be a standard production model of proven ability and shall be designed, constructed, and installed in accordance with the best practice and methods. In addition, the manufacturer shall maintain a permanent service organization and supply of spare parts as necessary to provide adequate service within 60 miles of the site. The design basis for the generator size including the enclosure and base tank are based on a Kohler unit with dimensions of 28' Length, 6.5' Width, 11.5' Height. Due to constraints on the site, units by the other manufactures must not exceed these dimension of by more than 10% which may require custom fabricated enclosures by the manufacture.
 1. Caterpillar
 2. Cummins
 3. Kohler
- B. The engine generators shall be a factory assembled unit specifically designed and fitted for operation on diesel fuel. The engine generator unit shall be free from injurious torsional or other vibration, and shall be assembled on an adequate steel subbase suitable for mounting on vibration isolation pads, on a flat concrete surface which is suitable for supporting the weight of the unit. The vibration installation material shall be furnished with the engine generator unit.
- C. The engine generator unit will be installed in Taunton, MA and rated for use at this location's elevation level. Outdoor enclosed units shall be provided with heating and cooling as required to maintain the generator set operational within the temperature limits of all devices and equipment. The engine generator unit shall be suitable for continuous operation at any temperature between 0 and 110 degree F at its full load rating and at 80 percent power factor.
- D. The engine generator unit shall be designed and built in accordance with the latest standards of IEEE, NEMA, ANSI and ASME.
- E. The engine generator unit shall be designed to minimize the danger of accidents to operating and maintenance personnel. The manufacturer shall, prior to shipment, verify that all electrical connections are tight and that circuits are isolated, that on-set piping connections are well-made, and that standard safety equipment is included and functions according to design.

1.06 ENGINE GENERATOR UNIT PERFORMANCE

- A. The engine generator unit shall maintain rated frequency from no load to full rated load.
- B. The voltage regulation shall be as specified herein and recovery to steady state operation shall be within two seconds.

- C. Stable or steady state operation is defined as operation with terminal voltage remaining constant within plus or minus one percent of rated voltage. A rheostat shall provide a minimum of plus or minus five percent voltage adjustment from rated voltage.
- D. Frequency regulation shall be maintained within 2½ percent of rated frequency from no load to full load. The steady state frequency shall be within 0.5 percent of rated frequency.
- E. The engine shall be equipped with a electronic isochronous governor capable of maintaining the engine speed from no load to full load within plus or minus .25 percent of the synchronous speed.

1.07 PRODUCT HANDLING

- A. All materials shall be shipped, stored, handled and installed in such a manner as not to degrade quality, serviceability, or appearance.
- B. Protect material and equipment, in accordance with the manufacturers recommended storage procedures, before, during, and after installation. Stored items shall be protected from the weather and contamination. During installation, piping and similar openings shall be capped to keep out dirt and other foreign matter.

1.08 WARRANTY/SERVICE

- A. The manufacturer's and dealers Extended Service Coverage shall in no event be for a period of less than five (5) years from date of Owner/Engineer's acceptance of the system and shall include repair parts, labor, travel expense necessary for repairs at the jobsite, and expendables (lubricating oil, filters, antifreeze, and other service items made unusable by the defect) used during the course of maintenance and repair. Applicable deductible costs applying only after the first year shall be specified in the manufacturer's warranty and not exceed \$500 per site visit. Submittals received without written warranties as specified will be rejected in their entirety. Warranty and maintenance shall be issued and executed by the dealer and may not be subcontracted.
- B. The generator set supplier shall have factory trained service representatives and tooling necessary to install, test maintain, and repair all provided equipment and shall be located within 150 miles of the customer's site.

PART 2 – PRODUCTS

2.01 ENGINE

- A. The engine shall be diesel fueled, four (4) cycle, water-cooled, while operating with nominal speed not exceeding 1800 RPM. The engine shall meet applicable EPA non-road mobile regulations and/or the EPA NSPS rule for stationary reciprocating compression ignition engines. Additionally, the engine shall comply with the State and Federal emission regulations at the time of installation/commissioning. Actual engine

emissions values must be in compliance with applicable EPA emissions standards per ISO 8178 Emissions Cycle at specified ekW/bHP rating.

- B. The engine shall be furnished with thermostatically controlled jacket water heaters of the size recommended by the supplier. Heaters shall be rated at 4,000 Watts for operation on 208 Volts.
- C. The oil sump will be fitted with pipe nipples, a ball valve, and an extension oil drain.
- D. The engine shall be provided with a governor which maintains the frequency within a bandwidth of the rated frequency, over a steady-state load range of zero to 100% of rated output capacity. The governor shall be configured for safe manual adjustment of the speed/frequency during operation of the engine-generator set, without special tools, from 90 to 110% of the rated speed/frequency, over a steady state load range of 0 to 110% or rated capacity.
 - 1. Steady state speed band, +/- 0.25% of rated speed.
 - 2. Internal oil pump, relief valve and accumulator controls governor operating pressure.
 - 3. Manual speed adjustment knob at top of unit.
 - 4. Positive locking to allow manual speed adjustment.

2.02 COOLING SYSTEM

- A. The engine shall be furnished with a unit mounted radiator. The radiator shall be of sufficient size to cool the water when ambient temperature is 100 degrees F. and the engine generator unit is operating at full rated load continuously.
- B. Cooling system shall further include water cooled manifolds, pusher fans and high temperature cutout. Provide radiator duct connector complete with suitable gasket, bolts and nuts. The cooling system shall be furnished with sufficient antifreeze solution to protect the cooling system with ambient air temperature down to minus fifty degrees F.
- C. Provide an anti-freeze treatment as recommended by the manufacturer for protection against corrosion and scale formation. The anti-freeze treatment shall be compatible with the antifreeze solution. The anti-freeze will be long life environmentally friendly polypropylene glycol. The concentration will be as recommended by the manufacturer.

2.03 FUEL SYSTEM

- A. The engine shall be furnished with filter, fuel pressure gage and engine priming pump.
- B. The engine-generator unit shall be furnished with an approximate 36 inch high, double-walled fuel base-tank with leak detection and fuel capacity for 48 hours of generator operation at full load. Tank shall be constructed of heavy gauge steel; epoxy coated

interior, and Housing surfaces shall have a corrosion resistant epoxy based hardened rubberized coating.

1. Tank shall conform to NFPA 30 and NFPA 47.
2. The diesel fuel oil tank shall have tappings for fuel supply and return. It shall be equipped with a suitable vent cap. The fill pipe shall be extended to the exterior wall and easily accessible and lockable.
3. The tank shall be dual wall constructed of steel and mounted directly to the generator set skid, and shall be provided with low fuel and leak detection alarms and dry contacts. For added protection the rupture basin portion of the tank shall have a leak monitoring system utilizing a non-toxic, non-volatile liquid to determine integrity of external rupture basin wall. This shall be coordinated to operate with floats and sensors of the fuel tank.
4. An 8 gallon overflow tank shall be furnished at the generator fill. The generator shall be furnished with a 2 inch diesel vent fuel line. The diesel fuel tank shall be furnished with audible and visual alarms at the fill gauge.
5. Vent and overflow piping to be provided.
6. Fuel gauge.
7. Provide tank openings to allow manual level measurement with stick gauges.

2.04 EXHAUST SILENCER

- A. The engine generator unit shall be provided with a critical type silencer including flexible exhaust fittings. Silencers shall be mounted so that its weight is not supported by the engine. Exhaust piping shall be sized as recommended by the manufacturer. Connection between engine and silencer shall be of the stainless steel flexible type.
- B. A flexible section shall be provided at each engine and an expansion joint at each muffler. Flexible sections and expansion joints shall have flanged connections. Flexible sections shall be made of convoluted seamless tube without joints or packing. Expansion joints shall be the bellows type. Expansion and flexible elements shall be stainless steel suitable for diesel-engine exhaust gas at the maximum exhaust temperature that is specified by the engine manufacturer. Expansion and flexible elements shall be capable of absorbing vibration from the engine and compensation for thermal expansion and contraction.
- C. Horizontal sections of exhaust piping shall be sloped downward away from the engine to a drip leg for collection of condensate with drain valve and cap. Changes in direction shall be long radius. Exhaust piping, mufflers and silencers installed shall be insulated with 3 inches of calcium silicate insulation and covered with aluminum flashing to protect personnel.
- D. All portions of the exhaust system shall be insulated and covered with flashing.

2.05 STARTING SYSTEM

- A. The electric starting system shall consist of the following equipment:
 - 1. The engine shall have a two wire, direct current starter suitable for automatic starting through the load transfer switch.
 - 2. Batteries shall be of the lead-acid type. Batteries shall be guaranteed to have sufficient capacity when in a fully charged state to perform not less than five, 15 second cranks while in an ambient temperature of 0 degrees F without recharging.
 - 3. Current limiting type automatic battery charger conforming to UL 1236 shall be of the static type, magnetic amplifier control with led status lights, battery temperature compensation, and user adjustable parameters factory set to match battery charge curve. Charger to be completely automatic, charging rate to be determined by the state of the battery, and reducing to milliamp current on a fully charged battery. Charger shall be for 120 Volt, single phase, 60 Hertz A.C. input with an output of not less than 10 amperes. The charger shall be for the correct voltage for the battery, and specifically for charging a lead-acid battery and for panel mounting.

2.06 ALTERNATOR

- A. The alternator shall be single bearing, open, dripproof revolving field, four pole brushless type, permanently aligned to the engine by flexible disc coupling. Each unit shall be reconnectable type having nine leads and shall be factory connected for three phase, 4 wire, 60 Hertz. The rating of the unit shall be as indicated on the drawings.
- B. Alternators shall have Class F insulation and shall be furnished with Amortisseur windings. Alternators shall have a complete static automatic voltage regulator which will hold the voltage within plus or minus two percent from no load to full rated load. On application of rated load in one step, the transient voltage dip shall not exceed twenty percent. The generator windings shall be braced to withstand any possible short circuit stresses. Alternator shall be "Radio Interference Proof" (RIP) and "Telephone Influence Factor" (TIF) and shall be within the limits of Section 9, ANSI C50.12. Alternators shall have a rotating brushless exciter and rectifier.
- C. The alternator characteristics shall be matched to the torque characteristics of the engine in such a manner that with full load connected to the alternator terminals, the alternator will utilize all the available engine power without exceeding it at all speeds.
- D. The generator exciter shall be of the brushless type. Semiconductor rectifiers shall have a minimum safety factor of 300% for peak inverse voltage and forward current ratings for all operating conditions, including 110% generator output at 40 degrees C 104 degrees F ambient. The exciter and regulator in combination shall maintain generator-output voltage within the limits specified.

- E. Each generator shall be provided with a solid-state voltage regulator, separate from the exciter. The regulator shall maintain the voltage within a bandwidth of the rated voltage, over a steady-state load range of zero to 100% of rated output capacity. Regulator shall be configured for safe manual adjustment of the engine-generator voltage output without special tools, during operation, from 90 to 110% of the rated voltage over the steady state load range of 0 to 100% of rated output capacity. Regulation drift shall not exceed plus or minus 0.5% for an ambient temperature change of 20 degrees C. 68 degrees F.
- F. Alternators shall be furnished with 120V stator heater and controls.

2.07 CONTROLS

- A. The engine generator units shall be furnished with a shock resistant, engine mounted NFPA 110 compliant microprocessor based controller.
- B. Standard data available shall include:
 - 1. Jacket water temperature
 - 2. Lube oil temperature
 - 3. Lube oil pressure
 - 4. Battery voltage
 - 5. RPM
 - 6. A.C. Voltmeter
 - 7. A.C. Ammeter
 - 8. Frequency meter
 - 9. Elapsed time meter calibrated in hours and tenths of hours
- C. Accessories shall include:
 - 1. Current transformers.
 - 2. Fuses
 - 3. Generator voltage regulator
 - 4. Voltage adjusting rheostat.
 - 5. Fault indication lights one each for:
 - a. low oil pressure
 - b. high water temperature

- c. overspeed
 - d. overcrank (fail to start).
 - 6. Prewarn indication lights one each for:
 - a. low oil pressure
 - b. high water temperature.
 - 7. 90 DB (a) Audible alarm to sound on any fault or prewarn and an alarm silencer.
 - 8. Mode selector switch – "AUTO", "OFF", "MANUAL" with audible alarm when switch is not in "AUTO" position.
 - 9. Control power fuse.
 - 10. Fixed overcrank timer - four-10 second cranks shall be provided. After four cranks, the unit shall stop and an alarm initiated.
 - 11. Auxiliary contacts which close when engine is in operation. Contacts shall be rated 10 amperes and shall be used to interlock combustion and ventilation air dampers.
 - 12. Common failure relay
 - 13. Dry contact kit with the minimum following contact signals:
 - a. Engine Running
 - b. Engine Trouble
 - c. Battery Charger Alarm
 - 14. Engine sensors for low water temperature near low oil pressure, near high water temperature.
- C. In addition to the equipment included in the control panel described above, the unit shall include a power and control junction box mounted on the generator. This junction box shall include:
- 1. Three phase power conductors terminated with pressure type ring connectors.
 - 2. Neutral connection.
 - 3. Terminal block with marked connection points for all external control connections and for jacket heaters, etc.
 - 4. Molded case line circuit breaker with interrupting rating of 100 KA amperes RMS, electronic LSI, and ground fault relay alarm.
- D. Automatic shutdown shall be provided for each of the following conditions:

1. High jacket water temperature
 2. Low jacket water pressure
 3. Low lubricating oil pressure
 4. Engine overspeed
 5. Unit fail to start.
- E. Auxiliary normal open dry contacts shall be provided for remote transmission of unit failure.

2.08 SUB-BASE

- A. The engine, generator and radiator shall be mounted on a structural steel base designed to maintain proper alignment. Vibration isolators shall be furnished of the size and type recommended by the supplier.

2.09 ENCLOSURE

- A. A sound-attenuated weather-protective housing shall be furnished. The housing shall enclose the complete unit and all related equipment (e.g. battery, battery charger, engine controls and control panel, etc). All components shall be wired and piped within the enclosure.
- B. The housing shall be constructed of 0.125" formed aluminum formed and shall include hinged locking access doors. Housing surfaces shall have a corrosion resistant epoxy primer coat and a dark green powder TGIC powder coat finish.
- C. The housing shall be sound insulated, vandal proof, and padlocked. The resulting structure with engine-generator in operation shall not transmit more than 76 db at a distance of 23 feet from the generator in any direction. There shall be no Puretone. The generator set manufacturer shall choose the thickness of insulation to meet the aforementioned sound criteria.
- D. The housing shall be furnished with weather-protective fixed louvers, and weather-protective flanged door openings to insure weather-resistant construction.
- E. Stainless steel flexible exhaust sections shall be provided. Exhaust outlet shall be terminated with a "shanty cap" designed so to prevent entrance of rain into exhaust outlet. All handles, sheet metal screws, bolts, nuts, hinges, and other exterior hardware shall be stainless steel.
- F. Provide factory wired instruction detection style doors switches for each of the enclosure entry doors that shall be wired in series to one another and terminated at a junction box within the generator enclosure.

PART 3 – EXECUTION

3.01 MANUFACTURER'S SERVICES

- A. A minimum of one, eight-hour day shall be provided to supervise the installation and testing of the equipment furnished, to assist in start-up and train Owners maintenance personnel.
- B. A minimum of one, four hour day, not including travel time to and from the site, shall be used by a fully qualified field service engineer to make necessary adjustments and to provide operator training on the equipment furnished. This work shall occur after the equipment has been in operation and at the request of the owner, but not to exceed one year after the acceptance of the facility.

3.02 TESTS

- A. At least 48 hours prior to the load test, the manufacturer shall perform a pretest. The pretest shall be conducted in the presence of the Engineer. The pretest shall determine that the unit is ready for load testing and that all components are functioning correctly. All adjustment for tuning the unit shall be made during the pretest. If remedial work is required, the work shall be performed before the load test is conducted.
- B. Upon completion of the installation, the manufacturer of the equipment shall test the complete unit, at full load, using load banks, for four continuous hours. During the test, the following data shall be taken at 15 minute intervals:
 - 1. Outside air temperature
 - 2. Generator room temperature
 - 3. Oil pressure
 - 4. Oil temperature
 - 5. Jacket water temperature
 - 6. Battery charge rate
 - 7. Fuel pressure
 - 8. A.C. Volts
 - 9. A.C. Amps
 - 10. Frequency
 - 11. Kilowatts.
- C. Following the test, three successive simulated power outages shall be conducted using all connected building load.
- D. The equipment shall be left in good operating order and the settings of all alarm and shutdown devices verified.
- E. The diesel fuel required for testing shall be supplied by the electrical contractor, upon engineer acceptance of the tests results the electrical contractor shall fill the generator's base tank and make the unit completely ready for full operation.

3.03 OPERATION AND MAINTENANCE MANUALS

- A. Furnish Operation and Maintenance Manuals as specified in Section 01730.
- B. Maintenance instructions shall be furnished for batteries, to include simple and clear procedures for addition of liquids, maintaining cleanliness, proper ventilation, proper electrical connections.
- C. Maintenance instruction shall be furnished for engines, including recommended lubricants, coolants, etc., recommended maintenance intervals, and recommended ventilation requirements.
- D. The Operating manual shall be a simple starting and stopping procedure, with reference to shop drawings information for more complicated procedures.

- END OF SECTION -

SECTION 16720

SECURITY ALARM SYSTEMS

PART 1 – GENERAL

1.01 DESCRIPTION

- A. The Work of this Section includes the furnishing and installing of complete security alarm systems as specified in the Contract Documents.
- B. The system shall include, but not be limited to, an alarm monitoring panel, magnetic door switches, timed exit/entry delay control keypad, heat detectors, help call pushbuttons, conduit, fittings and wire.
- C. Provide all required coordination with door installations for proper installation of alarm devices and wiring.

1.02 SUBMITTALS

- A. Manufacturer's literature and brochures shall be submitted for all items to be furnished in accordance with the provisions of the SECTION 01300, SUBMITTALS.
- B. Submittals required under this section include, but are not limited to the following:
 - 1. Complete system wiring diagrams and elementary or control schematic.
 - 2. Data sheets and outline drawings showing details for mounting all control devices and panel.
 - 3. Battery system load calculations.
 - 4. Standard preprinted sheets or drawings simply marked to indicate applicability to this contract will not be acceptable.

1.03 DELIVERY, STORAGE AND HANDLING

- A. Provide in accordance with Section 01600.
- B. All materials shall be shipped, stored, handled and installed in such a manner as not to degrade quality, serviceability, or appearance.

1.04 DESIGN CRITERIA

- A. The security system shall be the standard product, as modified by these Specifications of a manufacturer regularly engaged in the production of this type equipment. In addition, the manufacturer shall maintain a permanent service organization and a supply of spare

parts as necessary to provide adequate service to this system within 24 hours from receipt of a request for service.

- B. The security system shall be UL approved.

1.05 SYSTEM OPERATION

- A. The system shall have the following alarm zones.

1. Pump Station Intrusion
2. Wet Well Intrusion
3. Pump Station Lower Level Fire
4. Pump Station Ground Floor Fire
5. Pump Station Attic Fire
6. Generator Enclosure Intrusion
7. Help Call
8. Spare

- B. Actuation of the door switch, heat detector, or Help Call Pushbutton shall:

1. Actuate the respective zone alarm lamp at the security alarm key pad.
2. Actuate discrete remote dry contact alarm for the associated zone to SCADA system.

- C. The security alarm key pad panel shall allow a timed exit/entry control to access the building without tripping the alarm. Authorized personnel entering the building will have up to five minutes to de-activate the alarm system prior to sending an alarm output.

- D. Opens, ground, or tampering, occurring on the zone monitor circuit during bypass or secure mode of operation shall cause a trouble signal. To clear a trouble signal transmission, the trouble must be corrected and the system will automatically return to its normal state of operation. To restore the device actuating the alarm, the alarm must be secured to its normal position and the system reset switch operated. A trouble signal on an individual zone monitor circuit shall not interfere with the automatic transmission of an alarm signal on another zone monitor circuit occurring during the same period.

PART 2 – PRODUCTS

2.01 SYSTEM CONFIGURATION

- A. Provide a complete integrated security system consisting of the following major subsystems:
 - 1. Detection subsystem: Subsystem shall consist of sensors to detect intrusion attempts.
 - 2. Security Alarm Key Pad: Subsystem shall consist a speaker, annunciation lights, function keys, and annunciation display to properly display and control all security system functions and alarms.
 - 3. Communications subsystem: Subsystem shall consist of elements required to ensure that pertinent data is transferred from the point of origin to the point where appropriate actions can be taken.
 - 4. Assessment subsystem: Subsystem shall consist of electronic devices required to visually and audibly verify the validity of security system alarms.
 - 5. Alarm reporting subsystem: Subsystem shall consist of electronic devices to control, process, integrate, and annunciate security system data.
 - 6. Power subsystem: Subsystem shall consist of components required to ensure continuous operation of the entire security system.
- B. All system functions, alarms and annunciations shall be monitored and controlled at the security alarm key pad.
- C. The system shall have the capacity to collect date/time entry data in non-volatile memory and display the date/time entry when requested by an authorized user.
- D. The system shall have the capacity to collect, communicate, and display a minimum of 4 programmable sensor zone alarms and to enable control of one or more response devices in each of the sensor zones.
- E. A single alarm shall be annunciated at security alarm key panel within approximately 2 seconds after sensor transducer or other detection device activation.
- F. Provide the capability to detect when a critical component of the system experiences temporary or permanent loss of power and to declare an alarm at the security alarm keypad.
- G. Intrusion alarms shall not be generated by power switching; however, an indication of power switching and on-line source shall be provided at the security alarm keypad. Upon restoration of normal power, the system shall automatically switch back to the primary source. Low voltage condition of an on-line battery and battery charger circuit failure shall be detected and reported as a fault condition.

2.02 SECURITY CONTROL PANEL

- A. Provide micro-processor based modular components to make up a complete control system. The panel shall have the following features:
1. Alarm output relays.
 2. Zone modules, number as required for proper functionality for each system, access lamps, secure lamps, access/secure key switches for each.
 3. Earth detection module.
 4. Sealed lead acid battery standby power shall be supplied. It shall be under lock and key within this supervised cabinet to prevent deliberate tampering.
 5. Solid state battery charger.
 6. Alarm resound module.
 7. Total system supervision by a micro-processor which will supervise all wiring regardless whether or not the area of protection is bypassed or not.
 8. Quantity three normally open dry contacts which close on alarm conditions.
 9. Surge protector.
- B. Electrical power shall be obtained by the normal electrical distribution system. Power shall be continuously monitored and, if interrupted, automatic switching from primary to emergency backup source shall be accomplished without interruption or degradation of critical system function.
- C. Furnish 120 volt AC service, transformed through a two-winding isolation transformer and rectified to low-voltage DC for system operation. Obtain primary power at the 120V breaker as indicated in the Contract Documents.
- D. Provide lockable device at circuit breaker and label the circuit breaker in that panelboard: "Alarm System Do Not Turn Off."
- E. Provide backup power to the primary power by dedicated batteries in the Control Panel. Batteries shall be capable of operation in any position and shall be protected against venting caustic chemicals or fumes within an equipment cabinet. Batteries shall also be capable of continuous operation for up to 4 hours without recharge or replacement. If the sensors power requirements exceed the allowable UL rated capacity of the control communicator battery, provide the number of separate power supplies required to power the sensors. Provide each power supply with its own rechargeable battery and charger.

- F. Provide system components to facilitate modular subassembly and part replacement. Electronic components of the system shall be of the solid-state type, mounted on printed circuit boards conforming to UL 796. Circuitry shall not be so densely placed as to impede maintenance. Power-dissipating components shall incorporate safety margins of not less than 25 percent with respect to dissipation ratings, maximum voltages, and current-carrying capacity. Light duty relays and similar switching devices shall be solid-state or hermetically sealed electromechanical type.
- G. Provide only components in current manufacturing production. Components shall be manufactured to meet requirements specified herein and shall be free from characteristics and defects which affect appearance or serviceability or which render equipment unsuitable for the intended purpose. Provide components designed for continuous operation at specified conditions.
- H. Intrusion detection, communication, and power circuits shall be protected against lightning and voltage transients. Surge suppression device shall conform to UL 1449, rated single pulse transient energy by metal oxide varistor (MOV). The protective device shall be automatic and resettable and shall be active at all times. Fuses shall not be permitted as protection devices.
- I. Provide control devices to ensure ease of operation of specified characteristics. Where applicable, clockwise rotation of controls shall result in an increasing function. Controls, switches, visual signals, and indicating devices, input and output connectors, terminals, and test points shall be clearly marked or labeled on hardware to permit quick identification, intended use, and location. Terminal markings and labels shall be of a permanent and legible type and located to be visible when the associated system wiring is in place. Identification markings shall be associated with each adjustment device or item requiring periodic maintenance. Safety warning or cautions shall be marked in conspicuous red letters. Controls not required for operation of the system shall be inaccessible to the system operator.
- J. Cabinets, control communicators, wiring gutters, and other component housings, collectively referred to as enclosures, shall be formed and assembled to be sturdy and rigid. Metal thickness shall not be less than those in Tables 8.1, 8.2, and 8.3 of UL 1610 for alarm components, and NEMA ICS 2 and NEMA ICS 6 for other enclosures.
- K. Doors and covers shall be flanged. Where doors are mounted on hinges with exposed pins, hinges shall be of the tight-pin type, or ends of hinge pins shall be tack welded to prevent ready removal. Provide doors having a latch edge length of less than 24 inches with a single lock. Covers of junction boxes provided to facilitate initial installation of the system shall be held in place by tack welding, brazing, or one-way screws.
- L. Ventilation openings in enclosures and cabinets shall conform to the requirements of UL 1610. Sheet metal enclosures shall be designed for surface or recessed wall mounting with top hole slotted.
- M. Locks and key-lock-operated switches required to be installed on component enclosures shall be UL listed, round-key type with three dual, one mushroom, and three plain pin

tumblers, or shall have a pick resistance equal to a lock having a combination of five cylinder pin and five-point three-position side bar in the same lock. Keys shall be stamped "DO NOT DUP". Key-lock-operated switches shall be keyed differently.

2.03 SECURITY ALARM KEY PAD

- A. Provide control devices to ensure ease of operation of specified characteristics. Where applicable, clockwise rotation of controls shall result in an increasing function. Controls, switches, visual signals, and indicating devices shall be clearly marked or labeled on hardware to permit quick identification, intended use, and location.
- B. Entry/Exit delay. Timer shall be adjustable from 0 to 5 minutes.
- C. Annunciators shall be liquid crystal displays (LCDs). Annunciators shall be so connected in the circuit that failure of the annunciator, socket, or protective circuitry shall not result in an improper or indeterminate signal. LCDs shall be compatible with standby power supplies.
- D. Common trouble signal, trouble silencing switch, power on lamp, reset switch, alarm acknowledge switch and common zone test.
- E. An alarm shall be annunciated to clearly identify any component experiencing power loss.

2.04 MAGNETIC SWITCHES

- A. The switch mechanism shall have a minimum gap of 3/8-inch and a maximum gap of 1 ¼ inches without internal adjustment.
- B. The magnetic and switch parts of the devices shall be fully encapsulated in a weatherproof enclosure, the switch portion shall have a factory 24" minimum armored cord containing the switch wiring
- C. The magnetic and switch parts of the devices be secured using tamper resistant to the door and from with stainless steel screws.
- E. Each end of the armored cord shall terminate in a junction box above the door. Armored cord ends shall be mechanically secured to junction boxes by clamps or bushings. The armored cord shall experience no mechanical strain as the door is removed from fully open to closed.
- F. Provide explosion proof rated limit switches in areas designated as NEMA 7.

2.05 HEAT DETECTORS

- A. Fixed temperature 135 degrees F, rate of rise, vapor-tight industrial grade units.

2.06 HELP CALL PUSHBUTTONS

- A. The pushbuttons shall be red, twist to release keyed pushbutton with a minimum (1) NO and (1) NC contact and mounted on a curved stainless steel plate factory engraved with "Help Call". The pushbutton shall surface mounted on a standard device box.
- B. Provide clear polycarbonate resin thermal covers over all Help Call pushbutton stations.

PART 3 – EXECUTION

3.01 INSTALLATION

- A. No wire smaller than No. 14 AWG shall be installed. All wiring shall be color coded.
- B. Coordinate the installation of the door switches and wiring with the existing doors.
- C. Ground system components and conductor and cable shields to eliminate shock hazard and to minimize ground loops, common-mode returns, noise pickup, cross talk, and other impairments.

3.02 TESTING

- A. Manufacturer's Field Services: Engage a factory-authorized service representative to inspect field-assembled components and perform system pretesting, testing, adjustment, and programming.
- B. Before the installation is considered complete and acceptable, a demonstration test on the entire system shall be performed as follows:
- C. Test shall ensure that the requisite degree of intrusion detection is provided.
- D. Test each sensor and subsystem component individually.
- E. When the function of each component within a particular subsystem, such as each sensor within a particular zone, is verified, certify that subsystem of the entire security system has satisfactorily met the specifications.
- F. Test each subsystem similarly until each detection zone has been certified. When subsystem certification is complete, test the entire integrated system to ensure that subsystem elements are compatible and function as a complete system.
- G. The integrated system test shall be accomplished in linear fashion, end-to-end, and shall verify that each simulated intrusion performed within each detection zone produces an

appropriate alarm or signal, and that alarm is correctly annunciated at the keypad and remotely.

- H. Provide for approval, not later than 30 days prior to formal inspection and test, a detailed operational test plan of how each component, subsystem, and entire security system will be tested.

3.03 ADJUSTING

- A. Occupancy Adjustment. When requested within 12 months of date of Substantial Completion, provide on-site assistance in adjusting and reprogramming to suit actual occupied conditions. Provide up to two visits for this purpose without additional cost.

3.04 DEMONSTRATION

- A. Engage a factory-authorized service representative to explain programming and operation of system and to train Owner's maintenance personnel on procedures and schedules for maintaining, programming, operating, adjusting, troubleshooting, and servicing system. Provide a minimum of four hours' training in operation and maintenance.

- END OF SECTION -