

City of Taunton, MA  
Wastewater Treatment Facility  
Phase 2 Improvements  
March 31, 2022

Bidding Requirements, Bond Forms, Contract Agreement,  
Conditions of the Contract and Technical Specifications

Bid Package #1 - General



Professional Registration No.: 30863



**BETA**

701 George Washington Hwy  
Lincoln, Rhode Island 02865  
401.333.2382  
[www.BETA-Inc.com](http://www.BETA-Inc.com)

## TABLE OF CONTENTS

<u>Section Number</u>	<u>Title</u>	<u>Page No.</u>
<b>Division 00 Bidding Requirements</b>		
00100	Notice to Bidders	00100-1 to 00100-3
00200	Information for Bidders	00200-1 to 00200-4
00300	Bid	00300-1 to 00300-6
00500	Contract Agreement	00500-1 to 00500-87
<b>Division 01 General Requirements</b>		
01010	Summary of Work	01010-1 to 01010-4
01025	Measurement and Payment	01025-1 to 01025-5
01026	Schedule of Values	01026-1 to 01026-1
01035	Modification Procedures	01035-1 to 01035-2
01040	Coordination	01040-1 to 01040-1
01045	Cutting, Coring and Patching	01045-1 to 01045-3
01050	Field Engineering	01050-1 to 01050-1
01060	Permits	01060-1 to 01060-2
	Attachment: City of Taunton Contractor Licensing Application	
	Attachment: Trench Permit Application	
	Attachment: Conservation Commission Order of Conditions	
01067	State of Massachusetts and Federal Requirements with Attachments	01067-1 to 01067-217
01069	Health and Safety Requirements	01069-1 to 01069-3
01090	Reference Standards	01090-1 to 01090-5
01170	Environmental Protection	01170-1 to 01170-5
01200	Project Meetings	01200-1 to 01200-1
01300	Submittals	01300-1 to 01300-5
01310	Construction Progress Schedule	01310-1 to 01310-4
01400	Quality Control	01400-1 to 01400-2
01410	Testing Laboratory Services	01410-1 to 01410-3
01441	Project Sign	01441-1 to 01441-2
01525	Temporary Enclosures	01525-1 to 01525-1
01560	Temporary Controls	01560-1 to 01560-3
01590	Field Offices	01590-1 to 01590-3
01600	Materials and Equipment	01600-1 to 01600-2
01665	Services of Manufacturer's Representatives	01665-1 to 01665-6
01680	Equipment and System Checkout, Certifications, and Testing	01680-1 to 01680-5
01700	Contract Closeout	01700-1 to 01700-4
01710	Startup	01710-1 to 01710-3
01730	Operation and Maintenance Manuals	01730-1 to 01730-3

<u>Section Number</u>	<u>Title</u>	<u>Page No.</u>
<b>Division 01    General Requirements (continued)</b>		
01740	Warranties	01740-1 to 01740-2
01750	Spare Parts	01750-1 to 01750-1
01751	Lubricants	01751-1 to 01751-1
01800	Maintenance	01800-1 to 01800-2
01810	Maintenance of Plant Operation and Sequence of Construction	01810-1 to 01810-8
 <b>Division 02    Site Work</b>		
02050	Demolition	02050-1 to 02050-3
02075	Management of Underground Storage Tanks	02075-1 to 02075-5
02080	Management of Contaminated Soil	02080-1 to 02080-8
02140	Dewatering	02140-1 to 02140-7
01249	Maintaining Existing Flow	02149-1 to 02149-
02160	Excavation Support	02160-1 to 02160-14
02200	Earth Excavation, Backfill, Fill and Grading	02200-1 to 02200-10
02215	Aggregate Materials	02215-1 to 02215-3
02220	Riprap	02220-1 to 02220-2
02224	Controlled Density Fill	02224-1 to 02224-4
02272	Geotextile Materials	02272-1 to 02272-4
02276	Silt Fence	02276-1 to 02276-2
02277	Straw Wattles	02277-1 to 02277-2
02500	Pavement	02500-1 to 02500-6
02607	Precast Concrete Manholes and Structures	02607-1 to 02607-8
02618	Ductile Iron Pipe and Fittings For Buried Service	02618-1 to 02618-11
02620	High Density Polyethylene Pipe	02620-1 to 02620-5
02622	Polyvinyl Chloride Gravity Sewer Pipe	02622-1 to 02622-8
02627	Polyvinyl Chloride Pipe for Buried Low Pressure Service	02627-1 to 02627-6
02629	Underground Utility Marking Tape	02629-1 to 02629-2
02831	Chain Link Fence and Gates	02831-1 to 02831-7
02930	Loaming and Seeding	02930-1 to 02930-3
 <b>Division 03    Concrete</b>		
03100	Concrete Formwork	03100-1 to 03100-6
03200	Concrete Reinforcement	03200-1 to 03200-6
03250	Expansion, Construction, and Control Joints	03205-1 to 03250-6
03252	Waterstops	03252-1 to 03252-4
03300	Cast-In-Place Concrete	03300-1 to 03300-11
03604	Non-Shrink Construction Grout	03604-1 to 03604-3
03930	Concrete Rehabilitation	03930-1 to 03930-12
03940	Crack Repairs by Epoxy Injection	03940-1 to 03940-6

<u>Section Number</u>	<u>Title</u>	<u>Page No.</u>
<b>Division 05</b>	<b>Metals</b>	
05120	Structural Steel Framing	05120-1 to 05120-11
05500	Metal Fabrications	05500-1 to 05500-9
05510	Aluminum Stairs and Ladders	05510-1 to 05510-5
05520	Aluminum Handrails and Railings	05520-1 to 05520-4
05530	Metal Grating	05530-1 to 05530-6
<b>Division 06</b>	<b>Wood and Plastics</b>	
06600	FRP Products and Fabrications	06600-1 to 06600-5
<b>Division 07</b>	<b>Thermal and Moisture Protection</b>	
07002	Waterproofing, Damp-Proofing, and Caulking	07002-1 to 07002-1
07190	Vapor and Air Barriers	07190-1 to 07190-5
07212	Board Insulation	07212-1 to 07212-3
07840	Penetration Firestopping	07840-1 to 07840-13
07900	Joint Sealants	07900-1 to 07900-6
<b>Division 09</b>	<b>Finishes</b>	
09880	Concrete Protective Coating	09880-1 to 09880-5
09900	Painting	09900-1 to 09900-8
09920	Non-Slip Epoxy Coating	09920-1 to 09920-7
<b>Division 10</b>	<b>Specialties</b>	
10441	Signs	10441-1 to 10441-8
<b>Division 11</b>	<b>Equipment</b>	
11100	Automatic Algae Sweeping System (Alternate #1)	11100-1 to 11100-6
11282	Stainless Steel Slide Gates	11282-1 to 11282-13
11300	Peristaltic Chemical Metering Pump System	11300-1 to 11300-9
11301	Submersible Mixers	11301-1 to 11301-8
11305	Submersible Sewage Dewatering Pumps	11305-1 to 11305-7
11312	Vertical Centrifugal Pumps (Bid Package #3)	11312-1 to 11312-9
11315	Submersible Propeller Pumps	11315-1 to 11315-7
11316	Vertical Shaft Hyperbolic Mixer/Aerators	11316-1 to 11316-
11327	Final Clarifier Equipment (Alternate #1)	11327-1 to 11327-16
11329	Density Current Baffle System (Alternate #1)	11329-1 to 11329-4
11372	Positive Displacement Blowers	11372-1 to 11372-10
11376	Fine Bubble Aeration Equipment	11376-1 to 11376-9
11378	Single Stage Centrifugal Air Blowers	11378-1 to 11378-19

<u>Section Number</u>	<u>Title</u>	<u>Page No.</u>
11400	Polyethylene Chemical Storage Tanks	11400-1 to 11400-8
11600	FRP Baffle Walls	11600-1 to 11600-4
11601	FRP Weirs and Scum Baffles	11601-1 to 11601-3
11961	Interior and Exterior Process Piping	11961-1 to 11961-34
<b>Division 13</b>	<b>Special Construction</b>	
13320	Instrumentation	13320-1 to 13320-27
13321	Instrumentation and Controls	13321-1 to 13321-161
<b>Division 14</b>	<b>Conveying Systems</b>	
14600	Pump & Mixer Hoisting Equipment	14600-1 to 14600-4
14601	Monorail Hoisting Equipment	14601-1 to 14601-3
<b>Division 15</b>	<b>Mechanical</b>	
15050	Gauges	15050-1 to 15050-3
15060	Pipe Hangers and Supports	15060-1 to 15060-12
15066	Stainless Steel Pipe	15066-1 to 15066-11
15100	Above Ground Fuel Storage Systems	15100-1 to 15100-8
15400	Plumbing	15400-1 to 15400-24
15600	Heating, Ventilation, and Air Conditioning	15600-1 to 15600-29
<b>Division 16</b>	<b>Electrical</b>	
16000	Basic Electrical Requirements	16000-1 to 16000-10
16060	Grounding System	16060-1 to 16060-3
16080	Underground Systems	16080-1 to 16080-2
16085	Miscellaneous Equipment	16085-1 to 16085-6
16120	Wires and Cables	16120-1 to 16120-4
16130	Raceways and Fittings	16130-1 to 16130-6
16442	Panelboards	16442-1 to 16442-4
16443	Motor Control Centers	16443-1 to 16443-13
16495	Variable Frequency Drives	16495-1 to 16495-6
16500	Lighting Systems	16500-1 to 16500-5
16721	Fire Alarm Systems	16721-1 to 16721-9

**Appendix A Geotechnical Report**

**DIVISION 00**

## SECTION 00100

### INVITATION TO BID

#### CITY OF TAUNTON, MA WASTEWATER TREATMENT FACILITY PHASE 2 IMPROVEMENTS BID PACKAGE #1 - GENERAL CONTRACT S-2022-1, CWSRF NO. 6760

On behalf of the City of Taunton, MA, Veolia Water North America - Northeast, LLC ("Veolia") is seeking bids for Phase 2 Improvements project. Veolia has prequalified firms interested in submitting bids for this project. Only prequalified firms will be permitted to submit bids.

Sealed Bids for the construction of the Phase 2 Improvements project shall be sent to Carl Hendrickson, via electronic mail, at [carl.hendrickson@veolia.com](mailto:carl.hendrickson@veolia.com). **All bids must be received by 4:00 PM, April 28<sup>th</sup>, 2022 in Portable Document Format (PDF).**

The following documents must be included with the Bid Form:

- Appendix A1 - Certification Statement
- Appendix B - Diesel Retrofit Program - Statement of Intent to Comply
- Bid Bond

The subject line of the email submittal should read:

BID - Taunton WWTF Phase 2 Improvements Bid Package #1 – General, CWSRF 6760

The work consists of wastewater treatment plant improvements as follows:

##### Bid Package #1 – General

Bid Package #1 consists of all work not included in Packages #2-3, including:

- Retrofit of existing biological treatment tanks
- Construction of new biological treatment tanks
- Furnish and install blowers and associated equipment for biological treatment system
- **Installation** (mechanical and electrical) of secondary sludge pumping systems (RAS and WAS) (Pumps Procured under Package #3)
- Conversion of existing blower building to storage space
- Electrical work as shown in the contract documents - Electrical drawings and Specifications Division 16
- Install instrumentation and control panels furnished under Division 13 and Division 11
- Excavated removal of three (3) underground fuel storage tanks and replacement with above-ground tanks.
- **ADDITIVE ALTERNATIVE #1 - Rehabilitation and equipment replacement of final clarifiers (see Specification Section 01025 for definition)**
- **Contractor should note the scheduling requirements and sequencing outlined in Specification Section 01810 – Maintenance of Plant Operation and Sequence of Construction**

##### Bid Package #2 – Instrumentation and Control

- Furnish and program Instrumentation and control equipment as shown in the Contract Documents – Instrumentation drawings and Specifications Division 13

Bid Package #3 – Secondary Sludge Pumps Procurement

- Furnish vertical centrifugal pumps for secondary sludge pumping (RAS and WAS) as specified in Specification Section 11312.

all as more particularly indicated, shown or described in the Drawings, Specifications, and other Contract Documents.

Additional Details are provided in Section 00500 Construction Agreement, Attachment A - Scope of Work.

The Subcontractor shall complete all work required under the Contract within 548 calendar days after the date of the Notice of Award. Work performed beyond the completion date will be subjected to liquidated damages in the amount of \$1,000 per day.

A pre-bid conference will not be scheduled. Subcontractors can schedule site visits by contacting Carl Hendrickson at 617-999-8716. Veolia will transmit to all prospective Bidders of record such Addenda as Veolia considers necessary in response to questions. Oral statements may not be relied upon and will not be binding or legally effective.

A .pdf copy of the Contract Documents for the Work may be obtained from the office of Veolia by contacting Carl Hendrickson, 617-999-8716, [carl.hendrickson@veolia.com](mailto:carl.hendrickson@veolia.com). Hard copies will not be provided. The Contract Documents may be examined during normal business hours from 7:00 a.m. to 3:30 p.m. at the following location:

Taunton Wastewater Treatment Facility  
825 West Water Street  
Taunton, MA 02780

This Contract to be awarded as the result of this Advertisement for Bids is funded in part through the Massachusetts Department of Environmental Protection, Bureau of Resource Protection, by loans from the Massachusetts Water Pollution Abatement Trust. This Contract will be subject to the Department of Environmental Protection regulations contained in 310 CMR 44.00, "DEP Selection, Approval and Regulation of Water Pollution Abatement Projects Receiving Financial Assistance from the State Revolving Fund" in effect on the date of issuance of the assistance award (DEP Project Approval Certificate) by the Department.

The Project requires compliance with the Massachusetts Department of Environmental Protection Diesel Retrofit Program (MDRP) by use of engine emission controls that are EPA certified, or their equivalent, on all diesel powered non-road construction equipment used at the job site. Bidders must submit a signed and dated Statement of Intent to Comply as part of their Bid Proposal Document. The Statement of Intent to Comply is attached as Appendix B to the Agreement.

Failure to comply with these DEP requirements may be deemed to render a proposal nonresponsive. No waiver of any provision of these DEP requirements will be granted unless approved by the Department of Environmental Protection.

As Security, each Bid must be accompanied by a Bid Bond having as surety thereto, such Surety Company or Companies as are authorized to do business in the State of Massachusetts of an amount not less than five (5) percent of the Bid. No bid will be accepted unless accompanied by the required bid deposit.

For the successful Bidder a Performance Bond and a Payment Bond, each in the amount of 100 percent of the Contract Price, will be required in the form described in Exhibit J to the Agreement. All such bonds shall be issued by eligible sureties listed in the current US Department of Treasury Circular 570, qualified to do business under the laws of the Commonwealth of Massachusetts and satisfactory to the Owner.

Bidders shall not include Federal Excise Taxes or State of Massachusetts Sales Taxes from which Public Building Projects are exempt.

No Bidder may withdraw its Bid within 30 days (Saturdays, Sundays and legal holidays excluded) after the actual date of the Bid Opening.



Any proposed modification or equipment substitution that results in a change to the design to accommodate a manufacturer other than that named in the Specifications must be highlighted in the bid documents, including but not limited to modifications of existing piping, designed piping, electrical loads, dimensions, performance efficiencies, operational criteria, anchoring systems, warranties and spare parts.

Veolia reserves the right to accept any Bid, waive any informalities or minor defects, or reject any or all Bids, if in its sole judgment it is in the best interest of Veolia to do so. Veolia does not discriminate on the basis of sex, race, age, physical disability, religion or national origin.

Disadvantaged Business Enterprise (DBE) goals are applicable to the total dollars paid to the construction contract. The goals for this project are a minimum of **5.7% percent D/MBE participation and 6.1% percent D/WBE participation by certified DBEs**. The two low bidders shall submit completed DBE forms (EEO-DEP-190C, EEO-DEP-191C and the DBE Certification of United States Citizenship form) by the close of business on the third business day after bid opening. Failure to comply with the requirements of this paragraph may be deemed to render a proposal non-responsive. No waiver of any provision of this section will be granted unless approved by the Department of Environmental Protection (MassDEP).

Minimum Wage Rates as determined by the Commissioner of Department of Workforce Development under the provision of the Massachusetts General Laws, Chapter 149, Sections 26 to 27D, as amended, apply to this project. It is the responsibility of the contractor, before bid opening, to request if necessary, any additional information on Minimum Wage Rates for those trades people who may be employed for the proposed work under this contract. Federal Minimum Wage Rates as determined by the United States Department of Labor under the Davis-Bacon Act also apply to this project.

Veolia reserves the right to waive any informality in or to reject any or all Bids if deemed to be in its best interest.

The selection of Contractors for Bid Package #1 shall be EITHER:

1. The base bid for Bid Package #1

OR

2. Bid for Bid Package #1 with Additive Alternative #1

All questions shall be directed in writing via e-mail to Veolia: Attn: Carl Hendrickson, [carl.hendrickson@veolia.com](mailto:carl.hendrickson@veolia.com).

## SECTION 00200

### INSTRUCTIONS TO BIDDERS

#### ARTICLE 1. INVESTIGATION OF BIDDERS

1.1 The investigation of a Bidder will seek to determine whether available equipment and financial resources are adequate to assure Veolia that the Goods and Services will be delivered in accordance with the terms of the Agreement.

1.2 In evaluating Bids, Veolia will consider the qualifications of only those Bidders whose Bids are in compliance with the prescribed requirements.

1.3 Veolia reserves the right to reject any Bid if the evidence submitted by, or the investigation of, such Bidder fails to satisfy Veolia that such Bidder is properly qualified to carry out the obligations of the Procurement Documents and to complete the Goods and Services contemplated therein.

#### ARTICLE 2. COPIES OF PROCUREMENT DOCUMENTS

2.1 Complete sets of Procurement Documents shall be used in preparing Bids; neither Veolia nor Engineer assume any responsibility for errors or misinterpretations resulting from the use of incomplete sets of Procurement Documents.

2.2 Veolia and Engineer in making copies of Procurement Documents available do so only for the purpose of obtaining Bids on the Work and do not confer a license or grant for any other use.

#### ARTICLE 3. EXAMINATION OF PROCUREMENT DOCUMENTS

3.1 Before submitting a Bid, each Bidder must (a) examine the Procurement Documents thoroughly, (b) become familiar with Federal, State and local laws, ordinances, rules and regulations that may in any manner affect cost, progress or performance of the Work; and (c) study and carefully correlate Bidder's observations with the requirements of the Procurement Documents.

3.2 The submission of a Bid will constitute an incontrovertible representation that the Bidder has complied with every requirement of this Article 3 and that the Procurement Documents are sufficient in scope and detail to indicate and convey understanding of all terms and conditions for providing the Goods and Services.

#### ARTICLE 4. INTERPRETATIONS

4.1 All questions about the meaning or intent of the Procurement Documents shall be received **via e-mail** by Veolia, Attn: Mr. Carl Hendrickson, e: carl.hendrickson@veolia.com, m: 617-999-8716 at least ten calendar days before the date herein set for the opening of bids.

4.2 Written clarifications or interpretations will be issued by Addenda not later than five days before the bid opening date. Only questions answered by formal written Addenda will be binding. Oral and other clarifications or interpretations will be without legal effect. Addenda will be e-mailed to all parties recorded as having received the Procurement Documents.

4.3 All questions received from bidding Contractors shall be received as follows in an editable Excel format:

**Number / Date / Drawing Reference / Specification Reference / Question / Answer**

4.4 Bidders are responsible for determining that they have received all Addenda issued.

## ARTICLE 5. PRE-BID CONFERENCE

5.1 A pre-bid conference will not be scheduled. Subcontractors can schedule site visits by contacting Carl Hendrickson at 617-999-8716. Veolia will transmit to all prospective Bidders of record such Addenda as Veolia considers necessary in response to questions. Oral statements may not be relied upon and will not be binding or legally effective.

## ARTICLE 6. BID FORM

6.1 Each Bid shall be submitted on the Bid Form on the pages appended to the Procurement Documents. One such copy of the Bid Form shall be removed and submitted separately. All blank spaces must be filled in.

6.2 Bid Forms shall be completed in ink or by typewriter. The Bid price of each item on the form shall be stated in words, and figures. Discrepancies between words and figures will be resolved in favor of words. Discrepancies between the indicated sum of any column of figures and the correct sum thereof will be resolved in favor of the correct sum.

6.3 Firm bids are required. Conditional bids will not be considered.

6.4 Bids by corporations shall be executed in the corporate name by the president or a vice-president (or other corporate officer accompanied by evidence of authority to sign) and the corporate seal shall be affixed and attested by the secretary or an assistant secretary. The corporate address and state of incorporation shall be shown below the signature.

6.5 Bids by Limited Liability Companies shall be executed in the Limited Liability name by the Manager (or other Limited Liability Company officer/representative accompanied by evidence of authority to sign.) The Limited Liability Company address and state where the Limited Liability Company was formed shall be shown below the signature.

6.6 Bids by partnerships shall be executed in the partnership name and signed by a partner, whose title shall appear under the signature. The official address of the partnership shall be shown below the signature.

6.7 All names shall be typed or printed below the signature.

6.8 The Bid shall contain an acknowledgement of receipt of all Addenda (the numbers of which shall be filled in on the Bid Form).

6.9 The address to which communications regarding the Bid are to be directed shall be shown.

6.10 One copy of each Bid shall be submitted via e-mail.

## ARTICLE 7. RECEIPT OF BIDS

7.1 Bids will be received at the time and place indicated in the Invitation to Bid.

7.2 Veolia may consider informal any Bid not prepared and submitted in accordance with the provisions hereof.

7.3 Bidders are cautioned that it is the responsibility of each individual bidder to assure that their bid is in the possession of the responsible official or the designated alternate prior to the stated time and at the place of the Bid Opening. Owner is not responsible for bids delayed by e-mail services, of any nature.

## ARTICLE 8. MODIFICATION AND WITHDRAWAL OF BIDS

8.1 Bids may be modified only by an appropriate document duly executed (in the manner that a Bid must be executed) and delivered to the place where Bids are to be submitted at any time prior to the opening of Bids.

8.2 Bids may be withdrawn prior to the scheduled time (or authorized postponement thereof) for the opening of Bids.

8.3 Any Bid received after the time and date specified shall not be considered. No Bid may be withdrawn for a period of thirty days, excluding Saturdays, Sundays, and legal holidays, after the actual date of the opening of the Bids.

#### ARTICLE 9. AWARD OF CONTRACT

9.1 The Contract will be awarded to the lowest responsible and eligible Bidder (Successful Bidder). Such a Bidder shall possess the skill, ability, and integrity necessary for the faithful performance of the work. The term "lowest responsible and eligible Bidder" as used herein shall mean the Bidder whose Bid is the lowest of those Bidders possessing the skill, ability, and integrity necessary to the faithful performance of the Work.

9.2 Veolia reserves the right to reject any and all Bids, to waive any and all informalities if it is in Veolia's best interest to do so, and the right to disregard all nonconforming, non-responsive or conditional Bids.

9.3 If the Contract is to be awarded, Veolia will give the Successful Bidder an agreement within sixty days, excluding Saturdays, Sundays, and legal holidays.

9.5 A Bid which includes for any item a Bid Price that is abnormally low or high may be rejected as unbalanced.

#### ARTICLE 10. SALES TAX

10.1 The goods and services to be provided under this Contract are exempt from the Sales and Use Taxes of the State of Massachusetts.

#### ARTICLE 11. COMMONWEALTH OF MASSACHUSETTS REQUIREMENTS

11.1 Applicable provisions of Massachusetts General Laws and Regulations and/or the United States Code and Code of Federal Regulations govern this Contract and any provision in violation of the foregoing shall be deemed null, void and of no effect. Where conflict between Code of Federal Regulations and State Laws and Regulations exist, the more stringent requirement shall apply. Note that the City of Taunton has special legislation for contracts associated with water and wastewater treatment facilities.

11.2 Minimum Wage Rates as determined by the Commissioner of Department of Workforce Development under the provision of the Massachusetts General Laws, Chapter 149, Sections 26 to 27D, as amended, apply to this project. It is the responsibility of the contractor, before bid opening, to request if necessary, any additional information on Minimum Wage Rates for those trades people who may be employed for the proposed work under this contract. Federal Minimum Wage Rates as determined by the United States Department of Labor under the Davis-Bacon Act also apply to this project. See Appendix G to the Agreement.

11.3 The contractor guarantees that the Work and Services to be performed under the Contract, and all workmanship, materials and equipment performed, furnished, used or installed in the construction of the same shall be free from defects and flaws, and shall be performed and furnished in strict accordance with the Drawings, Specifications, and other contract documents, that the strength of all parts of all manufactured equipment shall be adequate and as specified and that the performance test requirements of the Contract shall be fulfilled. This guarantee shall be for a period of one year from and after the date of completion and acceptance of the Work as stated in the final estimate. If part of the Work is accepted in accordance with that subsection of this AGREEMENT titled "Partial Acceptance", the guarantee for that part of the Work shall be for a period of one year from the date fixed for such acceptance.

If at any time within the said period of guarantee any part of the Work requires repairing, correction or replacement, the Owner may notify the contractor in writing to make the required repairs,

correction or replacements. If the Contractor neglects to commence making such repairs, corrections or replacements to the satisfaction of the Owner within seven (7) days from the date of receipt of such notice, or having commenced fails to prosecute such Work with diligence, the Owner may employ other persons to make said repairs, correction or replacements, and charge the costs, including compensation for additional professional services, to the Contractor."

11.4 This project is subject to the Safety and Health Regulations of the U.S. Department of Labor set forth in Title 29 CFR, Part 1926 and to all subsequent amendments, and to any applicable Massachusetts regulations. Contractors shall be familiar with the requirements of these regulations.

11.5 This project is subject to the requirements of the Department of Environmental Protection's Diesel Retrofit Program. Bidders must submit a signed and dated Statement of Intent to Comply form as part of their bid proposal documents.

11.6 This project is subject to the American Iron and Steel requirements of P.L. 113-76, the Consolidated Appropriations Act of 2014. See Appendix I to the Agreement.

11.7 Whenever it is written that an equipment manufacturer must have a specified period of experience with his product, equipment which does not meet the specified experience period can be considered if the equipment supplier or manufacturer is willing to provide an "Efficiency Guarantee Bond" or cash deposit for the duration of the specified time period which will guarantee replacement of that equipment in the event of failure.

**SECTION 00300**

**BID FORM**

THIS BID IS SUBMITTED TO: Veolia Water North America - Northeast, LLC

PROJECT IDENTIFICATION: City of Taunton, MA  
Wastewater Treatment Facility  
Phase 2 Improvements – Bid Package #1  
Contract S-2022-1, CWSRF 6760

- A. The undersigned declares that the only persons or parties interested in this Bid as principals are as stated; that the Bid is made without any collusion with other persons, firms, or corporations; that all the Procurement Documents as prepared by Veolia Water North America - Northeast, LLC, 53 State Street, 14th Floor, Boston, MA, 02109 and dated DATE have been carefully examined; that the undersigned is fully informed in regard to all conditions pertaining to the work and the place where it is to be delivered, and from them the undersigned makes this Bid. These prices shall cover all expenses incurred in providing the Goods and Services required under the Procurement Documents, of which this Bid Form is a part.
- B. The time period for holding bids, where Federal approval is not required is 30 days, Saturdays, Sundays and legal holidays excluded, after the opening of bids and where Federal approval is required, the time period for holding bids is 30 days, Saturdays, Sundays and holidays excluded after Federal approval.
- C. If unsigned copies of the Construction Agreement are delivered to the undersigned within sixty days, excluding Saturdays, Sundays, and legal holidays, after the actual date of the opening of the Bids, the undersigned will within three days, excluding Saturdays, Sundays, and legal holidays, after the date of receipt of such notification, execute and return all copies of the Construction Agreement to Veolia.
- D. The undersigned hereby agrees to fully complete the Phase 2 Improvements in accordance with the terms stated in the Agreement.
- E. The undersigned acknowledges receipt of addenda:  
  
Addendum No. \_\_\_\_\_, dated \_\_\_\_\_  
  
Addendum No. \_\_\_\_\_, dated \_\_\_\_\_  
  
Addendum No. \_\_\_\_\_, dated \_\_\_\_\_
- F. The undersigned agrees that, if they are selected as Contractor, they will within five days, Saturdays, Sundays and legal holidays excluded, after presentation thereof by the Company (Veolia), execute a contract in accordance with the terms of this bid and furnish a performance bond in the amount of 100% of the total contract price and also a labor and materials or payment bond in the amount of 100% of the total contract price, each of a surety company qualified to do business under the laws of the Commonwealth and satisfactory to the Company and each in the sum of the contract price, the premiums for which are to be paid by the Contractor and are included in the contract price.
- G. The Subcontractor shall complete all work required under the Contract within 548 days of the issuance of a Notice to Proceed. Work performed beyond the completion date will be subjected to liquidated damages in the amount specified herein.
- H. Liquidated damages specified in this contract are \$1,000 per day for each calendar day beyond the contract completion date that work remains uncompleted.
- I. Pursuant to M.G.L.c.62C, s49A I certify under the penalties of perjury that I, to my best knowledge and belief, have filed all state tax returns and paid all State Taxes required under law.
- J. The undersigned bidder hereby certifies he/she will comply with the specific affirmative action steps contained in the EEO/AA provisions of this Contract, including compliance with the Disadvantaged Business Enterprise provisions as required under these contract provisions. The contractor receiving the award of the contract shall incorporate the EEO/AA provisions of this contract into all

subcontracts and purchase orders so that such provisions will be binding upon each subcontractor or vendor.

- K. The undersigned further certifies under penalty of perjury that the said undersigned is not presently debarred from doing public construction work in the Commonwealth under the provisions of Section Twenty-Nine F of Chapter Twenty-Nine, or any other applicable debarment provisions of any other Chapter of the General Laws or any rule or regulation promulgated thereunder; and is not presently debarred, suspended, proposed for debarment, declared ineligible, or voluntarily excluded from covered transactions by any Federal department or agency.
- L. Bidders must fully comply with Subpart C of 2 CFR Part 180 and 2 CFR Part 1532, entitled responsibilities of Participants Regarding transactions (Doing Business with Other Persons). Contractors, subcontractors, or suppliers that appear on the Excluded Parties List System at [www.usgovxml.com/dataservice.aspx?ds=EPLS](http://www.usgovxml.com/dataservice.aspx?ds=EPLS) are not eligible for award of any contracts funded by the Massachusetts State Revolving Fund.
- M. Bidders must fully comply with the Diesel Retrofit Program. See Appendix B to the Agreement.
- N. In accordance with the above understanding, the undersigned proposes to furnish all Goods and Services, and complete the Work in its entirety in the manner and under the conditions required at the prices listed as follows:

<u>Item Number</u>	<u>Estimated Quantity</u>	<u>Brief Description: unit or lump-sum price bid in both words and figures.</u>	<u>Total in Figures</u>
1	1 LS	Phase 2 Improvements, all work excluding Additive Alternative #1, Bid Package 2 (Instrumentation and Control), Bid Package 3 (Secondary Sludge Pumps procurement), and bid items 2-5	_____ dollars and _____ cents (\$ _____) \$ _____
1A	1 LS	ADDITIVE ALTERNATIVE #1 – Rehabilitation and equipment replacement for all final clarifiers	_____ dollars and _____ cents (\$ _____) \$ _____
2	250 LF	Crack Repair of Existing Concrete Tanks and structures, per linear foot,	_____ dollars and _____ cents (\$ _____) \$ _____
3	850 SF	Concrete Spalling Repair of Existing Concrete Tanks, and structures, per square foot,	_____ dollars and _____ cents (\$ _____) \$ _____
4	85,000 SF	Concrete Protective Coating of Existing Concrete Tanks, and structures, per square foot,	_____ dollars and _____ cents (\$ _____) \$ _____

5                    500                    Residual Solids, Grit and Debris Removal and Disposal  
CY                    per cubic yard,  
  
\_\_\_\_\_ dollars  
and \_\_\_\_\_ cents (\$ \_\_\_\_\_) \$ \_\_\_\_\_

**TOTAL OF TAUNTON WWTF PHASE 2 IMPROVEMENTS BID PACKAGE #1 BASE  
BID:**

**In Figures: \$** \_\_\_\_\_

**In Words:** \_\_\_\_\_

\_\_\_\_\_

\_\_\_\_\_ **Dollars**

and \_\_\_\_\_ **Cents**

---

**TOTAL OF TAUNTON WWTF PHASE 2 IMPROVEMENTS BID PACKAGE #1 WITH  
ADDITIVE ALTERNATIVE #1:**

**In Figures: \$** \_\_\_\_\_

**In Words:** \_\_\_\_\_

\_\_\_\_\_

\_\_\_\_\_ **Dollars**

and \_\_\_\_\_ **Cents**



Amounts shall be shown in both words and figures, where indicated. In case of discrepancy, the amount shown in words will govern.

The above prices shall include all labor, materials, delivery, overhead, profit, insurance, and incidentals required to complete the Work.

- O. The names and residences of all persons and parties interested in the foregoing Bid as principals are as follows:

(Give first and last names in full.)

---

---

---

---

---

---

---

---

- P. Notice of acceptance should be e-mailed or delivered to the undersigned Bidder at the following address:

\_\_\_\_\_  
(Name of Bidder)

\_\_\_\_\_  
(Title)

\_\_\_\_\_  
(Business Address)

\_\_\_\_\_  
(City and State)

\_\_\_\_\_  
Date

Note: If the Bidder is a corporation, indicate State of incorporation under signature, and affix corporate seal; if a limited liability company, indicate State of formation under signature; if a partnership, give full names and residential addresses, if different from business address.

STATEMENT OF INTENT TO COMPLY

*This form must be signed and submitted by the bidder as part of the bid.*

*Local Governmental Unit*      City of Taunton, MA      *SRF Project No.*      6760

*Contract No.*      S-2022-1      *Contact Title*      WWTF Phase 2 Improvements

*Bidder*

---

*The undersigned, on behalf of the above-named Bidder, agrees that, if awarded the Contract:*

- 1. the Bidder shall comply with the Department of Environmental Protection's ("DEP") Diesel Retrofit Program by ensuring that all diesel powered non-road construction equipment and vehicles greater than 50 brake horsepower which will be used in the performance of the work under the Contract are equipped or retrofitted with a pollution control device in accordance with the Diesel Retrofit Program Standard;*
- 2. the Bidder shall require all Subcontractors to comply with MassDEP's Diesel Retrofit Program by ensuring all diesel powered non-road construction equipment and vehicles greater than 50 brake horsepower which will be used in the performance of the work under the Contract are equipped or retrofitted with a pollution control device in accordance with the Diesel Retrofit Program Standard; and*
- 3. The Bidder shall submit and shall require each Subcontractor to submit a Diesel Retrofit Program Contractor Certification (form attached) with a Diesel Retrofit List to DEP (NAME and ADDRESS) and the Bidder within 10 days of the bidder being notified that it has been awarded the Contract. The Bidder shall require each Subcontractor to update such Certification and List within 2 days of using additional Diesel Construction Equipment on the project under the Contract.*

---

*(Signature of Bidder's Authorized Representative)*

*(Date)*

## BIDDER CERTIFICATIONS

Pursuant to M.G.L. Ch. 62C, s49A, I certify under the penalties of perjury that I, to my best knowledge and belief, have filed all state tax returns and paid all State Taxes Required under law.

The undersigned hereby certifies that he is able to furnish labor that can work in harmony with all other elements of labor employed or to be employed in the work.

The undersigned bidder hereby certifies he/she will comply with the specific affirmative action steps contained in the Equal Employment Opportunity/Affirmative Action (EEO/AA) provisions of this Contract, including compliance with the Disadvantaged Business Enterprise provisions as required under these contract provisions. The contractor receiving the award of the contract shall incorporate the EEO/AA provisions of this contract into all subcontracts and purchase orders so that such provisions will be binding upon each subcontractor or vendor.

The undersigned certifies under penalties of perjury that this bid is in all respects bonafide, fair and made without collusion or fraud with any other person. As use in this paragraph the "person" shall mean any natural person, joint venture, partnership, corporation or other business or legal entity.

The undersigned further certifies under penalty of perjury that the said undersigned is not presently debarred from doing public construction work in the Commonwealth of Massachusetts under the provisions of Section Twenty-Nine F of Chapter Twenty-Nine, or any other applicable debarment provisions of any other Chapter of the General Laws or any rule or regulations promulgated thereunder; and is not presently debarred, suspended, proposed for debarment, declared ineligible, or voluntarily excluded from covered transactions by any Federal department or agency.

\_\_\_\_\_  
(Date)

\_\_\_\_\_  
(Name of General Bidder)

\_\_\_\_\_  
(Federal Employer Identification No.)

By: \_\_\_\_\_

(Signature)

\_\_\_\_\_  
(Title & Name of person signing bid)

\_\_\_\_\_  
(Business Address)

\_\_\_\_\_  
(City, State, Zip)

**SECTION 00500**  
**CONSTRUCTION AGREEMENT**

**Between**

**Veolia Water North America - Northeast, LLC**

**and**

**Subcontractor**

**Located in: Taunton, MA**

**Project: City of Taunton Wastewater Treatment Facility  
Phase 2 Improvements – Bid Package #1  
Contract S-2022-1  
CWSRF 6760**

**Date:**

## CONSTRUCTION AGREEMENT

THIS CONSTRUCTION AGREEMENT ("Agreement") is made and entered into as of ..... 2022 ("Effective Date") by and between Veolia Water North America - Northeast, LLC, a Delaware corporation (hereinafter "Company") whose address is 53 State Street, 14th Floor, Boston, MA 02127, and Subcontractor (hereinafter "Subcontractor"), whose address is Street, City (Town), State ZIP, (each a "Party" and collectively the "Parties"),

**WHEREAS**, in consideration of the mutual promises herein contained, Company and Subcontractor agree, promise, and obligate themselves as follows:

1. Subcontractor promises to provide the services described in Exhibit A, Scope of Work, (hereinafter the "Work") in accordance with the Agreement. The Work is provided to support Company's obligations to Taunton, MA (hereinafter "Client") in conjunction with Company's performance at the City of Taunton Wastewater Treatment Facility, Phase 2 Improvements (hereinafter the "Project") and its agreement with the Client (the "Prime Contract").
2. Company promises to pay Subcontractor for full, accurate, and timely performance of the Work and compensation as provided in Exhibit C and as set forth below in the Contract Documents.
3. This Agreement constitutes the entire understanding between the Parties, and cancels and supersedes all prior negotiations, representations, understandings and agreements, except that the indemnification obligations contained in any prior agreements shall survive the execution of this Agreement and consists of a) this Agreement; and b) its Exhibits (collectively referred to as "Contract Documents") incorporated and referenced as follows:
  - Notice of Award
  - Addenda \_\_\_\_\_ to \_\_\_\_\_
  - Bid Form
  - Exhibit A - Scope of Work (Note: Drawings and Specifications have been provided by Company and are not attached to this Agreement.)
  - Exhibit B - General Terms and Conditions
  - Exhibit C - Compensation
    - Exhibit C.1 - Interim Waiver and Release of Liens and Claims upon Payment
    - Exhibit C.2 - Unconditional Final Waiver and Release of Liens
  - Exhibit D - Insurance Requirements
  - Exhibit E - Insurance Supplement
  - Exhibit F - Additional / Special Terms - Illustrative Schedule
  - Exhibit G - Terms and Conditions for Hazardous or Contaminated Non-Hazardous Waste
  - Exhibit H - IT Security Requirements
  - Exhibit I - Anti-Corruption Compliance
  - Exhibit J - Bonding / Letters of Credit requirements

In the event of an inconsistency between provisions of the Agreement, the inconsistency shall be resolved by giving precedence as follows: 1) this Agreement, 2) Exhibit F Additional/Special Terms, 3) Exhibit B General Terms and Conditions, 4) Exhibit A Scope of Work, and 5) any remaining Contract Documents.

4. The Effective Date set forth above is the date as to which all Contract Documents have reference for purposes of coordination of their meaning and effect. Any work commenced and any payments made pursuant to an award or letter of intent prior to the execution date hereof shall be deemed to have been done and paid after the Effective Date and governed by the terms of this Agreement.

IN WITNESS WHEREOF, the Parties hereto have caused this Agreement to be signed by their respective authorized representatives, effective as of the date indicated above.

<b>Veolia Water North America - Northeast, LLC:</b>	<b>Subcontractor:</b>
By:	By:
Title:	Title:
Typed Name:	Typed Name:
Date:	Date:

**EXHIBIT A**  
**SCOPE OF WORK**

**1 DESCRIPTION**

Except as otherwise expressly provided herein, Subcontractor shall provide all labor, supervision, material, supplies, equipment, inspections, and any other incidentals required to perform the Work as described in this Scope of Work for the Project. The Work is generally described as follows:

**City of Taunton Wastewater Treatment Facility  
Phase 2 Improvements – Bid Package #1  
Contract S-2022-1, CWSRF 6760**

**2 PERFORMANCE PERIOD / SCHEDULE**

Time is of the essence in the performance of this Work. Subcontractor shall make whatever adjustments in working hours, manpower, equipment, etc. deemed necessary to complete the Work in accordance with the terms of the Agreement and the specific schedule requirements hereof.

The time of completion of this contract is 548 calendar days. The Subcontractor shall prepare a Project schedule.

Liquidated damages specified in this contract are \$1,000 per day for each calendar day beyond the contract completion date that work remains uncompleted.

**3 REPORTING REQUIREMENTS**

The Subcontractor shall prepare daily reports and a monthly progress report providing significant progress completed that month summarized in bullet points and also providing percent of project complete.

**4 DATA REQUIREMENTS**

INTENTIONALLY LEFT BLANK

**5 SPECIAL EQUIPMENT WARRANTIES**

Subcontractor warrants that the goods and equipment ("Equipment") shall be free from liens and defects in title, design, material, workmanship, and performance, and shall conform and perform in all respects to the terms of this Order, the specifications and applicable drawings and shall be new and of the best quality. If, any time prior to the earlier of one (1) year from the date of actual productive use of the Equipment or from completion of performance of the services, it appears the Equipment or services do not conform to these warranties or the specifications, and Company so notifies the Subcontractor, Subcontractor shall promptly correct such nonconformity and take all other action to remedy the results of any defect or nonconformity to the satisfaction of the Company, at Subcontractor's sole expense, failing which Company may reject or revoke acceptance and cover, or Company may perform Subcontractor's work and correct such defects at Subcontractor's expense. These rights shall survive acceptance and the warranty shall inure to the benefit of and be enforceable by Company and its customer.

**6 COMPANY FURNISHED ITEMS**

With respect to the Company Furnished Products identified below, Subcontractor shall fulfill the described responsibilities:

- Bid Package #2 – Instrumentation and Control
- Bid Package #3 – Secondary Sludge Pumps Procurement

Subcontractor's Responsibilities:

Review Company provided shop drawings.  
Inspect for completeness or damage, jointly with Company.  
Handle, store, install and finish products.  
Repair or replace products/items damaged after receipt.  
Arrange for manufacturer's inspections, service, start-up services and training.

## 7 WORKING HOURS

The Work to be performed is located at 825 West Water Street, Taunton, MA ("Project Site") and the working hours are 7:00 A.M. to 3:30 P.M. Monday through Friday. Subcontractor shall coordinate with designated Veolia staff for deviations to this requirement.

## 8 COMMONWEALTH OF MASSACHUSETTS PROVISIONS

- A. Note that the City of Taunton has special legislation for contracts associated with wastewater treatment facilities. This legislation amends the MGL.
- B. The Contractor agrees that it will fully comply with Subpart C of 2 CFR Part 180 and 2 CFR Part 1532, entitled Responsibilities of Participants Regarding Transactions (Doing Business with Other Persons). The Contractor shall not award any subcontracts or purchase any materials from suppliers that appear on the Excluded Parties List System. The Contractor shall include this requirement in each subcontract and require it to be included in all subcontracts regardless of tier. The Contractor shall maintain reasonable records to demonstrate compliance with these requirements.
- C. The fair share goals for disadvantaged business enterprise (DBE) participation for this contract are a minimum of 5.7% percent Disadvantaged Minority Business Enterprise (D/MBE) participation and 6.1% percent Disadvantaged Women Business Enterprise (D/WBE) participation, applicable to the total dollar amount paid for the construction contract. The Contractor shall take all affirmative steps necessary to achieve this goal, and shall provide reports documenting the portion of contract and subcontract dollars paid to DBEs, and its efforts to achieve the goals, with each invoice submitted or at such greater intervals as specified by the (municipality). The contractor shall require similar reports from its subcontractors.
- D. During the performance of this contract, the contractor agrees as follows:
  - a. The contractor will not discriminate against any employee or applicant for employment because of race, color, religion, sex, or national origin. The contractor will take affirmative action to ensure that applicants are employed, and that employees are treated during employment, without regard to their race, color, religion, sex or national origin. Such action shall include, but not be limited to the following: employment, upgrading, demotion, or transfer; recruitment or recruitment advertising; layoff or termination; rates of pay or other forms of compensation; and selection for training, including apprenticeship. The contractor agrees to post in conspicuous places, available to employees and applicants for employment, notices to be provided by the contracting officer setting forth the provisions of this nondiscrimination clause.
  - b. The contractor will, in all solicitations or advancements for employees placed by or on behalf of the contractor, state that all qualified applicants will receive consideration for employment without regard to race, color, religion, sex or national origin.
  - c. The contractor will send to each labor union or representative of workers with which he has a collective bargaining agreement or other contract or understanding, a notice, to be provided by the agency contracting officer, advising the labor union or workers' representative of the contractor's commitments under Section 202 of Executive Order No. 11246 of September 24, 1965, and shall post copies of the notice in conspicuous places available to employees and applicants for employment.
  - d. The contractor will comply with all provisions of Executive Order No. 11246 of Sept. 24, 1965, and of the rules, regulations, and relevant orders of the Secretary of Labor.
  - e. The contractor will furnish all information and reports required by Executive Order No. 11246 of September 24, 1965, and by the rules, regulations, and orders of the Secretary of Labor, or pursuant thereto, and will permit access to his books, records, and accounts by the contracting agency and the Secretary of Labor for purposes of investigation to ascertain compliance with such rules, regulations, and orders. Comp., p. 684, EO 12086 of Oct. 5, 1978, 43 FR 46501, 3 CFR, 1978 Comp., p. 230

- f. In the event of the contractor's noncompliance with the nondiscrimination clauses of this contract or with any of such rules, regulations, or orders, this contract may be cancelled, terminated, or suspended in whole or in part and the contractor may be declared ineligible for further Government contracts in accordance with procedures authorized in Executive Order No. 11246 of Sept. 24, 1965, and such other sanctions may be imposed and remedies invoked as provided in Executive Order No. 11246 of September 24, 1965, or by rule, regulation, or order of the Secretary of Labor, or as otherwise provided by law.
- g. The contractor will include the provisions of paragraphs (1) through (7) in every subcontract or purchase order unless exempted by rules, regulations, or orders of the Secretary of Labor issued pursuant to Section 204 of Executive Order No. 11246 of September 24, 1965, so that such provisions will be binding upon each subcontractor or vendor. The contractor will take such action with respect to any subcontract or purchase order as may be directed by the Secretary of Labor as a means of enforcing such provisions including sanctions for noncompliance: Provided, however, that in the event the contractor becomes involved in, or is threatened with, litigation with a subcontractor or vendor as a result of such direction, the contractor may request the United States to enter into such litigation to protect the interests of the United States." [Sec. 202 amended by EO 11375 of Oct. 13, 1967, 32 FR 14303, 3 CFR, 1966-1970
- E. The contractor shall not participate in or cooperate with an international boycott, as defined in Section 999 (b)(3) and (4) of the Internal Revenue code 1986, as amended, or engage in conduct declared to be unlawful by Section 2 of Chapter 151E of the Massachusetts General Laws.
- F. Pursuant to M.G.L. c.44, s31C, I certify that an appropriation has been made in the total amount of the contract.
- G. The Contractor acknowledges to and for the benefit of the City of Taunton and the Commonwealth of Massachusetts (the "State") that it understands the goods and services under this Agreement are being funded with monies made available by the Clean Water State Revolving Fund and/or Drinking Water State Revolving Fund that have statutory requirements commonly known as "American Iron and Steel;" that requires all of the iron and steel products used in the project to be produced in the United States ("American Iron and Steel Requirement") including iron and steel products provided by the Contractor pursuant to this Agreement. The Contractor hereby represents and warrants to and for the benefit of the Purchaser and the State that (a)the Contractor has reviewed and understands the American Iron and Steel Requirement, (b) all of the iron and steel products used in the project will be and/or have been produced in the United States in a manner that complies with the American Iron and Steel Requirement, unless a waiver of the requirement is approved, and (c) the Contractor will provide any further verified information, certification or assurance of compliance with this paragraph, or information necessary to support a waiver of the American Iron and Steel Requirement, as may be requested by the Purchaser or the State. Notwithstanding any other provision of this Agreement, any failure to comply with this paragraph by the Contractor shall permit the Purchaser or State to recover as damages against the Contractor any loss, expense, or cost (including without limitation attorney's fees)incurred by the Purchaser or State resulting from any such failure (including without limitation any impairment or loss of funding, whether in whole or in part, from the State or any damages owed to the State by the Purchaser). While the Contractor has no direct contractual privity with the State, as a lender to the Purchaser for the funding of its project, the Purchaser and the Contractor agree that the State is a third-party beneficiary and neither this paragraph (nor any other provision of this Agreement necessary to give this paragraph force or effect) shall be amended or waived without the prior written consent of the State.
- H. All construction contracts are subject to the Davis Bacon wage rate requirements and must include the provisions found in Appendix G in the contract. The Davis Bacon Act Requirements are included.
- I. The Contractor agrees that it will fully comply with Subpart C of 2 CFR Part 180 and 2 CFR Part 1532, entitled Responsibilities of Participants Regarding Transactions (Doing Business with Other Persons). The Contractor shall not award any subcontracts or purchase any materials from suppliers that appear on the Excluded Parties List System. The Contractor shall include this requirement in each subcontract and require it to be included in all subcontracts regardless of tier. The Contractor shall maintain reasonable records to demonstrate compliance with these requirements.
- J. M.G.L statutes:
  - c.30 s 39F Payment to Subcontractor
  - c.30 s 39I Deviation from Plans and Specifications
  - c.30 s 39J No Arbitrary Decisions are Final
  - c.30 s 39L Construction Work by Foreign Corporations
  - c.30 s 39N Differing Site Conditions



c.30 s 39O Equitable Adjustments for Delays  
c.30 s 39P Decision on Interpretation of Specifications  
c.30 s 39R Contractor's Records  
c.149 s 34 Limitations on Hours of Work  
c.82 s 40 Excavations; Notice; Penalties

Section 39F.

- a. Every contract awarded pursuant to sections forty-four A to L, inclusive, of chapter one hundred and forty-nine shall contain the following subparagraphs (a) through (i) and every contract awarded pursuant to section thirty-nine M of chapter thirty shall contain the following subparagraphs (a) through (h) and in each case those subparagraphs shall be binding between the general contractor and each subcontractor.
  - a. Forthwith after the general contractor receives payment on account of a periodic estimate, the general contractor shall pay to each subcontractor the amount paid for the labor performed and the materials furnished by that subcontractor, less any amount specified in any court proceedings barring such payment and also less any amount claimed due from the subcontractor by the general contractor.
  - b. Not later than the sixty-fifth day after each subcontractor substantially completes his work in accordance with the plans and specifications, the entire balance due under the subcontract less amounts retained by the awarding authority as the estimated cost of completing the incomplete and unsatisfactory items of work, shall be due the subcontractor; and the awarding authority shall pay that amount to the general contractor. The general contractor shall forthwith pay to the subcontractor the full amount received from the awarding authority less any amount specified in any court proceedings barring such payment and also less any amount claimed due from the subcontractor by the general contractor.
  - c. Each payment made by the awarding authority to the general contractor pursuant to subparagraphs (a) and (b) of this paragraph for the labor performed and the materials furnished by a subcontractor shall be made to the general contractor for the account of that subcontractor; and the awarding authority shall take reasonable steps to compel the general contractor to make each such payment to each such subcontractor. If the awarding authority has received a demand for direct payment from a subcontractor for any amount which has already been included in a payment to the general contractor or which is to be included in a payment to the general contractor for payment to the subcontractor as provided in subparagraphs (a) and (b), the awarding authority shall act upon the demand as provided in this section.
  - d. If, within seventy days after the subcontractor has substantially completed the subcontract work, the subcontractor has not received from the general contractor the balance due under the subcontract including any amount due for extra labor and materials furnished to the general contractor, less any amount retained by the awarding authority as the estimated cost of completing the incomplete and unsatisfactory items of work, the subcontractor may demand direct payment of that balance from the awarding authority. The demand shall be by a sworn statement delivered to or sent by certified mail to the awarding authority, and a copy shall be delivered to or sent by certified mail to the general contractor at the same time. The demand shall contain a detailed breakdown of the balance due under the subcontract and also a statement of the status of completion of the subcontract work. Any demand made after substantial completion of the subcontract work shall be valid even if delivered or mailed prior to the seventieth day after the subcontractor has substantially completed the subcontract work. Within ten days after the subcontractor has delivered or so mailed the demand to the awarding authority and delivered or so mailed a copy to the general contractor, the general contractor may reply to the demand. The reply shall be by a sworn statement delivered to or sent by certified mail to the awarding authority and a copy shall be delivered to or sent by certified mail to the subcontractor at the same time. The reply shall contain a detailed breakdown of the balance due under the subcontract including any amount due for extra labor and materials furnished to the general contractor and of the amount due for each claim made by the general contractor against the subcontractor.

- e. Within fifteen days after receipt of the demand by the awarding authority, but in no event prior to the seventieth day after substantial completion of the subcontract work, the awarding authority shall make direct payment to the subcontractor of the balance due under the subcontract including any amount due for extra labor and materials furnished to the general contractor, less any amount (i) retained by the awarding authority as the estimated cost of completing the incomplete or unsatisfactory items of work, (ii) specified in any court proceedings barring such payment, or (iii) disputed by the general contractor in the sworn reply; provided, that the awarding authority shall not deduct from a direct payment any amount as provided in part (iii) if the reply is not sworn to, or for which the sworn reply does not contain the detailed breakdown required by subparagraph (d). The awarding authority shall make further direct payments to the subcontractor forthwith after the removal of the basis for deductions from direct payments made as provided in parts (i) and (ii) of this subparagraph.
  - f. The awarding authority shall forthwith deposit the amount deducted from a direct payment as provided in part (iii) of subparagraph (e) in an interest-bearing joint account in the names of the general contractor and the subcontractor in a bank in Massachusetts selected by the awarding authority or agreed upon by the general contractor and the subcontractor and shall notify the general contractor and the subcontractor of the date of the deposit and the bank receiving the deposit. The bank shall pay the amount in the account, including accrued interest, as provided in an agreement between the general contractor and the subcontractor or as determined by decree of a court of competent jurisdiction.
  - g. All direct payments and all deductions from demands for direct payments deposited in an interest-bearing account or accounts in a bank pursuant to subparagraph (f) shall be made out of amounts payable to the general contractor at the time of receipt of a demand for direct payment from a subcontractor and out of amounts which later become payable to the general contractor and in the order of receipt of such demands from subcontractors. All direct payments shall discharge the obligation of the awarding authority to the general contractor to the extent of such payment.
  - h. The awarding authority shall deduct from payments to a general contractor amounts which, together with the deposits in interest-bearing accounts pursuant to subparagraph (f), are sufficient to satisfy all unpaid balances of demands for direct payment received from subcontractors. All such amounts shall be earmarked for such direct payments, and the subcontractors shall have a right in such deductions prior to any claims against such amounts by creditors of the general contractor.
  - i. If the subcontractor does not receive payment as provided in subparagraph (a) or if the general contractor does not submit a periodic estimate for the value of the labor or materials performed or furnished by the subcontractor and the subcontractor does not receive payment for same when due less the deductions provided for in subparagraph (a), the subcontractor may demand direct payment by following the procedure in subparagraph (d) and the general contractor may file a sworn reply as provided in that same subparagraph. A demand made after the first day of the month following that for which the subcontractor performed or furnished the labor and materials for which the subcontractor seeks payment shall be valid even if delivered or mailed prior to the time payment was due on a periodic estimate from the general contractor. Thereafter the awarding authority shall proceed as provided in subparagraph (e), (f), (g) and (h).
- b. Any assignment by a subcontractor of the rights under this section to a surety company furnishing a bond under the provisions of section twenty-nine of chapter one hundred forty-nine shall be invalid. The assignment and subrogation rights of the surety to amounts included in a demand for direct payment which are in the possession of the awarding authority or which are on deposit pursuant to subparagraph (f) of paragraph (1) shall be subordinate to the rights of all subcontractors who are entitled to be paid under this section and who have not been paid in full.
  - c. "Subcontractor" as used in this section (i) for contracts awarded as provided in sections forty-four A to forty-four H, inclusive, of chapter one hundred forty-nine shall mean a person who files a sub-bid and receives a subcontract as a result of that filed sub-bid or who is approved by the awarding authority in writing as a person performing labor or both performing labor and furnishing materials pursuant to a contract with the general contractor, (ii) for contracts awarded as provided in paragraph (a) of section thirty-nine M of chapter thirty shall mean a

person approved by the awarding authority in writing as a person performing labor or both performing labor and furnishing materials pursuant to a contract with the general contractor, and (iii) for contracts with the commonwealth not awarded as provided in forty-four A to forty-four H, inclusive, of chapter one hundred forty-nine shall also mean a person contracting with the general contractor to supply materials used or employed in a public works project for a price in excess of five thousand dollars.

- d. A general contractor or a subcontractor shall enforce a claim to any portion of the amount of a demand for direct payment deposited as provided in subparagraph (f) of paragraph 1 by a petition in equity in the superior court against the other and the bank shall not be a necessary party. A subcontractor shall enforce a claim for direct payment or a right to require a deposit as provided in subparagraph (f) of paragraph 1 by a petition in equity in the superior court against the awarding authority and the general contractor shall not be a necessary party. Upon motion of any party the court shall advance for speedy trial any petition filed as provided in this paragraph. Sections fifty-nine and fifty-nine B of chapter two hundred thirty-one shall apply to such petitions. The court shall enter all interlocutory decree upon which execution shall issue for any part of a claim found due pursuant to sections fifty-nine and fifty-nine B and, upon motion of any party, shall advance for speedy trial the petition to collect the remainder of the claim. Any party aggrieved by such interlocutory decree shall have the right to appeal there from as from a final decree. The court shall not consolidate for trial the petition of any subcontractor with the petition of one or more subcontractors or the same general contract unless the court finds that a substantial portion of the evidence of the same events during the course of construction (other than the fact that the claims sought to be consolidated arise under the same general contract) is applicable to the petitions sought to be consolidated and that such consolidation will prevent unnecessary duplication of evidence. A decree in any such proceeding shall not include interest on the disputed amount deposited in excess of the interest carried for the period of any such deposit. No person except a subcontractor filing a demand for direct payment for which no funds due the general contractor are available for direct payment shall have a right to file a petition in court of equity against the awarding authority claiming a demand for direct payment is premature and such subcontractor must file the petition before the awarding authority has made a direct payment to the subcontractor and has made a deposit of the disputed portion as provided in part (iii) of subparagraph (e) and in subparagraph (f) of paragraph (1).
- e. In any petition to collect any claim for which a subcontractor has filed a demand for direct payment the court shall, upon motion of the general contractor, reduce by the amount of any deposit of a disputed amount by the awarding authority as provided in part (iii) of subparagraph (e) and in subparagraph (f) of paragraph (1) any amount held under a trustee writ or pursuant to a restraining order or injunction.

Section 39N. Every contract subject to section forty-four A of the chapter one hundred and forty-nine or subject to section thirty-nine M chapter thirty shall contain the following paragraph in its entirety and an awarding authority may adopt reasonable rules or regulations in conformity with that paragraph concerning, the filing investigation and settlement of such claims if, during the progress of the work, the contractor or the awarding authority discovers that the actual subsurface or latent physical conditions encountered at the site differ substantially or materially from those shown on the plans or indicated in the contract documents either the contractor or the contracting authority may request an equitable adjustment in the contract price of the contract applying to work affected by the differing site conditions. A request for such an adjustment shall be in writing and shall be delivered by the party making such claim to the other party as soon as possible after such conditions are discovered. Upon receipt of such a claim from a contractor, or upon its own initiative, the contracting authority shall make an investigation of such physical conditions, and, if they differ substantially or materially from those shown on the plans or indicated in the contract documents or from those ordinarily encountered and generally recognized as inherent in work of the character provided for in the plans and contract documents and are of such a nature as to cause an increase or decrease in the cost of performance of the work or a change in the construction methods required for the performance of the work which results in an increase or decrease in the cost of the work, the contracting authority shall make an equitable adjustment in the contract price and the contract shall be modified in writing accordingly.

Section 39O. Every contract subject to the provisions of section thirty-nine M of this chapter or subject to section forty-four A of chapter one hundred forty-nine shall contain the following provisions (a) and

(b) in their entirety and, in the event a suspension, delay, interruption or failure to act of the awarding authority increases the cost of performance to any subcontractor, that subcontractor shall have the same rights against the general contractor for payment for an increase in the cost of his performance as provisions (a) and (b) give the general contractor against the awarding authority, but nothing in provisions (a) and (b) shall in any way change, modify or alter any other rights which the general contractor or the subcontractor may have against each other.

- a. The awarding authority may order the general contractor in writing to suspend, delay, or interrupt all or any part of the work for such period of time as may determine to be appropriate for the convenience of the awarding authority; provided however, that if there is a suspension, delay or interruption for fifteen days or more or due to a failure of the awarding authority to act within the time specified in this contract, the awarding authority shall make an adjustment in the contract price for any increase in the cost of performance of this contract but shall not include any profit to the general contractor on such increase; and provided further, that the awarding authority shall not make any adjustment in the contract price under this provision for any suspension, delay, interruption or failure to act to the extent that such is due to any cause for which this contract provides for an equitable adjustment of the contract price under any other contract provisions.
- b. The general contractor must submit the amount of a claim under provision (a) to the awarding authority in writing as soon as practicable after the end of the suspension, delay, interruption or failure to act and, in any event, not later than the date of final payment under this contract and, except for costs due to a suspension order, the awarding authority shall not approve any costs in the claim incurred more than twenty days before the general contractor notified the awarding authority in writing of the act or failure to act involved in the claim.

K. Appendices:

1. Appendix A1 - Certification Statement
2. Appendix B - Diesel Retrofit Program
3. Appendix E - Disadvantaged Business Enterprises
4. Appendix F - DIVISION OF MUNICIPAL SERVICES POLICIES
5. Appendix G - Davis Bacon Act Requirements
6. Appendix I - American Iron and Steel Requirements

## 9 GENERAL REQUIREMENTS

A. Phase 2 Improvements:

Bid Package #1 – General

Bid Package #1 consists of all work not included in Packages #2-3, including:

- Retrofit of existing biological treatment tanks
- Construction of new biological treatment tanks
- Furnish and install blowers and associated equipment for biological treatment system
- **Installation** of secondary sludge pumping systems (RAS and WAS) (Procured under Package #3)
- Conversion of existing blower building to storage space
- Electrical work as shown in the contract documents - Electrical drawings and Specifications Division 16
- Install instrumentation and control panels furnished under Division 13 and Division 11
- **ADDITIVE ALTERNATIVE #1 - Rehabilitation and equipment replacement of final clarifiers (see Specification Section 01025 for definition)**

Bid Package #2 – Instrumentation and Control

- Furnish and program Instrumentation and control equipment as shown in the Contract Documents – Instrumentation drawings and Specifications Division 13

Bid Package #3 – Secondary Sludge Pumps Procurement

- Furnish vertical centrifugal pumps for secondary sludge pumping (RAS and WAS) as specified in Specification Section 11312.

all as more particularly indicated, shown or described in the Drawings, Specifications, and other Contract Documents.

- Safety Requirements:
  - The Subcontractor is to meet and review the Veolia safety plan for this facility prior to initiating work and shall submit a site-specific safety plan. The minimum PPE requirements are Steel toed boots, ANSI approved hard hats, and ANSI approved safety glasses.
  - Certain tasks may require additional personnel protective equipment - such as a respirator, hearing protection, fall protection, tyvek suits. Prior to performing these tasks - a job site safety analysis must be facilitated.

**CERTIFICATION STATEMENT**

Pursuant to M.G.L. c.44, s31C, I certify that an appropriation has been made in the total amount of the contract.

---

**City of Taunton, Massachusetts**  
**City Auditor**

Contract Approved As To Form:

---

**City of Taunton Massachusetts**  
**City Solicitor**

**DIESEL RETROFIT PROGRAM CONTRACTOR CERTIFICATION**

Each Contractor and its Subcontractor(s) must sign and email this form to the DEP DMS project engineer, within 10 days after the contractor is awarded.

Local Governmental Unit: **City of Taunton**

SRF Project No.: **6760**

Contract No.: **S-2022-1**

Contact Title: **WWTF Phase 2 Improvements**

Contractor: \_\_\_\_\_

I, \_\_\_\_\_, an authorized signatory for  
(Authorized Representative)

\_\_\_\_\_  
(Contractor)

whose principal place of business is at \_\_\_\_\_ do hereby certify that any and all diesel powered non-road construction equipment and vehicles greater than 50 brake horsepower which will be used in the performance of the work under the Contract (hereinafter "Diesel Construction Equipment") have pollution control devices, such as oxidation catalysts or particulate filters, installed on the exhaust system side of the diesel combustion engine equipment in accordance with the Diesel Retrofit Program Standard.

I am submitting on behalf of \_\_\_\_\_ a list of all said Diesel Construction Equipment, labeled "Diesel Retrofit List," that will be used in connection with this Contract by  
(Contractor)

\_\_\_\_\_. I hereby certify that the information on the attached Diesel Retrofit List is correct and accurate as of the date of signature. The List includes the following information for each piece of Diesel Construction Equipment:

1. Equipment type, make, model;
2. Vehicle Identification Number or VIN;
3. Engine model and year of manufacture;
4. Engine HP rating;
5. Emission Control Device ("ECD") type (Diesel Oxidation Catalyst or Diesel Particulate Filter);
6. ECD make, model, and manufacturer;
7. ECD EPA or CARB Verification Number or manufacturer's certification that the DOC or DPF meets or exceeds emission reductions provided by similar emission control technology verified by EPA or CARB;
8. ECD installation date;
9. Type of fuel to be used; and
10. Whether the equipment is owned or rented.

Contractor shall notify DEP within 48 hours of any new Diesel Construction Equipment brought onto the Contract site. Contractor shall maintain detailed records of all Diesel Construction Equipment used at the Contract site, including the dates and duration times the Diesel Construction Equipment is used at the Contract site. Contractor shall make such records available for inspection by DEP. Contractor shall ensure that the emissions control technology for each piece of Diesel Construction Equipment is operated, maintained, and serviced as recommended by the manufacturer. Contractor shall retrofit prior to the end of the Contract any Diesel Construction Equipment no longer exempt from meeting the Diesel Construction Equipment Standard under exemption 3 (because it had an engine that met the EPA particulate matter (PM) Tier emission standards currently in effect at the start of the Contract for non-road diesel engines for the applicable engine power group and such emissions standards were superseded during the Contract).

I acknowledge that this certificate is being furnished as a requirement under this Contract and is subject to applicable State and federal laws, both criminal and civil. Signed under pains and penalty of perjury on

this date \_\_\_\_\_.

Signature: \_\_\_\_\_

Printed Name: \_\_\_\_\_

Title: \_\_\_\_\_



DISADVANTAGED BUSINESS ENTERPRISE PARTICIPATION  
 MASSACHUSETTS DEPARTMENT OF ENVIRONMENTAL PROTECTION  
 DIVISION OF MUNICIPAL SERVICES

**STATE REVOLVING FUND LOAN PROGRAM – SCHEDULE OF SUBCONTRACTOR PARTICIPATION**

Local Governmental Unit \_\_\_\_\_  
 Project Name \_\_\_\_\_  
 SRF Identification Number \_\_\_\_\_  
 General Contractor \_\_\_\_\_  
 Contract Value \_\_\_\_\_

The United States Environmental Protection Agency (EPA) requires that all SRF borrowers develop and maintain a list of all MBE/WBE and non MBE/WBE subcontractors on the project.

This form must be completed and returned to MassDEP within 90 days of award of the contract.

Subcontractor	Point of Contact	Mailing Address	Telephone Number	E-Mail Address	MBE	WBE	DBE	Subcontract Value

DISADVANTAGED BUSINESS ENTERPRISE PARTICIPATION  
 MASSACHUSETTS DEPARTMENT OF ENVIRONMENTAL PROTECTION  
 DIVISION OF MUNICIPAL SERVICES

**SCHEDULE OF PARTICIPATION FOR SRF CONSTRUCTION**

**Project Title:** \_\_\_\_\_ **Project Location:** \_\_\_\_\_

**Disadvantaged Minority Business Enterprise Participation in the SRF Loan Work**

Name & Address of D/MBE	Nature of Participation	Dollar Value of Participation
1.		
2.		
3.		
<b>Total D/MBE Commitment:</b>		<b>\$</b>
<b>Percentage D/MBE Participation = (Total D/MBE Commitment) / (Bid Price) =</b>		<b>%</b>

**Disadvantaged Women Business Enterprise Participation in the SRF Loan Work**

Name & Address of D/WBE	Nature of Participation	Dollar Value of Participation
1.		
2.		
3.		
<b>Total D/WBE Commitment:</b>		<b>\$</b>
<b>Percentage D/WBE Participation = (Total D/WBE Commitment) / ( Bid Price) =</b>		<b>%</b>

The Bidder agrees to furnish implementation reports as required by MassDEP to indicate the D/MBEs and D/WBE(s) which it has used or intends to use. Breach of this commitment constitutes a breach of the contract.

Name of Bidder: \_\_\_\_\_

Date: \_\_\_\_\_ By: \_\_\_\_\_  
Signature

NOTE: Participation of a DBE may be counted in only their certified category; the same dollar participation cannot be used in computing the percentage of D/MBE participation and again of D/WBE participation.

**LETTER OF INTENT FOR SRF CONSTRUCTION**

This form is to be completed by the D/MBE and D/WBE and must be submitted by the Bidder no later than close of business on the third business day after notification by the LGU. A separate form must be completed for each D/MBE and D/WBE involved in the project.

Project Title: \_\_\_\_\_ Project Location: \_\_\_\_\_

**TO:** \_\_\_\_\_  
(Name of Bidder)

**FROM:** \_\_\_\_\_  
(Please Indicate Status  D/MBE or  D/WBE)

° I/we intend to perform work in connection with the above project as (check one):

- An individual                                     A partnership  
 A corporation                                     A joint venture with: \_\_\_\_\_  
 Other (explain): \_\_\_\_\_

° It is understood that if you are awarded the contract, you intend to enter into an agreement to perform the activity described below for the prices indicated.

**DBE PARTICIPATION**

Description of Activity	Date of Project Commencement	\$ Amount	% Bid Price
		\$	%

° The undersigned certify that they will enter into a formal agreement upon execution of the contract for the above referenced project.

<b>BIDDER</b>		<b>DBE</b>	
(Authorized Original Signature)	Date	(Authorized Original Signature)	Date
ADDRESS:		ADDRESS:	
TELEPHONE #:		TELEPHONE #:	
FEIN:		FEIN:	
EMAIL ADDRESS:		EMAIL ADDRESS:	

**ORIGINALS:**

- ° Compliance Mgr. City/Town Project Location
- ° DEP Program Manager for DEP's AAO Director

**\* Attach a copy of current (within 2 years) DBE Certification**

**DBE CERTIFICATION OF UNITED STATES CITIZENSHIP**

For the SRF program, under the EPA Disadvantage Business Enterprise (DBE) Rule, a DBE must be owned or controlled by a socially and economically disadvantaged person that is also a **citizen of the United States** (See 40 CFR 33.202). “Ownership” is defined at 13 CFR 124.105 and “control” is defined at 13 CFR 124.106.

DBEs are certified for the SRF program through the Supplier Diversity Office using the federal Department of Transportation (DOT) DBE rules. EPA allows the use of DBEs certified under the DOT rules as long as they are also United States citizens. To ensure compliance with the EPA rule, MassDEP must verify United States citizenship through the completion of the following form for each DBE used on the project.

SRF Project Number \_\_\_\_\_

Contract Number \_\_\_\_\_

Contract Title \_\_\_\_\_

DBE Subcontractor \_\_\_\_\_

The undersigned, on behalf of the above named DBE subcontractor, hereby certifies that the DBE firm is either owned or controlled by a person or persons that are citizens of the United States.

\_\_\_\_\_  
Printed Name and Title of DBE Signatory

\_\_\_\_\_  
DBE Signature

\_\_\_\_\_  
Date

**DISADVANTAGED BUSINESS ENTERPRISE**  
**PROGRAM DBE SUBCONTRACTOR PARTICIPATION**  
**FORM**

The United States Environmental Protection Agency (EPA) requires that this form be provided to all subcontractors on the project. At the option of the subcontractor, this form may be filled out and submitted directly to the EPA DBE Coordinator.

NAME OF SUBCONTRACTOR	PROJECT NAME
ADDRESS	CONTRACT NO.
TELEPHONE NO.	E-MAIL ADDRESS
PRIME CONTRACTOR NAME:	

Please use the space below to report any concerns regarding the above EPA-funded project (e.g., reason for termination by prime contractor, late payment, etc.).

---



---



---



---



---

CONTRACT ITEM NO.	ITEM OF WORK OR DESCRIPTION OF SERVICES RECEIVED FROM THE PRIME CONTRACTOR	AMOUNT SUBCONTRACTOR WAS PAID BY PRIME CONTRACTOR
_____ Subcontractor Signature		_____ Title/Date

Equivalent to EPA form 6100-2

**REQUEST FOR WAIVER FOR SRF CONSTRUCTION**

Upon exhausting all known sources and making every possible effort to meet the minimum requirements for DBE participation, the Bidder may seek relief either partially or entirely from these requirements by submitting a completed waiver package by the close of business on the third business day after notification by the LGU. Failure to comply with this process shall be cause to reject the bid thereby rendering the Bidder not eligible for award of the contract.

**General Information**

Project Title: \_\_\_\_\_ Project Location: \_\_\_\_\_  
Bid Opening (time/date) \_\_\_\_\_  
Bidder: \_\_\_\_\_  
Mailing Address: \_\_\_\_\_  
Contact Person: \_\_\_\_\_ Telephone No. \_\_\_\_\_

**Minimum Requirements**

The bidder must demonstrate that good faith efforts were undertaken to comply with the percentage goals as specified. The firm seeking relief must show that such efforts were taken appropriately in advance of the time set for opening bid proposals to allow adequate time for response(s) by submitting the following:

- A. A detailed record of the effort made to contact and negotiate with disadvantaged minority and/or woman owned businesses, including:
  - 1. names, addresses, telephone numbers and contact dates of all such companies contacted;
  - 2. copies of written notice(s) which were sent to DBE potential subcontractors prior to bid opening;
  - 3. a detailed statement as to why each subcontractor contacted (i) was not willing to do the job or (ii) was not qualified to perform the work as solicited; and
  - 4. in the case(s) where a negotiated price could not be reached the bidder should detail what efforts were made to reach an agreement on a competitive price.
  - 5. copies of advertisements, dated not less than ten (10) days prior to bid opening, as appearing in general publications, trade-oriented publications, and applicable minority/women-focused media detailing the opportunities for participation;

- B. MassDEP may require the bidder to produce such additional information as it deems appropriate.
- C. No later than fifteen (15) days after submission of all required information and documentation, MassDEP shall make a determination, in writing, whether the waiver request is granted and shall provide that determination to the bidder and Awarding Authority. If the waiver request is denied, the facts upon which a denial is based will be set forth in writing.

CERTIFICATION

The undersigned herewith certifies that the above information and appropriate attachments are true and accurate to the best of my knowledge and that I have been authorized to act on behalf of the bidder in this matter.

---

(authorized original signature)

---

DATE

**DEPARTMENT OF ENVIRONMENTAL PROTECTION**  
**BUREAU OF WATER RESOURCES**  
**DIVISION OF MUNICIPAL SERVICES POLICIES**

The Division of Municipal Services (DMS) has established the following policies for all Division financially-assisted projects.

**POLICY MEMORANDUM NO. PM-1**

**EASEMENTS AND RIGHTS OF WAY**

Prior to the approval of financial assistance for construction, the owner shall obtain and shall thereafter retain, a fee simple or such estate or interest in the site of construction and rights of access as will assure undisturbed use and possession for the purpose of construction and operation for the estimated life of the project. The Division may refuse to approve financial assistance until it has received from the owner sufficient assurances that such interests have been obtained. Unless the Division otherwise notifies the owner, the certificate (under pains and penalties of perjury) of the owner's legal representative shall constitute such sufficient assurance.

Additional cost which result from interruptions of construction or extensions of contract time caused by the owner's failure to obtain the necessary interests in land shall be ineligible for financial assistance, and all such additional costs shall be borne by the owner.

**POLICY MEMORANDUM NO. PM-2**

**PERMITS**

The owner shall be responsible for identifying and obtaining all federal, state, local and railroad permits required by the nature and location of construction, including but not limited to building construction permits and permits for street and highway cuts and openings, and all such permits shall be listed in a separate permits section of the contract documents. To the extent possible, such permits shall be obtained by the owner prior to the solicitation of bids for construction, and copies of all permits so obtained shall be included in the said permits section. The status of the application for each permit, including the permit conditions, and costs, not obtained prior to the solicitation of bids shall also be indicated in the contract documents permits section. The Division may refuse to approve financial assistance for construction unless and until it has received from the owner sufficient assurances that all necessary permits have been or will be obtained prior to the commencement of construction.



## Policy Memorandum No. PM-2 – Permits (Con't)

The contractor shall be responsible for obtaining all permits required of his equipment, work force, or particular operations (such as blasting) in the performance of the contract and not otherwise specified in the two preceding paragraphs as to be obtained by the owner. These permit fees shall be paid by the contractor.

The owner shall be responsible for the payment of all other permit fees required by the construction.

The following permits shall not be eligible for financial participation by the Department of Environmental Protection (DEP).

- Permits and insurance for construction in railroads' rights of way;
- Building permits;
- Permits for opening public streets and other public or municipal rights of way;
- Permits for the use of explosives;
- Permits for the disposal of waste materials;
- Permits and fees for connecting to municipal utilities.

Permits required by extraordinary circumstances and not specifically excluded from eligibility above may be eligible for DEP participation. For such permits to be so eligible, the owner or his representative must notify the DEP project engineer in advance of obtaining such permit and receive from the engineer specific agreement that such permit will be eligible for DEP participation. Eligibility for such participation will not be made retroactively.

Additional costs which result from interruptions of construction or extensions of contract time resulting from the owner's or the contractor's failure to obtain the necessary permits may be ineligible for participation.

## **POLICY MEMORANDUM NO. PM-3**

## **FIELD CONTROLS**

The Owner shall be responsible for indicating on the contract drawings all easement limits and all property and other control lines for locating the principal component parts of the work together with those elevations and bench marks used in the design of the work, all hereinafter referred to as "field controls". Where easement and property limits have not previously been established in the field, the owner shall be responsible for establishment of such limits. From the information provided by the Owner, unless otherwise specified, the Contractor shall develop and make all layouts required for construction, such as slope stakes, batter boards, stakes for pipe locations and other working points, lines, elevations and cut sheets.

Whenever he has reason to believe that an error exists or whenever he is otherwise unable to locate the field controls, the contractor shall promptly notify the owner and the owner's engineer of such error with appropriate documentation.

**POLICY MEMORANDUM NO. PM-4**

**RECORD DRAWINGS**

The Owner shall be responsible for the preparation of all record drawings required by this contract. This responsibility may be delegated to the Owner's representative. The responsibility for preparation of record drawings shall not be delegated or transferred to the contractor. They may use the contractor's and sub-contractor's certified AS BUILT drawings along with their own marked up set in the preparation of the Record Drawings.

Division approved contract drawings shall be revised upon completion of the contract to reflect any changes made and/or final quantities, as appropriate.

**POLICY MEMORANDUM NO. PM-5**

**PLAN SCALE**

Unless otherwise approved in advance by the Division, the horizontal scale for construction plans for non-structural facilities shall be 1" = 40'. A larger horizontal scale shall be used where appropriate to show sufficient detail to construct the project. The vertical scale for construction plans for non-structural facilities shall be 1" = 4'. Based on the best information available at the time of their preparation, the location of underground utilities and support structures for overhead utilities shall be shown on the plans.

Unless otherwise exempted in advance by the Division, construction plans shall be updated whenever the date of the advertisement for bids for the construction of such facilities is more than one year after the date of approval by the Division or EPA; and in the case of approval by both such agencies, the later approval date shall be used in determining the need for update.

The consulting engineer shall receive adequate compensation for updating plans and specifications, and such additional cost shall be eligible for assistance to the extent not otherwise prohibited by USEPA and Division regulations and program guidance.

All revision, or review without need for revision, shall be noted and dated on the plans prior to advertisement of the project for bid.

**POLICY MEMORANDUM NO. PM-6**

**BORINGS LOGS**

All soil borings shall be taken as close as practicable to the construction line, and the location of all such borings shall be clearly indicated on the contract drawings. The plan view shall show the location and boring number of each boring. The profile view shall show the location, elevation, and depth of each soil boring, the location of each change in soil stratum, the groundwater level, and the average of blow counts at each five foot interval. As a minimum, boring logs to be submitted with the plans and specifications shall show the name of the company taking the borings, the soil classification, the number of blows per foot of penetration, the groundwater elevation, and the date on which the borings were taken.

As part of the submission of plans and specification for approval, the owner's representative shall include written justification for the lesser frequency and depth of borings where their interval is more than approximately 300' or their depth is less than 50% below depth of pipe invert.

**POLICY MEMORANDUM NO. PM-7**

**BREAKDOWN OF BID ITEMS**

The following items shall, where applicable, be listed separately in the bid documents.

- 1. Mobilization
- 2. Pavement
  - a. Municipal
    - i. temporary
    - ii. permanent
  - b. State
    - i. temporary
    - ii. permanent
- 3. Concrete cradle or encasement  
(to be identified where applicable)
- 4. Rock-Excavation
- 5. Wood or steel sheeting left in place
- 6. Excavation of unsuitable materials below grade.
- 7. Select and/or borrow material
- 8. Dewatering
- 9. Special Dewatering (coffer dam)

Mobilization costs are the costs of initiating the contract, exclusive of the cost of materials. Payment for mobilization shall be a lump sum at the price bid for this item in the proposal and shall be payable when the contractor is operational on the site. For purposes of this policy, “operational” shall mean the substantial commencement of work on site.

The lump sum price bid for mobilization shall not exceed five per centum (5%) of the total amount of the bid.

**POLICY MEMORANDUM NO. PM-8**

**PAVEMENT**

All roads and trenches therein shall be refilled and repaved in accordance with specifications provided by the owner in the contract documents. Please note that this policy may be excludable on federally assisted projects where bid alternative items may be required (i.e. trench width vs. full width pavement). You are advised to seek project specific clarification.

Loan eligibility shall be limited to the following:

- A. Where the depth of the pipe invert is 0 to 8’, the maximum pavement widths which shall be eligible for financial assistance are as follows:

<u>Nominal Pipe Diameter</u>	<u>Maximum Eligible Widths</u>	
	<u>Initial Pavement</u>	<u>Permanent Trench</u>
0-24”	6’-6”	8’-6”

Where the nominal pipe diameter is greater than 24” the maximum eligible width for initial re-paving shall be the nominal diameter of the pipe plus four (4) feet, and for permanent trench re-paving the maximum eligible width shall be the nominal pipe diameter plus six (6) feet.

- B. For each additional four (4) feet (or fraction thereof) of pipe invert depth, add three feet to the eligible width limits stated in paragraph A.

Policy Memorandum No. PM-8 – Pavement (Con't)

At the design phase of a project the owner has the option to elect either Initial Pavement with Option I (Permanent Trench replacement) or Initial with Option II (curb to curb over initial)

Initial Pavement

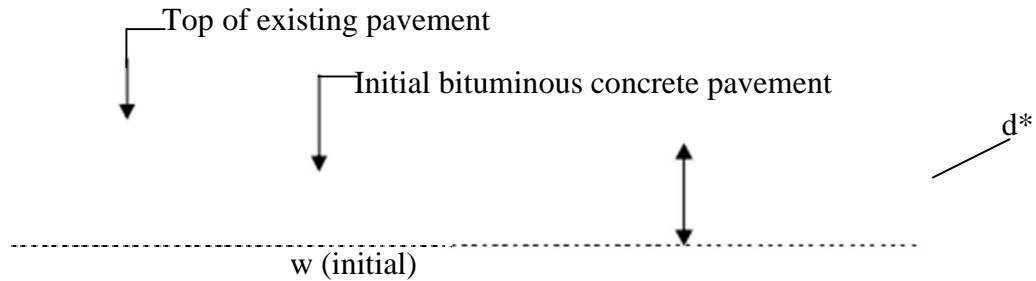

d\* = depth of existing pavement to a maximum of 3 inches (see general notes #3)  
w = maximum eligible Initial pavement width as described in paragraphs “A” & “B” on page DEP-DMS-CG’s-P4.

OPTION I Permanent Trench Pavement

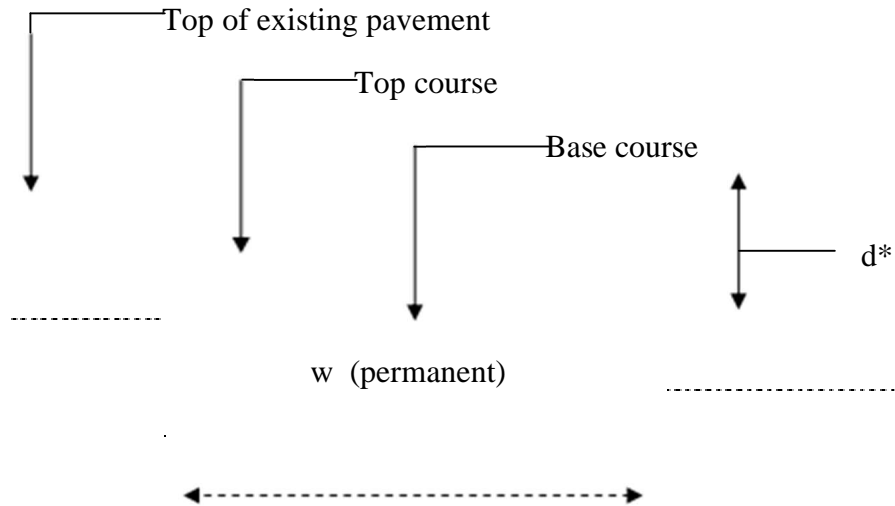

d\* = depth of existing pavement trench to a maximum of 3 inches (see general notes #3)  
w = maximum eligible permanent pavement width as described in paragraphs “A” & “B”.  
equals initial width plus 2 feet and includes:

- Cutting edges for the permanent trench
- Removal of initial patch plus two feet of existing pavement
- Fine grading/compacting gravel
- Placement of Permanent Trench pavement in two courses.

Policy Memorandum No. PM-8 – Pavement (Con't)

OPTION II Curb to Curb Pavement (overlay pavement for roadways up to 28 feet)

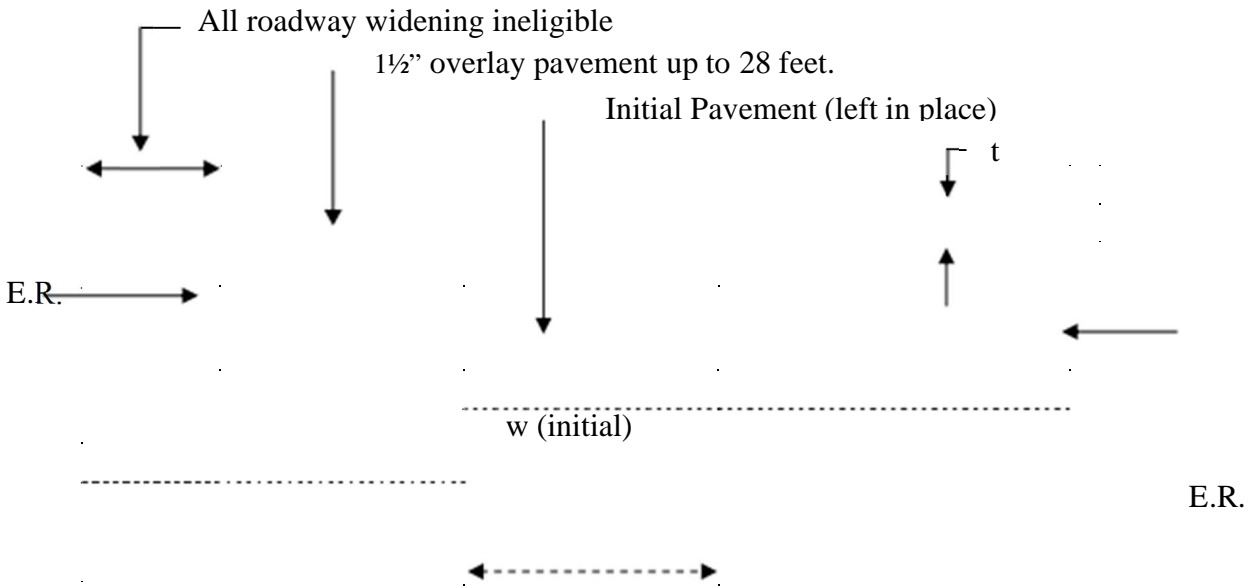

E.R.= edge of existing paved roadway

t = one and one half inch (1½") overlay of bituminous concrete pavement

GENERAL NOTES:

1. Repavement of settled areas and crown restoration within the trench limits shall be the responsibility of the contractor.
2. Leveling outside the trench limits shall be the responsibility of the owner.
3. Sewer trench re-fill and pavement re-paving on public ways under the jurisdiction of the Massachusetts Department of Public Works, the Metropolitan District Commission, or other such agency shall be in accordance with permit(s) issued therefore by that Department or Commission, as the case may be.
4. The Division will consider requests for increase in the participating pay limits defined in paragraphs A and B, when such increases are, in the Division's opinion, reasonable. Such requests should be documented in writing and submitted to the Division in a timely manner.
5. Projects which deviate from the above options are required to seek Division review and approval.

**POLICY MEMORANDUM NO. PM-9**

**PIPE TESTING**

Monthly payment estimates shall be prepared in accordance with contract documents. All pipe shall be tested in accordance with the contract documents and sound engineering practice. If, after 60 days following submission of a monthly payment estimate for pipe items, the pipe for which payment is requested has not been successfully tested, the owner may withhold up to 10% of the amount requested for such pipe items until the pipe has been so tested. However, in the case of a major (pipe diameter 24 inches or greater) interceptor pipe installation, sums retained by the owner pursuant to this policy memorandum shall not exceed two per centum (2%) of the costs of such pipe items.

**POLICY MEMORANDUM NO. PM-10**

**CHANGE ORDERS**

Executed change orders submitted to the Division for review and processing for financial assistance must be prepared on the attached Change Order Forms (PM-10, Attachment 1, pages A-1 & A-2) with a duplicate copy, calculation sheet(s) (PM-10, Attachment 2), and all other supporting documentation necessary for evaluation. Failure to comply with these instructions will result in delays in processing the change order and/or limited financial assistance.

M.G.L. c.44, s.31C requires that the auditor, accountant, or other municipal officer having similar duties must certify that adequate funding in an amount sufficient to cover the total cost of the change order has been made. Change orders will not be processed or approved until this certification is made on the face of the Change Order Form (PM-10 Attachment 1).

**Payment of Change Orders:**

Payment of all change orders shall be in accordance with the relevant provisions of Massachusetts General laws, Chapter 30, Section 39G for non-building construction and Section 39K for building construction.

Payment of change orders shall be made in accordance with one of the following three methods:

- A. Existing unit prices as set forth in the contract; or
- B. Agreed upon lump sum or unit prices; or
- C. Time and materials

A. **Payment for work for which there is a unit price in the contract:**

Where the contract contains a unit price for work and the Engineer orders a change for work of the same kind as other work contained in the contract and is performed under similar physical conditions, the contractor may accept full and final payment at the contract unit price(s) for the acceptable quantities.

Policy Memorandum No. PM-10 – Change Orders (Con't)

B. Payment for work or materials for which no price is contained in the contract:

If the Engineer directs, the contractor shall submit promptly in writing to the Engineer and offer to do the required work on a lump sum or unit price basis, as specified by the Engineer. The stated price, either lump sum or unit price, shall be divided so as to show that it is the sum of:

- (1) The estimated cost of labor, plus
- (2) Direct Labor Cost, plus
- (3) Material and Freight Costs, plus
- (4) Equipment Costs, plus
- (5) An amount not to exceed 20% of the sum of items (1) through (4) for overhead and profit, plus (if applicable),
- (6) In the case of work done by a subcontractor an amount not to exceed 7 ½ %, for the general contractor of the sum of items (1) through (4) for his overhead and profit, less, if applicable,
- (7) Credits for work deleted from the contract.

C. Payment for work on a time and materials basis:

Unless an agreed lump sum and/or unit price is obtained from above and is so stated in the change price, the contractor shall accept as full payment for which no other agreement is contained in contract, and amount equal to:

- (1) The estimated cost of Labor, plus
- (2) Direct Labor Cost, plus
- (3) Material and Freight Costs, plus
- (4) Equipment Costs, plus
- (5) An amount not to exceed 20% of the sum of items (1) through (4) for overhead and profit, plus (if applicable),
- (6) In the case of work done by a subcontractor an amount not to exceed 7 ½ %, for the general contractor of the sum of items (1) through (4) for his overhead and profit, less, if applicable,
- (7) Credits for work deleted from the contract.

Explanation of items (1) through (7) as outlined in “B” and “C”:

- (1) Labor – Only those workers employed on the project who are doing the extra work, including the foreman in charge, are allowable. General foremen, superintendents, or other supervisory personnel are considered to be included in the overhead markup as provided in items (5) and/or (6). Hourly labor rates in excess of those as listed in the contract wage rates (Federal or State, whichever applies) require documentation. As a minimum, an explanation and the appropriate copy of the certified payroll are required.





Policy Memorandum No. PM-10 – Change Orders (Con't)

(4) Equipment – Only the equipment required as a result of the change order is allowable. Equipment rental rates shall be governed by the current Nielson/Dataquest Rental Rate bluebook for Construction Equipment (the “Bluebook”). In determining the rental rate the following shall apply:

- (a) For equipment already on the project – the monthly prorated rental rate by the hourly use shall be applicable;
- (b) For equipment not on the project the daily rate, the weekly rate, or monthly rate will prevail, whichever will prove to be most cost effective. Small tools and manual equipment are examples of costs not allowable under this item. These costs are considered to be included in the overhead markup as provided in items (5) and/or (6) (1 month (normal use) = 176 hours)

(5) & (6) Overhead and Profit – All other costs not previously mentioned are considered to be included in this item, be it for the general contractor or subcontractor(s).

(7) Credits – Work deleted, material and equipment removed from the contractor, stored and/or returned shall be credited to the cost of the change order, less costs.

The Contractor shall furnish itemized statements of the cost of the work ordered and shall give the Engineer access to all accounts, bills and vouchers relating thereto; and unless the Contractor shall furnish such itemized statements, and access to all accounts, bills and vouchers, he shall not be entitled to payment for any items of extra work for which such information is sought by the Engineer. Deviations from any of the above will be reviewed for financial assistance on a case-by-case basis.

The change order will be prepared in such manner as to clearly separate Eligible and Ineligible Costs.

# CHANGE ORDER FORM

SRF Number \_\_\_\_\_  
Public Entity \_\_\_\_\_  
Contract Number \_\_\_\_\_  
Change Order Number \_\_\_\_\_

Contract Amount (As Bid) \$ \_\_\_\_\_

Net Change in Contract Price (this change order) \$ \_\_\_\_\_

Total Adjusted Contract Price (including this and all other change orders) \$ \_\_\_\_\_

This change order extends the time to complete the work by \_\_\_\_\_ calendar days.

The extended completion date is \_\_\_\_\_

This change order checked by \_\_\_\_\_  
(Chief) Resident Engineer Date

This change order is requested by: \_\_\_\_\_

This change order is recommended by: \_\_\_\_\_

\_\_\_\_\_  
Consultant Engineer P.E. Number Date

The undersigned agree to the terms of the change order.

\_\_\_\_\_  
Contractor Date

\_\_\_\_\_  
Owner Date

Certification of Appropriation under M.G.L. c.44, §31C: Adequate funding in an amount sufficient to cover the total cost of this change order is available.

By: \_\_\_\_\_  
Certification Officer (Auditor, accountant, treasurer) Date

Do not write below: this space reserved for STATE AGENCY APPROVAL

**CHANGE ORDER FORM (Continued)**

PM-10 Attachment 1

Page 2 of 2

Public Entity \_\_\_\_\_

SRF No: \_\_\_\_\_ Contract No. \_\_\_\_\_ Change Order No. \_\_\_\_\_

Contract Title: \_\_\_\_\_

Owner's Name: \_\_\_\_\_

Owner's Address: \_\_\_\_\_

Contractor's Name: \_\_\_\_\_

Contractor's Address: \_\_\_\_\_

Description of Change

\_\_\_\_\_  
\_\_\_\_\_  
\_\_\_\_\_  
\_\_\_\_\_  
\_\_\_\_\_  
\_\_\_\_\_  
\_\_\_\_\_  
\_\_\_\_\_

Reason for Change

\_\_\_\_\_  
\_\_\_\_\_  
\_\_\_\_\_  
\_\_\_\_\_  
\_\_\_\_\_  
\_\_\_\_\_  
\_\_\_\_\_  
\_\_\_\_\_  
\_\_\_\_\_  
\_\_\_\_\_

CALCULATION SHEET

(1)	Labor			
	Foreman	10 hrs @ \$10.00/hr.	\$	100.00
	Engineer	10 hrs @ 8.50/hr		85.00
	Operator	10 hrs @ 9.50/hr		95.00
	Laborers	24 hrs @ 7.00/hr		<u>168.00</u>
				\$448.00
(2)	Direct Labor Cost (use the agreed upon Direct Labor Cost)			
*	(30)% of \$448			
*	(Used for example purposes only)			134.00
(3)	Materials & Freight			
	150 l.f. of 12" pipe @ \$2.00/l.f.		\$	300.00
	15 v.f. precast SMH			1,700.00
	Freight (slip # _____ Enclosed)			<u>25.00</u>
				2,025.00
(4)	Equipment			
	1 Backhoe	10 hrs @ \$80.00/hr	\$	800.00
	1 Truck-crane	10 hrs @ \$100.00/hr		<u>1,000.00</u>
				1,800.00
		Total (Items 1 through 4)		<u>4,407.00</u>
(5)	20% markup for Overhead, Profit			
	20% of \$4,407			881.00
(6)	7 ½% markup for general contractor (if subcontractor is involved)			
	7 ½% of \$4,407			331.00
(7)	Credits (deductibles)			
				<u>- 323.00</u>
		Total Cost	\$	5,296.00

Reminder: Provide support documentation as necessary i.e. vouchers, correspondence, Calculation, photographs, reports .....

**POLICY MEMORANDUM NO. PM-11**

**UTILITY RELOCATION**

The construction of treatment facilities, sewers, pumping stations, force mains and appurtenant work can cause the relocation of utilities. Costly relocation can sometimes be minimized by early communication and cooperation of the representatives of the municipality (owner) and the utilities.

Every possible effort should be made by the owner and each utility to establish the location of existing utilities in the vicinity of the proposed construction. The owner or its consulting engineer should make every reasonable effort to design the proposed construction so that relocation of existing utilities is minimized whenever possible. If the proposed construction is in an area of many existing utilities or in an otherwise critical area, the utilities are encouraged to mark the location of their existing utilities at the site during the design phase of the project.

During the design phase of the project, the municipality should provide timely notice to all utilities known or thought to have facilities in or proximate to the site of such future construction.

**POLICY MEMORANDUM NO. PM-12**

**REFUNDABLE DEPOSITS FOR  
PLANS AND SPECIFICATIONS**

For each set of project plans and specifications provided, the owner may require a deposit in form of cash or other appropriate security, in an amount sufficient to cover the costs of production of such plans and specifications.

Upon return of the plans and specifications to the owner within a reasonable time and in good condition, such deposit shall be refunded.

Actual mailing costs, if any, shall be borne by the party requesting such plans and specifications.

**POLICY MEMORANDUM NO. PM-13**

**BID OPENING PROCEDURES**

As a minimum, bid documents shall be reviewed/inspected for conformance to the following bid opening procedure in the order presented below. Failure to comply with any of these steps shall render the bid non-responsive and upon determination of such non-responsiveness, such bid shall be rejected immediately, set aside, and shall receive no further consideration.

**Bid Opening Procedure**

Step #1. Timeliness – The bid must be filed at the place and within the time specified therefore in the invitation to bid, and no bid shall be accepted after such time. The time at which a bid is filed should be time/date stamped or otherwise prominently noted on the bid;

Policy Memorandum No. PM-13 – Bid Opening Procedures (Con't)

Step #2. Bid Security – Properly executed bid security, in the amount and terms specified in the invitation to bid (equal to 5% of Base Bid or Highest Possible Amount considering all alternatives) shall be placed in a seal envelope and attached to the outside of the envelope containing the bid at the time of its submission;

A. Bid Bond

The Bid bond must be dated On or Before the Bid Date;  
Issued by a Bonding Company Licensed in Massachusetts;  
Accompanied by a Current Power of Attorney;  
Signed by Surety;

B. Check

The Check must be a Certified, Cashiers or Bank Treasurer's;  
Dated On or Before the Bid Date;

Step #3. Bid Signature – The bid and all accompanying documents so required shall be signed by the bidder or its authorized representative before submission;

Step #4. Addenda – All addenda shall be sent certified mail, return receipt requested, by the owner to all individuals and organizations which have received plans and specifications and shall be mailed not later than five days prior to the date established for submission of bids. All bidders shall include with their bids written acknowledgement of receipt of all addenda, which acknowledgement may be on a form provided therefore by the owner.

Alternates – Any Alternates shall be acknowledged.

Step #5. Written Dollar Amounts – The total dollar amount of each bid shall be read, and the three lowest bids shall be selected for further consideration. The remaining bids shall then be set aside. The three apparent low bids shall be read to determine whether the unit price for each line item of each bid has been written therein in words. If it has not, such bid shall be rejected and shall receive no further consideration. ***Bid amounts shall be consistent (words vs. numbers) and if words and numbers differ, the words govern.*** This procedure shall then be repeated with the next apparent low bid until three are acceptable which have all the unit prices written in words, at which time the lowest bid shall be announced as the apparent low bidder, and the bid opening procedure shall be closed.

The Division recommends that this policy memorandum be included in all contract specifications and that the owner's evaluator(s) use the attached form (PM-13 Attachment 1) for bid opening procedures.

The Contractor's Bid Opening Checklist also attached hereto, is for use by each contractor to assure that his bid conforms with this policy memorandum. It is recommended that the checklist (PM-13 Attachment 2) be included in information for bidders, or at the end of the bid proposal, or in some other prominent part of the bid specifications

**FORM FOR BID OPENING PROCEDURES**

(to be completed by the owner's evaluator(s))

CONTRACT NO.: \_\_\_\_\_

DATE: \_\_\_\_\_

CONTRACT NAME: \_\_\_\_\_

BID OPENING TIME: \_\_\_\_\_

All non-responsive bids shall be rejected forthwith by the awarding authority upon determination of such bids' non-responsiveness at the time bids are opened and read. Failure to comply with any one of the requirements shall render the bid non-responsive, and upon determination of such non-responsiveness such bid shall be rejected and receive no further consideration.

A = Acceptable

N-R = Non-Responsive (explain reasons on supplemental sheet & attach)

BIDDER	1. TIMELINESS	2. BID SECURITY	3. SIGNATURE	4. ADDENDA ALTERNATIVES	5. WRITTEN DOLLAR AMOUNTS	COMPLIANCE (CIRCLE ONE)	
						YES	NO
1						YES	NO
2						YES	NO
3						YES	NO
4						YES	NO
5						YES	NO
6						YES	NO
7						YES	NO
8						YES	NO
9						YES	NO
10						YES	NO

**POLICY MEMORANDUM NO. PM-14**

**PAYMENT FOR ROCK EXCAVATION**

There shall be in the contract documents a separate pay item for rock excavation. For such purposes, “rock” shall mean igneous, sedimentary, metamorphic, and conglomerate rock, which for excavation must be drilled, blasted, broken, or ripped by power tools. Boulders and concrete structures one cubic yard or greater, however removed, are included within this definition of rock for payment purposes. At the option of the owner or his representative a separate pay item for boulders, concrete structures, or concrete road base may be used.

<u>Depth From Ground Surface</u> <u>To Invert Pipe</u>	<u>Pay Width</u> <u>(Nominal Pipe Diameter)</u>	
* 0 – 12’	<del>0-24”</del>	<del>Over 24”</del>
* Over 12’ – 20’	5’0”	D+3’0”
	7’0”	D+5’

Engineer’s plans and specifications shall establish pay limits below pipe and structures.

- See PM-14 Attachment 1 (typical cross section)

Payment width for depths over twenty feet (20’) shall be determined on a case-by-case basis consistent with the foregoing chart.

The pay limit for rock removal outside proposed manholes shall commence one foot (1’) outside the widest dimension of the structure of shall be the maximum connecting trench width, whichever is greater.

Payment depth for rock which is encountered in a trench shall be no less than three feet (3’) when removal can be accomplished only by drilling and blasting or by use of jack (air or hydraulic) hammers.

Payment for rock removed, using the same or equal equipment as utilized for normal trench excavation, shall be limited to the actual depth removed within the limits established by the contract documents.

Boulders encountered within the pay limits of excavation, whose volume is one cubic yard or greater, part of which extends outside said limits shall be paid in accordance with the actual volume excavated.



# CG-14 ROCK EXCAVATION

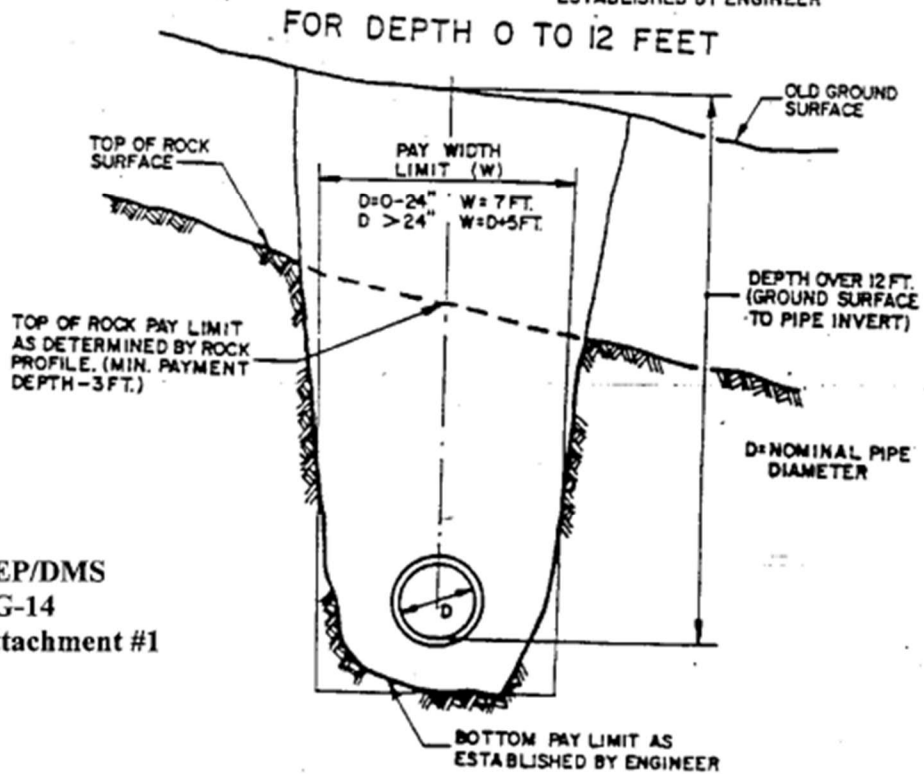
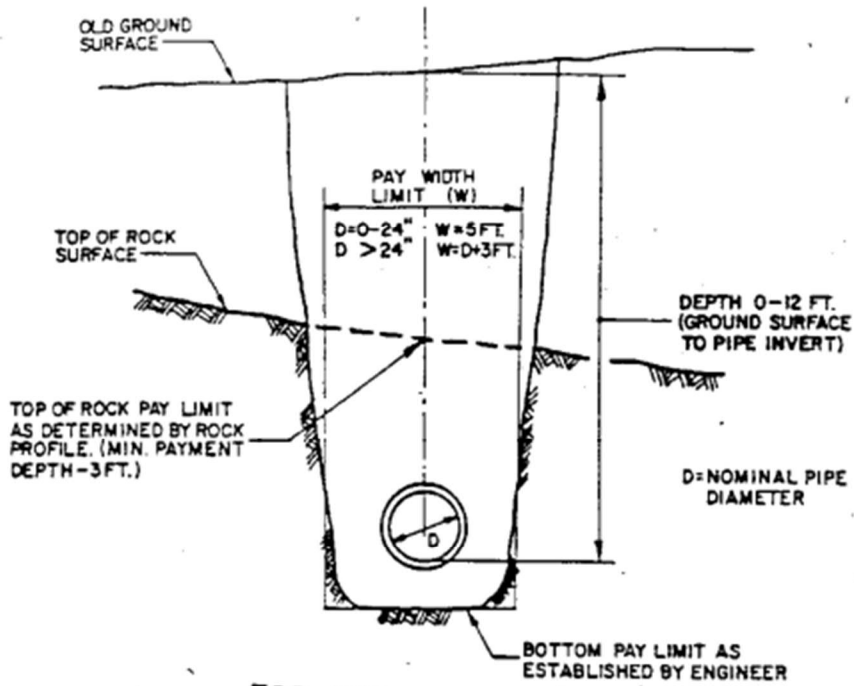

DEP/DMS  
CG-14  
Attachment #1

**POLICY MEMORANDUM NO. PM-15**

**TRAFFIC POLICE**

The reasonable costs for police details required for traffic control on a construction project which receives financial assistance shall be considered as an eligible administrative cost. A police detail item shall not be included as a bid item in the contract documents.

“Police” as used in this memorandum includes local, county, capital, state, regular and auxiliary police.

**Owner’s Responsibility**

It shall be the owner’s responsibility to submit in writing the hourly rate of pay to be established for detailed traffic police and each change in rate during the course of the project. It is the owner’s responsibility to arrange, document and pay for such police details. The owner or its representative shall meet with the police chief or other officer in charge of police detail duty to review contract needs. The owner shall maintain a daily record of the following:

- a. Officer’s name
- b. Hours worked
- c. Location of assignment
- d. Hourly rate

**POLICY MEMORANDUM NO. PM-16**

**DOCUMENTATION REQUIRED TO  
SUBSTANTIATE CONTRACT QUANTITIES**

<u>Unit</u>	<u>Documentation required</u>
Acres (A)	Location, station, offset and calculations. Location = Street right-of-way, etc; Station = Point on Baseline; Offset = Distance left or right of Baseline
Cubic Yard (C.Y.)	Location, stations, widths, depths, calculations and Cross sections as necessary
Each (Ea.)	Location, station, and offset.
Gallon (Gal.)	Location, stations, calculations (if appropriate) and delivery slips.
Hour (Hr.)	Hours and location.
Linear Feet (L.F.)	Location, stations, and offsets.
Month (Mo.)	Location, period of time and calculations if applicable.

1000 Foot Board Measure (MFBM)	Location, stations, offset, elevations, grade, and calculations.  Attach invoices where applicable.
Pound (Lb.)	Locations, stations, and calculations (if applicable). Attach Delivery weight slips.
Square Feet (S.F.)	Locations, stations and calculations
Square Yard (S.Y.)	Locations, stations and calculations
Ton	Locations, stations and calculations (if applicable). Attach Delivery weight slips.
Vertical Feet (V.F.)	Locations, stations, elevations, and offsets.

Note:

1. All of the above, that apply must be submitted with a final payment request or change order as applicable.
2. Where in place measurement is not possible or practical, delivery slips may be used to substantiate quantities. 3. Change orders – See PM-10 in which some of the above may be applicable in justifying materials, equipment and labor.
4. When necessary, itemized quantities must be separated into eligible and non-eligible units with separate calculations to justify eligible costs.
5. Overruns and underruns of any specific item shall be explained with an appropriate sentence or paragraph.
6. On all quantities, units of payment shall be maintained at the project site and shall be updated daily so that upon field inspection by the C.O.E., EPA or DMS, the quantities paid to date can be substantiated.
7. In the case of unforeseen conditions, photos should be submitted with the applicable item in addition to the recommended documentation.
8. Documentation of units of payment shall be clearly legible and cross referenced to the applicable sheets of the record drawings.
9. For record drawings policy, please see PM-4.

---

DMS Policies 1 through 16 Approved By:

Steven J. McCurdy  
Division of Municipal Services

**DWS POLICY 88-02**  
**DEPARTMENT OF ENVIRONMENTAL PROTECTION**  
**POLICY FOR REVIEW OF SEWER LINE/WATER SUPPLY PROTECTION**

The Department of Environmental Protection seeks to protect existing and potential water supplies from the potentially negative effects of leaking sewer lines through the adoption of a Department policy on this subject.

The following restrictions will apply to new sewer construction statewide:

Gravel Packed Wells

- ~ Within the 400 foot radius protective distance around gravel packed wells, all sewer lines and appurtenances are prohibited, unless they are necessary to eliminate existing and/or potential sources of pollution to the well.

Tubular Wells

- ~ Within the 250 foot radius protective distance around tubular wells, all sewer lines and appurtenances are prohibited, unless they are necessary to eliminate existing and/or potential sources of pollution to the well.

Gravel Packed and Tubular Wells

- ~ Within a minimum radius of 2,640 feet or unless otherwise documented by an appropriate study specifically defining the area of influence and approved by the Division of Water Supply, all sewer lines and appurtenances will be designed and constructed for maximum water tightness.
- Force Mains or Pressure Sewers: shall be tested at 150% above maximum operating pressure or 150 p.s.i. whichever is greater. Testing shall conform to the requirements of the American Water works Association (AWWA) standard c 600.
- Gravity Sewers: shall be tested by approved methods which will achieve test results for infiltration or exfiltration of less than 100 gallons/inch diameter/mile/24 hours.
- Manholes: shall be installed with watertight covers with locking or bolted and gasketed assemblies. Testing for infiltration/exfiltration shall conform to the same standards as the maximum allowed for pipes in the manhole as required for gravity sewers, indicated above.
- Satisfactory test results for Force Mains, Manholes and Gravity Sewers shall be performed prior to the expiration of the contractor's one year guarantee period.
- All pumping stations within this zone shall have standby power high water alarms telemetered to an appropriated location that is manned at all times. An emergency contingency plan must be developed by the owner and approved by the BWR.
- A minimum of Class B bedding as defined by WPCF-MOP9 must be used for all piping.
- Service connections (laterals and house connections) shall be rigidly inspected by the appropriate municipal official. Certified inspection reports shall be submitted to the BWR.

### Bedrock Wells

The above requirements are the same for bedrock wells, with the Department reserving the right to require more stringent controls on a case-by-case basis.

### Surface Water Supplies

- ~ Within 100 feet of all surface water supplies and tributaries all sewer lines and appurtenances are prohibited except as required to cross tributaries or to eliminate existing or potential pollution to the water supply. In the latter case, watertight construction methods shall be used.
- ~ Tributary stream crossings shall employ watertight construction methods of sewer lines and manholes. Watertight construction must extend 100 feet to either side of the stream.
- ~ Within 1,000 feet of surface water supplies and tributaries, all pumping stations shall have standby power and high water alarms telemetered to an appropriate location that is manned at all times. An emergency contingency plan must be developed by the owner of the wastewater treatment facility and submitted to the BWR for approval.
- ~ Beyond 1,000 feet and within the watershed of surface water supplies the Department may in specific circumstances after review, require additional controls.

### Potential Public Water Supplies

The above requirements also apply to potential public water supplies.

### Baseline Data Requirements

Two (2) copies of an appropriately scaled map(s) shall be submitted to the Department which details the proposed sewers and/or appurtenances and also includes the following:

- (1) the location of all nearby existing or potential surface water supplies, tributaries thereto, and watershed boundaries;
- (2) the location of existing and potential public and municipal potable groundwater supply wells.

The Department reserves the right to impose more restrictive measures than those contained in this policy as deemed appropriate.

Definitions

- Appurtenances – all attachments to sewer lines necessary for the transport and operation and maintenance of sewer lines, including manholes, pumping station, siphons, etc.
- Area of influence – that area of an aquifer which contributes water to a well under the most severe recharge and pumping condition that can be realistically anticipated (i.e. pumping at the safe yield of the well for 180 days without any natural recharge occurring). It is bounded by the groundwater divides which result from pumping the well and by the contact of the edge of the aquifer with less permeable materials such as till and bedrock. At some locations, streams and lakes may form recharge boundaries.
- Potential public water supply – areas designated by communities for water supply purposes where land has been set aside and Department approved pump tests conducted and surface water supplies as defined below.
- Surface Water Supply – Waters classified as Class A by the DWPC.
- Public Water Supply Systems – as defined in 310 CMR 22.02 (DEP Drinking Water Regulations).

- Class B Bedding – as defined in WPCF Manual of Practice No. 9.

APPROVED: (Signature on File)

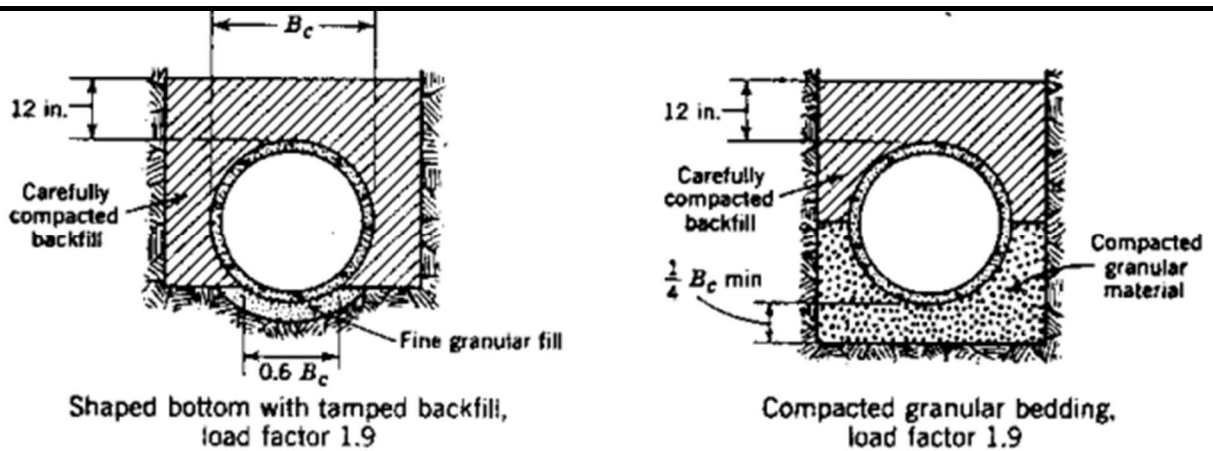

**Class B---First-Class Bedding** – Class B bedding may be achieved by either of two construction methods:

- a. Shaped Bottom with Tamped Backfill. The bottom of the trench excavation shall be

shaped to conform to a cylindrical surface with a radius at least 2 in. (5 cm) greater than the radius to the outside of the pipe and with a width sufficient to allow six-tenths of the width of the pipe barrel to be bedded in fine granular fill placed in the shaped excavation.

Carefully compacted backfill shall be placed at

the sides of the pipe to a thickness of at least 12 in. (30 cm) above the top of the pipe.

Shaped trench bottoms are difficult to achieve under current construction conditions.

- b. **Compacted Granular Bedding with Tamped Backfill.** The pipe shall be bedded in compacted granular material placed on a flat trench bottom. The granular bedding shall have a minimum thickness of one-fourth the outside pipe diameter and shall extend halfway up the pipe barrel at the sides. The remainder of the side fills and a minimum depth of 12 in. (30 cm) over the top of the pipe shall be filled with carefully compacted material.

## **Davis Bacon Act Requirements**

All construction projects are subject to the Davis Bacon wage rate requirements and must include the appropriate sections of the following document in its entirety in the contract documents.

**The vast majority of SRF projects will be bid by Governmental Entities (i.e., Cities, Towns, Authorities, Water Districts, Wastewater Districts). These projects must include the following language in construction contracts:**

**I.3. Contract and Subcontract Provisions**

**I.4. Contract Provisions for Contracts in Excess of \$100,000 (if applicable)**

**I.5. Compliance Verification**

**This language may be found on pages DB-3-DB-11.**

**In certain cases, SRF projects may be bid by non-Governmental Entities (i.e., private water companies, private PWSs, etc.). These projects must include the following language in construction contracts:**

**II.3. Contract and Subcontract Provisions**

**II.4. Contract Provisions for Contracts in Excess of \$100,000 (if applicable)**

**II.5. Compliance Verification**

**This language may be found on pages DB-11-DB-21**

### **Preamble**

With respect to the Clean Water and Safe Drinking Water State revolving Funds, EPA provides capitalization grants to each State which in turn provides subgrants or loans to eligible entities within the State. Typically, the subrecipients are municipal or other local governmental entities that manage the funds. For these types of recipients, the provisions set forth under Roman Numeral I, below, shall apply. Although EPA and the State remain responsible for ensuring subrecipients' compliance with the wage rate requirements set forth herein, those subrecipients shall have the primary responsibility to maintain payroll records as described in Section 3(ii)(A), below and for compliance as described in Section I-5.

Occasionally, the subrecipient may be a private for profit or not for profit entity. For these types of recipients, the provisions set forth in Roman Numeral II, below, shall apply. Although EPA and the State remain responsible for ensuring subrecipients' compliance with the wage rate requirements set forth herein, those subrecipients shall have the primary responsibility to maintain payroll records as described in Section II-3(ii)(A), below and for compliance as described in Section II-5.

### **I. Requirements For Subrecipients That Are Governmental Entities:**

The following terms and conditions specify how recipients will assist EPA in meeting its Davis-Bacon (DB) responsibilities when DB applies to EPA awards of financial assistance with respect to State recipients and subrecipients that are governmental entities. If a subrecipient has



questions regarding when DB applies, obtaining the correct DB wage determinations, DB provisions, or compliance monitoring, it may contact the State recipient. If a State recipient needs guidance, the recipient may contact Valerie Marshall at EPA Region 1 (617-918-1674) for guidance. The recipient or subrecipient may also obtain additional guidance from DOL's web site at <https://www.dol.gov/whd/govcontracts/dbra.htm>

## **1. Applicability of the Davis- Bacon (DB) prevailing wage requirements.**

DB prevailing wage requirements apply to the construction, alteration, and repair of treatment works carried out in whole or in part with assistance made available by a State water pollution control revolving fund and to any construction project carried out in whole or in part by assistance made available by a drinking water treatment revolving loan fund. If a subrecipient encounters a unique situation at a site that presents uncertainties regarding DB applicability, the subrecipient must discuss the situation with the recipient State before authorizing work on that site.

## **2. Obtaining Wage Determinations.**

(a) Subrecipients shall obtain the wage determination for the locality in which a covered activity subject to DB will take place prior to issuing requests for bids, proposals, quotes or other methods for soliciting contracts (solicitation) for activities subject to DB. These wage determinations shall be incorporated into solicitations and any subsequent contracts. Prime contracts must contain a provision requiring that subcontractors follow the wage determination incorporated into the prime contract.

(i) While the solicitation remains open, the subrecipient shall monitor [www.wdol.gov](http://www.wdol.gov) weekly to ensure that the wage determination contained in the solicitation remains current. The subrecipients shall amend the solicitation if DOL issues a modification more than 10 days prior to the closing date (i.e. bid opening) for the solicitation. If DOL modifies or supersedes the applicable wage determination less than 10 days prior to the closing date, the subrecipients may request a finding from the State recipient that there is not a reasonable time to notify interested contractors of the modification of the wage determination. The State recipient will provide a report of its findings to the subrecipient.

(ii) If the subrecipient does not award the contract within 90 days of the closure of the solicitation, any modifications or supersedes DOL makes to the wage determination contained in the solicitation shall be effective unless the State recipient, at the request of the subrecipient, obtains an extension of the 90 day period from DOL pursuant to 29 CFR 1.6(c)(3)(iv). The subrecipient shall monitor [www.wdol.gov](http://www.wdol.gov) on a weekly basis if it does not award the contract within 90 days of closure of the solicitation to ensure that wage determinations contained in the solicitation remain current.

(b) If the subrecipient carries out activity subject to DB by issuing a task order, work assignment or similar instrument to an existing contractor (ordering instrument) rather than by publishing a solicitation, the subrecipient shall insert the appropriate DOL wage determination from [www.wdol.gov](http://www.wdol.gov) into the ordering instrument.

(c) Subrecipients shall review all subcontracts subject to DB entered into by prime contractors to verify that the prime contractor has required its subcontractors to include the applicable wage determinations.

(d) As provided in 29 CFR 1.6(f), DOL may issue a revised wage determination applicable to a subrecipient's contract after the award of a contract or the issuance of an ordering instrument if DOL determines that the subrecipient has failed to incorporate a wage determination or has used a wage determination that clearly does not apply to the contract or ordering instrument. If this occurs, the subrecipient shall either terminate the contract or ordering instrument and issue a revised solicitation or ordering instrument or incorporate DOL's wage determination retroactive to the beginning of the contract or ordering instrument by change order. The subrecipient's contractor must be compensated for any increases in wages resulting from the use of DOL's revised wage determination.

### **3. Contract and Subcontract provisions.**

(a) The Recipient shall insure that the subrecipient(s) shall insert in full in any contract in excess of \$2,000 which is entered into for the actual construction, alteration and/or repair, including painting and decorating, of a treatment work under the CWSRF or a construction project under the DWSRF financed in whole or in part from Federal funds or in accordance with guarantees of a Federal agency or financed from funds obtained by pledge of any contract of a Federal agency to make a loan, grant or annual contribution (except where a different meaning is expressly indicated), and which is subject to the labor standards provisions of any of the acts listed in § 5.1 or the FY 2012 Appropriations Act, the following clauses:

(1) Minimum wages.

(i) All laborers and mechanics employed or working upon the site of the work will be paid unconditionally and not less often than once a week, and without subsequent deduction or rebate on any account (except such payroll deductions as are permitted by regulations issued by the Secretary of Labor under the Copeland Act (29 CFR part 3)), the full amount of wages and bona fide fringe benefits (or cash equivalents thereof) due at time of payment computed at rates not less than those contained in the wage determination of the Secretary of Labor which is attached hereto and made a part hereof, regardless of any contractual relationship which may be alleged to exist between the contractor and such laborers and mechanics.

Contributions made or costs reasonably anticipated for bona fide fringe benefits under section 1(b)(2) of the Davis-Bacon Act on behalf of laborers or mechanics are considered wages paid to such laborers or mechanics, subject to the provisions of paragraph (a)(1)(iv) of this section; also, regular contributions made or costs incurred for more than a weekly period (but not less often than quarterly) under plans, funds, or programs which cover the particular weekly period, are deemed to be constructively made or incurred during such weekly period. Such laborers and mechanics shall be paid the appropriate wage rate and fringe benefits on the wage determination for the classification of work actually performed, without regard to skill, except as provided in §5.5(a)(4). Laborers or mechanics performing work in more than one classification may be compensated at the rate specified for each classification for the time actually worked therein:

Provided, that the employer's payroll records accurately set forth the time spent in each classification in which work is performed. The wage determination (including any additional classification and wage rates conformed under paragraph (a)(1)(ii) of this section) and the Davis-Bacon poster (WH-1321) shall be posted at all times by the contractor and its subcontractors at the site of the work in a prominent and accessible place where it can be easily seen by the workers. Subrecipients may obtain wage determinations from the U.S. Department of Labor's web site, [www.dol.gov](http://www.dol.gov).

(ii)(A) The subrecipient(s), on behalf of EPA, shall require that any class of laborers or mechanics, including helpers, which is not listed in the wage determination and which is to be employed under the contract shall be classified in conformance with the wage determination. The State award official shall approve a request for an additional classification and wage rate and fringe benefits therefore only when the following criteria have been met:

- (1) The work to be performed by the classification requested is not performed by a classification in the wage determination; and
- (2) The classification is utilized in the area by the construction industry; and
- (3) The proposed wage rate, including any bona fide fringe benefits, bears a reasonable relationship to the wage rates contained in the wage determination.

(B) If the contractor and the laborers and mechanics to be employed in the classification (if known), or their representatives, and the subrecipient(s) agree on the classification and wage rate (including the amount designated for fringe benefits where appropriate), documentation of the action taken and the request, including the local wage determination shall be sent by the subrecipient (s) to the State award official. The State award official will transmit the request, to the Administrator of the Wage and Hour Division, Employment Standards Administration, U.S. Department of Labor, Washington, DC 20210 and to the EPA DB Regional Coordinator concurrently. The Administrator, or an authorized representative, will approve, modify, or disapprove every additional classification request within 30 days of receipt and so advise the State award official or will notify the State award official within the 30-day period that additional time is necessary.

(C) In the event the contractor, the laborers or mechanics to be employed in the classification or their representatives, and the subrecipient(s) do not agree on the proposed classification and wage rate (including the amount designated for fringe benefits, where appropriate), the award official shall refer the request and the local wage determination, including the views of all interested parties and the recommendation of the State award official, to the Administrator for determination. The request shall be sent to the EPA DB Regional Coordinator concurrently. The Administrator, or an authorized representative, will issue a determination within 30 days of receipt of the request and so advise the contracting officer or will notify the contracting officer within the 30-day period that additional time is necessary.

(D) The wage rate (including fringe benefits where appropriate) determined pursuant to paragraphs (a)(1)(ii)(B) or (C) of this section, shall be paid to all workers performing work in the classification under this contract from the first day on which work is performed in the classification.

(iii) Whenever the minimum wage rate prescribed in the contract for a class of laborers or mechanics includes a fringe benefit which is not expressed as an hourly rate, the contractor shall either pay the benefit as stated in the wage determination or shall pay another bona fide fringe benefit or an hourly cash equivalent thereof.

(iv) If the contractor does not make payments to a trustee or other third person, the contractor may consider as part of the wages of any laborer or mechanic the amount of any costs reasonably anticipated in providing bona fide fringe benefits under a plan or program, Provided, That the Secretary of Labor has found, upon the written request of the contractor, that the applicable standards of the Davis-Bacon Act have been met. The Secretary of Labor may require the contractor to set aside in a separate account assets for the meeting of obligations under the plan or program.

(2) Withholding. The subrecipient(s), shall upon written request of the EPA Award Official or an authorized representative of the Department of Labor, withhold or cause to be withheld from the contractor under this contract or any other Federal contract with the same prime contractor, or any other federally-assisted contract subject to Davis-Bacon prevailing wage requirements, which is held by the same prime contractor, so much of the accrued payments or advances as may be considered necessary to pay laborers and mechanics, including apprentices, trainees, and helpers, employed by the contractor or any subcontractor the full amount of wages required by the contract. In the event of failure to pay any laborer or mechanic, including any apprentice, trainee, or helper, employed or working on the site of the work, all or part of the wages required by the contract, the (Agency) may, after written notice to the contractor, sponsor, applicant, or owner, take such action as may be necessary to cause the suspension of any further payment, advance, or guarantee of funds until such violations have ceased.

(3) Payrolls and basic records.

(i) Payrolls and basic records relating thereto shall be maintained by the contractor during the course of the work and preserved for a period of three years thereafter for all laborers and mechanics working at the site of the work. Such records shall contain the name, address, and social security number of each such worker, his or her correct classification, hourly rates of wages paid (including rates of contributions or costs anticipated for bona fide fringe benefits or cash equivalents thereof of the types described in section 1(b)(2)(B) of the Davis-Bacon Act), daily and weekly number of hours worked, deductions made and actual wages paid. Whenever the Secretary of Labor has found under 29 CFR 5.5(a)(1)(iv) that the wages of any laborer or mechanic include the amount of any costs reasonably anticipated in providing benefits under a plan or program described in section 1(b)(2)(B) of the Davis-Bacon Act, the contractor shall maintain records which show that the commitment to provide such benefits is enforceable, that the plan or program is financially responsible, and that the plan or program has been communicated in writing to the laborers or mechanics affected, and records which show the costs anticipated or the actual cost incurred in providing such benefits. Contractors employing apprentices or trainees under approved programs shall maintain written evidence of the registration of apprenticeship programs and certification of trainee programs, the registration of the apprentices and trainees, and the ratios and wage rates prescribed in the applicable programs.

(ii)(A) The contractor shall submit weekly, for each week in which any contract work is performed, a copy of all payrolls to the subrecipient, that is, the entity that receives the sub-grant or loan from the State capitalization grant recipient. Such documentation shall be available on request of the State recipient or EPA. As to each payroll copy received, the subrecipient shall provide written confirmation in a form satisfactory to the State indicating whether or not the project is in compliance with the requirements of 29 CFR 5.5(a)(1) based on the most recent payroll copies for the specified week. The payrolls shall set out accurately and completely all of the information required to be maintained under 29 CFR 5.5(a)(3)(i), except that full social security numbers and home addresses shall not be included on the weekly payrolls. Instead the payrolls shall only need to include an individually identifying number for each employee (e.g., the last four digits of the employee's social security number). The required weekly payroll information may be submitted in any form desired. Optional Form WH-347 is available for this purpose from the Wage and Hour Division Web site at <https://www.dol.gov/whd/forms/wh347.pdf> or its successor site. The prime contractor is responsible for the submission of copies of payrolls by all subcontractors. Contractors and subcontractors shall maintain the full social security number and current address of each covered worker, and shall provide them upon request to the subrecipient(s) for transmission to the State or EPA if requested by EPA, the State, the contractor, or the Wage and Hour Division of the Department of Labor for purposes of an investigation or audit of compliance with prevailing wage requirements. It is not a violation of this section for a prime contractor to require a subcontractor to provide addresses and social security numbers to the prime contractor for its own records, without weekly submission to the subrecipient(s).

(B) Each payroll submitted shall be accompanied by a "Statement of Compliance," signed by the contractor or subcontractor or his or her agent who pays or supervises the payment of the persons employed under the contract and shall certify the following:

(1) That the payroll for the payroll period contains the information required to be provided under § 5.5 (a)(3)(ii) of Regulations, 29 CFR part 5, the appropriate information is being maintained under § 5.5 (a)(3)(i) of Regulations, 29 CFR part 5, and that such information is correct and complete;

(2) That each laborer or mechanic (including each helper, apprentice, and trainee) employed on the contract during the payroll period has been paid the full weekly wages earned, without rebate, either directly or indirectly, and that no deductions have been made either directly or indirectly from the full wages earned, other than permissible deductions as set forth in Regulations, 29 CFR part 3;

(3) That each laborer or mechanic has been paid not less than the applicable wage rates and fringe benefits or cash equivalents for the classification of work performed, as specified in the applicable wage determination incorporated into the contract.

(C) The weekly submission of a properly executed certification set forth on the reverse side of Optional Form WH-347 shall satisfy the requirement for submission of the "Statement of Compliance" required by paragraph (a)(3)(ii)(B) of this section.

(D) The falsification of any of the above certifications may subject the contractor or subcontractor to civil or criminal prosecution under section 1001 of title 18 and section 231 of title 31 of the United States Code.

(iii) The contractor or subcontractor shall make the records required under paragraph (a)(3)(i) of this section available for inspection, copying, or transcription by authorized representatives of the State, EPA or the Department of Labor, and shall permit such representatives to interview employees during working hours on the job. If the contractor or subcontractor fails to submit the required records or to make them available, the Federal agency or State may, after written notice to the contractor, sponsor, applicant, or owner, take such action as may be necessary to cause the suspension of any further payment, advance, or guarantee of funds. Furthermore, failure to submit the required records upon request or to make such records available may be grounds for debarment action pursuant to 29 CFR 5.12.

(4) Apprentices and trainees--

(i) Apprentices. Apprentices will be permitted to work at less than the predetermined rate for the work they performed when they are employed pursuant to and individually registered in a bona fide apprenticeship program registered with the U.S. Department of Labor, Employment and Training Administration, Office of Apprenticeship Training, Employer and Labor Services, or with a State Apprenticeship Agency recognized by the Office, or if a person is employed in his or her first 90 days of probationary employment as an apprentice in such an apprenticeship program, who is not individually registered in the program, but who has been certified by the Office of Apprenticeship Training, Employer and Labor Services or a State Apprenticeship Agency (where appropriate) to be eligible for probationary employment as an apprentice. The allowable ratio of apprentices to journeymen on the job site in any craft classification shall not be greater than the ratio permitted to the contractor as to the entire work force under the registered program. Any worker listed on a payroll at an apprentice wage rate, who is not registered or otherwise employed as stated above, shall be paid not less than the applicable wage rate on the wage determination for the classification of work actually performed. In addition, any apprentice performing work on the job site in excess of the ratio permitted under the registered program shall be paid not less than the applicable wage rate on the wage determination for the work actually performed. Where a contractor is performing construction on a project in a locality other than that in which its program is registered, the ratios and wage rates (expressed in percentages of the journeyman's hourly rate) specified in the contractor's or subcontractor's registered program shall be observed. Every apprentice must be paid at not less than the rate specified in the registered program for the apprentice's level of progress, expressed as a percentage of the journeymen hourly rate specified in the applicable wage determination. Apprentices shall be paid fringe benefits in accordance with the provisions of the apprenticeship program. If the apprenticeship program does not specify fringe benefits, apprentices must be paid the full amount of fringe benefits listed on the wage determination for the applicable classification. If the Administrator determines that a different practice prevails for the applicable apprentice classification, fringes shall be paid in accordance with that determination. In the event the Office of Apprenticeship Training, Employer and Labor Services, or a State Apprenticeship Agency recognized by the Office, withdraws approval of an apprenticeship program, the contractor will no longer be permitted to utilize apprentices at less than the applicable predetermined rate for the work performed until an acceptable program is approved.

(ii) Trainees. Except as provided in 29 CFR 5.16, trainees will not be permitted to work at less than the predetermined rate for the work performed unless they are employed pursuant to and individually registered in a program which has received prior approval, evidenced by formal certification by the U.S. Department of Labor, Employment and Training Administration. The ratio of trainees to journeymen on the job site shall not be greater than permitted under the plan approved by the Employment and Training Administration. Every trainee must be paid at not less than the rate specified in the approved program for the trainee's level of progress, expressed as a percentage of the journeyman hourly rate specified in the applicable wage determination. Trainees shall be paid fringe benefits in accordance with the provisions of the trainee program. If the trainee program does not mention fringe benefits, trainees shall be paid the full amount of fringe benefits listed on the wage determination unless the Administrator of the Wage and Hour Division determines that there is an apprenticeship program associated with the corresponding journeyman wage rate on the wage determination which provides for less than full fringe benefits for apprentices. Any employee listed on the payroll at a trainee rate who is not registered and participating in a training plan approved by the Employment and Training Administration shall be paid not less than the applicable wage rate on the wage determination for the classification of work actually performed. In addition, any trainee performing work on the job site in excess of the ratio permitted under the registered program shall be paid not less than the applicable wage rate on the wage determination for the work actually performed. In the event the Employment and Training Administration withdraws approval of a training program, the contractor will no longer be permitted to utilize trainees at less than the applicable predetermined rate for the work performed until an acceptable program is approved.

(iii) Equal employment opportunity. The utilization of apprentices, trainees and journeymen under this part shall be in conformity with the equal employment opportunity requirements of Executive Order 11246, as amended, and 29 CFR part 30.

- (5) Compliance with Copeland Act requirements. The contractor shall comply with the requirements of 29 CFR part 3, which are incorporated by reference in this contract.
- (6) Subcontracts. The contractor or subcontractor shall insert in any subcontracts the clauses contained in 29 CFR 5.5(a)(1) through (10) and such other clauses as the EPA determines may be appropriate, and also a clause requiring the subcontractors to include these clauses in any lower tier subcontracts. The prime contractor shall be responsible for the compliance by any subcontractor or lower tier subcontractor with all the contract clauses in 29 CFR 5.5.
- (7) Contract termination; debarment. A breach of the contract clauses in 29 CFR 5.5 may be grounds for termination of the contract, and for debarment as a contractor and a subcontractor as provided in 29 CFR 5.12.
- (8) Compliance with Davis-Bacon and Related Act requirements. All rulings and interpretations of the Davis-Bacon and Related Acts contained in 29 CFR parts 1, 3, and 5 are herein incorporated by reference in this contract.
- (9) Disputes concerning labor standards. Disputes arising out of the labor standards provisions of this contract shall not be subject to the general disputes clause of this contract. Such disputes shall be resolved in accordance with the procedures of the Department of Labor set forth in 29

CFR parts 5, 6, and 7. Disputes within the meaning of this clause include disputes between the contractor (or any of its subcontractors) and Subrecipient(s), State, EPA, the U.S. Department of Labor, or the employees or their representatives.

(10) Certification of eligibility.

(i) By entering into this contract, the contractor certifies that neither it (nor he or she) nor any person or firm who has an interest in the contractor's firm is a person or firm ineligible to be awarded Government contracts by virtue of section 3(a) of the Davis-Bacon Act or 29 CFR 5.12(a)(1).

(ii) No part of this contract shall be subcontracted to any person or firm ineligible for award of a Government contract by virtue of section 3(a) of the Davis-Bacon Act or 29 CFR 5.12(a)(1).

(iii) The penalty for making false statements is prescribed in the U.S. Criminal Code, 18 U.S.C. 1001.

**4. Contract Provision for Contracts in Excess of \$100,000.**

(a) Contract Work Hours and Safety Standards Act. The subrecipient shall insert the following clauses set forth in paragraphs (a)(1), (2), (3), and (4) of this section in full in any contract in an amount in excess of \$100,000 and subject to the overtime provisions of the Contract Work Hours and Safety Standards Act. These clauses shall be inserted in addition to the clauses required by Item 3, above or 29 CFR 4.6. As used in this paragraph, the terms laborers and mechanics include watchmen and guards.

(1) Overtime requirements. No contractor or subcontractor contracting for any part of the contract work which may require or involve the employment of laborers or mechanics shall require or permit any such laborer or mechanic in any workweek in which he or she is employed on such work to work in excess of forty hours in such workweek unless such laborer or mechanic receives compensation at a rate not less than one and one-half times the basic rate of pay for all hours worked in excess of forty hours in such workweek.

(2) Violation; liability for unpaid wages; liquidated damages. In the event of any violation of the clause set forth in paragraph (a)(1) of this section the contractor and any subcontractor responsible therefore shall be liable for the unpaid wages. In addition, such contractor and subcontractor shall be liable to the United States (in the case of work done under contract for the District of Columbia or a territory, to such District or to such territory), for liquidated damages. Such liquidated damages shall be computed with respect to each individual laborer or mechanic, including watchmen and guards, employed in violation of the clause set forth in paragraph (a)(1) of this section, in the sum of \$10 for each calendar day on which such individual was required or permitted to work in excess of the standard workweek of forty hours without payment of the overtime wages required by the clause set forth in paragraph (a)(1) of this section.

(3) Withholding for unpaid wages and liquidated damages. The subrecipient, upon written request of the EPA Award Official or an authorized representative of the Department of Labor, shall withhold or cause to be withheld, from any moneys payable on account of work performed by the contractor or subcontractor under any such contract or any other



Federal contract with the same prime contractor, or any other federally-assisted contract subject to the Contract Work Hours and Safety Standards Act, which is held by the same prime contractor, such sums as may be determined to be necessary to satisfy any liabilities of such contractor or subcontractor for unpaid wages and liquidated damages as provided in the clause set forth in paragraph (b)(2) of this section.

(4) Subcontracts. The contractor or subcontractor shall insert in any subcontracts the clauses set forth in paragraph (a)(1) through (4) of this section and also a clause requiring the subcontractors to include these clauses in any lower tier subcontracts. The prime contractor shall be responsible for compliance by any subcontractor or lower tier subcontractor with the clauses set forth in paragraphs (a)(1) through (4) of this section.

(b) In addition to the clauses contained in Item 3, above, in any contract subject only to the Contract Work Hours and Safety Standards Act and not to any of the other statutes cited in 29 CFR 5.1, the Subrecipient shall insert a clause requiring that the contractor or subcontractor shall maintain payrolls and basic payroll records during the course of the work and shall preserve them for a period of three years from the completion of the contract for all laborers and mechanics, including guards and watchmen, working on the contract. Such records shall contain the name and address of each such employee, social security number, correct classifications, hourly rates of wages paid, daily and weekly number of hours worked, deductions made, and actual wages paid. Further, the Subrecipient shall insert in any such contract a clause providing that the records to be maintained under this paragraph shall be made available by the contractor or subcontractor for inspection, copying, or transcription by authorized representatives of the (write the name of agency) and the Department of Labor, and the contractor or subcontractor will permit such representatives to interview employees during working hours on the job.

## **5. Compliance Verification**

(a) The subrecipient shall periodically interview a sufficient number of employees entitled to DB prevailing wages (covered employees) to verify that contractors or subcontractors are paying the appropriate wage rates. As provided in 29 CFR 5.6(a)(6), all interviews must be conducted in confidence. The subrecipient must use Standard Form 1445 (SF 1445) or equivalent documentation to memorialize the interviews. Copies of the SF 1445 are available from EPA on request.

(b) The subrecipient shall establish and follow an interview schedule based on its assessment of the risks of noncompliance with DB posed by contractors or subcontractors and the duration of the contract or subcontract. At a minimum, the subrecipient should conduct interviews with a representative group of covered employees within two weeks of each contractor or subcontractor's submission of its initial weekly payroll data and two weeks prior to the estimated completion date for the contract or subcontract. Subrecipients must conduct more frequent interviews if the initial interviews or other information indicates that there is a risk that the contractor or subcontractor is not complying with DB. Subrecipients shall immediately conduct necessary interviews in response to an alleged violation of the prevailing wage requirements. All interviews shall be conducted in confidence.

(c) The subrecipient shall periodically conduct spot checks of a representative sample of weekly payroll data to verify that contractors or subcontractors are paying the appropriate wage rates. The subrecipient shall establish and follow a spot check schedule based on its

assessment of the risks of noncompliance with DB posed by contractors or subcontractors and the duration of the contract or subcontract. At a minimum, if practicable, the subrecipient should spot check payroll data within two weeks of each contractor or subcontractor's submission of its initial payroll data and two weeks prior to the completion date the contract or subcontract. Subrecipients must conduct more frequent spot checks if the initial spot check or other information indicates that there is a risk that the contractor or subcontractor is not complying with DB. In addition, during the examinations the subrecipient shall verify evidence of fringe benefit plans and payments thereunder by contractors and subcontractors who claim credit for fringe benefit contributions.

(d) The subrecipient shall periodically review contractors and subcontractors use of apprentices and trainees to verify registration and certification with respect to apprenticeship and training programs approved by either the U.S Department of Labor or a state, as appropriate, and that contractors and subcontractors are not using disproportionate numbers of, laborers, trainees and apprentices. These reviews shall be conducted in accordance with the schedules for spot checks and interviews described in Item 5(b) and (c) above.

(e) Subrecipients must immediately report potential violations of the DB prevailing wage requirements to the EPA DB contact listed above and to the appropriate DOL Wage and Hour District Office listed at [https://www.dol.gov/whd/whd\\_district\\_offices.pdf](https://www.dol.gov/whd/whd_district_offices.pdf).

## **II. Requirements For Subrecipients That Are Not Governmental Entities**

The following terms and conditions specify how recipients will assist EPA in meeting its DB responsibilities when DB applies to EPA awards of financial assistance with respect to subrecipients that are not governmental entities. If a subrecipient has questions regarding when DB applies, obtaining the correct DB wage determinations, DB provisions, or compliance monitoring, it may contact the State recipient for guidance. If a State recipient needs guidance, the recipient may contact Valerie Marshall at EPA Region 1 (617-918-1674) for guidance. The recipient or subrecipient may also obtain additional guidance from DOL's web site at <https://www.dol.gov/whd/govcontracts/dbra.htm>

**Under these terms and conditions, the subrecipient must submit its proposed DB wage determinations to the State recipient for approval prior to including the wage determination in any solicitation, contract task orders, work assignments, or similar instruments to existing contractors.**

### **1. Applicability of the Davis- Bacon (DB) prevailing wage requirements.**

DB prevailing wage requirements apply to the construction, alteration, and repair of treatment works carried out in whole or in part with assistance made available by a State water pollution control revolving fund and to any construction project carried out in whole or in part by assistance made available by a drinking water treatment revolving loan fund. If a subrecipient encounters a unique situation at a site that presents uncertainties regarding DB applicability, the subrecipient must discuss the situation with the recipient State before authorizing work on that site.

### **2. Obtaining Wage Determinations.**

(a) Subrecipients must obtain proposed wage determinations for specific localities at [www.wdol.gov](http://www.wdol.gov). After the Subrecipient obtains its proposed wage determination, it must submit the wage determination to (insert contact information for State recipient DB point of contact for wage determination) for approval prior to inserting the wage determination into a solicitation, contract or issuing task orders, work assignments or similar instruments to existing contractors (ordering instruments unless subsequently directed otherwise by the State recipient Award Official).

(b) Subrecipients shall obtain the wage determination for the locality in which a covered activity subject to DB will take place prior to issuing requests for bids, proposals, quotes or other methods for soliciting contracts (solicitation) for activities subject to DB. These wage determinations shall be incorporated into solicitations and any subsequent contracts. Prime contracts must contain a provision requiring that subcontractors follow the wage determination incorporated into the prime contract.

(i) While the solicitation remains open, the subrecipient shall monitor [www.wdol.gov](http://www.wdol.gov) on a weekly basis to ensure that the wage determination contained in the solicitation remains current. The subrecipients shall amend the solicitation if DOL issues a modification more than 10 days prior to the closing date (i.e. bid opening) for the solicitation. If DOL modifies or supersedes the applicable wage determination less than 10 days prior to the closing date, the subrecipients may request a finding from the State recipient that there is not a reasonable time to notify interested contractors of the modification of the wage determination. The State recipient will provide a report of its findings to the subrecipient.

(ii) If the subrecipient does not award the contract within 90 days of the closure of the solicitation, any modifications or supersedes DOL makes to the wage determination contained in the solicitation shall be effective unless the State recipient, at the request of the subrecipient, obtains an extension of the 90 day period from DOL pursuant to 29 CFR 1.6(c)(3)(iv). The subrecipient shall monitor [www.wdol.gov](http://www.wdol.gov) on a weekly basis if it does not award the contract within 90 days of closure of the solicitation to ensure that wage determinations contained in the solicitation remain current.

(c) If the subrecipient carries out activity subject to DB by issuing a task order, work assignment or similar instrument to an existing contractor (ordering instrument) rather than by publishing a solicitation, the subrecipient shall insert the appropriate DOL wage determination from [www.wdol.gov](http://www.wdol.gov) into the ordering instrument.

(d) Subrecipients shall review all subcontracts subject to DB entered into by prime contractors to verify that the prime contractor has required its subcontractors to include the applicable wage determinations.

(e) As provided in 29 CFR 1.6(f), DOL may issue a revised wage determination applicable to a subrecipient's contract after the award of a contract or the issuance of an ordering instrument if DOL determines that the subrecipient has failed to incorporate a wage determination or has used a wage determination that clearly does not apply to the contract or ordering instrument. If this occurs, the subrecipient shall either terminate the contract or ordering instrument and issue a revised solicitation or ordering instrument or incorporate DOL's wage determination retroactive to the beginning of the contract or ordering instrument by change order. The subrecipient's contractor must be compensated for any increases in wages resulting from the use of DOL's revised wage determination.

### 3. Contract and Subcontract provisions.

(a) The Recipient shall insure that the subrecipient(s) shall insert in full in any contract in excess of \$2,000 which is entered into for the actual construction, alteration and/or repair, including painting and decorating, of a treatment work under the CWSRF or a construction project under the DWSRF financed in whole or in part from Federal funds or in accordance with guarantees of a Federal agency or financed from funds obtained by pledge of any contract of a Federal agency to make a loan, grant or annual contribution (except where a different meaning is expressly indicated), and which is subject to the labor standards provisions of any of the acts listed in § 5.1 or the FY 2011 Full-Year Continuing Appropriation, the following clauses:

(1) Minimum wages.

(i) All laborers and mechanics employed or working upon the site of the work, will be paid unconditionally and not less often than once a week, and without subsequent deduction or rebate on any account (except such payroll deductions as are permitted by regulations issued by the Secretary of Labor under the Copeland Act (29 CFR part 3) ), the full amount of wages and bona fide fringe benefits (or cash equivalents thereof) due at time of payment computed at rates not less than those contained in the wage determination of the Secretary of Labor which is attached hereto and made a part hereof, regardless of any contractual relationship which may be alleged to exist between the contractor and such laborers and mechanics. Contributions made or costs reasonably anticipated for bona fide fringe benefits under section 1(b)(2) of the Davis-Bacon Act on behalf of laborers or mechanics are considered wages paid to such laborers or mechanics, subject to the provisions of paragraph (a)(1)(iv) of this section; also, regular contributions made or costs incurred for more than a weekly period (but not less often than quarterly) under plans, funds, or programs which cover the particular weekly period, are deemed to be constructively made or incurred during such weekly period. Such laborers and mechanics shall be paid the appropriate wage rate and fringe benefits on the wage determination for the classification of work actually performed, without regard to skill, except as provided in §5.5(a)(4). Laborers or mechanics performing work in more than one classification may be compensated at the rate specified for each classification for the time actually worked therein: Provided, that the employer's payroll records accurately set forth the time spent in each classification in which work is performed. The wage determination (including any additional classification and wage rates conformed under paragraph (a)(1)(ii) of this section) and the Davis-Bacon poster (WH-1321) shall be posted at all times by the contractor and its subcontractors at the site of the work in a prominent and accessible place where it can be easily seen by the workers. Subrecipients may obtain wage determinations from the U.S. Department of Labor's web site, [www.dol.gov](http://www.dol.gov).

(ii)(A) The subrecipient(s), on behalf of EPA, shall require that any class of laborers or mechanics, including helpers, which is not listed in the wage determination and which is to be employed under the contract shall be classified in conformance with the wage determination. The State award official shall approve a request for an additional classification and wage rate and fringe benefits therefore only when the following criteria have been met:

(1) The work to be performed by the classification requested is not performed by a classification in the wage determination; and

(2) The classification is utilized in the area by the construction industry; and

(3) The proposed wage rate, including any bona fide fringe benefits, bears a reasonable relationship to the wage rates contained in the wage determination.

(B) If the contractor and the laborers and mechanics to be employed in the classification (if known), or their representatives, and the subrecipient(s) agree on the classification and wage rate (including the amount designated for fringe benefits where appropriate), documentation of the action taken and the request, including the local wage determination shall be sent by the subrecipient(s) to the State award official. The State award official will transmit the report, to the Administrator of the Wage and Hour Division, Employment Standards Administration, U.S. Department of Labor, Washington, DC 20210 and to the EPA DB Regional Coordinator concurrently. The Administrator, or an authorized representative, will approve, modify, or disapprove every additional classification request within 30 days of receipt and so advise the State award official or will notify the State award official within the 30-day period that additional time is necessary.

(C) In the event the contractor, the laborers or mechanics to be employed in the classification or their representatives, and the and the subrecipient(s) do not agree on the proposed classification and wage rate (including the amount designated for fringe benefits, where appropriate), the award official shall refer the request, and the local wage determination, including the views of all interested parties and the recommendation of the State award official, to the Administrator for determination. The request shall be sent to the EPA Regional Coordinator concurrently. The Administrator, or an authorized representative, will issue a determination within 30 days of receipt of the request and so advise the contracting officer or will notify the contracting officer within the 30-day period that additional time is necessary.

(D) The wage rate (including fringe benefits where appropriate) determined pursuant to paragraphs (a)(1)(ii)(B) or (C) of this section, shall be paid to all workers performing work in the classification under this contract from the first day on which work is performed in the classification.

(iii) Whenever the minimum wage rate prescribed in the contract for a class of laborers or mechanics includes a fringe benefit which is not expressed as an hourly rate, the contractor shall either pay the benefit as stated in the wage determination or shall pay another bona fide fringe benefit or an hourly cash equivalent thereof.

(iv) If the contractor does not make payments to a trustee or other third person, the contractor may consider as part of the wages of any laborer or mechanic the amount of any costs reasonably anticipated in providing bona fide fringe benefits under a plan or program, Provided, That the Secretary of Labor has found, upon the written request of the contractor, that the applicable standards of the Davis-Bacon Act have been met. The Secretary of Labor may require the contractor to set aside in a separate account assets for the meeting of obligations under the plan or program.

(2) Withholding. The subrecipient(s) shall upon written request of the EPA Award Official or an authorized representative of the Department of Labor, withhold or cause to be withheld from the contractor under this contract or any other Federal contract with the same prime contractor, or any other federally-assisted contract subject to Davis-Bacon prevailing wage requirements, which is held by the same prime contractor, so much of the accrued payments or advances as may be considered necessary to pay laborers and mechanics, including apprentices, trainees, and helpers, employed by the contractor or any subcontractor the full amount of wages required by the contract. In the event of failure to pay any laborer or mechanic, including any apprentice, trainee, or helper, employed or working on the site of the work, all or part of the wages required by the contract, the (Agency) may, after written notice to the contractor, sponsor, applicant, or owner, take such action as may be necessary to cause the suspension of any further payment, advance, or guarantee of funds until such violations have ceased.

(3) Payrolls and basic records.

(i) Payrolls and basic records relating thereto shall be maintained by the contractor during the course of the work and preserved for a period of three years thereafter for all laborers and mechanics working at the site of the work. Such records shall contain the name, address, and social security number of each such worker, his or her correct classification, hourly rates of wages paid (including rates of contributions or costs anticipated for bona fide fringe benefits or cash equivalents thereof of the types described in section 1(b)(2)(B) of the Davis-Bacon Act), daily and weekly number of hours worked, deductions made and actual wages paid. Whenever the Secretary of Labor has found under 29 CFR 5.5(a)(1)(iv) that the wages of any laborer or mechanic include the amount of any costs reasonably anticipated in providing benefits under a plan or program described in section 1(b)(2)(B) of the Davis-Bacon Act, the contractor shall maintain records which show that the commitment to provide such benefits is enforceable, that the plan or program is financially responsible, and that the plan or program has been communicated in writing to the laborers or mechanics affected, and records which show the costs anticipated or the actual cost incurred in providing such benefits. Contractors employing apprentices or trainees under approved programs shall maintain written evidence of the registration of apprenticeship programs and certification of trainee programs, the registration of the apprentices and trainees, and the ratios and wage rates prescribed in the applicable programs.

(ii)(A) The contractor shall submit weekly, for each week in which any contract work is performed, a copy of all payrolls to the subrecipient, that is, the entity that receives the sub-grant or loan from the State capitalization grant recipient. Such documentation shall be available on request of the State recipient or EPA. As to each payroll copy received, the subrecipient shall provide written confirmation in a form satisfactory to the State indicating whether or not the project is in compliance with the requirements of 29 CFR 5.5(a)(1) based on the most recent payroll copies for the specified week. The payrolls shall set out accurately and completely all of the information required to be maintained under 29 CFR 5.5(a)(3)(i), except that full social security numbers and home addresses shall not be included on the weekly payrolls. Instead the payrolls shall only need to include an individually identifying number for each employee (e.g., the last four digits of the employee's social security number). The required weekly payroll information may be submitted in any form desired. Optional Form WH-347 is

available for this purpose from the Wage and Hour Division Web site at <https://www.dol.gov/whd/forms/wh347.pdf> or its successor site. The prime contractor is responsible for the submission of copies of payrolls by all subcontractors. Contractors and subcontractors shall maintain the full social security number and current address of each covered worker, and shall provide them upon request to the subrecipient(s) for transmission to the State or EPA if requested by EPA, the State, the contractor, or the Wage and Hour Division of the Department of Labor for purposes of an investigation or audit of compliance with prevailing wage requirements. It is not a violation of this section for a prime contractor to require a subcontractor to provide addresses and social security numbers to the prime contractor for its own records, without weekly submission to the subrecipient(s).

(B) Each payroll submitted shall be accompanied by a "Statement of Compliance," signed by the contractor or subcontractor or his or her agent who pays or supervises the payment of the persons employed under the contract and shall certify the following:

- (1) That the payroll for the payroll period contains the information required to be provided under § 5.5 (a)(3)(ii) of Regulations, 29 CFR part 5, the appropriate information is being maintained under § 5.5 (a)(3)(i) of Regulations, 29 CFR part 5, and that such information is correct and complete;
- (2) That each laborer or mechanic (including each helper, apprentice, and trainee) employed on the contract during the payroll period has been paid the full weekly wages earned, without rebate, either directly or indirectly, and that no deductions have been made either directly or indirectly from the full wages earned, other than permissible deductions as set forth in Regulations, 29 CFR part 3;
- (3) That each laborer or mechanic has been paid not less than the applicable wage rates and fringe benefits or cash equivalents for the classification of work performed, as specified in the applicable wage determination incorporated into the contract.

(C) The weekly submission of a properly executed certification set forth on the reverse side of Optional Form WH-347 shall satisfy the requirement for submission of the "Statement of Compliance" required by paragraph (a)(3)(ii)(B) of this section.

(D) The falsification of any of the above certifications may subject the contractor or subcontractor to civil or criminal prosecution under section 1001 of title 18 and section 231 of title 31 of the United States Code.

(iii) The contractor or subcontractor shall make the records required under paragraph (a)(3)(i) of this section available for inspection, copying, or transcription by authorized representatives of the State, EPA or the Department of Labor, and shall permit such representatives to interview employees during working hours on the job. If the contractor or subcontractor fails to submit the required records or to make them available, the Federal agency or State may, after written notice to the contractor, sponsor, applicant, or owner, take such action as may be necessary to cause the suspension of any further payment, advance, or guarantee of funds. Furthermore, failure to submit the required records upon request or to make such records available may be grounds for debarment action pursuant to 29 CFR 5.12.

(4) Apprentices and trainees--

(i) Apprentices. Apprentices will be permitted to work at less than the predetermined rate for the work they performed when they are employed pursuant to and individually registered in a bona fide apprenticeship program registered with the U.S. Department of Labor, Employment and Training Administration, Office of Apprenticeship Training, Employer and Labor Services, or with a State Apprenticeship Agency recognized by the Office, or if a person is employed in his or her first 90 days of probationary employment as an apprentice in such an apprenticeship program, who is not individually registered in the program, but who has been certified by the Office of Apprenticeship Training, Employer and Labor Services or a State Apprenticeship Agency (where appropriate) to be eligible for probationary employment as an apprentice. The allowable ratio of apprentices to journeymen on the job site in any craft classification shall not be greater than the ratio permitted to the contractor as to the entire work force under the registered program. Any worker listed on a payroll at an apprentice wage rate, who is not registered or otherwise employed as stated above, shall be paid not less than the applicable wage rate on the wage determination for the classification of work actually performed. In addition, any apprentice performing work on the job site in excess of the ratio permitted under the registered program shall be paid not less than the applicable wage rate on the wage determination for the work actually performed. Where a contractor is performing construction on a project in a locality other than that in which its program is registered, the ratios and wage rates (expressed in percentages of the journeyman's hourly rate) specified in the contractor's or subcontractor's registered program shall be observed. Every apprentice must be paid at not less than the rate specified in the registered program for the apprentice's level of progress, expressed as a percentage of the journeymen hourly rate specified in the applicable wage determination. Apprentices shall be paid fringe benefits in accordance with the provisions of the apprenticeship program. If the apprenticeship program does not specify fringe benefits, apprentices must be paid the full amount of fringe benefits listed on the wage determination for the applicable classification. If the Administrator determines that a different practice prevails for the applicable apprentice classification, fringes shall be paid in accordance with that determination. In the event the Office of Apprenticeship Training, Employer and Labor Services, or a State Apprenticeship Agency recognized by the Office, withdraws approval of an apprenticeship program, the contractor will no longer be permitted to utilize apprentices at less than the applicable predetermined rate for the work performed until an acceptable program is approved.

(ii) Trainees. Except as provided in 29 CFR 5.16, trainees will not be permitted to work at less than the predetermined rate for the work performed unless they are employed pursuant to and individually registered in a program which has received prior approval, evidenced by formal certification by the U.S. Department of Labor, Employment and Training Administration. The ratio of trainees to journeymen on the job site shall not be greater than permitted under the plan approved by the Employment and Training Administration. Every trainee must be paid at not less than the rate specified in the approved program for the trainee's level of progress, expressed as a percentage of the journeyman hourly rate specified in the applicable wage determination. Trainees shall be paid fringe benefits in accordance with the provisions of the trainee program. If the trainee program does not mention fringe benefits, trainees shall be paid the full amount of



fringe benefits listed on the wage determination unless the Administrator of the Wage and Hour Division determines that there is an apprenticeship program associated with the corresponding journeyman wage rate on the wage determination which provides for less than full fringe benefits for apprentices. Any employee listed on the payroll at a trainee rate who is not registered and participating in a training plan approved by the Employment and Training Administration shall be paid not less than the applicable wage rate on the wage determination for the classification of work actually performed. In addition, any trainee performing work on the job site in excess of the ratio permitted under the registered program shall be paid not less than the applicable wage rate on the wage determination for the work actually performed. In the event the Employment and Training Administration withdraws approval of a training program, the contractor will no longer be permitted to utilize trainees at less than the applicable predetermined rate for the work performed until an acceptable program is approved.

(iii) Equal employment opportunity. The utilization of apprentices, trainees and journeymen under this part shall be in conformity with the equal employment opportunity requirements of Executive Order 11246, as amended, and 29 CFR part 30.

(5) Compliance with Copeland Act requirements. The contractor shall comply with the requirements of 29 CFR part 3, which are incorporated by reference in this contract.

(6) Subcontracts. The contractor or subcontractor shall insert in any subcontracts the clauses contained in 29 CFR 5.5(a)(1) through (10) and such other clauses as the EPA determines may be appropriate, and also a clause requiring the subcontractors to include these clauses in any lower tier subcontracts. The prime contractor shall be responsible for the compliance by any subcontractor or lower tier subcontractor with all the contract clauses in 29 CFR 5.5.

(7) Contract termination: debarment. A breach of the contract clauses in 29 CFR 5.5 may be grounds for termination of the contract, and for debarment as a contractor and a subcontractor as provided in 29 CFR 5.12.

(8) Compliance with Davis-Bacon and Related Act requirements. All rulings and interpretations of the Davis-Bacon and Related Acts contained in 29 CFR parts 1, 3, and 5 are herein incorporated by reference in this contract.

(9) Disputes concerning labor standards. Disputes arising out of the labor standards provisions of this contract shall not be subject to the general disputes clause of this contract. Such disputes shall be resolved in accordance with the procedures of the Department of Labor set forth in 29 CFR parts 5, 6, and 7. Disputes within the meaning of this clause include disputes between the contractor (or any of its subcontractors) and Subrecipient(s), State, EPA, the U.S. Department of Labor, or the employees or their representatives.

(10) Certification of eligibility.

(i) By entering into this contract, the contractor certifies that neither it (nor he or she) nor any person or firm who has an interest in the contractor's firm is a person or firm ineligible to be awarded Government contracts by virtue of section 3(a) of the Davis-Bacon Act or 29 CFR 5.12(a)(1).

(ii) No part of this contract shall be subcontracted to any person or firm ineligible for award of a Government contract by virtue of section 3(a) of the Davis-Bacon Act or 29 CFR 5.12(a)(1).

(iii) The penalty for making false statements is prescribed in the U.S. Criminal Code, 18 U.S.C. 1001.

#### **4. Contract Provision for Contracts in Excess of \$100,000.**

(a) Contract Work Hours and Safety Standards Act. The subrecipient shall insert the following clauses set forth in paragraphs (a)(1), (2), (3), and (4) of this section in full in any contract in an amount in excess of \$100,000 and subject to the overtime provisions of the Contract Work Hours and Safety Standards Act. These clauses shall be inserted in addition to the clauses required by Item 3, above or 29 CFR 4.6. As used in this paragraph, the terms laborers and mechanics include watchmen and guards.

(1) Overtime requirements. No contractor or subcontractor contracting for any part of the contract work which may require or involve the employment of laborers or mechanics shall require or permit any such laborer or mechanic in any workweek in which he or she is employed on such work to work in excess of forty hours in such workweek unless such laborer or mechanic receives compensation at a rate not less than one and one-half times the basic rate of pay for all hours worked in excess of forty hours in such workweek.

(2) Violation; liability for unpaid wages; liquidated damages. In the event of any violation of the clause set forth in paragraph (b)(1) of this section the contractor and any subcontractor responsible therefore shall be liable for the unpaid wages. In addition, such contractor and subcontractor shall be liable to the United States (in the case of work done under contract for the District of Columbia or a territory, to such District or to such territory), for liquidated damages. Such liquidated damages shall be computed with respect to each individual laborer or mechanic, including watchmen and guards, employed in violation of the clause set forth in paragraph (b)(1) of this section, in the sum of \$10 for each calendar day on which such individual was required or permitted to work in excess of the standard workweek of forty hours without payment of the overtime wages required by the clause set forth in paragraph (b)(1) of this section.

(3) Withholding for unpaid wages and liquidated damages. The subrecipient shall upon the request of the EPA Award Official or an authorized representative of the Department of Labor, withhold or cause to be withheld, from any moneys payable on account of work performed by the contractor or subcontractor under any such contract or any other Federal contract with the same prime contractor, or any other federally-assisted contract subject to the Contract Work Hours and Safety Standards Act, which is held by the same prime contractor, such sums as may be determined to be necessary to satisfy any liabilities of such contractor or subcontractor for unpaid wages and liquidated damages as provided in the clause set forth in paragraph (b)(2) of this section.

(4) Subcontracts. The contractor or subcontractor shall insert in any subcontracts the clauses set forth in paragraph (b)(1) through (4) of this section and also a clause requiring the subcontractors to include these clauses in any lower tier subcontracts. The prime contractor shall be responsible for compliance by any subcontractor or lower tier subcontractor with the clauses set forth in paragraphs (b)(1) through (4) of this section.

(c) In addition to the clauses contained in Item 3, above, in any contract subject only to the Contract Work Hours and Safety Standards Act and not to any of the other statutes cited in 29 CFR 5.1, the Subrecipient shall insert a clause requiring that the contractor or subcontractor shall maintain payrolls and basic payroll records during the course of the work and shall preserve them for a period of three years from the completion of the contract for all laborers and mechanics, including guards and watchmen, working on the contract. Such records shall contain the name and address of each such employee, social security number, correct classifications, hourly rates of wages paid, daily and weekly number of hours worked, deductions made, and actual wages paid. Further, the Subrecipient shall insert in any such contract a clause providing that the records to be maintained under this paragraph shall be made available by the contractor or subcontractor for inspection, copying, or transcription by authorized representatives of the (write the name of agency) and the Department of Labor, and the contractor or subcontractor will permit such representatives to interview employees during working hours on the job.

## **5. Compliance Verification**

(a). The subrecipient shall periodically interview a sufficient number of employees entitled to DB prevailing wages (covered employees) to verify that contractors or subcontractors are paying the appropriate wage rates. As provided in 29 CFR 5.6(a)(6), all interviews must be conducted in confidence. The subrecipient must use Standard Form 1445 (SF 1445) or equivalent documentation to memorialize the interviews. Copies of the SF 1445 are available from EPA on request.

(b) The subrecipient shall establish and follow an interview schedule based on its assessment of the risks of noncompliance with DB posed by contractors or subcontractors and the duration of the contract or subcontract. At a minimum, the subrecipient should conduct interviews with a representative group of covered employees within two weeks of each contractor or subcontractor's submission of its initial weekly payroll data and two weeks prior to the estimated completion date for the contract or subcontract. Subrecipients must conduct more frequent interviews if the initial interviews or other information indicates that there is a risk that the contractor or subcontractor is not complying with DB. Subrecipients shall immediately conduct necessary interviews in response to an alleged violation of the prevailing wage requirements. All interviews shall be conducted in confidence.

(c). The subrecipient shall periodically conduct spot checks of a representative sample of weekly payroll data to verify that contractors or subcontractors are paying the appropriate wage rates. The subrecipient shall establish and follow a spot check schedule based on its assessment of the risks of noncompliance with DB posed by contractors or subcontractors and the duration of the contract or subcontract. At a minimum, if practicable the subrecipient should spot check payroll data within two weeks of each contractor or subcontractor's submission of its initial payroll data and two weeks prior to the completion date the contract or subcontract. Subrecipients must conduct more frequent spot checks if the initial spot check or other information indicates that there is a risk that the contractor or subcontractor is not complying with DB . In addition, during the examinations the subrecipient shall verify evidence of fringe benefit plans and payments thereunder by contractors and subcontractors who claim credit for fringe benefit contributions.

(d). The subrecipient shall periodically review contractors and subcontractors use of apprentices and trainees to verify registration and certification with respect to apprenticeship and training programs approved by either the U.S Department of Labor or a state, as appropriate, and that contractors and subcontractors are not using disproportionate numbers of, laborers, trainees and apprentices. These reviews shall be conducted in accordance with the schedules for spot checks and interviews described in Item 5(b) and (c) above.

(e) Subrecipients must immediately report potential violations of the DB prevailing wage requirements to the EPA DB contact listed above and to the appropriate DOL Wage and Hour District Office listed at [https://www.dol.gov/whd/whd\\_district\\_offices.pdf](https://www.dol.gov/whd/whd_district_offices.pdf).

## EXHIBIT B

### GENERAL TERMS AND CONDITIONS

#### 1 WORK OF THE SUBCONTRACTOR

- 1.1 All Work shall be performed in accordance with sound and generally accepted professional practices and industry standards by professional, managerial, and administrative personnel fully qualified in the respective professional disciplines required and practicing under similar circumstances at the same time and in the same locality.
- 1.2 In performing the Work hereunder, Subcontractor shall:
  - (a) Have the complete professional, managerial, or technical responsibility for the validity, accuracy, and reliability of the Work performed, and its work shall conform to all applicable codes, standards, statutes, rules and regulations and the Work criteria and definition;
  - (b) Designate a Manager, in charge of the entire Work on a continuous basis with responsibility for providing adequate supervision or direction and having authority to take all action that may be required in performance of this Agreement. When required by state law, such individual shall have an appropriate engineering license or other appropriate registration;
  - (c) Comply with all government, state and local laws, ordinances, codes or regulations which apply to performance of the Work;
  - (d) Be properly licensed in the governmental jurisdiction where the Work is being performed and where the Project is located and secure at its own expense, all necessary licenses, permits, registrations, certificates and such other documents which may be required by the appropriate governmental authority or authorities to perform the Work.
- 1.3 All Subcontractor's personnel shall be subject to the review and approval by Company. Subcontractor shall immediately remove from the Project any personnel designated by Company; and Subcontractor shall hold harmless Company on account of such action. Subcontractor shall not remove or reassign its Manager in charge of the Work or its other Key Personnel designated in this Agreement without the prior written approval of Company, unless such personnel are no longer employed by Subcontractor.
- 1.4 The Work shall be performed at locations satisfactory to Company and such locations shall not be changed without the written approval of Company. Company shall have access at all times to the locations where Work is performed and to all of the drawings, specifications, data, calculations, models, test results and specimens, documents and other things related to the Work or the Project.
- 1.5 Subcontractor shall be responsible for the professional quality, technical accuracy and timely completion of its services furnished under this Agreement. In the event Subcontractor's services hereunder should not prove satisfactory to Company or Client, as a result of human error, omission or otherwise, Subcontractor shall, without additional compensation, and at its own cost and expense, remedy the defective services and the consequences thereof, provided such corrective services are requested in writing by Company or Client, within the period of warranty for such corrective Work as required by Client of Company under the Prime Contract executed by and between Client and Company.
- 1.6 Review and approval by Company of Subcontractor's drawings, samples, or other representations shall not relieve Subcontractor of the obligation to complete the entire Work in strict compliance with the requirements of this Agreement and to represent to Company that the Work will be sufficient and adequate to fulfill the purposes of the Project, and satisfy all applicable obligations and requirements of Company under the Prime Contract.

## 2 SCHEDULE AND DELAYS

- 2.1 Time is of the essence in this Agreement. Subcontractor agrees to commence the Work promptly when directed by Company and to prosecute the Work diligently to completion. Subcontractor shall schedule its services in compliance with Company's directions and consistent with the Project schedule. The schedule for the Work shall be subject to revision by Company to coordinate the overall Project progress. In the event the Work is delayed, Company may direct the Subcontractor to supplement its labor force, add equipment, or work overtime at Subcontractor's expense in order to alleviate any delay.
- 2.2 Delays caused solely by Company, its Client, or incurred as a result of "Force Majeure" which shall only include acts of God, fire, labor strikes or picketing, epidemic, pandemic, and unseasonable weather shall be excusable and shall entitle Subcontractor to an extension of the Project schedule, but there shall be no adjustment in the Subcontractor's compensation. Company will determine the normal working hours for the Work and overtime shall be subject to Company's prior written approval.
- 2.3 If the Prime Contract imposes the risk of penalties or liquidated or other damages on Company for delays, then, to the extent such penalties or damages are imposed on Company because of delays within the control of Subcontractor, then Subcontractor shall defend, hold harmless, and indemnify Company against such penalties or damages.

## 3 PERMITS

Subcontractor shall be solely responsible for acquiring and maintaining, at its own cost, any and all permits, licenses, easements, waivers and permissions of every nature necessary to perform the Works in full compliance with any applicable laws and/or regulations.

## 4 CHARGES AND PAYMENT CONDITIONS

- 4.1 Subcontractor agrees to provide such supporting documentation for each invoice as Company may reasonably require. Company's payment terms are NET 30 (i.e., undisputed amount paid within thirty (30) days after receipt of a correct invoice, which references the Company's Purchase Order Number). Payment of any invoice by Company shall not imply inspection, approval, or acceptance of the Work by Company or Client.

Subcontractor shall bear the risk of Client's insolvency, non-payment, and dispute of amounts invoiced. In the event of non-payment by Client, Company shall not be obligated to make payment to Subcontractor, but both parties shall cooperate in seeking payment from Client. **It is expressly acknowledged that receipt of payment by Company from the Client on account of the work performed by the Subcontractor shall be a condition precedent to any obligation by Company to make any payment to the Subcontractor hereunder.**

The final milestone payment invoice, not less than 10% of the Agreement Price, shall be paid upon completion and acceptance of the Work by Company and Client. Payment of any invoice by Company shall not imply review, approval, or acceptance of the Work by Company.

- 4.2 Subcontractor shall certify to Company in writing at the time of submittal of each invoice that all sub-subcontractors, subconsultants and suppliers have been paid for work and material from previous progress payments received, prior to receipt of any further progress payments. This provision in no way creates any contractual relationship between any sub-subcontractor, subconsultant or supplier and Company or any liability on Company for the Subcontractor's failure to make timely payments to them.
- 4.3 As a condition precedent to Company's final payment under this Agreement, Subcontractor shall furnish certifications, satisfactory to Company, that state that no liens of any kind, including, but not limited to, mechanics' liens or other claims arising directly or indirectly out of any act or omission of Subcontractor or any of its subconsultants, sub-subcontractors or suppliers, have been made or attached against the Work or upon any property owned by Company or its Client. Company at any

time, without notice, may pay and discharge liens, claims, and encumbrances filed by Subcontractor's sub-subcontractors or suppliers and deduct the amount paid, together with costs and attorneys' fees, from compensation due Subcontractor hereunder.

- 4.4 The acceptance by Subcontractor of the final payment under this Agreement shall constitute and operate as a release to Company for all claims and liability to Subcontractor, its representatives, subconsultants, sub-subcontractors, supplies and assigns for any additional compensation or payment relating to any and all things done or furnished to the services rendered by Subcontractor. However, final payment shall in no way relieve the Subcontractor of liability for its obligations or for faulty or defective work discovered after final payment.
- 4.5 The compensation to be paid to Subcontractor includes, and Subcontractor shall be liable for and shall pay, and shall defend, hold harmless, and indemnify Company against, all taxes, contributions, interest accrued, penalties imposed, and all taxes, excises, assessments, and other charges levied by any government agent, authority, or any other jurisdictional body on, or because of, the services performed hereunder or any labor, materials, supplies, or services furnished for or used in the performance of the Work.

## **5 CHANGES AND ADDITIONAL COMPENSATION**

- 5.1 Company, by written order (hereinafter "Change Order"), may make changes in the Work including, but not limited to, increasing or decreasing the Work or directing acceleration in the performance of the Work. Where practicable, Company and Subcontractor shall negotiate, prior to the issuance of a Change Order, the amount of any charge for increases or decreases in the Work or schedule change related to the Change Order. In the event the parties cannot agree, Company may issue the Change Order and the Subcontractor shall proceed with the Work, being compensated for the change in Work on a cost reimbursable basis as set forth in Article 4.2.
- 5.2 No change shall be made by Subcontractor in the Work or its manner of performance, without prior instructions from Company, in a written Change Order specifying the change in plans, specifications, procedures, schedule, sequence, or other requirements of this Agreement, and specifying whether there is to be an adjustment in the price for performance and how any such adjustment shall be determined. No adjustment in price or time of performance shall be made for changes in arrangement, aesthetics, substitution of equivalent materials, or equipment or other changes, unless such changes significantly affect Subcontractor's cost of performing the Work. An equitable adjustment will be made in price or time of performance or both, if the change ordered by Company substantially increases or decreases the cost and/or time of performance of the Work. The method of changing the price shall be specified in the Change Order. In the event a Change Order does not specify pricing for services, Subcontractor shall be paid all actual, direct additional cost incurred, without allocation of its home office general and administrative expense, plus ten percent (10%) of such costs, and Subcontractor shall maintain and furnish Company accurate and detailed records daily segregating the cost of the change in the Work. In case of deletion or reduction of the Work by such change, Subcontractor shall not be entitled to anticipated contribution to its home office overhead and profit from any portion of the Work not performed.
- 5.3 Whenever an event occurs or condition arises which Subcontractor considers to constitute a basis for additional compensation or time, and Company has not issued a Change Order, Subcontractor shall so notify Company immediately by telephone, and confirm in writing within five (5) business days, after the occurrence of the event or discovery of the condition, requesting Company to issue a Change Order under the procedure set forth above and forwarding adequate supporting information to substantiate Subcontractor's position. Subcontractor shall not proceed with respect to the event or condition forming the subject of the claim until advised in writing, or orally and confirmed in writing, by Company to do so. Company's liability to Subcontractor for any such events or conditions shall be limited to any sums or extension of time obtained from Client therefor.
- 5.4 Upon receipt of the notice from Subcontractor, Company shall either initiate the Change Order procedure or give other instructions by telephone or in writing, as appropriate. If Company orders Subcontractor to proceed and concludes that no Change Order is warranted, the disagreement shall

constitute a dispute and Subcontractor shall proceed in accordance with Company's instructions. The dispute shall be resolved in accordance with Article 19.0 Disputes.

## **6 INDEMNIFICATION**

Subcontractor releases and agrees to indemnify and defend Company, its Client, their officers, directors, and employees from and against any and all suits, actions, claims, demands, damages, liabilities, interest, attorney's fees, costs, and expenses of whatsoever kind, including those arising out of injury, disease, or death of Subcontractor's employees in any manner directly or indirectly caused, occasioned, or contributed to in whole or in part, or claimed to be caused, occasioned, or contributed to in whole or in part, by reason of any act, omission, fault, or negligence whether active or passive of Subcontractor, its subconsultants or sub-subcontractors, or of anyone acting under its direction or control. Subcontractor's aforesaid release and indemnity shall apply in the event of joint or contributory negligence, whether active or passive, or strict liability of Company or its Client to the fullest extent permitted by law, but in no event shall the release and indemnity obligation apply to liability caused by the willful misconduct or sole negligence of the party released or indemnified.

## **7 SAFETY**

- 7.3 Subcontractor shall be responsible for the health and safety of its employees and the employees of its subconsultants and sub-subcontractors, if any, while present at the Subcontractor's home and branch offices and other locations where Work is performed. While performing Work on Company's or Client's property and/or at Project Sites, Subcontractor shall place the highest priority on safety and safe working practices. Therefore, it will be the responsibility of Subcontractor to provide and maintain a safe working environment for its employees while working on Company's or Client's property and/or Project Sites and to protect the health and safety of Subcontractor's employees, agents and subconsultants and sub-subcontractors and their respective employees, and Company employees, the public and other third parties. All tools, equipment, facilities, and other items used by Subcontractor and practices employed by Subcontractor in accomplishing the Work are considered to be part of the working environment.
- 7.4 Subcontractor shall comply with all applicable laws, rules and regulations relating to health and safety, including but not limited to, those set forth in the Occupational Health and Safety Act, as amended (OSHA).
- 7.5 Whenever Subcontractor has any employees at the site of the Work, either temporarily on visits or on assigned basis, Subcontractor shall comply with all of the regulations and directives of Company and/or the Client with respect to safety, security, entrances, parking areas, sanitation, and other provisions for maintenance of good order and coordination of the activities of all participants in the Work as a whole.

## **8 DOCUMENTS**

- 8.1 The Work and all records relating to it, including, without limitation, all drawings, specifications, reports, summaries, samples, photographs, memoranda, notes, calculations, and other documents developed by Subcontractor during the period of performance of this Project is work product and shall be deemed to be the property of Company or Client. Subcontractor shall maintain all such materials in kind, or on microfilm, except for samples, for a period of not less than two (2) years after completion of the Work, or for such longer time as may be required by the Prime Contract.
- 8.2 All dimensions in notes and drawings prepared in the performance of the services specified in this Agreement shall be in the foot/pound system, unless otherwise required or approved by Company.
- 8.3 Subcontractor shall return to Company all drawings and written materials furnished to Subcontractor by Company, including all copies thereof, if any, made by Subcontractor, except that Subcontractor may retain one copy of the same in its files for record purposes only.



- 8.4 Subcontractor will limit access to Company's and Client's confidential and technical information to Subcontractor's employees who reasonably require such access for performance of Work pursuant to this Agreement.

## **9 PATENTS AND COPYRIGHTS**

- 9.1 If Subcontractor or its personnel make any inventions or prepare copyrightable material as a result of the performance of this Agreement, Subcontractor promptly shall disclose such inventions or materials to Company. Subcontractor agrees to grant, and hereby grants, to Company the entire right, title, and interest in and to such inventions and copyrightable materials, and Subcontractor shall cooperate with Company and execute all documents necessary to perfect Company's rights in the inventions or materials and to allow Company to prosecute and obtain patents and copyrights thereon.
- 9.2 Subcontractor shall indemnify and hold harmless Company and Client against any loss, cost or liability for infringement of any period or proprietary rights involving any services furnished hereunder.

## **10 CONFIDENTIALITY AND NONDISCLOSURE**

Subcontractor shall not disclose information regarding this Agreement or the Work, except for information that is required for the purposes of the performance of Work or in the public domain, to any person. Noncompliance by the Subcontractor or others under the control or direction of the Subcontractor with this obligation shall be sufficient cause for Company immediately to terminate this Agreement for cause without prior written notice, and shall entitle Company to injunctive and other relief from a court of competent jurisdiction. In addition, Subcontractor agrees to comply with any more restrictive confidentiality requirements imposed by Client in the Prime Contract.

## **11 AUDIT**

Not Used

## **12 INSPECTION AND NON-WAIVER**

- 12.1 Subcontractor shall permit representatives of Company to inspect and observe the Work at all reasonable times, and all Work shall be subject to acceptance and approval by Company. However, the exercise of any such rights shall not relieve Subcontractor of its responsibility to perform the Work in accordance with all Agreement requirements.
- 12.2 The failure of Company to insist upon strict performance of any of the terms of this Agreement or to exercise any rights conferred by this Agreement shall not be construed as a waiver of its right to assert or rely on any such terms or rights on any future occasion or as a waiver of any other terms or rights.

## **13 REMEDIES UPON DEFAULT**

In addition to any rights provided by any other provisions of this Agreement or any applicable law, Company shall have the right to retain any money in its possession due to the Subcontractor under this Agreement so as to reimburse Company for any damage or costs caused by or attributable to the acts or omissions of the Subcontractor with respect to this Agreement or any other subcontract or contract between the parties including, but not limited to, Subcontractor's late completion, breach of warranty, breach of guarantees, negligence or any other contractual breach. Failure to withhold payment shall in no event be construed as a waiver of any right of Company to assert any claim for breach of any obligation under this or any other agreement between the parties.

## **14 WARRANTY**

- 14.1 Subcontractor warrants that all Works will be as represented by Subcontractor, free from defects in materials, workmanship, and design, in conformance with all applicable specifications, descriptions,

samples, and drawings referred to in this Agreement and in Order(s), merchantable and fit for their intended purposes.

- 14.2 Subcontractor warrants that the production, packaging, labeling and transportation of all goods will comply with all applicable national, regional, state and local laws, rules, regulations, ordinances and orders.
- 14.3 Subcontractor warrants that it has the experience and ability as may be necessary to perform all Works with a high standard of quality and that all Works will be performed in a workmanlike, professional manner and in accordance with the highest standards in the industry.
- 14.4 Subcontractor warrants that it will make all appropriate tax payments and tax withholdings for all individuals it provides to perform Works and, in the case of Works performed in the United States of America, will verify such individuals as being legally able to work in the United States.
- 14.5 All warranties will survive inspection, testing and acceptance of the Works and expiration or termination of this Agreement.
- 14.6 All warranties are considered independent. Each will be separately construed and interpreted without reference to any other warranty.

## **15 TERMINATION AND SUSPENSION**

**15.1 Termination for Convenience.** Company, by ten (10) days written notice, may terminate this Agreement in whole or part for any reason, including solely for its convenience. Subcontractor will be paid for reasonable costs of all work performed including a reasonable overhead and profit. No money will be paid for interruption of business or loss of business opportunities, for overhead and profit on Work not completed, or for any other intangible costs. In no event shall the total sums paid Subcontractor exceed the Agreement price.

**15.2 Termination for Cause.** If, in the reasonable opinion of Company, the Subcontractor shall at any time, (1) fail in any material respect to prosecute timely the Work, (2) fail to comply with any material provision of this Agreement, (3) make a general assignment for the benefit of its creditors, (4) have a receiver appointed, or (5) become insolvent, then, after serving seven (7) days written notice, unless the condition specified in such notice shall have been eliminated within seven (7) days, Company, at its option and without voiding the other provisions of this Agreement, may, after an additional seven (7) days, (i) take such steps as are necessary to overcome the condition, in which case the Subcontractor shall be liable to Company for any cost hereof, or (ii) partially or wholly terminate for default the Subcontractor's continued performance of its duties under this Agreement. In the event of a termination for default, Company may, at its option, use all of Subcontractor's work product for completion of the Work by others, take assignment of any or all of the Subcontractor's agreements with subconsultants, sub-subcontractors or suppliers and/or have the remainder of the Subcontractor's obligations completed by whatever means Company deems expedient. In case of a termination for default, the Subcontractor shall not be entitled to receive any further payment until the Work shall be fully completed and accepted by Company and the Client and payment made in full by the Client at which point the Subcontractor shall be paid the remainder of its fee less any costs or expenses incurred by Company as a result of Company taking any steps necessary to overcome the deficiency or complete the Subcontractor's duties hereunder.

### **15.3 Suspension.**

- (a) Company may order Subcontractor, in writing, to suspend, interrupt or defer all or any part of its Work for such period of time as may be appropriate to the convenience of Company and/or Client.
- (b) If the performance of all or any part of Subcontractor's Work is suspended, interrupted or deferred by the direction of Company for a period greater than ninety (90) continuous days, an equitable adjustment shall be made for any increase in the cost of affected Work and the

schedule of such affected Work shall be adjusted in accordance with the provisions of this Agreement. However, no adjustments shall be made for any such suspension, interruption or deferment whereby performance would have been so suspended, interrupted or deferred by any other cause, including the fault or negligence of Subcontractor, or whereby an equitable adjustment is provided for or excluded under any other provision of this Agreement. Should any such suspension, interruption or deferment be directed by the Client, any equitable adjustment in cost and/or schedule adjustment, subject to the provisions of this Article, Subcontractor shall be compensated therefor only to the extent Company can recover such cost and/or schedule adjustment from the Client.

- (c) No claim hereunder shall be allowed unless such claim, in an amount stated, is asserted in writing within fifteen (15) days after termination of such suspension, delay or interruption, but in no case later than the date of Final Payment.

## **16 INDEPENDENT CONTRACTOR, NON- ASSIGNMENT, AND SUBCONTRACTS**

- 16.1 In the performance of the Work, Subcontractor shall operate as, and have the status of, an independent contractor and shall not act as or be an agent or employee of Company or its Client. As an independent contractor, Subcontractor shall be solely responsible for executing the Work.
- 16.2 Subcontractor shall not assign this Agreement without the prior written consent of Company. After assignment, this Agreement shall inure to the benefit of, and shall be binding upon, Company's and Subcontractor's respective successors and assigns. Subcontractor shall notify Company in writing of each subconsultant or sub-subcontractor it intends to use before entering into a subcontract. None of the Work may be subcontracted by Subcontractor without the prior written approval of Company.
- 16.3 Each subcontract with a subconsultant or sub-subcontractor must contain provisions, or be made expressly subject to provisions, for changes, notice, indemnification, insurance, nondisclosure and confidentiality, patents and inventions, documents, termination, suspension, dispute resolution, inspection and non-waiver, ethics and gratuities, employment practices, audit, liens and encumbrances, at least as restrictive in form and content as those contained or referred to in this Agreement. Subcontractor shall advise each prospective subconsultant or sub-subcontractor of these requirements and shall ensure that each subconsultant or sub-subcontractor complies with them.

## **17 TRUTH IN NEGOTIATIONS REPRESENTATIONS**

- 17.1 Subcontractor warrants that sub-subcontractor has not employed or retained any company or person other than a bona fide employee working solely for Subcontractor, to solicit or secure this Agreement and that has not paid or agreed to pay any person, company, corporation, individual or firm, other than a bona fide employee working solely for subcontractor, any fee, commission, percentage, gift or any other consideration contingent upon or resulting from the award or making of this Agreement.
- 17.2 Subcontractor warrants that the prices for the Work sold Company hereunder are not less favorable than those currently extended to any other customer of Subcontractor for the same or similar services in similar quantities. Subcontractor further warrants that wage rates and other factual unit costs supporting the compensation are accurate, complete and current at the time of the Agreement. The Subcontractor agrees that the original Agreement price and any additions thereto shall be adjusted to exclude any significant sums by which Company or Client determines the Agreement price was increased due to inaccurate, incomplete, or non-current wage rates and other factual unit costs.

## **18 ETHICS AND GRATUITIES**

The Subcontractor represents and warrants that in connection with its performance of this Agreement, it has not or will not, directly or indirectly, pay, give, offer, promise to pay or give, or authorize the payment or giving of any money, gift, or things of value to any governmental official, political party, or candidate for political office; or to any person who knowingly will give all or a portion of the money, gift, or thing of value to any such official in its official capacity. Breach of this

representation or warranty shall be considered a default under the terms of this Agreement and shall, in addition to any other remedies, entitle Company to recover all amounts paid to Subcontractor under this Agreement.

## **19 EMPLOYMENT PRACTICES**

Subcontractor shall not discriminate against any employee or applicant for employment or applicant for employment because of race, color, national origin, religion, sex, age or for any reason prohibited by law. To the extent applicable to the Work on this Project, Subcontractor shall comply with Executive Order 11246 or any amendment, replacement or counterpart thereof.

## **20 COMMUNICATIONS AND NOTICES**

- 20.1 All inquiries the Subcontractor may have concerning this Agreement shall be made to Company and not directly to the Client.
- 20.2 All of Subcontractor's correspondence/ communication regarding this Agreement shall include Company's Agreement Number and Work Description, and shall be mailed or delivered to Company's Designated Representative.
- 20.3 Notices of changes, deficiencies, delays, claims or disputes shall be in writing, and shall furnish full information to the extent available. The party notified will acknowledge receipt by endorsement of a copy if requested or will otherwise confirm receipt in writing. To avoid difficulty in delivery of Notice, sufficient Notice shall be deemed to have been given by mailing via Registered or Certified Mail or equivalent to the Site address shown on page 1 of this Agreement.

## **21 DISPUTES**

- 21.1 The Parties agree to attempt to resolve disputes through informal mediation. The Parties may pursue their respective remedies at law or equity for any claim, controversy, or dispute relating to this Agreement, except as follows: Subcontractor acknowledges that the Prime Contract may include a disputes resolution clause pursuant to which Company may be limited to certain dispute resolution procedures such as arbitration or administrative proceedings in the event of a dispute relating to the Prime Contract. In the event that such provisions govern disputes between Company and its Client, Subcontractor agrees to be bound by the procedures in the Prime Contract with respect to disputes under this Agreement in the same manner that Company is bound under the terms of the Prime Contract. Subcontractor consents to joinder in any proceedings between Company and its Client upon Company's request. Subcontractor shall not have the right to join in proceedings between Company and the Client unless Company consents to the joinder.
- 21.2 The Subcontractor shall carry on the Work and maintain the Project schedule during any dispute proceedings, unless otherwise instructed by Company.

## **22 GOVERNING LAW**

This Agreement shall be governed by and construed in accordance with the laws of the jurisdiction in which the Project is located.

## **23 SETOFF**

Company is authorized to deduct any sums owed it by Subcontractor (whether or not the debt arises out of this Agreement) from the payments due Subcontractor under this Agreement. Company may also withhold payment from Subcontractor in an amount sufficient to protect Company from any claims of third parties or any liens which arise as a result of Subcontractor's or its subconsultants' and sub-subcontractors' performance of the Work.

## **24 SURVIVAL**

The warranty, liability, indemnity, audit, ownership of work product, patent, and confidentiality (including publicity releases) provisions of this Agreement shall survive its termination or final settlement. The provisions of this Agreement relating to termination and settlement of disputes and claims (including choice of law) shall survive its termination, but not its final settlement.

## **25 SEVERABILITY**

Any provisions of this Agreement held in violation of any law or ordinance shall be deemed stricken, and all remaining provisions shall continue to be valid and binding upon the Parties. Company and Subcontractor shall in good faith attempt to replace any invalid or unenforceable provisions of this Agreement with provisions that are valid and enforceable and that come as close as possible to expressing the intention of the original provisions.

## **26 REMEDIES**

The remedies reserved for Company herein shall be cumulative and additional to any other or further remedies provided in law or equity. Any waiver by Company of any provision of this Agreement shall not constitute a waiver of any other provisions of the Agreement.

## **27 HEADINGS**

The descriptive headings at the beginning of the articles, clauses, and subclauses of this Agreement are provided for convenience only and do not affect the interpretation or construction of this Agreement. In some instances an article or clause contains provisions not covered by the heading hereof, in other instances an article or clause contains provisions that are described in the heading of another article or clause.

**EXHIBIT C**  
**COMPENSATION**

**1.0 AGREEMENT PRICE**

- 1.1 Company shall pay Subcontractor for complete, satisfactory and timely performance of the Work in strict accordance with the requirements hereof, the following firm fixed price, which excludes all applicable taxes and which is not subject to escalation: \$\_\_\_\_\_.
- 1.2 Change Orders
- 1.1. As allowed in DEP's Policy Memorandum #10 - the agreed upon DIRECT LABOR MARKUP (percentage) for Change Orders on this project shall be \_\_\_\_\_%. The "direct labor mark-up" rate shall account for the cost of Worker's Compensation Insurance, Federal Social Security and State Unemployment Compensation.
- 1.2. The agreed-upon mark-up for Overhead and Profit (OH&P) on this project shall be 15 percent (15%).
- 1.3. The agreed-upon mark-up for the Contractor's Overhead and Profit (OH&P) on Subcontractors shall be five percent (5%).
- 1.4. Any Change Orders authorized on a Time and Materials (T&M) basis shall have daily time and materials forms prepared by the Contractor and signed by Veolia.

**2.0 INVOICES**

- 2.1 Payment will be made in accordance with Article 3.0 of Exhibit B.
- 2.2 Subcontractor's invoice shall:
- 2.2.1 Reflect Company's Purchase Order ("PO") number and Site ID
- 2.2.2 Be numbered sequentially
- 2.2.3 Be submitted by email to [us.apinvoices@veolia.com](mailto:us.apinvoices@veolia.com) for approval
- 2.2.4 Be submitted on a monthly basis no later than the fifteenth (15<sup>th</sup>) day of the following month
- 2.2.5 Show previous amount billed, current amount billed, and amount billed to date by each activity and by the sum of all activities
- 2.2.6 Be accompanied by such supporting documentation as Company may reasonably require
- 2.3 An executed waiver and release form in the respective formats referenced as Exhibit C.1 - Interim Waiver And Release of Liens and Claims Upon Payment and Exhibit C.2 - Unconditional Final Waiver and Release of Liens and Claims upon Final Payment shall accompany Subcontractor's final invoice.

**EXHIBIT C.1**

**INTERIM WAIVER AND RELEASE OF LIENS AND CLAIMS UPON PAYMENT**

(To be provided by Subcontractor with Interim Progress Payment Invoices)

STATE OF Massachusetts  
COUNTY OF Bristol

The undersigned, Subcontractor ("Subcontractor"), has been engaged under subcontract with Veolia Water North America - Northeast, LLC ("Company") to furnish certain materials, equipment, services, and/or labor for the project known as Taunton MA, Wastewater Treatment Facility, Phase 2 Improvements, which is located at 825 West Water Street, Taunton, MA ("Property"), and more particularly described as follows: Taunton MA, Wastewater Treatment Facility, Phase 2 Improvements.

Upon receipt of the sum of \$ \_\_\_\_\_, the Subcontractor waives and releases any and all liens or claims of liens and all claims, demands, actions, causes of action or other rights against Company and the Client and upon the foregoing described Project and Property through the date of \_\_\_\_\_, 20\_\_ ("Current Date") and reserving those rights and liens that the Subcontractor might have in any retained amounts, on account of materials, equipment, services and/or labor furnished by the undersigned to or on account of Company for said **Taunton MA, Wastewater Treatment Facility, Phase 2 Improvements**. Exceptions as follows:

(if no exception entry or "none" is entered above, Subcontractor shall be deemed not to have reserved any claim.)

Subcontractor further represents that all employees, laborers, materialmen, sub-subcontractors and sub-subconsultants employed by the Subcontractor in connection with the Project and all bills incurred through the Current Date for materials, equipment, services and/or labor, and taxes furnished by such parties to the Subcontractor in connection with the Subcontractor's work on the Project have been, or shall be within 10 days of receipt of payment from Company stated above, fully paid and that no obligations, legal, equitable or otherwise, are, or shall be then, owed by the Subcontractor to such parties.

This Waiver and Release is freely and voluntarily given and the undersigned acknowledges and represents that it has fully reviewed the terms and conditions of this Waiver and Release, that it is fully informed with respect to the legal effect of this Waiver and Release, and that it has voluntarily chosen to accept the terms and conditions of this Waiver and Release in return for the payment recited above.

The undersigned understands that the failure to complete correctly or fully any of the blank spaces in this document shall not invalidate the document so long as the subject matter of this Waiver and Release may reasonably be determined.

**FOR SUBCONTRACTOR:**

Applicable to Payment Request(s) No. \_\_\_\_\_  
(or) Invoice(s) No. \_\_\_\_\_ By: \_\_\_\_\_  
Date: \_\_\_\_\_ Title: \_\_\_\_\_

**AFFIDAVIT**

On this \_\_\_\_ day of \_\_\_\_\_, 20\_\_, before me appeared the above-signed, known or identified to me personally, who, being first duly sworn, did say that s/he is the authorized representative of the above-referenced Subcontractor and that this document was signed under oath personally and on behalf of the Subcontractor and the above-signed acknowledged that this Affidavit was executed as a free act and deed of Subcontractor.

Signature \_\_\_\_\_ (Seal)  
Signature of Notary Public

**EXHIBIT C.2**

**UNCONDITIONAL FINAL WAIVER AND RELEASE OF LIENS AND CLAIMS UPON FINAL PAYMENT**

(To be provided by Subcontractor with Final Invoice)

STATE OF Massachusetts

COUNTY OF Bristol

The undersigned, Subcontractor ("Subcontractor"), has, under an agreement with Veolia Water North America - Northeast, LLC ("Company"), furnished certain materials, equipment, services, and/or labor for the project known as Taunton MA, Wastewater Treatment Facility, Phase 2 Improvements, which is located at 825 West Water Street, Taunton, MA, County of Worcester ("Property"), and more particularly described as follows: Taunton MA, Wastewater Treatment Facility, Phase 2 Improvements

Upon receipt of the sum of \$\_\_\_\_\_, such receipt being hereby acknowledged, the Subcontractor waives and releases any and all claims, demands, actions, causes of action or other rights against Company, the Client, the Project and Property, at law, in contract, tort, equity or otherwise, and any and all liens or claims of liens or any right against any labor and/or material bond Subcontractor has, may have had or may have in the future arising out of Subcontractor's performance of work on the Project.

This Waiver and Release applies to all facts, acts, events, circumstances, changes, constructive or actual delays, accelerations, extra work, disruptions, interferences and the like which have occurred, or may be claimed to have occurred prior to the date of this Waiver and Release, whether or not known to the Subcontractor at the time of execution of this Waiver and Release.

The Subcontractor further represents that all of its obligations, legal, equitable, or otherwise, relating to or arising out of its work on the Project have been, or shall be within 10 days of the date stated below, fully satisfied, including, but not limited to obligations relating to:

- Employees, laborers, materialmen, sub-subcontractors and sub-subcontractors employed by the Subcontractor;
- Labor, materials, equipment and supplies furnished by others to the Subcontractor; and
- Sales and use taxes, social security taxes, income tax withholding, unemployment insurance, privilege taxes, license fees, and any other taxes and obligations imposed by governmental authorities.

This Waiver and Release is freely and voluntarily given and the Subcontractor acknowledges and represents that it has fully reviewed the terms and conditions of this Waiver and Release, that it is fully informed with respect to the legal effect of this Waiver and Release, and that it has voluntarily chosen to accept the terms and conditions of this Waiver and Release in return for the payment recited above. The Subcontractor understands, agrees and acknowledges that, upon payment; this document waives rights unconditionally and is fully enforceable to extinguish all claims of the Subcontractor as of the date of execution of this document by the Subcontractor. The Subcontractor understands that the failure to complete correctly any of the blank spaces in this document shall not invalidate the document so long as the subject matter of this Waiver and Release may reasonably be determined.

**FOR SUBCONTRACTOR:**

Applicable to Payment Request(s) No. \_\_\_\_\_

Signed: \_\_\_\_\_(SEAL)

\*If all, print "all" \_\_\_\_\_

By: \_\_\_\_\_

Date: \_\_\_\_\_

Title: \_\_\_\_\_

**AFFIDAVIT**

On this \_\_\_ day of \_\_\_\_\_, 20\_\_\_, before me appeared the above-signed, known or identified to me personally, who, being first duly sworn, did say that s/he is the authorized representative of the above-referenced Subcontractor and that this document was signed under oath personally and on behalf of the Subcontractor and the above-signed acknowledged that this Affidavit was executed as a free act and deed of Subcontractor.

Signature \_\_\_\_\_ (Seal)

Signature of Notary Public



**EXHIBIT D**

**INSURANCE REQUIREMENTS**

Without in any way limiting Subcontractor's liability hereunder, Subcontractor shall maintain the following minimum limits of insurance at its own expense during the performance of the Work, with insurance companies rated A-VII or higher by A.M. Best's, to cover the risk of losses associated with this Agreement:

<u>Coverage</u>	<u>Limits</u>
(i) Workers' Compensation	\$100,000
(ii) Employers' Liability	\$1,000,000 each accident \$1,000,000 each employee \$1,000,000 policy limit
(iii) Commercial General Liability written on ISO CG 00 01 coverage form or its equivalent. No limiting or exclusionary endorsements material to Subcontractor's obligations in this Subcontract may be attached. Coverage shall include: a) contractual liability; b) explosion, collapse & underground perils (XCU); c) third-party over action coverage; d) Riggers Liability endorsement for the use of cranes, booms or other rigging equipment, if applicable; and e) amendment of the aircraft exclusion to include coverage for the use of commercial UAVs (drones), if applicable	\$2,000,000 each occurrence for property damage and bodily injury (PD/BI) \$2,000,000 general aggregate per project \$2,000,000 products/completed operations aggregate
(iv) Automobile Liability - covering all owned (if any), hired and non-owned autos. If Subcontractor is performing any hauling, endorsements MCS-90 and/or CA 99 48 shall be attached.	\$2,000,000 combined single limits - each accident
(v) Umbrella/Excess Liability providing coverage at least as broad as the underlying policy(ies)	May be utilized to meet limits outlined above
(vi) Property	Subcontractor shall be solely responsible for protecting and insuring all property owned or leased or used by Subcontractor in conjunction with the Work during the term of this Subcontract
(vii) Professional Liability (Errors & Omissions), if applicable to the Work - Coverage shall not exclude Technology Errors & Omissions coverage if Subcontractor will have any type of access to any Company systems, including, but not limited to, any Company-owned or managed IT asset (network, server or application) wherever it is hosted	\$1,000,000 each claim \$1,000,000 annual aggregate
(viii) Contractor's Pollution Liability, if applicable to the Work	\$1,000,000 each claim \$1,000,000 annual aggregate

Prior to providing any Work under this Agreement, Subcontractor will provide Company with an ACORD certificate of insurance evidencing that the above described coverages are in full force and effect. Subcontractor will name Company and Client as additional insured with respect to coverages (iii), (iv), and (viii), (and (v) if applicable) above. All policies will be primary and non-contributory, provide a full waiver of the insurer's right of subrogation in favor of Company and Client, if applicable, and/or any sub-subcontractor with respect to claims that are covered or should have been covered by valid and collectible insurance provided hereunder and said waiver will extend to any deductibles, co-insurance or

retentions. Subcontractor will not permit any cancellation or non-renewal in the insurance coverage to be provided hereunder without thirty (30) days' written notice to Company.

All policies shall be issued on occurrence-based forms, except for coverages (vii) or (viii), which may be issued on a claims-made form. All claims-made policies will at least be retroactive to the earlier of the date of this Agreement or the commencement of Subcontractor's services in relation to the Work, and shall be maintained for three (3) years after the expiration or termination of this Agreement.

These insurance requirements will not be construed in any matter as waiving, restricting or limiting Company's rights or Subcontractor's obligations under this Agreement. Company does not represent that coverage or limits herein will be adequate to protect Subcontractor. Subcontractor remains responsible for any liability not paid by insurance including deductibles and retentions.

**EXHIBIT E**  
**INSURANCE SUPPLEMENT (IF APPLICABLE)**  
**INTENTIONALLY LEFT BLANK**

**EXHIBIT F**  
**ADDITIONAL / SPECIAL TERMS**  
**INTENTIONALLY LEFT BLANK**

## EXHIBIT G

### TERMS AND CONDITIONS FOR SERVICES INVOLVING HAZARDOUS OR CONTAMINATED NON-HAZARDOUS WASTE OR MATERIALS

#### 1. DEFINITIONS

- 1.1. "Hazardous Waste or Hazardous Materials": Means any substance falling within the definition of hazardous waste or hazardous material as set forth in the United States Resource Conservation and Recovery Act, 42 U.S.C §6901 et seq., the United States Comprehensive Environmental Response, Compensation and Liability Act, 42 U.S.C §9601 et seq., or any other federal, state or local statutes, regulations and ordinances which are applicable to the handling, remediation or transportation of Hazardous Waste or Hazardous Materials.
- 1.2. "Non-Hazardous Contaminated Materials": Means any material considered contaminated by State or Federal law or regulation but is not listed under RCRA and are able to pass TCLP, e g, oil contaminated materials.
- 1.3. "Law" or "Laws": Means all federal, state and local statutes, laws, ordinances and any regulations, orders and administrative guidelines (by whatever title, and without respect to whether enforceable at law) issued thereunder that are applicable to the performance of the Work under this Agreement. To the extent that a Permit is required for Subcontractor to perform the Work, "Law" includes "Permit."
- 1.4. "Permit" or "Permits": Means every permit, license, authorization, certification, permission, or equivalent control document required under any federal, state or local statute, law ordinance, regulation or order.

#### 2. WARRANTY

- 2.1. Subcontractor warrants that it is aware of and is knowledgeable about all Laws, including Environmental Protection Agency (EPA) Regulations, U.S. Department of Transportation (DOT) Regulations, the Occupational Safety and Health Act (OSHA) Regulations and the Resource Conservation and Recovery Act (RCRA), which may be applicable to the handling, remediation, disposal or transportation of Non-Hazardous Contaminated Materials, Hazardous Waste or Hazardous Materials which comprise all or part of the Work under this Agreement. Subcontractor further warrants that the Work will be accomplished in a manner which complies with Laws including, but not limited to, EPA DOT, OSHA and RCRA.
- 2.2. Subcontractor warrants that it is fully aware of the extent of the Work required by this Agreement, that it has conducted adequate research and analysis with respect to the handling, remediation, disposal and/or transportation of Non-Hazardous Contaminated Materials, Hazardous Waste or Hazardous Materials which comprise all or part of the Work under this Agreement, and that it has the expertise, experience, personnel, equipment (including the necessary health and safety personal protective equipment), facilities and financial resources necessary to perform the Work in accordance with all Laws.
- 2.3. Subcontractor warrants that its possesses or shall obtain, prior to commencing the Work, all Permits and other forms of documentation required in order to perform the Work in full compliance with all Laws, and shall ensure that all of the Subcontractor's employees, and all sub-subcontractors and their employees at any tier shall also possess the necessary Permits, and other forms of required documentation prior to the commencement of the Work.
- 2.4. If Work requires the generation of a Site-Specific Safety and Health Plan (SSHP) as required by OSHA, the Subcontractor and its sub-subcontractors shall generate such a plan for their employees in compliance with 29 CFR 19101.20/1926.65. This plan shall be made available to Company prior

to the start of any field activities. The Subcontractor's SSHP is solely the responsibility of Subcontractor, who shall evaluate the potential hazards to its employees and adhere to its SSHP. The Subcontractor's SSHP shall, at a minimum, conform to the requirements, where applicable, established in Company SSHP if one is generated. However, the Company SSHP does not, nor is it intended to, address procedures or activities of Subcontractor or its sub-subcontractors.

2.5. Subcontractor warrants that it is aware of and understands the currently known hazards and risk of injury to persons, property and the environment associated with the handling, remediation, disposal and/or transportation of Non-Hazardous Contaminated Materials, Hazardous Waste or Hazardous Materials which comprise all or part of the Work, Subcontractor shall have instructed its employees and the employees of its sub-subcontractors at any tier in the proper safety procedures and safety equipment to be used in the performance of the Work in compliance with all Laws, including OSHA.

### **3. TRANSPORTING WASTES OFF-SITE**

3.1. Any vehicles/waste shipment containers leaving an exclusion zone shall be decontaminated prior to leaving the Project Site. The Subcontractor shall inspect all waste shipment containers prior to leaving the Project Site to ensure that the least possible amount of soil adheres to wheels and undercarriages.

3.2. Subcontractor shall not deliver site materials to any facility other than the approved disposal facility(ies) listed on the shipping manifest.

3.3. Subcontractor shall be responsible for and all actions necessary to remedy situations involving transit of mud, soil, contaminates, or waste materials trucked offsite. This cleanup shall be accomplished at the Subcontractor's expense.

3.4. Subcontractor shall prepare and submit for approval by Client through Company, a route selection report containing results of any inspections of the proposed access routes to determine road conditions, overhead clearance, weight restrictions, and required traffic control measures.

3.5. The Subcontractor shall ensure that waste shipment containers are protected against contamination by properly covering and lining them with compatible materials or by decontaminating them prior to any use other than hauling contaminated materials.

3.6. Prior to leaving the Project Site, a load inspection of all shipments shall be conducted by a designated responsible party approved by Company's Designated Representative. The load inspection report shall be submitted to Client through Company, which shall verify and provide written documentation of the following:

- A complete and accurate manifest.
- Utilization of the proper DOT approved shipping container in accordance with 49 Code of Federal Regulation (CFR).
- Labeling in accordance with DOT regulations specified by 49 CFR.
- A bill of lading traceable to the manifest.
- Validation that all waste shipment containers are in good condition and are not leaking.
- A statement that the driver is physically fit to perform his duties.
- Validation that the driver has written documentation in his possession of completion of the required DOT safety training and health monitoring.
- A statement that the driver's log book is current.
- Validation that a certificate of insurance is in force.

3.7. Site materials will be stored and transported in bulk containers when practical.

### **4. NOTIFICATION OF RELEASE**

4.1. The Subcontractor shall be prepared and qualified to respond to emergency situations and releases for operations under the Subcontractor's control.

4.2. Should any release of Non-Hazardous Contaminated Materials, Hazardous Waste or Hazardous Materials occur during the performance of the Work, Subcontractor shall immediately notify all appropriate agencies and take all appropriate action. The Subcontractor shall also notify Company of such release by telephone or facsimile within four (4) hours of the incident. Subcontractor shall provide Company with copies of all notices of the release provided to any person, agency or authority by Subcontractor or its agents. Such copies shall be provided to Company simultaneously with the service of the original to any person, agency or authority.

## EXHIBIT H

### IT Security Requirements

At all times during its performance of work arising under this Agreement, Subcontractor shall comply with (and ensure that its managers/members, employees, agents and representatives of any type comply with) all requirements and policies of Veolia or its customers concerning information security, safety and other business operations, and all applicable Federal, foreign, state and local laws, rules, ordinances, codes and regulations including, but not limited to, all laws regulating the conduct of Works.

#### CONFIDENTIAL INFORMATION

At the expiration or termination of this Agreement, Subcontractor shall return or destroy (if requested by Company) all copies, extracts or other reproductions in whole or in part of the Confidential Information disclosed to the Subcontractor by Company. If Company requests that the documents be destroyed, Subcontractor shall provide a certification of such destruction, by an officer of Subcontractor. Subcontractor shall retain no copies of any Confidential Information.

#### NOTICES

Subcontractor is required to provide notification to Company of any suspected or actual breach of security, intrusion or unauthorized use or disclosure of Company personally identifiable information or Confidential Information and/or any actual or suspected use or disclosure of data in violation of any applicable federal or state laws or regulations in connection with the services and/or deliverables contained within this Agreement. In addition to sending notification to the General Counsel, notification shall also be sent to: [na.information.security@veolia.com](mailto:na.information.security@veolia.com)

#### WARRANTIES

Subcontractor warrants that it will maintain commercially reasonable security standards for its and its end users' systems, including without limitation the use of sufficiently secure passwords and regularly required password change, maintain its systems with proper patching and security updates; will use good industry virus protection software and practices, and other security best practice procedures to protect Company data and to avoid introducing any virus that could disrupt the proper operation of the Company systems used or corrupt the data.

Subcontractor also warrants that it shall use all reasonable endeavors to ensure that its end users do not upload or distribute files that contain viruses, malicious files or other harmful code on to, or disrupt or attempt to disrupt the systems and networks used during the Works. In the event a virus or other such code is introduced into the Company systems due to Subcontractor's failure to use such endeavors or Company data is breached from Subcontractor's systems, Subcontractor will at its cost assist Company in mitigating the direct effects of such issue.

#### VIRUSES

Subcontractor warrants it has not knowingly included any known viruses (including, but not limited to Trojan horses, or worms, or other software code designed to permit unauthorized access to, or to erase or otherwise harm, Company software, hardware, or data) with any material provided to Company.

#### OWNERSHIP OF DATA

Company will at all times retain ownership in the data, proprietary information and materials that Company provides to Subcontractor, including all patent, copyright and other intellectual property rights of Company, and all materials prepared by Subcontractor pursuant to this Agreement, including but not limited to surveys, results and findings.



## EXHIBIT I

### ANTI-CORRUPTION COMPLIANCE

1. In carrying out the terms of this Agreement, Subcontractor hereby undertakes to strictly comply with applicable laws prohibiting the bribery of public officials and private persons, influence peddling, money laundering that may in particular entail a public contract debarment, including:
  - (a) the 1977 Foreign Corrupt Practices Act of the United States,
  - (b) the 1999 Canadian Corruption of Foreign Public Officials Act,
  - (c) the 2010 UK Bribery Act, the OECD Convention on Combating Bribery of Foreign Public Officials in International Business Transactions of December 17, 1997. SUBCONTRACTOR undertakes to put in place and implement all necessary and reasonable policies and measures to prevent corruption.
2. Subcontractor declares that to its knowledge, its legal representatives, directors, employees, agents, and anyone performing services for or on behalf of Company pursuant to this Agreement do not and will not directly or indirectly offer, give, agree to give, authorize, solicit, or accept the giving of money or anything else of value or grant any advantage or gift to any person, company or undertaking whatsoever including any government official or employee, political party official, candidate for political office, person holding a legislative, administrative or judicial position of any kind for or on behalf of any country, public agency or state owned company, official of a public international organization, for the purpose of corruptly influencing such person in their official capacity, or for the purpose of rewarding or inducing the improper performance of a relevant function or activity by any person in order to obtain or retain any business for Company or to gain any advantage in the conduct of business for Company.
3. Subcontractor further undertakes to ensure that neither Subcontractor nor any of its legal representatives, directors, employees, agents, sub-contractors and anyone performing services for or on behalf of Company under this Agreement has been, or is listed by any government agency as being debarred, suspended, proposed for suspension or debarment, or otherwise ineligible for participation in government procurement programs and/or bidding following invitations to bid advertised by the World Bank or any other international development bank.
4. Subcontractor undertakes to retain for an appropriate period following termination of this Agreement, accurate supporting documentation of its compliance with the terms of this clause.
5. Subcontractor agrees to notify Company of any breach of any term of this clause within a reasonable time.
6. If Company notifies Subcontractor that it has reasonable grounds to believe that Subcontractor has breached any term of this clause:
  - (a) Company is entitled to suspend performance of this Agreement without notice for as long as Company considers necessary to investigate the relevant conduct without incurring any liability or obligation to Subcontractor for such suspension;
  - (b) Subcontractor is obliged to take all reasonable steps to prevent the loss or destruction of any documentary evidence in relation to the relevant conduct.
7. If Subcontractor breaches any term of this clause:
  - (a) Company may immediately terminate this Agreement without notice and without incurring any liability.
  - (b) Subcontractor undertakes to indemnify Company, to the maximum extent permitted by law, for any loss, damages, or expenses incurred or suffered by Company arising out of such breach.

## EXHIBIT J

### BONDING / LETTER OF CREDIT REQUIREMENTS

Effective on the date this Contract is entered into the Subcontractor shall provide financial security for the performance of its obligations hereunder through a Performance Bond issued by a surety company: (1) approved by the Owner having a rating of "A" in the latest revision of the A.M. Best Company's Insurance Report; (2) listed in the United States Treasury Department's Circular 570, "Companies Holding Certificates of Authority as Acceptable Sureties on Federal Bonds and as Acceptable Reinsurance Companies"; and (3) properly registered and licensed to conduct business in the State of Connecticut. The bond shall be issued in the name of the Subcontractor, as principal, and the Company and Client, as obligee, in the full amount (100%) of the Work, to be adjusted to account for any adjustments, and shall remain open until the final completion of the Work and any modifications.

**DIVISION 01**

## SECTION 01010

### SUMMARY OF WORK

#### PART 1 GENERAL

##### 1.01 SECTION INCLUDES

- A. Work covered by the Contract, listing of Owner, Project location, Engineer. Sequence requirements, the Contractor's use of the premises Owner's occupancy requirements, State Sales and Use Tax, Non Discrimination in Employment, and Wetlands and Waterways.

##### 1.02 WORK COVERED BY CONTRACT DOCUMENTS

- A. The Work includes, but is not necessarily limited to the construction of:

###### Bid Package #1 – General

Bid Package #1 consists of all work not included in Packages #2-3, including:

- Retrofit of existing biological treatment tanks
- Construction of new biological treatment tanks
- Furnish and install blowers and associated equipment for biological treatment system
- **Installation** (mechanical and electrical) of secondary sludge pumping systems (RAS and WAS) (Pumps Procured under Package #3)
- Conversion of existing blower building to storage space
- Electrical work as shown in the contract documents - Electrical drawings and Specifications Division 16
- Install instrumentation and control panels furnished under Division 13 and Division 11
- **ADDITIVE ALTERNATIVE #1 - Rehabilitation and equipment replacement of final clarifiers (see Specification Section 01025 for definition)**
- **Contractor should note the requirements and sequencing in Specification Section 01810 – Maintenance of Plant Operation and Sequence of Construction**

###### Bid Package #2 – Instrumentation and Control

- Furnish and program Instrumentation and control equipment as shown in the Contract Documents – Instrumentation drawings and Specifications Division 13
- All Instrumentation and Control work shown on Instrumentation drawings and described in Specifications shall be installed regardless of whether or not Additive Alternative #1 in Bid Package #1 is awarded.

###### Bid Package #3 – Secondary Sludge Pumps Procurement

- Furnish vertical centrifugal pumps for secondary sludge pumping (RAS and WAS) as specified in Specification Section 11312.

all as more particularly indicated, shown or described in the Drawings, Specifications, and other Contract Documents.

##### 1.03 OWNER

- A. City of Taunton, Department of Public Works  
90 Ingell Street  
Taunton, MA 02708  
Telephone: 508-821-1434  
Contact: Fred Cornaglia, Commissioner

1.04 PROJECT LOCATION

- A. Taunton Wastewater Treatment Facility (WWTF)  
825 West Water Street  
Taunton, MA 02708

1.05 ENGINEER

- A. BETA Group, Inc.  
701 George Washington Highway  
Lincoln, Rhode Island 02865  
Telephone: 401-333-2382
- Contact: Michael Andrus, P.E.  
Email: mandrus@beta-inc.com

1.06 WORK SEQUENCE

- A. In order that Work may be conducted with minimum inconvenience to the public and, work under this Contract may be coordinated with other work which may be under construction or contemplated, and that work under the Contract may conform to conditions which it has been undertaken or conditions attached to a right-of-way or particular location for this work, the Engineer may determine the point or points and time or times when portions of work will commence or be carried on and may issue orders pertaining to the work sequence, relative to the rate of progress on several portions of the work.
- B. Contractor shall take particular note of the requirements and sequencing of construction outlined in Specification Section 01810 – Maintenance of Plant Operation and Sequence of Construction

1.07 CONTRACTOR USE OF PREMISES

- A. The Contractor's use of premises shall be within the limits shown on the Drawings and as defined in Section 00500 – Contract Agreement, for the performance of the Work.
- B. The Contractor shall maintain access and utilities to the existing WWTF facilities at all times.
- C. The Contractor shall assume full responsibility for security of all materials and equipment on the site, including those of his subcontractor's.
- D. If directed by the Owner, the Contractor shall move any stored items that interfere with operations of the Owner.
- E. Obtain and pay for use of additional storage or work areas if needed to perform the Work.

1.08 OWNER OCCUPANCY REQUIREMENTS

- A. The existing WWTF must remain in full service at all times, throughout the duration of the project.

- B. The Owner requires safe and unhindered access to be maintained to the existing WWTF facilities for the purpose of operating and maintaining the facility, throughout the duration of the Contract.

#### 1.09 STATE SALES AND USE TAX

- A. Materials and equipment purchased for installation under this Contract are exempt from Massachusetts Sales Tax. The Contractor shall file for exemption on behalf of the Owner with the Commonwealth of Massachusetts Department of Revenue as required by law. The exemption from the Sales Tax shall be taken into account by the Contractor during bidding.

#### 1.10 NONDISCRIMINATION IN EMPLOYMENT

- A. Contracts for work will obligate the Contractors and subcontractors not to discriminate in employment practices.
- B. The Contractor will not discriminate against any employee or applicant for employment because of race, color, religion, sex, age, handicap, or national origin. The Contractor shall take affirmative action to ensure that applicants are employed and the employees are treated during employment without regard to their race, color, religion, sex, age, handicap, or national origin. Such actions shall include, but not be limited to, the following: employment, upgrading; demotions, or transfers; recruitment or recruitment advertising, layoffs, or terminations; rates of pay or other forms of compensation; selection for training including apprenticeship; and participation in recreational and education activities. The Contractor agrees to post in conspicuous places available to employees and applicants for employment notice to be provided setting forth the provisions of this non-discrimination clause. The Contractor will in all solicitations or advertisements for employees placed by or on behalf on the Contractor state that all qualified applicants will receive consideration for employment without regard to race, color, religion, sex, age, handicap or national origin. The Contractor will cause the foregoing provisions to be inserted in all sub-contracts for any work covered by this Contract so that such provisions will be binding upon each sub-contractor and upon sub-contracts for standard commercial supplies or raw materials.
- C. The Contractor shall keep such records and submit such reports concerning the racial and ethnic origin of applicants for employment and employees as the Owner may require as consistent with Federal and State law. The Contractor agrees to comply with such rules, regulations, or guidelines as the Commonwealth of Massachusetts may implement these requirements. The Contractor further warrants, that he will comply with the President's Executive Order No. 11246 or any preceding similar Executive Order relating thereto.
- D. Contractors must, if required, submit a compliance report (EPA Form 5720-4) concerning their employment practices and policies in order to maintain their eligibility to receive award of the Contract.
- E. Contractors must, submit a list of all Subcontractors who will perform work on the project, and written signed statements from authorized agents of labor pools with which they will or may deal with for employees on the work, together with any information to the effect that such labor pools' practices or policies are in conformity with said Executive Order that they will affirmatively cooperate in or offer no hindrance to the recruitment, employment, and equal treatment of employees seeking employment and performing work under this Contract;

or a certification as to when such agents or labor pools have failed or refused to furnish them, prior to award of the Contract.

- F. Contractor will be required to comply with Equal Opportunity Requirements and to abide by the prevailing wage rates for Public Work Projects for all employees on the job. It is the responsibility of Bidders to inform themselves as to the local labor conditions, overtime compensation, health and welfare contributions, labor supply and prospective changes or adjustment of wage rates. Information is available at the Department of Labor.
- G. Contractor shall comply with the Minority and Women Workforce Participation goals as outlined in the Commonwealth of Massachusetts Supplemental Equal Employment Opportunity, Non-Discrimination and Affirmative Action Program.

#### 1.11 WETLANDS AND WATERWAYS

- A. The Contractor's attention is directed to the fact that a portion of the work is located within and/or immediately adjacent to wetlands and waterways. Work within these areas is subject to the jurisdiction of the Massachusetts Department of Environmental Protection. All requirements and/or control measures deemed necessary by the Department shall be strictly adhered to throughout the duration of this Contract.
- B. The Contractor shall not have or assert any claim for nor shall he be entitled to any additional compensation or damages on account of requirements set forth by the Department of Environmental Protection regarding wetlands and waterways encountered during construction.

#### PART 2 PRODUCTS

NOT USED

#### PART 3 EXECUTION

NOT USED

END OF SECTION

## SECTION 01025

### MEASUREMENT AND PAYMENT

#### PART 1 GENERAL

##### 1.01 SUMMARY

###### A. Section Includes

1. Measurement and payment criteria applicable to the Work performed under a unit price and/or lump sum payment method of Items listed in the BID.

###### B. Related Sections

1. Section 00300 - Bid
2. Section 00500 - Agreement
3. Section 00700 – General Conditions
4. Section 00800 – Supplementary Conditions

##### 1.02 LUMP SUM PRICES

- A. Payment will be computed on the basis of the percentage of work completed on each Item in the contract BID as determined by the Engineer. Lump sum prices are to include the cost of all necessary materials, labor, equipment, overhead, profit and other applicable costs. (See Par. 1.03, this Section.)

##### 1.03 PRICES INCLUDE

- A. The prices stated in the Proposal include full compensation not only for furnishing all the labor, equipment and material needed for, and for performing the work and building the structures contemplated by, the Contract, but also for assuming all risks of any kind for expenses arising by reason of the nature of the soil, ground water, or the action of the elements; for all excavation and backfilling; for the removal of and delay or damage occasioned by trees, stumps, tracks, pipes, ducts, timber, masonry or other obstacles; for removing, protecting, repairing, or restoring, without cost to the Owner, all pipes, ducts, drains, sewers, culverts, conduits, curbs, gutters, walks, fences, tracks, or other obstacles, road pavements and other ground surfacing whether shown on plans or not for draining, damming, pumping or otherwise handling and removing, without damage to the work or to other parties, and without needless nuisance, all water or sewage from whatever source which might affect the work or its progress, or be encountered in excavations made for the work; for maintaining existing plant flows, for providing temporary equipment, systems and facilities as specified and as necessary so that the WWTF may continue operation during construction; for furnishing, inserting and removing as directed, all shoring, staging, cofferdams etc.; for all signs, fencing, lighting, watching, guarding, temporary surfacing, bridging, snow removal, etc., necessary to maintain and protect travel on streets, walks and private ways; for making



all provisions necessary to maintain and protect buildings, fences, poles, trees, structures, pipes, ducts and other public or private property affected or endangered by the work; for the repair or replacement of such things if injured by neglect of such provisions for removing all surplus or rejected materials as may be directed; for replacing, repairing and maintaining the surfaces of streets, highways, public and private lands if and where disturbed by work performed under the Contract or by negligence in the performance of work under the Contract; for furnishing the requisite filling materials in case of any deficiency or lack of suitable materials; for obtaining all permits and licenses and complying with the requirements thereof, including the cost of furnishing any security needed in connection therewith; for any and all expense on account of the use of any patented device or process; for protection against inclement or cold weather; for all expenses incurred by or on account of the suspension; interruption or discontinuance of work; for the cost of the surety bond and adequate insurance; for all taxes, fees, union dues, etc., for which the Contractor may be or become liable, arising out of his operations incidental to the Contract; for providing equipment on the site and off site; for providing a field office and its appurtenances and for all general and incidental expenses; for tools, implements and equipment required to build and put into good working order all work contemplated by the Contract; for maintaining and guaranteeing the same as provided; and for fulfilling all obligations assumed by the Contractor under the Contract and its related documents.

- B. The Owner shall pay and the Contractor shall receive the prices stipulated in the BID made a part hereof as full compensation for everything performed and for all risks and obligations undertaken by the Contractor under and as required by the Contract.
- C. The prices shall also include the removal and disposal of the existing pipe being replaced or repaired, unless otherwise specified in the Contract.

#### 1.04 GENERAL BID, PART I

#### BID ITEM NO. 1 WASTEWATER TREATMENT FACILITY IMPROVEMENTS - PHASE 2

- A. Payment of the lump-sum price bid in the Bid Form (Specification Section 00300) for Item No. 1 shall constitute full compensation for all labor, material, tools, equipment and incidentals necessary for constructing the Wastewater Treatment Facility Improvements - Phase 2, Contract S-2022-1, complete, as indicated on the Drawings and as specified in the Bidding and Contract Requirements and Divisions 1 through 16, EXCEPT:
  - A. Bid Item #1A - Additive Alternative #1 – Rehabilitation and equipment replacement of final Clarifiers
  - B. Bid Items 2 through 5
  - C. Bid Package #2 (Instrumentation and Controls)
  - D. Bid Package #3 (Secondary Sludge Pumps Procurement)
- B. For all equipment and systems provided under this bid:

- Five (5) percent of the equipment/system cost will be withheld until the operations and maintenance manual has been approved and all copies have been turned over to the Owner.
- Five (5) percent of the equipment/system cost will be withheld until the spare parts and lubricants have been turned over to the Owner.
- Five (5) percent of the equipment/system cost will be withheld until the manufacturer's representative has certified the equipment, assisted with the start-up and completed the training.
- Five (5) percent of the equipment/system cost will be withheld until the testing has been completed and the test results have been submitted and approved.

**BID ITEM NO. 1A ADDITIVE ALTERNATIVE #1 – REHABILITATION AND EQUIPMENT REPLACEMENT FOR ALL FINAL CLARIFIERS**

- A. Payment for Alternative Item #1, if awarded, shall constitute full compensation for structural and mechanical rehabilitation and equipment replacement of all four (4) final clarifiers as described on the following plans and Specification Sections:
  - a. Drawings S-4.1, M-4.1, M-4.2, M-4.7, M-4.8, and M-4.13 in their entirety.
  - b. Specification Sections 11100 – Automatic Algae Sweeping System; 11327 – Final Clarifier Equipment; 11329 – Density Current Baffles in their entirety
  - c. Portions of specifications 11601 – FRP Weirs and Scum Baffles, Division 03 – Concrete, and other sections as pertains to the work on the Final Clarifiers as shown on the drawing referenced in part (a) above.
- B. Electrical work relative to the final clarifiers as shown on the Electrical drawings and described in Division 16 of the specifications is NOT considered part of this alternative, but shall be included as part of the base bid (Bid Item #1). Electrical work relative to final clarifiers shall be completed under Bid Item #1 whether or not the additive alternative is awarded.
- C. Instrumentation and control work relative to the final clarifiers as shown on the Instrumentation and Control drawings and described in Division 13 of the specifications is NOT considered part of this alternative, but shall be included as part of Bid Package #2. Instrumentation and control work relative to the final clarifiers shall be completed under Bid Package #2 whether or not the additive alternative is awarded.

**BID ITEM NO. 2 CRACK REPAIR OF EXISTING CONCRETE TANKS AND STRUCTURES**

- A. The length of Crack Repair to be paid for under Item 2 shall be by the linear foot of crack repaired, as measured by the Contractor and confirmed by the Engineer prior to repairs. The bid quantity for this Item includes repairs associated with the Final Clarifiers (Additive Alternative #1). If Alternative #1 is not awarded, the quantity of this Item shall be reduced accordingly.
- B. Payment of the unit price bid in the Bid Form for Item No. 2 shall constitute full compensation for all labor, material, tools, equipment and incidentals necessary for

completing concrete crack repairs by epoxy injection in accordance with Specification Section 03940.

**BID ITEM NO. 3 CONCRETE SPALLING REPAIR OF EXISTING CONCRETE TANKS AND STRUCTURES**

- A. The quantity of Crack Repair to be paid for under Item 3 shall be by the square foot of spalling repaired, as measured by the Contractor and confirmed by the Engineer prior to repairs. The bid quantity for this Item includes repairs associated with the Final Clarifiers (Additive Alternative #1). If Alternative #1 is not awarded, the quantity of this Item shall be reduced accordingly.
- B. Payment of the unit price bid in the Bid Form for Item No. 3 shall constitute full compensation for all labor, material, tools, equipment and incidentals necessary for completing concrete rehabilitation in accordance with Specification Section 03930.

**BID ITEM NO. 4 CONCRETE PROTECTIVE COATING OF EXISTING CONCRETE TANKS AND STRUCTURES**

- A. The quantity of concrete protective coating to be paid for under Item 4 shall be by the square foot of concrete coated, as measured by the Contractor and confirmed by the Engineer prior to coating being applied. The bid quantity for this Item includes repairs associated with the Final Clarifiers (Additive Alternative #1). If Alternative #1 is not awarded, the quantity of this Item shall be reduced accordingly.
- B. Payment of the unit price bid in the Bid Form for Item No. 4 shall constitute full compensation for all labor, material, tools, equipment and incidentals necessary for providing and installing concrete protective coating as specified in Section 09880.

**BID ITEM NO. 5 REMOVAL AND DISPOSAL OF RESIDUAL SOLIDS, GRIT, AND DEBRIS**

- A. The quantity of residual solids, grit, and debris to be paid for under Item 5 shall be by the cubic yard of residuals disposed of. The bid quantity for this Item includes work associated with the Final Clarifiers (Additive Alternative #1). If Alternative #1 is not awarded, the quantity of this Item shall be reduced accordingly.
- B. Payment of the unit price bid in the Bid Form for Item No. 5 shall constitute full compensation for all labor, material, tools, equipment and incidentals necessary for removing and disposing of residual solids, grit and debris.

**1.05 PAYMENTS, PART I AND II**

- A. Payment of the total price bid in the General Bid for Part I, together with the lump sums bid in the Sub-bid for Part II, shall fully compensate the Contractor for furnishing all labor, materials, equipment and incidentals required to complete the work as outlined above and under Section 01010. Payment shall also include

compensation for all other work required to complete the Project as described in the Contract Documents and not specifically mentioned under Part I or II.

1.06 EXTRA WORK

- A. Extra work, if any, will be performed and paid for in accordance with the Owner Contractor Agreement, General Conditions and Supplementary Conditions.

END OF SECTION

SECTION 01026

SCHEDULE OF VALUES

PART 1 GENERAL

1.01 SUMMARY

A. Section Includes

1. Requirements for breakdown of lump sum bid.

B. Related Sections

1. Section 01300 - Submittals

1.02 BREAKDOWN OF LUMP SUM BID

A. Within 20 business days of the date of the executed Contract, a list detailing the breakdown of the lump sums bid by the appropriate Divisions of these Specifications or as otherwise directed by the Engineer, shall be submitted for review and concurrence by the Engineer. This list will be used by the Engineer as a guide in preparing estimates for payment. The list shall be an accurate representation of costs required to complete the Work in accordance with the Contract Documents.

B. A schedule of the monthly value of work done based on the Progress Schedule submitted under Section 01300 - Submittals shall be submitted within 20 business days of the date of the executed Contract. The schedule shall show the total sum of work done for each month of the projected construction period and shall be updated monthly to reflect the actual amount requisitioned for payment.

PART 2 PRODUCTS

NOT USED

PART 3 EXECUTION

NOT USED

END OF SECTION

## SECTION 01035

### MODIFICATION PROCEDURES

#### PART 1 GENERAL

##### 1.01 SUMMARY

###### A. Section Includes

1. Procedures for making modifications to the Contract by change orders or other means.

###### B. Related Sections

1. Document 00500 - Agreement

##### 1.02 CHANGE ORDERS

A. In general Change Orders will be issued for modification of Contract documents which will incorporate changes in the Contract requirements, including additions or deletions in the Work; for unforeseen field conditions which will necessitate changes in the Work; changes in code provisions or other requirements of federal, state or local authority requiring changes in the Work; changes in the availability of products or for incorporating new products into the work and for changes directed by the Engineer for the benefit of the Owner.

B. Authority to execute Change Orders shall be that of the Owner and not of the Contractor. Changes Orders will, in general, originate by a "Change Order Proposal Request" or by issuance of a "Construction Change Authorization".

C. Unless authorized by the Owner, no work shall be performed that is involved in the change until a formal Change Order is issued.

D. To initiate a Change Order, the Owner will forward a Change Order proposal request describing the proposed changes and if required, include additional or revised drawings and specifications soliciting a formal quotation of cost and time to complete the proposed Change Order work. Upon reaching mutual agreement on the cost and time, the Engineer will sign his approval of the Change Order and submit it to the Contractor for his full signature of acceptance.

##### 1.03 FIELD ORDERS

A. The Owner may, to avoid costly removal of, or alterations to, present on-going work, issue a Work Directive Change authorizing the Contractor to proceed, subject to later negotiation of the price of the change.

##### 1.04 PRICE AGREEMENTS

A. Prices agreed upon to cover the Change Orders may be either by mutual acceptance of a lump sum or by unit prices as stated in the Contract bid proposal or actual direct cost plus a percentage for overhead, profit and other expenses consistent with Section 00500 – Contract Agreement.

- B. Work done by a subcontractor entitles the General Contractor a percentage of the sum of the actual direct cost, not including the subcontractor's overhead and profit, consistent with Section 00500 – Contract Agreement.
- C. Method for computing the cost of the change shall be based on the net additional increase. No overhead and profit shall be deducted from prices for changes deleting work.
- D. The Change Order form document shall indicate the net adjustment (+/-) to the total Contract price as a result thereof including extension or reduction of time when applicable.

PART 2 PRODUCTS

NOT USED

PART 3 EXECUTION

NOT USED

END OF SECTION

SECTION 01040

COORDINATION

PART 1 GENERAL

1.01 SECTION INCLUDES

- A. Requirements for coordinating the various parts of Work under this Contract.

1.02 REQUIREMENTS

- A. Coordinate scheduling, submittals, and Work of the various Sections of specifications to assure efficient and orderly sequence of installation of interdependent construction elements.
- B. Verify that utility requirement characteristics of operating equipment are compatible with building utilities. Coordinate work of various Sections having interdependent responsibilities for installing, connecting to, and placing in service, such equipment.
- C. Coordinate space requirements and installation of mechanical, instrumentation and electrical work, which are indicated diagrammatically on Drawings. Follow routing shown for pipes, ducts, and conduit, as closely as practicable; place runs parallel with line of building. Utilize spaces efficiently to maximize accessibility for other installations, for maintenance, and for repairs.
- D. In finished areas except as otherwise indicated, conceal pipes, ducts, and wiring within the construction. Coordinate locations of fixtures and outlets with finish elements.
- E. Coordinate completion and clean up of Work of separate Sections in preparation for Substantial Completion.
- F. After Owner occupancy of premises, coordinate access to site for correction of defective Work and Work not in accordance with Contract Documents, to minimize disruption of Owner's activities.
- G. Coordinate work with all utility companies necessary for completion of work under this contract.

PART 2 PRODUCTS

NOT USED

PART 3 EXECUTION

NOT USED

END OF SECTION



## SECTION 01045

### CUTTING, CORING AND PATCHING

#### PART 1 GENERAL

##### 1.01 SUMMARY

###### A. Section Includes

1. Requirements and limitations for cutting, coring and patching of Work.

###### B. Related Sections

1. Section 01300-Submittals

##### 1.02 SUBMITTALS

###### A. In accordance with Section 01300 submit written request in advance of cutting or alteration which affects the following:

1. Structural integrity of any element of Project.
2. Integrity of weather-exposed or moisture-resistant element.
3. Efficiency, maintenance, or safety of any operational element.
4. Visual qualities of sight exposed elements.
5. Work of Owner or separate contractor.

###### B. Include in request:

1. Identification of Project.
2. Location and description of affected work.
3. Necessity for cutting or alteration.
4. Description of proposed work, and products to be used.
5. Alternatives to cutting and patching.
6. Effect on work of Owner or separate contractor.
7. Written permission of affected separate contractor.
8. Date and time work will be executed.

###### C. Should conditions of the Work, or schedule, indicate a required change of materials or methods for cutting and patching, notify the Engineer and secure his written permission and the required Change Order prior to proceeding.

##### 1.03 RELATED SECTIONS

###### A. Section 11961 – Interior and Exterior Process Piping

###### B. Section 15050 – Pipe Sleeves

## PART 2 PRODUCTS

### 2.01 MATERIALS

- A. For replacement of items removed, use materials complying with pertinent sections of these specifications.
- B. Sealing materials to be used to seal annular space between cored hole in walls and related pipes to be in accordance with Section 11961.
- C. Sealing cored holes in sewer manholes to be with a resilient seal similar to Kor-N-Seal made by National Pollution Control Systems, Inc., Nashua, NH or similar product, as indicated on the Drawings.

## PART 3 EXECUTION

### 3.01 EXAMINATION

- A. Site Verification of Conditions
  - 1. Inspect existing conditions, including elements subject to movement or damage during cutting, excavating, patching, and backfilling.
  - 2. After uncovering the work, inspect conditions affecting installation of new work.
  - 3. If uncovered conditions are not as anticipated, immediately notify the Engineer.
  - 4. Do not proceed until unsatisfactory conditions are corrected.

### 3.02 PREPARATION

- A. Protection
  - 1. Provide required protection including, but not necessarily limited to, shoring, bracing, and support to maintain structural integrity of the Work.
  - 2. Perform cutting and demolition by methods which will prevent damage to portions of the Work.
- B. Surface Preparation
  - 1. Provide proper surfaces to receive installation of repair and new work.

### 3.03 INSTALLATION

- A. Use adequate numbers of skilled workmen who are trained and experienced in the necessary crafts and who are familiar with the specified requirements and the methods needed for proper performance of the Work.
- B. Execute cutting, fitting, and patching (including excavation and fill) to complete work.
- C. Installation of materials shall be in accordance with manufacturer's instructions.
- D. Installations, repair or replacement of items provided under this Contract shall be in accordance with the Contract Documents.

### 3.04 FIELD QUALITY CONTROL

- A. In addition to other requirements specified, upon the Engineer's request uncover work to provide for inspection by the Engineer of covered work, and remove samples of installed materials for testing.
- B. Do not cut or alter work performed under separate contracts without the Engineer's written permission.

### 3.05 ADJUSTING

- A. Perform fitting and adjusting of products to provide finished installation complying with the specified tolerances and finishes.

END OF SECTION

SECTION 01050  
FIELD ENGINEERING

PART 1 GENERAL

1.01 SECTION INCLUDES

- A. Survey work and other field engineering responsibilities of the Contractor.

1.02 REQUIREMENTS

- A. The Contractor shall be responsible for layout of the work and the establishing of lines and grades.
- B. Establish elevations, lines, levels, reference marks, batter boards, etc., required during the progress of the Work. Verify such marks by instrument to confirm accuracy.
- C. Locate and protect survey control and reference points.
- D. Make, check, and be responsible for all measurements and dimensions necessary for the proper construction of the Work.
- E. The Engineer will be permitted to check the lines, elevations, reference marks, batter boards, etc., set by the Contractor. The Contractor shall correct any errors found in lines, elevations, reference marks, batter boards, etc.. Such a check shall not be construed as approval of the Contractor's work and shall not relieve or diminish the responsibility of the Contractor for the accurate construction and completion of the Work.
- F. Control datum for survey as shown on Drawings.

1.03 QUALITY ASSURANCE

- A. Qualifications
  - 1. Employ a Civil Engineer or Land Surveyor registered within the Commonwealth of Massachusetts, acceptable to the Engineer.
- B. Certifications
  - 1. Submit certificate signed by the Contractor's Engineer or Land Surveyor stating elevations and locations of the Work are in conformance with the Contract Documents.

PART 2 PRODUCTS

NOT USED

PART 3 EXECUTION

NOT USED

END OF SECTION

## SECTION 01060

### PERMITS

#### PART 1 GENERAL

##### 1.01 SECTION INCLUDES

- A. Building codes, Mechanical codes, and Electrical codes, Regulations, Permits and Fees applicable to the project.

##### 1.02 PERMITS BY CONTRACTOR

- A. The Contractor shall secure all necessary permits from the state, city or town authorities having jurisdiction, for digging of trenches in the streets or highways and all other building and construction operations requiring permits.
- B. As a minimum the following permits are required:
  - 1. Building Permit – City of Taunton
  - 2. National Pollutant Discharge Elimination System (NPDES) General Permit for Dewatering Activity Discharge, Permit No. MAG070000.
  - 3. City of Taunton Contractor's License
    - a. Contractor's License Requirements and Application is attached to this specification section.
  - 4. Trench Permit (Jackie's Law) – City of Taunton Dept. of Public Works
    - a. The Permit Application Form is attached to this Specification Section

##### 1.03 PERMITS BY OWNER

- A. The Owner has obtained or will obtain and pay all fees for the permits listed here:
  - 1. Order of Conditions – Local Conservation Commission
  - 2. WM 16 - Treatment Works Plan Approval, without Permit Modification - MassDEP

##### 1.04 CODES

- A. The Contractor shall conform to the requirements of and pay all fees imposed by local and State Building Authorities having jurisdiction over the Work. The Contractor is responsible to conform to all building, mechanical, electrical and plumbing code requirements.
- B. The Contractor shall conform to the latest requirements of the following codes:
  - 1. Federal, State and Municipal Laws
  - 2. 2009 International Building Code (IBC)
  - 3. 2009 International Energy Conservation Code (IECC)
  - 4. Commonwealth of Massachusetts State Building Code, 780 CMR
  - 5. Commonwealth of Massachusetts State Plumbing Code 248 CMR 10.00
  - 6. Commonwealth of Massachusetts Electrical Code 527 CMR 12.00
  - 7. Massachusetts Architectural Access Board (521 CMR)
  - 8. Massachusetts Board of Fire Prevention Regulations (527 CMR)

9. OSHA

10. Any prevailing rules and regulations pertaining to adequate protection and/or guarding of any moving parts or otherwise hazardous locations.

1.04 FEES

- A. The cost of all permits secured by the Contractor shall be borne by him and shall be considered as having been included in the price or prices stated in the Bid. Copies of all required permits shall be filed with the Engineer prior to starting work for which a permit is required.

PART 2 PRODUCTS

NOT USED

PART 3 EXECUTION

NOT USED

END OF SECTION



# City of Taunton

Department of Public Works Commissioner's Office

**Contractor Licensing Requirements & Application**

## **Construction Contract Year**

**May 1<sup>st</sup> 2021 to April 30<sup>th</sup> 2022**

Prepared by:

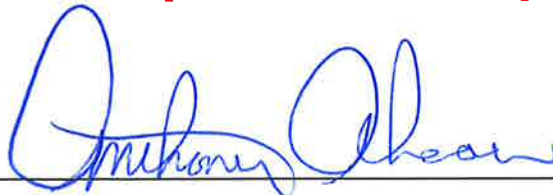
 3/30/2021

Tony Abreau: Assistant Commissioner, Taunton Public Works

Approved by:

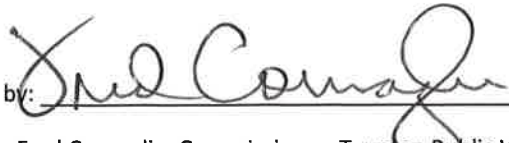
 3/30/21

Fred Cornaglia: Commissioner, Taunton Public Works



**City of Taunton**  
**Department of Public Works Commissioner's Office**  
**Contractor Licensing Requirements**

Contractors are licensed by the City of Taunton (City) through the Department of Public Works Commissioner's Office (DPW). Only licensed contractors may work in the City's layout of a public way to install or work on driveways and underground utilities such as water, sewer, drainage, gas, electrical, or road construction.

**1.0 Licensing Requirements:**

**1.1: Only utility contractors licensed by or contractors working directly for the City of Taunton are allowed to work within the limits of the city streets, sidewalks, easement, layouts, or right-of-ways, or to make connections to municipal storm drains, sewers, or water lines.**

**1.2: To assure faithful performance of all work and to indemnify the city against any loss or damage from negligent or defective work a yearly bond in the amount of either \$50,000.00 for road projects or \$5,000.00 for sewer laterals, must be submitted by all contractor applicants. For larger projects, the DPW Commissioner's Office may require the bond to be increased.**

**1.3: To the fullest extent not prohibited by laws and regulations, the contractor shall indemnify, hold harmless and defend the City of Taunton, its officers, employees, and agents from and against all claims, cost, losses, and damages, including but not limited to attorney's fees, caused by, arising out of, or relating to any claim of action against the City of Taunton, provided that any such claim, cost, loss or damage is caused in whole or in part by any negligent act or omission of the contractor, its employees, agents, or anyone for whose acts any of them may be liable.**

**1.4: Each contractor shall provide to the City of Taunton a Certificate of Insurance (COI) providing evidence of the following.**

- 1. Commercial General Liability (CGL) with limits of not less than \$1,000,000.00 each occurrence and \$2,000,000.00 Annual Aggregate. If the CGL coverage contains a General Aggregate Limit, such General Aggregate shall apply separately to each project. CGL coverage shall be written on ISO Occurrence Form CG 00 01 (1093) or a substitute form providing equivalent coverage and shall cover liability arising from collapse, explosive hazards, underground work by equipment on the street, premises, completed operations, independent contractors, and personal injury. The City of Taunton shall be listed as "additional insured" on the CGL policy.**



## **2. Automobile Liability**

**A: Business Auto Liability with limits of as least \$1,000,000.00 each accident;**

**B: Business Auto coverage must include coverage for liability arising out of all owned, leased, hired, and non-owned automobiles.**

## **3. Workers Compensation and Employers Liability**

**Employers Liability Insurance limits of at least \$500,000.00 each accident for bodily injury by accident and \$500,000.00 each employee for injury by disease.**

### **1.5**

**Applications for a contractor's license shall be submitted to the City Department of Public Works Commissioner for approval or disapproval.**

### **1.6**

**Each license shall be granted for one year from May 1<sup>st</sup> until April 30<sup>th</sup> of the following year, and the required bond and certificate of insurance shall be co-terminus with the license. Such license may be suspended for cause by the City Council at its next meeting.**

### **1.7**

**Every Corporation shall submit with its application a copy of its current annual Certificate of Good Standing and a copy of any subsequent certificate of change of corporate officers on file with the Secretary of State as required by M.G.L.c. 156. SS 24 AND 27.**

## **2.0 Schedule of License Fees**

**Licensed road opening and utility contractor fees are as follows:**

<b>Initial Application Fee</b>	<b>\$500.00</b>
<b>Annual Renewal Fee</b>	<b>\$250.00</b>

## **3.0 License Application**

**Complete the License Application identified as Exhibit A**

# Exhibit A: Contractor License Application



City of Taunton  
Department of Public Works  
Commissioner's Office

---

Company Name:

Owners Name:

Street Address:

City:

State:

Zip Code:

Telephone #:

E-mail:

Country:

Dunn & Bradstreet #:

Federal Employee ID #:

Point of Contact:

Point of Contact Phone #:

Website (Optional)

E-mail:

What areas does your company serve?:

S.E Mass

Metro Boston

W. Mass

N. Mass

Mass (ALL)

RI

CT

NH

NY

NJ

PA

Other

Primary SIC Code

Secondary SIC Code

Date company was founded?

Gross Annual Sales:

\$0-\$49,999	\$50,000-\$99,999	\$100,000-\$499,999
\$500,000-\$999,999	\$1,000,000-\$2,499,999	
\$2,500,000-\$4,999,999	\$5,000,000-\$10,000,000	
Over \$10,000,000		

Number of Employees:

1-10	10-20	20-30
30-50	Over 50 Employees	

Bonding Capacity:

\$0-\$49,999	\$50,000-\$99,999	\$1000,000-\$499,999
\$500,000-\$999,999	\$1,000,000-\$2,499,99	
\$2,500,000-\$4,999,999	\$5,000,000-\$10,000,000	
Over \$10,000,000		

Business Structure:

Profit	Non-Profit	S Corporation	C Corporation
Sole Proprietor	Partnership	Joint Venture	LLC

---

**Qualifications**

What contractor licenses do you currently hold in Massachusetts?

In which Municipalities in Massachusetts do you currently hold open road licenses?

Please identify Massachusetts contractor license (s) you have that are currently active. (Include license (s) number, type of contractor's license, and expiration date)

Please provide at least 4 business references including your current bonding company.

---

Largest Contract:

\$0-\$49,999

\$50,000-\$99,999

\$100,000-\$499,999

\$500,000-\$999,999

\$1,000,000-\$2,499,999

\$2,500,000-\$4,999,999

\$5,000,000-\$10,000,000

Over \$10,000,000

Contracting agency for largest contract?

Company comments (Include a brief description of the goods and/or services your company provides):

Name of President or CEO?:

Date:

Telephone Number:

E-mail:

Name of individual completing this form?

Telephone Number:

E-mail:

Signature of individual completing the form.

Date



# City of Taunton

Permit issued by: Department of Public Works  
 90 Ingel Street  
 Taunton, Massachusetts 02780  
 Phone (508) 821-1431  
 FAX (508) 821-1059

Permit Number \_\_\_\_\_

Date Issued \_\_\_\_\_

Expiration Date \_\_\_\_\_

## TRENCH PERMIT APPLICATION

Pursuant to G.L. c. 82A §1 and 520 CMR 7.00 et seq.(as amended)

### Submittals Normally Processed in 5 Business Days

Name of Applicant			Phone	Cell
Applicant Street Address				
City/Town	ST	ZIP		
Name of Excavator (if different from applicant)			Phone	Cell
Excavator Street Address				
City/Town	ST	ZIP		
Name of Property Owner(s)			Phone	Cell
Trench Address				
City/Town	ST	ZIP		
Email			Permit Fee Received No ( ) Yes ( )	
Description, location and purpose of proposed trench: Please describe the exact location of the proposed trench and its purpose (include a description of what is (or is intended) to be laid in proposed trench (eg; pipes/cable lines etc.) Please use reverse side if additional space is needed.				
Insurance Certificate #:				
Name and Contact Information of Insurer:				
Policy Expiration Date:				
Dig Safe #:				
Name of Competent Person (as defined by 520 CMR 7.02):				
Massachusetts Hoisting License #			Expiration Date:	
License Grade:				

**THIS PERMIT MUST BE FULLY COMPLETED PRIOR TO CONSIDERATION**

BY SIGNING THIS FORM, THE APPLICANT, OWNER, AND EXCAVATOR ALL ACKNOWLEDGE AND CERTIFY THAT THEY ARE FAMILIAR WITH, OR, BEFORE COMMENCEMENT OF THE WORK, WILL BECOME FAMILIAR WITH, ALL LAWS AND REGULATIONS APPLICABLE TO WORK PROPOSED, INCLUDING OSHA REGULATIONS, G.L. c. 82A, 520 CMR 7.00 et seq., AND ANY APPLICABLE MUNICIPAL ORDINANCES, BY-LAWS AND REGULATIONS AND THEY COVENANT AND AGREE THAT ALL WORK DONE UNDER THE PERMIT ISSUED FOR SUCH WORK WILL COMPLY THEREWITH IN ALL RESPECTS AND WITH THE CONDITIONS SET FORTH BELOW.

THE UNDERSIGNED OWNER AUTHORIZES THE APPLICANT TO APPLY FOR THE PERMIT AND THE EXCAVATOR TO UNDERTAKE SUCH WORK ON THE PROPERTY OF THE OWNER, AND ALSO, FOR THE DURATION OF CONSTRUCTION, AUTHORIZES PERSONS DULY APPOINTED BY THE MUNICIPALITY TO ENTER UPON THE PROPERTY TO MONITOR AND INSPECT THE WORK FOR CONFORMITY WITH THE CONDITIONS ATTACHED HERETO AND THE LAWS AND REGULATIONS GOVERING SUCH WORK.

THE UNDERSIGNED APPLICANT, OWNER AND EXCAVATOR AGREE JOINTLY AND SEVERALLY TO REIMBURSE THE MUNICIPALITY FOR ANY AND ALL COSTS AND EXPENSES INCURRED BY THE MUNICIPALITY IN CONNECTION WITH THIS PERMIT AND THE WORK CONDUCTED THEREUNDER, INCLUDING BUT NOT LIMITED TO ENFORCING THE REQUIREMENTS OF STATE LAW AND CONDITIONS OF THIS PERMIT, INSPECTIONS MADE TO ASSURE COMPLIANCE THEREWITH, AND MEASURES TAKEN BY THE MUNICIPALITY TO PROTECT THE PUBLIC WHERE THE APPLICANT OWNER OR EXCAVATOR HAS FAILED TO COMPLY THEREWITH INCLUDING POLICE DETAILS AND OTHER REMEDIAL MEASURES DEEMED NECESSARY BY THE MUNICIPALITY.

THE UNDERSIGNED APPLICANT, OWNER AND EXCAVATOR AGREE JOINTLY AND SEVERALLY TO DEFEND, INDEMNIFY, AND HOLD HARMLESS THE MUNICIPALITY AND ALL OF ITS AGENTS AND EMPLOYEES FROM ANY AND ALL LIABILITY, CAUSES OR ACTION, COSTS, AND EXPENSES RESULTING FROM OR ARISING OUT OF ANY INJURY, DEATH, LOSS, OR DAMAGE TO ANY PERSON OR PROPERTY DURING THE WORK CONDUCTED UNDER THIS PERMIT.

**APPLICANT SIGNATURE**

\_\_\_\_\_ **DATE** \_\_\_\_\_

**EXCAVATOR SIGNATURE (IF DIFFERENT)**

\_\_\_\_\_ **DATE** \_\_\_\_\_

**OWNER'S SIGNATURE (IF DIFFERENT)**

\_\_\_\_\_ **DATE** \_\_\_\_\_

For City/Town use -- Do not write in this section	
<b>PERMIT APPROVED BY</b>	\$ _____ <b>Application Fee</b>
<b>PERMITTING AUTHORITY</b> <b>Date</b>	
<b>CONDITIONS OF APPROVAL</b>	

**CONDITIONS AND REQUIREMENTS PURSUANT TO G.L.C.82A AND 520 CMR 7.00 et seq. (as amended)**

By signing the application, the applicant understands and agrees to comply with the following:

No trench may be excavated unless the requirements of sections 40 through 40D of chapter 82, and any accompanying regulations, have been met and this permit is invalid unless and until said requirements have been complied with by the excavator applying for the permit including, but not limited to, the establishment of a valid excavation number with the underground plant damage prevention system as said system is defined in section 76D of chapter 164 (DIG SAFE);

Trenches may pose a significant health and safety hazard. Pursuant to Section 1 of Chapter 82 of the General Laws, an excavator shall not leave any open trench unattended without first making every reasonable effort to eliminate any recognized safety hazard that may exist as a result of leaving said open trench unattended. Excavators should consult regulations promulgated by the Department of Public Safety in order to familiarize themselves with the recognized safety hazards associated with excavations and open trenches and the procedures required or recommended by said department in order to make every reasonable effort to eliminate said safety hazards which may include covering, barricading or otherwise protecting open trenches from accidental entry.

Persons engaging in any in any trenching operation shall familiarize themselves with the federal safety standards promulgated by the Occupational Safety and Health Administration on excavations: 29 CFR 1926.650 et.seq., entitled

Subpart P "Excavations".

Excavators engaging in any trenching operation who utilize hoisting or other mechanical equipment subject to chapter 146 shall only employ individuals licensed to operate said equipment by the Department of Public Safety pursuant to said chapter and this permit must be presented to said licensed operator before any excavation is commenced;

By applying for, accepting and signing this permit, the applicant hereby attests to the following: (1) that they have read and understands the regulations promulgated by the Department of Public Safety with regard to construction related excavations and trench safety; (2) that he has read and understands the federal safety standards promulgated by the Occupational Safety and Health Administration on excavations: 29 CFR 1926.650 et seq., entitled Subpart P "Excavations" as well as any other excavation requirements established by this municipality; and (3) that he is aware of and has, with regard to the proposed trench excavation on private property or proposed excavation of a city or town public way that forms the basis of the permit application, complied with the requirements of sections 40-40D of chapter 82A.

This permit shall be posted in plain view on the site of the trench.

**For additional information please visit the Department of Public Safety's website at [www.mass.gov/dps](http://www.mass.gov/dps)**

#### Summary of Excavation and Trench Safety Regulation (520 CMR 14.00 et seq.)

This summary was prepared by the Massachusetts Department of Public Safety pursuant to G.L.c.82A and does not include all requirements of the 520 CMR 14.00. To view the full regulation and G.L.c.82A, go to [www.mass.gov/dps](http://www.mass.gov/dps) Pursuant to M.G.L. c. 82, § 1, the Department of Public Safety, jointly with the Division of Occupational Safety, drafted regulations relative to trench safety. The regulation is codified in section 14.00 of title 520 of the Code of Massachusetts Regulations. The regulation requires all excavators to obtain a permit prior to the excavation of a trench made for a construction-related purpose on public or private land or rights-of-way. All municipalities must establish a local permitting authority for the purpose of issuing permits for trenches within their municipality. Trenches on land owned or controlled by a public (state) agency requires a permit to be issued by that public agency unless otherwise designated.

In addition to the permitting requirements mandated by statute, the trench safety regulations require that all excavators, whether public or private, take specific precautions to protect the general public and prevent unauthorized access to unattended trenches. Accordingly, unattended trenches must be covered, barricaded or backfilled. Covers must be road plates at least ¾" thick or equivalent; barricades must be fences at least 6' high with no openings greater than 4" between vertical supports; backfilling must be sufficient to eliminate the trench. Alternatively, excavators may choose to attend trenches at all times, for instance by hiring a police detail, security guard or other attendant who will be present during times when the trench will be unattended by the excavator.

The regulations further provide that local permitting authorities, the Department of Public Safety, or the Division of Occupational Safety may order an immediate shutdown of a trench in the event of a death or serious injury; the failure to obtain a permit; or the failure to implement or effectively use adequate protections for the general public. The trench shall remain shutdown until re-inspected and authorized to re-open provided, however, that excavators shall have the right to appeal an immediate shutdown. Permitting authorities are further authorized to suspend or revoke a permit following a hearing. Excavators may also be subject to administrative fines issued by the Department of Public Safety for identified violations.

#### Summary of 1926 CFR Subpart P -OSHA Excavation Standard

This is a worker protection standard, and is designed to protect employees who are working inside a trench. This summary was prepared by the Massachusetts Division of Occupational Safety and not OSHA for informational purposes only and does not constitute an official interpretation by OSHA of their regulations, and may not include all aspects of the standard. For further information or a full copy of the standard go to [www.osha.gov](http://www.osha.gov).

#### **Trench Definition per the OSHA standard:**

An excavation made below the surface of the ground, narrow in relation to its length.

In general, the depth is greater than the width, but the width of the trench is not greater than fifteen feet.

**Protective Systems** to prevent soil wall collapse are always required in trenches deeper than 5', and are also required in trenches less than 5' deep when the competent person determines that a hazard exists. Protection options include: Shoring. Shoring must be used in accordance with the OSHA Excavation standard appendices, the equipment manufacturer's tabulated data, or designed by a registered professional engineer.

Shielding (Trench Boxes). Trench boxes must be used in accordance with the equipment manufacturer's tabulated data, or a registered professional engineer.

Sloping or Benching. In Type C soils (what is most typically encountered) the excavation must extend horizontally 1 ½ feet for every foot of trench depth on both sides, 1 foot for Type B soils, and ¾ foot for Type A soils.

A registered professional engineer must design protective systems for all excavations greater than 20' in depth.



**Ladders** must be used in trenches deeper than 4'.

Ladders must be inside the trench with workers at all times, and located within 25' of unobstructed lateral travel for every worker in the trench.

Ladders must extend 3' above the top of the trench so workers can safely get onto and off of the ladder.

**Inspections** of every trench worksite are required:

Prior to the start of each shift, and again when there is a change in conditions such as a rainstorm.

Inspections must be conducted by the competent person (see below).

**Competent Person(s) is:**

Capable (i.e., trained and knowledgeable) in identifying existing and predictable hazards in the trench, and other working conditions which may pose a hazard to workers, and

Authorized by management to take necessary corrective action to eliminate the hazards. Employees must be removed from hazardous areas until the hazard has been corrected.

**Underground Utilities** must be:

Identified prior to opening the excavation (e.g., contact Digsafe).

Located by safe and acceptable means while excavating.

Protected, supported, or removed once exposed.

**Spoils** must be kept back a minimum of 2' from the edge of the trench.

**Surface Encumbrances** creating a hazard must be removed or supported to safeguard employees. Keep heavy equipment and heavy material as far back from the edge of the trench as possible.

**Stability of Adjacent Structures:**

Where the stability of adjacent structures is endangered by creation of the trench, they must be underpinned, braced, or otherwise supported.

Sidewalks, pavements, etc. shall not be undermined unless a support system or other method of protection is provided.

**Protection from water accumulation hazards:**

It is not allowable for employees to work in trenches with accumulated water. If water control such as pumping is used to prevent water accumulation, this must be monitored by the competent person.

If the trench interrupts natural drainage of surface water, ditches, dikes or other means must be used to prevent this water from entering the excavation.

**Additional Requirements:**

For mobile equipment operated near the edge of the trench, a warning system such as barricades or stop logs must be used.

Employees are not permitted to work underneath loads. Operators may not remain in vehicles being loaded unless vehicles are equipped with adequate protection as per 1926.601 (b)(6).

Employees must wear high-visibility clothing in traffic work zones.

Air monitoring must be conducted in trenches deeper than 4' if the potential for a hazardous atmosphere exists. If a hazardous atmosphere is found to exist (e.g., O<sub>2</sub> <19.5% or >23.5%, 20% LEL, specific chemical hazard), adequate protections shall be taken such as ventilation of the space.

Walkways are required where employees must cross over the trench. Walkways with guardrails must be provided for crossing over trenches > 6' deep.

Employees must be protected from loose rock or soil through protections such as scaling or protective barricades.



*City of Taunton, Massachusetts*  
**CONSERVATION  
COMMISSION**

*Office: 1298 Cohannet Street  
Mailing: 15 Summer Street  
Taunton, Massachusetts 02780*

*Conservation Commissioners*

*Steven Turner, Chair  
Debra Botellio, Vice Chair  
Joshua Borden  
Richard Enos  
Luis Freitas  
Matthew Haggerty  
Jan Rego*

*Phone 508-821-1095 Fax 508-821-1665*

November 18, 2020

BETA Group, Inc. – Nicole Iannuzzi  
701 George Washington Hwy  
Lincoln, RI 02865

**RE: 825 West Water Street SE73-2881**

Attached you will find the original Order of Conditions for the location noted above **which needs to be recorded at the Registry of Deeds within 40 days of receipt**. Upon the recording of this document, please forward a copy of the receipt showing date, book and page of the recording to this office for our records. Please be sure to include “project location” and DEP number (**SE73-2881**).

If you have any questions please do not hesitate to give this office a call. Thanks for your assistance in this matter.

Sincerely,

*Steven Turner*  
*DI*

Steven Turner, Chair  
Conservation Commission

Cc: DEP  
COT/DPW-Fred Cornaglia



**Massachusetts Department of Environmental Protection**  
**Bureau of Resource Protection - Wetlands**  
**WPA Form 5 – Order of Conditions**  
 Massachusetts Wetlands Protection Act M.G.L. c. 131, §40

Provided by MassDEP:  
 SE73-2881  
 MassDEP File #  
 eDEP Transaction #  
 Taunton  
 City/Town

**A. General Information**

Please note: this form has been modified with added space to accommodate the Registry of Deeds Requirements

**Important:** When filling out forms on the computer, use only the tab key to move your cursor - do not use the return key.

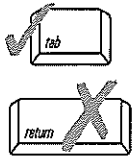

1. From: Taunton  
 Conservation Commission

2. This issuance is for (check one):  
 a.  Order of Conditions      b.  Amended Order of Conditions

3. To: Applicant:  
 Fred Cornaglia  
 a. First Name      b. Last Name  
 City of Taunton/DPW  
 c. Organization  
 90 Ingell Street  
 d. Mailing Address  
 Taunton      MA      02780  
 e. City/Town      f. State      g. Zip Code

4. Property Owner (if different from applicant):  
 \_\_\_\_\_  
 a. First Name      b. Last Name  
 City of Taunton  
 c. Organization  
 15 Summer Street  
 d. Mailing Address  
 Taunton      MA      02780  
 e. City/Town      f. State      g. Zip Code

5. Project Location:  
 825 West Water Street      Taunton  
 a. Street Address      b. City/Town  
 105      159  
 c. Assessors Map/Plat Number      d. Parcel/Lot Number  
 Latitude and Longitude, if known:      d      m      s      d      m      s  
 d. Latitude      e. Longitude



**Massachusetts Department of Environmental Protection**  
 Bureau of Resource Protection - Wetlands  
**WPA Form 5 – Order of Conditions**  
 Massachusetts Wetlands Protection Act M.G.L. c. 131, §40

Provided by MassDEP:  
 SE73-2881  
 MassDEP File #

eDEP Transaction #  
 Taunton  
 City/Town

**A. General Information (cont.)**

6. Property recorded at the Registry of Deeds for (attach additional information if more than one parcel):

_____		_____	
a. County		b. Certificate Number (if registered land)	
_____		_____	
c. Book		d. Page	

7. Dates: 11/2/2020 11/16/2020 11/18/2020  
 a. Date Notice of Intent Filed b. Date Public Hearing Closed c. Date of Issuance

8. Final Approved Plans and Other Documents (attach additional plan or document references as needed):

Wastewater Treatment Facility

_____		_____	
a. Plan Title		b. Prepared By	
BETA Inc.		Joseph Federico, Jr.	
10/30/2020		c. Signed and Stamped by	
d. Final Revision Date		1"=40'	
		e. Scale	
_____		_____	
f. Additional Plan or Document Title		g. Date	

**B. Findings**

1. Findings pursuant to the Massachusetts Wetlands Protection Act:

Following the review of the above-referenced Notice of Intent and based on the information provided in this application and presented at the public hearing, this Commission finds that the areas in which work is proposed is significant to the following interests of the Wetlands Protection Act (the Act). Check all that apply:

- |   |  |  |
|---|--|--|
| a. <input type="checkbox"/> Public Water Supply             | b. <input type="checkbox"/> Land Containing Shellfish          | c. <input checked="" type="checkbox"/> Prevention of Pollution |
| d. <input checked="" type="checkbox"/> Private Water Supply | e. <input type="checkbox"/> Fisheries                          | f. <input type="checkbox"/> Protection of Wildlife Habitat     |
| g. <input checked="" type="checkbox"/> Groundwater Supply   | h. <input checked="" type="checkbox"/> Storm Damage Prevention | i. <input checked="" type="checkbox"/> Flood Control           |

2. This Commission hereby finds the project, as proposed, is: (check one of the following boxes)

Approved subject to:

- a.  the following conditions which are necessary in accordance with the performance standards set forth in the wetlands regulations. This Commission orders that all work shall be performed in accordance with the Notice of Intent referenced above, the following General Conditions, and any other special conditions attached to this Order. To the extent that the following conditions modify or differ from the plans, specifications, or other proposals submitted with the Notice of Intent, these conditions shall control.



**Massachusetts Department of Environmental Protection**  
 Bureau of Resource Protection - Wetlands  
**WPA Form 5 – Order of Conditions**  
 Massachusetts Wetlands Protection Act M.G.L. c. 131, §40

Provided by MassDEP:  
 SE73-2881  
 MassDEP File # \_\_\_\_\_

eDEP Transaction # \_\_\_\_\_  
 Taunton  
 City/Town

**B. Findings (cont.)**

Denied because:

- b.  the proposed work cannot be conditioned to meet the performance standards set forth in the wetland regulations. Therefore, work on this project may not go forward unless and until a new Notice of Intent is submitted which provides measures which are adequate to protect the interests of the Act, and a final Order of Conditions is issued. **A description of the performance standards which the proposed work cannot meet is attached to this Order.**
- c.  the information submitted by the applicant is not sufficient to describe the site, the work, or the effect of the work on the interests identified in the Wetlands Protection Act. Therefore, work on this project may not go forward unless and until a revised Notice of Intent is submitted which provides sufficient information and includes measures which are adequate to protect the Act's interests, and a final Order of Conditions is issued. **A description of the specific information which is lacking and why it is necessary is attached to this Order as per 310 CMR 10.05(6)(c).**
- 3.  Buffer Zone Impacts: Shortest distance between limit of project disturbance and the wetland resource area specified in 310 CMR 10.02(1)(a) \_\_\_\_\_ a. linear feet

**Inland Resource Area Impacts:** Check all that apply below. (For Approvals Only)

Resource Area	Proposed Alteration	Permitted Alteration	Proposed Replacement	Permitted Replacement
4. <input checked="" type="checkbox"/> Bank	0 a. linear feet	0 b. linear feet	_____ c. linear feet	_____ d. linear feet
5. <input type="checkbox"/> Bordering Vegetated Wetland	_____ a. square feet	_____ b. square feet	_____ c. square feet	_____ d. square feet
6. <input type="checkbox"/> Land Under Waterbodies and Waterways	_____ a. square feet	_____ b. square feet	_____ c. square feet	_____ d. square feet
	_____ e. c/y dredged	_____ f. c/y dredged		
7. <input checked="" type="checkbox"/> Bordering Land Subject to Flooding	1435 a. square feet	1435 b. square feet	0 c. square feet	0 d. square feet
Cubic Feet Flood Storage	_____ e. cubic feet	_____ f. cubic feet	_____ g. cubic feet	_____ h. cubic feet
8. <input type="checkbox"/> Isolated Land Subject to Flooding	_____ a. square feet	_____ b. square feet		
Cubic Feet Flood Storage	_____ c. cubic feet	_____ d. cubic feet	_____ e. cubic feet	_____ f. cubic feet
9. <input checked="" type="checkbox"/> Riverfront Area	Taunton River _____ a. square feet	Coastal _____ b. total sq. feet		
Sq ft within 100 ft	_____ c. square feet	_____ d. square feet	_____ e. square feet	_____ f. square feet
Sq ft between 100-200 ft	_____ g. square feet	_____ h. square feet	_____ i. square feet	_____ j. square feet

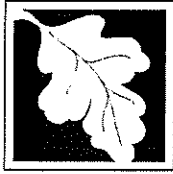

**Massachusetts Department of Environmental Protection**  
**Bureau of Resource Protection - Wetlands**  
**WPA Form 5 – Order of Conditions**  
 Massachusetts Wetlands Protection Act M.G.L. c. 131, §40

Provided by MassDEP:  
 SE73-2881  
 MassDEP File #

eDEP Transaction #  
 Taunton  
 City/Town

**B. Findings (cont.)**

**Coastal Resource Area Impacts: Check all that apply below. (For Approvals Only)**

	Proposed Alteration	Permitted Alteration	Proposed Replacement	Permitted Replacement
10. <input type="checkbox"/> Designated Port Areas	Indicate size under Land Under the Ocean, below			
11. <input type="checkbox"/> Land Under the Ocean	_____	_____		
	a. square feet	b. square feet		
	_____	_____		
	c. c/y dredged	d. c/y dredged		
12. <input type="checkbox"/> Barrier Beaches	Indicate size under Coastal Beaches and/or Coastal Dunes below			
13. <input type="checkbox"/> Coastal Beaches	_____	_____	_____ cu yd	_____ cu yd
	a. square feet	b. square feet	c. nourishment	d. nourishment
14. <input type="checkbox"/> Coastal Dunes	_____	_____	_____ cu yd	_____ cu yd
	a. square feet	b. square feet	c. nourishment	d. nourishment
15. <input type="checkbox"/> Coastal Banks	_____	_____		
	a. linear feet	b. linear feet		
16. <input type="checkbox"/> Rocky Intertidal Shores	_____	_____		
	a. square feet	b. square feet		
17. <input type="checkbox"/> Salt Marshes	_____	_____	_____	_____
	a. square feet	b. square feet	c. square feet	d. square feet
18. <input type="checkbox"/> Land Under Salt Ponds	_____	_____		
	a. square feet	b. square feet		
	_____	_____		
	c. c/y dredged	d. c/y dredged		
19. <input type="checkbox"/> Land Containing Shellfish	_____	_____	_____	_____
	a. square feet	b. square feet	c. square feet	d. square feet
20. <input type="checkbox"/> Fish Runs	Indicate size under Coastal Banks, Inland Bank, Land Under the Ocean, and/or inland Land Under Waterbodies and Waterways, above			
	_____	_____		
	a. c/y dredged	b. c/y dredged		
21. <input type="checkbox"/> Land Subject to Coastal Storm Flowage	_____	_____		
	a. square feet	b. square feet		
22. <input type="checkbox"/> Riverfront Area	_____	_____		
	a. total sq. feet	b. total sq. feet		
Sq ft within 100 ft	_____	_____	_____	_____
	c. square feet	d. square feet	e. square feet	f. square feet
Sq ft between 100-200 ft	_____	_____	_____	_____
	g. square feet	h. square feet	i. square feet	j. square feet



Massachusetts Department of Environmental Protection  
 Bureau of Resource Protection - Wetlands  
**WPA Form 5 – Order of Conditions**  
 Massachusetts Wetlands Protection Act M.G.L. c. 131, §40

Provided by MassDEP:  
 SE73-2881  
 MassDEP File #

eDEP Transaction #  
 Taunton  
 City/Town

**B. Findings (cont.)**

\* #23. If the project is for the purpose of restoring or enhancing a wetland resource area in addition to the square footage that has been entered in Section B.5.c (BVW) or B.17.c (Salt Marsh) above, please enter the additional amount here.

23.  Restoration/Enhancement \*:  
 a. square feet of BVW \_\_\_\_\_ b. square feet of salt marsh \_\_\_\_\_
24.  Stream Crossing(s):  
 a. number of new stream crossings \_\_\_\_\_ b. number of replacement stream crossings \_\_\_\_\_

**C. General Conditions Under Massachusetts Wetlands Protection Act**

The following conditions are only applicable to Approved projects.

1. Failure to comply with all conditions stated herein, and with all related statutes and other regulatory measures, shall be deemed cause to revoke or modify this Order.
2. The Order does not grant any property rights or any exclusive privileges; it does not authorize any injury to private property or invasion of private rights.
3. This Order does not relieve the permittee or any other person of the necessity of complying with all other applicable federal, state, or local statutes, ordinances, bylaws, or regulations.
4. The work authorized hereunder shall be completed within three years from the date of this Order unless either of the following apply:
  - a. The work is a maintenance dredging project as provided for in the Act; or
  - b. The time for completion has been extended to a specified date more than three years, but less than five years, from the date of issuance. If this Order is intended to be valid for more than three years, the extension date and the special circumstances warranting the extended time period are set forth as a special condition in this Order.
  - c. If the work is for a Test Project, this Order of Conditions shall be valid for no more than one year.
5. This Order may be extended by the issuing authority for one or more periods of up to three years each upon application to the issuing authority at least 30 days prior to the expiration date of the Order. An Order of Conditions for a Test Project may be extended for one additional year only upon written application by the applicant, subject to the provisions of 310 CMR 10.05(11)(f).
6. If this Order constitutes an Amended Order of Conditions, this Amended Order of Conditions does not extend the issuance date of the original Final Order of Conditions and the Order will expire on \_\_\_\_\_ unless extended in writing by the Department.
7. Any fill used in connection with this project shall be clean fill. Any fill shall contain no trash, refuse, rubbish, or debris, including but not limited to lumber, bricks, plaster, wire, lath, paper, cardboard, pipe, tires, ashes, refrigerators, motor vehicles, or parts of any of the foregoing.



Massachusetts Department of Environmental Protection  
Bureau of Resource Protection - Wetlands  
**WPA Form 5 – Order of Conditions**  
Massachusetts Wetlands Protection Act M.G.L. c. 131, §40

Provided by MassDEP:  
SE73-2881  
MassDEP File #

eDEP Transaction #  
Taunton  
City/Town

### C. General Conditions Under Massachusetts Wetlands Protection Act

8. This Order is not final until all administrative appeal periods from this Order have elapsed, or if such an appeal has been taken, until all proceedings before the Department have been completed.
9. No work shall be undertaken until the Order has become final and then has been recorded in the Registry of Deeds or the Land Court for the district in which the land is located, within the chain of title of the affected property. In the case of recorded land, the Final Order shall also be noted in the Registry's Grantor Index under the name of the owner of the land upon which the proposed work is to be done. In the case of the registered land, the Final Order shall also be noted on the Land Court Certificate of Title of the owner of the land upon which the proposed work is done. The recording information shall be submitted to the Conservation Commission on the form at the end of this Order, which form must be stamped by the Registry of Deeds, prior to the commencement of work.
10. A sign shall be displayed at the site not less than two square feet or more than three square feet in size bearing the words,
 

"Massachusetts Department of Environmental Protection" [or, "MassDEP"]  
"File Number            SE73-2881            "
11. Where the Department of Environmental Protection is requested to issue a Superseding Order, the Conservation Commission shall be a party to all agency proceedings and hearings before MassDEP.
12. Upon completion of the work described herein, the applicant shall submit a Request for Certificate of Compliance (WPA Form 8A) to the Conservation Commission.
13. The work shall conform to the plans and special conditions referenced in this order.
14. Any change to the plans identified in Condition #13 above shall require the applicant to inquire of the Conservation Commission in writing whether the change is significant enough to require the filing of a new Notice of Intent.
15. The Agent or members of the Conservation Commission and the Department of Environmental Protection shall have the right to enter and inspect the area subject to this Order at reasonable hours to evaluate compliance with the conditions stated in this Order, and may require the submittal of any data deemed necessary by the Conservation Commission or Department for that evaluation.
16. This Order of Conditions shall apply to any successor in interest or successor in control of the property subject to this Order and to any contractor or other person performing work conditioned by this Order.



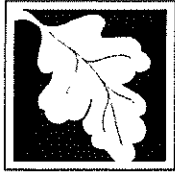

Massachusetts Department of Environmental Protection  
Bureau of Resource Protection - Wetlands

## WPA Form 5 – Order of Conditions

Massachusetts Wetlands Protection Act M.G.L. c. 131, §40

Provided by MassDEP:

SE73-2881

MassDEP File #

eDEP Transaction #

Taunton

City/Town

### C. General Conditions Under Massachusetts Wetlands Protection Act (cont.)

17. Prior to the start of work, and if the project involves work adjacent to a Bordering Vegetated Wetland, the boundary of the wetland in the vicinity of the proposed work area shall be marked by wooden stakes or flagging. Once in place, the wetland boundary markers shall be maintained until a Certificate of Compliance has been issued by the Conservation Commission.
18. All sedimentation barriers shall be maintained in good repair until all disturbed areas have been fully stabilized with vegetation or other means. At no time shall sediments be deposited in a wetland or water body. During construction, the applicant or his/her designee shall inspect the erosion controls on a daily basis and shall remove accumulated sediments as needed. The applicant shall immediately control any erosion problems that occur at the site and shall also immediately notify the Conservation Commission, which reserves the right to require additional erosion and/or damage prevention controls it may deem necessary. Sedimentation barriers shall serve as the limit of work unless another limit of work line has been approved by this Order.
19. The work associated with this Order (the "Project")
- (1)  is subject to the Massachusetts Stormwater Standards
- (2)  is NOT subject to the Massachusetts Stormwater Standards

**If the work is subject to the Stormwater Standards, then the project is subject to the following conditions:**

- a) All work, including site preparation, land disturbance, construction and redevelopment, shall be implemented in accordance with the construction period pollution prevention and erosion and sedimentation control plan and, if applicable, the Stormwater Pollution Prevention Plan required by the National Pollution Discharge Elimination System Construction General Permit as required by Stormwater Condition 8. Construction period erosion, sedimentation and pollution control measures and best management practices (BMPs) shall remain in place until the site is fully stabilized.
- b) No stormwater runoff may be discharged to the post-construction stormwater BMPs unless and until a Registered Professional Engineer provides a Certification that:
- i.* all construction period BMPs have been removed or will be removed by a date certain specified in the Certification. For any construction period BMPs intended to be converted to post construction operation for stormwater attenuation, recharge, and/or treatment, the conversion is allowed by the MassDEP Stormwater Handbook BMP specifications and that the BMP has been properly cleaned or prepared for post construction operation, including removal of all construction period sediment trapped in inlet and outlet control structures;
  - ii.* as-built final construction BMP plans are included, signed and stamped by a Registered Professional Engineer, certifying the site is fully stabilized;
  - iii.* any illicit discharges to the stormwater management system have been removed, as per the requirements of Stormwater Standard 10;

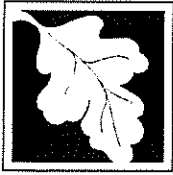

Massachusetts Department of Environmental Protection  
Bureau of Resource Protection - Wetlands  
**WPA Form 5 – Order of Conditions**  
Massachusetts Wetlands Protection Act M.G.L. c. 131, §40

Provided by MassDEP:  
SE73-2881  
MassDEP File #

eDEP Transaction #  
Taunton  
City/Town

**C. General Conditions Under Massachusetts Wetlands Protection Act (cont.)**

- iv.* all post-construction stormwater BMPs are installed in accordance with the plans (including all planting plans) approved by the issuing authority, and have been inspected to ensure that they are not damaged and that they are in proper working condition;
- v.* any vegetation associated with post-construction BMPs is suitably established to withstand erosion.
- c)* The landowner is responsible for BMP maintenance until the issuing authority is notified that another party has legally assumed responsibility for BMP maintenance. Prior to requesting a Certificate of Compliance, or Partial Certificate of Compliance, the responsible party (defined in General Condition 18(e)) shall execute and submit to the issuing authority an Operation and Maintenance Compliance Statement ("O&M Statement") for the Stormwater BMPs identifying the party responsible for implementing the stormwater BMP Operation and Maintenance Plan ("O&M Plan") and certifying the following:
- i.)* the O&M Plan is complete and will be implemented upon receipt of the Certificate of Compliance, and
  - ii.)* the future responsible parties shall be notified in writing of their ongoing legal responsibility to operate and maintain the stormwater management BMPs and implement the Stormwater Pollution Prevention Plan.
- d)* Post-construction pollution prevention and source control shall be implemented in accordance with the long-term pollution prevention plan section of the approved Stormwater Report and, if applicable, the Stormwater Pollution Prevention Plan required by the National Pollution Discharge Elimination System Multi-Sector General Permit.
- e)* Unless and until another party accepts responsibility, the landowner, or owner of any drainage easement, assumes responsibility for maintaining each BMP. To overcome this presumption, the landowner of the property must submit to the issuing authority a legally binding agreement of record, acceptable to the issuing authority, evidencing that another entity has accepted responsibility for maintaining the BMP, and that the proposed responsible party shall be treated as a permittee for purposes of implementing the requirements of Conditions 18(f) through 18(k) with respect to that BMP. Any failure of the proposed responsible party to implement the requirements of Conditions 18(f) through 18(k) with respect to that BMP shall be a violation of the Order of Conditions or Certificate of Compliance. In the case of stormwater BMPs that are serving more than one lot, the legally binding agreement shall also identify the lots that will be serviced by the stormwater BMPs. A plan and easement deed that grants the responsible party access to perform the required operation and maintenance must be submitted along with the legally binding agreement.
- f)* The responsible party shall operate and maintain all stormwater BMPs in accordance with the design plans, the O&M Plan, and the requirements of the Massachusetts Stormwater Handbook.



Massachusetts Department of Environmental Protection  
Bureau of Resource Protection - Wetlands  
**WPA Form 5 – Order of Conditions**  
Massachusetts Wetlands Protection Act M.G.L. c. 131, §40

Provided by MassDEP:  
SE73-2881  
MassDEP File #

eDEP Transaction #  
Taunton  
City/Town

---

**C. General Conditions Under Massachusetts Wetlands Protection Act (cont.)**

- g) The responsible party shall:
1. Maintain an operation and maintenance log for the last three (3) consecutive calendar years of inspections, repairs, maintenance and/or replacement of the stormwater management system or any part thereof, and disposal (for disposal the log shall indicate the type of material and the disposal location);
  2. Make the maintenance log available to MassDEP and the Conservation Commission ("Commission") upon request; and
  3. Allow members and agents of the MassDEP and the Commission to enter and inspect the site to evaluate and ensure that the responsible party is in compliance with the requirements for each BMP established in the O&M Plan approved by the issuing authority.
- h) All sediment or other contaminants removed from stormwater BMPs shall be disposed of in accordance with all applicable federal, state, and local laws and regulations.
- i) Illicit discharges to the stormwater management system as defined in 310 CMR 10.04 are prohibited.
- j) The stormwater management system approved in the Order of Conditions shall not be changed without the prior written approval of the issuing authority.
- k) Areas designated as qualifying pervious areas for the purpose of the Low Impact Site Design Credit (as defined in the MassDEP Stormwater Handbook, Volume 3, Chapter 1, Low Impact Development Site Design Credits) shall not be altered without the prior written approval of the issuing authority.
- l) Access for maintenance, repair, and/or replacement of BMPs shall not be withheld. Any fencing constructed around stormwater BMPs shall include access gates and shall be at least six inches above grade to allow for wildlife passage.

Special Conditions (if you need more space for additional conditions, please attach a text document):

---

20. For Test Projects subject to 310 CMR 10.05(11), the applicant shall also implement the monitoring plan and the restoration plan submitted with the Notice of Intent. If the conservation commission or Department determines that the Test Project threatens the public health, safety or the environment, the applicant shall implement the removal plan submitted with the Notice of Intent or modify the project as directed by the conservation commission or the Department.



Massachusetts Department of Environmental Protection  
 Bureau of Resource Protection - Wetlands  
**WPA Form 5 – Order of Conditions**  
 Massachusetts Wetlands Protection Act M.G.L. c. 131, §40

Provided by MassDEP:  
 SE73-2881  
 MassDEP File #

eDEP Transaction #  
 Taunton  
 City/Town

**D. Findings Under Municipal Wetlands Bylaw or Ordinance**

1. Is a municipal wetlands bylaw or ordinance applicable?  Yes  No
2. The Taunton hereby finds (check one that applies):  
 Conservation Commission
- a.  that the proposed work cannot be conditioned to meet the standards set forth in a municipal ordinance or bylaw, specifically:

1. Municipal Ordinance or Bylaw	2. Citation

Therefore, work on this project may not go forward unless and until a revised Notice of Intent is submitted which provides measures which are adequate to meet these standards, and a final Order of Conditions is issued.

- b.  that the following additional conditions are necessary to comply with a municipal ordinance or bylaw:

1. Municipal Ordinance or Bylaw	Chap.16 Sec. 30-38

3. The Commission orders that all work shall be performed in accordance with the following conditions and with the Notice of Intent referenced above. To the extent that the following conditions modify or differ from the plans, specifications, or other proposals submitted with the Notice of Intent, the conditions shall control.
- The special conditions relating to municipal ordinance or bylaw are as follows (if you need more space for additional conditions, attach a text document):

SEE ATTACHED SPECIAL CONDITIONS



Massachusetts Department of Environmental Protection  
 Bureau of Resource Protection - Wetlands  
**WPA Form 5 – Order of Conditions**  
 Massachusetts Wetlands Protection Act M.G.L. c. 131, §40

Provided by MassDEP:  
SE73-2881  
 MassDEP File #

eDEP Transaction #  
Taunton  
 City/Town

**E. Signatures**

This Order is valid for three years, unless otherwise specified as a special condition pursuant to General Conditions #4, from the date of issuance.

Please indicate the number of members who will sign this form.

This Order must be signed by a majority of the Conservation Commission.

The Order must be mailed by certified mail (return receipt requested) or hand delivered to the applicant. A copy also must be mailed or hand delivered at the same time to the appropriate Department of Environmental Protection Regional Office, if not filing electronically, and the property owner, if different from applicant.

11/18/2020  
 1. Date of Issuance  
7  
 2. Number of Signers

11/16/2020

Signature <u>[Signature]</u>	STEVEN TURNER
Printed Name	
Signature <u>Debra A. Botello</u>	DEBRA BOTELLIO
Printed Name	
Signature <u>John Borden</u>	JOSHUA BORDEN
Printed Name	
Signature <u>Richard Enos</u>	RICHARD ENOS
Printed Name	
Signature <u>Luis m. Freitas</u>	LUIS FREITAS
Printed Name	
Signature <u>Matthew P. Haggerty</u>	MATTHEW HAGGERTY
Printed Name	
Signature <u>[Signature]</u>	JAN REGO
Printed Name	
Signature _____	Printed Name _____

by hand delivery on

by certified mail, return receipt requested, on

Date \_\_\_\_\_

Date 11/18/2020



Massachusetts Department of Environmental Protection  
 Bureau of Resource Protection - Wetlands  
**WPA Form 5 – Order of Conditions**  
 Massachusetts Wetlands Protection Act M.G.L. c. 131, §40

Provided by MassDEP:  
 SE73-2881  
 \_\_\_\_\_  
 MassDEP File #

\_\_\_\_\_ eDEP Transaction #  
 Taunton  
 \_\_\_\_\_  
 City/Town

**F. Appeals**

The applicant, the owner, any person aggrieved by this Order, any owner of land abutting the land subject to this Order, or any ten residents of the city or town in which such land is located, are hereby notified of their right to request the appropriate MassDEP Regional Office to issue a Superseding Order of Conditions. The request must be made by certified mail or hand delivery to the Department, with the appropriate filing fee and a completed Request for Departmental Action Fee Transmittal Form, as provided in 310 CMR 10.03(7) within ten business days from the date of issuance of this Order. A copy of the request shall at the same time be sent by certified mail or hand delivery to the Conservation Commission and to the applicant, if he/she is not the appellant.

Any appellants seeking to appeal the Department’s Superseding Order associated with this appeal will be required to demonstrate prior participation in the review of this project. Previous participation in the permit proceeding means the submission of written information to the Conservation Commission prior to the close of the public hearing, requesting a Superseding Order, or providing written information to the Department prior to issuance of a Superseding Order.

The request shall state clearly and concisely the objections to the Order which is being appealed and how the Order does not contribute to the protection of the interests identified in the Massachusetts Wetlands Protection Act (M.G.L. c. 131, § 40), and is inconsistent with the wetlands regulations (310 CMR 10.00). To the extent that the Order is based on a municipal ordinance or bylaw, and not on the Massachusetts Wetlands Protection Act or regulations, the Department has no appellate jurisdiction.



Massachusetts Department of Environmental Protection  
 Bureau of Resource Protection - Wetlands  
**WPA Form 5 – Order of Conditions**  
 Massachusetts Wetlands Protection Act M.G.L. c. 131, §40

Provided by MassDEP:  
 SE73-2881  
 MassDEP File #

eDEP Transaction #  
 Taunton  
 City/Town

**G. Recording Information**

Prior to commencement of work, this Order of Conditions must be recorded in the Registry of Deeds or the Land Court for the district in which the land is located, within the chain of title of the affected property. In the case of recorded land, the Final Order shall also be noted in the Registry's Grantor Index under the name of the owner of the land subject to the Order. In the case of registered land, this Order shall also be noted on the Land Court Certificate of Title of the owner of the land subject to the Order of Conditions. The recording information on this page shall be submitted to the Conservation Commission listed below.

Taunton  
 Conservation Commission

Detach on dotted line, have stamped by the Registry of Deeds and submit to the Conservation Commission.

To:

Taunton  
 Conservation Commission

Please be advised that the Order of Conditions for the Project at:

825 W. Water Street (105-159)  
 Project Location

SE73-2881  
 MassDEP File Number

Has been recorded at the Registry of Deeds of:

Bristol  
 County

Book

Page

for: Property Owner

and has been noted in the chain of title of the affected property in:

Book

Page

In accordance with the Order of Conditions issued on:

Date

If recorded land, the instrument number identifying this transaction is:

Instrument Number

If registered land, the document number identifying this transaction is:

Document Number

Signature of Applicant

## SPECIAL CONDITIONS FOR ORDERS OF CONDITIONS

- ✓  SC1 – Any change in the plans or any change in construction from the proposed plans shall require the Applicant to file a notice of project change with this Commission via a written inquiry as to whether the change is significant enough to require filing an amendment or a new Notice of Intent. If a minor/insignificant revision, no meeting will be required. Should the house footprint be changed without permission, or found by TCC to be changed in any way from the approved plan, all work shall immediately cease until approved by the TCC. Noncompliance with this condition shall automatically stop any permit process by this office for this Applicant.
- ✓  SC2 – A copy of this Order of Conditions and the Plans of Record shall be available on site at all times until the project is completed.
- ✓  SC3 – Best management practices as referenced by the Commission and the City Engineer shall be used to prevent any form of flooding to adjacent properties, wetlands, or watersheds as a result of this project's work. The Applicant shall be fully responsible for any damage due to improper construction or poor engineering on the site, and shall take immediate steps to correct any flooding problems resulting from work on this project. Corrective measures shall be approved by this Commission on an emergency basis if needed.
- ✓  SC4 – Any debris, fill, or excavated material shall be stockpiled on the upland side of the siltation barriers and at a location which prevents sediment from entering the wetlands.
- ✓  SC5 – All disturbed areas on this site shall be permanently stabilized either by sodding, loaming and seeding, loaming and hydro-seeding, mulching and planting, or by stone placement or other method approved by the Commission. Vegetative or other site stabilization must be uniform and complete before a final Certificate of Compliance is issued.
- ✓  SC6 - All road construction should be timed so that the binder coat can be in place prior to the closing of the asphalt plants of the winter.
- ✓  SC7 - Storm drains and catch basins must be protected from silt during the construction phase of the project.
- ✓  SC8 - An acceptable dewatering plan must be submitted and approved by the Director of Conservation Services prior to the beginning of work.
- ✓  SC9 - No water resulting from dewatering may be discharged into the Resource Area.
- SC10 - All hazardous materials on site must be disposed of properly and evidence of such disposal presented for the COC.
- SC11 - No water may be discharged into the detention structures until those structures have been fully stabilized (Growth has been established)
- SC12 - A fence must be installed between the limit of work and Resource Area.
- SC13 - Any pre-existing violations must be repaired.



- SC14 –The following replication area conditions shall apply:
  - a) Replication areas must be completed first in sequence prior to construction.
  - b) Replication areas should be in place and functional for two growing seasons prior to the issuance of a Certificate of Compliance.
  - c) Replication area must be at least twice as large as the disturbed wetlands they are intended to replace (2:1 replication).
  - d) Replication area must reflect the characteristics of the displaced wetland area.
  - e) An acceptable Replication Plan must be on file with the Taunton Conservation Commission Office.
  - f) Wetlands replication area must be located in the same Bordering Vegetated Wetlands system as the altered wetlands.
  - g) Wetlands replication area must be on the property owned by the applicant.
  - h) Replication construction must be supervised by a certified wetland biologist/specialist.
- SC15 - TCC to inspect proposed washout area.
- SC16 - TCC to be notified when ownership of the property changes.
- SC17 - New owners to made aware of the Order of Conditions.
- SC18 - Deed Restrictions.
- ✓ □ SC19 – Siltation barrier to be installed and inspected prior to construction.
- SC20 - Ongoing maintenance for all conservation structures.
- ✓ □ SC21 - Evidence of recording within 40 days of issuance.
- SC22- 6” of topsoil required around conservation structures.
- SC23 - Roof drains into dry wells.
- SC24 - Keep washout area outside of buffer zone.
- ✓ □ SC25 – The Applicant shall notify this Commission in writing of the name, address, business and home telephone numbers of the Project Supervisor and/or Contractor who shall be responsible for ensuring compliance with this Order, and who shall notify this Commission in writing at least three (3) days before any activity commences on the project site.
- ✓ □ SC26 – A CD with a PDF file of the plans should be submitted prior to the release of the Order of Conditions.
- ✓ □ SC27 – A CD with a PDF file of the AS-Built plan should be submitted when submitting a Request for Certificate of Compliance.

SECTION 01067

COMMONWEALTH OF MASSACHUSETTS AND FEDERAL REQUIREMENTS

PART 1 - GENERAL

TABLE OF CONTENTS

- 1.01 American Iron and Steel
- 1.02 Suspension and Debarment
- 1.03 Excerpts From Massachusetts Statutes
- 1.04 Minimum Wage Rates
- 1.05 Safety and Health
- 1.06 Modified Supplemental Equal Employment Opportunity Anti-Discrimination and Affirmative Action Program
- 1.07 Supplemental Equal Employment Opportunity Anti-Discrimination and Affirmative Action Program – Contract Compliance Procedure
- 1.08 Special Provisions for Minority/Women Business Enterprises Statutes Regulating Construction Contracts for Public Buildings and Public Works Projects

LIST OF ATTACHMENTS

- A - Excerpts from Massachusetts General Laws
- B - Massachusetts Prevailing Wage Rates & Federal Davis-Bacon Wage Rates
- C - Massachusetts Equal Employment Opportunity Package
- D - Massachusetts Diesel Retrofit Forms
- E - American Iron and Steel Requirements
- F - DMS Policies
- G - Davis Bacon Requirements

1.01 AMERICAN IRON AND STEEL

A. The Contractor acknowledges to and for the benefit of the City of Taunton (“Owner”) and the Commonwealth of Massachusetts (the “State”) that it understands the goods and services under this Agreement are being funded with monies made available by the Clean Water State Revolving Fund that have statutory requirements commonly known as “American Iron and Steel;” that requires all of the iron and steel products used in the project to be produced in the United States (“American Iron and Steel Requirement”) including iron and steel products provided by the Contractor pursuant to this Agreement. The Contractor hereby represents and warrants to and for the benefit of the Owner and the State that (a) the Contractor has reviewed and understands the American Iron and Steel Requirement, (b) all of the iron and steel products used in the project will be and/or have been produced in the United States in a manner that complies with the American Iron and Steel Requirement, unless a waiver of the requirement is approved, and (c) the Contractor will provide any further verified information, certification or assurance of compliance with this paragraph, or information necessary to support a waiver of the American Iron and Steel Requirement, as may be requested by the Owner or the State. Notwithstanding any other provision of this Agreement, any failure to comply with this paragraph by the Contractor

shall permit the Owner or State to recover as damages against the Contractor any loss, expense, or cost (including without limitation attorney's fees) incurred by the Owner or State resulting from any such failure (including without limitation any impairment or loss of funding, whether in whole or in part, from the State or any damages owed to the State by the Owner). While the Contractor has no direct contractual privity with the State, as a lender to the Owner for the funding of its project, the Owner and the Contractor agree that the State is a third-party beneficiary and neither this paragraph (nor any other provision of this Agreement necessary to give this paragraph force or effect) shall be amended or waived without the prior written consent of the State.

#### 1.02 SUSPENSION AND DEBARMENT

The Contractor agrees that it will fully comply with Subpart C of 2 CFR Part 180 and 2 CFR Part 1532, entitled "Responsibilities of Participants Regarding Transactions (Doing Business with Other Persons)". The Contractor shall not award any subcontracts or purchase any materials from suppliers that appear on the Excluded Parties List System. The Contractor shall include this requirement in each subcontract and require it to be included in all subcontracts regardless of tier. The Contractor shall maintain reasonable records to demonstrate compliance with these requirements.

#### 1.03 EXCERPTS FROM MASSACHUSETTS STATUTES

A. In addition to the requirements as set forth under "Compliance with Laws" in the AGREEMENT, particular attention is directed to certain stipulations of Chapter 149 of the General Laws of Massachusetts, as amended to date as follows:

Section 25. "Every employee in public work shall lodge, board, and trade where and with whom he elects; and no person or his agents or employees under contract with the commonwealth, a county, city or town, or with a department, board, commission or officer acting therefore, for the doing of public work shall directly or indirectly require, as a condition of employment therein, that the employee shall lodge, board or trade at a particular place or with a particular person. This section shall be made a part of the contract for such employment."

Section 26. "In the employment of mechanics and apprentices, teamsters, chauffeurs and laborers in the construction of public works by the commonwealth, or by a county, town, authority or district, or by persons contracting or subcontracting for such works, preference shall first be given to citizens of the commonwealth who have been residents of the commonwealth for at least six months at the commencement of their employment who are male veterans as defined in clause Forty-third of section seven of chapter four, and who are qualified to perform the work to which the employment relates; and secondly, to citizens of the commonwealth generally who have been residents of the commonwealth for at least six months at the commencement of their employment, and if they cannot be obtained in sufficient numbers, then to citizens of the United States, and every contract for such work shall contain a provision to this effect.

Section 34. "Every contract, except for the purchase of, material or supplies, involving the employment of laborers, workmen, mechanics, foremen, or inspectors, to which the commonwealth or any county or any town, subject to section thirty, is a party, shall contain a stipulation that no laborer, workman, mechanic, foreman or inspector working within the commonwealth, in the employ of the contractor, subcontractor or other person doing or contracting to do the whole or a part of the work contemplated by the contract, shall be required or permitted to work more than eight hours in any one day or more than 48 hours in any one week, or more than six days in any one week, except in cases of emergency, or in case any town subject to section thirty-one is a party to such a contract, more than eight hours in any one day, except as aforesaid..."

Section 34A. "Every contract for the construction, alteration, maintenance, repair or demolition of or addition to, any public building or other public works for the commonwealth or any political subdivision thereof shall contain stipulations requiring that the contractor shall, before commencing performance of such contract, provide by insurance for the payment of compensation and the furnishing of other benefits under chapter one hundred and fifty-two to all persons to be employed under the contract, and that the contractor shall continue such insurance in full force and effect during the term of the contract. No officer or agent contracting in behalf of the commonwealth or any political subdivision thereof shall award such a contract until he has been furnished with sufficient proof of compliance with the aforesaid stipulations. Failure to provide and continue in force such insurance as aforesaid shall be deemed a material breach of contract and shall operate as an immediate termination thereof. No cancellation of such insurance, whether by the insurer or by the insured, shall be valid unless written notice thereof is given by the party proposing cancellation to the other party and to the officer or agent who awarded the contract at least fifteen days prior to the intended effective date thereof, which date shall be expressed in said notice. Notice of cancellation sent by the party proposing receipt of the addressee requested, shall be a sufficient notice..."

Section 34B. "Every contract for the construction, alteration, maintenance, repair or demolition of, or addition to, any public works for the commonwealth or any political subdivision thereof shall contain stipulations requiring that the contractor shall pay to any reserve police officer employed by him in any city or town the prevailing rate of wage paid to regular police officers employed by him in such city or town."

Attention is directed to Chapter 774 of the Acts of 1972 amending Section 39F of Chapter 30 to read as follows:

Section 39F. "(1) Every contract awarded shall contain the following subparagraphs and in each case those subparagraphs shall be binding between the general contractor and each subcontractor.

(a) Forthwith after the general contractor receives payment on account of a periodic estimate, the general contractor shall pay to each subcontractor the amount paid for the labor performed and the materials furnished by that subcontractor, less any amount specified in any court proceedings barring such payment and also less any amount claimed due from the subcontractor by the general contractor.

(b) Not later than the sixty-fifth day after each subcontractor substantially completes his work in accordance with the plans and specifications, the entire balance due under the subcontract less amounts retained by the awarding authority as the estimated cost of completing the incomplete and unsatisfactory items of work, shall be due the subcontractor; and the awarding authority shall pay that amount to the general contractor. The general contractor shall forthwith pay to the subcontractor the full amount received from the awarding authority less any amount specified in any court proceedings barring such payment and also less any amount claimed due from the subcontractor by the general contractor.

(c) Each payment made by the awarding authority to the general contractor pursuant to sub-paragraphs (a) and (b) of this paragraph for the labor performed and the materials furnished by a subcontractor shall be made to the general contractor for the account of that subcontractor; and the awarding authority shall take reasonable steps to compel the general contractor to make each such payment to each such subcontractor. If the awarding authority has received a demand for direct payment from a subcontractor for any amount which has already been included in a payment to the general contractor for payment to the subcontractor as provided in subparagraphs (a) and (b), the awarding authority shall act upon the demand as provided in this section.

(d) If, within seventy days after the subcontractor has substantially completed the subcontractor work, the subcontractor has not received from the general contractor the balance due under the subcontract including any amount due for extra labor and materials furnished to the general contractor, less any amount retained by the awarding authority as the estimated cost of completing the incomplete and unsatisfactory items of work, the subcontractor may demand direct payment of that balance from the awarding authority. The demand shall be by a sworn statement delivered to or sent by certified mail to the awarding authority, and a copy shall be delivered to or sent by certified mail to the general contractor at the same time. The demand shall contain a detailed breakdown of the balance due under the subcontract and also a statement of the status of completion of the subcontract work. Any demand made after substantial completion of the subcontract work shall be valid even if delivered or mailed prior to the seventieth day after the subcontract work. Within ten days after the subcontractor has delivered or so mailed the demand to the awarding authority and delivered or so mailed a copy to the general contractor, the general contractor may reply to the demand. The reply shall be by a sworn statement delivered to or sent by certified mail to the awarding authority and a copy shall be delivered to or sent by certified mail to the subcontractor at the same time. The reply shall contain a detailed breakdown of the balance due under the subcontract including any amount due for extra labor and materials furnished to the general contractor and of the amount due for each claim made by the general contractor against the subcontractor.

(e) Within fifteen days after receipt of the demand by the awarding authority, but in no event prior to the seventieth day after substantial completion of the subcontract work, the awarding authority shall make direct payment to the subcontractor of the balance due under the subcontract including any amount due for extra and materials furnished to the general

contractor, less any amount (i) retained by the awarding authority as the estimated cost of completing the incomplete or unsatisfactory items of work, (ii) specified in any court proceedings barring such payment, or (iii) disputed by the general contractor in the sworn reply; provided, that the awarding authority shall not deduct from a direct payment any amount as provided in part (iii) if the reply is not sworn to, or for which the sworn reply does not contain the detailed breakdown required by subparagraph (d). The awarding authority shall make further direct payments to the Subcontractor forthwith after the removal of the basis for deductions from direct payments made as provided in parts (i) and (ii) of this subparagraph.

(f) The awarding authority shall forthwith deposit the amount deducted from a direct payment as provided in part (iii) of subparagraph (e) in an interest-bearing joint account in the names of the general contractor and the subcontractor in a bank in Massachusetts selected by the awarding authority or agreed upon by the general contractor and the subcontractor and shall notify the general contractor and the subcontractor of the date of the deposit and the bank receiving the deposit. The bank shall pay the amount in the account, including accrued interest, as provided in an agreement between the general contractor and the subcontractor or as determined by decree of a court of competent jurisdiction.

(g) All direct payments and all deductions from demands for direct payments deposited in an interest-bearing account or accounts in a bank pursuant to subparagraph (f) shall be made out of amounts payable to the general contractor at the time of receipt of a demand for direct payment for a subcontractor and out of amounts which later become payable to the general contractor and in the order of receipt of such demands from subcontractors. All direct payments shall discharge the obligation of the awarding authority to the general contractor to the extent of such payment.

(h) The awarding authority shall deduct from payments to a general contractor amounts which, together with the deposits in interest-bearing accounts pursuant to subparagraph (f), are sufficient to satisfy all unpaid balances of demands for direct payment received from subcontractors. All such amounts shall be earmarked for such direct payments, and the subcontractors shall have a right in such deductions prior to any claims against such amounts by creditors of the general contractor."

Attention is also directed to Chapter 774 of the Acts of 1972 further amending Chapter 30 by adding after Section 39M the following section:

Section 39M. (b) Specifications for such contracts, and specification for contracts awarded pursuant to the provisions of said sections forty-four A to forty-four L of said chapter one hundred and forty-nine, shall be written to provide for full competition for each item of material to be furnished under the contract; except, however, that said specifications may be otherwise written for sound reasons in the public interest stated in writing in the public records of the awarding authority or promptly given in writing by the awarding authority to anyone making a written request therefore, in either instance such writing to be prepared after reasonable investigation. Every such contract shall provide that an item equal to that

named or described in the said specifications may be furnished; and an item shall be considered equal to the item so named or described if (1) it is at least equal in quality, durability, appearance, strength and design, (2) it will perform at least equally the function imposed by the general design for the public work being contracted for or the material being purchased, and (3) it conforms substantially, even with deviations, to the detailed requirements for the item in the said specifications. For each item of material the specifications shall provide for either a minimum of three named brands of material or a description of material which can be met by a minimum of three manufacturers or producers, and for the equal of any one of said named or described materials.

Section 39N. "Every contract subject to section forty-four A of chapter one hundred forty-nine or subject to section thirty-nine M of chapter thirty shall contain the following paragraph in its entirety and an awarding authority may adopt reasonable rules or regulations in conformity with that paragraph concerning the filing, investigation and settlement of such claims:

If, during the progress of the work, the contractor or the awarding authority discovers that the actual subsurface or latent physical conditions encountered at the site differ substantially or materially from those shown on the plans or indicated in the contract documents either the contractor or the contracting authority may request an equitable adjustment in the contract price of the contract applying to work affected by the differing site conditions. A request for such an adjustment shall be in writing and shall be delivered by the party making such claim to the other party as soon as possible after such conditions are discovered. Upon receipt of such a claim from a contractor, or upon its own initiative, the contracting authority shall make an investigation of such physical conditions, and, if they differ substantially or materially from those shown on the plans or indicated in the contract documents or from those ordinarily encountered and generally recognized as inherent in work of the character provided for in the plans and contract documents are of such a nature as to cause an increase or decrease in the cost of performance of the work or a change in the construction methods required for the performance of the work which results in an increase or decrease in the cost of the work, the contracting authority shall make an equitable adjustment in the contract price and the contract shall be modified in writing accordingly."

Attention is also directed to Chapter 1164 of the Acts of 1973 further amending Chapter 30 by adding after Section 39N the following two sections:

Section 39O. "Every contract subject to the provisions of section thirty-nine M of this chapter or subject to section forty-four A of chapter one hundred forty-nine shall contain the following provisions (a) and (b) in their entirety...

(a) The awarding authority may order the general contractor in writing to suspend, delay, or interrupt all or any part of the work for such period of time as it may determine to be appropriate for the convenience of the awarding authority; provided however, that if there is a suspension, delay or interruption for fifteen days or more due to a failure of the awarding authority shall make an adjustment in the contract but shall not include any profit

to the general contractor on such increase; and provide further, that the awarding authority shall not make any adjustment in the contract price under this provision for any suspension, delay, interruption or failure to act to the extent that such is due to any cause for which this contract provides for an equitable adjustment of the contract price under any other contract provisions.

(b) The general contractor must submit the amount of a claim under provision (a) to the awarding authority in writing as soon as practicable after the end of the suspension, delay, interruption or failure to act and, in any event, not later than the date of final payment under this contract and, except for costs due to a suspension order, the awarding authority shall not approve any costs in the claim incurred more than 20 days before the general contractor notified the awarding authority of the act or failure to act involved in the claim."

Section 39P. "Every contract subject to section thirty-nine M of this chapter or section forty-four A of chapter one hundred forty-nine which requires the awarding authority, any official, its architect or engineer to make a decision on interpretation of the specifications, approval of equipment, material or any other approval, or progress of the work, shall require that the decision be made promptly and, in any event no later than thirty days after the written submission for decision; but if such decision required extended investigation and study, the awarding authority, the official, architect or engineer shall, within thirty days after the receipt of the submission, give the party making the submission written notice of the reasons why the decision cannot be made within the thirty day period and the date by which the decision will be made."

Attention is also directed to Chapter 30, Section 39R of the General Laws of Massachusetts as amended to date as follows:

Section 39R. (a) The words defined herein shall have the meaning stated below whenever they appear in this section:

(1) "Contractor" means any person, corporation, partnership, joint venture, sole proprietorship, or other entity awarded a contract pursuant to section thirty-nine M of chapter thirty, sections forty-four A through forty-four H, inclusive, of chapter one hundred forty-nine and sections thirty B through thirty P, inclusive, of chapter seven.

(2) "Contract" means any contract awarded or executed pursuant to sections thirty B through thirty P, inclusive, of chapter seven and any contract awarded or executed pursuant to section thirty-nine M of chapter thirty, or sections forty-four A through forty-four H, inclusive, of chapter one hundred forty-nine, which is for an amount or estimated amount greater than one hundred thousand dollars.

(3) "Records" means books of original entry, accounts, checks, bank statements and all other banking documents, correspondence, memorandum invoices, computer printouts, tapes, discs, papers and other documents transcribed information of any type, whether expressed in ordinary or machine language.



(4) "Independent Certified Public Accountant" means a person duly registered in good standing and entitled to practice as a certified public accountant under the laws of the place of his/her residence or principal office and who is in fact independent. In determining whether an accountant is independent with respect to a particular person, appropriate consideration should be given to all relationships between the accountant and that person or any affiliate thereof. Determination of an accountant's independence shall not be confined to the relationships existing in connection with the filing of reports with the awarding authority.

(5) "Audit", when used in regard to financial statements, means an examination of records by an independent certified public accountant in accordance with generally accepted accounting principles and auditing standards for the purpose of expressing a certified opinion thereon, or, in the alternative, a qualified opinion or a delineation to express an opinion for stated reasons.

(6) "Accountant's Report", when used in regard to financial statements, means a document in which an independent certified public accountant indicates the scope of the audit which she/he has made and sets forth his/her opinion regarding the financial statements taken as a whole with a listing of noted exceptions and qualifications, or an assertion to the effect that an overall opinion cannot be expressed. When an overall opinion cannot be expressed the reason therefor shall be stated. An accountant's report shall include as a part thereof a signed statement by the responsible corporate officer attesting that management has fully disclosed all material facts to the independent certified public accountant, and that the audited financial statement is a true and complete statement of a financial condition of the contractor.

(7) "Management", when used herein, means the chief executive officers, partners, principals or other person or persons primarily responsible for the financial and operational policies and practices of the contractor.

(8) Accounting terms, unless otherwise defined herein, shall have a meaning in accordance with generally accepted accounting principals and auditing standards.

(b) Subsection (a) (2) hereof notwithstanding, every agreement or contract awarded or executed pursuant to sections 30B through 30P, inclusive, of chapter seven, and pursuant to section 39M of chapter 30 or to section 44A through 44H, inclusive, of chapter 149, shall provide that:

(1) The contractor shall make, and keep for at least six years after final payment, books, records, and accounts which in reasonable detail accurately and fairly reflect the transactions and dispositions of the contractor, and

(2) until the expiration of six years after final payment, the awarding authority, office of inspector general, and the deputy commissioner of capital planning and operations shall have the right to examine any books, documents, papers or records of the contractor or of

his/her subcontractors that directly pertain to, and involve transactions relating to, the contractor or his/her subcontractors, and

(3) if the agreement is a contract as defined herein, the contractor shall describe any change in the method of maintaining records or recording transactions which materially affect any statements filed with the awarding authority, including in his/her description the date of the change and reasons therefore, and shall accompany said description with a letter from the contractor's independent certified public accountant approving or otherwise commenting on the changes, and

(4) if the agreement is a contract as defined herein, the contractor has filed a statement of management on internal accounting controls as set forth in paragraph (c) below prior to the execution of the contract, and

(5) if the agreement is a contract as defined herein, the contractor has filed prior to the execution of the contracts and will continue to file annually, an audited financial statement for the most recent completed fiscal year as set forth in paragraph (d) below.

(c) Every contractor awarded a contract shall file with the awarding authority a statement of management as to whether the system of internal accounting controls of the contractor and its subsidiaries reasonably assures that:

(1) transactions are executed in accordance with management's general and specific authorization;

(2) transactions are recorded as necessary:

i. to permit preparation of financial statements in conformity with generally accepted accounting principles, and

ii. To maintain accountability for assets;

(3) access to assets is permitted only in accordance with management's general or specific authorization; and

(4) the recorded accountability for assets is compared with the existing assets at reasonable intervals and appropriate action was taken with respect to any difference.

Every contractor awarded a contract shall also file with the awarding authority a statement prepared and signed by an independent certified public accountant, stating that she/he has examined the statement of management on internal accounting controls, and expressing an opinion as to

(1) whether the representations of management in response to this paragraph and paragraph (b) above are consistent with the result of management's evaluation of the system of internal accounting controls; and

(2) whether such representations of management are, in addition, reasonable with respect to transactions and assets in amounts which would be material when measured in relation to the applicant's financial statements.

(d) Every contractor awarded a contract by the commonwealth or by any political subdivision thereof shall annually file with the awarding authority during the term of the contract a financial statement prepared by an independent certified public accountant on

the basis of an audit by sub accountant. The final statement filed shall include the date of final payment. All statements shall be accompanied by an accountant's report.

(e) The office of inspector general, the deputy commissioner for capital planning and operations and any other awarding authority shall enforce the provisions of this section. The deputy commissioner of capital planning and operations may after providing an opportunity for the inspector general and other interested parties to comment, promulgate pursuant to the provisions of chapter thirty A such rules, regulations and guidelines as are necessary to effectuate the purposes of this section. Such rules, regulations and guidelines may be applicable to all awarding authorities. A contractor's failure to satisfy any of the requirements of this section may be grounds for disqualification pursuant to section forty-four C of Chapter one hundred forty-nine.

#### 1.04 MINIMUM WAGE RATES

- A. Minimum Wage Rates as determined by the Commissioner of Department of Labor and Industries under the provision of the Massachusetts General Laws, Chapter 149, Sections 26 to 27D, as amended, apply to this project. It is the responsibility of the contractor, before bid opening, to request if necessary, any additional information of Minimum Wage Rates for those trades-people who may be employed for the proposed work under this contract. Minimum wage rates are included at the end of this section.
- B. Minimum Wage Rates as determined by the United States Department of Labor under the Davis-Bacon Act also apply to this project.

#### 1.05 SAFETY AND HEALTH

- A. This project is subject to the Safety and Health regulation of the U.S. Department of Labor set forth in 29 CFR Part 1926, Commonwealth of Massachusetts Regulations CMR 454, and to the Massachusetts Department of Labor and Industries, Division of Industrial Safety "Rules and Regulations for the Prevention of Accidents in Construction operations (Chapter 454 CMR 10.00 et. seq.)". Contractors shall be familiar with the requirements of these regulations.

#### 1.06 MODIFIED SUPPLEMENTAL EQUAL EMPLOYMENT OPPORTUNITY NON-DISCRIMINATION AND AFFIRMATIVE ACTION PROGRAM

- A. See Attached pages EEO-AAO-MS Page 1 through EEO-AAO-MS Page 7.

#### 1.07 SPECIAL PROVISIONS FOR DISADVANTAGED BUSINESS ENTERPRISES

- A. See Attached pages EEO-DEP-SP Page 1 through EEO-DEP-SP Page 9 AND EEO-DEP Forms.

1.08 STATUTES REGULATING CONSTRUCTION CONTRACTS FOR PUBLIC BUILDINGS AND PUBLIC WORKS PROJECTS

- A. The following statutes regulating construction contracts for public buildings and public works projects are incorporated into the specifications. Where indicated, statutory references are included as attachments.

1. M.G.L c.30 s 39F Payment to Subcontractor (attached)
2. M.G.L c.30 s 39I Deviation from Plans and Specifications
3. M.G.L c.30 s 39J No Arbitrary Decisions are Final
4. M.G.L c.30 s 39L Construction Work by Foreign Corporations
5. M.G.L c.30 s 39M(b) Substitution of Equal Products
6. M.G.L c.30 s 39N Differing Site Conditions (attached)
7. M.G.L c.30 s 39O Equitable Adjustments for Delays (attached)
8. M.G.L c.30 s 39P Decision on Interpretation of Specifications
9. M.G.L c.30 s 39R Contractor's Records
10. M.G.L c.149 s 34 Limitations on Hours of Work
11. M.G.L c.149 s 44J Advertising Invitations to Bid
12. M.G.L c.82 s 40 Excavations; Notice; Penalties
13. M.G.L c.30 s 39K Prompt Payment
14. M.G.L c.149 ss44F and 44G

END OF SECTION



**ATTACHMENT A**

**Excerpts from the Massachusetts General Laws**



**GENERAL LAWS OF MASSACHUSETTS  
PART I.  
ADMINISTRATION OF THE GOVERNMENT.**

---

**TITLE III.  
LAWS RELATING TO STATE OFFICERS.**

---

**CHAPTER 30. GENERAL PROVISIONS RELATIVE TO STATE DEPARTMENTS, COMMISSIONS, OFFICERS AND EMPLOYEES.**

**Chapter 30: Section 39F. Construction contracts; assignment and subrogation; subcontractor defined; enforcement of claim for direct payment; deposit, reduction of disputed amounts.**

Section 39F. (1) Every contract awarded pursuant to sections forty-four A to L, inclusive, of chapter one hundred and forty-nine shall contain the following subparagraphs (a) through (i) and every contract awarded pursuant to section thirty-nine M of chapter thirty shall contain the following subparagraphs (a) through (h) and in each case those subparagraphs shall be binding between the general contractor and each subcontractor.

(a) Forthwith after the general contractor receives payment on account of a periodic estimate, the general contractor shall pay to each subcontractor the amount paid for the labor performed and the materials furnished by that subcontractor, less any amount specified in any court proceedings barring such payment and also less any amount claimed due from the subcontractor by the general contractor.

(b) Not later than the sixty-fifth day after each subcontractor substantially completes his work in accordance with the plans and specifications, the entire balance due under the subcontract less amounts retained by the awarding authority as the estimated cost of completing the incomplete and unsatisfactory items of work, shall be due the subcontractor; and the awarding authority shall pay that amount to the general contractor. The general contractor shall forthwith pay to the subcontractor the full amount received from the awarding authority less any amount specified in any court proceedings barring such payment and also less any amount claimed due from the subcontractor by the general contractor.

(c) Each payment made by the awarding authority to the general contractor pursuant to subparagraphs (a) and (b) of this paragraph for the labor performed and the materials furnished by a subcontractor shall be made to the general contractor for the account of that subcontractor; and the awarding authority shall take reasonable steps to compel the general contractor to make each such payment to each such subcontractor. If the awarding authority has received a demand for direct payment from a subcontractor for any amount which has already been included in a payment to the general contractor or which is to be included in a payment to the general contractor for payment to the subcontractor as provided in subparagraphs (a) and (b), the awarding authority shall act upon the demand as provided in this section.

(d) If, within seventy days after the subcontractor has substantially completed the subcontract work, the subcontractor has not received from the general contractor the balance due under the subcontract including any amount due for extra labor and materials furnished to the general contractor, less any amount retained by the awarding authority as the estimated cost of completing the incomplete and unsatisfactory items of work, the subcontractor may demand direct payment of that balance from the awarding authority.



The demand shall be by a sworn statement delivered to or sent by certified mail to the awarding authority, and a copy shall be delivered to or sent by certified mail to the general contractor at the same time. The demand shall contain a detailed breakdown of the balance due under the subcontract and also a statement of the status of completion of the subcontract work. Any demand made after substantial completion of the subcontract work shall be valid even if delivered or mailed prior to the seventieth day after the subcontractor has substantially completed the subcontract work. Within ten days after the subcontractor has delivered or so mailed the demand to the awarding authority and delivered or so mailed a copy to the general contractor, the general contractor may reply to the demand. The reply shall be by a sworn statement delivered to or sent by certified mail to the awarding authority and a copy shall be delivered to or sent by certified mail to the subcontractor at the same time. The reply shall contain a detailed breakdown of the balance due under the subcontract including any amount due for extra labor and materials furnished to the general contractor and of the amount due for each claim made by the general contractor against the subcontractor.

(e) Within fifteen days after receipt of the demand by the awarding authority, but in no event prior to the seventieth day after substantial completion of the subcontract work, the awarding authority shall make direct payment to the subcontractor of the balance due under the subcontract including any amount due for extra labor and materials furnished to the general contractor, less any amount (i) retained by the awarding authority as the estimated cost of completing the incomplete or unsatisfactory items of work, (ii) specified in any court proceedings barring such payment, or (iii) disputed by the general contractor in the sworn reply; provided, that the awarding authority shall not deduct from a direct payment any amount as provided in part (iii) if the reply is not sworn to, or for which the sworn reply does not contain the detailed breakdown required by subparagraph (d). The awarding authority shall make further direct payments to the subcontractor forthwith after the removal of the basis for deductions from direct payments made as provided in parts (i) and (ii) of this subparagraph.

(f) The awarding authority shall forthwith deposit the amount deducted from a direct payment as provided in part (iii) of subparagraph (e) in an interest-bearing joint account in the names of the general contractor and the subcontractor in a bank in Massachusetts selected by the awarding authority or agreed upon by the general contractor and the subcontractor and shall notify the general contractor and the subcontractor of the date of the deposit and the bank receiving the deposit. The bank shall pay the amount in the account, including accrued interest, as provided in an agreement between the general contractor and the subcontractor or as determined by decree of a court of competent jurisdiction.

(g) All direct payments and all deductions from demands for direct payments deposited in an interest-bearing account or accounts in a bank pursuant to subparagraph (f) shall be made out of amounts payable to the general contractor at the time of receipt of a demand for direct payment from a subcontractor and out of amounts which later become payable to the general contractor and in the order of receipt of such demands from subcontractors. All direct payments shall discharge the obligation of the awarding authority to the general contractor to the extent of such payment.

(h) The awarding authority shall deduct from payments to a general contractor amounts which, together with the deposits in interest-bearing accounts pursuant to subparagraph (f),

are sufficient to satisfy all unpaid balances of demands for direct payment received from subcontractors. All such amounts shall be earmarked for such direct payments, and the subcontractors shall have a right in such deductions prior to any claims against such amounts by creditors of the general contractor.

(i) If the subcontractor does not receive payment as provided in subparagraph (a) or if the general contractor does not submit a periodic estimate for the value of the labor or materials performed or furnished by the subcontractor and the subcontractor does not receive payment for same when due less the deductions provided for in subparagraph (a), the subcontractor may demand direct payment by following the procedure in subparagraph (d) and the general contractor may file a sworn reply as provided in that same subparagraph. A demand made after the first day of the month following that for which the subcontractor performed or furnished the labor and materials for which the subcontractor seeks payment shall be valid even if delivered or mailed prior to the time payment was due on a periodic estimate from the general contractor. Thereafter the awarding authority shall proceed as provided in subparagraph (e), (f), (g) and (h).

(2) Any assignment by a subcontractor of the rights under this section to a surety company furnishing a bond under the provisions of section twenty-nine of chapter one hundred forty-nine shall be invalid. The assignment and subrogation rights of the surety to amounts included in a demand for direct payment which are in the possession of the awarding authority or which are on deposit pursuant to subparagraph (f) of paragraph (1) shall be subordinate to the rights of all subcontractors who are entitled to be paid under this section and who have not been paid in full.

(3) "Subcontractor" as used in this section (i) for contracts awarded as provided in sections forty-four A to forty-four H, inclusive, of chapter one hundred forty-nine shall mean a person who files a sub-bid and receives a subcontract as a result of that filed sub-bid or who is approved by the awarding authority in writing as a person performing labor or both performing labor and furnishing materials pursuant to a contract with the general contractor, (ii) for contracts awarded as provided in paragraph (a) of section thirty-nine M of chapter thirty shall mean a person approved by the awarding authority in writing as a person performing labor or both performing labor and furnishing materials pursuant to a contract with the general contractor, and (iii) for contracts with the commonwealth not awarded as provided in forty-four A to forty-four H, inclusive, of chapter one hundred forty-nine shall also mean a person contracting with the general contractor to supply materials used or employed in a public works project for a price in excess of five thousand dollars.

(4) A general contractor or a subcontractor shall enforce a claim to any portion of the amount of a demand for direct payment deposited as provided in subparagraph (f) of paragraph 1 by a petition in equity in the superior court against the other and the bank shall not be a necessary party. A subcontractor shall enforce a claim for direct payment or a right to require a deposit as provided in subparagraph (f) of paragraph 1 by a petition in equity in the superior court against the awarding authority and the general contractor shall not be a necessary party. Upon motion of any party the court shall advance for speedy trial any petition filed as provided in this paragraph. Sections fifty-nine and fifty-nine B of chapter two hundred thirty-one shall apply to such petitions. The court shall enter an interlocutory decree upon which execution shall issue for any part of a claim found due pursuant to sections fifty-nine and fifty-nine B and, upon motion of any party, shall advance for speedy

trial the petition to collect the remainder of the claim. Any party aggrieved by such interlocutory decree shall have the right to appeal therefrom as from a final decree. The court shall not consolidate for trial the petition of any subcontractor with the petition of one or more subcontractors or the same general contract unless the court finds that a substantial portion of the evidence of the same events during the course of construction (other than the fact that the claims sought to be consolidated arise under the same general contract) is applicable to the petitions sought to be consolidated and that such consolidation will prevent unnecessary duplication of evidence. A decree in any such proceeding shall not include interest on the disputed amount deposited in excess of the interest earned for the period of any such deposit. No person except a subcontractor filing a demand for direct payment for which no funds due the general contractor are available for direct payment shall have a right to file a petition in court of equity against the awarding authority claiming a demand for direct payment is premature and such subcontractor must file the petition before the awarding authority has made a direct payment to the subcontractor and has made a deposit of the disputed portion as provided in part (iii) of subparagraph (e) and in subparagraph (f) of paragraph (1).

(5) In any petition to collect any claim for which a subcontractor has filed a demand for direct payment the court shall, upon motion of the general contractor, reduce by the amount of any deposit of a disputed amount by the awarding authority as provided in part (iii) of subparagraph (e) and in subparagraph (f) of paragraph (1) any amount held under a trustee writ or pursuant to a restraining order or injunction.

**GENERAL LAWS OF MASSACHUSETTS  
PART I.  
ADMINISTRATION OF THE GOVERNMENT.**

---

**TITLE III.  
LAWS RELATING TO STATE OFFICERS.**

---

**CHAPTER 30.** GENERAL PROVISIONS RELATIVE TO STATE DEPARTMENTS, COMMISSIONS, OFFICERS AND EMPLOYEES.

**Chapter 30: Section 39N. Construction contracts; equitable adjustment in contract price for differing subsurface or latent physical conditions.**

Section 39N. Every contract subject to section forty-four A of chapter one hundred and forty-nine or subject to section thirty-nine M of chapter thirty shall contain the following paragraph in its entirety and an awarding authority may adopt reasonable rules or regulations in conformity with that paragraph concerning the filing, investigation and settlement of such claims:

If, during the progress of the work, the contractor or the awarding authority discovers that the actual subsurface or latent physical conditions encountered at the site differ substantially or materially from those shown on the plans or indicated in the contract documents either the contractor or the contracting authority may request an equitable adjustment in the contract price of the contract applying to work affected by the differing site conditions. A request for such an adjustment shall be in writing and shall be delivered by the party making such claim to the other party as soon as possible after such conditions are discovered. Upon receipt of such a claim from a contractor, or upon its own initiative, the contracting authority shall make an investigation of such physical conditions, and, if they differ substantially or materially from those shown on the plans or indicated in the contract documents or from those ordinarily encountered and generally recognized as inherent in work of the character provided for in the plans and contract documents and are of such a nature as to cause an increase or decrease in the cost of performance of the work or a change in the construction methods required for the performance of the work which results in an increase or decrease in the cost of the work, the contracting authority shall make an equitable adjustment in the contract price and the contract shall be modified in writing accordingly.



**GENERAL LAWS OF MASSACHUSETTS  
PART I.  
ADMINISTRATION OF THE GOVERNMENT.**

---

**TITLE III.  
LAWS RELATING TO STATE OFFICERS.**

---

**CHAPTER 30.** GENERAL PROVISIONS RELATIVE TO STATE DEPARTMENTS, COMMISSIONS, OFFICERS AND EMPLOYEES.

**Chapter 30: Section 39O. Contracts for construction and materials; suspension, delay or interruption due to order of awarding authority; adjustment in contract price; required provisions.**

Section 39O. Every contract subject to the provisions of section thirty-nine M of this chapter or subject to section forty-four A of chapter one hundred forty-nine shall contain the following provisions (a) and (b) in their entirety and, in the event a suspension, delay, interruption or failure to act of the awarding authority increases the cost of performance to any subcontractor, that subcontractor shall have the same rights against the general contractor for payment for an increase in the cost of his performance as provisions (a) and (b) give the general contractor against the awarding authority, but nothing in provisions (a) and (b) shall in any way change, modify or alter any other rights which the general contractor or the subcontractor may have against each other.

(a) The awarding authority may order the general contractor in writing to suspend, delay, or interrupt all or any part of the work for such period of time as it may determine to be appropriate for the convenience of the awarding authority; provided however, that if there is a suspension, delay or interruption for fifteen days or more or due to a failure of the awarding authority to act within the time specified in this contract, the awarding authority shall make an adjustment in the contract price for any increase in the cost of performance of this contract but shall not include any profit to the general contractor on such increase; and provided further, that the awarding authority shall not make any adjustment in the contract price under this provision for any suspension, delay, interruption or failure to act to the extent that such is due to any cause for which this contract provides for an equitable adjustment of the contract price under any other contract provisions.

(b) The general contractor must submit the amount of a claim under provision (a) to the awarding authority in writing as soon as practicable after the end of the suspension, delay, interruption or failure to act and, in any event, not later than the date of final payment under this contract and, except for costs due to a suspension order, the awarding authority shall not approve any costs in the claim incurred more than twenty days before the general contractor notified the awarding authority in writing of the act or failure to act involved in the claim.



**ATTACHMENT B**

**Massachusetts Prevailing Wage Rates**

**And**

**Federal Davis-Bacon Wage Rates**







CHARLES D. BAKER  
Governor

KARYN E. POLITO  
Lt. Governor

THE COMMONWEALTH OF MASSACHUSETTS  
EXECUTIVE OFFICE OF LABOR AND WORKFORCE DEVELOPMENT  
DEPARTMENT OF LABOR STANDARDS

Prevailing Wage Rates

As determined by the Director under the provisions of the  
Massachusetts General Laws, Chapter 149, Sections 26 to 27H

ROSALIN ACOSTA  
Secretary  
MICHAEL FLANAGAN  
Director

**Awarding Authority:** City of Taunton DPW  
**Contract Number:** S-2022-1 **City/Town:** TAUNTON  
**Description of Work:** Improvements to the biological treatment systems of the Taunton Wastewater Treatment Facility  
**Job Location:** 825 West Water St, Taunton, MA

---

Information about Prevailing Wage Schedules for Awarding Authorities and Contractors

- This wage schedule applies only to the specific project referenced at the top of this page and uniquely identified by the “Wage Request Number” on all pages of this schedule.
  - An Awarding Authority must request an updated wage schedule from the Department of Labor Standards (“DLS”) if it has not opened bids or selected a contractor within 90 days of the date of issuance of the wage schedule. For CM AT RISK projects (bid pursuant to G.L. c.149A), the earlier of: (a) the execution date of the GMP Amendment, or (b) the bid for the first construction scope of work must be within 90-days of the wage schedule issuance date.
  - The wage schedule shall be incorporated in any advertisement or call for bids for the project as required by M.G.L. c. 149, § 27. The wage schedule shall be made a part of the contract awarded for the project. The wage schedule must be posted in a conspicuous place at the work site for the life of the project in accordance with M.G.L. c. 149 § 27. The wages listed on the wage schedule must be paid to employees performing construction work on the project whether they are employed by the prime contractor, a filed sub-bidder, or any sub-contractor.
  - All apprentices working on the project are required to be registered with the Massachusetts Department of Labor Standards, Division of Apprentice Standards (DLS/DAS). Apprentice must keep his/her apprentice identification card on his/her person during all work hours on the project. An apprentice registered with DAS may be paid the lower apprentice wage rate at the applicable step as provided on the prevailing wage schedule. **Any apprentice not registered with DLS/DAS regardless of whether or not they are registered with any other federal, state, local, or private agency must be paid the journeyworker's rate for the trade.**
  - The wage rates will remain in effect for the duration of the project, except in the case of multi-year public construction projects. For construction projects lasting longer than one year, awarding authorities must request an updated wage schedule. Awarding authorities are required to request these updates no later than two weeks before the anniversary of the date the contract was executed by the awarding authority and the general contractor. For multi-year CM AT RISK projects, awarding authority must request an annual update no later than two weeks before the anniversary date, determined as the earlier of: (a) the execution date of the GMP Amendment, or (b) the execution date of the first amendment to permit procurement of construction services. Contractors are required to obtain the wage schedules from awarding authorities, and to pay no less than these rates to covered workers. The annual update requirement is not applicable to 27F “rental of equipment” contracts.
  - Every contractor or subcontractor which performs construction work on the project is required to submit weekly payroll reports and a Statement of Compliance directly to the awarding authority by mail or email and keep them on file for three years. Each weekly payroll report must contain: the employee’s name, address, occupational classification, hours worked, and wages paid. Do not submit weekly payroll reports to DLS. A sample of a payroll reporting form may be obtained at <http://www.mass.gov/dols/pw>.
  - Contractors with questions about the wage rates or classifications included on the wage schedule have an affirmative obligation to inquire with DLS at (617) 626-6953.
  - Employees not receiving the prevailing wage rate set forth on the wage schedule may report the violation to the Fair Labor Division of the office of the Attorney General at (617) 727-3465.
  - Failure of a contractor or subcontractor to pay the prevailing wage rates listed on the wage schedule to all employees who perform construction work on the project is a violation of the law and subjects the contractor or subcontractor to civil and criminal penalties.
-

Classification	Effective Date	Base Wage	Health	Pension	Supplemental Unemployment	Total Rate
<b>Construction</b>						
(2 AXLE) DRIVER - EQUIPMENT <i>TEAMSTERS JOINT COUNCIL NO. 10 ZONE B</i>	08/01/2021	\$35.95	\$13.41	\$14.82	\$0.00	\$64.18
	12/01/2021	\$35.95	\$13.41	\$16.01	\$0.00	\$65.37
(3 AXLE) DRIVER - EQUIPMENT <i>TEAMSTERS JOINT COUNCIL NO. 10 ZONE B</i>	08/01/2021	\$36.02	\$13.41	\$14.82	\$0.00	\$64.25
	12/01/2021	\$36.02	\$13.41	\$16.01	\$0.00	\$65.44
(4 & 5 AXLE) DRIVER - EQUIPMENT <i>TEAMSTERS JOINT COUNCIL NO. 10 ZONE B</i>	08/01/2021	\$36.14	\$13.41	\$14.82	\$0.00	\$64.37
	12/01/2021	\$36.14	\$13.41	\$16.01	\$0.00	\$65.56
ADS/SUBMERSIBLE PILOT <i>PILE DRIVER LOCAL 56 (ZONE 1)</i>	08/01/2020	\$103.05	\$9.40	\$23.12	\$0.00	\$135.57
For apprentice rates see "Apprentice- PILE DRIVER"						
AIR TRACK OPERATOR <i>LABORERS - ZONE 2</i>	06/01/2021	\$35.75	\$8.60	\$16.64	\$0.00	\$60.99
	12/01/2021	\$36.66	\$8.60	\$16.64	\$0.00	\$61.90
	06/01/2022	\$37.56	\$8.60	\$16.64	\$0.00	\$62.80
	12/01/2022	\$38.41	\$8.60	\$16.64	\$0.00	\$63.65
	06/01/2023	\$39.31	\$8.60	\$16.64	\$0.00	\$64.55
	12/01/2023	\$40.21	\$8.60	\$16.64	\$0.00	\$65.45
For apprentice rates see "Apprentice- LABORER"						
AIR TRACK OPERATOR (HEAVY & HIGHWAY) <i>LABORERS - ZONE 2 (HEAVY &amp; HIGHWAY)</i>	06/01/2021	\$35.75	\$8.60	\$16.64	\$0.00	\$60.99
	12/01/2021	\$36.66	\$8.60	\$16.64	\$0.00	\$61.90
For apprentice rates see "Apprentice- LABORER (Heavy and Highway)"						
ASBESTOS WORKER (PIPES & TANKS) <i>HEAT &amp; FROST INSULATORS LOCAL 6 (SOUTHERN MASS)</i>	12/01/2020	\$38.10	\$12.80	\$9.45	\$0.00	\$60.35
ASPHALT RAKER <i>LABORERS - ZONE 2</i>	06/01/2021	\$35.25	\$8.60	\$16.64	\$0.00	\$60.49
	12/01/2021	\$36.16	\$8.60	\$16.64	\$0.00	\$61.40
	06/01/2022	\$37.06	\$8.60	\$16.64	\$0.00	\$62.30
	12/01/2022	\$37.91	\$8.60	\$16.64	\$0.00	\$63.15
	06/01/2023	\$38.81	\$8.60	\$16.64	\$0.00	\$64.05
	12/01/2023	\$39.71	\$8.60	\$16.64	\$0.00	\$64.95
For apprentice rates see "Apprentice- LABORER"						
ASPHALT RAKER (HEAVY & HIGHWAY) <i>LABORERS - ZONE 2 (HEAVY &amp; HIGHWAY)</i>	06/01/2021	\$35.25	\$8.60	\$16.64	\$0.00	\$60.49
	12/01/2021	\$36.16	\$8.60	\$16.64	\$0.00	\$61.40
For apprentice rates see "Apprentice- LABORER (Heavy and Highway)"						
ASPHALT/CONCRETE/CRUSHER PLANT-ON SITE <i>OPERATING ENGINEERS LOCAL 4</i>	06/01/2021	\$50.73	\$13.75	\$15.80	\$0.00	\$80.28
	12/01/2021	\$51.88	\$13.75	\$15.80	\$0.00	\$81.43
For apprentice rates see "Apprentice- OPERATING ENGINEERS"						
BACKHOE/FRONT-END LOADER <i>OPERATING ENGINEERS LOCAL 4</i>	06/01/2021	\$50.73	\$13.75	\$15.80	\$0.00	\$80.28
	12/01/2021	\$51.88	\$13.75	\$15.80	\$0.00	\$81.43
For apprentice rates see "Apprentice- OPERATING ENGINEERS"						
BARCO-TYPE JUMPING TAMPER <i>LABORERS - ZONE 2</i>	06/01/2021	\$35.25	\$8.60	\$16.64	\$0.00	\$60.49
	12/01/2021	\$36.16	\$8.60	\$16.64	\$0.00	\$61.40
	06/01/2022	\$37.06	\$8.60	\$16.64	\$0.00	\$62.30
	12/01/2022	\$37.91	\$8.60	\$16.64	\$0.00	\$63.15
	06/01/2023	\$38.81	\$8.60	\$16.64	\$0.00	\$64.05
	12/01/2023	\$39.71	\$8.60	\$16.64	\$0.00	\$64.95
For apprentice rates see "Apprentice- LABORER"						

Classification	Effective Date	Base Wage	Health	Pension	Supplemental Unemployment	Total Rate
BLOCK PAVER, RAMMER / CURB SETTER <i>LABORERS - ZONE 2</i>	06/01/2021	\$35.75	\$8.60	\$16.64	\$0.00	\$60.99
	12/01/2021	\$36.66	\$8.60	\$16.64	\$0.00	\$61.90
	06/01/2022	\$37.56	\$8.60	\$16.64	\$0.00	\$62.80
	12/01/2022	\$38.41	\$8.60	\$16.64	\$0.00	\$63.65
	06/01/2023	\$39.31	\$8.60	\$16.64	\$0.00	\$64.55
	12/01/2023	\$40.21	\$8.60	\$16.64	\$0.00	\$65.45
For apprentice rates see "Apprentice- LABORER"						
BLOCK PAVER, RAMMER / CURB SETTER (HEAVY & HIGHWAY) <i>LABORERS - ZONE 2 (HEAVY &amp; HIGHWAY)</i>	06/01/2021	\$35.75	\$8.60	\$16.64	\$0.00	\$60.99
	12/01/2021	\$36.66	\$8.60	\$16.64	\$0.00	\$61.90
For apprentice rates see "Apprentice- LABORER (Heavy and Highway)"						
BOILER MAKER <i>BOILERMAKERS LOCAL 29</i>	01/01/2020	\$46.10	\$7.07	\$17.98	\$0.00	\$71.15

**Apprentice - BOILERMAKER - Local 29**

**Effective Date - 01/01/2020**

Step	percent	Apprentice Base Wage	Health	Pension	Supplemental Unemployment	Total Rate
1	65	\$29.97	\$7.07	\$11.69	\$0.00	\$48.73
2	65	\$29.97	\$7.07	\$11.69	\$0.00	\$48.73
3	70	\$32.27	\$7.07	\$12.59	\$0.00	\$51.93
4	75	\$34.58	\$7.07	\$13.49	\$0.00	\$55.14
5	80	\$36.88	\$7.07	\$14.38	\$0.00	\$58.33
6	85	\$39.19	\$7.07	\$15.29	\$0.00	\$61.55
7	90	\$41.49	\$7.07	\$16.18	\$0.00	\$64.74
8	95	\$43.80	\$7.07	\$17.09	\$0.00	\$67.96

**Notes:**

**Apprentice to Journeyworker Ratio:1:4**

BRICK/STONE/ARTIFICIAL MASONRY (INCL. MASONRY WATERPROOFING) <i>BRICKLAYERS LOCAL 3 (FOXBORO)</i>	08/01/2021	\$55.01	\$11.39	\$21.57	\$0.00	\$87.97
	02/01/2022	\$55.59	\$11.39	\$21.57	\$0.00	\$88.55

**Classification**

**Effective Date   Base Wage   Health   Pension   Supplemental Unemployment   Total Rate**

**Apprentice - BRICK/PLASTER/CEMENT MASON - Local 3 Foxboro**

**Effective Date - 08/01/2021**

Step	percent	Apprentice Base Wage	Health	Pension	Supplemental Unemployment	Total Rate
1	50	\$27.51	\$11.39	\$21.57	\$0.00	\$60.47
2	60	\$33.01	\$11.39	\$21.57	\$0.00	\$65.97
3	70	\$38.51	\$11.39	\$21.57	\$0.00	\$71.47
4	80	\$44.01	\$11.39	\$21.57	\$0.00	\$76.97
5	90	\$49.51	\$11.39	\$21.57	\$0.00	\$82.47

**Effective Date - 02/01/2022**

Step	percent	Apprentice Base Wage	Health	Pension	Supplemental Unemployment	Total Rate
1	50	\$27.80	\$11.39	\$21.57	\$0.00	\$60.76
2	60	\$33.35	\$11.39	\$21.57	\$0.00	\$66.31
3	70	\$38.91	\$11.39	\$21.57	\$0.00	\$71.87
4	80	\$44.47	\$11.39	\$21.57	\$0.00	\$77.43
5	90	\$50.03	\$11.39	\$21.57	\$0.00	\$82.99

**Notes:**

**Apprentice to Journeyworker Ratio:1:5**

<b>BULLDOZER/GRADER/SCRAPER</b> <i>OPERATING ENGINEERS LOCAL 4</i>	06/01/2021	\$50.19	\$13.75	\$15.80	\$0.00	\$79.74
	12/01/2021	\$51.33	\$13.75	\$15.80	\$0.00	\$80.88
For apprentice rates see "Apprentice- OPERATING ENGINEERS"						
<b>CAISSON &amp; UNDERPINNING BOTTOM MAN</b> <i>LABORERS - FOUNDATION AND MARINE</i>	06/01/2021	\$41.82	\$8.60	\$17.72	\$0.00	\$68.14
	12/01/2021	\$42.83	\$8.60	\$17.72	\$0.00	\$69.15
For apprentice rates see "Apprentice- LABORER"						
<b>CAISSON &amp; UNDERPINNING LABORER</b> <i>LABORERS - FOUNDATION AND MARINE</i>	06/01/2021	\$40.67	\$8.60	\$17.72	\$0.00	\$66.99
	12/01/2021	\$41.68	\$8.60	\$17.72	\$0.00	\$68.00
For apprentice rates see "Apprentice- LABORER"						
<b>CAISSON &amp; UNDERPINNING TOP MAN</b> <i>LABORERS - FOUNDATION AND MARINE</i>	06/01/2021	\$40.67	\$8.60	\$17.72	\$0.00	\$66.99
	12/01/2021	\$41.68	\$8.60	\$17.72	\$0.00	\$68.00
For apprentice rates see "Apprentice- LABORER"						
<b>CARBIDE CORE DRILL OPERATOR</b> <i>LABORERS - ZONE 2</i>	06/01/2021	\$35.25	\$8.60	\$16.64	\$0.00	\$60.49
	12/01/2021	\$36.16	\$8.60	\$16.64	\$0.00	\$61.40
	06/01/2022	\$37.06	\$8.60	\$16.64	\$0.00	\$62.30
	12/01/2022	\$37.91	\$8.60	\$16.64	\$0.00	\$63.15
	06/01/2023	\$38.81	\$8.60	\$16.64	\$0.00	\$64.05
	12/01/2023	\$39.71	\$8.60	\$16.64	\$0.00	\$64.95
For apprentice rates see "Apprentice- LABORER"						
<b>CARPENTER</b> <i>CARPENTERS -ZONE 2 (Eastern Massachusetts)</i>	09/01/2021	\$44.18	\$8.58	\$19.82	\$0.00	\$72.58
	03/01/2022	\$44.78	\$8.58	\$19.82	\$0.00	\$73.18
	09/01/2022	\$45.43	\$8.58	\$19.82	\$0.00	\$73.83
	03/01/2023	\$46.03	\$8.58	\$19.82	\$0.00	\$74.43

**Classification**

**Effective Date    Base Wage    Health    Pension    Supplemental Unemployment    Total Rate**

**Apprentice - CARPENTER - Zone 2 Eastern MA**

**Effective Date - 09/01/2021**

Step	percent	Apprentice Base Wage	Health	Pension	Supplemental Unemployment	Total Rate
1	50	\$22.09	\$8.58	\$1.73	\$0.00	\$32.40
2	60	\$26.51	\$8.58	\$1.73	\$0.00	\$36.82
3	70	\$30.93	\$8.58	\$14.63	\$0.00	\$54.14
4	75	\$33.14	\$8.58	\$14.63	\$0.00	\$56.35
5	80	\$35.34	\$8.58	\$16.36	\$0.00	\$60.28
6	80	\$35.34	\$8.58	\$16.36	\$0.00	\$60.28
7	90	\$39.76	\$8.58	\$18.09	\$0.00	\$66.43
8	90	\$39.76	\$8.58	\$18.09	\$0.00	\$66.43

**Effective Date - 03/01/2022**

Step	percent	Apprentice Base Wage	Health	Pension	Supplemental Unemployment	Total Rate
1	50	\$22.39	\$8.58	\$1.73	\$0.00	\$32.70
2	60	\$26.87	\$8.58	\$1.73	\$0.00	\$37.18
3	70	\$31.35	\$8.58	\$14.63	\$0.00	\$54.56
4	75	\$33.59	\$8.58	\$14.63	\$0.00	\$56.80
5	80	\$35.82	\$8.58	\$16.36	\$0.00	\$60.76
6	80	\$35.82	\$8.58	\$16.36	\$0.00	\$60.76
7	90	\$40.30	\$8.58	\$18.09	\$0.00	\$66.97
8	90	\$40.30	\$8.58	\$18.09	\$0.00	\$66.97

**Notes:**  
 % Indentured After 10/1/17; 45/45/55/55/70/70/80/80  
 Step 1&2 \$30.19/ 3&4 \$36.28/ 5&6 \$55.87/ 7&8 \$62.01

**Apprentice to Journeyworker Ratio:1:5**

CARPENTER WOOD FRAME	04/01/2021	\$23.16	\$7.21	\$4.80	\$0.00	\$35.17
CARPENTERS-ZONE 3 (Wood Frame)	04/01/2022	\$23.66	\$7.21	\$4.80	\$0.00	\$35.67
All Aspects of New Wood Frame Work	04/01/2023	\$24.16	\$7.21	\$4.80	\$0.00	\$36.17

**Classification**

**Effective Date    Base Wage    Health    Pension    Supplemental Unemployment    Total Rate**

**Apprentice - CARPENTER (Wood Frame) - Zone 3**

**Effective Date - 04/01/2021**

Step	percent	Apprentice Base Wage	Health	Pension	Supplemental Unemployment	Total Rate
1	60	\$13.90	\$7.21	\$0.00	\$0.00	\$21.11
2	60	\$13.90	\$7.21	\$0.00	\$0.00	\$21.11
3	65	\$15.05	\$7.21	\$0.00	\$0.00	\$22.26
4	70	\$16.21	\$7.21	\$0.00	\$0.00	\$23.42
5	75	\$17.37	\$7.21	\$3.80	\$0.00	\$28.38
6	80	\$18.53	\$7.21	\$3.80	\$0.00	\$29.54
7	85	\$19.69	\$7.21	\$3.80	\$0.00	\$30.70
8	90	\$20.84	\$7.21	\$3.80	\$0.00	\$31.85

**Effective Date - 04/01/2022**

Step	percent	Apprentice Base Wage	Health	Pension	Supplemental Unemployment	Total Rate
1	60	\$14.20	\$7.21	\$0.00	\$0.00	\$21.41
2	60	\$14.20	\$7.21	\$0.00	\$0.00	\$21.41
3	65	\$15.38	\$7.21	\$0.00	\$0.00	\$22.59
4	70	\$16.56	\$7.21	\$0.00	\$0.00	\$23.77
5	75	\$17.75	\$7.21	\$3.80	\$0.00	\$28.76
6	80	\$18.93	\$7.21	\$3.80	\$0.00	\$29.94
7	85	\$20.11	\$7.21	\$3.80	\$0.00	\$31.12
8	90	\$21.29	\$7.21	\$3.80	\$0.00	\$32.30

**Notes:**

% Indentured After 10/1/17; 45/45/55/55/70/70/80/80  
 Step 1&2 \$17.63/ 3&4 \$19.95/ 5&6 \$27.22/ 7&8 \$29.54

**Apprentice to Journeyworker Ratio:1:5**

CEMENT MASONRY/PLASTERING BRICKLAYERS LOCAL 3 (FOXBORO)	01/01/2020	\$44.67	\$12.75	\$22.41	\$0.62	\$80.45
--	------------	---------	---------	---------	--------	---------

**Apprentice - CEMENT MASONRY/PLASTERING - Foxboro**

**Effective Date - 01/01/2020**

Step	percent	Apprentice Base Wage	Health	Pension	Supplemental Unemployment	Total Rate
1	50	\$22.34	\$12.75	\$15.41	\$0.00	\$50.50
2	60	\$26.80	\$12.75	\$17.41	\$0.62	\$57.58
3	65	\$29.04	\$12.75	\$18.41	\$0.62	\$60.82
4	70	\$31.27	\$12.75	\$19.41	\$0.62	\$64.05
5	75	\$33.50	\$12.75	\$20.41	\$0.62	\$67.28
6	80	\$35.74	\$12.75	\$21.41	\$0.62	\$70.52
7	90	\$40.20	\$12.75	\$22.41	\$0.62	\$75.98

**Notes:**

Steps 3,4 are 500 hrs. All other steps are 1,000 hrs.

**Apprentice to Journeyworker Ratio:1:3**

Classification	Effective Date	Base Wage	Health	Pension	Supplemental Unemployment	Total Rate
CHAIN SAW OPERATOR <i>LABORERS - ZONE 2</i>	06/01/2021	\$35.25	\$8.60	\$16.64	\$0.00	\$60.49
	12/01/2021	\$36.16	\$8.60	\$16.64	\$0.00	\$61.40
	06/01/2022	\$37.06	\$8.60	\$16.64	\$0.00	\$62.30
	12/01/2022	\$37.91	\$8.60	\$16.64	\$0.00	\$63.15
	06/01/2023	\$38.81	\$8.60	\$16.64	\$0.00	\$64.05
	12/01/2023	\$39.71	\$8.60	\$16.64	\$0.00	\$64.95
For apprentice rates see "Apprentice- LABORER"						
CLAM SHELLS/SLURRY BUCKETS/HEADING MACHINES <i>OPERATING ENGINEERS LOCAL 4</i>	06/01/2021	\$51.73	\$13.75	\$15.80	\$0.00	\$81.28
	12/01/2021	\$52.88	\$13.75	\$15.80	\$0.00	\$82.43
For apprentice rates see "Apprentice- OPERATING ENGINEERS"						
COMPRESSOR OPERATOR <i>OPERATING ENGINEERS LOCAL 4</i>	06/01/2021	\$33.40	\$13.75	\$15.80	\$0.00	\$62.95
	12/01/2021	\$34.19	\$13.75	\$15.80	\$0.00	\$63.74
For apprentice rates see "Apprentice- OPERATING ENGINEERS"						
DELEADER (BRIDGE) <i>PAINTERS LOCAL 35 - ZONE 2</i>	01/01/2021	\$52.06	\$8.25	\$22.75	\$0.00	\$83.06

**Apprentice - PAINTER Local 35 - BRIDGES/TANKS**

**Effective Date - 01/01/2021**

Step	percent	Apprentice Base Wage	Health	Pension	Supplemental Unemployment	Total Rate
1	50	\$26.03	\$8.25	\$0.00	\$0.00	\$34.28
2	55	\$28.63	\$8.25	\$6.16	\$0.00	\$43.04
3	60	\$31.24	\$8.25	\$6.72	\$0.00	\$46.21
4	65	\$33.84	\$8.25	\$7.28	\$0.00	\$49.37
5	70	\$36.44	\$8.25	\$19.39	\$0.00	\$64.08
6	75	\$39.05	\$8.25	\$19.95	\$0.00	\$67.25
7	80	\$41.65	\$8.25	\$20.51	\$0.00	\$70.41
8	90	\$46.85	\$8.25	\$21.63	\$0.00	\$76.73

**Notes:**

Steps are 750 hrs.

**Apprentice to Journeyworker Ratio:1:1**

DEMO: ADZEMAN <i>LABORERS - ZONE 2</i>	06/01/2021	\$40.82	\$8.60	\$17.57	\$0.00	\$66.99
	12/01/2021	\$41.83	\$8.60	\$17.57	\$0.00	\$68.00
	06/01/2022	\$42.83	\$8.60	\$17.57	\$0.00	\$69.00
	12/01/2022	\$43.83	\$8.60	\$17.57	\$0.00	\$70.00
	06/01/2023	\$44.83	\$8.60	\$17.57	\$0.00	\$71.00
	12/01/2023	\$46.08	\$8.60	\$17.57	\$0.00	\$72.25
For apprentice rates see "Apprentice- LABORER"						
DEMO: BACKHOE/LOADER/HAMMER OPERATOR <i>LABORERS - ZONE 2</i>	06/01/2021	\$41.82	\$8.60	\$17.57	\$0.00	\$67.99
	12/01/2021	\$42.83	\$8.60	\$17.57	\$0.00	\$69.00
	06/01/2022	\$43.83	\$8.60	\$17.57	\$0.00	\$70.00
	12/01/2022	\$44.83	\$8.60	\$17.57	\$0.00	\$71.00
	06/01/2023	\$45.83	\$8.60	\$17.57	\$0.00	\$72.00
	12/01/2023	\$47.08	\$8.60	\$17.57	\$0.00	\$73.25
For apprentice rates see "Apprentice- LABORER"						



Classification	Effective Date	Base Wage	Health	Pension	Supplemental Unemployment	Total Rate
DEMO: BURNERS <i>LABORERS - ZONE 2</i>	06/01/2021	\$41.57	\$8.60	\$17.57	\$0.00	\$67.74
	12/01/2021	\$42.58	\$8.60	\$17.57	\$0.00	\$68.75
	06/01/2022	\$43.58	\$8.60	\$17.57	\$0.00	\$69.75
	12/01/2022	\$44.58	\$8.60	\$17.57	\$0.00	\$70.75
	06/01/2023	\$45.58	\$8.60	\$17.57	\$0.00	\$71.75
	12/01/2023	\$46.83	\$8.60	\$17.57	\$0.00	\$73.00
For apprentice rates see "Apprentice- LABORER"						
DEMO: CONCRETE CUTTER/SAWYER <i>LABORERS - ZONE 2</i>	06/01/2021	\$41.82	\$8.60	\$17.57	\$0.00	\$67.99
	12/01/2021	\$42.83	\$8.60	\$17.57	\$0.00	\$69.00
	06/01/2022	\$43.83	\$8.60	\$17.57	\$0.00	\$70.00
	12/01/2022	\$44.83	\$8.60	\$17.57	\$0.00	\$71.00
	06/01/2023	\$45.83	\$8.60	\$17.57	\$0.00	\$72.00
	12/01/2023	\$47.08	\$8.60	\$17.57	\$0.00	\$73.25
For apprentice rates see "Apprentice- LABORER"						
DEMO: JACKHAMMER OPERATOR <i>LABORERS - ZONE 2</i>	06/01/2021	\$41.57	\$8.60	\$17.57	\$0.00	\$67.74
	12/01/2021	\$42.58	\$8.60	\$17.57	\$0.00	\$68.75
	06/01/2022	\$43.58	\$8.60	\$17.57	\$0.00	\$69.75
	12/01/2022	\$44.58	\$8.60	\$17.57	\$0.00	\$70.75
	06/01/2023	\$45.58	\$8.60	\$17.57	\$0.00	\$71.75
	12/01/2023	\$46.83	\$8.60	\$17.57	\$0.00	\$73.00
For apprentice rates see "Apprentice- LABORER"						
DEMO: WRECKING LABORER <i>LABORERS - ZONE 2</i>	06/01/2021	\$40.82	\$8.60	\$17.57	\$0.00	\$66.99
	12/01/2021	\$41.83	\$8.60	\$17.57	\$0.00	\$68.00
	06/01/2022	\$42.83	\$8.60	\$17.57	\$0.00	\$69.00
	12/01/2022	\$43.83	\$8.60	\$17.57	\$0.00	\$70.00
	06/01/2023	\$44.83	\$8.60	\$17.57	\$0.00	\$71.00
	12/01/2023	\$46.08	\$8.60	\$17.57	\$0.00	\$72.25
For apprentice rates see "Apprentice- LABORER"						
DIRECTIONAL DRILL MACHINE OPERATOR <i>OPERATING ENGINEERS LOCAL 4</i>	06/01/2021	\$50.19	\$13.75	\$15.80	\$0.00	\$79.74
	12/01/2021	\$51.33	\$13.75	\$15.80	\$0.00	\$80.88
For apprentice rates see "Apprentice- OPERATING ENGINEERS"						
DIVER <i>PILE DRIVER LOCAL 56 (ZONE 1)</i>	08/01/2020	\$68.70	\$9.40	\$23.12	\$0.00	\$101.22
For apprentice rates see "Apprentice- PILE DRIVER"						
DIVER TENDER <i>PILE DRIVER LOCAL 56 (ZONE 1)</i>	08/01/2020	\$49.07	\$9.40	\$23.12	\$0.00	\$81.59
For apprentice rates see "Apprentice- PILE DRIVER"						
DIVER TENDER (EFFLUENT) <i>PILE DRIVER LOCAL 56 (ZONE 1)</i>	08/01/2020	\$73.60	\$9.40	\$23.12	\$0.00	\$106.12
For apprentice rates see "Apprentice- PILE DRIVER"						
DIVER/SLURRY (EFFLUENT) <i>PILE DRIVER LOCAL 56 (ZONE 1)</i>	08/01/2020	\$103.05	\$9.40	\$23.12	\$0.00	\$135.57
For apprentice rates see "Apprentice- PILE DRIVER"						
DRAWBRIDGE OPERATOR (Construction) <i>DRAWBRIDGE - SEIU LOCAL 888</i>	07/01/2020	\$26.77	\$6.67	\$3.93	\$0.16	\$37.53
ELECTRICIAN <i>ELECTRICIANS LOCAL 223</i>	09/01/2020	\$43.66	\$10.90	\$14.66	\$0.00	\$69.22

**Classification**

**Effective Date    Base Wage    Health    Pension    Supplemental Unemployment    Total Rate**

**Apprentice - ELECTRICIAN - Local 223**

**Effective Date - 09/01/2020**

Step	percent	Apprentice Base Wage	Health	Pension	Supplemental Unemployment	Total Rate
1	40	\$17.46	\$10.90	\$0.52	\$0.00	\$28.88
2	45	\$19.65	\$10.90	\$0.59	\$0.00	\$31.14
3	50	\$21.83	\$10.90	\$0.65	\$0.00	\$33.38
4	55	\$24.01	\$10.90	\$6.28	\$0.00	\$41.19
5	60	\$26.20	\$10.90	\$6.77	\$0.00	\$43.87
6	65	\$28.38	\$10.90	\$7.24	\$0.00	\$46.52
7	70	\$30.56	\$10.90	\$7.73	\$0.00	\$49.19
8	75	\$32.75	\$10.90	\$8.21	\$0.00	\$51.86

**Notes:**

**Apprentice to Journeyworker Ratio:2:3\*\*\***

ELEVATOR CONSTRUCTOR ELEVATOR CONSTRUCTORS LOCAL 4	01/01/2021	\$63.47	\$15.88	\$19.31	\$0.00	\$98.66
	01/01/2022	\$65.62	\$16.03	\$20.21	\$0.00	\$101.86

**Apprentice - ELEVATOR CONSTRUCTOR - Local 4**

**Effective Date - 01/01/2021**

Step	percent	Apprentice Base Wage	Health	Pension	Supplemental Unemployment	Total Rate
1	50	\$31.74	\$15.88	\$0.00	\$0.00	\$47.62
2	55	\$34.91	\$15.88	\$19.31	\$0.00	\$70.10
3	65	\$41.26	\$15.88	\$19.31	\$0.00	\$76.45
4	70	\$44.43	\$15.88	\$19.31	\$0.00	\$79.62
5	80	\$50.78	\$15.88	\$19.31	\$0.00	\$85.97

**Effective Date - 01/01/2022**

Step	percent	Apprentice Base Wage	Health	Pension	Supplemental Unemployment	Total Rate
1	50	\$32.81	\$16.03	\$0.00	\$0.00	\$48.84
2	55	\$36.09	\$16.03	\$20.21	\$0.00	\$72.33
3	65	\$42.65	\$16.03	\$20.21	\$0.00	\$78.89
4	70	\$45.93	\$16.03	\$20.21	\$0.00	\$82.17
5	80	\$52.50	\$16.03	\$20.21	\$0.00	\$88.74

**Notes:**

Steps 1-2 are 6 mos.; Steps 3-5 are 1 year

**Apprentice to Journeyworker Ratio:1:1**

ELEVATOR CONSTRUCTOR HELPER ELEVATOR CONSTRUCTORS LOCAL 4	01/01/2021	\$44.43	\$15.88	\$19.31	\$0.00	\$79.62
	01/01/2022	\$45.93	\$16.03	\$20.21	\$0.00	\$82.17

For apprentice rates see "Apprentice - ELEVATOR CONSTRUCTOR"

FENCE & GUARD RAIL ERECTOR (HEAVY & HIGHWAY) LABORERS - ZONE 2 (HEAVY & HIGHWAY)	06/01/2021	\$35.25	\$8.60	\$16.64	\$0.00	\$60.49
	12/01/2021	\$36.16	\$8.60	\$16.64	\$0.00	\$61.40

Classification	Effective Date	Base Wage	Health	Pension	Supplemental Unemployment	Total Rate
For apprentice rates see "Apprentice- LABORER (Heavy and Highway)						
FIELD ENG.INST.PERSON-BLDG,SITE,HVY/HWY <i>OPERATING ENGINEERS LOCAL 4</i>	05/01/2021	\$45.88	\$13.50	\$15.70	\$0.00	\$75.08
	11/01/2021	\$46.88	\$13.50	\$15.70	\$0.00	\$76.08
	05/01/2022	\$48.03	\$13.50	\$15.70	\$0.00	\$77.23
For apprentice rates see "Apprentice- OPERATING ENGINEERS"						
FIELD ENG.PARTY CHIEF-BLDG,SITE,HVY/HWY <i>OPERATING ENGINEERS LOCAL 4</i>	05/01/2021	\$47.40	\$13.50	\$15.70	\$0.00	\$76.60
	11/01/2021	\$48.41	\$13.50	\$15.70	\$0.00	\$77.61
	05/01/2022	\$49.57	\$13.50	\$15.70	\$0.00	\$78.77
For apprentice rates see "Apprentice- OPERATING ENGINEERS"						
FIELD ENG.ROD PERSON-BLDG,SITE,HVY/HWY <i>OPERATING ENGINEERS LOCAL 4</i>	05/01/2021	\$22.91	\$13.50	\$15.70	\$0.00	\$52.11
	11/01/2021	\$23.51	\$13.50	\$15.70	\$0.00	\$52.71
	05/01/2022	\$24.18	\$13.50	\$15.70	\$0.00	\$53.38
For apprentice rates see "Apprentice- OPERATING ENGINEERS"						
FIRE ALARM INSTALLER <i>ELECTRICIANS LOCAL 223</i>	09/01/2020	\$43.66	\$10.90	\$14.66	\$0.00	\$69.22
For apprentice rates see "Apprentice- ELECTRICIAN"						
FIRE ALARM REPAIR / MAINTENANCE <i>LOCAL 223</i> <i>/ COMMISSIONINGELECTRICIANS</i>	09/01/2020	\$36.86	\$10.90	\$12.45	\$0.00	\$60.21
For apprentice rates see "Apprentice- TELECOMMUNICATIONS TECHNICIAN"						
FIREMAN (ASST. ENGINEER) <i>OPERATING ENGINEERS LOCAL 4</i>	06/01/2021	\$41.31	\$13.75	\$15.80	\$0.00	\$70.86
	12/01/2021	\$42.26	\$13.75	\$15.80	\$0.00	\$71.81
For apprentice rates see "Apprentice- OPERATING ENGINEERS"						
FLAGGER & SIGNALER (HEAVY & HIGHWAY) <i>LABORERS - ZONE 2 (HEAVY &amp; HIGHWAY)</i>	06/01/2021	\$24.50	\$8.60	\$16.64	\$0.00	\$49.74
	12/01/2021	\$24.50	\$8.60	\$16.64	\$0.00	\$49.74
For apprentice rates see "Apprentice- LABORER (Heavy and Highway)						
FLOORCOVERER <i>FLOORCOVERERS LOCAL 2168 ZONE 1</i>	09/01/2021	\$49.38	\$8.58	\$20.12	\$0.00	\$78.08
	03/01/2022	\$50.18	\$8.58	\$20.12	\$0.00	\$78.88

**Classification**

**Effective Date    Base Wage    Health    Pension    Supplemental Unemployment    Total Rate**

**Apprentice - FLOORCOVERER - Local 2168 Zone I**

**Effective Date - 09/01/2021**

Step	percent	Apprentice Base Wage	Health	Pension	Supplemental Unemployment	Total Rate
1	50	\$24.69	\$8.58	\$1.79	\$0.00	\$35.06
2	55	\$27.16	\$8.58	\$1.79	\$0.00	\$37.53
3	60	\$29.63	\$8.58	\$14.75	\$0.00	\$52.96
4	65	\$32.10	\$8.58	\$14.75	\$0.00	\$55.43
5	70	\$34.57	\$8.58	\$16.54	\$0.00	\$59.69
6	75	\$37.04	\$8.58	\$16.54	\$0.00	\$62.16
7	80	\$39.50	\$8.58	\$18.33	\$0.00	\$66.41
8	85	\$41.97	\$8.58	\$18.33	\$0.00	\$68.88

**Effective Date - 03/01/2022**

Step	percent	Apprentice Base Wage	Health	Pension	Supplemental Unemployment	Total Rate
1	50	\$25.09	\$8.58	\$1.79	\$0.00	\$35.46
2	55	\$27.60	\$8.58	\$1.79	\$0.00	\$37.97
3	60	\$30.11	\$8.58	\$14.75	\$0.00	\$53.44
4	65	\$32.62	\$8.58	\$14.75	\$0.00	\$55.95
5	70	\$35.13	\$8.58	\$16.54	\$0.00	\$60.25
6	75	\$37.64	\$8.58	\$16.54	\$0.00	\$62.76
7	80	\$40.14	\$8.58	\$18.33	\$0.00	\$67.05
8	85	\$42.65	\$8.58	\$18.33	\$0.00	\$69.56

**Notes:** Steps are 750 hrs.  
 % After 10/1/17; 45/45/55/55/70/70/80/80 (1500hr Steps)  
 Step 1&2 \$32.59/ 3&4 \$39.26/ 5&6 \$59.69/ 7&8 \$66.41

**Apprentice to Journeyworker Ratio:1:1**

FORK LIFT/CHERRY PICKER <i>OPERATING ENGINEERS LOCAL 4</i>	06/01/2021	\$50.73	\$13.75	\$15.80	\$0.00	\$80.28
For apprentice rates see "Apprentice- OPERATING ENGINEERS"	12/01/2021	\$51.88	\$13.75	\$15.80	\$0.00	\$81.43
GENERATOR/LIGHTING PLANT/HEATERS <i>OPERATING ENGINEERS LOCAL 4</i>	06/01/2021	\$33.40	\$13.75	\$15.80	\$0.00	\$62.95
For apprentice rates see "Apprentice- OPERATING ENGINEERS"	12/01/2021	\$34.19	\$13.75	\$15.80	\$0.00	\$63.74
GLAZIER (GLASS PLANK/AIR BARRIER/INTERIOR SYSTEMS) <i>GLAZIERS LOCAL 1333</i>	06/01/2020	\$39.18	\$10.80	\$10.45	\$0.00	\$60.43

**Classification**

**Effective Date    Base Wage    Health    Pension    Supplemental Unemployment    Total Rate**

**Apprentice - GLAZIER - Local 1333**

**Effective Date - 06/01/2020**

Step	percent	Apprentice Base Wage	Health	Pension	Supplemental Unemployment	Total Rate
1	50	\$19.59	\$10.80	\$1.80	\$0.00	\$32.19
2	56	\$22.04	\$10.80	\$1.80	\$0.00	\$34.64
3	63	\$24.49	\$10.80	\$2.45	\$0.00	\$37.74
4	69	\$26.94	\$10.80	\$2.45	\$0.00	\$40.19
5	75	\$29.39	\$10.80	\$3.15	\$0.00	\$43.34
6	81	\$31.83	\$10.80	\$3.15	\$0.00	\$45.78
7	88	\$34.28	\$10.80	\$10.45	\$0.00	\$55.53
8	94	\$36.73	\$10.80	\$10.45	\$0.00	\$57.98

**Notes:**

**Apprentice to Journeyworker Ratio:1:3**

HOISTING ENGINEER/CRANES/GRADALLS	06/01/2021	\$50.73	\$13.75	\$15.80	\$0.00	\$80.28
OPERATING ENGINEERS LOCAL 4	12/01/2021	\$51.88	\$13.75	\$15.80	\$0.00	\$81.43

**Classification**

**Effective Date   Base Wage   Health   Pension   Supplemental Unemployment   Total Rate**

**Apprentice - OPERATING ENGINEERS - Local 4**

**Effective Date - 06/01/2021**

Step	percent	Apprentice Base Wage	Health	Pension	Supplemental Unemployment	Total Rate
1	55	\$27.90	\$13.75	\$0.00	\$0.00	\$41.65
2	60	\$30.44	\$13.75	\$15.80	\$0.00	\$59.99
3	65	\$32.97	\$13.75	\$15.80	\$0.00	\$62.52
4	70	\$35.51	\$13.75	\$15.80	\$0.00	\$65.06
5	75	\$38.05	\$13.75	\$15.80	\$0.00	\$67.60
6	80	\$40.58	\$13.75	\$15.80	\$0.00	\$70.13
7	85	\$43.12	\$13.75	\$15.80	\$0.00	\$72.67
8	90	\$45.66	\$13.75	\$15.80	\$0.00	\$75.21

**Effective Date - 12/01/2021**

Step	percent	Apprentice Base Wage	Health	Pension	Supplemental Unemployment	Total Rate
1	55	\$28.53	\$13.75	\$0.00	\$0.00	\$42.28
2	60	\$31.13	\$13.75	\$15.80	\$0.00	\$60.68
3	65	\$33.72	\$13.75	\$15.80	\$0.00	\$63.27
4	70	\$36.32	\$13.75	\$15.80	\$0.00	\$65.87
5	75	\$38.91	\$13.75	\$15.80	\$0.00	\$68.46
6	80	\$41.50	\$13.75	\$15.80	\$0.00	\$71.05
7	85	\$44.10	\$13.75	\$15.80	\$0.00	\$73.65
8	90	\$46.69	\$13.75	\$15.80	\$0.00	\$76.24

**Notes:**

**Apprentice to Journeyworker Ratio:1:6**

HVAC (DUCTWORK) SHEETMETAL WORKERS LOCAL 17 - A	08/01/2021	\$51.95	\$13.80	\$25.60	\$2.74	\$94.09
	02/01/2022	\$53.70	\$13.80	\$25.60	\$2.79	\$95.89

For apprentice rates see "Apprentice- SHEET METAL WORKER"

HVAC (ELECTRICAL CONTROLS) ELECTRICIANS LOCAL 223	09/01/2020	\$43.66	\$10.90	\$14.66	\$0.00	\$69.22
--	------------	---------	---------	---------	--------	---------

For apprentice rates see "Apprentice- ELECTRICIAN"

HVAC (TESTING AND BALANCING - AIR) SHEETMETAL WORKERS LOCAL 17 - A	08/01/2021	\$51.95	\$13.80	\$25.60	\$2.74	\$94.09
	02/01/2022	\$53.70	\$13.80	\$25.60	\$2.79	\$95.89

For apprentice rates see "Apprentice- SHEET METAL WORKER"

HVAC (TESTING AND BALANCING -WATER) PLUMBERS & PIPEFITTERS LOCAL 51	08/30/2021	\$46.49	\$10.15	\$19.95	\$0.00	\$76.59
--	------------	---------	---------	---------	--------	---------

For apprentice rates see "Apprentice- PIPEFITTER" or "PLUMBER/PIPEFITTER"

HVAC MECHANIC PLUMBERS & PIPEFITTERS LOCAL 51	08/30/2021	\$46.49	\$10.15	\$19.95	\$0.00	\$76.59
--	------------	---------	---------	---------	--------	---------

For apprentice rates see "Apprentice- PIPEFITTER" or "PLUMBER/PIPEFITTER"

Classification	Effective Date	Base Wage	Health	Pension	Supplemental Unemployment	Total Rate
HYDRAULIC DRILLS <i>LABORERS - ZONE 2</i>	06/01/2021	\$35.75	\$8.60	\$16.64	\$0.00	\$60.99
	12/01/2021	\$36.66	\$8.60	\$16.64	\$0.00	\$61.90
	06/01/2022	\$37.56	\$8.60	\$16.64	\$0.00	\$62.80
	12/01/2022	\$38.41	\$8.60	\$16.64	\$0.00	\$63.65
	06/01/2023	\$39.31	\$8.60	\$16.64	\$0.00	\$64.55
	12/01/2023	\$40.21	\$8.60	\$16.64	\$0.00	\$65.45
For apprentice rates see "Apprentice- LABORER"						
HYDRAULIC DRILLS (HEAVY & HIGHWAY) <i>LABORERS - ZONE 2 (HEAVY &amp; HIGHWAY)</i>	06/01/2021	\$35.75	\$8.60	\$16.64	\$0.00	\$60.99
	12/01/2021	\$36.66	\$8.60	\$16.64	\$0.00	\$61.90
For apprentice rates see "Apprentice- LABORER (Heavy and Highway)"						
INSULATOR (PIPES & TANKS) <i>HEAT &amp; FROST INSULATORS LOCAL 6 (SOUTHERN MASS)</i>	09/01/2021	\$46.50	\$13.80	\$17.14	\$0.00	\$77.44
	09/01/2022	\$48.95	\$13.80	\$17.14	\$0.00	\$79.89

**Apprentice - ASBESTOS INSULATOR (Pipes & Tanks) - Local 6 Southern MA**

**Effective Date - 09/01/2021**

Step	percent	Apprentice Base Wage	Health	Pension	Supplemental Unemployment	Total Rate
1	50	\$23.25	\$13.80	\$12.42	\$0.00	\$49.47
2	60	\$27.90	\$13.80	\$13.36	\$0.00	\$55.06
3	70	\$32.55	\$13.80	\$14.31	\$0.00	\$60.66
4	80	\$37.20	\$13.80	\$15.25	\$0.00	\$66.25

**Effective Date - 09/01/2022**

Step	percent	Apprentice Base Wage	Health	Pension	Supplemental Unemployment	Total Rate
1	50	\$24.48	\$13.80	\$12.42	\$0.00	\$50.70
2	60	\$29.37	\$13.80	\$13.36	\$0.00	\$56.53
3	70	\$34.27	\$13.80	\$14.31	\$0.00	\$62.38
4	80	\$39.16	\$13.80	\$15.25	\$0.00	\$68.21

**Notes:**

Steps are 1 year

**Apprentice to Journeyworker Ratio:1:4**

IRONWORKER/WELDER <i>IRONWORKERS LOCAL 37</i>	03/16/2021	\$42.46	\$7.70	\$17.10	\$0.00	\$67.26
--	------------	---------	--------	---------	--------	---------

**Classification**

**Effective Date    Base Wage    Health    Pension    Supplemental Unemployment    Total Rate**

**Apprentice - IRONWORKER - Local 37**

**Effective Date - 03/16/2021**

Step	percent	Apprentice Base Wage	Health	Pension	Supplemental Unemployment	Total Rate
1	70	\$29.72	\$7.70	\$17.10	\$0.00	\$54.52
2	75	\$31.85	\$7.70	\$17.10	\$0.00	\$56.65
3	80	\$33.97	\$7.70	\$17.10	\$0.00	\$58.77
4	85	\$36.09	\$7.70	\$17.10	\$0.00	\$60.89
5	90	\$38.21	\$7.70	\$17.10	\$0.00	\$63.01
6	95	\$40.34	\$7.70	\$17.10	\$0.00	\$65.14

**Notes:**

**Apprentice to Journeyworker Ratio:1:4**

JACKHAMMER & PAVING BREAKER OPERATOR LABORERS - ZONE 2	06/01/2021	\$35.25	\$8.60	\$16.64	\$0.00	\$60.49
	12/01/2021	\$36.16	\$8.60	\$16.64	\$0.00	\$61.40
	06/01/2022	\$37.06	\$8.60	\$16.64	\$0.00	\$62.30
	12/01/2022	\$37.91	\$8.60	\$16.64	\$0.00	\$63.15
	06/01/2023	\$38.81	\$8.60	\$16.64	\$0.00	\$64.05
	12/01/2023	\$39.71	\$8.60	\$16.64	\$0.00	\$64.95

For apprentice rates see "Apprentice- LABORER"

LABORER LABORERS - ZONE 2	06/01/2021	\$35.00	\$8.60	\$16.64	\$0.00	\$60.24
	12/01/2021	\$35.91	\$8.60	\$16.64	\$0.00	\$61.15
	06/01/2022	\$36.81	\$8.60	\$16.64	\$0.00	\$62.05
	12/01/2022	\$37.66	\$8.60	\$16.64	\$0.00	\$62.90
	06/01/2023	\$38.56	\$8.60	\$16.64	\$0.00	\$63.80
	12/01/2023	\$39.46	\$8.60	\$16.64	\$0.00	\$64.70



**Classification**

**Effective Date    Base Wage    Health    Pension    Supplemental Unemployment    Total Rate**

**Apprentice - LABORER - Zone 2**

**Effective Date - 06/01/2021**

Step	percent	Apprentice Base Wage	Health	Pension	Supplemental Unemployment	Total Rate
1	60	\$21.00	\$8.60	\$16.64	\$0.00	\$46.24
2	70	\$24.50	\$8.60	\$16.64	\$0.00	\$49.74
3	80	\$28.00	\$8.60	\$16.64	\$0.00	\$53.24
4	90	\$31.50	\$8.60	\$16.64	\$0.00	\$56.74

**Effective Date - 12/01/2021**

Step	percent	Apprentice Base Wage	Health	Pension	Supplemental Unemployment	Total Rate
1	60	\$21.55	\$8.60	\$16.64	\$0.00	\$46.79
2	70	\$25.14	\$8.60	\$16.64	\$0.00	\$50.38
3	80	\$28.73	\$8.60	\$16.64	\$0.00	\$53.97
4	90	\$32.32	\$8.60	\$16.64	\$0.00	\$57.56

**Notes:**

**Apprentice to Journeyworker Ratio:1:5**

LABORER (HEAVY & HIGHWAY)	06/01/2021	\$35.00	\$8.60	\$16.64	\$0.00	\$60.24
LABORERS - ZONE 2 (HEAVY & HIGHWAY)	12/01/2021	\$35.91	\$8.60	\$16.64	\$0.00	\$61.15

**Apprentice - LABORER (Heavy & Highway) - Zone 2**

**Effective Date - 06/01/2021**

Step	percent	Apprentice Base Wage	Health	Pension	Supplemental Unemployment	Total Rate
1	60	\$21.00	\$8.60	\$16.64	\$0.00	\$46.24
2	70	\$24.50	\$8.60	\$16.64	\$0.00	\$49.74
3	80	\$28.00	\$8.60	\$16.64	\$0.00	\$53.24
4	90	\$31.50	\$8.60	\$16.64	\$0.00	\$56.74

**Effective Date - 12/01/2021**

Step	percent	Apprentice Base Wage	Health	Pension	Supplemental Unemployment	Total Rate
1	60	\$21.55	\$8.60	\$16.64	\$0.00	\$46.79
2	70	\$25.14	\$8.60	\$16.64	\$0.00	\$50.38
3	80	\$28.73	\$8.60	\$16.64	\$0.00	\$53.97
4	90	\$32.32	\$8.60	\$16.64	\$0.00	\$57.56

**Notes:**

**Apprentice to Journeyworker Ratio:1:5**

Classification	Effective Date	Base Wage	Health	Pension	Supplemental Unemployment	Total Rate
LABORER: CARPENTER TENDER <i>LABORERS - ZONE 2</i>	06/01/2021	\$35.00	\$8.60	\$16.64	\$0.00	\$60.24
	12/01/2021	\$35.91	\$8.60	\$16.64	\$0.00	\$61.15
	06/01/2022	\$36.81	\$8.60	\$16.64	\$0.00	\$62.05
	12/01/2022	\$37.66	\$8.60	\$16.64	\$0.00	\$62.90
	06/01/2023	\$38.56	\$8.60	\$16.64	\$0.00	\$63.80
	12/01/2023	\$39.46	\$8.60	\$16.64	\$0.00	\$64.70
For apprentice rates see "Apprentice- LABORER"						
LABORER: CEMENT FINISHER TENDER <i>LABORERS - ZONE 2</i>	06/01/2021	\$35.00	\$8.60	\$16.64	\$0.00	\$60.24
	12/01/2021	\$35.91	\$8.60	\$16.64	\$0.00	\$61.15
	06/01/2022	\$36.81	\$8.60	\$16.64	\$0.00	\$62.05
	12/01/2022	\$37.66	\$8.60	\$16.64	\$0.00	\$62.90
	06/01/2023	\$38.56	\$8.60	\$16.64	\$0.00	\$63.80
	12/01/2023	\$39.46	\$8.60	\$16.64	\$0.00	\$64.70
For apprentice rates see "Apprentice- LABORER"						
LABORER: HAZARDOUS WASTE/ASBESTOS REMOVER <i>LABORERS - ZONE 2</i>	06/01/2021	\$35.09	\$8.60	\$16.70	\$0.00	\$60.39
	12/01/2021	\$36.00	\$8.60	\$16.70	\$0.00	\$61.30
	06/01/2022	\$36.90	\$8.60	\$16.70	\$0.00	\$62.20
	12/01/2022	\$37.75	\$8.60	\$16.70	\$0.00	\$63.05
	06/01/2023	\$38.65	\$8.60	\$16.70	\$0.00	\$63.95
	12/01/2023	\$39.55	\$8.60	\$16.70	\$0.00	\$64.85
For apprentice rates see "Apprentice- LABORER"						
LABORER: MASON TENDER <i>LABORERS - ZONE 2</i>	06/01/2021	\$35.25	\$8.60	\$16.64	\$0.00	\$60.49
	12/01/2021	\$36.16	\$8.60	\$16.64	\$0.00	\$61.40
	06/01/2022	\$37.06	\$8.60	\$16.64	\$0.00	\$62.30
	12/01/2022	\$37.91	\$8.60	\$16.64	\$0.00	\$63.15
	06/01/2023	\$38.81	\$8.60	\$16.64	\$0.00	\$64.05
	12/01/2023	\$39.71	\$8.60	\$16.64	\$0.00	\$64.95
For apprentice rates see "Apprentice- LABORER"						
LABORER: MASON TENDER (HEAVY & HIGHWAY) <i>LABORERS - ZONE 2 (HEAVY &amp; HIGHWAY)</i>	06/01/2021	\$35.25	\$8.60	\$16.64	\$0.00	\$60.49
	12/01/2021	\$36.16	\$8.60	\$16.64	\$0.00	\$61.40
For apprentice rates see "Apprentice- LABORER (Heavy and Highway)"						
LABORER: MULTI-TRADE TENDER <i>LABORERS - ZONE 2</i>	06/01/2021	\$35.00	\$8.60	\$16.64	\$0.00	\$60.24
	12/01/2021	\$35.91	\$8.60	\$16.64	\$0.00	\$61.15
	06/01/2022	\$36.81	\$8.60	\$16.64	\$0.00	\$62.05
	12/01/2022	\$37.66	\$8.60	\$16.64	\$0.00	\$62.90
	06/01/2023	\$38.56	\$8.60	\$16.64	\$0.00	\$63.80
	12/01/2023	\$39.46	\$8.60	\$16.64	\$0.00	\$64.70
For apprentice rates see "Apprentice- LABORER"						
LABORER: TREE REMOVER <i>LABORERS - ZONE 2</i>	06/01/2021	\$35.00	\$8.60	\$16.64	\$0.00	\$60.24
	12/01/2021	\$35.91	\$8.60	\$16.64	\$0.00	\$61.15
	06/01/2022	\$36.81	\$8.60	\$16.64	\$0.00	\$62.05
	12/01/2022	\$37.66	\$8.60	\$16.64	\$0.00	\$62.90
	06/01/2023	\$38.56	\$8.60	\$16.64	\$0.00	\$63.80
	12/01/2023	\$39.46	\$8.60	\$16.64	\$0.00	\$64.70
This classification applies to the removal of standing trees, and the trimming and removal of branches and limbs when related to public works construction or site clearance incidental to construction . For apprentice rates see "Apprentice- LABORER"						

Classification	Effective Date	Base Wage	Health	Pension	Supplemental Unemployment	Total Rate
LASER BEAM OPERATOR <i>LABORERS - ZONE 2</i>	06/01/2021	\$35.25	\$8.60	\$16.64	\$0.00	\$60.49
	12/01/2021	\$36.16	\$8.60	\$16.64	\$0.00	\$61.40
	06/01/2022	\$37.06	\$8.60	\$16.64	\$0.00	\$62.30
	12/01/2022	\$37.91	\$8.60	\$16.64	\$0.00	\$63.15
	06/01/2023	\$38.81	\$8.60	\$16.64	\$0.00	\$64.05
	12/01/2023	\$39.71	\$8.60	\$16.64	\$0.00	\$64.95
For apprentice rates see "Apprentice- LABORER"						
LASER BEAM OPERATOR (HEAVY & HIGHWAY) <i>LABORERS - ZONE 2 (HEAVY &amp; HIGHWAY)</i>	06/01/2021	\$35.25	\$8.60	\$16.64	\$0.00	\$60.49
	12/01/2021	\$36.16	\$8.60	\$16.64	\$0.00	\$61.40
For apprentice rates see "Apprentice- LABORER (Heavy and Highway)"						
MARBLE & TILE FINISHERS <i>BRICKLAYERS LOCAL 3 - MARBLE &amp; TILE</i>	08/01/2021	\$43.69	\$11.39	\$20.30	\$0.00	\$75.38
	02/01/2022	\$44.16	\$11.39	\$20.30	\$0.00	\$75.85

**Apprentice - MARBLE & TILE FINISHER - Local 3 Marble & Tile**

**Effective Date - 08/01/2021**

Step	percent	Apprentice Base Wage	Health	Pension	Supplemental Unemployment	Total Rate
1	50	\$21.85	\$11.39	\$20.30	\$0.00	\$53.54
2	60	\$26.21	\$11.39	\$20.30	\$0.00	\$57.90
3	70	\$30.58	\$11.39	\$20.30	\$0.00	\$62.27
4	80	\$34.95	\$11.39	\$20.30	\$0.00	\$66.64
5	90	\$39.32	\$11.39	\$20.30	\$0.00	\$71.01

**Effective Date - 02/01/2022**

Step	percent	Apprentice Base Wage	Health	Pension	Supplemental Unemployment	Total Rate
1	50	\$22.08	\$11.39	\$20.30	\$0.00	\$53.77
2	60	\$26.50	\$11.39	\$20.30	\$0.00	\$58.19
3	70	\$30.91	\$11.39	\$20.30	\$0.00	\$62.60
4	80	\$35.33	\$11.39	\$20.30	\$0.00	\$67.02
5	90	\$39.74	\$11.39	\$20.30	\$0.00	\$71.43

**Notes:**

**Apprentice to Journeyworker Ratio:1:3**

MARBLE MASONS, TILELAYERS & TERRAZZO MECH <i>BRICKLAYERS LOCAL 3 - MARBLE &amp; TILE</i>	08/01/2021	\$57.17	\$11.39	\$22.24	\$0.00	\$90.80
	02/01/2022	\$57.74	\$11.39	\$22.24	\$0.00	\$91.37

**Classification**

**Effective Date    Base Wage    Health    Pension    Supplemental Unemployment    Total Rate**

**Apprentice - MARBLE-TILE-TERRAZZO MECHANIC - Local 3 Marble & Tile**

**Effective Date - 08/01/2021**

Step	percent	Apprentice Base Wage	Health	Pension	Supplemental Unemployment	Total Rate
1	50	\$28.59	\$11.39	\$22.24	\$0.00	\$62.22
2	60	\$34.30	\$11.39	\$22.24	\$0.00	\$67.93
3	70	\$40.02	\$11.39	\$22.24	\$0.00	\$73.65
4	80	\$45.74	\$11.39	\$22.24	\$0.00	\$79.37
5	90	\$51.45	\$11.39	\$22.24	\$0.00	\$85.08

**Effective Date - 02/01/2022**

Step	percent	Apprentice Base Wage	Health	Pension	Supplemental Unemployment	Total Rate
1	50	\$28.87	\$11.39	\$22.24	\$0.00	\$62.50
2	60	\$34.64	\$11.39	\$22.24	\$0.00	\$68.27
3	70	\$40.42	\$11.39	\$22.24	\$0.00	\$74.05
4	80	\$46.19	\$11.39	\$22.24	\$0.00	\$79.82
5	90	\$51.97	\$11.39	\$22.24	\$0.00	\$85.60

**Notes:**

**Apprentice to Journeyworker Ratio:1:5**

MECH. SWEEPER OPERATOR (ON CONST. SITES) <i>OPERATING ENGINEERS LOCAL 4</i>	06/01/2021	\$50.19	\$13.75	\$15.80	\$0.00	\$79.74
	12/01/2021	\$51.33	\$13.75	\$15.80	\$0.00	\$80.88

For apprentice rates see "Apprentice- OPERATING ENGINEERS"

MECHANICS MAINTENANCE <i>OPERATING ENGINEERS LOCAL 4</i>	06/01/2021	\$50.19	\$13.75	\$15.80	\$0.00	\$79.74
	12/01/2021	\$51.33	\$13.75	\$15.80	\$0.00	\$80.88

For apprentice rates see "Apprentice- OPERATING ENGINEERS"

MILLWRIGHT (Zone 2) <i>MILLWRIGHTS LOCAL 1121 - Zone 2</i>	03/01/2021	\$39.42	\$8.58	\$21.57	\$0.00	\$69.57
	01/03/2022	\$40.67	\$8.58	\$21.57	\$0.00	\$70.82
	01/02/2023	\$41.92	\$8.58	\$21.57	\$0.00	\$72.07

**Apprentice - MILLWRIGHT - Local 1121 Zone 2**

**Effective Date - 03/01/2021**

Step	percent	Apprentice Base Wage	Health	Pension	Supplemental Unemployment	Total Rate
1	55	\$21.68	\$8.58	\$5.72	\$0.00	\$35.98
2	65	\$25.62	\$8.58	\$17.93	\$0.00	\$52.13
3	75	\$29.57	\$8.58	\$18.98	\$0.00	\$57.13
4	85	\$33.51	\$8.58	\$20.01	\$0.00	\$62.10

**Effective Date - 01/03/2022**

Step	percent	Apprentice Base Wage	Health	Pension	Supplemental Unemployment	Total Rate
1	55	\$22.37	\$8.58	\$5.72	\$0.00	\$36.67
2	65	\$26.44	\$8.58	\$17.93	\$0.00	\$52.95
3	75	\$30.50	\$8.58	\$18.98	\$0.00	\$58.06
4	85	\$34.57	\$8.58	\$20.01	\$0.00	\$63.16

**Notes:** Step 1&2 Appr. indentured after 1/6/2020 receive no pension, but do receive annuity. (Step 1 \$5.72, Step 2 \$6.66)  
Steps are 2,000 hours

**Apprentice to Journeyworker Ratio:1:5**

MORTAR MIXER LABORERS - ZONE 2	06/01/2021	\$35.25	\$8.60	\$16.64	\$0.00	\$60.49
	12/01/2021	\$36.16	\$8.60	\$16.64	\$0.00	\$61.40
	06/01/2022	\$37.06	\$8.60	\$16.64	\$0.00	\$62.30
	12/01/2022	\$37.91	\$8.60	\$16.64	\$0.00	\$63.15
	06/01/2023	\$38.81	\$8.60	\$16.64	\$0.00	\$64.05
	12/01/2023	\$39.71	\$8.60	\$16.64	\$0.00	\$64.95
For apprentice rates see "Apprentice- LABORER"						
OILER (OTHER THAN TRUCK CRANES,GRADALLS) OPERATING ENGINEERS LOCAL 4	06/01/2021	\$23.40	\$13.75	\$15.80	\$0.00	\$52.95
	12/01/2021	\$23.98	\$13.75	\$15.80	\$0.00	\$53.53
For apprentice rates see "Apprentice- OPERATING ENGINEERS"						
OILER (TRUCK CRANES, GRADALLS) OPERATING ENGINEERS LOCAL 4	06/01/2021	\$28.26	\$13.75	\$15.80	\$0.00	\$57.81
	12/01/2021	\$28.94	\$13.75	\$15.80	\$0.00	\$58.49
For apprentice rates see "Apprentice- OPERATING ENGINEERS"						
OTHER POWER DRIVEN EQUIPMENT - CLASS II OPERATING ENGINEERS LOCAL 4	06/01/2021	\$50.19	\$13.75	\$15.80	\$0.00	\$79.74
	12/01/2021	\$51.33	\$13.75	\$15.80	\$0.00	\$80.88
For apprentice rates see "Apprentice- OPERATING ENGINEERS"						
PAINTER (BRIDGES/TANKS) PAINTERS LOCAL 35 - ZONE 2	01/01/2021	\$52.06	\$8.25	\$22.75	\$0.00	\$83.06

**Classification**

**Effective Date    Base Wage    Health    Pension    Supplemental Unemployment    Total Rate**

**Apprentice - PAINTER Local 35 - BRIDGES/TANKS**

**Effective Date - 01/01/2021**

Step	percent	Apprentice Base Wage	Health	Pension	Supplemental Unemployment	Total Rate
1	50	\$26.03	\$8.25	\$0.00	\$0.00	\$34.28
2	55	\$28.63	\$8.25	\$6.16	\$0.00	\$43.04
3	60	\$31.24	\$8.25	\$6.72	\$0.00	\$46.21
4	65	\$33.84	\$8.25	\$7.28	\$0.00	\$49.37
5	70	\$36.44	\$8.25	\$19.39	\$0.00	\$64.08
6	75	\$39.05	\$8.25	\$19.95	\$0.00	\$67.25
7	80	\$41.65	\$8.25	\$20.51	\$0.00	\$70.41
8	90	\$46.85	\$8.25	\$21.63	\$0.00	\$76.73

**Notes:**  
Steps are 750 hrs.

**Apprentice to Journeyworker Ratio:1:1**

PAINTER (SPRAY OR SANDBLAST, NEW) *	01/01/2021	\$42.96	\$8.25	\$22.75	\$0.00	\$73.96
-------------------------------------	------------	---------	--------	---------	--------	---------

\* If 30% or more of surfaces to be painted are new construction, NEW paint rate shall be used. PAINTERS LOCAL 35 - ZONE 2

**Apprentice - PAINTER Local 35 Zone 2 - Spray/Sandblast - New**

**Effective Date - 01/01/2021**

Step	percent	Apprentice Base Wage	Health	Pension	Supplemental Unemployment	Total Rate
1	50	\$21.48	\$8.25	\$0.00	\$0.00	\$29.73
2	55	\$23.63	\$8.25	\$6.16	\$0.00	\$38.04
3	60	\$25.78	\$8.25	\$6.72	\$0.00	\$40.75
4	65	\$27.92	\$8.25	\$7.28	\$0.00	\$43.45
5	70	\$30.07	\$8.25	\$19.39	\$0.00	\$57.71
6	75	\$32.22	\$8.25	\$19.95	\$0.00	\$60.42
7	80	\$34.37	\$8.25	\$20.51	\$0.00	\$63.13
8	90	\$38.66	\$8.25	\$21.63	\$0.00	\$68.54

**Notes:**  
Steps are 750 hrs.

**Apprentice to Journeyworker Ratio:1:1**

PAINTER (SPRAY OR SANDBLAST, REPAINT)	01/01/2021	\$41.02	\$8.25	\$22.75	\$0.00	\$72.02
---------------------------------------	------------	---------	--------	---------	--------	---------

PAINTERS LOCAL 35 - ZONE 2

**Classification**

**Effective Date    Base Wage    Health    Pension    Supplemental Unemployment    Total Rate**

**Apprentice - PAINTER Local 35 Zone 2 - Spray/Sandblast - Repaint**

**Effective Date - 01/01/2021**

Step	percent	Apprentice Base Wage	Health	Pension	Supplemental Unemployment	Total Rate
1	50	\$20.51	\$8.25	\$0.00	\$0.00	\$28.76
2	55	\$22.56	\$8.25	\$6.16	\$0.00	\$36.97
3	60	\$24.61	\$8.25	\$6.72	\$0.00	\$39.58
4	65	\$26.66	\$8.25	\$7.28	\$0.00	\$42.19
5	70	\$28.71	\$8.25	\$19.39	\$0.00	\$56.35
6	75	\$30.77	\$8.25	\$19.95	\$0.00	\$58.97
7	80	\$32.82	\$8.25	\$20.51	\$0.00	\$61.58
8	90	\$36.92	\$8.25	\$21.63	\$0.00	\$66.80

**Notes:**

Steps are 750 hrs.

**Apprentice to Journeyworker Ratio:1:1**

PAINTER / TAPER (BRUSH, NEW) *	01/01/2021	\$41.56	\$8.25	\$22.75	\$0.00	\$72.56
--------------------------------	------------	---------	--------	---------	--------	---------

\* If 30% or more of surfaces to be painted are new construction, NEW paint rate shall be used. PAINTERS LOCAL 35 - ZONE 2

**Apprentice - PAINTER - Local 35 Zone 2 - BRUSH NEW**

**Effective Date - 01/01/2021**

Step	percent	Apprentice Base Wage	Health	Pension	Supplemental Unemployment	Total Rate
1	50	\$20.78	\$8.25	\$0.00	\$0.00	\$29.03
2	55	\$22.86	\$8.25	\$6.16	\$0.00	\$37.27
3	60	\$24.94	\$8.25	\$6.72	\$0.00	\$39.91
4	65	\$27.01	\$8.25	\$7.28	\$0.00	\$42.54
5	70	\$29.09	\$8.25	\$19.39	\$0.00	\$56.73
6	75	\$31.17	\$8.25	\$19.95	\$0.00	\$59.37
7	80	\$33.25	\$8.25	\$20.51	\$0.00	\$62.01
8	90	\$37.40	\$8.25	\$21.63	\$0.00	\$67.28

**Notes:**

Steps are 750 hrs.

**Apprentice to Journeyworker Ratio:1:1**

PAINTER / TAPER (BRUSH, REPAINT)	01/01/2021	\$39.62	\$8.25	\$22.75	\$0.00	\$70.62
----------------------------------	------------	---------	--------	---------	--------	---------

PAINTERS LOCAL 35 - ZONE 2

**Classification**

**Effective Date    Base Wage    Health    Pension    Supplemental Unemployment    Total Rate**

**Apprentice - PAINTER Local 35 Zone 2 - BRUSH REPAINT**

**Effective Date - 01/01/2021**

Step	percent	Apprentice Base Wage	Health	Pension	Supplemental Unemployment	Total Rate
1	50	\$19.81	\$8.25	\$0.00	\$0.00	\$28.06
2	55	\$21.79	\$8.25	\$6.16	\$0.00	\$36.20
3	60	\$23.77	\$8.25	\$6.72	\$0.00	\$38.74
4	65	\$25.75	\$8.25	\$7.28	\$0.00	\$41.28
5	70	\$27.73	\$8.25	\$19.39	\$0.00	\$55.37
6	75	\$29.72	\$8.25	\$19.95	\$0.00	\$57.92
7	80	\$31.70	\$8.25	\$20.51	\$0.00	\$60.46
8	90	\$35.66	\$8.25	\$21.63	\$0.00	\$65.54

**Notes:**

Steps are 750 hrs.

**Apprentice to Journeyworker Ratio:1:1**

PAINTER TRAFFIC MARKINGS (HEAVY/HIGHWAY)	06/01/2021	\$35.00	\$8.60	\$16.64	\$0.00	\$60.24
LABORERS - ZONE 2 (HEAVY & HIGHWAY)	12/01/2021	\$35.91	\$8.60	\$16.64	\$0.00	\$61.15

For apprentice rates see "Apprentice- LABORER (Heavy and Highway)

PANEL & PICKUP TRUCKS DRIVER	08/01/2021	\$35.78	\$13.41	\$14.82	\$0.00	\$64.01
TEAMSTERS JOINT COUNCIL NO. 10 ZONE B	12/01/2021	\$35.78	\$13.41	\$16.01	\$0.00	\$65.20

PIER AND DOCK CONSTRUCTOR (UNDERPINNING AND DECK)	08/01/2020	\$49.07	\$9.40	\$23.12	\$0.00	\$81.59
---	------------	---------	--------	---------	--------	---------

PILE DRIVER LOCAL 56 (ZONE 1)

For apprentice rates see "Apprentice- PILE DRIVER"

PILE DRIVER	08/01/2020	\$49.07	\$9.40	\$23.12	\$0.00	\$81.59
PILE DRIVER LOCAL 56 (ZONE 1)						

**Apprentice - PILE DRIVER - Local 56 Zone 1**

**Effective Date - 08/01/2020**

Step	percent	Apprentice Base Wage	Health	Pension	Supplemental Unemployment	Total Rate
1	50	\$24.54	\$9.40	\$23.12	\$0.00	\$57.06
2	60	\$29.44	\$9.40	\$23.12	\$0.00	\$61.96
3	70	\$34.35	\$9.40	\$23.12	\$0.00	\$66.87
4	75	\$36.80	\$9.40	\$23.12	\$0.00	\$69.32
5	80	\$39.26	\$9.40	\$23.12	\$0.00	\$71.78
6	80	\$39.26	\$9.40	\$23.12	\$0.00	\$71.78
7	90	\$44.16	\$9.40	\$23.12	\$0.00	\$76.68
8	90	\$44.16	\$9.40	\$23.12	\$0.00	\$76.68

**Notes:**

% Indentured After 10/1/17; 45/45/55/55/70/70/80/80  
 Step 1&2 \$34.01/ 3&4 \$41.46/ 5&6 \$62.80/ 7&8 \$69.25

**Apprentice to Journeyworker Ratio:1:5**



Classification	Effective Date	Base Wage	Health	Pension	Supplemental Unemployment	Total Rate
PIPELAYER <i>LABORERS - ZONE 2</i>	06/01/2021	\$35.25	\$8.60	\$16.64	\$0.00	\$60.49
	12/01/2021	\$36.16	\$8.60	\$16.64	\$0.00	\$61.40
	06/01/2022	\$37.06	\$8.60	\$16.64	\$0.00	\$62.30
	12/01/2022	\$37.91	\$8.60	\$16.64	\$0.00	\$63.15
	06/01/2023	\$38.81	\$8.60	\$16.64	\$0.00	\$64.05
	12/01/2023	\$39.71	\$8.60	\$16.64	\$0.00	\$64.95
For apprentice rates see "Apprentice- LABORER"						
PIPELAYER (HEAVY & HIGHWAY) <i>LABORERS - ZONE 2 (HEAVY &amp; HIGHWAY)</i>	06/01/2021	\$35.25	\$8.60	\$16.64	\$0.00	\$60.49
	12/01/2021	\$36.16	\$8.60	\$16.64	\$0.00	\$61.40
For apprentice rates see "Apprentice- LABORER (Heavy and Highway)"						
PLUMBER & PIPEFITTER <i>PLUMBERS &amp; PIPEFITTERS LOCAL 51</i>	08/30/2021	\$46.49	\$10.15	\$19.95	\$0.00	\$76.59

**Apprentice - PLUMBER/PIPEFITTER - Local 51**

**Effective Date - 08/30/2021**

Step	percent	Apprentice Base Wage	Health	Pension	Supplemental Unemployment	Total Rate
1	40	\$18.60	\$10.15	\$2.50	\$0.00	\$31.25
2	50	\$23.25	\$10.15	\$2.50	\$0.00	\$35.90
3	60	\$27.89	\$10.15	\$8.80	\$0.00	\$46.84
4	70	\$32.54	\$10.15	\$14.08	\$0.00	\$56.77
5	80	\$37.19	\$10.15	\$17.60	\$0.00	\$64.94

**Notes:**

Steps 2000hrs. Prior 9/1/05; 40/40/45/50/55/60/65/75/80/85

**Apprentice to Journeyworker Ratio:1:3**

PNEUMATIC CONTROLS (TEMP.) <i>PLUMBERS &amp; PIPEFITTERS LOCAL 51</i>	08/30/2021	\$46.49	\$10.15	\$19.95	\$0.00	\$76.59
For apprentice rates see "Apprentice- PIPEFITTER" or "PLUMBER/PIPEFITTER"						
PNEUMATIC DRILL/TOOL OPERATOR <i>LABORERS - ZONE 2</i>	06/01/2021	\$35.25	\$8.60	\$16.64	\$0.00	\$60.49
	12/01/2021	\$36.16	\$8.60	\$16.64	\$0.00	\$61.40
	06/01/2022	\$37.06	\$8.60	\$16.64	\$0.00	\$62.30
	12/01/2022	\$37.91	\$8.60	\$16.64	\$0.00	\$63.15
	06/01/2023	\$38.81	\$8.60	\$16.64	\$0.00	\$64.05
	12/01/2023	\$39.71	\$8.60	\$16.64	\$0.00	\$64.95
For apprentice rates see "Apprentice- LABORER"						
PNEUMATIC DRILL/TOOL OPERATOR (HEAVY & HIGHWAY) <i>LABORERS - ZONE 2 (HEAVY &amp; HIGHWAY)</i>	06/01/2021	\$35.25	\$8.60	\$16.64	\$0.00	\$60.49
	12/01/2021	\$36.16	\$8.60	\$16.64	\$0.00	\$61.40
For apprentice rates see "Apprentice- LABORER (Heavy and Highway)"						
POWDERMAN & BLASTER <i>LABORERS - ZONE 2</i>	06/01/2021	\$36.00	\$8.60	\$16.64	\$0.00	\$61.24
	12/01/2021	\$36.91	\$8.60	\$16.64	\$0.00	\$62.15
	06/01/2022	\$37.81	\$8.60	\$16.64	\$0.00	\$63.05
	12/01/2022	\$38.66	\$8.60	\$16.64	\$0.00	\$63.90
	06/01/2023	\$39.56	\$8.60	\$16.64	\$0.00	\$64.80
	12/01/2023	\$40.46	\$8.60	\$16.64	\$0.00	\$65.70
For apprentice rates see "Apprentice- LABORER"						

Classification	Effective Date	Base Wage	Health	Pension	Supplemental Unemployment	Total Rate
POWDERMAN & BLASTER (HEAVY & HIGHWAY) <i>LABORERS - ZONE 2 (HEAVY &amp; HIGHWAY)</i>	06/01/2021	\$36.00	\$8.60	\$16.64	\$0.00	\$61.24
	12/01/2021	\$36.91	\$8.60	\$16.64	\$0.00	\$62.15
For apprentice rates see "Apprentice- LABORER (Heavy and Highway)						
POWER SHOVEL/DERRICK/TRENCHING MACHINE <i>OPERATING ENGINEERS LOCAL 4</i>	06/01/2021	\$50.73	\$13.75	\$15.80	\$0.00	\$80.28
	12/01/2021	\$51.88	\$13.75	\$15.80	\$0.00	\$81.43
For apprentice rates see "Apprentice- OPERATING ENGINEERS"						
PUMP OPERATOR (CONCRETE) <i>OPERATING ENGINEERS LOCAL 4</i>	06/01/2021	\$50.73	\$13.75	\$15.80	\$0.00	\$80.28
	12/01/2021	\$51.88	\$13.75	\$15.80	\$0.00	\$81.43
For apprentice rates see "Apprentice- OPERATING ENGINEERS"						
PUMP OPERATOR (DEWATERING, OTHER) <i>OPERATING ENGINEERS LOCAL 4</i>	06/01/2021	\$33.40	\$13.75	\$15.80	\$0.00	\$62.95
	12/01/2021	\$34.19	\$13.75	\$15.80	\$0.00	\$63.74
For apprentice rates see "Apprentice- OPERATING ENGINEERS"						
READY-MIX CONCRETE DRIVER <i>TEAMSTERS 170 - Dauphinis (Bellingham)</i>	01/01/2021	\$25.00	\$9.31	\$3.20	\$0.00	\$37.51
	12/01/2021	\$25.75	\$9.76	\$4.00	\$0.00	\$39.51
	01/01/2022	\$25.75	\$9.76	\$4.00	\$0.00	\$39.51
	12/01/2022	\$26.40	\$10.26	\$4.75	\$0.00	\$41.41
	01/01/2023	\$26.40	\$10.26	\$4.75	\$0.00	\$41.41
	12/01/2023	\$27.00	\$10.76	\$5.45	\$0.00	\$43.21
	01/01/2024	\$27.00	\$10.76	\$5.45	\$0.00	\$43.21
	12/01/2024	\$27.60	\$11.26	\$6.15	\$0.00	\$45.01
RECLAIMERS <i>OPERATING ENGINEERS LOCAL 4</i>	06/01/2021	\$50.19	\$13.75	\$15.80	\$0.00	\$79.74
	12/01/2021	\$51.33	\$13.75	\$15.80	\$0.00	\$80.88
For apprentice rates see "Apprentice- OPERATING ENGINEERS"						
RIDE-ON MOTORIZED BUGGY OPERATOR <i>LABORERS - ZONE 2</i>	06/01/2021	\$35.25	\$8.60	\$16.64	\$0.00	\$60.49
	12/01/2021	\$36.16	\$8.60	\$16.64	\$0.00	\$61.40
	06/01/2022	\$37.06	\$8.60	\$16.64	\$0.00	\$62.30
	12/01/2022	\$37.91	\$8.60	\$16.64	\$0.00	\$63.15
	06/01/2023	\$38.81	\$8.60	\$16.64	\$0.00	\$64.05
	12/01/2023	\$39.71	\$8.60	\$16.64	\$0.00	\$64.95
For apprentice rates see "Apprentice- LABORER"						
ROLLER/SPREADER/MULCHING MACHINE <i>OPERATING ENGINEERS LOCAL 4</i>	06/01/2021	\$50.19	\$13.75	\$15.80	\$0.00	\$79.74
	12/01/2021	\$51.33	\$13.75	\$15.80	\$0.00	\$80.88
For apprentice rates see "Apprentice- OPERATING ENGINEERS"						
ROOFER (Inc.Roofing Waterproofing &Roofing Damproofg) <i>ROOFERS LOCAL 33</i>	08/01/2021	\$47.03	\$12.28	\$18.15	\$0.00	\$77.46
	02/01/2022	\$48.46	\$12.28	\$18.15	\$0.00	\$78.89

**Classification**

**Effective Date    Base Wage    Health    Pension    Supplemental Unemployment    Total Rate**

**Apprentice - ROOFER - Local 33**

**Effective Date - 08/01/2021**

Step	percent	Apprentice Base Wage	Health	Pension	Supplemental Unemployment	Total Rate
1	50	\$23.52	\$12.28	\$4.56	\$0.00	\$40.36
2	60	\$28.22	\$12.28	\$18.15	\$0.00	\$58.65
3	65	\$30.57	\$12.28	\$18.15	\$0.00	\$61.00
4	75	\$35.27	\$12.28	\$18.15	\$0.00	\$65.70
5	85	\$39.98	\$12.28	\$18.15	\$0.00	\$70.41

**Effective Date - 02/01/2022**

Step	percent	Apprentice Base Wage	Health	Pension	Supplemental Unemployment	Total Rate
1	50	\$24.23	\$12.28	\$4.56	\$0.00	\$41.07
2	60	\$29.08	\$12.28	\$18.15	\$0.00	\$59.51
3	65	\$31.50	\$12.28	\$18.15	\$0.00	\$61.93
4	75	\$36.35	\$12.28	\$18.15	\$0.00	\$66.78
5	85	\$41.19	\$12.28	\$18.15	\$0.00	\$71.62

**Notes:** \*\* 1:5, 2:6-10, the 1:10; Reroofing: 1:4, then 1:1  
 Step 1 is 2000 hrs.; Steps 2-5 are 1000 hrs.  
 (Hot Pitch Mechanics' receive \$1.00 hr. above ROOFER)

**Apprentice to Journeyworker Ratio:\*\***

ROOFER SLATE / TILE / PRECAST CONCRETE ROOFERS LOCAL 33	08/01/2021	\$47.28	\$12.28	\$18.15	\$0.00	\$77.71
	02/01/2022	\$48.71	\$12.28	\$18.15	\$0.00	\$79.14
For apprentice rates see "Apprentice- ROOFER"						
SHEETMETAL WORKER SHEETMETAL WORKERS LOCAL 17 - A	08/01/2021	\$51.95	\$13.80	\$25.60	\$2.74	\$94.09
	02/01/2022	\$53.70	\$13.80	\$25.60	\$2.79	\$95.89

**Classification**

**Effective Date    Base Wage    Health    Pension    Supplemental Unemployment    Total Rate**

**Apprentice - SHEET METAL WORKER - Local 17-A**

**Effective Date - 08/01/2021**

Step	percent	Apprentice Base Wage	Health	Pension	Supplemental Unemployment	Total Rate
1	42	\$21.82	\$13.80	\$6.01	\$0.00	\$41.63
2	42	\$21.82	\$13.80	\$6.01	\$0.00	\$41.63
3	47	\$24.42	\$13.80	\$11.26	\$1.48	\$50.96
4	47	\$24.42	\$13.80	\$11.26	\$1.48	\$50.96
5	52	\$27.01	\$13.80	\$12.23	\$1.59	\$54.63
6	52	\$27.01	\$13.80	\$12.48	\$1.60	\$54.89
7	60	\$31.17	\$13.80	\$13.87	\$1.77	\$60.61
8	65	\$33.77	\$13.80	\$14.84	\$1.87	\$64.28
9	75	\$38.96	\$13.80	\$16.77	\$2.09	\$71.62
10	85	\$44.16	\$13.80	\$18.20	\$2.28	\$78.44

**Effective Date - 02/01/2022**

Step	percent	Apprentice Base Wage	Health	Pension	Supplemental Unemployment	Total Rate
1	42	\$22.55	\$13.80	\$6.01	\$0.00	\$42.36
2	42	\$22.55	\$13.80	\$6.01	\$0.00	\$42.36
3	47	\$25.24	\$13.80	\$11.26	\$1.51	\$51.81
4	47	\$25.24	\$13.80	\$11.26	\$1.51	\$51.81
5	52	\$27.92	\$13.80	\$12.23	\$1.62	\$55.57
6	52	\$27.92	\$13.80	\$12.48	\$1.63	\$55.83
7	60	\$32.22	\$13.80	\$13.87	\$1.80	\$61.69
8	65	\$34.91	\$13.80	\$14.84	\$1.91	\$65.46
9	75	\$40.28	\$13.80	\$16.77	\$2.13	\$72.98
10	85	\$45.65	\$13.80	\$18.20	\$2.33	\$79.98

**Notes:**

Steps are 6 mos.

**Apprentice to Journeyworker Ratio:1:4**

SPECIALIZED EARTH MOVING EQUIP < 35 TONS <i>TEAMSTERS JOINT COUNCIL NO. 10 ZONE B</i>	08/01/2021	\$36.24	\$13.41	\$14.82	\$0.00	\$64.47
	12/01/2021	\$36.24	\$13.41	\$16.01	\$0.00	\$65.66
SPECIALIZED EARTH MOVING EQUIP > 35 TONS <i>TEAMSTERS JOINT COUNCIL NO. 10 ZONE B</i>	08/01/2021	\$36.53	\$13.41	\$14.82	\$0.00	\$64.76
	12/01/2021	\$36.53	\$13.41	\$16.01	\$0.00	\$65.95
SPRINKLER FITTER <i>SPRINKLER FITTERS LOCAL 550 - (Section A) Zone 1</i>	03/01/2021	\$62.45	\$10.00	\$21.25	\$0.00	\$93.70

**Classification**

**Effective Date    Base Wage    Health    Pension    Supplemental Unemployment    Total Rate**

**Apprentice - SPRINKLER FITTER - Local 550 (Section A) Zone 1**

**Effective Date - 03/01/2021**

Step	percent	Apprentice Base Wage	Health	Pension	Supplemental Unemployment	Total Rate
1	35	\$21.86	\$10.00	\$11.99	\$0.00	\$43.85
2	40	\$24.98	\$10.00	\$12.70	\$0.00	\$47.68
3	45	\$28.10	\$10.00	\$13.41	\$0.00	\$51.51
4	50	\$31.23	\$10.00	\$14.13	\$0.00	\$55.36
5	55	\$34.35	\$10.00	\$14.84	\$0.00	\$59.19
6	60	\$37.47	\$10.00	\$15.55	\$0.00	\$63.02
7	65	\$40.59	\$10.00	\$16.26	\$0.00	\$66.85
8	70	\$43.72	\$10.00	\$16.98	\$0.00	\$70.70
9	75	\$46.84	\$10.00	\$17.69	\$0.00	\$74.53
10	80	\$49.96	\$10.00	\$18.40	\$0.00	\$78.36

**Notes:** Apprentice entered prior 9/30/10:  
40/45/50/55/60/65/70/75/80/85  
Steps are 850 hours

**Apprentice to Journeyworker Ratio:1:3**

STEAM BOILER OPERATOR <i>OPERATING ENGINEERS LOCAL 4</i>	06/01/2021	\$50.19	\$13.75	\$15.80	\$0.00	\$79.74
	12/01/2021	\$51.33	\$13.75	\$15.80	\$0.00	\$80.88
For apprentice rates see "Apprentice- OPERATING ENGINEERS"						
TAMPERS, SELF-PROPELLED OR TRACTOR DRAWN <i>OPERATING ENGINEERS LOCAL 4</i>	06/01/2021	\$50.19	\$13.75	\$15.80	\$0.00	\$79.74
	12/01/2021	\$51.33	\$13.75	\$15.80	\$0.00	\$80.88
For apprentice rates see "Apprentice- OPERATING ENGINEERS"						
TELECOMMUNICATION TECHNICIAN <i>ELECTRICIANS LOCAL 223</i>	09/01/2020	\$36.86	\$10.90	\$12.45	\$0.00	\$60.21

**Apprentice - TELECOMMUNICATION TECHNICIAN - Local 223**

**Effective Date - 09/01/2020**

Step	percent	Apprentice Base Wage	Health	Pension	Supplemental Unemployment	Total Rate
1	0	\$0.00	\$0.00	\$0.00	\$0.00	\$0.00

**Notes:** See Electrician Apprentice Wages  
  
Telecom Apprentice Wages shall be the same as the Electrician Apprentice Wages

**Apprentice to Journeyworker Ratio:2:3\*\*\***

TERRAZZO FINISHERS <i>BRICKLAYERS LOCAL 3 - MARBLE &amp; TILE</i>	08/01/2021	\$56.09	\$11.39	\$22.25	\$0.00	\$89.73
	02/01/2022	\$56.68	\$11.39	\$22.25	\$0.00	\$90.32

**Apprentice - TERRAZZO FINISHER - Local 3 Marble & Tile**

**Effective Date - 08/01/2021**

Step	percent	Apprentice Base Wage	Health	Pension	Supplemental Unemployment	Total Rate
1	50	\$28.05	\$11.39	\$22.25	\$0.00	\$61.69
2	60	\$33.65	\$11.39	\$22.25	\$0.00	\$67.29
3	70	\$39.26	\$11.39	\$22.25	\$0.00	\$72.90
4	80	\$44.87	\$11.39	\$22.25	\$0.00	\$78.51
5	90	\$50.48	\$11.39	\$22.25	\$0.00	\$84.12

**Effective Date - 02/01/2022**

Step	percent	Apprentice Base Wage	Health	Pension	Supplemental Unemployment	Total Rate
1	50	\$28.34	\$11.39	\$22.25	\$0.00	\$61.98
2	60	\$34.01	\$11.39	\$22.25	\$0.00	\$67.65
3	70	\$39.68	\$11.39	\$22.25	\$0.00	\$73.32
4	80	\$45.34	\$11.39	\$22.25	\$0.00	\$78.98
5	90	\$51.01	\$11.39	\$22.25	\$0.00	\$84.65

**Notes:**

**Apprentice to Journeyworker Ratio:1:3**

TEST BORING DRILLER <i>LABORERS - FOUNDATION AND MARINE</i>	06/01/2021	\$42.07	\$8.60	\$17.72	\$0.00	\$68.39
	12/01/2021	\$43.08	\$8.60	\$17.72	\$0.00	\$69.40

For apprentice rates see "Apprentice- LABORER"

TEST BORING DRILLER HELPER <i>LABORERS - FOUNDATION AND MARINE</i>	06/01/2021	\$40.79	\$8.60	\$17.72	\$0.00	\$67.11
	12/01/2021	\$41.80	\$8.60	\$17.72	\$0.00	\$68.12

For apprentice rates see "Apprentice- LABORER"

TEST BORING LABORER <i>LABORERS - FOUNDATION AND MARINE</i>	06/01/2021	\$40.67	\$8.60	\$17.72	\$0.00	\$66.99
	12/01/2021	\$41.68	\$8.60	\$17.72	\$0.00	\$68.00

For apprentice rates see "Apprentice- LABORER"

TRACTORS/PORTABLE STEAM GENERATORS <i>OPERATING ENGINEERS LOCAL 4</i>	06/01/2021	\$50.19	\$13.75	\$15.80	\$0.00	\$79.74
	12/01/2021	\$51.33	\$13.75	\$15.80	\$0.00	\$80.88

For apprentice rates see "Apprentice- OPERATING ENGINEERS"

TRAILERS FOR EARTH MOVING EQUIPMENT <i>TEAMSTERS JOINT COUNCIL NO. 10 ZONE B</i>	08/01/2021	\$36.82	\$13.41	\$14.82	\$0.00	\$65.05
	12/01/2021	\$36.82	\$13.41	\$16.01	\$0.00	\$66.24

TUNNEL WORK - COMPRESSED AIR <i>LABORERS (COMPRESSED AIR)</i>	06/01/2021	\$52.90	\$8.60	\$18.17	\$0.00	\$79.67
	12/01/2021	\$53.91	\$8.60	\$18.17	\$0.00	\$80.68

For apprentice rates see "Apprentice- LABORER"

TUNNEL WORK - COMPRESSED AIR (HAZ. WASTE) <i>LABORERS (COMPRESSED AIR)</i>	06/01/2021	\$54.90	\$8.60	\$18.17	\$0.00	\$81.67
	12/01/2021	\$55.91	\$8.60	\$18.17	\$0.00	\$82.68

For apprentice rates see "Apprentice- LABORER"

TUNNEL WORK - FREE AIR <i>LABORERS (FREE AIR TUNNEL)</i>	06/01/2021	\$44.97	\$8.60	\$18.17	\$0.00	\$71.74
	12/01/2021	\$45.98	\$8.60	\$18.17	\$0.00	\$72.75

For apprentice rates see "Apprentice- LABORER"

TUNNEL WORK - FREE AIR (HAZ. WASTE) <i>LABORERS (FREE AIR TUNNEL)</i>	06/01/2021	\$46.97	\$8.60	\$18.17	\$0.00	\$73.74
	12/01/2021	\$47.98	\$8.60	\$18.17	\$0.00	\$74.75

Classification	Effective Date	Base Wage	Health	Pension	Supplemental Unemployment	Total Rate
For apprentice rates see "Apprentice- LABORER"						
VAC-HAUL <i>TEAMSTERS JOINT COUNCIL NO. 10 ZONE B</i>	08/01/2021	\$36.24	\$13.41	\$14.82	\$0.00	\$64.47
	12/01/2021	\$36.24	\$13.41	\$16.01	\$0.00	\$65.66
WAGON DRILL OPERATOR <i>LABORERS - ZONE 2</i>	06/01/2021	\$35.25	\$8.60	\$16.64	\$0.00	\$60.49
	12/01/2021	\$36.16	\$8.60	\$16.64	\$0.00	\$61.40
	06/01/2022	\$37.06	\$8.60	\$16.64	\$0.00	\$62.30
	12/01/2022	\$37.91	\$8.60	\$16.64	\$0.00	\$63.15
	06/01/2023	\$38.81	\$8.60	\$16.64	\$0.00	\$64.05
	12/01/2023	\$39.71	\$8.60	\$16.64	\$0.00	\$64.95
For apprentice rates see "Apprentice- LABORER"						
WAGON DRILL OPERATOR (HEAVY & HIGHWAY) <i>LABORERS - ZONE 2 (HEAVY &amp; HIGHWAY)</i>	06/01/2021	\$35.25	\$8.60	\$16.64	\$0.00	\$60.49
	12/01/2021	\$36.16	\$8.60	\$16.64	\$0.00	\$61.40
For apprentice rates see "Apprentice- LABORER (Heavy and Highway)"						
WASTE WATER PUMP OPERATOR <i>OPERATING ENGINEERS LOCAL 4</i>	06/01/2021	\$50.73	\$13.75	\$15.80	\$0.00	\$80.28
	12/01/2021	\$51.88	\$13.75	\$15.80	\$0.00	\$81.43
For apprentice rates see "Apprentice- OPERATING ENGINEERS"						
WATER METER INSTALLER <i>PLUMBERS &amp; PIPEFITTERS LOCAL 51</i>	08/30/2021	\$46.49	\$10.15	\$19.95	\$0.00	\$76.59
For apprentice rates see "Apprentice- PLUMBER/PIPEFITTER" or "PLUMBER/GASFITTER"						
<b>Outside Electrical - East</b>						
CABLE TECHNICIAN (Power Zone) <i>OUTSIDE ELECTRICAL WORKERS - EAST LOCAL 104</i>	08/30/2020	\$29.67	\$9.25	\$1.89	\$0.00	\$40.81
For apprentice rates see "Apprentice- LINEMAN"						
CABLEMAN (Underground Ducts & Cables) <i>OUTSIDE ELECTRICAL WORKERS - EAST LOCAL 104</i>	08/30/2020	\$42.03	\$9.25	\$10.27	\$0.00	\$61.55
For apprentice rates see "Apprentice- LINEMAN"						
DRIVER / GROUNDMAN CDL <i>OUTSIDE ELECTRICAL WORKERS - EAST LOCAL 104</i>	08/30/2020	\$34.62	\$9.25	\$10.07	\$0.00	\$53.94
For apprentice rates see "Apprentice- LINEMAN"						
DRIVER / GROUNDMAN -Inexperienced (<2000 Hrs) <i>OUTSIDE ELECTRICAL WORKERS - EAST LOCAL 104</i>	08/30/2020	\$27.20	\$9.25	\$1.82	\$0.00	\$38.27
For apprentice rates see "Apprentice- LINEMAN"						
EQUIPMENT OPERATOR (Class A CDL) <i>OUTSIDE ELECTRICAL WORKERS - EAST LOCAL 104</i>	08/30/2020	\$42.03	\$9.25	\$14.35	\$0.00	\$65.63
For apprentice rates see "Apprentice- LINEMAN"						
EQUIPMENT OPERATOR (Class B CDL) <i>OUTSIDE ELECTRICAL WORKERS - EAST LOCAL 104</i>	08/30/2020	\$37.09	\$9.25	\$10.87	\$0.00	\$57.21
For apprentice rates see "Apprentice- LINEMAN"						
GROUNDMAN <i>OUTSIDE ELECTRICAL WORKERS - EAST LOCAL 104</i>	08/30/2020	\$27.20	\$9.25	\$1.82	\$0.00	\$38.27
For apprentice rates see "Apprentice- LINEMAN"						
GROUNDMAN -Inexperienced (<2000 Hrs.) <i>OUTSIDE ELECTRICAL WORKERS - EAST LOCAL 104</i>	08/30/2020	\$22.25	\$9.25	\$1.82	\$0.00	\$33.32
For apprentice rates see "Apprentice- LINEMAN"						
JOURNEYMAN LINEMAN <i>OUTSIDE ELECTRICAL WORKERS - EAST LOCAL 104</i>	08/30/2020	\$49.45	\$9.25	\$17.48	\$0.00	\$76.18

**Classification**

**Effective Date    Base Wage    Health    Pension    Supplemental Unemployment    Total Rate**

**Apprentice - LINEMAN (Outside Electrical) - East Local 104**

**Effective Date - 08/30/2020**

Step	percent	Apprentice Base Wage	Health	Pension	Supplemental Unemployment	Total Rate
1	60	\$29.67	\$9.25	\$3.39	\$0.00	\$42.31
2	65	\$32.14	\$9.25	\$3.46	\$0.00	\$44.85
3	70	\$34.62	\$9.25	\$3.54	\$0.00	\$47.41
4	75	\$37.09	\$9.25	\$5.11	\$0.00	\$51.45
5	80	\$39.56	\$9.25	\$5.19	\$0.00	\$54.00
6	85	\$42.03	\$9.25	\$5.26	\$0.00	\$56.54
7	90	\$44.51	\$9.25	\$7.34	\$0.00	\$61.10

**Notes:**

**Apprentice to Journeyworker Ratio:1:2**

TELEDATA CABLE SPLICER <i>OUTSIDE ELECTRICAL WORKERS - EAST LOCAL 104</i>	02/04/2019	\$30.73	\$4.70	\$3.17	\$0.00	\$38.60
TELEDATA LINEMAN/EQUIPMENT OPERATOR <i>OUTSIDE ELECTRICAL WORKERS - EAST LOCAL 104</i>	02/04/2019	\$28.93	\$4.70	\$3.14	\$0.00	\$36.77
TELEDATA WIREMAN/INSTALLER/TECHNICIAN <i>OUTSIDE ELECTRICAL WORKERS - EAST LOCAL 104</i>	02/04/2019	\$28.93	\$4.70	\$3.14	\$0.00	\$36.77

**Additional Apprentice Information:**

Minimum wage rates for apprentices employed on public works projects are listed above as a percentage of the pre-determined hourly wage rate established by the Commissioner under the provisions of the M.G.L. c. 149, ss. 26-27D. Apprentice ratios are established by the Division of Apprenticeship Training pursuant to M.G.L. c. 23, ss. 11E-11L.

All apprentices must be registered with the Division of Apprenticeship Training in accordance with M.G.L. c. 23, ss. 11E-11L.

All steps are six months (1000 hours.)

Ratios are expressed in allowable number of apprentices to journeymen or fraction thereof, unless otherwise specified.

- \*\* Multiple ratios are listed in the comment field.
- \*\*\* APP to JM; 1:1, 2:2, 2:3, 3:4, 4:4, 4:5, 4:6, 5:7, 6:7, 6:8, 6:9, 7:10, 8:10, 8:11, 8:12, 9:13, 10:13, 10:14, etc.
- \*\*\*\* APP to JM; 1:1, 1:2, 2:3, 2:4, 3:5, 4:6, 4:7, 5:8, 6:9, 6:10, 7:11, 8:12, 8:13, 9:14, 10:15, 10:16, etc.



"General Decision Number: MA20220001 01/07/2022

Superseded General Decision Number: MA20210001

State: Massachusetts

Construction Type: Building

Counties: Barnstable, Bristol, Dukes, Essex, Middlesex, Nantucket, Norfolk and Suffolk Counties in Massachusetts.

BUILDING CONSTRUCTION PROJECTS (does not include single family homes and apartments up to and including 4 stories)

Note: Contracts subject to the Davis-Bacon Act are generally required to pay at least the applicable minimum wage rate required under Executive Order 14026 or Executive Order 13658. Please note that these Executive Orders apply to covered contracts entered into by the federal government that are subject to the Davis-Bacon Act itself, but do not apply to contracts subject only to the Davis-Bacon Related Acts, including those set forth at 29 CFR 5.1(a)(2)-(60).

If the contract is entered into on or after January 30, 2022, or the contract is renewed or extended (e.g., an option is exercised) on or after January 30, 2022, Executive Order 14026 generally applies to the contract. The contractor must pay all covered workers at least \$15.00 per hour (or the applicable wage rate listed on this wage determination, if it is higher) for all hours spent performing on that contract in 2022.

If the contract was awarded on or between January 1, 2015 and January 29, 2022, and the contract is not renewed or extended on or after January 30, 2022, Executive Order 13658 generally applies to the contract. The contractor must pay all covered workers at least \$11.25 per hour (or the applicable wage rate listed on this wage determination, if it is higher) for all hours spent performing on that contract in 2022.

The applicable Executive Order minimum wage rate will be adjusted annually. If this contract is covered by one of the Executive Orders and a classification considered necessary for performance of work on the contract does not appear on this wage determination, the contractor must still submit a conformance request.

Additional information on contractor requirements and worker protections under the Executive Orders is available at [www.dol.gov/whd/govcontracts](http://www.dol.gov/whd/govcontracts).

Modi fication Number      Publication Date  
0                                      01/07/2022

ASBE0006-001 09/01/2021

	Rates	Fri nges
Insulator/asbestos worker Includes the application of all insulating materials, protective coverings, coatings, and finishes to all types of mechanical systems		
(ZONE A).....	\$ 50.00	32.89
(ZONE B).....	\$ 50.00	32.89

ZONES:

ZONE A

BARNSTABLE COUNTY (Brewster, Chatham, Dennis, Eastham, Harwich, Orleans, Provincetown, Truro, Wellfleet, Yarmouth)  
BRISTOL COUNTY (Easton), MIDDLESEX COUNTY, and NORFOLK COUNTY (Avon, Braintree, Brookline, Canton, Cohasset, Dedham, Dover, Foxborough, Holbrook, Medfield, Medway, Millis, Milton, Needham, Norfolk, Norwood, Quincy, Randolph, Sharon, Stoughton, Walpole, Wellesley, Westwood, Weymouth)

ZONE B

BARNSTABLE COUNTY (Barnstable, Bourne, Falmouth, Mashpee, Sandwich), BRISTOL COUNTY (All cities except Easton), and NORFOLK COUNTY (Bellingham, Franklin, Plainville)

---

ASBE0006-002 09/01/2021

BARNSTABLE (Brewster, Chatham, Dennis, Eastham, Harwich, Orleans, Provincetown, Truro, Wellfleet and Yarmouth); BRISTOL (Easton); ESSEX; MIDDLESEX; NORFOLK (Avon, Braintree, Brookline, Canton, Cohasset, Dedham, Dover, Foxboro, Holbrook, Hull, Medfield, Medway, Millis, Milton, Needham, Norfolk, Norwood, Quincy, Randolph, Sharon Stoughton, Walpole, Wellesley, Westwood, and Weymouth) AND SUFFOLK COUNTIES

	Rates	Fri nges
HAZARDOUS MATERIAL HANDLER (Includes preparati on,		

wetting, stripping, removal, scrapping, vacuuming, bagging and disposing of all insulation materials from mechanical systems whether they contain asbestos or not).... \$ 40.00 33.04

-----  
 ASBE0006-010 09/01/2021

BARNSTABLE (Barnstable, Bourne, Falmouth, Mashpee and Sandwich); BRISTOL (Acushnet, Attleboro city, Berkeley, Dartmouth, Dighton, Fairhaven, Fall river City, Freetown, Marion, Mansfield, New Bedford City, North Attleboro, Norton, Raynham, Rehoboth, Seekonk, Somerset, Swansea, Taunton City and Westport); DUKES; NANTUCKET; NORFOLK (Bellingham, Franklin, Plainville, and Wrentham); PLYMOUTH (Lakeville, Mattapoisett, Middl eboro, Rochester and Wareham)

Rates Fringes

Insulator/asbestos worker (Includes the application of all insulating materials, protective coverings, coatings and finishes to all types of mechanical systems.).... \$ 50.00 32.89

-----  
 BOIL0029-001 01/01/2021

Rates Fringes

BOILERMAKER..... \$ 45.87 29.02

-----  
 BRMA0001-008 02/01/2021

FOXBORO CHAPTER  
 BRISTOL (Attleboro, Berkley, Dighton, Mansfield, North Attleboro, Norton, Raynham, Rehoboth, Seekonk, Taunton) AND NORFOLK (Bellingham, Canton, Dedham, Foxboro, Franklin, Norfolk, Norwood, Plainville, Sharon, Walpole, Westrwood, Wrentham) COUNTIES

Rates Fringes

Bricklayer, Cement Mason, Plasterer..... \$ 53.61 35.94

-----  
 BRMA0001-009 02/01/2021

LOWELL CHAPTER

MIDDLESEX (Acton, Asby, Ayer, Bedford, Billerica, Boxboro, Carlisle, Chemsford, Dracut, Dunstable, Ft. Denvens, Groton, Littleton, Lowell, North Acton, Pepperell, Shirley, South Acton, Tewksbury, Townsend, Tyngsboro, West Acton, Westford, Wilmingon)

	Rates	Fringes
Bricklayer and plasterer.....	\$ 53.61	35.94

-----  
BRMA0001-010 08/01/2020

LOWELL CHAPTER

MIDDLESEX (Ashland, Framingham, Holliston, Hopkinton, Hudson, Maynard, Natick, Sherborn, Stow); and NORFOLK (Medfield, Medway, Millis)

	Rates	Fringes
BRICKLAYER.....	\$ 53.16	34.95

-----  
BRMA0003-001 02/01/2021

	Rates	Fringes
Marble & Tile Finisher.....	\$ 42.57	32.00
Marble, Tile & Terrazzo Workers.....	\$ 54.69	33.80
TERRAZZO FINISHER.....	\$ 55.77	34.47

-----  
BRMA0003-003 02/01/2021

BOSTON CHAPTER

MIDDLESEX (Arlington, Cambridge, Everett, Malden, Medford, Melrose, Somerville); NORFOLK (Brookline, Milton); and SUFFOLK

	Rates	Fringes
BRICKLAYER.....	\$ 55.75	35.85

-----  
BRMA0003-006 08/01/2021

LYNN CHAPTER

ESSEX (Amesbury, Andover, Beverly, Boxford, Danvers, Essex, Georgetown, Gloucester, Groveland, Hamilton, Haverhill, Ipswich, Lawrence, Lynn, Lynnfield, Manchester, Marblehead, Merrimac, Methuen, Middleton, Nahant, Newbury, Newburyport,

North Andover, Peabody, Rockport, Rowley, Salisbury, Salem, Saugus, Swampscott, Topsfield Wakefield, Wenham, West Newbury); and MIDDLESEX (Reading, North Reading, Wakefield)

	Rates	Fringes
Bricklayer, cement mason and plasterer.....	\$ 57.17	35.98

-----  
BRMA0003-007 08/01/2021

WALTHAM CHAPTER

MIDDLESEX (Belmont, Burlington, Concord, Lexington, Lincoln, Stoneham, Sudbury, Waltham, Watertown, Wayland, Weston, Winchester, Woburn)

	Rates	Fringes
Bricklayer and plasterer.....	\$ 57.17	35.98

-----  
BRMA0003-008 08/01/2021

NEWTON CHAPTER

MIDDLESEX (Newton) and NORFOLK (Dover, Needham, Wellesley)

	Rates	Fringes
Bricklayer, cement mason and plasterer.....	\$ 57.17	35.98

-----  
BRMA0003-009 08/01/2021

NEW BEDFORD

BARNSTABLE; BRISTOL (Acushnet, Dartmouth, Fairhaven, Fall River, Freetown, New Bedford, Somerset, Swansea, Westport); DUKES; and NANTUCKET COUNTIES

	Rates	Fringes
Bricklayer, cement mason and plasterer.....	\$ 57.17	35.98

-----  
BRMA0003-010 08/01/2021

QUINCY CHAPTER

NORFOLK COUNTY (Avon, Braintree, Cohasset, Holbrook, Quincy, Randolph, Soughton, Weymouth)

	Rates	Fringes
Bricklayer, cement mason and plasterer.....	\$ 57.17	35.98

-----  
 CARP0056-011 08/01/2021

SUFFOLK (All of County); and those areas of BARNSTABLE, BRISTOL, ESSEX, MIDDLESEX & NORFOLK COUNTIES situated inside Boston Beltway (I-495) and North of Cape Cod Canal. ALL of DUKES AND NANTUCKET COUNTIES

	Rates	Fringes
PILED RIVERMAN.....	\$ 50.74	33.66

-----  
 CARP0056-012 08/01/2020

The areas of BARNSTABLE, BRISTOL, and NORFOLK COUNTIES situated OUTSIDE Boston Beltway (I-495) and South of Cape Cod Canal

	Rates	Fringes
PILED RIVERMAN.....	\$ 49.07	35.57

-----  
 CARP0056-013 08/01/2021

Those areas of ESSEX and MIDDLESEX COUNTIES situated OUTSIDE Boston Beltway (I-495)

	Rates	Fringes
PILED RIVERMAN.....	\$ 44.61	33.45

-----  
 CARP0327-001 03/01/2021

MIDDLESEX (Belmont, Cambridge, Everett, Malden, Medford, Somerville); NORFOLK (Brookline, Dedham, Milton); and SUFFOLK

	Rates	Fringes
CARPENTER.....	\$ 52.38	20.78

-----  
 \* CARP0339-001 09/01/2021

BRISTOL (Attleborough, North Attleborough); ESSEX; MIDDLESEX (Except Belmont, Cambridge, Everett, Malden, Medford, Somerville); AND NORFOLK (Bellingham, Canton, Foxboro, Franklin, Medfield, Medway, Millis, Needham, Norfolk, Norwood, Plainville, Sharon, Walpole, Wellesley, Westwood, Wrentham)

	Rates	Fringes
CARPENTER.....	\$ 44.18	29.27

-----  
 CARP0346-003 03/01/2020

NORFOLK COUNTY (Braintree, Cohasset, Scituate, Weymouth, Quincy)

	Rates	Fringes
CARPENTER.....	\$ 42.40	29.10

-----  
 CARP0624-005 09/01/2017

DUKES; NANTUCKET

	Rates	Fringes
CARPENTER.....	\$ 46.43	28.35

-----  
 CARP0624-007 09/01/2017

BARNSTABLE; BRISTOL (Except Attleboro & North Attleboro); AND NORFOLK (Avon, Holbrook, Randolph, Stoughton) COUNTIES

	Rates	Fringes
CARPENTER.....	\$ 39.28	27.90

-----  
 CARP1121-001 01/06/2020

SUFFOLK COUNTY

	Rates	Fringes
MILLWRIGHT.....	\$ 42.32	31.15

-----  
 CARP1121-003 01/06/2020

BARNSTABLE, BRISTOL, DUKES, ESSEX, MIDDLESEX, NANTUCKET and NORFOLK COUNTIES

	Rates	Fringes
MILLWRIGHT.....	\$ 38.47	31.15

---

\* CARP2168-001 09/01/2021

MIDDLESEX (Belmont, Cambridge, Everett, Malden, Medford, Somerville); NORFOLK (Brookline, Dedham, Milton); and SUFFOLK

	Rates	Fringes
FLOOR LAYER: Carpet.....	\$ 53.27	29.37

---

\* CARP2168-004 09/01/2021

BRISTOL; ESSEX; MIDDLESEX (Except Belmont, Cambridge, Everett, Malden, Medford, Somerville); Remainder of Norfolk County

	Rates	Fringes
FLOOR LAYER: Carpet.....	\$ 53.27	29.37

---

\* CARP2168-005 09/01/2021

BARNSTABALE; DUKES; AND NANTUCKET

	Rates	Fringes
FLOOR LAYER: Carpet.....	\$ 53.27	29.37

---

ELEC0096-001 09/06/2021

MIDDLESEX (Ashby, Ashland, Ayer, Ft. Devens, Groton, Hopkinton, Hudson, Marlboro, Pepperell, Shirley, Stow, Townsend)

	Rates	Fringes
ELECTRICIAN.....	\$ 45.01	11%+25.01
Tel edata System Installer.....	\$ 32.85	28.12

---

ELEC0099-001 06/01/2021

BRISTOL (Attleboro, North Attleboro, Seekonk)

	Rates	Fringes
--	-------	---------



ELECTRICIAN.....	\$ 43.61	54.71%
Teledata System Installer.....	\$ 31.21	13.1%+14.93

---

ELEC0103-001 09/01/2021

ESSEX; MIDDLESEX (Excluding Ashby, Ashland, Ayer, Ft. Devens, Groton, Hopkinton, Hudson, Marlboro, Pepperell, Shirley, Stow, Townsend); NORFOLK (Excluding Avon, Holbrook, Plainville, Randolph, Stoughton) SUFFOLK

	Rates	Fringes
Teledata System Installer.....	\$ 43.40	32.02

---

ELEC0103-002 09/01/2021

ESSEX (Amesbury, Andover, Boxford, Georgetown, Groveland, Haverhill, Lawrence, Merrimac, Methuen, Newbury, Newburyport, North Andover, Rowley, Salisbury, West Newbury); MIDDLESEX (Bedford, Billerica, Boxboro, Burlington, Carlisle, Chelmsford, Dracut, Dunstable Littleton, Lowell, North Reading, Tewksbury, Tyngsboro, Westford, Wilmington)

	Rates	Fringes
ELECTRICIAN.....	\$ 56.36	34.39

---

ELEC0103-004 09/01/2021

ESSEX (Beverly, Danvers, Essex, Gloucester, Hamilton, Ipswich, Manchester, Marblehead, Middleton, Peabody, Rockport, Salem, Topsfield, Wenham)

	Rates	Fringes
ELECTRICIAN.....	\$ 56.36	34.39

---

ELEC0103-005 09/01/2021

ESSEX (Lynn, Lynnfield, Nahant, Saugus, Swampscott); MIDDLESEX (Acton, Arlington, Belmont, Cambridge, Concord, Everett, Framingham, Holliston, Lexington, Lincoln, Malden, Maynard, Medford, Melrose, Natick, Newton, Reading, Sherborn, Somerville, Stoneham, Sudbury, Wakefield, Waltham, Watertown, Wayland, Weston, Winchester, Woburn); NORFOLK (Bellingham, Braintree, Brookline, Canton, Cohasset, Dedham, Dover, Foxboro, Franklin, Medfield, Medway, Millis, Milton, Needham, Norfolk, Norwood, Quincy, Sharon, Walpole, Wellesley, Westwood,

Weymouth, Wrentham); PLYMOUTH (Hingham and Hull); SUFFOLK

	Rates	Fringes
ELECTRICIAN.....	\$ 56.36	34.39

-----  
\* ELEC0104-001 09/01/2021

	Rates	Fringes
Line Construction:		
Cableman.....	\$ 51.09	27.91+A
Equipment Operator.....	\$ 43.43	24.62+A
Groundman.....	\$ 28.10	11.80+A
Lineman.....	\$ 51.09	27.91+A

A. PAID HOLIDAYS: New Year's Day; Memorial Day; Independence Day; Labor Day; Thanksgiving Day; Christmas Day and Columbus Day, provided the employee has been employed 5 working days prior to any one of the listed holidays.

-----  
ELEC0223-005 09/01/2021

BARNSTABLE; BRISTOL (Except Attleboro, North Attleboro, Seekonk); DUKES; NANTUCKET AND NORFOLK (Avon, Halbrook, Plainville, Randolph, Stoughton)

	Rates	Fringes
ELECTRICIAN.....	\$ 44.27	31.18%+14.00

-----  
ELEC0223-006 09/01/2021

BARNSTABLE; BRISTOL (Except Attleboro, North Attleboro, Seekonk); DUKES; NANTUCKET AND NORFOLK (Avon, Halbrook, Plainville, Randolph, Stoughton)

	Rates	Fringes
Teladata System Installer.....	\$ 37.63	31.09%+13.75

-----  
ELEV0004-001 01/01/2021

	Rates	Fringes
ELEVATOR MECHANIC.....	\$ 63.47	35.83

FOOTNOTE FOR ELEVATOR MECHANICS:

- a. Vacation: 6%/under 5 years based on regular hourly rate for all hours worked. 8%/over 5 years based on regular hourly rate for all hours worked.
- b. PAID HOLIDAYS: New Year's Day; Memorial Day; Independence Day; Labor Day; Veterans' Day; Thanksgiving Day; the Friday after Thanksgiving Day; and Christmas Day.

ENGI 0004-001 06/01/2020

	Rates	Fringes
Power equipment operators:		
Group 1.....	\$ 49.33	29.75
Group 2.....	\$ 48.81	29.75
Group 3.....	\$ 32.72	29.75
Group 4.....	\$ 40.30	29.75
Group 5.....	\$ 23.13	29.75
Group 6.....	\$ 27.79	29.75

FOOTNOTE FOR POWER EQUIPMENT OPERATORS:

- A. PAID HOLIDAYS: New Year's Day, Washington's Birthday, Labor Day, Memorial Day, Independence Day, Patriot's Day, Columbus Day, Veteran's Day, Thanksgiving Day, Christmas Day

HOURLY PREMIUM FOR BOOM LENGTHS (Including Jib):

- Over 150 ft. +2.18
- Over 185 ft. +3.84
- Over 210 ft. +5.39
- Over 250 ft. +8.16
- Over 295 ft. +11.29
- Over 350 ft. +13.14

POWER EQUIPMENT OPERATORS CLASSIFICATIONS

- Group 1: Crane; shovel; truck crane; cherry picker; dragline; trench hoe; backhoe; three drum machine; derrick; pile driver; elevator tower; hoist; gradall; shovel dozer; front end loader; fork lift; suger; boring machine; rotaryu drill; post hole hammer; post hole digger; pumpcrete machine; asphalt plant (on site); concrete batching and/or mixing plant (on site); crusher plant (on site); paving concrete mixer; timber jack
- Group 2: Sonic or vibratory hammer; grader; scraper; tandem scraper; concrete pump; bulldozer; tractor; york rake; mulching machine; portable steam boiler; portable steam generator; roller; spreader; tamper (self propelled or tractor drawn); asphalt paver; mechanic - maintenance; paving screed machine; stationary steam boiler; paving

concrete finishing machine; cal truck; ballast regulator;  
 switch tamper; rail anchor machine; tire truck  
 Group 3: Pumps (1-3 grouped); compressor; welding machine  
 (1-3 grouped); generator; concrete vibrator; heater (power  
 driven 1- 5); well point system (operating);  
 syphon-pul someter; concrete mixer; valves controlling  
 permanent plant air or steam; conveyor; Jackson type  
 tamper; single diaphragm pump; lighting plant  
 Group 4: Assistant engineer (fireman)  
 Group 5: Oiler (other than truck cranes and gradalls)  
 Group 6: Oiler (on truck cranes and gradalls) stant engineer  
 (on truck crane and gradall)

-----  
 IRON0007-006 09/16/2021

AREA 1: BRISTOL (Easton); ESSEX (Beverly, Gloucester,  
 Lynn, Lynnfield, Manchester, Marblehead, Nahant, Rockport,  
 Salem, Saugus, Swampscott); MIDDLESEX (Arlington, Bedford,  
 Belmont, Burlington, Cambridge, Carlisle, Concord, Dunstable,  
 Everett, Framingham, Lexington, Lincoln, Malden, Maynard,  
 Medford, Melrose, Natick, Newton, Reading, Sherborn,  
 Somerville, Stoneham, Sudbury, Wakefield, Waltham, Watertown,  
 Wayland, Weston, Winchester, Woburn); NORFOLK (Except Medway);  
 SUFFOLK

AREA 2: ESSEX (Amesbury, Andover, Boxford, Danvers, Essex,  
 Georgetown, Hamilton, Haverhill, Ipswich, Lawrence, Merrimac,  
 Methuen, Newbury, Newburyport, North Andover, Rowley,  
 Salisbury, Topsfield, Wenham, West Newbury); MIDDLESEX (Acton,  
 Billerica, Chelmsford, Dracut, Groton, Groveland, Littleton,  
 Lowell, Middleton, North Reading, Pepperell, Tewksbury,  
 Tyngsboro, Westford, Wilmingon)

	Rates	Fringes
Ironworkers:		
AREA 1.....	\$ 50.13	34.81
AREA 2.....	\$ 45.72	34.81

-----  
 IRON0007-010 09/16/2021

MIDDLESEX (Ashby, Ashland, Ayer, Boxboro, Holliston, Hopkinton,  
 Hudson, Marlboro, Shirley, Stow, Townsend); NORFOLK (Medway)

	Rates	Fringes
IRONWORKER.....	\$ 49.83	34.81

-----

IRON0037-005 03/16/2021

BARNSTABLE; BRISTOL (Acushnet, Attleboro, Berkley, Dartmouth, Dighton, Fairhaven, Fall River, Freetown, Mansfield, New Bedford, North Attleboro, Norton, Raynham, Rehoboth, Seekonk, Somerset, Swansea, Taunton, Westport); DUKES; NANTUCKET; NORFOLK (Biltingham, Franklin, Plainville, Wrentham)

	Rates	Fringes
IRONWORKER.....	\$ 37.87	30.13

---

\* LAB00022-001 12/01/2021

	Rates	Fringes
Laborers: (HEAVY CONSTRUCTION)		
GROUP 1.....	\$ 35.41	26.59
GROUP 2.....	\$ 35.66	26.59
GROUP 3.....	\$ 36.16	26.59
GROUP 4.....	\$ 36.41	26.59
GROUP 5.....	\$ 24.50	26.59
GROUP 6.....	\$ 37.41	26.59

LABORERS CLASSIFICATIONS

GROUP 1: Laborers; carpenter tenders; cement finisher tenders, plasterer tenders

GROUP 2: Asphalt raker; fence and guard rail erector; laser beam operator; mason tender; pipelayer; pneumatic drill operator; pneumatic tool operator; wagon drill operator, jack hammer operator, pavement breaker, carbide core drilling machine, chain saw operator, barco type jumping tampers, concrete pump, motorized mortar mixer, ride-on-motorized buggy

GROUP 3: Air track operator; block paver; rammer; curb setter, hydraulic and similar self powered drills

GROUP 4: Blaster; powderman

GROUP 5: Flagger

GROUP 6: Asbestos Abatement; Toxic and Hazardous Waste Laborers

---

\* LAB00022-003 12/01/2021

	Rates	Fringes
Plasterer tender BARNSTABLE, BRISTOL, DUKES, ESSEX, NANTUCKET, MIDDLESEX (with the exception of Arlington, Belmont, Burlington, Cambridge, Everett, Malden, Medford, Melrose, Reading, Somerville, Stoneham, Wakefield, Winchester, Winthrop and Woburn); NORFOLK (with the exception of Brookline Dedham and Milton) COUNTIES. \$ 35.41		26.59
SUFFOLK COUNTY (Boston, Chelsea, Revere, Winthrop, Deer Island, Nut Island); MIDDLESEX COUNTY (Arlington, Belmont, Burlington, Cambridge, Everett, Malden, Medford, Melrose, Reading, Somerville, Stoneham, Wakefield, Winchester, Winthrop and Woburn only); NORFOLK COUNTY (Brookline, Dedham, and Milton only).... \$ 41.18		27.52

\* LAB00022-004 12/01/2021

	Rates	Fringes
Plasterer tender..... \$ 35.41		26.59

\* LAB00022-005 12/01/2021

	Rates	Fringes
Plasterer tender BARNSTABLE, BRISTOL, DUKES, ESSEX, NANTUCKET, MIDDLESEX (with the exception of Arlington, Belmont, Burlington, Cambridge, Everett, Malden, Medford, Melrose, Reading, Somerville, Stoneham, Wakefield, Winchester, Winthrop and		

Woburn); NORFOLK (with the exception of Brookline Dedham and Milton) COUNTIES. \$ 35.41 26.59  
 SUFFOLK COUNTY (Boston, Chelsea, Revere, Winthrop, Deer Island, Nut Island);  
 MIDDLESEX COUNTY (Arlington, Belmont, Burlington, Cambridge, Everett, Malden, Medford, Melrose, Reading, Somerville, Stoneham, Wakefield, Winchester, Winthrop and Woburn only);  
 NORFOLK COUNTY (Brookline, Dedham, and Milton only).... \$ 41.18 27.52

-----  
 \* LAB00022-009 12/01/2021

SUFFOLK COUNTY (Boston, Chelsea, Revere, Winthrop, Deer & Nut Islands); MIDDLESEX COUNTY (Arlington, Belmont, Burlington, Cambridge, Everett, Malden, Medford, Melrose, Reading, Somerville, Stoneham, Wakefield, Winchester, Winthrop, and Woburn only); NORFOLK COUNTY (Brookline, Dedham, and Milton only)

	Rates	Fringes
Laborers:		
GROUP 1.....	\$ 41.18	27.52
GROUP 2.....	\$ 41.43	27.56
GROUP 3.....	\$ 41.93	27.56
GROUP 4.....	\$ 42.18	27.56
GROUP 5.....	\$ 41.93	27.56
GROUP 6.....	\$ 43.18	27.52
GROUP 7.....	\$ 24.50	27.52

LABORERS CLASSIFICATIONS

GROUP 1: Laborers; Carpenter Tenders

GROUP 2: Jackhammer operator; pavement breaker; asphalt raker carbide core drilling machine; chain saw operator; pipelayer; barco type jumping tampers; laser beam; concrete pump; mason tender; motorized mortar mixer; ride-on motorized buggy; fence and beam rail erector

GROUP 3: Air track, block paver; rammer; curb setter, hydraulic and similar self-powered drills

- GROUP 4: Blaster; powderman
- GROUP 5: Pre-cast floor and roof plank erector
- GROUP 6: Asbestos removal laborers/haz-mat laborers
- GROUP 7: Flaggers

-----  
 \* LAB00022-010 12/01/2021

Counties of BARNSTABLE; BRISTOL; DUKES; ESSEX; NANTUCKET; MIDDLESEX (with the exception of Arlington, Belmont, Burlington, Cambridge, Everett, Malden, Medford, Melrose, Reading, Somerville, Stoneham, Waverfield, Winchester, Winthrop and Woburn); NORFOLK (with the exception of Brookline, Dedham and Milton)

	Rates	Fringes
Laborers:		
GROUP 1.....	\$ 35.41	26.59
GROUP 2.....	\$ 35.66	26.59
GROUP 3.....	\$ 36.16	26.59
GROUP 4.....	\$ 36.41	26.59
GROUP 5.....	\$ 36.16	26.59
GROUP 6.....	\$ 37.41	26.59

LABORERS CLASSIFICATIONS

GROUP 1: Laborers; Carpenter Tenders

GROUP 2: Jackhammer operator; pavement breaker; asphalt raker carbide core drilling machine; chain saw operator; pipelayer; barco type jumping tampers; laser beam; concrete pump; mason tender; motorized mortar mixer; ride-on motorized buggy; fence and beam rail erector

GROUP 3: Air track, block paver; hammer; curb setter, hydraulic and similar self-powered drills

- GROUP 4: Blaster; powderman
- GROUP 5: Pre-cast floor and roof plank erector
- GROUP 6: Asbestos removal laborers/haz-mat laborers

-----  
 \* LAB01421-004 12/01/2021



BARNSTABLE, BRISTOL, DUKES, ESSEX, MIDDLESEX, NANTUCKET NORFOLK AND SUFFOLK COUNTIES

	Rates	Fringes
Laborers: (Wrecking)		
Group 1.....	\$ 41.33	27.37
Group 2.....	\$ 42.08	27.37
Group 3.....	\$ 42.33	27.37
Group 4.....	\$ 37.33	27.37
Group 5.....	\$ 40.43	27.37
Group 6.....	\$ 41.33	27.37

- Group 1: Adzeman, Wrecking Laborer.
- Group 2: Burners, Jackhammers.
- Group 3: Small Backhoes, Loaders on tracks, Bobcat Type Loaders, Hydraulic ""Brock"" Type Hammer Operators, Concrete Cutting Saws.
- Group 4: Yardman (Salvage Yard Only).
- Group 5: Yardman, Burners, Sawyers.
- Group 6: Asbestos, Lead Paint, Toxic and Hazardous Waste.

-----  
 \* PAI N0011-007 06/01/2021

BARNSTABLE, BRISTOL, DUKES, AND NANTUCKET COUNTIES

	Rates	Fringes
GLAZIER.....	\$ 39.98	23.75

FOOTNOTE:  
 A. PAID HOLIDAY: LABOR DAY (provided employee has worked any part of the week prior to Labor Day and any part of the week after Labor Day)

-----  
 PAI N0035-004 01/01/2019

BARNSTABLE; BRISTOL; ESSEX; NANTUCKET; DUKES; COUNTIES; REMAINDER OF NORFOLK; MIDDLESEX AND SUFFOLK COUNTIES

	Rates	Fringes
PAINTER		
NEW CONSTRUCTION:		
Brush, Taper.....	\$ 39.86	30.25
Spray, Sandblast.....	\$ 41.26	30.25
REPAINT:		

Brush, Taper.....	\$ 37.92	30.25
Spray, Sandblast.....	\$ 39.32	30.25

-----  
PAI N0035-013 01/01/2019

MIDDLESEX (Cambridge, Everett, Malden, Medford, Somerville)  
SUFFOLK COUNTY (Boston, Chelsea) NORFOLK COUNTY (Brookline)

	Rates	Fringes
PAINTER		
NEW CONSTRUCTION:		
Brush, Taper.....	\$ 45.65	30.25
Spray, Sandblast.....	\$ 47.05	30.25
REPAINT:		
Brush, Taper.....	\$ 43.71	30.25
Spray, Sandblast.....	\$ 45.11	30.25

-----  
PAI N0035-020 01/01/2019

ESSEX; MIDDLESEX; NORFOLK; SUFFOLK

	Rates	Fringes
GLAZIER.....	\$ 39.86	30.25

-----  
PLAS0534-001 01/01/2020

ESSEX; MIDDLESEX; NORFOLK AND SUFFOLK COUNTY

	Rates	Fringes
CEMENT MASON/CONCRETE FINISHER...	\$ 43.00	37.66

-----  
PLAS0534-004 01/01/2020

MIDDLESEX; NORFOLK AND SUFFOLK COUNTIES

	Rates	Fringes
PLASTERER.....	\$ 43.00	37.66

-----  
PLUM0004-001 09/01/2021

MIDDLESEX (Ashby, Ayer-West of Greenville branch of Boston and  
Maine Railroad, Ft. Devens, Groton, Shirley, Townsend)

Rates	Fringes
-------	---------

Plumbers and Pipefitters.....\$ 48.50 27.27

---

PLUM0012-005 09/02/2019

ESSEX (Ames, Andover, Beverly, Boxford, Byfield, Danvers, Essex, Georgetown, Gloucester, Groveland, Hamilton, Haverhill, Ipswich, Lawrence, Manchester, Marblehead, Merrimac, Methuen, Middleton, Newbury, Newburyport, North Andover, Peabody, Rockport, Rowley, Salem, Salisbury, Topsfield, Wenham, West Newbury)

	Rates	Fringes
PLUMBER.....	\$ 53.61	30.43

---

PLUM0012-007 09/02/2021

ESSEX (Lynn, Lynnfield, Nahant, Saugus, and Swampscott); MIDDLESEX (Acton, Arlington, Ashford, Ayer-except west of Greenville Branch of Boston & Maine Rail Road, Bedford, Belmont, Billerica, Boxboro, Burlington, Cambridge, Carlisle, Chelmsford, Concord, Dracut, Dunstable, Everett, Framingham, Hudson, Holliston, Hopkinton, Lexington, Lincoln, Littleton, Lowell, Malden, Marlboro, Maynard, Medford, Melrose, Natick, Newton, North Reading, Pepperell, Reading, Sherborn, Somerville, Stoneham, Stow, Sudbury, Tewksbury, Tyngsboro, Wakefield, Watham, Watertown, Wayland, Westford, Wilmington, Winchester and Woburn), NORFOLK (Bellingham, Braintree, Brookline, Canton, Cohasset, Dedham, Dover, Foxboro, Franklin, Medford, Medway, Millis, Milton, Needham, Norfolk, Norwood, Plainville, Quincy, Sharon, Walpole, Wellesley, Westwood, Weymouth and Wrentham); PLYMOUTH (Hingham, Hull, Scituate); SUFFOLK; WORCESTER (Hopedale and Southboro)

	Rates	Fringes
PLUMBER.....	\$ 61.79	32.43

---

PLUM0051-004 09/01/2018

BARNSTABLE; BRISTOL; DUKES; NANTUCKET; AND NORFOLK (Avon, Holbrook, Randolph, Stoughton) COUNTIES

	Rates	Fringes
Plumbers and Pipefitters.....	\$ 42.04	29.91

---

PLUM0537-005 03/01/2021

ESSEX (Ames, Andover, Beverly, Boxford, Byfield, Danvers, Essex, Georgetown, Gloucester, Groveland, Hamilton, Haverhill, Ipswich, Lawrence, Lynn, Lynnfield, Manchester, Marblehead, Merrimac, Methuen, Middleton, Nahant, Newbury, Newburyport, North Andover, Peabody, Rockport, Rowley, Salem, Salisbury, Saugus, Swampscott, Topsfield, Wenham, West Newbury); MIDDLESEX (Acton, Arlington, Ashford, Ayer-except west of Greenville Branch of Boston & Maine Rail Road, Bedford, Belmont, Billerica, Boxboro, Burlington, Cambridge, Carlisle, Chelmsford, Concord, Dracut, Dunstable, Everett, Framingham, Hudson, Holliston, Hopkinton, Lexington, Lincoln, Littleton, Lowell, Malden, Marlboro, Maynard, Medford, Melrose, Natick, Newton, North Reading, Pepperell, Reading, Sherborn, Somerville, Stoneham, Stow, Sudbury, Tewksbury, Tyngsboro, Wakefield, Watham, Watertown, Wayland, Westford, Wilmington, Winchester and Woburn); NORFOLK (Bellingham, Braintree, Brookline, Canton, Cohasset, Dedham, Dover, Foxboro, Franklin, Medford, Medway, Millis, Milton, Needham, Norfolk, Norwood, Plainville, Quincy, Sharon, Walpole, Wellesley, Westwood, Weymouth and Wrentham); PLYMOUTH (Hingham, Hull, Scituate); SUFFOLK; WORCHESTER (Hopedale and Southboro)

	Rates	Fringes
PIPEFITTER.....	\$ 57.08	34.97

-----  
 \* R00F0033-001 08/01/2021

	Rates	Fringes
Roofers: All Tear-off and/or removal of any types of roofing and all spudding, sweeping, vacuuming and/or cleanup of any and all areas of any type where a roof is to be relaid.....	\$ 47.03	32.18

-----  
 SFMA0550-001 10/01/2021

BRISTOL (Portion within 35 mile radius from Boston City Hall); ESSEX; MIDDLESEX (Except Ashby, Townsend, and portions of Pepperell and Shirley beyond 35 mile radius from Boston City Hall); NORFOLK; PLYMOUTH (Portion within 35 mile radius of Boston City Hall); SUFFOLK

Rates	Fringes
-------	---------

SPRINKLER FITTER..... \$ 63.30 33.21

a. PAID HOLIDAYS: Memorial Day, July 4th, Labor Day, Thanksgiving Day and Christmas Day, provided the employee has been in the employment of a contractor 20 working days prior to any such paid holiday.

-----  
SFMA0550-002 10/01/2021

BRISTOL (Seekonk, Swansea, and Somerset)

Rates Fringes

SPRINKLER FITTER..... \$ 56.97 33.21

a. PAID HOLIDAYS: Memorial Day, July 4th, Labor Day, Thanksgiving Day and Christmas Day, provided the employee has been in the employment of a contractor 20 working days prior to any such paid holiday.

-----  
SFMA0669-001 04/01/2021

BARNSTABLE; BRISTOL (Beyond 35 mile radius of Boston City Hall); DUKES; MIDDLESEX (Ashby, Townsend, portions of Pepperell and Shirley beyond 35 mile radius of Boston City Hall); NANTUCKET; PLYMOUTH (Beyond 35 mile radius of Boston City Hall)

Rates Fringes

SPRINKLER FITTER..... \$ 43.14 27.48

-----  
SHEE0017-003 08/01/2020

BRISTOL (Attleboro, Berkley, Easton, Mansfield, North Attleboro, Norton, Raynham, Taunton); ESSEX; MIDDLESEX; NORFOLK; PLYMOUTH (except except Marion, Mattapoisett, Rochester, Wareham); SUFFOLK

Rates Fringes

Sheet metal worker..... \$ 50.67 41.84

-----  
SHEE0017-007 08/01/2021

BARNSTABLE; BRISTOL (Acushnet, Assonet, Dartmouth, Dighton, Fairhaven, Fall River, Freetown, New Bedford, Rehoboth,

Seekonk, Somerset, Swansea, Westport); DUKES; AND NANTUCKET

	Rates	Fringes
Sheet metal worker.....	\$ 51.95	43.04
-----		
TEAM0379-001 08/01/2020		

	Rates	Fringes
Truck drivers:		
Group 1.....	\$ 34.98	26.6325+A+B
Group 2.....	\$ 35.15	26.6325+A+B
Group 3.....	\$ 35.22	26.6325+A+B
Group 4.....	\$ 34.44	26.6325+A+B
Group 5.....	\$ 35.44	26.6325+A+B
Group 6.....	\$ 35.73	26.6325+A+B
Group 7.....	\$ 36.02	26.6325+A+B

POWER TRUCKS \$.25 DIFFERENTIAL BY AXLE  
TUNNEL WORK (UNDERGROUND ONLY) \$.40 DIFFERENTIAL BY AXLE  
HAZARDOUS MATERIALS (IN HOT ZONE ONLY) \$2.00 PREMIUM

TRUCK DRIVERS CLASSIFICATIONS

- Group 1: Station wagons; panel trucks; and pickup trucks
- Group 2: Two axle equipment; & forklift operator
- Group 3: Three axle equipment and tireman
- Group 4: Four and Five Axle equipment
- Group 5: Specialized earth moving equipment under 35 tons other than conventional type trucks; low bed; vachual; mechanics, paving restoration equipment
- Group 6: Specialized earth moving equipment over 35 tons
- Group 7: Trailers for earth moving equipment (double hookup)

FOOTNOTES:

A. PAID HOLIDAYS: New Year's Day, Washington's Birthday, Memorial Day, Independence Day, Labor Day, Patriot's Day, Columbus Day, Veteran's Day, Thanksgiving Day and Christmas Day

B. PAID VACATION: Employees with 4 months to 1 year of service receive 1/2 day's pay per month; 1 week vacation for 1 - 5 years of service; 2 weeks vacation for 5 - 10 years of service; and 3 weeks vacation for more than 10 years of service

---

WELDERS - Receive rate prescribed for craft performing operation to which welding is incidental.

---

Note: Executive Order (EO) 13706, Establishing Paid Sick Leave for Federal Contractors applies to all contracts subject to the Davis-Bacon Act for which the contract is awarded (and any solicitation was issued) on or after January 1, 2017. If this contract is covered by the EO, the contractor must provide employees with 1 hour of paid sick leave for every 30 hours they work, up to 56 hours of paid sick leave each year. Employees must be permitted to use paid sick leave for their own illness, injury or other health-related needs, including preventive care; to assist a family member (or person who is like family to the employee) who is ill, injured, or has other health-related needs, including preventive care; or for reasons resulting from, or to assist a family member (or person who is like family to the employee) who is a victim of, domestic violence, sexual assault, or stalking. Additional information on contractor requirements and worker protections under the EO is available at [www.dol.gov/whd/govcontracts](http://www.dol.gov/whd/govcontracts).

Unlisted classifications needed for work not included within the scope of the classifications listed may be added after award only as provided in the labor standards contract clauses (29CFR 5.5 (a) (1) (ii)).

---

The body of each wage determination lists the classification and wage rates that have been found to be prevailing for the cited type(s) of construction in the area covered by the wage determination. The classifications are listed in alphabetical order of "identifiers" that indicate whether the particular rate is a union rate (current union negotiated rate for local), a survey rate (weighted average rate) or a union average rate (weighted union average rate).

Union Rate Identifiers

A four letter classification abbreviation identifier enclosed in dotted lines beginning with characters other than ""SU"" or ""UAVG"" denotes that the union classification and rate were prevailing for that classification in the survey. Example: PLUM0198-005 07/01/2014. PLUM is an abbreviation identifier of the union, which prevailed in the survey for this classification, which in this example would be Plumbers 0198 indicates the local union number or district council number where applicable, i.e., Plumbers Local 0198. The next number, 005 in the example, is an internal number used in processing the wage determination. 07/01/2014 is the effective date of the most current negotiated rate, which in this example is July 1, 2014.

Union prevailing wage rates are updated to reflect all rate changes in the collective bargaining agreement (CBA) governing this classification and rate.

#### Survey Rate Identifiers

Classifications listed under the ""SU"" identifier indicate that no one rate prevailed for this classification in the survey and the published rate is derived by computing a weighted average rate based on all the rates reported in the survey for that classification. As this weighted average rate includes all rates reported in the survey, it may include both union and non-union rates. Example: SULA2012-007 5/13/2014. SU indicates the rates are survey rates based on a weighted average calculation of rates and are not majority rates. LA indicates the State of Louisiana. 2012 is the year of survey on which these classifications and rates are based. The next number, 007 in the example, is an internal number used in producing the wage determination. 5/13/2014 indicates the survey completion date for the classifications and rates under that identifier.

Survey wage rates are not updated and remain in effect until a new survey is conducted.

#### Union Average Rate Identifiers

Classification(s) listed under the UAVG identifier indicate that no single majority rate prevailed for those classifications; however, 100% of the data reported for the classifications was union data. EXAMPLE: UAVG-OH-0010 08/29/2014. UAVG indicates that the rate is a weighted union average rate. OH indicates the state. The next number, 0010 in the example, is an internal number used in producing the wage determination. 08/29/2014 indicates the survey completion date for the classifications and rates under that identifier.

A UAVG rate will be updated once a year, usually in January of



each year, to reflect a weighted average of the current negotiated/CBA rate of the union locals from which the rate is based.

---

#### WAGE DETERMINATION APPEALS PROCESS

1.) Has there been an initial decision in the matter? This can be:

- \* an existing published wage determination
- \* a survey underlying a wage determination
- \* a Wage and Hour Division letter setting forth a position on a wage determination matter
- \* a conformance (additional classification and rate) ruling

On survey related matters, initial contact, including requests for summaries of surveys, should be with the Wage and Hour Division National Office Branch of Wage Surveys. If the response from this initial contact is not satisfactory, then the process described in 2.) and 3.) should be followed.

With regard to any other matter not yet ripe for the formal process described here, initial contact should be with the Branch of Construction Wage Determinations. Write to:

Branch of Construction Wage Determinations  
Wage and Hour Division  
U. S. Department of Labor  
200 Constitution Avenue, N. W.  
Washington, DC 20210

2.) If the answer to the question in 1.) is yes, then an interested party (those affected by the action) can request review and reconsideration from the Wage and Hour Administrator (See 29 CFR Part 1.8 and 29 CFR Part 7). Write to:

Wage and Hour Administrator  
U. S. Department of Labor  
200 Constitution Avenue, N. W.  
Washington, DC 20210

The request should be accompanied by a full statement of the interested party's position and by any information (wage payment data, project description, area practice material, etc.) that the requestor considers relevant to the issue.

3.) If the decision of the Administrator is not favorable, an

interested party may appeal directly to the Administrative Review Board (formerly the Wage Appeals Board). Write to:

Administrative Review Board  
U. S. Department of Labor  
200 Constitution Avenue, N. W.  
Washington, DC 20210

4.) All decisions by the Administrative Review Board are final.

=====

END OF GENERAL DECISION"

"General Decision Number: MA20220008 01/07/2022

Superseded General Decision Number: MA20210008

State: Massachusetts

Construction Types: Heavy (Heavy and Marine)

Counties: Barnstable, Bristol, Dukes, Essex, Middlesex, Nantucket, Norfolk, Plymouth and Suffolk Counties in Massachusetts.

#### HEAVY AND MARINE CONSTRUCTION PROJECTS

Note: Contracts subject to the Davis-Bacon Act are generally required to pay at least the applicable minimum wage rate required under Executive Order 14026 or Executive Order 13658. Please note that these Executive Orders apply to covered contracts entered into by the federal government that are subject to the Davis-Bacon Act itself, but do not apply to contracts subject only to the Davis-Bacon Related Acts, including those set forth at 29 CFR 5.1(a)(2)-(60).

If the contract is entered into on or after January 30, 2022, or the contract is renewed or extended (e.g., an option is exercised) on or after January 30, 2022, Executive Order 14026 generally applies to the contract. The contractor must pay all covered workers at least \$15.00 per hour (or the applicable wage rate listed on this wage determination, if it is higher) for all hours spent performing on that contract in 2022.

If the contract was awarded on or between January 1, 2015 and January 29, 2022, and the contract is not renewed or extended on or after January 30, 2022, Executive Order 13658 generally applies to the contract. The contractor must pay all covered workers at least \$11.25 per hour (or the applicable wage rate listed on this wage determination, if it is higher) for all hours spent performing on that contract in 2022.

The applicable Executive Order minimum wage rate will be adjusted annually. If this contract is covered by one of the Executive Orders and a classification considered necessary for performance of work on the contract does not appear on this wage determination, the contractor must still submit a conformance request.

Additional information on contractor requirements and worker protections under the Executive Orders is available at [www.dol.gov/whd/govcontracts](http://www.dol.gov/whd/govcontracts).

Modification Number      Publication Date  
0                              01/07/2022

BOIL0029-001 01/01/2021

	Rates	Fringes
BOILERMAKER.....	\$ 45.87	29.02

-----  
BRMA0001-011 08/01/2020

FOXBORO CHAPTER

BRISTOL (Attleboro, Berkley, Dighton, Mansfield, North Attleboro, Norton, Raynham, Rehoboth, Seekonk, Taunton); NORFOLK, (Bellingham, Canton, Dedham, Foxboro, Franklin, Norfolk, Norwood, Plainville, Sharon, Walpole, Westwood, Wrentham); and PLYMOUTH (Lakeville)

	Rates	Fringes
Bricklayer/Cement Mason.....	\$ 53.16	34.95

-----  
BRMA0001-012 08/01/2020

LOWELL CHAPTER

MIDDLESEX (Acton, Ashby, Ayer, Bedford, Billerica, Boxboro, Carlisle, Chemsford, Dracut, Dunstable, Ft Devens, Groton, Littleton, Lowell, North Acton, Pepperell, Shirley, South Acton, Tewksbury, Townsend, Tyngsboro, West Acton, Westford, Wilmingon)

	Rates	Fringes
BRICKLAYER.....	\$ 53.16	34.95

-----  
BRMA0001-013 08/01/2020

LOWELL CHAPTER

MIDDLESEX (Ashland, Framingham, Holliston, Hopkinton, Hudson, Maynard, Natick, Sherborn, Stow); and NORFOLK (Medfield, Medway, Millis)

	Rates	Fringes
BRICKLAYER.....	\$ 53.16	34.95

-----  
BRMA0003-001 02/01/2021

	Rates	Fringes
Marble & Tile Finisher.....	\$ 42.57	32.00
Marble, Tile & Terrazzo Workers.....	\$ 54.69	33.80
TERRAZZO FINISHER.....	\$ 55.77	34.47

-----  
BRMA0003-003 02/01/2021

BOSTON CHAPTER  
MIDDLESEX (Arlington, Cambridge, Everett, Malden, Medford,  
Melrose, Somerville); NORFOLK (Brookline, Milton); and SUFFOLK

	Rates	Fringes
BRICKLAYER.....	\$ 55.75	35.85

-----  
BRMA0003-011 02/01/2021

LYNN CHAPTER

ESSEX (Amesbury, Andover, Beverly, Boxford, Danvers, Essex,  
Georgetown, Gloucester, Groveland, Hamilton, Haverhill,  
Ipswich, Lawrence, Lynn, Lynnfield, Manchester, Marblehead,  
Merrimac, Methuen, Middleton, Nahant, Newbury, Newburyport,  
North Andover, Peabody, Rockport, Rowley, Salisbury, Salem,  
Saugus, Swampscott, Topsfield, Wakefield, Wenham, West  
Newbury); and MIDDLESEX (North Reading, Reading, Wakefield)

	Rates	Fringes
Bricklayer/Cement Mason.....	\$ 55.75	35.85

-----  
BRMA0003-012 02/01/2021

	Rates	Fringes
BRICKLAYER WALTHAM CHAPTER - MIDDLESEX (Belmont, Burlington, Concord, Lexington, Lincoln, Stoneham, Sudbury, Waltham, Watertown, Wayland, Weston, Winchester, Woburn).....	\$ 55.75	35.85

-----  
BRMA0003-014 02/01/2021

QUINCY CHAPTER

PLYMOUTH COUNTY (Abington, Bridgewater, Brockton, Carver, Duxbury, East Bridgewater, Halifax, Hanover, Hanson, Hingham, Hull, Kingston, Marshfield, Middleboro, Norwell, Pembroke, Plymouth, Rockland, Scituate, West Bridgewater, Whitman)

	Rates	Fringes
Bricklayer/Cement Mason.....	\$ 55.75	35.85

-----  
BRMA0003-025 02/01/2021

NEW BEDFORD CHAPTER

BARNSTABLE; BRISTOL (Acushnet, Dartmouth, Fairhaven, Fall River, Freetown, New Bedford, Somerset, Swansea, Westport); DUKES; NANTUCKET; PLYMOUTH (Marion, Mattapoisett, Rochester, Wareham)

	Rates	Fringes
Bricklayer/Cement Mason.....	\$ 55.75	35.85

-----  
BRMA0003-033 02/01/2021

NEWTON CHAPTER

MIDDLESEX (Newton); NORFOLK (Dover, Needham, Wellesley)

	Rates	Fringes
Bricklayer, Plasterer.....	\$ 55.75	35.85

-----  
CARP0056-001 08/01/2021

All of SUFFOLK COUNTY; and those areas of BARNSTABLE, BRISTOL, ESSEX, MIDDLESEX, NORFOLK, and PLYMOUTH COUNTIES situated INSIDE Boston Beltway (I-495) and North of Cape Cod Canal. ALL of DUKES and NANTUCKET COUNTIES

	Rates	Fringes
PILEDRIVERMAN.....	\$ 50.74	33.66

-----  
CARP0056-002 08/01/2021

The areas of BARNSTABLE, BRISTOL, PLYMOUTH, and NORFOLK COUNTIES situated OUTSIDE Boston Beltway (I-495) and South of Cape Cod Canal

	Rates	Fringes
PI LEDRIVERMAN.....	\$ 47.14	33.45
-----		
CARP0056-003 08/01/2021		

Those areas of ESSEX and MIDDLESEX COUNTIES situated OUTSIDE Boston Beltway (I-495)

	Rates	Fringes
PI LEDRIVERMAN.....	\$ 44.61	33.45
-----		
CARP0056-004 08/01/2020		

	Rates	Fringes
DIVER TENDER.....	\$ 49.07	35.57
DIVER.....	\$ 68.70	35.57
-----		
CARP0327-002 03/01/2021		

MIDDLESEX (Belmont, Cambridge, Everett, Malden, Medford, Somerville); NORFOLK (Brookline, Dedham, Milton); AND SUFFOLK COUNTIES

	Rates	Fringes
CARPENTER.....	\$ 52.38	20.78
-----		
* CARP0339-002 09/01/2021		

BRISTOL (Attleborough, North Attleborough); ESSEX; MIDDLESEX (Except Belmont, Cambridge, Everett, Malden, Medford, Somerville); AND NORFOLK (Bellingham, Braintree, Canton, Cohasset, Foxboro, Franklin, Medfield, Medway, Millis, Needham, Norfolk, Norwood, Plainville, Quincy, Sharon, Walpole, Wellesley, Westwood, Weymouth, Wrentham) COUNTIES

	Rates	Fringes
CARPENTER.....	\$ 44.18	29.27

-----  
CARP0346-001 03/01/2020

NORFOLK (Braintree, Quincy, Cohasset, Weymouth, etc.) PLYMOUTH  
(Duxbury, Hanover, Hull, Hingham, Marshfield, Norwell, Pembroke  
Rockland, Scituate)

	Rates	Fringes
CARPENTER.....	\$ 42.40	29.10

-----  
CARP0624-002 09/01/2017

DUKES; NANTUCKET

	Rates	Fringes
CARPENTER.....	\$ 46.43	28.35

-----  
CARP0624-006 09/01/2017

BARNSTABLE; BRISTOL (Except Attleboro & North Attleboro);  
NORFOLK (Avon, Holbrook, Randolph, Stoughton); PLYMOUTH  
(Bridgewater, Kingston, Lakeville, Middleboro, Plymouth, S.  
Hanover, Whitman)

	Rates	Fringes
CARPENTER.....	\$ 39.28	27.90

-----  
CARP1121-001 01/06/2020

SUFFOLK COUNTY

	Rates	Fringes
MILLWRIGHT.....	\$ 42.32	31.15

-----  
CARP1121-005 01/06/2020

BARNSTABLE, BRISTOL, DUKES, ESSEX, MIDDLESEX, NANTUCKET,  
NORFOLK and PLYMOUTH COUNTIES

	Rates	Fringes
MILLWRIGHT.....	\$ 38.47	31.15

-----  
ELEC0096-001 09/06/2021



MIDDLESEX (Ashby, Ashland, Ayer, Ft. Devens, Groton, Hopkinton, Hudson, Marlboro, Pepperell, Shirley, Stow, Townsend)

	Rates	Fringes
ELECTRICIAN.....	\$ 45.01	11%+25.01
Teladata System Installer.....	\$ 32.85	28.12

-----  
 ELEC0099-001 06/01/2021

BRISTOL (Attleboro, North Attleboro, Seekonk)

	Rates	Fringes
ELECTRICIAN.....	\$ 43.61	54.71%
Teladata System Installer.....	\$ 31.21	13.1%+14.93

-----  
 ELEC0103-002 09/01/2021

ESSEX (Amesbury, Andover, Boxford, Georgetown, Groveland, Haverhill, Lawrence, Merrimac, Methuen, Newbury, Newburyport, North Andover, Rowley, Salisbury, West Newbury); MIDDLESEX (Bedford, Billerica, Boxboro, Burlington, Carlisle, Chelmsford, Dracut, Dunstable, Littleton, Lowell, North Reading, Tewksbury, Tyngsboro, Westford, Wilmington)

	Rates	Fringes
ELECTRICIAN.....	\$ 56.36	34.39

-----  
 ELEC0103-004 09/01/2021

ESSEX (Beverly, Danvers, Essex, Gloucester, Hamilton, Ipswich, Manchester, Marblehead, Middleton, Peabody, Rockport, Salem, Topsfield, Wenham)

	Rates	Fringes
ELECTRICIAN.....	\$ 56.36	34.39

-----  
 ELEC0103-005 09/01/2021

ESSEX (Lynn, Lynnfield, Nahant, Saugus, Swampscott); MIDDLESEX (Acton, Arlington, Belmont, Cambridge, Concord, Everett, Framingham, Holliston, Lexington, Lincoln, Malden, Maynard, Medford, Melrose, Natick, Newton, Reading, Sherborn, Somerville, Stoneham, Sudbury, Wakefield, Waltham, Watertown,

Wayland, Weston, Winchester, Woburn); NORFOLK (Bellingham, Braintree, Brookline, Canton, Cohasset, Dedham, Dover, Foxboro, Frankl oin, Medfield, Medway, Millis, Milton, Needham, Norfolk, Norwood, Quincy, Sharon, Walpole, Wellesley, Westwood, Weymouth, Wrentham); PLYMOUTH (Hingham and Hull); SUFFOLK

	Rates	Fringes
ELECTRICIAN.....	\$ 56.36	34.39

\* ELEC0104-001 09/01/2021

	Rates	Fringes
Line Construction:		
Cableman.....	\$ 51.09	27.91+A
Equipment Operator.....	\$ 43.43	24.62+A
Groundman.....	\$ 28.10	11.80+A
Lineman.....	\$ 51.09	27.91+A

A. PAID HOLIDAYS: New Year's Day; Memorial Day; Independence Day; Labor Day; Thanksgiving Day; Christmas Day and Columbus Day, provided the employee has been employed 5 working days prior to any one of the listed holidays.

-----  
ELEC0223-002 09/01/2021

BARNSTABLE, BRISTOL (Except Attleboro, North Attleboro, Seekonk); DUKES; NANTUCKET; PLYMOUTH (Except Hingham and Hull Twps); NORFOLK (Avon, Halbrook, Randolph, Soughton)

	Rates	Fringes
ELECTRICIAN.....	\$ 44.27	31.18%+14.00

-----  
ENGI0004-009 06/01/2020

	Rates	Fringes
Power equipment operators:		
Group 1.....	\$ 49.33	29.75+a
Group 2.....	\$ 48.81	29.75+a
Group 3.....	\$ 32.72	29.75+a
Group 4.....	\$ 40.30	29.75+a
Group 5.....	\$ 23.13	29.75+a
Group 6.....	\$ 27.79	29.75+a

HOURLY PREMIUM FOR BOOM LENGTHS (Including Jib):

Over 150 ft. +2.18  
Over 185 ft. +3.84  
Over 210 ft. +5.39  
Over 250 ft. +8.16  
Over 295 ft. +11.29  
Over 350 ft. +13.14

FOOTNOTE FOR POWER EQUIPMENT OPERATORS:

A. PAID HOLIDAYS: New Year's Day, Washington's Birthday, Labor Day, Memorial Day, Independence Day, Patriot's Day, Columbus Day, Veteran's Day, Thanksgiving Day, Christmas Day

POWER EQUIPMENT OPERATORS CLASSIFICATIONS [HEAVY CONSTRUCTION]

GROUP 1: Power shovel; crane; truck crane; derrick; pile driver; trenching machine; mechanical hoist pavement breaker; cement concrete paver; dragline; hoisting engine; three drum machine; pumpcrete machine; loaders; shovel dozer; front end loader; mucking machine; shaft hoist; steam engine; backhoe; gradall; cable way; fork lift; cherry picker; boring machine; rotary drill; post hole hammer; post hole digger; asphalt plant on job site; concrete batching and/or mixing plant on job site; crusher plant on job site; paving concrete mixer; timber jack

GROUP 2: Sonic or vibratory hammer; grader; scraper; tandem scraper; bulldozer; tractor; mechanic - maintenance; York rake; mulching machine; paving screed machine; stationary steam boiler; paving concrete finishing machine; grout pump; portable steam boiler; portable steam generator; roller; spreader; asphalt paver; locomotives or machines used in place thereof; tamper (self propelled or tractor-draw); cal tracks; ballast regulator; rail anchor machine; switch tamper; tire truck

GROUP 3: Pumps (1-3 grouped); compressor; welding machines (1-3 grouped); generator; sighting plant; heaters (power driven, 1- 5); syphon-pul someter; concrete mixer; valves controlling permanent plant air steam, conveyor, wellpoint system (operating)

GROUP 4: Assitant engineer (fireman)

GROUP 5: Oiler (other than truck cranes and gradalls)

GROUP 6: Oiler (on truck cranes and gradalls)

-----  
IRON007-001 09/16/2021

AREA 1: BRISTOL (Easton); ESSEX (Beverly, Gloucester, Lynn, Lynnfield, Manchester, Marblehead, Nahant, Rockport, Salem, Saugus, Swampscott); MIDDLESEX (Arlington, Bedford, Belmont, Burlington, Cambridge, Carlisle, Concord, Dunstable, Everett, Framingham, Lexington, Lincoln, Malden, Maynard, Medford,

Melrose, Natick, Newton, Reading, Sherborn, Somerville, Stoneham, Sudbury, Wakefield, Waltham, Watertown, Wayland, Weston, Winchester, Woburn); NORFOLK (Except Medway); PLYMOUTH (Abington, Bridgewater, Brockton, Duxbury, East Bridgewater, Halifax, Hanover, Hanson, Hingham, Hull, Kingston, Marshfield, Norwell, Pembroke, Plymouth, Plympton, Rockland, Scituate, West Bridgewater, Whitman); SUFFOLK

AREA 2: ESSEX (Amesbury, Andover, Boxford, Danvers, Essex, Georgetown, Hamilton, Haverhill, Ipswich, Lawrence, Merrimac, Methuen, Newbury, Newburyport, North Andover, Rowley, Salisbury, Topsfield, Wenham, West Newbury); MIDDLESEX (Acton, Billerica, Chelmsford, Dracut, Groton, Groveland, Littleton, Lowell, Middleton, North Reading, Pepperell, Tewksbury, Tyngsboro, Westford, Wilmington)

	Rates	Fringes
IRONWORKER		
AREA 1.....	\$ 50.13	34.81
AREA 2.....	\$ 45.72	34.81

-----  
 IRON0007-010 09/16/2021

MIDDLESEX (Ashby, Ashland, Ayer, Boxboro, Holliston, Hopkinton, Hudson, Marlboro, Shirley, Stow, Townsend); NORFOLK (Medway)

	Rates	Fringes
IRONWORKER.....	\$ 49.83	34.81

-----  
 IRON0037-002 03/16/2021

BARNSTABLE; BRISTOL (Acushnet, Attleboro, Berkley, Dartmouth, Dighton, Fairhaven, Fall River, Freetown, Mansfield, New Bedford, North Attleboro, Norton, Raynham, Rehoboth, Seekonk, Somerset, Swansea, Taunton, Westport); DUKES; NANTUCKET; NORFOLK (Billingham, Franklin, Plainville, Wrentham); PLYMOUTH (Lakeville, Marion, Mattapoisett, Middleboro, Rochester, Wareham)

	Rates	Fringes
IRONWORKER.....	\$ 37.87	30.13

-----  
 \* LAB00022-006 12/01/2021

SUFFOLK COUNTY (Boston, Chelsea, Revere, Winthrop, Deer & Nut

Islands); MIDDLESEX COUNTY (Arlington, Belmont, Burlington, Cambridge, Everett, Malden, Medford, Melrose, Reading, Somerville, Stoneham, Wakefield, Winchester, Winthrop and Woburn only); NORFOLK COUNTY (Brookline, Dedham, and Milton only)

	Rates	Fringes
Laborers:		
GROUP 1.....	\$ 41.18	27.52
GROUP 2.....	\$ 41.43	27.52
GROUP 3.....	\$ 41.93	27.52
GROUP 4.....	\$ 42.18	27.52
GROUP 5.....	\$ 24.50	27.52
GROUP 6.....	\$ 43.18	27.52

LABORERS CLASSIFICATIONS

GROUP 1: Laborers; carpenter tenders; cement finisher tenders

GROUP 2: Asphalt raker; fence and guard rail erector; laser beam operator; mason tender; pipelayer; pneumatic drill operator; pneumatic tool operator; wagon drill operator

GROUP 3: Air track operator; block paver; rammer; curb setter

GROUP 4: Blaster; powderman

GROUP 5: Flagger

GROUP 6: Asbestos Abatement; Toxic and Hazardous Waste Laborers

-----  
 \* LAB00022-012 12/01/2021

Counties of BARNSTABLE; BRISTOL; DUKES; ESSEX; NANTUCKET; PLYMOUTH; MIDDLESEX (With the exception of Arlington, Belmont, Burlington, Cambridge, Everett, Malden, Melrose, Reading, Somerville, Stoneham, Wakefield, Winchester, Winthrop and Woburn); NORFOLK (With the exception of Brookline, Dedham, and Milton)

	Rates	Fringes
Laborers:		
GROUP 1.....	\$ 35.41	26.59

GROUP 2.....	\$ 35.66	26.59
GROUP 3.....	\$ 36.16	26.59
GROUP 4.....	\$ 36.41	26.59
GROUP 5.....	\$ 24.50	26.59
GROUP 6.....	\$ 37.41	26.59

LABORERS CLASSIFICATIONS

GROUP 1: Laborers; carpenter tenders; cement finisher tenders

GROUP 2: Asphalt raker; fence and guard rail erector; laser beam operator; mason tender; pipelayer; pneumatic drill operator; pneumatic tool operator; wagon drill operator

GROUP 3: Air track operator; block paver; rammer; curb setter; hydraulic & similar self powered drills

GROUP 4: Blaster; powderman

GROUP 5: Flagger

GROUP 6: Asbestos Abatement; Toxic and Hazardous Waste Laborers

-----  
\* LAB00022-013 12/01/2021

	Rates	Fringes
Laborers:		
(FREE AIR OPERATION):		
SHIELD DRIVEN AND LINER PLATE IN FREE AIR)		
GROUP 1.....	\$ 45.48	28.02
GROUP 2.....	\$ 45.48	28.02
(OPEN AIR CASSONS, UNDERPINNING AND TEST BORING INDUSTRIES):		
TEST BORING & WELL DRILLING		
Driller.....	\$ 42.58	27.67
Laborer.....	\$ 41.18	27.67
(OPEN AIR CASSONS, UNDERPINNING AND TEST BORING INDUSTRIES):		

OPEN AIR CASSON, UNDERPINNING WORK & BORING CREW		
Bottom man.....	\$ 42.33	27.67
Laborers; Top man.....	\$ 41.18	27.67
(TUNNELS, CAISSON & CYLINDER WORK IN COMPRESSED AIR)		
GROUP 1.....	\$ 42.93	28.02
GROUP 2.....	\$ 53.41	28.02
GROUP 3.....	\$ 53.41	28.02
GROUP 4.....	\$ 53.41	28.02
GROUP 5.....	\$ 53.41	28.02
GROUP 6.....	\$ 55.41	28.02
CLEANING CONCRETE AND CAULKING TUNNEL (Both New & Existing)		
GROUP 1.....	\$ 45.48	28.02
GROUP 2.....	\$ 45.48	28.02
ROCK SHAFT, CONCRETE LINING OF SAME AND TUNNEL IN FREE AIR		
GROUP 1.....	\$ 42.93	28.02
GROUP 2.....	\$ 45.48	28.02
GROUP 3.....	\$ 45.48	28.02
GROUP 4.....	\$ 45.48	28.02
GROUP 5.....	\$ 47.48	28.02

LABORERS CLASSIFICATIONS for TUNNELS, CAISSON & CYLINDER WORK  
IN COMPRESSED AIR

GROUP 1: Powder watchman; Top man on iron bolt; change house attendant

GROUP 2: Brakeman; trackman; groutman; tunnel laborer; outside lock tender; lock tender; guage tender

GROUP 3: Motorman, miner

GROUP 4: Blaster

GROUP 5: Mucking machine operator

GROUP 6: Hazardous Waste work within the ""HOT"" zone. (A premium of two dollars \$2.00 per hour over the basic wage rate.

LABORERS CLASSIFICATIONS for (FREE AIR OPERATION): SHIELD  
DRIVEN AND LINER PLATE IN FREE AIR

GROUP 1: Miner; miner welder; conveyor operator; motorman; mucking machine operator; nozzle man; grout man-; pumps, shaft and tunnel steel and rodman; shield and erector arm operators, mole nipper, outside motorman, burner, TBM operator, safety miner; laborer topside; heading motormen; erecting operators; top signal men

GROUP 2: Brakeman; trackman

LABORERS CLASSIFICATIONS FOR CLEANING CONCRETE AND CAULKING TUNNEL (Both New & Existing)

GROUP 1: Concrete workers; strippers and form movers (wood & steel), cement finisher

GROUP 2: Form erector (wood & steel and all accessories)

LABORERS CLASSIFICATIONS for ROCK SHAFT, CONCRETE LINING OF SAME AND TUNNEL IN FREE AIR

GROUP 1: Change house attendants

GROUP 2: Laborers, topside, bottom men (when heading is 50 ft. from shaft) and all other laborers

GROUP 3: Brakeman; trackman; tunnel laborers; shaft laborers

GROUP 4: Miner; cage tender; bellman

GROUP 5: Hazardous Waste work within the "HOT" zone. (A premium of two dollars \$2.00 per hour over the basic wage rate)

FOOTNOTE FOR LABORERS:

A. PAID HOLIDAYS: New Year's Day, Washington's Birthday, Patriot's Day, Memorial Day, Independence Day, Labor Day, Columbus Day, Veteran's Day, Thanksgiving Day, and Christmas Day

---

\* LAB01421-001 12/01/2021

WRECKING LABORERS:

Rates

Fringes



Laborers: (Wrecking)

Group 1.....	\$ 41.33	27.37
Group 2.....	\$ 42.08	27.37
Group 3.....	\$ 42.33	27.37
Group 4.....	\$ 37.33	27.37
Group 5.....	\$ 40.43	27.37
Group 6.....	\$ 41.33	27.37

Group 1: Adzeman, Wrecking Laborer.

Group 2: Burners, Jackhammers.

Group 3: Small Backhoes, Loaders on tracks, Bobcat Type Loaders, Hydraulic ""Brock"" Type Hammer Operators, Concrete Cutting Saws.

Group 4: Yardman (Salvage Yard Only).

Group 5: Yardman, Burners, Sawyers.

Group 6: Asbestos, Lead Paint, Toxic and Hazardous Waste.

-----  
PAI N0035-001 07/01/2019

BARNSTABLE BRISTOL; DUKES; ESSEX; NANTUCKET; PLYMOUTH  
(Remainder of NORFOLK; MIDDLESEX AND SUFFOLK COUNTIES)

Rates Fringes

PAINTER

NEW CONSTRUCTION:

Bridge.....	\$ 50.36	30.25
Brush, Taper.....	\$ 39.86	30.25
Spray, Sandblast.....	\$ 41.26	30.25

REPAINT:

Bridge.....	\$ 50.66	30.90
Brush, Taper.....	\$ 37.92	30.25
Spray, Sandblast.....	\$ 39.32	30.25

-----  
PAI N0035-015 07/01/2019

MIDDLESEX (Cambridge, Everett, Malden, Medford, Somerville)  
SUFFOLK COUNTY (Boston, Chelsea) NORFOLK COUNTY (Brookline)

Rates Fringes

PAINTER

NEW CONSTRUCTION:

Brush, Taper.....	\$ 45.65	30.25
Spray, Sandblast.....	\$ 47.05	30.25

REPAINT:

Bridge.....	\$ 50.66	30.90
-------------	----------	-------

Brush, Taper.....	\$ 43.71	30.25
Spray, Sandblast.....	\$ 45.11	30.25

-----

PLAS0534-001 01/01/2020

ESSEX; MIDDLESEX; NORFOLK AND SUFFOLK COUNTY

	Rates	Fringes
CEMENT MASON/CONCRETE FINISHER... \$	43.00	37.66

-----

PLUM0004-001 09/01/2021

MIDDLESEX (Ashby, Ayer-West of Greenville branch of Boston and  
Maine Railroad, Ft. Devens, Groton, Shirley, Townsend)

	Rates	Fringes
Plumbers and Pipefitters..... \$	48.50	27.27

-----

PLUM0012-001 03/01/2019

ESSEX (Ames, Andover, Beverly, Boxford, Byfield, Danvers,  
Essex, Georgetown, Gloucester, Groveland, Hamilton, Haverhill,  
Ipswich, Lawrence, Manchester, Marblehead, Merrimac, Methuen,  
Middleton, Newbury, Newburyport, North Andover, Peabody,  
Rockport, Rowley, Salem, Salisbury, Topsfield, Wenham, West  
Newbury)

	Rates	Fringes
PLUMBER..... \$	52.61	29.93

-----

PLUM0012-003 03/01/2019

ESSEX (Ames, Andover, Beverly, Boxford, Byfield, Danvers,  
Essex, Georgetown, Gloucester, Groveland, Hamilton, Haverhill,  
Ipswich, Lawrence, Manchester, Marblehead, Merrimac, Methuen,  
Middleton, Newbury, Newburyport, North Andover, Peabody,  
Rockport, Rowley, Salem, Salisbury, Topsfield, Wenham, West  
Newbury)

	Rates	Fringes
Plumber, Pipefitter, Steamfitter..... \$	52.61	29.93

-----

PLUM0012-006 03/01/2019

ESSEX (Lynn, Lynnfield, Nahant, Saugus, and Swampscott);  
MIDDLESEX (Acton, Arlington, Ashland, Ayer - except W. of  
Greenville Branch of Boston & Maine RR, Bedford, Belmont,  
Billerica, Boxboro, Burlington, Cambridge, Carlisle,  
Chelmsford, Concord, Dracut, Dunstable, Everett, Framingham,  
Hudson, Holliston, Hopkinton, Lexington, Lincoln, Littleton,  
Lowell, Malden, Marlboro, Maynard, Medford, Melrose, Natick,  
Newton, North Reading, Pepperell, Reading, Sherborn,  
Somerville, Stoneham, Stow, Sudbury, Tewksbury, Tyngsboro,  
Wakefield, Waltham, Watertown, Wayland, Westford, Wilmington,  
Winchester, Woburn); NORFOLK (Bellingham, Braintree,  
Brookline, Canton, Cohasset, Dedham, Dover, Foxboro, Franklin,  
Medfield, Medway, Millis, Milton, Needham, Norfolk, Norwood,  
Plainville, Quincy, Sharon, Walpole, Wellesley, Westwood,  
Weymouth, Wrentham); PLYMOUTH (Hingham, Hull, Scituate);  
SUFFOLK

	Rates	Fringes
PLUMBER.....	\$ 56.69	29.93
-----		
PLUM0051-005 09/01/2018		

BARNSTABLE; BRISTOL; DUKES; NANTUCKET; NORFOLK (Avon, Holbrook,  
Randolph, Stoughton) PLYMOUTH(Remainder of County)

	Rates	Fringes
Plumbers and Pipefitters.....	\$ 42.04	29.91
-----		
PLUM0537-001 03/01/2021		

MIDDLESEX (Arlington, Cambridge, Everett, Malden, Medford,  
Melrose, Reading, Wakefield, Winchester and Woburn); NORFOLK  
(Bellingham, Braintree, Brookline, Canton, Cohasset, Dedham,  
Foxboro, Franklin, Millis, Milton, Sharon, Walpole, Westwood,  
and Wrentham); PLYMOUTH (Hingham, Hull, Scituate); ESSEX (Ames,  
Andover, Beverly, Boxford, Byfield, Danvers, Essex, Georgetown,  
Gloucester, Groveland, Hamilton, Haverhill, Ipswich,  
Lawrence, Lynn, Lynnfield, Manchester, Marblehead, Merrimac,  
Methuen, Middleton, Nahant, Newbury, Newburyport, North  
Andover, Peabody, Rockport, Rowley, Salem, Salisbury, Saugus,  
Swampscott, Topsfield, Wenham, West Newbury)

	Rates	Fringes
PIPEFITTER.....	\$ 52.75	34.97

	Rates	Fringes
Truck drivers:		
Group 1.....	\$ 34.98	26.6325+A+B
Group 2.....	\$ 35.15	26.6325+A+B
Group 3.....	\$ 35.22	26.6325+A+B
Group 4.....	\$ 34.44	26.6325+A+B
Group 5.....	\$ 35.44	26.6325+A+B
Group 6.....	\$ 35.73	26.6325+A+B
Group 7.....	\$ 36.02	26.6325+A+B

POWER TRUCKS \$.25 DIFFERENTIAL BY AXLE  
TUNNEL WORK (UNDERGROUND ONLY) \$.40 DIFFERENTIAL BY AXLE  
HAZARDOUS MATERIALS (IN HOT ZONE ONLY) \$2.00 PREMIUM

TRUCK DRIVERS CLASSIFICATIONS

- Group 1: Station wagons; panel trucks; and pickup trucks
- Group 2: Two axle equipment; & forklift operator
- Group 3: Three axle equipment and tireman
- Group 4: Four and Five Axle equipment
- Group 5: Specialized earth moving equipment under 35 tons other than conventional type trucks; low bed; vachual; mechanics, paving restorati on equipment
- Group 6: Specialized earth moving equipment over 35 tons
- Group 7: Trailers for earth moving equipment (double hookup)

FOOTNOTES:

- A. PAID HOLIDAYS: New Year's Day, Washington's Birthday, Memorial Day, Independence Day, Labor Day, Patriot's Day, Columbus Day, Veteran's Day, Thanksgiving Day and Christmas Day
- B. PAID VACATION: Employees with 4 months to 1 year of service receive 1/2 day's pay per month; 1 week vacation for 1 - 5 years of service; 2 weeks vacation for 5 - 10 years of service; and 3 weeks vacation for more than 10 years of service

-----  
WELDERS - Receive rate prescribed for craft performing operation to which welding is incidental.

=====  
Note: Executive Order (EO) 13706, Establishing Paid Sick Leave for Federal Contractors applies to all contracts subject to the Davis-Bacon Act for which the contract is awarded (and any solicitation was issued) on or after January 1, 2017. If this contract is covered by the EO, the contractor must provide employees with 1 hour of paid sick leave for every 30 hours they work, up to 56 hours of paid sick leave each year. Employees must be permitted to use paid sick leave for their own illness, injury or other health-related needs, including preventive care; to assist a family member (or person who is like family to the employee) who is ill, injured, or has other health-related needs, including preventive care; or for reasons resulting from, or to assist a family member (or person who is like family to the employee) who is a victim of, domestic violence, sexual assault, or stalking. Additional information on contractor requirements and worker protections under the EO is available at [www.dol.gov/whd/govcontracts](http://www.dol.gov/whd/govcontracts).

Unlisted classifications needed for work not included within the scope of the classifications listed may be added after award only as provided in the labor standards contract clauses (29CFR 5.5 (a) (1) (ii)).

-----  
The body of each wage determination lists the classification and wage rates that have been found to be prevailing for the cited type(s) of construction in the area covered by the wage determination. The classifications are listed in alphabetical order of "identifiers" that indicate whether the particular rate is a union rate (current union negotiated rate for local), a survey rate (weighted average rate) or a union average rate (weighted union average rate).

#### Union Rate Identifiers

A four letter classification abbreviation identifier enclosed in dotted lines beginning with characters other than "SU" or "UAVG" denotes that the union classification and rate were prevailing for that classification in the survey. Example: PLUM0198-005 07/01/2014. PLUM is an abbreviation identifier of the union, which prevailed in the survey for this

classification, which in this example would be Plumbers 0198 indicates the local union number or district council number where applicable, i.e., Plumbers Local 0198. The next number, 005 in the example, is an internal number used in processing the wage determination. 07/01/2014 is the effective date of the most current negotiated rate, which in this example is July 1, 2014.

Union prevailing wage rates are updated to reflect all rate changes in the collective bargaining agreement (CBA) governing this classification and rate.

#### Survey Rate Identifiers

Classifications listed under the ""SU"" identifier indicate that no one rate prevailed for this classification in the survey and the published rate is derived by computing a weighted average rate based on all the rates reported in the survey for that classification. As this weighted average rate includes all rates reported in the survey, it may include both union and non-union rates. Example: SULA2012-007 5/13/2014. SU indicates the rates are survey rates based on a weighted average calculation of rates and are not majority rates. LA indicates the State of Louisiana. 2012 is the year of survey on which these classifications and rates are based. The next number, 007 in the example, is an internal number used in producing the wage determination. 5/13/2014 indicates the survey completion date for the classifications and rates under that identifier.

Survey wage rates are not updated and remain in effect until a new survey is conducted.

#### Union Average Rate Identifiers

Classification(s) listed under the UAVG identifier indicate that no single majority rate prevailed for those classifications; however, 100% of the data reported for the classifications was union data. EXAMPLE: UAVG-OH-0010 08/29/2014. UAVG indicates that the rate is a weighted union average rate. OH indicates the state. The next number, 0010 in the example, is an internal number used in producing the wage determination. 08/29/2014 indicates the survey completion date for the classifications and rates under that identifier.

A UAVG rate will be updated once a year, usually in January of each year, to reflect a weighted average of the current negotiated/CBA rate of the union locals from which the rate is based.

---

WAGE DETERMINATION APPEALS PROCESS

1.) Has there been an initial decision in the matter? This can be:

- \* an existing published wage determination
- \* a survey underlying a wage determination
- \* a Wage and Hour Division letter setting forth a position on a wage determination matter
- \* a conformance (additional classification and rate) ruling

On survey related matters, initial contact, including requests for summaries of surveys, should be with the Wage and Hour Division National Office Branch of Wage Surveys. If the response from this initial contact is not satisfactory, then the process described in 2.) and 3.) should be followed.

With regard to any other matter not yet ripe for the formal process described here, initial contact should be with the Branch of Construction Wage Determinations. Write to:

Branch of Construction Wage Determinations  
Wage and Hour Division  
U. S. Department of Labor  
200 Constitution Avenue, N. W.  
Washington, DC 20210

2.) If the answer to the question in 1.) is yes, then an interested party (those affected by the action) can request review and reconsideration from the Wage and Hour Administrator (See 29 CFR Part 1.8 and 29 CFR Part 7). Write to:

Wage and Hour Administrator  
U. S. Department of Labor  
200 Constitution Avenue, N. W.  
Washington, DC 20210

The request should be accompanied by a full statement of the interested party's position and by any information (wage payment data, project description, area practice material, etc.) that the requestor considers relevant to the issue.

3.) If the decision of the Administrator is not favorable, an interested party may appeal directly to the Administrative Review Board (formerly the Wage Appeals Board). Write to:

Administrative Review Board  
U. S. Department of Labor  
200 Constitution Avenue, N. W.

Washington, DC 20210

4.) All decisions by the Administrative Review Board are final.

=====

END OF GENERAL DECISION"





**ATTACHMENT C**

**Massachusetts Equal Employment Opportunity Package**



**CONSTRUCTION BID SPECIFICATIONS  
SPECIAL PROVISIONS FOR DISADVANTAGED BUSINESS ENTERPRISES  
MASSACHUSETTS DEPARTMENT OF ENVIRONMENTAL PROTECTION  
DIVISION OF MUNICIPAL SERVICES**

DISADVANTAGED BUSINESS ENTERPRISE PROGRAM BACKGROUND

In May 2008 a United States Environmental Protection Agency (EPA) rule became effective that changed the Minority Business Enterprise (MBE) and Women Business Enterprise (WBE) Program to a Disadvantaged Business Enterprise (DBE) Program.

For firms to qualify under the old MBE/WBE program they needed to be socially disadvantaged and had to be certified by the Supplier Diversity Office (SDO). Under the new DBE rule, the firms must be both **socially** and **economically** disadvantaged, **citizens of the United States**, and certified as a DBE. Women and certain minorities are presumed to be socially disadvantaged. The economic disadvantage is measured by the owner's initial and continuing personal net worth of less than \$1,320,000.

Because the Clean Water Act requires the use of MBEs and WBEs, these firms will still be utilized in the State Revolving Fund (SRF) Loan Program, but they must also be certified as DBEs.

SDO will continue to be the certifying agency for the SRF program. SDO certifies firms under the federal Department of Transportation program, which is acceptable for use in the SRF program. An additional form has been added to the DBE package to verify that DBEs are owned or controlled by United States citizens.

**BID SPECIFICATIONS**

**I.** In this contract, the percentage of business activity to be performed by disadvantaged business enterprise(s) (DBE) shall not be less than the following percentages of the total contract price or the percentage submitted by the contractor in the Schedule of Participation, whichever is greater:

Disadvantaged MBE (D/MBE) 5.7%

Disadvantaged WBE (D/WBE) 6.1%

## II. DEFINITIONS

For the purpose of these provisions, the following terms are defined as follows:

- A. Awarding Authority – Entity that awards a prime contract under a State Revolving Fund loan.
- B. Bidder - Any individual, partnership, joint venture, corporation, or firm submitting a price, directly or through an authorized representative, for the purpose of performing construction or construction related activities under a Contract.
- C. Certified DBE – A DBE certified by the United States Small Business Administration, under its 8(a) Business Development Program (13 CFR part 124, subpart A) or its Small Disadvantaged Business Program (13 CFR part 124, subpart B); The United States Department of Transportation (DOT), under its regulations for Participation by DBEs in DOT programs (49 CFR parts 23 and 26); or SDO in accordance with 40 CFR part 33; provided that the certification meets the U.S. citizenship requirement under 40 CFR §33.202 or §33.203.
- D. Compliance Unit - A subdivision of MassDEP’s Affirmative Action Office designated to ensure compliance under these provisions.
- E. Contractor - Any business that contracts or subcontracts for construction, demolition, renovation, survey, or maintenance work in the various classifications customarily used in work and that is acting in this capacity under the subject contract.
- F. Construction Related Services - Those services performed at the work site ancillary to, and/or in support of, the construction work, such as hauling, trucking, equipment operation, surveying or other technical services, etc. For the purposes hereof, supply and delivery of materials (e.g. pre-cast concrete elements) to the site by a supplier who has manufactured those goods, or substantially altered them before re-sales shall be considered as “construction related services
- G. Construction Work - The activities at the work site, or labor and use of materials in the performance of constructing, reconstructing, erecting, demolishing, altering, installing, disassembling, excavating, etc, all or part of the work required by the Contract Documents.
- H. Disadvantaged Business Enterprise (DBE) - An entity owned or controlled by a socially and economically disadvantaged individual as described by Public Law 102-389 (42 U.S.C. 4370d) or an entity owned and controlled by a socially and economically disadvantaged individual as described by Title X of the Clean Air Act Amendments of 1990 (42 U.S.C. 7601 note); a Small Business Enterprise (SBE); a Small Business in a Rural Area (SBRA); or a Labor Surplus Area Firm (LAF), a Historically Underutilized Business (HUB) Zone Small Business Concern, or a concern under a successor program.

- I. Equipment Rental Firm - A firm that owns equipment and assumes actual and contractual responsibility for renting said equipment to perform a useful function of the work of the contract consistent with normal industry practice
- J. Good Faith Efforts – The race and/or gender neutral measures described in 40 CFR 33, subpart C.
- K. HUBZone - A historically underutilized business zone, which is an area located within one or more qualified census tracts, qualified metropolitan counties, or lands within the external boundaries of an Indian reservation.
- L. HUBZone small business concern - A small business concern that appears on the List of Qualified HUBZone Small Business Concerns maintained by the Small Business Administration.
- M. Joint Venture - An agreement between SDO certified DBE and a non-DBE or non-DBE controlled enterprise.
  - 1. A pairing of companies will be considered a DBE joint venture if the SDO certified DBE which is part of the relationship has more than 51% of the profits that are derived from that project.
  - 2. A joint venture between a certified DBE subcontractor and a non DBE subcontractor, in which the DBE for that proportion of the joint venture’s contract equal to the DBE participation in the joint venture.
  - 3. Whenever a general bid is filed by a joint venture with a certified DBE participant in the joint venture that does not exercise more than 51% control over management and profits, that joint venture shall be entitled to credit as a DBE for that portion of the joint venture’s contract equal to the DBE participation in the joint venture. Minority As deemed by SDO.
- N. Labor surplus area firm (LSAF) - A concern that together with its first-tier subcontractors will perform substantially in labor surplus areas (as identified by the Department of Labor in accordance with 20 CFR part 654). Performance is substantially in labor surplus areas if the costs incurred under the contract on account of manufacturing, production or performance of appropriate services in labor surplus areas exceed 50 percent of the contract price.
- O. Letter of Intent – Certified document signed by the principal(s) of the DBE with respect to the work to be performed under contract.
- P. Local Government Unit (LGU) – A city, town, or municipal district which applies for a loan under the Clean Water Trust Program.
- Q. Material Supplier – A vendor certified by SDO as a DBE in sales to supply industry from an established place of business or source of supply, and that vendor.

1. Manufactures goods from raw materials, or substantially utilizes them in the work, or substantially alters them before resale, entitling the general contractor to DBE credit for 100% of the purchase order.
  2. Provides and maintains a storage facility for materials utilized in the work, entitling the general contractor to DBE credit for 10% of the purchase order
- R. Minority and Women Business Enterprise (M/WBE) – Any business concern certified by the SDO as a bona-fide M/WBE. A bona-fide M/WBE is a business whose minority group/women ownership interests are real, which have at least 51% ownership and control over management and operation.
- S. Percent of Total Price – Is the percentage to be paid to the DBE, work they perform, as compared to the total bid price
- T. Recipient - An agency, person or political subdivision which has been awarded or received financial assistance by the Trust or MassDEP.
- U. Small business, small business concern or small business enterprise (SBE) - A concern, including its affiliates, that is independently owned and operated, not dominant in the field of operation in which it is bidding, and qualified as a small business under the criteria and size standards in 13 CFR part 121.
- V. Small business in a rural area (SBRA) - A small business operating in an area identified as a rural county with a code 6-9 in the Rural-Urban continuum Classification Code developed by the United States Department of Agriculture in 1980.
- W. SDO – The Supplier Diversity Office.
- X. Subcontractor – A company, firm, joint venture, or individual who enters into an agreement with a contractor to provide services pursuant to an award of financial assistance.
- Y. Total Contract Price – The total amount of compensation to be paid for all materials, work or services rendered in the performance of the contract
- Z. Trust – The Massachusetts Clean Water Trust established by M.G.L. c.29.

### **III. REQUIREMENTS FOR CONTRACT AWARD**

DBE packages must be submitted by the two lowest bidders on the project. Following bid opening, the LGU shall notify the two lowest bidders to submit DBE packages to the LGU or the LGUs consultant, as directed. By the close of business on the third business day after notification, the two lowest bidders, including a bidder who is a MBE, WBE or DBE, shall submit the following information:

- A. A Schedule of Participation (Form EEO-DEP-190). The Schedule of Participation shall list those certified DBEs the bidder intends to use in fulfilling the contract obligations, the nature of the work to be performed by each certified DBE subcontractor and the total price they are to be paid.
  - 1. A listing of bona-fide services such as a professional, technical, consultant or managerial services, assistance in the procurement of essential personnel, facilities, equipment, materials, or supplies required for performance of the contract, and reasonable fees or commissions charged.
  - 2. A listing of haulers, truckers, or delivery services, not the contractors, including reasonable fees for delivery of said materials or supplies to be included on the project.
- B. A Letter of Intent (Form EEO-DEP-191) for each DBE the bidder intends to use on the project. The Letter of Intent shall include, among other things, a reasonable description of the work the certified DBE is proposing to perform and the prices the certified DBE proposes to charge for the work. A Letter of Intent shall be jointly signed by the certified DBE and the General Contractor who proposes to use them in the performance of the Contract.
- C. Each DBE must also sign and return the DBE Certification of United States Citizenship form to verify that the firm is owned or controlled by a United States citizen.
- D. The SDO “DBE Certification” as prepared by each certified DBE.
- E. A completed Request for Waiver form and backup documentation should the goals not be achieved (See IV below).

### **IV. REQUIREMENTS FOR MODIFICATION OR WAIVERS.**

The bidder shall make every possible effort to meet the minimum requirements of certified DBE participation. If the percentage of DBE participation submitted by the bidder on its Schedule of Participation (EEO-DEP-190) does not meet the minimum requirements, the bid may be rejected by the Awarding Authority and found not to be eligible for award of the contract.



In the event that the bidder is unable to meet the minimum requirements of DBE participation, the bidder shall submit with his/her submittal required in Section III. Requirement of Contract Award a Request for Waiver form (EEO-DEP-490). The Awarding Authority shall review the waiver request to determine if the request should proceed. If approved by the Awarding Authority, the Awarding Authority shall submit the waiver request and supporting documentation, with a recommendation to MassDEP within five days of receipt of the Request for Waiver. MassDEP in conjunction with the project manager, Compliance Unit, will determine whether the waiver will be granted.

The waiver request shall include detailed information as specified below to establish that the bidder has made a good faith effort to comply with the minimum requirements of DBE participation specified in Part I. In addition, the bidder must show that such efforts were undertaken well in advance of the time set for opening of bids to allow adequate response. A waiver request shall include the following:

- A. A detailed record of the effort made to contact and negotiate with the certified DBE, including, but not limited to:
  1. names, addresses and telephone numbers of all such companies contacted;
  2. copies of written notices(s) which were sent to certified DBE potential subcontractors, prior to bid opening;
  3. a detailed statement as to why each subcontractor contacted (i) was not willing to do the job or (ii) was not qualified to perform the work as solicited; and
  4. in the case(s) where a negotiated price could not be reached the bidder should detail what efforts were made to reach an agreement on a competitive price;
  5. copies of advertisements, dated not less than ten (10) days prior to bid opening, as appearing in general publications, trade-oriented publications, and applicable minority/ women-focused media detailing the opportunities for participation.
- B. MassDEP may require the bidder to produce such additional information as it deems appropriate.
- C. No later than fifteen (15) days after MassDEP receives all required information and documentation, it shall make a decision in writing, whether the waiver is granted and shall provide that determination to the bidder and Awarding Authority. If the waiver request is denied, the facts upon which a denial is based will be set forth in writing. If the waiver request is denied, the bid shall be rejected by the Awarding Authority, or the contract will be determined ineligible for SRF funding.

If a Request for Waiver is denied by MassDEP and the bid is rejected by the Awarding Authority, the Awarding Authority may then move to the second bidder on the project. At the Awarding Authority's discretion, it may collect a DBE package from the third bidder on the project.

## **V. DISADVANTAGED BUSINESS ENTERPRISES PARTICIPATION**

### **A. Reporting Requirements**

1. The Contractor's utilization of certified DBEs will be documented based upon submittal of the LGU's monthly Payment Requisitions as reported on Form-2000. The Form-2000 form will show all certified DBEs performing work on the project regardless of any billing activity for that month. For auditing and accounting purposes, the Contractor periodically may be required to submit copies of canceled checks verifying that payments have been made to the certified DBE as listed on the schedule. The Contractor may also be required to submit current schedules on utilization of all DBEs to indicate when their services will commence and be billed for.
2. During the life of the Contract, the Contractor's fulfillment of the percentage requirements in Part I shall be determined with reference to the Contract price as follows:
  - A. If the price in the Contract executed exceeds the base bid price (e.g., because an alternate was selected or because unit prices were used in awarding the Contract), the Contractor shall submit for approval by MassDEP a revised Schedule of Participation by certified DBEs satisfying the percentage requirements and such other information concerning additional DBE participation as may be requested by MassDEP.
  - B. If the Contract price increases after execution due to change orders or other adjustments, MassDEP may require the Contractor to subcontract additional work or to purchase additional goods and services from certified DBEs up to the percentages stated in Part I.

## **VI. COMPLIANCE**

- A. If the Schedule or any of the Letters of Intent are materially incomplete or not submitted in a timely manner, the LGU may rescind its vote of award; treat the bid informal as to substance and reject the bid. If the bid is incomplete in any other respect than the Schedule the LGU with the approval of MassDEP may waive the informalities upon satisfactory completion of the required information by the Contractor and the certified DBE as applicable.
- B. If the LGU finds that the percentage of certified DBE participation submitted by the contractor on its Schedule does not meet the percentage requirement in Part I, it shall rescind its vote of award and find such contractor not to be eligible for award of the contract.

- C. The Contractor shall not perform with its own organization, or subcontract to any other primary or subcontractor any work designated for the named certified DBEs on the schedule submitted by the Contractor under Part III without the approval of MassDEP.
- D. A Contractor's compliance with the percentage requirement in Part I shall continue to be determined by reference to the required percentage of the total contract price as stated in Section I even though the total of actual contract payments may be greater or less than the bid price.
- E. If the Contractor for reasons beyond its control cannot comply with Part III in accordance with the Schedule submitted under Part III, Section B, the contractor must submit to MassDEP as soon as they are aware of the deficiency, the reason for its inability to comply. Proposed revisions to the Schedule stating how the contractor intends to meet its obligations under these conditions must be submitted within ten (10) working days of notification.
- F. If the Contractor becomes aware by any means that that DBE is no longer certified, the Contractor shall immediately notify MassDEP. The Contractor shall use good faith efforts to retain a substitute certified DBE.
- G. If a certified DBE listed by the bidder in its Schedule of M/WBE contractors fails to obtain a performance or payment bond requested by the bidder, said failure shall not entitle the bidder to avoid the requirements of Part III (A). After a bidder has been awarded the contract, he shall not change the certified DBE listed in its Schedule at the time of the award or make any other such substitutions without the written approval of MassDEP.

## **VII. SANCTIONS**

- A. If the Contractor does not comply with the terms of these Special Provisions, the Awarding Authority may (1) suspend any payment for the work that should have been performed by a certified DBE pursuant to the schedule, or (2) require specific performance of the Contractor's obligation by requiring the Contractor to subcontract with a DBE for any contract or specialty item at the contract price established for that item in the proposal submitted by the Contractor.
- B. To the extent that the Contractor has not complied with the terms of these Special Provisions, the Awarding Authority may retain in connection with Estimates and Payments an amount determined by multiplying the bid price of this contract by the percentage in Section I, less the amount paid to DBE's for work performed under the contract and any payments already suspended under VII A.
- C. The Awarding Authority may suspend, terminate or cancel this contract, in whole or in part, or may call upon the Contractor's surety to perform all terms and conditions in the contract, unless the contractor is able to demonstrate his compliance with the terms

of these Special Provisions, and further deny to the Contractor, the right to participate in any future contracts awarded by the Awarding Authority for a period of up to three years.

- D. In any proceeding involving the imposition of sanctions by the Awarding Authority, no sanctions shall be imposed if the Awarding Authority finds that the contractor has taken every possible measure to comply with these Special Provisions or that some other justifiable reason exists for waiving these Special Provisions in whole or in part.
- E. The contract shall provide such information as is necessary in the judgment of the Awarding Authority to ascertain its compliance with the terms of these Special Provisions.
- F. A contractor shall have the right to request suspension of any sanctions imposed under this section upon demonstrating that he is in compliance with these Special Provisions.

DISADVANTAGED BUSINESS ENTERPRISE PARTICIPATION  
 MASSACHUSETTS DEPARTMENT OF ENVIRONMENTAL PROTECTION  
 DIVISION OF MUNICIPAL SERVICES

**SCHEDULE OF PARTICIPATION FOR SRF CONSTRUCTION**

**Project Title:** \_\_\_\_\_ **Project Location:** \_\_\_\_\_

**Disadvantaged Minority Business Enterprise Participation in the SRF Loan Work**

Name & Address of D/MBE	Nature of Participation	Dollar Value of Participation
1.		
2.		
3.		
<b>Total D/MBE Commitment:</b>		<b>\$</b>
<b>Percentage D/MBE Participation = (Total D/MBE Commitment) / (Bid Price) =</b>		<b>%</b>

**Disadvantaged Women Business Enterprise Participation in the SRF Loan Work**

Name & Address of D/WBE	Nature of Participation	Dollar Value of Participation
1.		
2.		
3.		
<b>Total D/WBE Commitment:</b>		<b>\$</b>
<b>Percentage D/WBE Participation = (Total D/WBE Commitment) / ( Bid Price) =</b>		<b>%</b>

The Bidder agrees to furnish implementation reports as required by MassDEP to indicate the D/MBEs and D/WBE(s) which it has used or intends to use. Breach of this commitment constitutes a breach of the contract.

Name of Bidder: \_\_\_\_\_

Date: \_\_\_\_\_ By: \_\_\_\_\_  
Signature

NOTE: Participation of a DBE may be counted in only their certified category; the same dollar participation cannot be used in computing the percentage of D/MBE participation and again of D/WBE participation.

**LETTER OF INTENT FOR SRF CONSTRUCTION**

This form is to be completed by the D/MBE and D/WBE and must be submitted by the Bidder no later than close of business on the third business day after notification by the LGU. A separate form must be completed for each D/MBE and D/WBE involved in the project.

Project Title: \_\_\_\_\_ Project Location: \_\_\_\_\_

**TO:** \_\_\_\_\_  
(Name of Bidder)

**FROM:** \_\_\_\_\_  
(Please Indicate Status  D/MBE or  D/WBE)

° I/we intend to perform work in connection with the above project as (check one):

- An individual     A partnership  
 A corporation     A joint venture with: \_\_\_\_\_  
 Other (explain): \_\_\_\_\_

° It is understood that if you are awarded the contract, you intend to enter into an agreement to perform the activity described below for the prices indicated.

**DBE PARTICIPATION**

Description of Activity	Date of Project Commencement	\$ Amount	% Bid Price
		\$	%

° The undersigned certify that they will enter into a formal agreement upon execution of the contract for the above referenced project.

<b>BIDDER</b>		<b>DBE</b>	
(Authorized Original Signature)	Date	(Authorized Original Signature)	Date
ADDRESS:		ADDRESS:	
TELEPHONE #:		TELEPHONE #:	
FEIN:		FEIN:	
EMAIL ADDRESS:		EMAIL ADDRESS:	

**ORIGINALS:**

- ° Compliance Mgr. City/Town Project Location
- ° DEP Program Manager for DEP's AAO Director

**\* Attach a copy of current (within 2 years) DBE Certification**

EEO-DEP-191C

EEO-DEP-E Page 11 of 16

**DBE CERTIFICATION OF UNITED STATES CITIZENSHIP**

For the SRF program, under the EPA Disadvantage Business Enterprise (DBE) Rule, a DBE must be owned or controlled by a socially and economically disadvantaged person that is also a **citizen of the United States** (See 40 CFR 33.202). “Ownership” is defined at 13 CFR 124.105 and “control” is defined at 13 CFR 124.106.

DBEs are certified for the SRF program through the Supplier Diversity Office using the federal Department of Transportation (DOT) DBE rules. EPA allows the use of DBEs certified under the DOT rules as long as they are also United States citizens. To ensure compliance with the EPA rule, MassDEP must verify United States citizenship through the completion of the following form for each DBE used on the project.

SRF Project Number \_\_\_\_\_

Contract Number \_\_\_\_\_

Contract Title \_\_\_\_\_

DBE Subcontractor \_\_\_\_\_

The undersigned, on behalf of the above named DBE subcontractor, hereby certifies that the DBE firm is either owned or controlled by a person or persons that are citizens of the United States.

\_\_\_\_\_  
Printed Name and Title of DBE Signatory

\_\_\_\_\_  
DBE Signature

\_\_\_\_\_  
Date

**DISADVANTAGED BUSINESS ENTERPRISE**  
**PROGRAM DBE SUBCONTRACTOR PARTICIPATION**  
**FORM**

The United States Environmental Protection Agency (EPA) requires that this form be provided to all subcontractors on the project. At the option of the subcontractor, this form may be filled out and submitted directly to the EPA DBE Coordinator.

NAME OF SUBCONTRACTOR	PROJECT NAME
ADDRESS	CONTRACT NO.
TELEPHONE NO.	E-MAIL ADDRESS
PRIME CONTRACTOR NAME:	

Please use the space below to report any concerns regarding the above EPA-funded project (e.g., reason for termination by prime contractor, late payment, etc.).

---



---



---



---



---

CONTRACT ITEM NO.	ITEM OF WORK OR DESCRIPTION OF SERVICES RECEIVED FROM THE PRIME CONTRACTOR	AMOUNT SUBCONTRACTOR WAS PAID BY PRIME CONTRACTOR
<hr/> Subcontractor Signature		<hr/> Title/Date



**REQUEST FOR WAIVER FOR SRF CONSTRUCTION**

Upon exhausting all known sources and making every possible effort to meet the minimum requirements for DBE participation, the Bidder may seek relief either partially or entirely from these requirements by submitting a completed waiver package by the close of business on the third business day after notification by the LGU. Failure to comply with this process shall be cause to reject the bid thereby rendering the Bidder not eligible for award of the contract.

**General Information**

Project Title: \_\_\_\_\_ Project Location: \_\_\_\_\_  
Bid Opening (time/date) \_\_\_\_\_  
Bidder: \_\_\_\_\_  
Mailing Address: \_\_\_\_\_  
Contact Person: \_\_\_\_\_ Telephone No. \_\_\_\_\_

**Minimum Requirements**

The bidder must demonstrate that good faith efforts were undertaken to comply with the percentage goals as specified. The firm seeking relief must show that such efforts were taken appropriately in advance of the time set for opening bid proposals to allow adequate time for response(s) by submitting the following:

- A. A detailed record of the effort made to contact and negotiate with disadvantaged minority and/or woman owned businesses, including:
  - 1. names, addresses, telephone numbers and contact dates of all such companies contacted;
  - 2. copies of written notice(s) which were sent to DBE potential subcontractors prior to bid opening;
  - 3. a detailed statement as to why each subcontractor contacted (i) was not willing to do the job or (ii) was not qualified to perform the work as solicited; and
  - 4. in the case(s) where a negotiated price could not be reached the bidder should detail what efforts were made to reach an agreement on a competitive price.
  - 5. copies of advertisements, dated not less than ten (10) days prior to bid opening, as appearing in general publications, trade-oriented publications, and applicable minority/women-focused media detailing the opportunities for participation;

- B. MassDEP may require the bidder to produce such additional information as it deems appropriate.
- C. No later than fifteen (15) days after submission of all required information and documentation, MassDEP shall make a determination, in writing, whether the waiver request is granted and shall provide that determination to the bidder and Awarding Authority. If the waiver request is denied, the facts upon which a denial is based will be set forth in writing.

CERTIFICATION

The undersigned herewith certifies that the above information and appropriate attachments are true and accurate to the best of my knowledge and that I have been authorized to act on behalf of the bidder in this matter.

---

(authorized original signature)

---

DATE

DISADVANTAGED BUSINESS ENTERPRISE PARTICIPATION  
MASSACHUSETTS DEPARTMENT OF ENVIRONMENTAL PROTECTION  
DIVISION OF MUNICIPAL SERVICES

STATE REVOLVING FUND LOAN PROGRAM – SCHEDULE OF SUBCONTRACTOR PARTICIPATION

Local Governmental Unit \_\_\_\_\_  
Project Name \_\_\_\_\_  
SRF Identification Number \_\_\_\_\_  
General Contractor \_\_\_\_\_  
Contract Value \_\_\_\_\_

The United States Environmental Protection Agency (EPA) requires that all SRF borrowers develop and maintain a list of all MBE/WBE and non MBE/WBE subcontractors on the project.  
This form must be completed and returned to MassDEP within 90 days of award of the contract.

Subcontractor	Point of Contact	Mailing Address	Telephone Number	E-Mail Address	MBE	WBE	DBE	Subcontract Value

**DEPARTMENT OF ENVIRONMENTAL PROTECTION**  
**BUREAU OF RESOURCE PROTECTION**  
**DIVISION OF MUNICIPAL SERVICES POLICIES**

The Division of Municipal Services (DMS) has established the following policies for all Division financially-assisted projects.

**POLICY MEMORANDUM NO. CG-1**

**EASEMENTS AND RIGHTS OF WAY**

Prior to the approval of financial assistance for construction, the owner shall obtain and shall thereafter retain, a fee simple or such estate or interest in the site of construction and rights of access as will assure undisturbed use and possession for the purpose of construction and operation for the estimated life of the project. The Division may refuse to approve financial assistance until it has received from the owner sufficient assurances that such interests have been obtained. Unless the Division otherwise notifies the owner, the certificate (under pains and penalties of perjury) of the owner's legal representative shall constitute such sufficient assurance.

Additional cost which result from interruptions of construction or extensions of contract time caused by the owner's failure to obtain the necessary interests in land shall be ineligible for financial assistance, and all such additional costs shall be borne by the owner.

**POLICY MEMORANDUM NO. CG-2**

**PERMITS**

The owner shall be responsible for identifying and obtaining all federal, state, local and railroad permits required by the nature and location of construction, including but not limited to building construction permits and permits for street and highway cuts and openings, and all such permits shall be listed in a separate permits section of the contract documents. To the extent possible, such permits shall be obtained by the owner prior to the solicitation of bids for construction, and copies of all permits so obtained shall be included in the said permits section. The status of the application for each permit, including the permit conditions, and costs, not obtained prior to the solicitation of bids shall also be indicated in the contract documents permits section. The Division may refuse to approve financial assistance for construction unless and until it has received from the owner sufficient assurances that all necessary permits have been or will be obtained prior to the commencement of construction.

The contractor shall be responsible for obtaining all permits required of his equipment, work force, or particular operations (such as blasting) in the performance of the contract and not otherwise specified in the two preceding paragraphs as to be obtained by the owner. These permit fees shall be paid by the contractor.

The owner shall be responsible for the payment of all other permit fees required by the construction.

The following permits shall not be eligible for financial participation by the Department of Environmental Protection (DEP).

- Permits and insurance for construction in railroads' rights of way;
- Building permits;
- Permits for opening public streets and other public or municipal rights of way;
- Permits for the use of explosives;
- Permits for the disposal of waste materials;
- Permits and fees for connecting to municipal utilities.

Permits required by extraordinary circumstances and not specifically excluded from eligibility above may be eligible for DEP participation. For such permits to be so eligible, the owner or his representative must notify the DEP project engineer in advance of obtaining such permit and receive from the engineer specific agreement that such permit will be eligible for DEP participation. Eligibility for such participation will not be made retroactively.

Additional costs which result from interruptions of construction or extensions of contract time resulting from the owner's or the contractor's failure to obtain the necessary permits may be ineligible for participation.

**POLICY MEMORANDUM NO. CG-3**

**FIELD CONTROLS**

The Owner shall be responsible for indicating on the contract drawings all easement limits and all property and other control lines for locating the principal component parts of the work together with those elevations and bench marks used in the design of the work, all hereinafter referred to as "field controls". Where easement and property limits have not previously been established in the field, the owner shall be responsible for establishment of such limits. From the information provided by the Owner, unless otherwise specified, the Contractor shall develop and make all layouts required for construction, such as slope stakes, batter boards, stakes for pipe locations and other working points, lines, elevations and cut sheets.

Whenever he has reason to believe that an error exists or whenever he is otherwise unable to locate the field controls, the contractor shall promptly notify the owner and the owner's engineer of such error with appropriate documentation.

**POLICY MEMORANDUM NO. CG-4**

**RECORD DRAWINGS:**

The Owner shall be responsible for the preparation of all record drawings required by this contract. This responsibility may be delegated to the Owner's representative. The responsibility for preparation of record drawings shall not be delegated or transferred to the contractor. They may use the contractor's and sub-contractor's certified AS BUILT drawings along with their own marked up set in the preparation of the Record Drawings.

Division approved contract drawings shall be revised upon completion of the contract to reflect any changes made and/or final quantities, as appropriate.

**POLICY MEMORANDUM NO. CG-5**

**PLAN SCALE**

Unless otherwise approved in advance by the Division, the horizontal scale for construction plans for non-structural facilities shall be 1" = 40'. A larger horizontal scale shall be used where appropriate to show sufficient detail to construct the project. The vertical scale for construction plans for non-structural facilities shall be 1" = 4'. Based on the best information available at the time of their preparation, the location of underground utilities and support structures for overhead utilities shall be shown on the plans.

Unless otherwise exempted in advance by the Division, construction plans shall be updated whenever the date of the advertisement for bids for the construction of such facilities is more than one year after the date of approval by the Division or EPA; and in the case of approval by both such agencies, the later approval date shall be used in determining the need for update.

The consulting engineer shall receive adequate compensation for updating plans and specifications, and such additional cost shall be eligible for assistance to the extent not otherwise prohibited by USEPA and Division regulations and program guidance.

All revision, or review without need for revision, shall be noted and dated on the plans prior to advertisement of the project for bid.

#### **POLICY MEMORANDUM NO. CG-6**

#### **BORINGS LOGS**

All soil borings shall be taken as close as practicable to the construction line, and the location of all such borings shall be clearly indicated on the contract drawings. The plan view shall show the location and boring number of each boring. The profile view shall show the location, elevation, and depth of each soil boring, the location of each change in soil stratum, the groundwater level, and the average of blow counts at each five foot interval. As a minimum, boring logs to be submitted with the plans and specifications shall show the name of the company taking the borings, the soil classification, the number of blows per foot of penetration, the groundwater elevation, and the date on which the borings were taken.

As part of the submission of plans and specification for approval, the owner's representative shall include written justification for the lesser frequency and depth of borings where their interval is more than approximately 300' or their depth is less than 50% below depth of pipe invert.

#### **POLICY MEMORANDUM NO. CG-7**

#### **BREAKDOWN OF BID ITEMS**

The following items shall, where applicable, be listed separately in the bid documents.

1. Mobilization
2. Pavement
  - a. Municipal
    - i. temporary
    - ii. permanent
  - b. State
    - i. temporary
    - ii. permanent
4. Rock-Excavation
5. Wood or steel sheeting left in place
6. Excavation of unsuitable materials below grade.
7. Select and/or borrow material
8. Dewatering
9. Special Dewatering (coffer dam)

3. Concrete cradle or encasement  
(to be identified where applicable)

Mobilization costs are the costs of initiating the contract, exclusive of the cost of materials. Payment for mobilization shall be a lump sum at the price bid for this item in the proposal and shall be payable when the contractor is operational on the site. For purposes of this policy, “operational” shall mean the substantial commencement of work on site.

The lump sum price bid for mobilization shall not exceed five per centum (5%) of the total amount of the bid.

**POLICY MEMORANDUM NO. CG-8**

**PAVEMENT**

All roads and trenches therein shall be refilled and repaved in accordance with specifications provided by the owner in the contract documents. Please note that this policy may be excludable on federally assisted projects where bid alternative items may be required (i.e. trench width vs. full width pavement). You are advised to seek project specific clarification.

Loan eligibility shall be limited to the following:

- A. Where the depth of the pipe invert is 0 to 8’, the maximum pavement widths which shall be eligible for financial assistance are as follows:

<u>Nominal Pipe Diameter</u>	<u>Maximum Eligible Widths</u>	
	<u>Initial Pavement</u>	<u>Permanent Trench</u>
0-24”	6’-6”	8’-6”

Where the nominal pipe diameter is greater than 24” the maximum eligible width for initial re-paving shall be the nominal diameter of the pipe plus four (4) feet, and for permanent trench re-paving the maximum eligible width shall be the nominal pipe diameter plus six (6) feet.

- B. For each additional four (4) feet (or fraction thereof) of pipe invert depth, add three feet to the eligible width limits stated in paragraph A.

At the design phase of a project the owner has the option to elect either Initial Pavement with Option I (Permanent Trench replacement) or Initial with Option II (curb to curb over initial)

### Initial Pavement

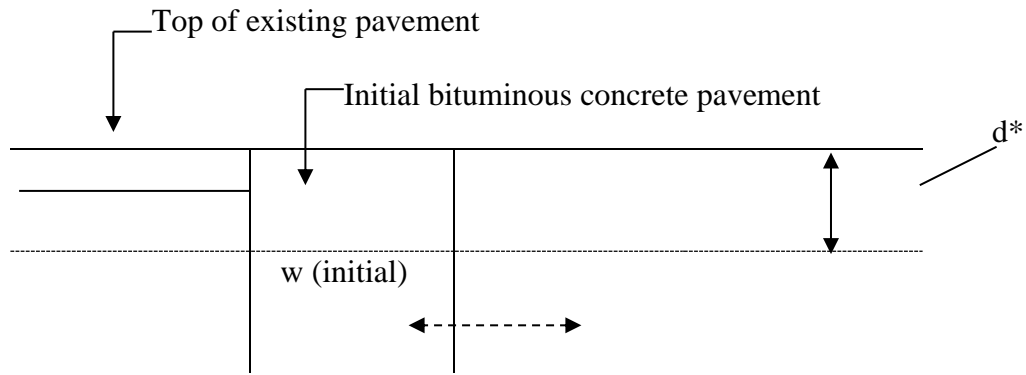

d\* = depth of existing pavement to a maximum of 3 inches (see general notes #3)  
w = maximum eligible Initial pavement width as described in paragraphs "A" & "B" on page DEP-DMS-CG's-P4.

### OPTION I Permanent Trench Pavement

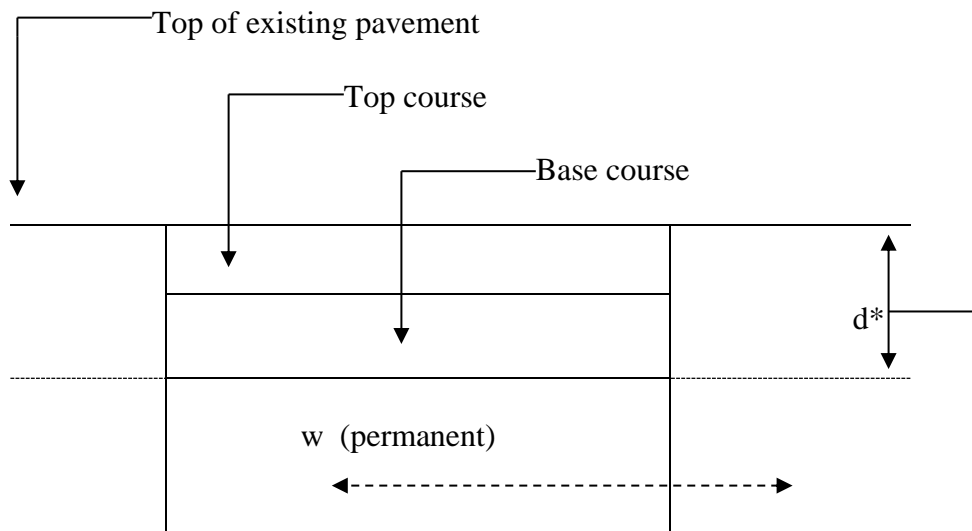

d\* = depth of existing pavement trench to a maximum of 3 inches (see general notes #3)  
w = maximum eligible permanent pavement width as described in paragraphs "A" & "B".  
equals initial width plus 2 feet and includes:

- Cutting edges for the permanent trench
- Removal of initial patch plus two feet of existing pavement
- Fine grading/compacting gravel
- Placement of Permanent Trench pavement in two courses.



OPTION II Curb to Curb Pavement (overlay pavement for roadways up to 28 feet)

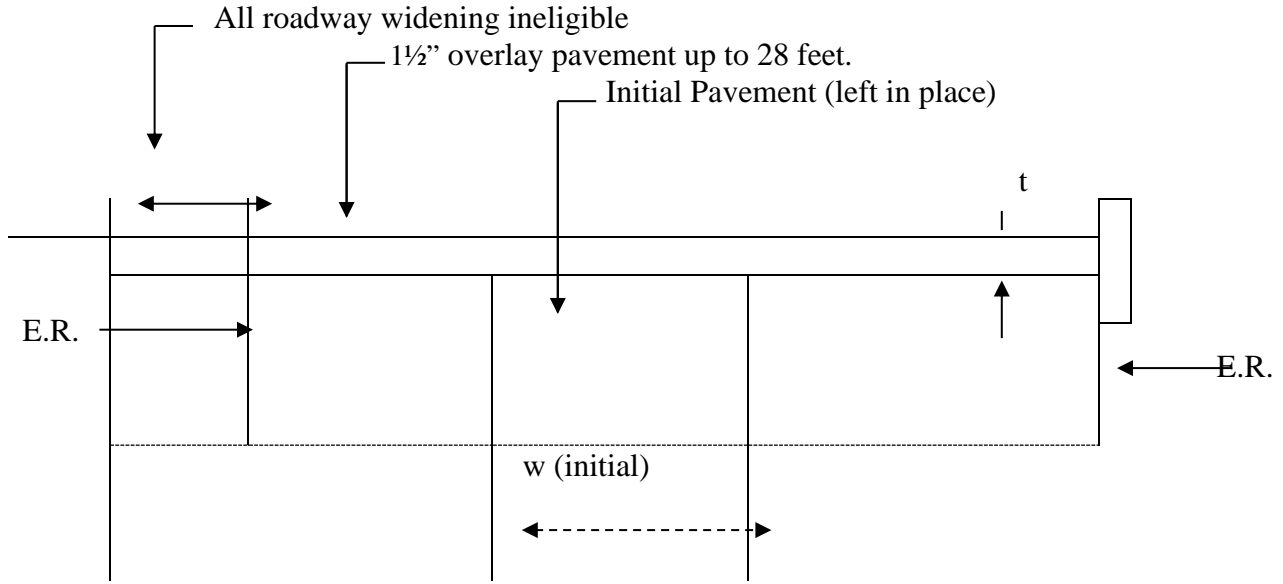

E.R.= edge of existing paved roadway

t = one and one half inch (1 1/2") overlay of bituminous concrete pavement

GENERAL NOTES:

1. Repavement of settled areas and crown restoration within the trench limits shall be the responsibility of the contractor.
2. Leveling outside the trench limits shall be the responsibility of the owner.
3. Sewer trench re-fill and pavement re-paving on public ways under the jurisdiction of the Massachusetts Department of Public Works, the Metropolitan District Commission, or other such agency shall be in accordance with permit(s) issued therefore by that Department or Commission, as the case may be.
4. The Division will consider requests for increase in the participating pay limits defined in paragraphs A and B, when such increases are, in the Division's opinion, reasonable. Such requests should be documented in writing and submitted to the Division in a timely manner.
5. Projects which deviate from the above options are required to seek Division review and approval.

**POLICY MEMORANDUM NO. CG-9**

**PIPE TESTING**

Monthly payment estimates shall be prepared in accordance with contract documents. All pipe shall be tested in accordance with the contract documents and sound engineering practice. If, after 60 days following submission of a monthly payment estimate for pipe items, the pipe for which payment is requested has not been successfully tested, the owner may withhold up to 10% of the amount requested for such pipe items until the pipe has been so tested. However, in the case of a major (pipe diameter 24 inches or greater) interceptor pipe installation, sums retained by the owner pursuant to this policy memorandum shall not exceed two per centum (2%) of the costs of such pipe items.

Executed change orders submitted to the Division for review and processing for financial assistance must be prepared on the attached Change Order Forms (CG-10, Attachment 1, pages A-1 & A-2) with a duplicate copy, calculation sheet(s) (CG-10, Attachment 2), and all other supporting documentation necessary for evaluation. Failure to comply with these instructions will result in delays in processing the change order and/or limited financial assistance.

M.G.L. c.44, s.31C requires that the auditor, accountant, or other municipal officer having similar duties must certify that adequate funding in an amount sufficient to cover the total cost of the change order has been made. Change orders will not be processed or approved until this certification is made on the face of the Change Order Form (CG-10 Attachment 1).

Payment of Change Orders:

Payment of all change orders shall be in accordance with the relevant provisions of Massachusetts General laws, Chapter 30, Section 39G for non-building construction and Section 39K for building construction.

Payment of change orders shall be made in accordance with one of the following three methods:

- A. Existing unit prices as set forth in the contract; or
  - B. Agreed upon lump sum or unit prices; or
  - C. Time and materials
- A. Payment for work for which there is a unit price in the contract:

Where the contract contains a unit price for work and the Engineer orders a change for work of the same kind as other work contained in the contract and is performed under similar physical conditions, the contractor may accept full and final payment at the contract unit price(s) for the acceptable quantities.

- B. Payment for work or materials for which no price is contained in the contract:

If the Engineer directs, the contractor shall submit promptly in writing to the Engineer and offer to do the required work on a lump sum or unit price basis, as specified by the Engineer. The stated price, either lump sum or unit price, shall be divided so as to show that it is the sum of:

- (1) The estimated cost of labor, plus
- (2) Direct Labor Cost, plus
- (3) Material and Freight Costs, plus
- (4) Equipment Costs, plus
- (5) An amount not to exceed 20% of the sum of items (1) through (4) for overhead and profit, plus (if applicable),
- (6) In the case of work done by a subcontractor and amount not to exceed 7 ½ %, for the general contractor of the sum of items (1) through (4) for his overhead and profit, less, if applicable,

- (7) Credits for work deleted from the contract.
- C.
- D. Payment for work on a time and materials basis:  
 Unless an agreed lump sum and/or unit price is obtained from above and is so stated in the change price, the contractor shall accept as full payment for which no other agreement is contained in contract, and amount equal to:
- (1) The estimated cost of Labor, plus
  - (2) Direct Labor Cost, plus
  - (3) Material and Freight Costs, plus
  - (4) Equipment Costs, plus
  - (5) An amount not to exceed 20% of the sum of items (1) through (4) for overhead and profit, plus (if applicable),
  - (6) In the case of work done by a subcontractor and amount not to exceed 7 ½ %, for the general contractor of the sum of items (1) through (4) for his overhead and profit, less, if applicable,
  - (7) Credits for work deleted from the contract.

Explanation of items (1) through (7) as outlined in “B” and “C”:

- (1) Labor – Only those workers employed on the project who are doing the extra work, including the foreman in charge, are allowable. General foremen, superintendents, or other supervisory personnel are considered to be included in the overhead markup as provided in items (5) and/or (6). Hourly labor rates in excess of those as listed in the contract wage rates (Federal or State, whichever applies require documentation. As a minimum, an explanation and the appropriate copy of the certified payroll are required.
- (2) Direct Labor Costs - These costs are limited to those which are required in the contract document. Coverage in excess of the contract provisions, secured by the contractor/subcontractor(s) at his option, are ineligible for financial assistance. The following list of typical direct labor charges is provided for your assistance and is in no way intended to be complete or all encompassing:
- Workman’s Compensation
  - Federal/State: Social Security Tax and Unemployment Tax;
  - Health, Welfare and Pension Benefits; (this cost is included in the wage rates appearing in the Mass. Wage Rates of the contract specifications)
  - Liability Insurance: Bodily Injury;
    - Excess Umbrella;
    - Property damage;
    - Public Liability
  - Blasters Insurance    If applied to any required
  - Builders Risk Insurance                                        direct labor costs.
  - Experience Modification Insurance
  - Surcharges

Following award and prior to execution of a construction contract, the contractor and filed sub-bidders (where applicable) shall submit for review by the owner, documentation to establish the Direct Labor Cost percentage(s) (Direct Labor markup percentage(s)).

The documented direct labor markup for this contract may be adjusted on an annual basis as measured from the date the contract is executed. The contract agreement will provide for the establishment of the Direct Labor Cost percentage.

- (3) Material and Freight – Only those materials required as a result of the change order and reasonable freight charges for delivery of same are allowable.
- (4) Equipment – Only the equipment required as a result of the change order is allowable. Equipment rental rates shall be governed by the current Nielson/Dataquest Rental Rate bluebook for Construction Equipment (the “Bluebook”). In determining the rental rate the following shall apply:
  - (a) For equipment already on the project – the monthly prorated rental rate by the hourly use shall be applicable;
  - (b) For equipment not on the project the daily rate, the weekly rate, or monthly rate will prevail, whichever will prove to be most cost effective. Small tools and manual equipment are examples of costs not allowable under this item. These costs are considered to be included in the overhead markup as provided in items (5) and/or (6)  
(1 month (normal use) = 176 hours)
- (5) & (6) Overhead and Profit – All other costs not previously mentioned are considered to be included in this item, be it for the general contractor or subcontractor(s).
- (7) Credits – Work deleted, material and equipment removed from the contractor, stored and/or returned shall be credited to the cost of the change order, less costs.

The Contractor shall furnish itemized statements of the cost of the work ordered and shall give the Engineer access to all accounts, bills and vouchers relating thereto; and unless the Contractor shall furnish such itemized statements, and access to all accounts, bills and vouchers, he shall not be entitled to payment for any items of extra work for which such information is sought by the Engineer. Deviations from any of the above will be reviewed for financial assistance on a case-by-case basis.

The change order will be prepared in such manner as to clearly separate Eligible and Ineligible Costs.

**CHANGE ORDER FORM**

SRF Number \_\_\_\_\_  
Public Entity \_\_\_\_\_  
Contract Number \_\_\_\_\_  
Change Order Number \_\_\_\_\_

Contract Amount (As Bid) \$ \_\_\_\_\_  
Net Change in Contract Price (this change order) \$ \_\_\_\_\_  
Total Adjusted Contract Price (including this and all other change orders) \$ \_\_\_\_\_

This change order extends the time to complete the work by \_\_\_\_\_ calendar days.

The extended completion date is \_\_\_\_\_

This change order checked by \_\_\_\_\_  
(Chief) Resident Engineer Date

This change order is requested by: \_\_\_\_\_

This change order is recommended by: \_\_\_\_\_

\_\_\_\_\_  
Consultant Engineer P.E. Number Date

The undersigned agree to the terms of the change order.

\_\_\_\_\_  
Contractor Date

\_\_\_\_\_  
Owner Date

Certification of Appropriation under M.G.L. c.44, §31C: Adequate funding in an amount sufficient to cover the total cost of this change order is available.

By: \_\_\_\_\_  
Certification Officer (Auditor, accountant, treasurer) Date

Do not write below: this space reserved for STATE AGENCY APPROVAL

CHANGE ORDER FORM (Continued)

Public Entity \_\_\_\_\_

SRF No: \_\_\_\_\_ Contract No. \_\_\_\_\_ Change Order No. \_\_\_\_\_

Contract Title: \_\_\_\_\_

Owner's Name: \_\_\_\_\_

Owner's Address: \_\_\_\_\_

Contractor's Name: \_\_\_\_\_

Contractor's Address: \_\_\_\_\_

Description of Change

\_\_\_\_\_  
\_\_\_\_\_  
\_\_\_\_\_  
\_\_\_\_\_  
\_\_\_\_\_  
\_\_\_\_\_  
\_\_\_\_\_  
\_\_\_\_\_

Reason for Change

\_\_\_\_\_  
\_\_\_\_\_  
\_\_\_\_\_  
\_\_\_\_\_  
\_\_\_\_\_  
\_\_\_\_\_  
\_\_\_\_\_  
\_\_\_\_\_  
\_\_\_\_\_  
\_\_\_\_\_

CALCULATION SHEET

(1)	Labor			
	Foreman	10 hrs @ \$10.00/hr.	\$	100.00
	Engineer	10 hrs @ 8.50/hr		85.00
	Operator	10 hrs @ 9.50/hr		95.00
	Laborers	24 hrs @ 7.00/hr		<u>168.00</u>
				\$448.00
(2)	Direct Labor Cost (use the agreed upon Direct Labor Cost)			
	*	(30)% of \$448		
	*	(Used for example purposes only)		134.00
(3)	Materials & Freight			
	150 l.f. of 12" pipe @ \$2.00/l.f.		\$	300.00
	15 v.f. precast SMH			1,700.00
	Freight (slip # _____ Enclosed)			<u>25.00</u>
				2,025.00
(4)	Equipment			
	1 Backhoe	10 hrs @ \$80.00/hr	\$	800.00
	1 Truck-crane	10 hrs @ \$100.00/hr		<u>1,000.00</u>
				<u>1,800.00</u>
		Total (Items 1 through 4)		4,407.00
(5)	20% markup for Overhead, Profit			
	20% of \$4,407			881.00
(6)	7 ½% markup for general contractor (if subcontractor is involved)			
	7 ½% of \$4,407			331.00
(7)	Credits (deductibles)			<u>- 323.00</u>
		Total Cost	\$	5,296.00

Reminder: Provide support documentation as necessary i.e. vouchers, correspondence, Calculation, photographs, reports .....

**POLICY MEMORANDUM NO. CG-11**

**UTILITY RELOCATION**

The construction of treatment facilities, sewers, pumping stations, force mains and appurtenant work can cause the relocation of utilities. Costly relocation can sometimes be minimized by early communication and cooperation of the representatives of the municipality (owner) and the utilities.

Every possible effort should be made by the owner and each utility to establish the location of existing utilities in the vicinity of the proposed construction. The owner or its consulting engineer should make every reasonable effort to design the proposed construction so that relocation of existing utilities is minimized whenever possible. If the proposed construction is in an area of many existing utilities or in an otherwise critical area, the utilities are encouraged to mark the location of their existing utilities at the site during the design phase of the project.

During the design phase of the project, the municipality should provide timely notice to all utilities known or thought to have facilities in or proximate to the site of such future construction.

**POLICY MEMORANDUM NO. CG-12**

**REFUNDABLE DEPOSITS FOR  
PLANS AND SPECIFICATIONS**

For each set of project plans and specifications provided, the owner may require a deposit in form of cash or other appropriate security, in an amount sufficient to cover the costs of production of such plans and specifications.

Upon return of the plans and specifications to the owner within a reasonable time and in good condition, such deposit shall be refunded.

Actual mailing costs, if any, shall be borne by the party requesting such plans and specifications.

**POLICY MEMORANDUM NO. CG-13**

**BID OPENING PROCEDURES**

As a minimum, bid documents shall be reviewed/inspected for conformance to the following bid opening procedure in the order presented below. Failure to comply with any of these steps shall render the bid non-responsive and upon determination of such non-responsiveness, such bid shall be rejected immediately, set aside, and shall receive no further consideration.

**Bid Opening Procedure**

Step #1. Timeliness – The bid must be filed at the place and within the time specified therefore in the invitation to bid, and no bid shall be accepted after such time. The time at which a bid is filed should be time/date stamped or otherwise prominently noted on the bid;

Policy Memorandum No. CG-13 – Bid Opening Procedures (Con't)

Step #2. Bid Security – Properly executed bid security, in the amount and terms specified in the invitation to bid (equal to 5% of Base Bid or Highest Possible Amount considering all alternatives) shall be placed in a seal envelope and attached to the outside of the envelope containing the bid at the time of its submission;

A. Bid Bond



The Bid bond must be dated On or Before the Bid Date;  
Issued by a Bonding Company Licensed in Massachusetts;  
Accompanied by a Current Power of Attorney;  
Signed by Surety;

B. Check

The Check must be a Certified, Cashiers or Bank Treasurer's;  
Dated On or Before the Bid Date;

Step #3. Bid Signature – The bid and all accompanying documents so required shall be signed by the bidder or its authorized representative before submission;

Step #4. Addenda – All addenda shall be sent certified mail, return receipt requested, by the owner to all individuals and organizations which have received plans and specifications and shall be mailed not later than five days prior to the date established for submission of bids. All bidders shall include with their bids written acknowledgement of receipt of all addenda, which acknowledgement may be on a form provided therefore by the owner.

Alternates – Any Alternates shall be acknowledged.

Step #5. Written Dollar Amounts – The total dollar amount of each bid shall be read, and the three lowest bids shall be selected for further consideration. The remaining bids shall then be set aside. The three apparent low bids shall be read to determine whether the unit price for each line item of each bid has been written therein in words. If it has not, such bid shall be rejected and shall receive no further consideration. ***Bid amounts shall be consistent (words vs. numbers) and if words and numbers differ, the words govern.*** This procedure shall then be repeated with the next apparent low bid until three are acceptable which have all the unit prices written in words, at which time the lowest bid shall be announced as the apparent low bidder, and the bid opening procedure shall be closed.

The Division recommends that this policy memorandum be included in all contract specifications and that the owner's evaluator(s) use the attached form (CG-13 Attachment #1) for bid opening procedures.

The Contractor's Bid Opening Checklist also attached hereto, is for use by each contractor to assure that his bid conforms with this policy memorandum. It is recommended that the checklist (CG-13 Attachment #2) be included in information for bidders, or at the end of the bid proposal, or in some other prominent part of the bid specifications

**FORM FOR BID OPENING PROCEDURES**  
(to be completed by the owner's evaluator(s))

CONTRACT NO.: \_\_\_\_\_

DATE: \_\_\_\_\_

CONTRACT NAME: \_\_\_\_\_

BID OPENING TIME: \_\_\_\_\_

All non-responsive bids shall be rejected forthwith by the awarding authority upon determination of such bids' non-responsiveness at the time bids are opened and read. Failure to comply with any one of the requirements shall render the bid non-responsive, and upon determination of such non-responsiveness such bid shall be rejected and receive no further consideration.

A = Acceptable

N-R = Non-Responsive (explain reasons on supplemental sheet & attach)

BIDDER	1. TIMELINESS	2. BID SECURITY	3. SIGNATURE	4. ADDENDA ALTERNATIVES	5. WRITTEN DOLLAR AMOUNTS	COMPLIANCE (CIRCLE ONE)	
						YES	NO
1						YES	NO
2						YES	NO
3						YES	NO
4						YES	NO
5						YES	NO
6						YES	NO
7						YES	NO
8						YES	NO
9						YES	NO
10						YES	NO
11						YES	NO
12						YES	NO

DEP/DMS

Evaluator(s) \_\_\_\_\_

\_\_\_\_\_

\_\_\_\_\_

**BID OPENING PROCEDURES**

**CONTRACTORS CHECKLIST**

CONTRACT NO.: \_\_\_\_\_ BIDDER: \_\_\_\_\_ DATE: \_\_\_\_\_

All non-responsive bids shall be rejected forthwith by the awarding authority upon determination of such bids' non-responsiveness at the time bids are opened and read. Failure to comply with one or more of the following requirements shall render the bid non-responsive, and upon determination of such non-responsiveness such bid shall be rejected and receive no further consideration.

ITEM	REQUIREMENTS	COMPLIANCE (CIRCLE 1)		REASONS FOR REJECTION
		Yes	No; Rejected	
1. Timeliness	Bid filed w/in time specified	Yes	No; Rejected	
2. Bid Security	Appropriate and properly Executed security w/bid.	Yes	No; Rejected	
3. Signature	Bid signed by authorized Representative	Yes	No; Rejected	
4. Addenda	All addenda acknowledge Any alternative	Yes	No; Rejected	
5. Dollar Amount	Dollar amount in words Specified for each line item in bid	Yes	No; Rejected	

There shall be in the contract documents a separate pay item for rock excavation. For such purposes, “rock” shall mean igneous, sedimentary, metamorphic, and conglomerate rock, which for excavation must be drilled, blasted, broken, or ripped by power tools. Boulders and concrete structures one cubic yard or greater, however removed, are included within this definition of rock for payment purposes. At the option of the owner or his representative a separate pay item for boulders, concrete structures, or concrete road base may be used.

<u>Depth From Ground Surface</u>	<u>Pay Width</u>	
<u>To Invert Pipe</u>	<u>(Nominal Pipe Diameter)</u>	
	<u>0-24”</u>	<u>Over 24”</u>
* 0 – 12’	5’0”	D+3’0”
* Over 12’ – 20’	7’0”	D+5’

Engineer’s plans and specifications shall establish pay limits below pipe and structures.

- See CG-14 Attachment #1 (typical cross section)

Payment width for depths over twenty feet (20’) shall be determined on a case-by-case basis consistent with the foregoing chart.

The pay limit for rock removal outside proposed manholes shall commence one foot (1’) outside the widest dimension of the structure of shall be the maximum connecting trench width, whichever is greater.

Payment depth for rock which is encountered in a trench shall be no less than three feet (3’) when removal can be accomplished only by drilling and blasting or by use of jack (air or hydraulic) hammers.

Payment for rock removed, using the same or equal equipment as utilized for normal trench excavation, shall be limited to the actual depth removed within the limits established by the contract documents.

Boulders encountered within the pay limits of excavation, whose volume is one cubic yard or greater, part of which extends outside said limits shall be paid in accordance with the actual volume excavated.

# CG-14 ROCK EXCAVATION

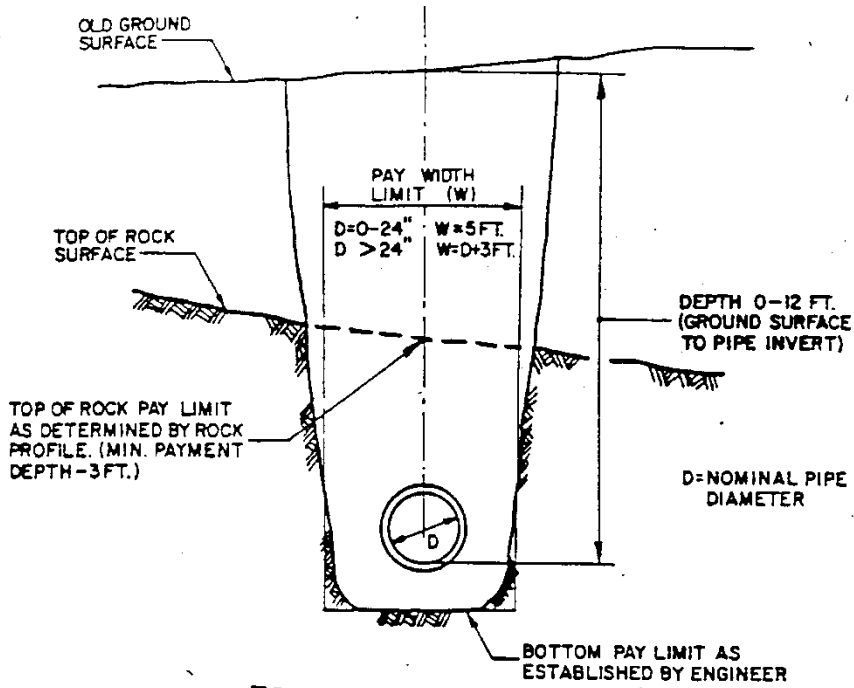

FOR DEPTH 0 TO 12 FEET

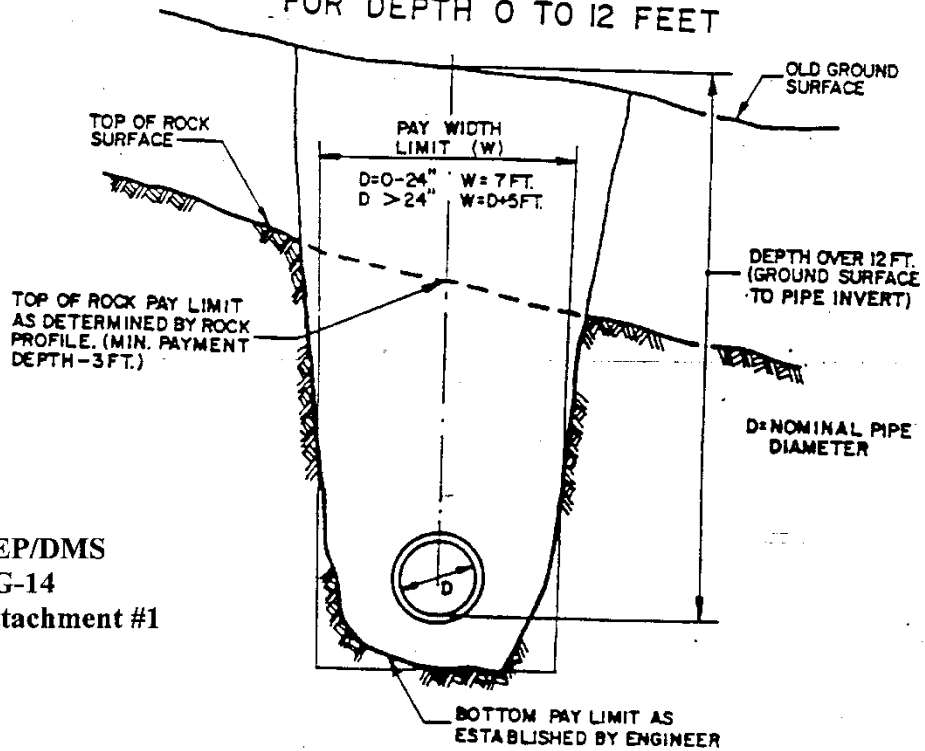

FOR DEPTH OVER 12 FEET AND UP TO 20 FEET

DEP/DMS  
CG-14  
Attachment #1

**POLICY MEMORANDUM NO. CG-15**

**TRAFFIC POLICE**

The reasonable costs for police details required for traffic control on a construction project which receives financial assistance shall be considered as an eligible administrative cost. A police detail item shall not be included as a bid item in the contract documents.

“Police” as used in this memorandum includes local, county, capital, state, regular and auxiliary police.

**Owner’s Responsibility**

It shall be the owner’s responsibility to submit in writing the hourly rate of pay to be established for detailed traffic police and each change in rate during the course of the project. It is the owner’s responsibility to arrange, document and pay for such police details. The owner or its representative shall meet with the police chief or other officer in charge of police detail duty to review contract needs. The owner shall maintain a daily record of the following:

- a. Officer’s name
- b. Hours worked
- c. Location of assignment
- d. Hourly rate

**POLICY MEMORANDUM NO. CG-16**

**DOCUMENTATION REQUIRED TO  
SUBSTANTIATE CONTRACT QUANITITES**

<u>Unit</u>	<u>Documentation required</u>
Acres (A)	Location, station, offset and calculations. Location = Street right-of-way, etc; Station = Point on Baseline; Offset = Distance left or right of Baseline
Cubic Yard (C.Y.)	Location, stations, widths, depths, calculations and Cross sections as necessary
Each (Ea.)	Location, station, and offset.
Gallon (Gal.)	Location, stations, calculations (if appropriate) and delivery slips.
Hour (Hr.)	Hours and location.
Linear Feet (L.F.)	Location, stations, and offsets.
Month (Mo.)	Location, period of time and calculations if applicable.

1000 Foot Board Measure

(MFBM)	Location, stations, offset, elevations, grade, and calculations. Attach invoices where applicable.
Pound (Lb.)	Locations, stations, and calculations (if applicable). Attach Delivery weight slips.
Square Feet (S.F.)	Locations, stations and calculations
Square Yard (S.Y.)	Locations, stations and calculations
Ton	Locations, stations and calculations (if applicable). Attach Delivery weight slips.
Vertical Feet (V.F.)	Locations, stations, elevations, and offsets.

Note:

1. All of the above, that apply must be submitted with a final payment request or change order as applicable.
2. Where in place measurement is not possible or practical, delivery slips may be used to substantiate quantities.
3. Change orders – See CG-10 in which some of the above may be applicable in justifying materials, equipment and labor.
4. When necessary, itemized quantities must be separated into eligible and non-eligible units with separate calculations to justify eligible costs.
5. Overruns and underruns of any specific item shall be explained with an appropriate sentence or paragraph.
6. On all quantities, units of payment shall be maintained at the project site and shall be updated daily so that upon field inspection by the C.O.E., EPA or DMS, the quantities paid to date can be substantiated.
7. In the case of unforeseen conditions, photos should be submitted with the applicable item in addition to the recommended documentation.
8. Documentation of units of payment shall be clearly legible and cross referenced to the applicable sheets of the record drawings.
9. For record drawings policy, please see CG-4.

---

DMS Policies 1 through 16 Approved By:

Steven J. McCurdy  
Division of Municipal Services

**DWS POLICY 88-02**

**DEPARTMENT OF ENVIRONMENTAL PROTECTION**

## **POLICY FOR REVIEW OF SEWER LINE/WATER SUPPLY PROTECTION**

The Department of Environmental Protection seeks to protect existing and potential water supplies from the potentially negative effects of leaking sewer lines through the adoption of a Department policy on this subject.

The following restrictions will apply to new sewer construction statewide:

### Gravel Packed Wells

- ~ Within the 400 foot radius protective distance around gravel packed wells, all sewer lines and appurtenances are prohibited, unless they are necessary to eliminate existing and/or potential sources of pollution to the well.

### Tubular Wells

- ~ Within the 250 foot radius protective distance around tubular wells, all sewer lines and appurtenances are prohibited, unless they are necessary to eliminate existing and/or potential sources of pollution to the well.

### Gravel Packed and Tubular Wells

- ~ Within a minimum radius of 2,640 feet or unless otherwise documented by an appropriate study specifically defining the area of influence and approved by the Division of Water Supply, all sewer lines and appurtenances will be designed and constructed for maximum water tightness.
- Force Mains or Pressure Sewers: shall be tested at 150% above maximum operating pressure or 150 p.s.i. whichever is greater. Testing shall conform to the requirements of the American Water works Association (AWWA) standard c 600.
- Gravity Sewers: shall be tested by approved methods which will achieve test results for infiltration or exfiltration of less than 100 gallons/inch diameter/mile/24 hours.
- Manholes: shall be installed with watertight covers with locking or bolted and gasketed assemblies. Testing for infiltration/exfiltration shall conform to the same standards as the maximum allowed for pipes in the manhole as required for gravity sewers, indicated above.
- Satisfactory test results for Force Mains, Manholes and Gravity Sewers shall be performed prior to the expiration of the contractor's one year guarantee period.
- All pumping stations within this zone shall have standby power high water alarms telemetered to an appropriated location that is manned at all times. An emergency contingency plan must be developed by the owner and approved by the BRP.
- A minimum of Class B bedding as defined by WPCF-MOP9 must be used for all piping.
- Service connections (laterals and house connections) shall be rigidly inspected by the appropriate municipal official. Certified inspection reports shall be submitted to the BRP.

### Bedrock Wells

The above requirements are the same for bedrock wells, with the Department reserving the right to require more stringent controls on a case-by-case basis.

### Surface Water Supplies



- ~ Within 100 feet of all surface water supplies and tributaries all sewer lines and appurtenances are prohibited except as required to cross tributaries or to eliminate existing or potential pollution to the water supply. In the latter case, watertight construction methods shall be use.
- ~ Tributary stream crossings shall employ watertight construction methods of sewer lines and manholes. Watertight construction must extend 100 feet to either side of the stream.
- ~ Within 1,000 feet of surface water supplies and tributaries, all pumping stations shall have standby power and high water alarms telemetered to an appropriate location that is manned at all times. An emergency contingency plan must be developed by the owner of the wastewater treatment facility and submitted to the BRP for approval.
- ~ Beyond 1,000 feet and within the watershed of surface water supplies the Department may in specific circumstances after review, require additional controls.

#### Potential Public Water Supplies

The above requirements also apply to potential public water supplies.

#### Baseline Data Requirements

Two (2) copies of an appropriately scaled map(s) shall be submitted to the Department which details the proposed sewers and/or appurtenances and also includes the following:

- (1)the location of all nearby existing or potential surface water supplies, tributaries thereto, and watershed boundaries;
- (2)the location of existing and potential public and municipal potable groundwater supply wells.

The Department reserves the right to impose more restrictive measures than those contained in this policy as deemed appropriate.

#### Definitions

- Appurtenances – all attachments to sewer lines necessary for the transport and operation and maintenance of sewer lines, including manholes, pumping station, siphons, etc.
- Area of influence – that area of an aquifer which contributes water to a well under the most severe recharge and pumping condition that can be realistically anticipated (i.e. pumping at the safe yield of the well for 180 days without any natural recharge occurring). It is bounded by the groundwater divides which result from pumping the well and by the contact of the edge of the aquifer with less permeable materials such as till and bedrock. At some locations, streams and lakes may form recharge boundaries.
- Potential public water supply – areas designated by communities for water supply purposes where land has been set aside and Department approved pump tests conducted and surface water supplies as defined below.
- Surface Water Supply – Waters classified as Class A by the DWPC.
- Public Water Supply Systems – as defined in 310 CMR 22.02 (DEP Drinking Water Regulations).
- Class B Bedding – as defined in WPCF Manual of Practice No. 9.

APPROVED: (Signature on File)

---



---

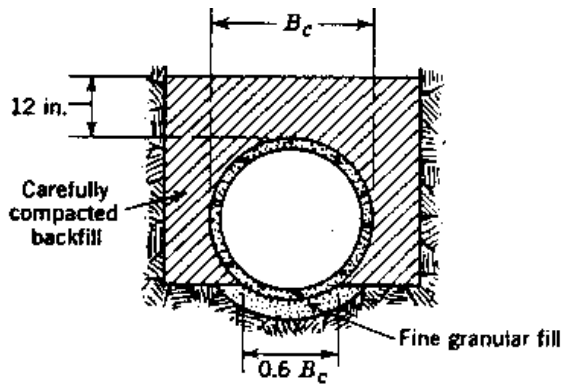

Shaped bottom with tamped backfill,  
load factor 1.9

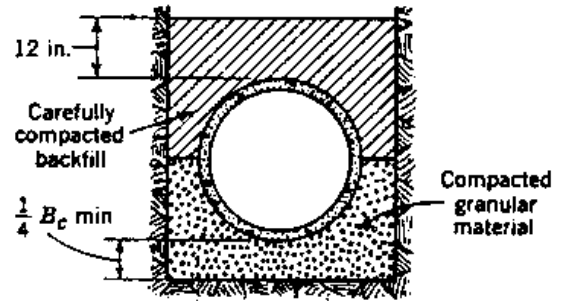

Compacted granular bedding,  
load factor 1.9

**Class B---First-Class Bedding** – Class B bedding may be achieved by either of two construction methods:

- a. **Shaped Bottom with Tamped Backfill.** The bottom of the trench excavation shall be shaped to conform to a cylindrical surface with a radius at least 2 in. (5 cm) greater than the radius to the outside of the pipe and with a width sufficient to allow six-tenths of the width of the pipe barrel to be bedded in fine granular fill placed in the shaped excavation. Carefully compacted backfill shall be placed at the sides of the pipe to a thickness of at least 12 in. (30 cm) above the top of the pipe. Shaped trench bottoms are difficult to achieve under current construction conditions.
- b. **Compacted Granular Bedding with Tamped Backfill.** The pipe shall be bedded in compacted granular material placed on a flat trench bottom. The granular bedding shall have a minimum thickness of one-fourth the outside pipe diameter and shall extend halfway up the pipe barrel at the sides. The remainder of the side fills and a minimum depth of 12 in. (30 cm) over the top of the pipe shall be filled with carefully compacted material.



## **Davis Bacon Act Requirements**

All construction projects are subject to the Davis Bacon wage rate requirements and must include the appropriate sections of the following document in its entirety in the contract documents.

**The vast majority of SRF projects will be bid by Governmental Entities (i.e., Cities, Towns, Authorities, Water Districts, Wastewater Districts). These projects must include the following language in construction contracts:**

**I.3. Contract and Subcontract Provisions**

**I.4. Contract Provisions for Contracts in Excess of \$100,000 (if applicable)**

**I.5. Compliance Verification**

**This language may be found on pages DB-3-DB-11.**

**In certain cases, SRF projects may be bid by non-Governmental Entities (i.e., private water companies, private PWSs, etc.). These projects must include the following language in construction contracts:**

**II.3. Contract and Subcontract Provisions**

**II.4. Contract Provisions for Contracts in Excess of \$100,000 (if applicable)**

**II.5. Compliance Verification**

**This language may be found on pages DB-11-DB-21**

### **Preamble**

With respect to the Clean Water and Safe Drinking Water State revolving Funds, EPA provides capitalization grants to each State which in turn provides subgrants or loans to eligible entities within the State. Typically, the subrecipients are municipal or other local governmental entities that manage the funds. For these types of recipients, the provisions set forth under Roman Numeral I, below, shall apply. Although EPA and the State remain responsible for ensuring subrecipients' compliance with the wage rate requirements set forth herein, those subrecipients shall have the primary responsibility to maintain payroll records as described in Section 3(ii)(A), below and for compliance as described in Section I-5.

Occasionally, the subrecipient may be a private for profit or not for profit entity. For these types of recipients, the provisions set forth in Roman Numeral II, below, shall apply. Although EPA and the State remain responsible for ensuring subrecipients' compliance with the wage rate requirements set forth herein, those subrecipients shall have the primary responsibility to maintain payroll records as described in Section II-3(ii)(A), below and for compliance as described in Section II-5.

### **I. Requirements For Subrecipients That Are Governmental Entities:**

The following terms and conditions specify how recipients will assist EPA in meeting its Davis-Bacon (DB) responsibilities when DB applies to EPA awards of financial assistance with respect to State recipients and subrecipients that are governmental entities. If a subrecipient has

questions regarding when DB applies, obtaining the correct DB wage determinations, DB provisions, or compliance monitoring, it may contact the State recipient. If a State recipient needs guidance, the recipient may contact Valerie Marshall at EPA Region 1 (617-918-1674) for guidance. The recipient or subrecipient may also obtain additional guidance from DOL's web site at <https://www.dol.gov/whd/govcontracts/dbra.htm>

## **1. Applicability of the Davis- Bacon (DB) prevailing wage requirements.**

DB prevailing wage requirements apply to the construction, alteration, and repair of treatment works carried out in whole or in part with assistance made available by a State water pollution control revolving fund and to any construction project carried out in whole or in part by assistance made available by a drinking water treatment revolving loan fund. If a subrecipient encounters a unique situation at a site that presents uncertainties regarding DB applicability, the subrecipient must discuss the situation with the recipient State before authorizing work on that site.

## **2. Obtaining Wage Determinations.**

(a) Subrecipients shall obtain the wage determination for the locality in which a covered activity subject to DB will take place prior to issuing requests for bids, proposals, quotes or other methods for soliciting contracts (solicitation) for activities subject to DB. These wage determinations shall be incorporated into solicitations and any subsequent contracts. Prime contracts must contain a provision requiring that subcontractors follow the wage determination incorporated into the prime contract.

(i) While the solicitation remains open, the subrecipient shall monitor [www.wdol.gov](http://www.wdol.gov) weekly to ensure that the wage determination contained in the solicitation remains current. The subrecipients shall amend the solicitation if DOL issues a modification more than 10 days prior to the closing date (i.e. bid opening) for the solicitation. If DOL modifies or supersedes the applicable wage determination less than 10 days prior to the closing date, the subrecipients may request a finding from the State recipient that there is not a reasonable time to notify interested contractors of the modification of the wage determination. The State recipient will provide a report of its findings to the subrecipient.

(ii) If the subrecipient does not award the contract within 90 days of the closure of the solicitation, any modifications or supersedes DOL makes to the wage determination contained in the solicitation shall be effective unless the State recipient, at the request of the subrecipient, obtains an extension of the 90 day period from DOL pursuant to 29 CFR 1.6(c)(3)(iv). The subrecipient shall monitor [www.wdol.gov](http://www.wdol.gov) on a weekly basis if it does not award the contract within 90 days of closure of the solicitation to ensure that wage determinations contained in the solicitation remain current.

(b) If the subrecipient carries out activity subject to DB by issuing a task order, work assignment or similar instrument to an existing contractor (ordering instrument) rather than by publishing a solicitation, the subrecipient shall insert the appropriate DOL wage determination from [www.wdol.gov](http://www.wdol.gov) into the ordering instrument.

(c) Subrecipients shall review all subcontracts subject to DB entered into by prime contractors to verify that the prime contractor has required its subcontractors to include the applicable wage determinations.

(d) As provided in 29 CFR 1.6(f), DOL may issue a revised wage determination applicable to a subrecipient's contract after the award of a contract or the issuance of an ordering instrument if DOL determines that the subrecipient has failed to incorporate a wage determination or has used a wage determination that clearly does not apply to the contract or ordering instrument. If this occurs, the subrecipient shall either terminate the contract or ordering instrument and issue a revised solicitation or ordering instrument or incorporate DOL's wage determination retroactive to the beginning of the contract or ordering instrument by change order. The subrecipient's contractor must be compensated for any increases in wages resulting from the use of DOL's revised wage determination.

### **3. Contract and Subcontract provisions.**

(a) The Recipient shall insure that the subrecipient(s) shall insert in full in any contract in excess of \$2,000 which is entered into for the actual construction, alteration and/or repair, including painting and decorating, of a treatment work under the CWSRF or a construction project under the DWSRF financed in whole or in part from Federal funds or in accordance with guarantees of a Federal agency or financed from funds obtained by pledge of any contract of a Federal agency to make a loan, grant or annual contribution (except where a different meaning is expressly indicated), and which is subject to the labor standards provisions of any of the acts listed in § 5.1 or the FY 2012 Appropriations Act, the following clauses:

(1) Minimum wages.

(i) All laborers and mechanics employed or working upon the site of the work will be paid unconditionally and not less often than once a week, and without subsequent deduction or rebate on any account (except such payroll deductions as are permitted by regulations issued by the Secretary of Labor under the Copeland Act (29 CFR part 3)), the full amount of wages and bona fide fringe benefits (or cash equivalents thereof) due at time of payment computed at rates not less than those contained in the wage determination of the Secretary of Labor which is attached hereto and made a part hereof, regardless of any contractual relationship which may be alleged to exist between the contractor and such laborers and mechanics.

Contributions made or costs reasonably anticipated for bona fide fringe benefits under section 1(b)(2) of the Davis-Bacon Act on behalf of laborers or mechanics are considered wages paid to such laborers or mechanics, subject to the provisions of paragraph (a)(1)(iv) of this section; also, regular contributions made or costs incurred for more than a weekly period (but not less often than quarterly) under plans, funds, or programs which cover the particular weekly period, are deemed to be constructively made or incurred during such weekly period. Such laborers and mechanics shall be paid the appropriate wage rate and fringe benefits on the wage determination for the classification of work actually performed, without regard to skill, except as provided in §5.5(a)(4). Laborers or mechanics performing work in more than one classification may be compensated at the rate specified for each classification for the time actually worked therein:

Provided, that the employer's payroll records accurately set forth the time spent in each classification in which work is performed. The wage determination (including any additional classification and wage rates conformed under paragraph (a)(1)(ii) of this section) and the Davis-Bacon poster (WH-1321) shall be posted at all times by the contractor and its subcontractors at the site of the work in a prominent and accessible place where it can be easily seen by the workers. Subrecipients may obtain wage determinations from the U.S. Department of Labor's web site, [www.dol.gov](http://www.dol.gov).

(ii)(A) The subrecipient(s), on behalf of EPA, shall require that any class of laborers or mechanics, including helpers, which is not listed in the wage determination and which is to be employed under the contract shall be classified in conformance with the wage determination. The State award official shall approve a request for an additional classification and wage rate and fringe benefits therefore only when the following criteria have been met:

- (1) The work to be performed by the classification requested is not performed by a classification in the wage determination; and
- (2) The classification is utilized in the area by the construction industry; and
- (3) The proposed wage rate, including any bona fide fringe benefits, bears a reasonable relationship to the wage rates contained in the wage determination.

(B) If the contractor and the laborers and mechanics to be employed in the classification (if known), or their representatives, and the subrecipient(s) agree on the classification and wage rate (including the amount designated for fringe benefits where appropriate), documentation of the action taken and the request, including the local wage determination shall be sent by the subrecipient (s) to the State award official. The State award official will transmit the request, to the Administrator of the Wage and Hour Division, Employment Standards Administration, U.S. Department of Labor, Washington, DC 20210 and to the EPA DB Regional Coordinator concurrently. The Administrator, or an authorized representative, will approve, modify, or disapprove every additional classification request within 30 days of receipt and so advise the State award official or will notify the State award official within the 30-day period that additional time is necessary.

(C) In the event the contractor, the laborers or mechanics to be employed in the classification or their representatives, and the subrecipient(s) do not agree on the proposed classification and wage rate (including the amount designated for fringe benefits, where appropriate), the award official shall refer the request and the local wage determination, including the views of all interested parties and the recommendation of the State award official, to the Administrator for determination. The request shall be sent to the EPA DB Regional Coordinator concurrently. The Administrator, or an authorized representative, will issue a determination within 30 days of receipt of the request and so advise the contracting officer or will notify the contracting officer within the 30-day period that additional time is necessary.

(D) The wage rate (including fringe benefits where appropriate) determined pursuant to paragraphs (a)(1)(ii)(B) or (C) of this section, shall be paid to all workers performing work in the classification under this contract from the first day on which work is performed in the classification.

(iii) Whenever the minimum wage rate prescribed in the contract for a class of laborers or mechanics includes a fringe benefit which is not expressed as an hourly rate, the contractor shall either pay the benefit as stated in the wage determination or shall pay another bona fide fringe benefit or an hourly cash equivalent thereof.

(iv) If the contractor does not make payments to a trustee or other third person, the contractor may consider as part of the wages of any laborer or mechanic the amount of any costs reasonably anticipated in providing bona fide fringe benefits under a plan or program, Provided, That the Secretary of Labor has found, upon the written request of the contractor, that the applicable standards of the Davis-Bacon Act have been met. The Secretary of Labor may require the contractor to set aside in a separate account assets for the meeting of obligations under the plan or program.

(2) Withholding. The subrecipient(s), shall upon written request of the EPA Award Official or an authorized representative of the Department of Labor, withhold or cause to be withheld from the contractor under this contract or any other Federal contract with the same prime contractor, or any other federally-assisted contract subject to Davis-Bacon prevailing wage requirements, which is held by the same prime contractor, so much of the accrued payments or advances as may be considered necessary to pay laborers and mechanics, including apprentices, trainees, and helpers, employed by the contractor or any subcontractor the full amount of wages required by the contract. In the event of failure to pay any laborer or mechanic, including any apprentice, trainee, or helper, employed or working on the site of the work, all or part of the wages required by the contract, the (Agency) may, after written notice to the contractor, sponsor, applicant, or owner, take such action as may be necessary to cause the suspension of any further payment, advance, or guarantee of funds until such violations have ceased.

(3) Payrolls and basic records.

(i) Payrolls and basic records relating thereto shall be maintained by the contractor during the course of the work and preserved for a period of three years thereafter for all laborers and mechanics working at the site of the work. Such records shall contain the name, address, and social security number of each such worker, his or her correct classification, hourly rates of wages paid (including rates of contributions or costs anticipated for bona fide fringe benefits or cash equivalents thereof of the types described in section 1(b)(2)(B) of the Davis-Bacon Act), daily and weekly number of hours worked, deductions made and actual wages paid. Whenever the Secretary of Labor has found under 29 CFR 5.5(a)(1)(iv) that the wages of any laborer or mechanic include the amount of any costs reasonably anticipated in providing benefits under a plan or program described in section 1(b)(2)(B) of the Davis-Bacon Act, the contractor shall maintain records which show that the commitment to provide such benefits is enforceable, that the plan or program is financially responsible, and that the plan or program has been communicated in writing to the laborers or mechanics affected, and records which show the costs anticipated or the actual cost incurred in providing such benefits. Contractors employing apprentices or trainees under approved programs shall maintain written evidence of the registration of apprenticeship programs and certification of trainee programs, the registration of the apprentices and trainees, and the ratios and wage rates prescribed in the applicable programs.



(ii)(A) The contractor shall submit weekly, for each week in which any contract work is performed, a copy of all payrolls to the subrecipient, that is, the entity that receives the sub-grant or loan from the State capitalization grant recipient. Such documentation shall be available on request of the State recipient or EPA. As to each payroll copy received, the subrecipient shall provide written confirmation in a form satisfactory to the State indicating whether or not the project is in compliance with the requirements of 29 CFR 5.5(a)(1) based on the most recent payroll copies for the specified week. The payrolls shall set out accurately and completely all of the information required to be maintained under 29 CFR 5.5(a)(3)(i), except that full social security numbers and home addresses shall not be included on the weekly payrolls. Instead the payrolls shall only need to include an individually identifying number for each employee (e.g., the last four digits of the employee's social security number). The required weekly payroll information may be submitted in any form desired. Optional Form WH-347 is available for this purpose from the Wage and Hour Division Web site at <https://www.dol.gov/whd/forms/wh347.pdf> or its successor site. The prime contractor is responsible for the submission of copies of payrolls by all subcontractors. Contractors and subcontractors shall maintain the full social security number and current address of each covered worker, and shall provide them upon request to the subrecipient(s) for transmission to the State or EPA if requested by EPA, the State, the contractor, or the Wage and Hour Division of the Department of Labor for purposes of an investigation or audit of compliance with prevailing wage requirements. It is not a violation of this section for a prime contractor to require a subcontractor to provide addresses and social security numbers to the prime contractor for its own records, without weekly submission to the subrecipient(s).

(B) Each payroll submitted shall be accompanied by a "Statement of Compliance," signed by the contractor or subcontractor or his or her agent who pays or supervises the payment of the persons employed under the contract and shall certify the following:

(1) That the payroll for the payroll period contains the information required to be provided under § 5.5 (a)(3)(ii) of Regulations, 29 CFR part 5, the appropriate information is being maintained under § 5.5 (a)(3)(i) of Regulations, 29 CFR part 5, and that such information is correct and complete;

(2) That each laborer or mechanic (including each helper, apprentice, and trainee) employed on the contract during the payroll period has been paid the full weekly wages earned, without rebate, either directly or indirectly, and that no deductions have been made either directly or indirectly from the full wages earned, other than permissible deductions as set forth in Regulations, 29 CFR part 3;

(3) That each laborer or mechanic has been paid not less than the applicable wage rates and fringe benefits or cash equivalents for the classification of work performed, as specified in the applicable wage determination incorporated into the contract.

(C) The weekly submission of a properly executed certification set forth on the reverse side of Optional Form WH-347 shall satisfy the requirement for submission of the "Statement of Compliance" required by paragraph (a)(3)(ii)(B) of this section.

(D) The falsification of any of the above certifications may subject the contractor or subcontractor to civil or criminal prosecution under section 1001 of title 18 and section 231 of title 31 of the United States Code.

(iii) The contractor or subcontractor shall make the records required under paragraph (a)(3)(i) of this section available for inspection, copying, or transcription by authorized representatives of the State, EPA or the Department of Labor, and shall permit such representatives to interview employees during working hours on the job. If the contractor or subcontractor fails to submit the required records or to make them available, the Federal agency or State may, after written notice to the contractor, sponsor, applicant, or owner, take such action as may be necessary to cause the suspension of any further payment, advance, or guarantee of funds. Furthermore, failure to submit the required records upon request or to make such records available may be grounds for debarment action pursuant to 29 CFR 5.12.

(4) Apprentices and trainees--

(i) Apprentices. Apprentices will be permitted to work at less than the predetermined rate for the work they performed when they are employed pursuant to and individually registered in a bona fide apprenticeship program registered with the U.S. Department of Labor, Employment and Training Administration, Office of Apprenticeship Training, Employer and Labor Services, or with a State Apprenticeship Agency recognized by the Office, or if a person is employed in his or her first 90 days of probationary employment as an apprentice in such an apprenticeship program, who is not individually registered in the program, but who has been certified by the Office of Apprenticeship Training, Employer and Labor Services or a State Apprenticeship Agency (where appropriate) to be eligible for probationary employment as an apprentice. The allowable ratio of apprentices to journeymen on the job site in any craft classification shall not be greater than the ratio permitted to the contractor as to the entire work force under the registered program. Any worker listed on a payroll at an apprentice wage rate, who is not registered or otherwise employed as stated above, shall be paid not less than the applicable wage rate on the wage determination for the classification of work actually performed. In addition, any apprentice performing work on the job site in excess of the ratio permitted under the registered program shall be paid not less than the applicable wage rate on the wage determination for the work actually performed. Where a contractor is performing construction on a project in a locality other than that in which its program is registered, the ratios and wage rates (expressed in percentages of the journeyman's hourly rate) specified in the contractor's or subcontractor's registered program shall be observed. Every apprentice must be paid at not less than the rate specified in the registered program for the apprentice's level of progress, expressed as a percentage of the journeymen hourly rate specified in the applicable wage determination. Apprentices shall be paid fringe benefits in accordance with the provisions of the apprenticeship program. If the apprenticeship program does not specify fringe benefits, apprentices must be paid the full amount of fringe benefits listed on the wage determination for the applicable classification. If the Administrator determines that a different practice prevails for the applicable apprentice classification, fringes shall be paid in accordance with that determination. In the event the Office of Apprenticeship Training, Employer and Labor Services, or a State Apprenticeship Agency recognized by the Office, withdraws approval of an apprenticeship program, the contractor will no longer be permitted to utilize apprentices at less than the applicable predetermined rate for the work performed until an acceptable program is approved.

(ii) Trainees. Except as provided in 29 CFR 5.16, trainees will not be permitted to work at less than the predetermined rate for the work performed unless they are employed pursuant to and individually registered in a program which has received prior approval, evidenced by formal certification by the U.S. Department of Labor, Employment and Training Administration. The ratio of trainees to journeymen on the job site shall not be greater than permitted under the plan approved by the Employment and Training Administration. Every trainee must be paid at not less than the rate specified in the approved program for the trainee's level of progress, expressed as a percentage of the journeyman hourly rate specified in the applicable wage determination. Trainees shall be paid fringe benefits in accordance with the provisions of the trainee program. If the trainee program does not mention fringe benefits, trainees shall be paid the full amount of fringe benefits listed on the wage determination unless the Administrator of the Wage and Hour Division determines that there is an apprenticeship program associated with the corresponding journeyman wage rate on the wage determination which provides for less than full fringe benefits for apprentices. Any employee listed on the payroll at a trainee rate who is not registered and participating in a training plan approved by the Employment and Training Administration shall be paid not less than the applicable wage rate on the wage determination for the classification of work actually performed. In addition, any trainee performing work on the job site in excess of the ratio permitted under the registered program shall be paid not less than the applicable wage rate on the wage determination for the work actually performed. In the event the Employment and Training Administration withdraws approval of a training program, the contractor will no longer be permitted to utilize trainees at less than the applicable predetermined rate for the work performed until an acceptable program is approved.

(iii) Equal employment opportunity. The utilization of apprentices, trainees and journeymen under this part shall be in conformity with the equal employment opportunity requirements of Executive Order 11246, as amended, and 29 CFR part 30.

- (5) Compliance with Copeland Act requirements. The contractor shall comply with the requirements of 29 CFR part 3, which are incorporated by reference in this contract.
- (6) Subcontracts. The contractor or subcontractor shall insert in any subcontracts the clauses contained in 29 CFR 5.5(a)(1) through (10) and such other clauses as the EPA determines may be appropriate, and also a clause requiring the subcontractors to include these clauses in any lower tier subcontracts. The prime contractor shall be responsible for the compliance by any subcontractor or lower tier subcontractor with all the contract clauses in 29 CFR 5.5.
- (7) Contract termination; debarment. A breach of the contract clauses in 29 CFR 5.5 may be grounds for termination of the contract, and for debarment as a contractor and a subcontractor as provided in 29 CFR 5.12.
- (8) Compliance with Davis-Bacon and Related Act requirements. All rulings and interpretations of the Davis-Bacon and Related Acts contained in 29 CFR parts 1, 3, and 5 are herein incorporated by reference in this contract.
- (9) Disputes concerning labor standards. Disputes arising out of the labor standards provisions of this contract shall not be subject to the general disputes clause of this contract. Such disputes shall be resolved in accordance with the procedures of the Department of Labor set forth in 29

CFR parts 5, 6, and 7. Disputes within the meaning of this clause include disputes between the contractor (or any of its subcontractors) and Subrecipient(s), State, EPA, the U.S. Department of Labor, or the employees or their representatives.

(10) Certification of eligibility.

(i) By entering into this contract, the contractor certifies that neither it (nor he or she) nor any person or firm who has an interest in the contractor's firm is a person or firm ineligible to be awarded Government contracts by virtue of section 3(a) of the Davis-Bacon Act or 29 CFR 5.12(a)(1).

(ii) No part of this contract shall be subcontracted to any person or firm ineligible for award of a Government contract by virtue of section 3(a) of the Davis-Bacon Act or 29 CFR 5.12(a)(1).

(iii) The penalty for making false statements is prescribed in the U.S. Criminal Code, 18 U.S.C. 1001.

**4. Contract Provision for Contracts in Excess of \$100,000.**

(a) Contract Work Hours and Safety Standards Act. The subrecipient shall insert the following clauses set forth in paragraphs (a)(1), (2), (3), and (4) of this section in full in any contract in an amount in excess of \$100,000 and subject to the overtime provisions of the Contract Work Hours and Safety Standards Act. These clauses shall be inserted in addition to the clauses required by Item 3, above or 29 CFR 4.6. As used in this paragraph, the terms laborers and mechanics include watchmen and guards.

(1) Overtime requirements. No contractor or subcontractor contracting for any part of the contract work which may require or involve the employment of laborers or mechanics shall require or permit any such laborer or mechanic in any workweek in which he or she is employed on such work to work in excess of forty hours in such workweek unless such laborer or mechanic receives compensation at a rate not less than one and one-half times the basic rate of pay for all hours worked in excess of forty hours in such workweek.

(2) Violation; liability for unpaid wages; liquidated damages. In the event of any violation of the clause set forth in paragraph (a)(1) of this section the contractor and any subcontractor responsible therefore shall be liable for the unpaid wages. In addition, such contractor and subcontractor shall be liable to the United States (in the case of work done under contract for the District of Columbia or a territory, to such District or to such territory), for liquidated damages. Such liquidated damages shall be computed with respect to each individual laborer or mechanic, including watchmen and guards, employed in violation of the clause set forth in paragraph (a)(1) of this section, in the sum of \$10 for each calendar day on which such individual was required or permitted to work in excess of the standard workweek of forty hours without payment of the overtime wages required by the clause set forth in paragraph (a)(1) of this section.

(3) Withholding for unpaid wages and liquidated damages. The subrecipient, upon written request of the EPA Award Official or an authorized representative of the Department of Labor, shall withhold or cause to be withheld, from any moneys payable on account of work performed by the contractor or subcontractor under any such contract or any other

Federal contract with the same prime contractor, or any other federally-assisted contract subject to the Contract Work Hours and Safety Standards Act, which is held by the same prime contractor, such sums as may be determined to be necessary to satisfy any liabilities of such contractor or subcontractor for unpaid wages and liquidated damages as provided in the clause set forth in paragraph (b)(2) of this section.

(4) Subcontracts. The contractor or subcontractor shall insert in any subcontracts the clauses set forth in paragraph (a)(1) through (4) of this section and also a clause requiring the subcontractors to include these clauses in any lower tier subcontracts. The prime contractor shall be responsible for compliance by any subcontractor or lower tier subcontractor with the clauses set forth in paragraphs (a)(1) through (4) of this section.

(b) In addition to the clauses contained in Item 3, above, in any contract subject only to the Contract Work Hours and Safety Standards Act and not to any of the other statutes cited in 29 CFR 5.1, the Subrecipient shall insert a clause requiring that the contractor or subcontractor shall maintain payrolls and basic payroll records during the course of the work and shall preserve them for a period of three years from the completion of the contract for all laborers and mechanics, including guards and watchmen, working on the contract. Such records shall contain the name and address of each such employee, social security number, correct classifications, hourly rates of wages paid, daily and weekly number of hours worked, deductions made, and actual wages paid. Further, the Subrecipient shall insert in any such contract a clause providing that the records to be maintained under this paragraph shall be made available by the contractor or subcontractor for inspection, copying, or transcription by authorized representatives of the (write the name of agency) and the Department of Labor, and the contractor or subcontractor will permit such representatives to interview employees during working hours on the job.

## **5. Compliance Verification**

(a) The subrecipient shall periodically interview a sufficient number of employees entitled to DB prevailing wages (covered employees) to verify that contractors or subcontractors are paying the appropriate wage rates. As provided in 29 CFR 5.6(a)(6), all interviews must be conducted in confidence. The subrecipient must use Standard Form 1445 (SF 1445) or equivalent documentation to memorialize the interviews. Copies of the SF 1445 are available from EPA on request.

(b) The subrecipient shall establish and follow an interview schedule based on its assessment of the risks of noncompliance with DB posed by contractors or subcontractors and the duration of the contract or subcontract. At a minimum, the subrecipient should conduct interviews with a representative group of covered employees within two weeks of each contractor or subcontractor's submission of its initial weekly payroll data and two weeks prior to the estimated completion date for the contract or subcontract. Subrecipients must conduct more frequent interviews if the initial interviews or other information indicates that there is a risk that the contractor or subcontractor is not complying with DB. Subrecipients shall immediately conduct necessary interviews in response to an alleged violation of the prevailing wage requirements. All interviews shall be conducted in confidence.

(c) The subrecipient shall periodically conduct spot checks of a representative sample of weekly payroll data to verify that contractors or subcontractors are paying the appropriate wage rates. The subrecipient shall establish and follow a spot check schedule based on its

assessment of the risks of noncompliance with DB posed by contractors or subcontractors and the duration of the contract or subcontract. At a minimum, if practicable, the subrecipient should spot check payroll data within two weeks of each contractor or subcontractor's submission of its initial payroll data and two weeks prior to the completion date the contract or subcontract. Subrecipients must conduct more frequent spot checks if the initial spot check or other information indicates that there is a risk that the contractor or subcontractor is not complying with DB. In addition, during the examinations the subrecipient shall verify evidence of fringe benefit plans and payments thereunder by contractors and subcontractors who claim credit for fringe benefit contributions.

(d) The subrecipient shall periodically review contractors and subcontractors use of apprentices and trainees to verify registration and certification with respect to apprenticeship and training programs approved by either the U.S Department of Labor or a state, as appropriate, and that contractors and subcontractors are not using disproportionate numbers of, laborers, trainees and apprentices. These reviews shall be conducted in accordance with the schedules for spot checks and interviews described in Item 5(b) and (c) above.

(e) Subrecipients must immediately report potential violations of the DB prevailing wage requirements to the EPA DB contact listed above and to the appropriate DOL Wage and Hour District Office listed at [https://www.dol.gov/whd/whd\\_district\\_offices.pdf](https://www.dol.gov/whd/whd_district_offices.pdf).

## **II. Requirements For Subrecipients That Are Not Governmental Entities**

The following terms and conditions specify how recipients will assist EPA in meeting its DB responsibilities when DB applies to EPA awards of financial assistance with respect to subrecipients that are not governmental entities. If a subrecipient has questions regarding when DB applies, obtaining the correct DB wage determinations, DB provisions, or compliance monitoring, it may contact the State recipient for guidance. If a State recipient needs guidance, the recipient may contact Valerie Marshall at EPA Region 1 (617-918-1674) for guidance. The recipient or subrecipient may also obtain additional guidance from DOL's web site at <https://www.dol.gov/whd/govcontracts/dbra.htm>

**Under these terms and conditions, the subrecipient must submit its proposed DB wage determinations to the State recipient for approval prior to including the wage determination in any solicitation, contract task orders, work assignments, or similar instruments to existing contractors.**

### **1. Applicability of the Davis- Bacon (DB) prevailing wage requirements.**

DB prevailing wage requirements apply to the construction, alteration, and repair of treatment works carried out in whole or in part with assistance made available by a State water pollution control revolving fund and to any construction project carried out in whole or in part by assistance made available by a drinking water treatment revolving loan fund. If a subrecipient encounters a unique situation at a site that presents uncertainties regarding DB applicability, the subrecipient must discuss the situation with the recipient State before authorizing work on that site.

### **2. Obtaining Wage Determinations.**

(a) Subrecipients must obtain proposed wage determinations for specific localities at [www.wdol.gov](http://www.wdol.gov). After the Subrecipient obtains its proposed wage determination, it must submit the wage determination to (insert contact information for State recipient DB point of contact for wage determination) for approval prior to inserting the wage determination into a solicitation, contract or issuing task orders, work assignments or similar instruments to existing contractors (ordering instruments unless subsequently directed otherwise by the State recipient Award Official).

(b) Subrecipients shall obtain the wage determination for the locality in which a covered activity subject to DB will take place prior to issuing requests for bids, proposals, quotes or other methods for soliciting contracts (solicitation) for activities subject to DB. These wage determinations shall be incorporated into solicitations and any subsequent contracts. Prime contracts must contain a provision requiring that subcontractors follow the wage determination incorporated into the prime contract.

(i) While the solicitation remains open, the subrecipient shall monitor [www.wdol.gov](http://www.wdol.gov) on a weekly basis to ensure that the wage determination contained in the solicitation remains current. The subrecipients shall amend the solicitation if DOL issues a modification more than 10 days prior to the closing date (i.e. bid opening) for the solicitation. If DOL modifies or supersedes the applicable wage determination less than 10 days prior to the closing date, the subrecipients may request a finding from the State recipient that there is not a reasonable time to notify interested contractors of the modification of the wage determination. The State recipient will provide a report of its findings to the subrecipient.

(ii) If the subrecipient does not award the contract within 90 days of the closure of the solicitation, any modifications or supersedes DOL makes to the wage determination contained in the solicitation shall be effective unless the State recipient, at the request of the subrecipient, obtains an extension of the 90 day period from DOL pursuant to 29 CFR 1.6(c)(3)(iv). The subrecipient shall monitor [www.wdol.gov](http://www.wdol.gov) on a weekly basis if it does not award the contract within 90 days of closure of the solicitation to ensure that wage determinations contained in the solicitation remain current.

(c) If the subrecipient carries out activity subject to DB by issuing a task order, work assignment or similar instrument to an existing contractor (ordering instrument) rather than by publishing a solicitation, the subrecipient shall insert the appropriate DOL wage determination from [www.wdol.gov](http://www.wdol.gov) into the ordering instrument.

(d) Subrecipients shall review all subcontracts subject to DB entered into by prime contractors to verify that the prime contractor has required its subcontractors to include the applicable wage determinations.

(e) As provided in 29 CFR 1.6(f), DOL may issue a revised wage determination applicable to a subrecipient's contract after the award of a contract or the issuance of an ordering instrument if DOL determines that the subrecipient has failed to incorporate a wage determination or has used a wage determination that clearly does not apply to the contract or ordering instrument. If this occurs, the subrecipient shall either terminate the contract or ordering instrument and issue a revised solicitation or ordering instrument or incorporate DOL's wage determination retroactive to the beginning of the contract or ordering instrument by change order. The subrecipient's contractor must be compensated for any increases in wages resulting from the use of DOL's revised wage determination.

### 3. Contract and Subcontract provisions.

(a) The Recipient shall insure that the subrecipient(s) shall insert in full in any contract in excess of \$2,000 which is entered into for the actual construction, alteration and/or repair, including painting and decorating, of a treatment work under the CWSRF or a construction project under the DWSRF financed in whole or in part from Federal funds or in accordance with guarantees of a Federal agency or financed from funds obtained by pledge of any contract of a Federal agency to make a loan, grant or annual contribution (except where a different meaning is expressly indicated), and which is subject to the labor standards provisions of any of the acts listed in § 5.1 or the FY 2011 Full-Year Continuing Appropriation, the following clauses:

(1) Minimum wages.

(i) All laborers and mechanics employed or working upon the site of the work, will be paid unconditionally and not less often than once a week, and without subsequent deduction or rebate on any account (except such payroll deductions as are permitted by regulations issued by the Secretary of Labor under the Copeland Act (29 CFR part 3) ), the full amount of wages and bona fide fringe benefits (or cash equivalents thereof) due at time of payment computed at rates not less than those contained in the wage determination of the Secretary of Labor which is attached hereto and made a part hereof, regardless of any contractual relationship which may be alleged to exist between the contractor and such laborers and mechanics. Contributions made or costs reasonably anticipated for bona fide fringe benefits under section 1(b)(2) of the Davis-Bacon Act on behalf of laborers or mechanics are considered wages paid to such laborers or mechanics, subject to the provisions of paragraph (a)(1)(iv) of this section; also, regular contributions made or costs incurred for more than a weekly period (but not less often than quarterly) under plans, funds, or programs which cover the particular weekly period, are deemed to be constructively made or incurred during such weekly period. Such laborers and mechanics shall be paid the appropriate wage rate and fringe benefits on the wage determination for the classification of work actually performed, without regard to skill, except as provided in §5.5(a)(4). Laborers or mechanics performing work in more than one classification may be compensated at the rate specified for each classification for the time actually worked therein: Provided, that the employer's payroll records accurately set forth the time spent in each classification in which work is performed. The wage determination (including any additional classification and wage rates conformed under paragraph (a)(1)(ii) of this section) and the Davis-Bacon poster (WH-1321) shall be posted at all times by the contractor and its subcontractors at the site of the work in a prominent and accessible place where it can be easily seen by the workers. Subrecipients may obtain wage determinations from the U.S. Department of Labor's web site, [www.dol.gov](http://www.dol.gov).

(ii)(A) The subrecipient(s), on behalf of EPA, shall require that any class of laborers or mechanics, including helpers, which is not listed in the wage determination and which is to be employed under the contract shall be classified in conformance with the wage determination. The State award official shall approve a request for an additional classification and wage rate and fringe benefits therefore only when the following criteria have been met:



(1) The work to be performed by the classification requested is not performed by a classification in the wage determination; and

(2) The classification is utilized in the area by the construction industry; and

(3) The proposed wage rate, including any bona fide fringe benefits, bears a reasonable relationship to the wage rates contained in the wage determination.

(B) If the contractor and the laborers and mechanics to be employed in the classification (if known), or their representatives, and the subrecipient(s) agree on the classification and wage rate (including the amount designated for fringe benefits where appropriate), documentation of the action taken and the request, including the local wage determination shall be sent by the subrecipient(s) to the State award official. The State award official will transmit the report, to the Administrator of the Wage and Hour Division, Employment Standards Administration, U.S. Department of Labor, Washington, DC 20210 and to the EPA DB Regional Coordinator concurrently. The Administrator, or an authorized representative, will approve, modify, or disapprove every additional classification request within 30 days of receipt and so advise the State award official or will notify the State award official within the 30-day period that additional time is necessary.

(C) In the event the contractor, the laborers or mechanics to be employed in the classification or their representatives, and the and the subrecipient(s) do not agree on the proposed classification and wage rate (including the amount designated for fringe benefits, where appropriate), the award official shall refer the request, and the local wage determination, including the views of all interested parties and the recommendation of the State award official, to the Administrator for determination. The request shall be sent to the EPA Regional Coordinator concurrently. The Administrator, or an authorized representative, will issue a determination within 30 days of receipt of the request and so advise the contracting officer or will notify the contracting officer within the 30-day period that additional time is necessary.

(D) The wage rate (including fringe benefits where appropriate) determined pursuant to paragraphs (a)(1)(ii)(B) or (C) of this section, shall be paid to all workers performing work in the classification under this contract from the first day on which work is performed in the classification.

(iii) Whenever the minimum wage rate prescribed in the contract for a class of laborers or mechanics includes a fringe benefit which is not expressed as an hourly rate, the contractor shall either pay the benefit as stated in the wage determination or shall pay another bona fide fringe benefit or an hourly cash equivalent thereof.

(iv) If the contractor does not make payments to a trustee or other third person, the contractor may consider as part of the wages of any laborer or mechanic the amount of any costs reasonably anticipated in providing bona fide fringe benefits under a plan or program, Provided, That the Secretary of Labor has found, upon the written request of the contractor, that the applicable standards of the Davis-Bacon Act have been met. The Secretary of Labor may require the contractor to set aside in a separate account assets for the meeting of obligations under the plan or program.

(2) Withholding. The subrecipient(s) shall upon written request of the EPA Award Official or an authorized representative of the Department of Labor, withhold or cause to be withheld from the contractor under this contract or any other Federal contract with the same prime contractor, or any other federally-assisted contract subject to Davis-Bacon prevailing wage requirements, which is held by the same prime contractor, so much of the accrued payments or advances as may be considered necessary to pay laborers and mechanics, including apprentices, trainees, and helpers, employed by the contractor or any subcontractor the full amount of wages required by the contract. In the event of failure to pay any laborer or mechanic, including any apprentice, trainee, or helper, employed or working on the site of the work, all or part of the wages required by the contract, the (Agency) may, after written notice to the contractor, sponsor, applicant, or owner, take such action as may be necessary to cause the suspension of any further payment, advance, or guarantee of funds until such violations have ceased.

(3) Payrolls and basic records.

(i) Payrolls and basic records relating thereto shall be maintained by the contractor during the course of the work and preserved for a period of three years thereafter for all laborers and mechanics working at the site of the work. Such records shall contain the name, address, and social security number of each such worker, his or her correct classification, hourly rates of wages paid (including rates of contributions or costs anticipated for bona fide fringe benefits or cash equivalents thereof of the types described in section 1(b)(2)(B) of the Davis-Bacon Act), daily and weekly number of hours worked, deductions made and actual wages paid. Whenever the Secretary of Labor has found under 29 CFR 5.5(a)(1)(iv) that the wages of any laborer or mechanic include the amount of any costs reasonably anticipated in providing benefits under a plan or program described in section 1(b)(2)(B) of the Davis-Bacon Act, the contractor shall maintain records which show that the commitment to provide such benefits is enforceable, that the plan or program is financially responsible, and that the plan or program has been communicated in writing to the laborers or mechanics affected, and records which show the costs anticipated or the actual cost incurred in providing such benefits. Contractors employing apprentices or trainees under approved programs shall maintain written evidence of the registration of apprenticeship programs and certification of trainee programs, the registration of the apprentices and trainees, and the ratios and wage rates prescribed in the applicable programs.

(ii)(A) The contractor shall submit weekly, for each week in which any contract work is performed, a copy of all payrolls to the subrecipient, that is, the entity that receives the sub-grant or loan from the State capitalization grant recipient. Such documentation shall be available on request of the State recipient or EPA. As to each payroll copy received, the subrecipient shall provide written confirmation in a form satisfactory to the State indicating whether or not the project is in compliance with the requirements of 29 CFR 5.5(a)(1) based on the most recent payroll copies for the specified week. The payrolls shall set out accurately and completely all of the information required to be maintained under 29 CFR 5.5(a)(3)(i), except that full social security numbers and home addresses shall not be included on the weekly payrolls. Instead the payrolls shall only need to include an individually identifying number for each employee (e.g., the last four digits of the employee's social security number). The required weekly payroll information may be submitted in any form desired. Optional Form WH-347 is

available for this purpose from the Wage and Hour Division Web site at <https://www.dol.gov/whd/forms/wh347.pdf> or its successor site. The prime contractor is responsible for the submission of copies of payrolls by all subcontractors. Contractors and subcontractors shall maintain the full social security number and current address of each covered worker, and shall provide them upon request to the subrecipient(s) for transmission to the State or EPA if requested by EPA, the State, the contractor, or the Wage and Hour Division of the Department of Labor for purposes of an investigation or audit of compliance with prevailing wage requirements. It is not a violation of this section for a prime contractor to require a subcontractor to provide addresses and social security numbers to the prime contractor for its own records, without weekly submission to the subrecipient(s).

(B) Each payroll submitted shall be accompanied by a "Statement of Compliance," signed by the contractor or subcontractor or his or her agent who pays or supervises the payment of the persons employed under the contract and shall certify the following:

- (1) That the payroll for the payroll period contains the information required to be provided under § 5.5 (a)(3)(ii) of Regulations, 29 CFR part 5, the appropriate information is being maintained under § 5.5 (a)(3)(i) of Regulations, 29 CFR part 5, and that such information is correct and complete;
- (2) That each laborer or mechanic (including each helper, apprentice, and trainee) employed on the contract during the payroll period has been paid the full weekly wages earned, without rebate, either directly or indirectly, and that no deductions have been made either directly or indirectly from the full wages earned, other than permissible deductions as set forth in Regulations, 29 CFR part 3;
- (3) That each laborer or mechanic has been paid not less than the applicable wage rates and fringe benefits or cash equivalents for the classification of work performed, as specified in the applicable wage determination incorporated into the contract.

(C) The weekly submission of a properly executed certification set forth on the reverse side of Optional Form WH-347 shall satisfy the requirement for submission of the "Statement of Compliance" required by paragraph (a)(3)(ii)(B) of this section.

(D) The falsification of any of the above certifications may subject the contractor or subcontractor to civil or criminal prosecution under section 1001 of title 18 and section 231 of title 31 of the United States Code.

(iii) The contractor or subcontractor shall make the records required under paragraph (a)(3)(i) of this section available for inspection, copying, or transcription by authorized representatives of the State, EPA or the Department of Labor, and shall permit such representatives to interview employees during working hours on the job. If the contractor or subcontractor fails to submit the required records or to make them available, the Federal agency or State may, after written notice to the contractor, sponsor, applicant, or owner, take such action as may be necessary to cause the suspension of any further payment, advance, or guarantee of funds. Furthermore, failure to submit the required records upon request or to make such records available may be grounds for debarment action pursuant to 29 CFR 5.12.

(4) Apprentices and trainees--

(i) Apprentices. Apprentices will be permitted to work at less than the predetermined rate for the work they performed when they are employed pursuant to and individually registered in a bona fide apprenticeship program registered with the U.S. Department of Labor, Employment and Training Administration, Office of Apprenticeship Training, Employer and Labor Services, or with a State Apprenticeship Agency recognized by the Office, or if a person is employed in his or her first 90 days of probationary employment as an apprentice in such an apprenticeship program, who is not individually registered in the program, but who has been certified by the Office of Apprenticeship Training, Employer and Labor Services or a State Apprenticeship Agency (where appropriate) to be eligible for probationary employment as an apprentice. The allowable ratio of apprentices to journeymen on the job site in any craft classification shall not be greater than the ratio permitted to the contractor as to the entire work force under the registered program. Any worker listed on a payroll at an apprentice wage rate, who is not registered or otherwise employed as stated above, shall be paid not less than the applicable wage rate on the wage determination for the classification of work actually performed. In addition, any apprentice performing work on the job site in excess of the ratio permitted under the registered program shall be paid not less than the applicable wage rate on the wage determination for the work actually performed. Where a contractor is performing construction on a project in a locality other than that in which its program is registered, the ratios and wage rates (expressed in percentages of the journeyman's hourly rate) specified in the contractor's or subcontractor's registered program shall be observed. Every apprentice must be paid at not less than the rate specified in the registered program for the apprentice's level of progress, expressed as a percentage of the journeymen hourly rate specified in the applicable wage determination. Apprentices shall be paid fringe benefits in accordance with the provisions of the apprenticeship program. If the apprenticeship program does not specify fringe benefits, apprentices must be paid the full amount of fringe benefits listed on the wage determination for the applicable classification. If the Administrator determines that a different practice prevails for the applicable apprentice classification, fringes shall be paid in accordance with that determination. In the event the Office of Apprenticeship Training, Employer and Labor Services, or a State Apprenticeship Agency recognized by the Office, withdraws approval of an apprenticeship program, the contractor will no longer be permitted to utilize apprentices at less than the applicable predetermined rate for the work performed until an acceptable program is approved.

(ii) Trainees. Except as provided in 29 CFR 5.16, trainees will not be permitted to work at less than the predetermined rate for the work performed unless they are employed pursuant to and individually registered in a program which has received prior approval, evidenced by formal certification by the U.S. Department of Labor, Employment and Training Administration. The ratio of trainees to journeymen on the job site shall not be greater than permitted under the plan approved by the Employment and Training Administration. Every trainee must be paid at not less than the rate specified in the approved program for the trainee's level of progress, expressed as a percentage of the journeyman hourly rate specified in the applicable wage determination. Trainees shall be paid fringe benefits in accordance with the provisions of the trainee program. If the trainee program does not mention fringe benefits, trainees shall be paid the full amount of

fringe benefits listed on the wage determination unless the Administrator of the Wage and Hour Division determines that there is an apprenticeship program associated with the corresponding journeyman wage rate on the wage determination which provides for less than full fringe benefits for apprentices. Any employee listed on the payroll at a trainee rate who is not registered and participating in a training plan approved by the Employment and Training Administration shall be paid not less than the applicable wage rate on the wage determination for the classification of work actually performed. In addition, any trainee performing work on the job site in excess of the ratio permitted under the registered program shall be paid not less than the applicable wage rate on the wage determination for the work actually performed. In the event the Employment and Training Administration withdraws approval of a training program, the contractor will no longer be permitted to utilize trainees at less than the applicable predetermined rate for the work performed until an acceptable program is approved.

(iii) Equal employment opportunity. The utilization of apprentices, trainees and journeymen under this part shall be in conformity with the equal employment opportunity requirements of Executive Order 11246, as amended, and 29 CFR part 30.

(5) Compliance with Copeland Act requirements. The contractor shall comply with the requirements of 29 CFR part 3, which are incorporated by reference in this contract.

(6) Subcontracts. The contractor or subcontractor shall insert in any subcontracts the clauses contained in 29 CFR 5.5(a)(1) through (10) and such other clauses as the EPA determines may be appropriate, and also a clause requiring the subcontractors to include these clauses in any lower tier subcontracts. The prime contractor shall be responsible for the compliance by any subcontractor or lower tier subcontractor with all the contract clauses in 29 CFR 5.5.

(7) Contract termination: debarment. A breach of the contract clauses in 29 CFR 5.5 may be grounds for termination of the contract, and for debarment as a contractor and a subcontractor as provided in 29 CFR 5.12.

(8) Compliance with Davis-Bacon and Related Act requirements. All rulings and interpretations of the Davis-Bacon and Related Acts contained in 29 CFR parts 1, 3, and 5 are herein incorporated by reference in this contract.

(9) Disputes concerning labor standards. Disputes arising out of the labor standards provisions of this contract shall not be subject to the general disputes clause of this contract. Such disputes shall be resolved in accordance with the procedures of the Department of Labor set forth in 29 CFR parts 5, 6, and 7. Disputes within the meaning of this clause include disputes between the contractor (or any of its subcontractors) and Subrecipient(s), State, EPA, the U.S. Department of Labor, or the employees or their representatives.

(10) Certification of eligibility.

(i) By entering into this contract, the contractor certifies that neither it (nor he or she) nor any person or firm who has an interest in the contractor's firm is a person or firm ineligible to be awarded Government contracts by virtue of section 3(a) of the Davis-Bacon Act or 29 CFR 5.12(a)(1).

(ii) No part of this contract shall be subcontracted to any person or firm ineligible for award of a Government contract by virtue of section 3(a) of the Davis-Bacon Act or 29 CFR 5.12(a)(1).

(iii) The penalty for making false statements is prescribed in the U.S. Criminal Code, 18 U.S.C. 1001.

#### **4. Contract Provision for Contracts in Excess of \$100,000.**

(a) Contract Work Hours and Safety Standards Act. The subrecipient shall insert the following clauses set forth in paragraphs (a)(1), (2), (3), and (4) of this section in full in any contract in an amount in excess of \$100,000 and subject to the overtime provisions of the Contract Work Hours and Safety Standards Act. These clauses shall be inserted in addition to the clauses required by Item 3, above or 29 CFR 4.6. As used in this paragraph, the terms laborers and mechanics include watchmen and guards.

- (1) Overtime requirements. No contractor or subcontractor contracting for any part of the contract work which may require or involve the employment of laborers or mechanics shall require or permit any such laborer or mechanic in any workweek in which he or she is employed on such work to work in excess of forty hours in such workweek unless such laborer or mechanic receives compensation at a rate not less than one and one-half times the basic rate of pay for all hours worked in excess of forty hours in such workweek.
- (2) Violation; liability for unpaid wages; liquidated damages. In the event of any violation of the clause set forth in paragraph (b)(1) of this section the contractor and any subcontractor responsible therefore shall be liable for the unpaid wages. In addition, such contractor and subcontractor shall be liable to the United States (in the case of work done under contract for the District of Columbia or a territory, to such District or to such territory), for liquidated damages. Such liquidated damages shall be computed with respect to each individual laborer or mechanic, including watchmen and guards, employed in violation of the clause set forth in paragraph (b)(1) of this section, in the sum of \$10 for each calendar day on which such individual was required or permitted to work in excess of the standard workweek of forty hours without payment of the overtime wages required by the clause set forth in paragraph (b)(1) of this section.
- (3) Withholding for unpaid wages and liquidated damages. The subrecipient shall upon the request of the EPA Award Official or an authorized representative of the Department of Labor, withhold or cause to be withheld, from any moneys payable on account of work performed by the contractor or subcontractor under any such contract or any other Federal contract with the same prime contractor, or any other federally-assisted contract subject to the Contract Work Hours and Safety Standards Act, which is held by the same prime contractor, such sums as may be determined to be necessary to satisfy any liabilities of such contractor or subcontractor for unpaid wages and liquidated damages as provided in the clause set forth in paragraph (b)(2) of this section.
- (4) Subcontracts. The contractor or subcontractor shall insert in any subcontracts the clauses set forth in paragraph (b)(1) through (4) of this section and also a clause requiring the subcontractors to include these clauses in any lower tier subcontracts. The prime contractor shall be responsible for compliance by any subcontractor or lower tier subcontractor with the clauses set forth in paragraphs (b)(1) through (4) of this section.

(c) In addition to the clauses contained in Item 3, above, in any contract subject only to the Contract Work Hours and Safety Standards Act and not to any of the other statutes cited in 29 CFR 5.1, the Subrecipient shall insert a clause requiring that the contractor or subcontractor shall maintain payrolls and basic payroll records during the course of the work and shall preserve them for a period of three years from the completion of the contract for all laborers and mechanics, including guards and watchmen, working on the contract. Such records shall contain the name and address of each such employee, social security number, correct classifications, hourly rates of wages paid, daily and weekly number of hours worked, deductions made, and actual wages paid. Further, the Subrecipient shall insert in any such contract a clause providing that the records to be maintained under this paragraph shall be made available by the contractor or subcontractor for inspection, copying, or transcription by authorized representatives of the (write the name of agency) and the Department of Labor, and the contractor or subcontractor will permit such representatives to interview employees during working hours on the job.

## **5. Compliance Verification**

(a). The subrecipient shall periodically interview a sufficient number of employees entitled to DB prevailing wages (covered employees) to verify that contractors or subcontractors are paying the appropriate wage rates. As provided in 29 CFR 5.6(a)(6), all interviews must be conducted in confidence. The subrecipient must use Standard Form 1445 (SF 1445) or equivalent documentation to memorialize the interviews. Copies of the SF 1445 are available from EPA on request.

(b) The subrecipient shall establish and follow an interview schedule based on its assessment of the risks of noncompliance with DB posed by contractors or subcontractors and the duration of the contract or subcontract. At a minimum, the subrecipient should conduct interviews with a representative group of covered employees within two weeks of each contractor or subcontractor's submission of its initial weekly payroll data and two weeks prior to the estimated completion date for the contract or subcontract. Subrecipients must conduct more frequent interviews if the initial interviews or other information indicates that there is a risk that the contractor or subcontractor is not complying with DB. Subrecipients shall immediately conduct necessary interviews in response to an alleged violation of the prevailing wage requirements. All interviews shall be conducted in confidence.

(c). The subrecipient shall periodically conduct spot checks of a representative sample of weekly payroll data to verify that contractors or subcontractors are paying the appropriate wage rates. The subrecipient shall establish and follow a spot check schedule based on its assessment of the risks of noncompliance with DB posed by contractors or subcontractors and the duration of the contract or subcontract. At a minimum, if practicable the subrecipient should spot check payroll data within two weeks of each contractor or subcontractor's submission of its initial payroll data and two weeks prior to the completion date the contract or subcontract. Subrecipients must conduct more frequent spot checks if the initial spot check or other information indicates that there is a risk that the contractor or subcontractor is not complying with DB . In addition, during the examinations the subrecipient shall verify evidence of fringe benefit plans and payments thereunder by contractors and subcontractors who claim credit for fringe benefit contributions.

(d). The subrecipient shall periodically review contractors and subcontractors use of apprentices and trainees to verify registration and certification with respect to apprenticeship and training programs approved by either the U.S Department of Labor or a state, as appropriate, and that contractors and subcontractors are not using disproportionate numbers of, laborers, trainees and apprentices. These reviews shall be conducted in accordance with the schedules for spot checks and interviews described in Item 5(b) and (c) above.

(e) Subrecipients must immediately report potential violations of the DB prevailing wage requirements to the EPA DB contact listed above and to the appropriate DOL Wage and Hour District Office listed at [https://www.dol.gov/whd/whd\\_district\\_offices.pdf](https://www.dol.gov/whd/whd_district_offices.pdf).





APPENDIX I

AMERICAN IRON AND STEEL REQUIREMENTS



UNITED STATES ENVIRONMENTAL PROTECTION AGENCY  
WASHINGTON, D.C. 20460

MAR 20 2014

OFFICE OF WATER

MEMORANDUM

SUBJECT: Implementation of American Iron and Steel provisions of P.L. 113-76, Consolidated Appropriations Act, 2014

FROM: Andrew D. Sawyer, Director  
Office of Wastewater Management (4201M)

Peter C. Grevatt, Director  
Office of Ground Water and Drinking Water (4601M)

TO: Water Management Division Directors  
Regions I - X

P.L. 113-76, Consolidated Appropriations Act, 2014 (Act), includes an "American Iron and Steel (AIS)" requirement in section 436 that requires Clean Water State Revolving Loan Fund (CWSRF) and Drinking Water State Revolving Loan Fund (DWSRF) assistance recipients to use iron and steel products that are produced in the United States for projects for the construction, alteration, maintenance, or repair of a public water system or treatment works if the project is funded through an assistance agreement executed beginning January 17, 2014 (enactment of the Act), through the end of Federal Fiscal Year 2014.

Section 436 also sets forth certain circumstances under which EPA may waive the AIS requirement. Furthermore, the Act specifically exempts projects where engineering plans and specifications were approved by a State agency prior to January 17, 2014.

The approach described below explains how EPA will implement the AIS requirement. The first section is in the form of questions and answers that address the types of projects that must comply with the AIS requirement, the types of products covered by the AIS requirement, and compliance. The second section is a step-by-step process for requesting waivers and the circumstances under which waivers may be granted.

## Implementation

The Act states:

Sec. 436 (a)(1) None of the funds made available by a State water pollution control revolving fund as authorized by title VI of the Federal Water Pollution Control Act (33 U.S.C. 1381 et seq.) or made available by a drinking water treatment revolving loan fund as authorized by section 1452 of the Safe Drinking Water Act (42 U.S.C. 300j-12) shall be used for a project for the construction, alteration, maintenance, or repair of a public water system or treatment works unless all of the iron and steel products used in the project are produced in the United States.

(2) In this section, the term “iron and steel products” means the following products made primarily of iron or steel: lined or unlined pipes and fittings, manhole covers and other municipal castings, hydrants, tanks, flanges, pipe clamps and restraints, valves, structural steel, reinforced precast concrete, and construction materials.

(b) Subsection (a) shall not apply in any case or category of cases in which the Administrator of the Environmental Protection Agency (in this section referred to as the “Administrator”) finds that—

(1) applying subsection (a) would be inconsistent with the public interest;

(2) iron and steel products are not produced in the United States in sufficient and reasonably available quantities and of a satisfactory quality; or

(3) inclusion of iron and steel products produced in the United States will increase the cost of the overall project by more than 25 percent.

(c) If the Administrator receives a request for a waiver under this section, the Administrator shall make available to the public on an informal basis a copy of the request and information available to the Administrator concerning the request, and shall allow for informal public input on the request for at least 15 days prior to making a finding based on the request. The Administrator shall make the request and accompanying information available by electronic means, including on the official public Internet Web site of the Environmental Protection Agency.

(d) This section shall be applied in a manner consistent with United States obligations under international agreements.

(e) The Administrator may retain up to 0.25 percent of the funds appropriated in this Act for the Clean and Drinking Water State Revolving Funds for carrying out the provisions described in subsection (a)(1) for management and oversight of the requirements of this section.

(f) This section does not apply with respect to a project if a State agency approves the engineering plans and specifications for the project, in that agency's capacity to approve such plans and specifications prior to a project requesting bids, prior to the date of the enactment of this Act.

The following questions and answers provide guidance for implementing and complying with the AIS requirements:

### **Project Coverage**

#### **1) What classes of projects are covered by the AIS requirement?**

All treatment works projects funded by a CWSRF assistance agreement, and all public water system projects funded by a DWSRF assistance agreement, from the date of enactment through the end of Federal Fiscal Year 2014, are covered. The AIS requirements apply to the entirety of the project, no matter when construction begins or ends. Additionally, the AIS requirements apply to all parts of the project, no matter the source of funding.

#### **2) Does the AIS requirement apply to nonpoint source projects or national estuary projects?**

No. Congress did not include an AIS requirement for nonpoint source and national estuary projects unless the project can also be classified as a 'treatment works' as defined by section 212 of the Clean Water Act.

#### **3) Are any projects for the construction, alteration, maintenance, or repair of a public water system or treatment works excluded from the AIS requirement?**

Any project, whether a treatment works project or a public water system project, for which engineering plans and specifications were approved by the responsible state agency prior to January 17, 2014, is excluded from the AIS requirements.

#### **4) What if the project does not have approved engineering plans and specifications but has signed an assistance agreement with a CWSRF or DWSRF program prior to January 17, 2014?**

The AIS requirements do not apply to any project for which an assistance agreement was signed prior to January 17, 2014.

#### **5) What if the project does not have approved engineering plans and specifications, but bids were advertised prior to January 17, 2014 and an assistance agreement was signed after January 17, 2014?**

If the project does not require approved engineering plans and specifications, the bid advertisement date will count in lieu of the approval date for purposes of the exemption in section 436(f).

**6) What if the assistance agreement that was signed prior to January 17, 2014, only funded a part of the overall project, where the remainder of the project will be funded later with another SRF loan?**

If the original assistance agreement funded any construction of the project, the date of the original assistance agreement counts for purposes of the exemption. If the original assistance agreement was only for planning and design, the date of that assistance agreement will count for purposes of the exemption only if there is a written commitment or expectation on the part of the assistance recipient to fund the remainder of the project with SRF funds.

**7) What if the assistance agreement that was signed prior to January 17, 2014, funded the first phase of a multi-phase project, where the remaining phases will be funded by SRF assistance in the future?**

In such a case, the phases of the project will be considered a single project if all construction necessary to complete the building or work, regardless of the number of contracts or assistance agreements involved, are closely related in purpose, time and place. However, there are many situations in which major construction activities are clearly undertaken in phases that are distinct in purpose, time, or place. In the case of distinct phases, projects with engineering plans and specifications approval or assistance agreements signed prior to January 17, 2014 would be excluded from AIS requirements while those approved/signed on January 17, 2014, or later would be covered by the AIS requirements.

**8) What if a project has split funding from a non-SRF source?**

Many States intend to fund projects with “split” funding, from the SRF program and from State or other programs. Based on the Act language in section 436, which requires that American iron and steel products be used in any project for the construction, alteration, maintenance, or repair of a public water system or treatment works receiving SRF funding between and including January 17, 2014 and September 30, 2014, any project that is funded in whole or in part with such funds must comply with the AIS requirement. A “project” consists of all construction necessary to complete the building or work regardless of the number of contracts or assistance agreements involved so long as all contracts and assistance agreements awarded are closely related in purpose, time and place. This precludes the intentional splitting of SRF projects into separate and smaller contracts or assistance agreements to avoid AIS coverage on some portion of a larger project, particularly where the activities are integrally and proximately related to the whole. However, there are many situations in which major construction activities are clearly undertaken in separate phases that are distinct in purpose, time, or place, in which case, separate contracts or assistance agreement for SRF and State or other funding would carry separate requirements.

## **9) What about refinancing?**

If a project began construction, financed from a non-SRF source, prior to January 17, 2014, but is refinanced through an SRF assistance agreement executed on or after January 17, 2014 and prior to October 1, 2014, AIS requirements will apply to all construction that occurs on or after January 17, 2014, through completion of construction, unless, as is likely, engineering plans and specifications were approved by a responsible state agency prior to January 17, 2014. There is no retroactive application of the AIS requirements where a refinancing occurs for a project that has completed construction prior to January 17, 2014.

## **10) Do the AIS requirements apply to any other EPA programs, besides the SRF program, such as the Tribal Set-aside grants or grants to the Territories and DC?**

No, the AIS requirement only applies to funds made available by a State water pollution control revolving fund as authorized by title VI of the Federal Water Pollution Control Act (33 U.S.C. 1381 et seq.) or made available by a drinking water treatment revolving loan fund as authorized by section 1452 of the Safe Drinking Water Act (42 U.S.C. 300j-12)

## **Covered Iron and Steel Products**

### **11) What is an iron or steel product?**

For purposes of the CWSRF and DWSRF projects that must comply with the AIS requirement, an iron or steel product is one of the following made primarily of iron or steel that is permanently incorporated into the public water system or treatment works:

- Lined or unlined pipes or fittings;
- Manhole Covers;
- Municipal Castings (defined in more detail below);
- Hydrants;
- Tanks;
- Flanges;
- Pipe clamps and restraints;
- Valves;
- Structural steel (defined in more detail below);
- Reinforced precast concrete; and
- Construction materials (defined in more detail below).

### **12) What does the term ‘primarily iron or steel’ mean?**

‘Primarily iron or steel’ places constraints on the list of products above. For one of the listed products to be considered subject to the AIS requirements, it must be made of

greater than 50% iron or steel, measured by cost. The cost should be based on the material costs.

**13) Can you provide an example of how to perform a cost determination?**

For example, the iron portion of a fire hydrant would likely be the bonnet, body and shoe, and the cost then would include the pouring and casting to create those components. The other material costs would include non-iron and steel internal workings of the fire hydrant (i.e., stem, coupling, valve, seals, etc). However, the assembly of the internal workings into the hydrant body would not be included in this cost calculation. If one of the listed products is not made primarily of iron or steel, United States (US) provenance is not required. An exception to this definition is reinforced precast concrete, which is addressed in a later question.

**14) If a product is composed of more than 50% iron or steel, but is not listed in the above list of items, must the item be produced in the US? Alternatively, must the iron or steel in such a product be produced in the US?**

The answer to both question is no. Only items on the above list must be produced in the US. Additionally, the iron or steel in a non-listed item can be sourced from outside the US.

**15) What is the definition of steel?**

Steel means an alloy that includes at least 50 percent iron, between .02 and 2 percent carbon, and may include other elements. Metallic elements such as chromium, nickel, molybdenum, manganese, and silicon may be added during the melting of steel for the purpose of enhancing properties such as corrosion resistance, hardness, or strength. The definition of steel covers carbon steel, alloy steel, stainless steel, tool steel and other specialty steels.

**16) What does ‘produced in the United States’ mean?**

Production in the United States of the iron or steel products used in the project requires that all manufacturing processes, including application of coatings, must take place in the United States, with the exception of metallurgical processes involving refinement of steel additives. All manufacturing processes includes processes such as melting, refining, forming, rolling, drawing, finishing, fabricating and coating. Further, if a domestic iron and steel product is taken out of the US for any part of the manufacturing process, it becomes foreign source material. However, raw materials such as iron ore, limestone and iron and steel scrap are not covered by the AIS requirement, and the material(s), if any, being applied as a coating are similarly not covered. Non-iron or steel components of an iron and steel product may come from non-US sources. For example, for products such as valves and hydrants, the individual non-iron and steel components do not have to be of domestic origin.

**17) Are the raw materials used in the production of iron or steel required to come from US sources?**

No. Raw materials, such as iron ore, limestone, scrap iron, and scrap steel, can come from non-US sources.

**18) If an above listed item is primarily made of iron or steel, but is only at the construction site temporarily, must such an item be produced in the US?**

No. Only the above listed products made primarily of iron or steel, permanently incorporated into the project must be produced in the US. For example trench boxes, scaffolding or equipment, which are removed from the project site upon completion of the project, are not required to be made of U.S. Iron or Steel.

**19) What is the definition of ‘municipal castings’?**

Municipal castings are cast iron or steel infrastructure products that are melted and cast. They typically provide access, protection, or housing for components incorporated into utility owned drinking water, storm water, wastewater, and surface infrastructure. They are typically made of grey or ductile iron, or steel. Examples of municipal castings are:

- Access Hatches;
- Ballast Screen;
- Benches (Iron or Steel);
- Bollards;
- Cast Bases;
- Cast Iron Hinged Hatches, Square and Rectangular;
- Cast Iron Riser Rings;
- Catch Basin Inlet;
- Cleanout/Monument Boxes;
- Construction Covers and Frames;
- Curb and Corner Guards;
- Curb Openings;
- Detectable Warning Plates;
- Downspout Shoes (Boot, Inlet);
- Drainage Grates, Frames and Curb Inlets;
- Inlets;
- Junction Boxes;
- Lampposts;
- Manhole Covers, Rings and Frames, Risers;
- Meter Boxes;
- Service Boxes;
- Steel Hinged Hatches, Square and Rectangular;
- Steel Riser Rings;
- Trash receptacles;
- Tree Grates;



Tree Guards;  
Trench Grates; and  
Valve Boxes, Covers and Risers.

## **20) What is ‘structural steel’?**

Structural steel is rolled flanged shapes, having at least one dimension of their cross-section three inches or greater, which are used in the construction of bridges, buildings, ships, railroad rolling stock, and for numerous other constructional purposes. Such shapes are designated as wide-flange shapes, standard I-beams, channels, angles, tees and zees. Other shapes include H-piles, sheet piling, tie plates, cross ties, and those for other special purposes.

## **21) What is a ‘construction material’ for purposes of the AIS requirement?**

Construction materials are those articles, materials, or supplies made primarily of iron and steel, that are permanently incorporated into the project, not including mechanical and/or electrical components, equipment and systems. Some of these products may overlap with what is also considered “structural steel”. This includes, but is not limited to, the following products: wire rod, bar, angles, concrete reinforcing bar, wire, wire cloth, wire rope and cables, tubing, framing, joists, trusses, fasteners (i.e., nuts and bolts), welding rods, decking, grating, railings, stairs, access ramps, fire escapes, ladders, wall panels, dome structures, roofing, ductwork, surface drains, cable hanging systems, manhole steps, fencing and fence tubing, guardrails, doors, and stationary screens.

## **22) What is not considered a ‘construction material’ for purposes of the AIS requirement?**

Mechanical and electrical components, equipment and systems are not considered construction materials. Mechanical equipment is typically that which has motorized parts and/or is powered by a motor. Electrical equipment is typically any machine powered by electricity and includes components that are part of the electrical distribution system.

The following examples (including their appurtenances necessary for their intended use and operation) are NOT considered construction materials: pumps, motors, gear reducers, drives (including variable frequency drives (VFDs)), electric/pneumatic/manual accessories used to operate valves (such as electric valve actuators), mixers, gates, motorized screens (such as traveling screens), blowers/aeration equipment, compressors, meters, sensors, controls and switches, supervisory control and data acquisition (SCADA), membrane bioreactor systems, membrane filtration systems, filters, clarifiers and clarifier mechanisms, rakes, grinders, disinfection systems, presses (including belt presses), conveyors, cranes, HVAC (excluding ductwork), water heaters, heat exchangers, generators, cabinetry and housings (such as electrical boxes/enclosures), lighting fixtures, electrical conduit, emergency life systems, metal office furniture, shelving, laboratory equipment, analytical instrumentation, and dewatering equipment.

**23) If the iron or steel is produced in the US, may other steps in the manufacturing process take place outside of the US, such as assembly?**

No. Production in the US of the iron or steel used in a listed product requires that all manufacturing processes must take place in the United States, except metallurgical processes involving refinement of steel additives.

**24) What processes must occur in the US to be compliant with the AIS requirement for reinforced precast concrete?**

While reinforced precast concrete may not be at least 50% iron or steel, in this particular case, the reinforcing bar and wire must be produced in the US and meet the same standards as for any other iron or steel product. Additionally, the casting of the concrete product must take place in the US. The cement and other raw materials used in concrete production are not required to be of domestic origin.

If the reinforced concrete is cast at the construction site, the reinforcing bar and wire are considered to be a construction material and must be produced in the US.

**Compliance**

**25) How should an assistance recipient document compliance with the AIS requirement?**

In order to ensure compliance with the AIS requirement, specific AIS contract language must be included in each contract, starting with the assistance agreement, all the way down to the purchase agreements. Sample language for assistance agreements and contracts can be found in Appendix 3 and 4.

EPA recommends the use of a step certification process, similar to one used by the Federal Highway Administration. The step certification process is a method to ensure that producers adhere to the AIS requirement and assistance recipients can verify that products comply with the AIS requirement. The process also establishes accountability and better enables States to take enforcement actions against violators.

Step certification creates a paper trail which documents the location of the manufacturing process involved with the production of steel and iron materials. A step certification is a process under which each handler (supplier, fabricator, manufacturer, processor, etc) of the iron and steel products certifies that their step in the process was domestically performed. Each time a step in the manufacturing process takes place, the manufacturer delivers its work along with a certification of its origin. A certification can be quite simple. Typically, it includes the name of the manufacturer, the location of the manufacturing facility where the product or process took place (not its headquarters), a description of the product or item being delivered, and a signature by a manufacturer's responsible party. Attached, as Appendix 5, are sample certifications. These certifications should be collected and maintained by assistance recipients.

Alternatively, the final manufacturer that delivers the iron or steel product to the worksite, vendor, or contractor, may provide a certification asserting that all manufacturing processes occurred in the US. While this type of certification may be acceptable, it may not provide the same degree of assurance. Additional documentation may be needed if the certification is lacking important information. Step certification is the best practice.

**26) How should a State ensure assistance recipients are complying with the AIS requirement?**

In order to ensure compliance with the AIS requirement, States SRF programs must include specific AIS contract language in the assistance agreement. Sample language for assistance agreements can be found in Appendix 3.

States should also, as a best practice, conduct site visits of projects during construction and review documentation demonstrating proof of compliance which the assistance recipient has gathered.

**27) What happens if a State or EPA finds a non-compliant iron and/or steel product permanently incorporated in the project?**

If a potentially non-compliant product is identified, the State should notify the assistance recipient of the apparent unauthorized use of the non-domestic component, including a proposed corrective action, and should be given the opportunity to reply. If unauthorized use is confirmed, the State can take one or more of the following actions: request a waiver where appropriate; require the removal of the non-domestic item; or withhold payment for all or part of the project. Only EPA can issue waivers to authorize the use of a non-domestic item. EPA may use remedies available to it under the Clean Water Act, the Safe Drinking Water Act, and 40 CFR part 31 grant regulations, in the event of a violation of a grant term and condition.

It is recommended that the State work collaboratively with EPA to determine the appropriate corrective action, especially in cases where the State is the one who identifies the item in noncompliance or there is a disagreement with the assistance recipient.

If fraud, waste, abuse, or any violation of the law is suspected, the Office of Inspector General (OIG) should be contacted immediately. The OIG can be reached at 1-888-546-8740 or [OIG\\_Hotline@epa.gov](mailto:OIG_Hotline@epa.gov). More information can be found at this website: <http://oig.hhs.gov/fraud/report-fraud/>

**28) How do international trade agreements affect the implementation of the AIS requirements?**

The AIS provision applies in a manner consistent with United States obligations under international agreements. Typically, these obligations only apply to direct procurement by the entities that are signatories to such agreements. In general, SRF

assistance recipients are not signatories to such agreements, so these agreements have no impact on this AIS provision. In the few instances where such an agreement applies to a municipality, that municipality is under the obligation to determine its applicability and requirements and document the actions taken to comply for the State.

### **Waiver Process**

The statute permits EPA to issue waivers for a case or category of cases where EPA finds (1) that applying these requirements would be inconsistent with the public interest; (2) iron and steel products are not produced in the US in sufficient and reasonably available quantities and of a satisfactory quality; or (3) inclusion of iron and steel products produced in the US will increase the cost of the overall project by more than 25 percent.

In order to implement the AIS requirements, EPA has developed an approach to allow for effective and efficient implementation of the waiver process to allow projects to proceed in a timely manner. The framework described below will allow States, on behalf of the assistance recipients, to apply for waivers of the AIS requirement directly to EPA Headquarters. Only waiver requests received from states will be considered. Pursuant to the Act, EPA has the responsibility to make findings as to the issuance of waivers to the AIS requirements.

### **Definitions**

The following terms are critical to the interpretation and implementation of the AIS requirements and apply to the process described in this memorandum:

Reasonably Available Quantity: The quantity of iron or steel products is available or will be available at the time needed and place needed, and in the proper form or specification as specified in the project plans and design.

Satisfactory Quality: The quality of iron or steel products, as specified in the project plans and designs.

Assistance Recipient: A borrower or grantee that receives funding from a State CWSRF or DWSRF program.

### **Step-By-Step Waiver Process**

#### **Application by Assistance Recipient**

Each local entity that receives SRF water infrastructure financial assistance is required by section 436 of the Act to use American made iron and steel products in the construction of its project. However, the recipient may request a waiver. Until a waiver is granted by EPA, the AIS requirement stands, except as noted above with respect to municipalities covered by international agreements.

The waiver process begins with the SRF assistance recipient. In order to fulfill the AIS requirement, the assistance recipient must in good faith design the project (where applicable) and solicit bids for construction with American made iron and steel products. It is essential that the assistance recipient include the AIS terms in any request for proposals or solicitations for bids, and in all contracts (see Appendix 3 for sample construction contract language). The assistance recipient may receive a waiver at any point before, during, or after the bid process, if one or more of three conditions is met:

1. Applying the American Iron and Steel requirements of the Act would be inconsistent with the public interest;
2. Iron and steel products are not produced in the United States in sufficient and reasonably available quantities and of a satisfactory quality; or
3. Inclusion of iron and steel products produced in the United States will increase the cost of the overall project by more than 25 percent.

Proper and sufficient documentation must be provided by the assistance recipient. A checklist detailing the types of information required for a waiver to be processed is attached as Appendix 1.

Additionally, it is strongly encouraged that assistance recipients hold pre-bid conferences with potential bidders. A pre-bid conference can help to identify iron and steel products needed to complete the project as described in the plans and specifications that may not be available from domestic sources. It may also identify the need to seek a waiver prior to bid, and can help inform the recipient on compliance options.

In order to apply for a project waiver, the assistance recipient should email the request in the form of a Word document (.doc) to the State SRF program. It is strongly recommended that the State designate a single person for all AIS communications. The State SRF designee will review the application for the waiver and determine whether the necessary information has been included. Once the waiver application is complete, the State designee will forward the application to either of two email addresses. For CWSRF waiver requests, please send the application to: [cwsrfwaiver@epa.gov](mailto:cwsrfwaiver@epa.gov). For DWSRF waiver requests, please send the application to: [dwsrfwaiver@epa.gov](mailto:dwsrfwaiver@epa.gov).

### Evaluation by EPA

After receiving an application for waiver of the AIS requirements, EPA Headquarters will publish the request on its website for 15 days and receive informal comment. EPA Headquarters will then use the checklist in Appendix 2 to determine whether the application properly and adequately documents and justifies the statutory basis cited for the waiver – that it is quantitatively and qualitatively sufficient – and to determine whether or not to grant the waiver.

In the event that EPA finds that adequate documentation and justification has been submitted, the Administrator may grant a waiver to the assistance recipient. EPA will notify the State designee that a waiver request has been approved or denied as soon as such a decision has been made. Granting such a waiver is a three-step process:

1. Posting – After receiving an application for a waiver, EPA is required to publish the application and all material submitted with the application on EPA’s website for 15 days. During that period, the public will have the opportunity to review the request and provide informal comment to EPA. The website can be found at: [http://water.epa.gov/grants\\_funding/aisrequirement.cfm](http://water.epa.gov/grants_funding/aisrequirement.cfm)
2. Evaluation – After receiving an application for waiver of the AIS requirements, EPA Headquarters will use the checklist in Appendix 2 to determine whether the application properly and adequately documents and justifies the statutory basis cited for the waiver – that it is quantitatively and qualitatively sufficient – and to determine whether or not to grant the waiver.
3. Signature of waiver approval by the Administrator or another agency official with delegated authority – As soon as the waiver is signed and dated, EPA will notify the State SRF program, and post the signed waiver on our website. The assistance recipient should keep a copy of the signed waiver in its project files.

### Public Interest Waivers

EPA has the authority to issue public interest waivers. Evaluation of a public interest waiver request may be more complicated than that of other waiver requests so they may take more time than other waiver requests for a decision to be made. An example of a public interest waiver that might be issued could be for a community that has standardized on a particular type or manufacturer of a valve because of its performance to meet their specifications. Switching to an alternative valve may require staff to be trained on the new equipment and additional spare parts would need to be purchased and stocked, existing valves may need to be unnecessarily replaced, and portions of the system may need to be redesigned. Therefore, requiring the community to install an alternative valve would be inconsistent with public interest.

EPA also has the authority to issue a public interest waiver that covers categories of products that might apply to all projects.

EPA reserves the right to issue national waivers that may apply to particular classes of assistance recipients, particular classes of projects, or particular categories of iron or steel products. EPA may develop national or (US geographic) regional categorical waivers through the identification of similar circumstances in the detailed justifications presented to EPA in a waiver request or requests. EPA may issue a national waiver based on policy decisions regarding the public’s interest or a determination that a particular item is not produced domestically in reasonably available quantities or of a sufficient quality. In such cases, EPA may determine it is necessary to issue a national waiver.

If you have any questions concerning the contents of this memorandum, you may contact us, or have your staff contact Jordan Dorfman, Attorney-Advisor, State Revolving Fund Branch, Municipal Support Division, at [dorfman.jordan@epa.gov](mailto:dorfman.jordan@epa.gov) or (202) 564-0614 or Kiri Anderer, Environmental Engineer, Infrastructure Branch, Drinking Water Protection Division, at [anderer.kirsten@epa.gov](mailto:anderer.kirsten@epa.gov) or (202) 564-3134.

Attachments

**Attachment 1: Information Checklist for Waiver Request**

The purpose of this checklist is to help ensure that all appropriate and necessary information is submitted to EPA. EPA recommends that States review this checklist carefully and provide all appropriate information to EPA. This checklist is for informational purposes only and does not need to be included as part of a waiver application.

Items	✓	Notes
<p><b>General</b></p> <ul style="list-style-type: none"> <li>• Waiver request includes the following information:               <ul style="list-style-type: none"> <li>— Description of the foreign and domestic construction materials</li> <li>— Unit of measure</li> <li>— Quantity</li> <li>— Price</li> <li>— Time of delivery or availability</li> <li>— Location of the construction project</li> <li>— Name and address of the proposed supplier</li> <li>— A detailed justification for the use of foreign construction materials</li> </ul> </li> <li>• Waiver request was submitted according to the instructions in the memorandum</li> <li>• Assistance recipient made a good faith effort to solicit bids for domestic iron and steel products, as demonstrated by language in requests for proposals, contracts, and communications with the prime contractor</li> </ul>	✓	
<p><b>Cost Waiver Requests</b></p> <ul style="list-style-type: none"> <li>• Waiver request includes the following information:               <ul style="list-style-type: none"> <li>— Comparison of overall cost of project with domestic iron and steel products to overall cost of project with foreign iron and steel products</li> <li>— Relevant excerpts from the bid documents used by the contractors to complete the comparison</li> <li>— Supporting documentation indicating that the contractor made a reasonable survey of the market, such as a description of the process for identifying suppliers and a list of contacted suppliers</li> </ul> </li> </ul>		
<p><b>Availability Waiver Requests</b></p> <ul style="list-style-type: none"> <li>• Waiver request includes the following supporting documentation necessary to demonstrate the availability, quantity, and/or quality of the materials for which the waiver is requested:               <ul style="list-style-type: none"> <li>— Supplier information or pricing information from a reasonable number of domestic suppliers indicating availability/delivery date for construction materials</li> <li>— Documentation of the assistance recipient's efforts to find available domestic sources, such as a description of the process for identifying suppliers and a list of contacted suppliers.</li> <li>— Project schedule</li> <li>— Relevant excerpts from project plans, specifications, and permits indicating the required quantity and quality of construction materials</li> </ul> </li> <li>• Waiver request includes a statement from the prime contractor and/or supplier confirming the non-availability of the domestic construction materials for which the waiver is sought</li> <li>• Has the State received other waiver requests for the materials described in this waiver request, for comparable projects?</li> </ul>		



**Attachment 2: HQ Review Checklist for Waiver Request**

Instructions: To be completed by EPA. Review all waiver requests using the questions in the checklist, and mark the appropriate box as Yes, No or N/A. Marks that fall inside the shaded boxes may be grounds for denying the waiver. If none of your review markings fall into a shaded box, the waiver is eligible for approval if it indicates that one or more of the following conditions applies to the domestic product for which the waiver is sought:

1. The iron and/or steel products are not produced in the United States in sufficient and reasonably available quantities and of a satisfactory quality.
2. The inclusion of iron and/or steel products produced in the United States will increase the cost of the overall project by more than 25 percent.

Review Items	Yes	No	N/A	Comments
<p>Cost Waiver Requests</p> <ul style="list-style-type: none"> <li>• Does the waiver request include the following information?                             <ul style="list-style-type: none"> <li>— Comparison of overall cost of project with domestic iron and steel products to overall cost of project with foreign iron and steel products</li> <li>— Relevant excerpts from the bid documents used by the contractors to complete the comparison</li> <li>— A sufficient number of bid documents or pricing information from domestic sources to constitute a reasonable survey of the market</li> </ul> </li> <li>• Does the Total Domestic Project exceed the Total Foreign Project Cost by more than 25%?</li> </ul>				
<p>Availability Waiver Requests</p> <ul style="list-style-type: none"> <li>• Does the waiver request include supporting documentation sufficient to show the availability, quantity, and/or quality of the iron and/or steel product for which the waiver is requested?                             <ul style="list-style-type: none"> <li>— Supplier information or other documentation indicating availability/delivery date for materials</li> <li>— Project schedule</li> <li>— Relevant excerpts from project plans, specifications, and permits indicating the required quantity and quality of materials</li> </ul> </li> <li>• Does supporting documentation provide sufficient evidence that the contractors made a reasonable effort to locate domestic suppliers of materials, such as a description of the process for identifying suppliers and a list of contacted suppliers?</li> <li>• Based on the materials delivery/availability date indicated in the supporting documentation, will the materials be unavailable when they are needed according to the project schedule? (By item, list schedule date and domestic delivery quote date or other relevant information)</li> <li>• Is EPA aware of any other evidence indicating the non-availability of the materials for which the waiver is requested?</li> </ul> <p>Examples include:</p> <ul style="list-style-type: none"> <li>— Multiple waiver requests for the materials described in this waiver request, for comparable projects in the same State</li> <li>— Multiple waiver requests for the materials described in this waiver request, for comparable projects in other States</li> <li>— Correspondence with construction trade associations indicating the non-availability of the materials</li> </ul> <ul style="list-style-type: none"> <li>• Are the available domestic materials indicated in the bid documents of inadequate quality compared those required by the project plans, specifications, and/or permits?</li> </ul>				

### **Attachment 3: Example Loan Agreement Language**

ALL ASSISTANCE AGREEMENT MUST HAVE A CLAUSE REQUIRING COMPLIANCE WITH THE AIS REQUIREMENT. THIS IS AN EXAMPLE OF WHAT COULD BE INCLUDED IN SRF ASSISTANCE AGREEMENTS. EPA MAKES NO CLAIMS REGARDING THE LEGALITY OF THIS CLAUSE WITH RESPECT TO STATE LAW:

Comply with all federal requirements applicable to the Loan (including those imposed by the 2014 Appropriations Act and related SRF Policy Guidelines) which the Participant understands includes, among other, requirements that all of the iron and steel products used in the Project are to be produced in the United States (“American Iron and Steel Requirement”) unless (i) the Participant has requested and obtained a waiver from the Agency pertaining to the Project or (ii) the Finance Authority has otherwise advised the Participant in writing that the American Iron and Steel Requirement is not applicable to the Project.

Comply with all record keeping and reporting requirements under the Clean Water Act/Safe Drinking Water Act, including any reports required by a Federal agency or the Finance Authority such as performance indicators of program deliverables, information on costs and project progress. The Participant understands that (i) each contract and subcontract related to the Project is subject to audit by appropriate federal and state entities and (ii) failure to comply with the Clean Water Act/Safe Drinking Water Act and this Agreement may be a default hereunder that results in a repayment of the Loan in advance of the maturity of the Bonds and/or other remedial actions.

#### Attachment 4: Sample Construction Contract Language

ALL CONTRACTS MUST HAVE A CLAUSE REQUIRING COMPLIANCE WITH THE AIS REQUIREMENT. THIS IS AN EXAMPLE OF WHAT COULD BE INCLUDED IN ALL CONTRACTS IN PROJECTS THAT USE SRF FUNDS. EPA MAKES NO CLAIMS REGARDING THE LEGALITY OF THIS CLAUSE WITH RESPECT TO STATE OR LOCAL LAW:

The Contractor acknowledges to and for the benefit of the City of \_\_\_\_\_ (“Purchaser”) and the \_\_\_\_\_ (the “State”) that it understands the goods and services under this Agreement are being funded with monies made available by the Clean Water State Revolving Fund and/or Drinking Water State Revolving Fund that have statutory requirements commonly known as “American Iron and Steel;” that requires all of the iron and steel products used in the project to be produced in the United States (“American Iron and Steel Requirement”) including iron and steel products provided by the Contractor pursuant to this Agreement. The Contractor hereby represents and warrants to and for the benefit of the Purchaser and the State that (a) the Contractor has reviewed and understands the American Iron and Steel Requirement, (b) all of the iron and steel products used in the project will be and/or have been produced in the United States in a manner that complies with the American Iron and Steel Requirement, unless a waiver of the requirement is approved, and (c) the Contractor will provide any further verified information, certification or assurance of compliance with this paragraph, or information necessary to support a waiver of the American Iron and Steel Requirement, as may be requested by the Purchaser or the State. Notwithstanding any other provision of this Agreement, any failure to comply with this paragraph by the Contractor shall permit the Purchaser or State to recover as damages against the Contractor any loss, expense, or cost (including without limitation attorney’s fees) incurred by the Purchaser or State resulting from any such failure (including without limitation any impairment or loss of funding, whether in whole or in part, from the State or any damages owed to the State by the Purchaser). While the Contractor has no direct contractual privity with the State, as a lender to the Purchaser for the funding of its project, the Purchaser and the Contractor agree that the State is a third-party beneficiary and neither this paragraph (nor any other provision of this Agreement necessary to give this paragraph force or effect) shall be amended or waived without the prior written consent of the State.

## Attachment 5: Sample Certification 1

The following information is provided as a sample letter of step certification for AIS compliance. Documentation must be provided on company letterhead.

Date

Company Name

Company Address

City, State Zip

Subject: American Iron and Steel Step Certification for Project (XXXXXXXXXX)

I, (company representative), certify that the (melting, bending, coating, galvanizing, cutting, etc.) process for (manufacturing or fabricating) the following products and/or materials shipped or provided for the subject project is in full compliance with the American Iron and Steel requirement as mandated in EPA's State Revolving Fund Programs.

Item, Products and/or Materials:

1. XXXX
2. XXXX
3. XXXX

Such process took place at the following location:

If any of the above compliance statements change while providing material to this project we will immediately notify the prime contractor and the engineer.

Signed by company representative

## Attachment 5: Sample Certification 2

The following information is provided as a sample letter of certification for AIS compliance. Documentation must be provided on company letterhead.

Date

Company Name

Company Address

City, State Zip

Subject: American Iron and Steel Certification for Project (XXXXXXXXXX)

I, (company representative), certify that the following products and/or materials shipped/provided to the subject project are in full compliance with the American Iron and Steel requirement as mandated in EPA's State Revolving Fund Programs.

Item, Products and/or Materials:

1. XXXX
2. XXXX
3. XXXX

Such process took place at the following location:

If any of the above compliance statements change while providing material to this project we will immediately notify the prime contractor and the engineer.

Signed by company representative

**ATTACHMENT D**

**Massachusetts Diesel Retrofit Certifications**



## **DIESEL RETROFIT PROGRAM**

The Department of Environmental Protection (“DEP”) has developed the Diesel Retrofit Program in response to increasing public health concerns with the emissions from diesel engines and vehicles.

### **Diesel Construction Equipment Standard**

All diesel powered non-road construction equipment and vehicles greater than 50 brake horsepower which will be used in the performance of the work under the Contract (hereinafter “Diesel Construction Equipment”) must have the following pollution control device installed unless exempt as provided below:

1. Emission control technology verified by U.S. Environmental Protection Agency (“EPA”) or the California Air Resources Board (“CARB”) for use with non-road engines;
2. Emission control technology verified by EPA or CARB for use with on-road engines provided that such equipment is operated with diesel fuel that has no more than 15 parts per million sulfur content (i.e. Ultra Low Sulfur Diesel fuel); or
3. Emission control technology certified by the manufacturer that such technology meets or exceeds the emission reductions provided by on-road or off-road emission control technology verified by EPA or CARB, i.e. that a Diesel Oxidation Catalyst is achieving the following minimum emission reductions: particulate matter 20%; carbon monoxide 40%; volatile organic compounds 50%; or a Diesel Particulate Filter is achieving a minimum of 85% emission reductions for particulate matter.

Emission control devices, such as oxidation catalysts or particulate filters, shall be installed on the exhaust system side of the Diesel Construction Equipment. The Contractor shall be responsible to insure that the emissions control technology is operated, maintained, and serviced as recommended by the manufacturer.

For the latest up-to-date list of EPA verified-technologies, see:

<https://www.epa.gov/verified-diesel-tech>

For the latest up-to-date list of CARB verified technologies, see:

<http://www.arb.ca.gov/diesel/verdev/vt/cvt.htm>

### **Exemptions**

The following Diesel Construction Equipment shall be exempt from the standard above. The Contractor shall include such Diesel Construction Equipment in the required recordkeeping:

1. Diesel Construction Equipment not owned by the Contractor and used in the performance of the work under this Contract for 30 calendar days (cumulative days but not necessarily consecutive) or less;
2. Unless otherwise exempt, additional Diesel Construction Equipment originally not anticipated to be used under the Contract or used as permanent replacement after the work under the Contract has commenced, for 15 calendar days from the date such Diesel Construction Equipment is brought on site;



## **DIESEL RETROFIT PROGRAM**

3. Diesel Construction Equipment with an engine that meets the EPA particulate matter (PM) Tier emission standards in effect at the start of the Contract for non-road diesel engines for the applicable engine power group (e.g., as of January 1, 2009, a piece of Diesel Construction Equipment with a Tier 3 engine is exempt from meeting the standard until the piece of Diesel Construction Equipment is available with a Tier 4 engine) provided that if such emissions standards are superseded during the Contract then such Diesel Construction Equipment must be retrofitted in accordance with the standards above prior to the end of the Contract;
4. A large crane (e.g. a sky crane or link belt crane which is responsible for critical lift operations) if such device would adversely affect the operation of the crane provided the Contractor submits to the municipality's project engineer written technical justification documenting the adverse impact on operation; and
5. Diesel Construction Equipment that the project engineer has determined is necessary to control a compelling emergency including but not limited to, the need for rescue vehicles or other equipment to prevent harm to human beings or additional equipment required to address a catastrophic emergency such as structure collapse or imminent collapse. After the compelling emergency is controlled, such non-compliant equipment must be removed from the Contract site and may not be used in further performance of the work under this Contract. Meeting Contract deadlines is not a compelling emergency.

### **Contractor Certification**

Each bidder shall submit as part of its bid, the Statement of Intent to Comply. Within 10 days of being notified that it has been awarded a contract, the bidder and each of its Contractors and Subcontractors shall submit a Diesel Retrofit Program Contractor Certification. Each such Certification shall contain the following information for each piece of Diesel Construction Equipment:

1. Contractor or Subcontractor name;
2. Equipment type, make, model;
3. Vehicle Identification Number or VIN;
4. Engine model and year of manufacture;
5. Engine HP rating;
6. Emission Control Device (ECD) type (Diesel Oxidation Catalyst or Diesel Particulate Filter);
7. ECD make, model, and manufacturer;
8. ECD EPA or CARB Verification Number or manufacturer's certification that the DOC or DPF meets or exceeds emission reductions provided by similar emission control technology verified by EPA or CARB;
9. ECD installation date;
10. Type of fuel to be used; and
11. Whether the equipment is owned or rented.

### **Recordkeeping**

Each Contractor and Subcontractor shall maintain detailed records of all Diesel Construction Equipment used under the Contract, including the dates and duration times the Diesel Construction Equipment is

## **DIESEL RETROFIT PROGRAM**

used at the Contract site. Records shall be available for inspection by DEP. Each Contractor and Subcontractor shall notify DEP within 48 hours of any new Diesel Construction Equipment brought onto the Contract site.

For Diesel Construction Equipment that has an emissions control device with a manufacturer's certification, the Contractor shall maintain records of all supporting emissions test data and test procedures. If upon review the emissions reductions are not supported by the test data and test procedures, then the emissions control device may need to be replaced with a compliant retrofit device.

### **Project Regulatory Agreement**

The following language shall be included section 4 (Covenants of the Borrower) of the municipality's Project Regulatory Agreement if it receives funds from the State Revolving Fund:

The Borrower shall require each Contractor and Subcontractor to submit the Diesel Retrofit Program Contractor Certification to DEP and the Borrower prior to commencing work on the Project. The Borrower shall not allow any Contractor or Subcontractor to commence work at the Project site prior to submitting such Certification.

**DIESEL RETROFIT  
PROGRAM**

**STATEMENT OF INTENT TO COMPLY**

*This form must be signed and submitted by the bidder as part of the bid.*

**Local Governmental Unit** \_\_\_\_\_ **SRF Project No.** \_\_\_\_\_

**Contract No.** \_\_\_\_\_ **Contact Title** \_\_\_\_\_

**Bidder** \_\_\_\_\_

**The undersigned, on behalf of the above-named Bidder, agrees that, if awarded the Contract:**

- 1. the Bidder shall comply with the Massachusetts Department of Environmental Protection's ("MassDEP") Diesel Retrofit Program by ensuring that all diesel powered non-road construction equipment and vehicles greater than 50 brake horsepower which will be used in the performance of the work under the Contract are equipped or retrofitted with a pollution control device in accordance with the Diesel Retrofit Program Standard;**
- 2. the Bidder shall require all Subcontractors to comply with MassDEP's Diesel Retrofit Program by ensuring all diesel powered non-road construction equipment and vehicles greater than 50 brake horsepower which will be used in the performance of the work under the Contract are equipped or retrofitted with a pollution control device in accordance with the Diesel Retrofit Program Standard; and**
- 3. The Bidder shall submit and shall require each Subcontractor to submit a Diesel Retrofit Program Contractor Certification (form attached) with a Diesel Retrofit List to MassDEP Municipal Services and the Bidder within 10 days of the bidder being notified that it has been awarded the Contract. The Bidder shall require each Subcontractor to update such Certification and List within 2 days of using additional Diesel Construction Equipment on the project under the Contract.**

\_\_\_\_\_  
**(Signature of Bidder's Authorized Representative)** **(Date)**

**DIESEL RETROFIT PROGRAM CONTRACTOR CERTIFICATION**

*Each Contractor and its Subcontractor(s) must sign and email this form to the DEP DMS project engineer, within 10 days after the contractor is awarded.*

**Local Governmental Unit** \_\_\_\_\_ **SRF Project No.** \_\_\_\_\_

**Contract No.** \_\_\_\_\_ **Contact Title** \_\_\_\_\_

**Contractor** \_\_\_\_\_

I, \_\_\_\_\_, an authorized signatory for \_\_\_\_\_, whose principal place of business is at \_\_\_\_\_ do hereby certify that any and all diesel powered non-road construction equipment and vehicles greater than 50 brake horsepower which will be used in the performance of the work under the Contract (hereinafter "Diesel Construction Equipment") have pollution control devices, such as oxidation catalysts or particulate filters, installed on the exhaust system side of the diesel combustion engine equipment in accordance with the Diesel Retrofit Program Standard.

I am submitting on behalf of \_\_\_\_\_ a list of all said Diesel Construction Equipment, labeled "Diesel Retrofit List," that will be used in connection with this Contract by \_\_\_\_\_. I hereby certify that the information on the attached Diesel Retrofit List is correct and accurate as of the date of signature. The List includes the following information for each piece of Diesel Construction Equipment:

1. Equipment type, make, model;
2. Vehicle Identification Number or VIN;
3. Engine model and year of manufacture;
4. Engine HP rating;
5. Emission Control Device ("ECD") type (Diesel Oxidation Catalyst or Diesel Particulate Filter);
6. ECD make, model, and manufacturer;
7. ECD EPA or CARB Verification Number or manufacturer's certification that the DOC or DPF meets or exceeds emission reductions provided by similar emission control technology verified by EPA or CARB;
8. ECD installation date;
9. Type of fuel to be used; and
10. Whether the equipment is owned or rented.

**DIESEL RETROFIT PROGRAM CONTRACTOR CERTIFICATION**

\_\_\_\_\_ shall notify DEP within 48 hours of any new Diesel Construction Equipment brought onto the Contract site. \_\_\_\_\_ shall maintain detailed records of all Diesel Construction Equipment used at the Contract site, including the dates and duration times the Diesel Construction Equipment is used at the Contract site. \_\_\_\_\_ shall make such records available for inspection by DEP. \_\_\_\_\_ shall ensure that the emissions control technology for each piece of Diesel Construction Equipment is operated, maintained, and serviced as recommended by the manufacturer. \_\_\_\_\_ shall retrofit prior to the end of the Contract any Diesel Construction Equipment no longer exempt from meeting the Diesel Construction Equipment Standard under exemption 3 (because it had an engine that met the EPA particulate matter (PM) Tier emission standards currently in effect at the start of the Contract for non-road diesel engines for the applicable engine power group and such emissions standards were superseded during the Contract).

I acknowledge that this certificate is being furnished as a requirement under this Contract and is subject to applicable State and federal laws, both criminal and civil. Signed under pains and penalty of perjury on this date \_\_\_\_\_.

Signature \_\_\_\_\_

Name: \_\_\_\_\_

Title: \_\_\_\_\_

## **Appendix e**

### **American Iron and Steel Requirements**





UNITED STATES ENVIRONMENTAL PROTECTION AGENCY  
WASHINGTON, D.C. 20460

MAR 20 2014

OFFICE OF WATER

MEMORANDUM

SUBJECT: Implementation of American Iron and Steel provisions of P.L. 113-76,  
Consolidated Appropriations Act, 2014

FROM: Andrew D. Sawyers, Director   
Office of Wastewater Management (4201M)

Peter C. Grevatt, Director   
Office of Ground Water and Drinking Water (4601M)

TO: Water Management Division Directors  
Regions I - X

P.L. 113-76, Consolidated Appropriations Act, 2014 (Act), includes an "American Iron and Steel (AIS)" requirement in section 436 that requires Clean Water State Revolving Loan Fund (CWSRF) and Drinking Water State Revolving Loan Fund (DWSRF) assistance recipients to use iron and steel products that are produced in the United States for projects for the construction, alteration, maintenance, or repair of a public water system or treatment works if the project is funded through an assistance agreement executed beginning January 17, 2014 (enactment of the Act), through the end of Federal Fiscal Year 2014.

Section 436 also sets forth certain circumstances under which EPA may waive the AIS requirement. Furthermore, the Act specifically exempts projects where engineering plans and specifications were approved by a State agency prior to January 17, 2014.

The approach described below explains how EPA will implement the AIS requirement. The first section is in the form of questions and answers that address the types of projects that must comply with the AIS requirement, the types of products covered by the AIS requirement, and compliance. The second section is a step-by-step process for requesting waivers and the circumstances under which waivers may be granted.



## **Implementation**

The Act states:

Sec. 436 (a)(1) None of the funds made available by a State water pollution control revolving fund as authorized by title VI of the Federal Water Pollution Control Act (33 U.S.C. 1381 et seq.) or made available by a drinking water treatment revolving loan fund as authorized by section 1452 of the Safe Drinking Water Act (42 U.S.C. 300j-12) shall be used for a project for the construction, alteration, maintenance, or repair of a public water system or treatment works unless all of the iron and steel products used in the project are produced in the United States.

- (2) In this section, the term “iron and steel products” means the following products made primarily of iron or steel: lined or unlined pipes and fittings, manhole covers and other municipal castings, hydrants, tanks, flanges, pipe clamps and restraints, valves, structural steel, reinforced precast concrete, and construction materials.
  - (b) Subsection (a) shall not apply in any case or category of cases in which the Administrator of the Environmental Protection Agency (in this section referred to as the “Administrator”) finds that —
    - (1) applying subsection (a) would be inconsistent with the public interest;
    - (2) iron and steel products are not produced in the United States in sufficient and reasonably available quantities and of a satisfactory quality; or
    - (3) inclusion of iron and steel products produced in the United States will increase the cost of the overall project by more than 25 percent.
  - (c) If the Administrator receives a request for a waiver under this section, the Administrator shall make available to the public on an informal basis a copy of the request and information available to the Administrator concerning the request, and shall allow for informal public input on the request for at least 15 days prior to making a finding based on the request. The Administrator shall make the request and accompanying information available by electronic means, including on the official public Internet Web site of the Environmental Protection Agency.
  - (d) This section shall be applied in a manner consistent with United States obligations under international agreements.
  - (e) The Administrator may retain up to 0.25 percent of the funds appropriated in this Act for the Clean and Drinking Water State Revolving Funds for carrying out the provisions described in subsection (a)(1) for management and oversight of the requirements of this section.
  - (f) This section does not apply with respect to a project if a State agency approves the engineering plans and specifications for the project, in that agency’s capacity to approve such plans and specifications prior to a project requesting bids, prior to the date of the enactment of this Act.

The following questions and answers provide guidance for implementing and complying with the AIS requirements:

## **Project Coverage**

### **1) What classes of projects are covered by the AIS requirement?**

All treatment works projects funded by a CWSRF assistance agreement, and all public water system projects funded by a DWSRF assistance agreement, from the date of enactment through the end of Federal Fiscal Year 2014, are covered. The AIS requirements apply to the entirety of the project, no matter when construction begins or ends. Additionally, the AIS requirements apply to all parts of the project, no matter the source of funding.

### **2) Does the AIS requirement apply to nonpoint source projects or national estuary projects?**

No. Congress did not include an AIS requirement for nonpoint source and national estuary projects unless the project can also be classified as a 'treatment works' as defined by section 212 of the Clean Water Act.

### **3) Are any projects for the construction, alteration, maintenance, or repair of a public water system or treatment works excluded from the AIS requirement?**

Any project, whether a treatment works project or a public water system project, for which engineering plans and specifications were approved by the responsible state agency prior to January 17, 2014, is excluded from the AIS requirements.

### **4) What if the project does not have approved engineering plans and specifications but has signed an assistance agreement with a CWSRF or DWSRF program prior to January 17, 2014?**

The AIS requirements do not apply to any project for which an assistance agreement was signed prior to January 17, 2014.

### **5) What if the project does not have approved engineering plans and specifications, but bids were advertised prior to January 17, 2014 and an assistance agreement was signed after January 17, 2014?**

If the project does not require approved engineering plans and specifications, the bid advertisement date will count in lieu of the approval date for purposes of the exemption in section 436(f).

### **6) What if the assistance agreement that was signed prior to January 17, 2014, only funded a part of the overall project, where the remainder of the project will be funded later with another SRF loan?**

If the original assistance agreement funded any construction of the project, the date of the original assistance agreement counts for purposes of the exemption. If the original assistance agreement was only for planning and design, the date of that assistance agreement will count for purposes of the exemption only if there is a written commitment or expectation on the part of the assistance recipient to fund the remainder of the project with SRF funds.

7) **What if the assistance agreement that was signed prior to January 17, 2014, funded the first phase of a multi-phase project, where the remaining phases will be funded by SRF assistance in the future?**

In such a case, the phases of the project will be considered a single project if all construction necessary to complete the building or work, regardless of the number of contracts or assistance agreements involved, are closely related in purpose, time and place. However, there are many situations in which major construction activities are clearly undertaken in phases that are distinct in purpose, time, or place. In the case of distinct phases, projects with engineering plans and specifications approval or assistance agreements signed prior to January 17, 2014 would be excluded from AIS requirements while those approved/signed on January 17, 2014, or later would be covered by the AIS requirements.

8) **What if a project has split funding from a non-SRF source?**

Many States intend to fund projects with “split” funding, from the SRF program and from State or other programs. Based on the Act language in section 436, which requires that American iron and steel products be used in any project for the construction, alteration, maintenance, or repair of a public water system or treatment works receiving SRF funding between and including January 17, 2014 and September 30, 2014, any project that is funded in whole or in part with such funds must comply with the AIS requirement. A “project” consists of all construction necessary to complete the building or work regardless of the number of contracts or assistance agreements involved so long as all contracts and assistance agreements awarded are closely related in purpose, time and place. This precludes the intentional splitting of SRF projects into separate and smaller contracts or assistance agreements to avoid AIS coverage on some portion of a larger project, particularly where the activities are integrally and proximately related to the whole. However, there are many situations in which major construction activities are clearly undertaken in separate phases that are distinct in purpose, time, or place, in which case, separate contracts or assistance agreement for SRF and State or other funding would carry separate requirements.

9) **What about refinancing?**

If a project began construction, financed from a non-SRF source, prior to January 17, 2014, but is refinanced through an SRF assistance agreement executed on or after January 17, 2014 and prior to October 1, 2014, AIS requirements will apply to all construction that occurs on or after January 17, 2014, through completion of construction, unless, as is likely, engineering plans and specifications were approved by a responsible state agency prior to January 17, 2014. There is no retroactive application of the AIS requirements where a refinancing occurs for a project that has completed construction prior to January 17, 2014.

**10) Do the AIS requirements apply to any other EPA programs, besides the SRF program, such as the Tribal Set-aside grants or grants to the Territories and DC?**

No, the AIS requirement only applies to funds made available by a State water pollution control revolving fund as authorized by title VI of the Federal Water Pollution Control Act (33 U.S.C. 1381 et seq.) or made available by a drinking water treatment revolving loan fund as authorized by section 1452 of the Safe Drinking Water Act (42 U.S.C. 300j-12)

**Covered Iron and Steel Products**

**11) What is an iron or steel product?**

For purposes of the CWSRF and DWSRF projects that must comply with the AIS requirement, an iron or steel product is one of the following made primarily of iron or steel that is permanently incorporated into the public water system or treatment works:

- Lined or unlined pipes or fittings;
- Manhole Covers;
- Municipal Castings (defined in more detail below);
- Hydrants;
- Tanks;
- Flanges;
- Pipe clamps and restraints;
- Valves;
- Structural steel (defined in more detail below);
- Reinforced precast concrete; and
- Construction materials (defined in more detail below).

**12) What does the term 'primarily iron or steel' mean?**

'Primarily iron or steel' places constraints on the list of products above. For one of the listed products to be considered subject to the AIS requirements, it must be made of greater than 50% iron or steel, measured by cost. The cost should be based on the material costs.

**13) Can you provide an example of how to perform a cost determination?**

For example, the iron portion of a fire hydrant would likely be the bonnet, body and shoe, and the cost then would include the pouring and casting to create those components. The other material costs would include non-iron and steel internal workings of the fire hydrant (i.e., stem, coupling, valve, seals, etc). However, the assembly of the internal workings into the hydrant body would not be included in this cost calculation. If one of the listed products is not made primarily of iron or steel, United States (US) provenance is not required. An exception to this definition is reinforced precast concrete, which is addressed in a later question.

**14) If a product is composed of more than 50% iron or steel, but is not listed in the above list of items, must the item be produced in the US? Alternatively, must the iron or steel in such a product be produced in the US?**

The answer to both question is no. Only items on the above list must be produced in the US. Additionally, iron or steel in a non-listed item can be sourced from outside the US.

**15) What is the definition of steel?**

Steel means an alloy that includes at least 50 percent iron, between .02 and 2 percent carbon, and may include other elements. Metallic elements such as chromium, nickel, molybdenum, manganese, and silicon may be added during the melting of steel for the purpose of enhancing properties such as corrosion resistance, hardness, or strength. The definition of steel covers carbon steel, alloy steel, stainless steel, tool steel and other specialty steels.

**16) What does 'produced in the United States' mean?**

Production in the United States of the iron or steel products used in the project requires that all manufacturing processes, including application of coatings, must take place in the United States, with the exception of metallurgical processes involving refinement of steel additives. All manufacturing processes includes processes such as melting, refining, forming, rolling, drawing, finishing, fabricating and coating. Further, if a domestic iron and steel product is taken out of the US for any part of the manufacturing process, it becomes foreign source material. However, raw materials such as iron ore, limestone and iron and steel scrap are not covered by the AIS requirement, and the material(s), if any, being applied as a coating are similarly not covered. Non-iron or steel components of an iron and steel product may come from non-US sources. For example, for products such as valves and hydrants, the individual non-iron and steel components do not have to be of domestic origin.

**17) Are the raw materials used in the production of iron or steel required to come from US sources?**

No. Raw materials, such as iron ore, limestone, scrap iron, and scrap steel, can come from non-US sources.

**18) If an above listed item is primarily made of iron or steel, but is only at the construction site temporarily, must such an item be produced in the US?**

No. Only the above listed products made primarily of iron or steel, permanently incorporated into the project must be produced in the US. For example trench boxes, scaffolding or equipment, which are removed from the project site upon completion of the project, are not required to be made of U.S. Iron or Steel.

**19) What is the definition of ‘municipal castings’?**

Municipal castings are cast iron or steel infrastructure products that are melted and cast. They typically provide access, protection, or housing for components incorporated into utility owned drinking water, storm water, wastewater, and surface infrastructure. They are typically made of grey or ductile iron, or steel. Examples of municipal castings are:

- Access Hatches;
- Ballast Screen;
- Benches (Iron or Steel);
- Bollards;
- Cast Bases;
- Cast Iron Hinged Hatches, Square and Rectangular;
- Cast Iron Riser Rings;
- Catch Basin Inlet;
- Cleanout/Monument Boxes;
- Construction Covers and Frames;
- Curb and Corner Guards;
- Curb Openings;
- Detectable Warning Plates;
- Downspout Shoes (Boot, Inlet);
- Drainage Grates, Frames and Curb Inlets;
- Inlets;
- Junction Boxes;
- Lampposts;
- Manhole Covers, Rings and Frames, Risers;
- Meter Boxes;
- Service Boxes;
- Steel Hinged Hatches, Square and Rectangular;
- Steel Riser Rings;
- Trash receptacles;
- Tree Grates;
- Tree Guards;
- Trench Grates; and
- Valve Boxes, Covers and Risers.

**20) What is ‘structural steel’?**

Structural steel is rolled flanged shapes, having at least one dimension of their cross-section three inches or greater, which are used in the construction of bridges, buildings, ships, railroad rolling stock, and for numerous other constructional purposes. Such shapes are designated as wide-flange shapes, standard I-beams, channels, angles, tees and zees. Other shapes include H-piles, sheet piling, tie plates, cross ties, and those for other special purposes.

**21) What is a ‘construction material’ for purposes of the AIS requirement?**

Construction materials are those articles, materials, or supplies made primarily of iron and steel, that are permanently incorporated into the project, not including mechanical and/or electrical components, equipment and systems. Some of these products may overlap with what is also considered “structural steel”. This includes, but is not limited to, the following products: wire rod, bar, angles, concrete reinforcing bar, wire, wire cloth, wire rope and cables, tubing, framing, joists, trusses, fasteners (i.e., nuts and bolts), welding rods, decking, grating, railings, stairs, access ramps, fire escapes, ladders, wall panels, dome structures, roofing, ductwork, surface drains, cable hanging systems, manhole steps, fencing and fence tubing, guardrails, doors, and stationary screens.

**22) What is not considered a ‘construction material’ for purposes of the AIS requirement?**

Mechanical and electrical components, equipment and systems are not considered construction materials. Mechanical equipment is typically that which has motorized parts and/or is powered by a motor. Electrical equipment is typically any machine powered by electricity and includes components that are part of the electrical distribution system.

The following examples (including their appurtenances necessary for their intended use and operation) are NOT considered construction materials: pumps, motors, gear reducers, drives (including variable frequency drives (VFDs)), electric/pneumatic/manual accessories used to operate valves (such as electric valve actuators), mixers, gates, motorized screens (such as traveling screens), blowers/aeration equipment, compressors, meters, sensors, controls and switches, supervisory control and data acquisition (SCADA), membrane bioreactor systems, membrane filtration systems, filters, clarifiers and clarifier mechanisms, rakes, grinders, disinfection systems, presses (including belt presses), conveyors, cranes, HVAC (excluding ductwork), water heaters, heat exchangers, generators, cabinetry and housings (such as electrical boxes/enclosures), lighting fixtures, electrical conduit, emergency life systems, metal office furniture, shelving, laboratory equipment, analytical instrumentation, and dewatering equipment.

**23) If the iron or steel is produced in the US, may other steps in the manufacturing process take place outside of the US, such as assembly?**

No. Production in the US of the iron or steel used in a listed product requires that all manufacturing processes must take place in the United States, except metallurgical processes involving refinement of steel additives.

**24) What processes must occur in the US to be compliant with the AIS requirement for reinforced precast concrete?**

While reinforced precast concrete may not be at least 50% iron or steel, in this particular case, the reinforcing bar and wire must be produced in the US and meet the same standards as for any other iron or steel product. Additionally, the casting of the concrete product must take place in the US. The cement and other raw materials used in concrete production are not required to be of domestic origin.

If the reinforced concrete is cast at the construction site, the reinforcing bar and wire are considered to be a construction material and must be produced in the US.

**Compliance**

**25) How should an assistance recipient document compliance with the AIS requirement?**

In order to ensure compliance with the AIS requirement, specific AIS contract language must be included in each contract, starting with the assistance agreement, all the way down to the purchase agreements. Sample language for assistance agreements and contracts can be found in Appendix 3 and 4.

EPA recommends the use of a step certification process, similar to one used by the Federal Highway Administration. The step certification process is a method to ensure that producers adhere to the AIS requirement and assistance recipients can verify that products comply with the AIS requirement. The process also establishes accountability and better enables States to take enforcement actions against violators.

Step certification creates a paper trail which documents the location of the manufacturing process involved with the production of steel and iron materials. A step certification is a process under which each handler (supplier, fabricator, manufacturer, processor, etc) of the iron and steel products certifies that their step in the process was domestically performed. Each time a step in the manufacturing process takes place, the manufacturer delivers its work along with a certification of its origin. A certification can be quite simple. Typically, it includes the name of the manufacturer, the location of the manufacturing facility where the product or process took place (not its headquarters), a description of the product or item being delivered, and a signature by a manufacturer's responsible party. Attached, as Appendix 5, are sample certifications. These certifications should be collected and maintained by assistance recipients.

Alternatively, the final manufacturer that delivers the iron or steel product to the worksite, vendor, or contractor, may provide a certification asserting that all manufacturing processes occurred in the US. While this type of certification may be acceptable, it may not provide the same degree of assurance. Additional documentation may be needed if the certification is lacking important information. Step certification is the best practice.



**26) How should a State ensure assistance recipients are complying with the AIS requirement?**

In order to ensure compliance with the AIS requirement, States SRF programs must include specific AIS contract language in the assistance agreement. Sample language for assistance agreements can be found in Appendix 3.

States should also, as a best practice, conduct site visits of projects during construction and review documentation demonstrating proof of compliance which the assistance recipient has gathered.

**27) What happens if a State or EPA finds a non-compliant iron and/or steel product permanently incorporated in the project?**

If a potentially non-compliant product is identified, the State should notify the assistance recipient of the apparent unauthorized use of the non-domestic component, including a proposed corrective action, and should be given the opportunity to reply. If unauthorized use is confirmed, the State can take one or more of the following actions: request a waiver where appropriate; require the removal of the non-domestic item; or withhold payment for all or part of the project. Only EPA can issue waivers to authorize the use of a non-domestic item. EPA may use remedies available to it under the Clean Water Act, the Safe Drinking Water Act, and 40 CFR part 31 grant regulations, in the event of a violation of a grant term and condition.

It is recommended that the State work collaboratively with EPA to determine the appropriate corrective action, especially in cases where the State is the one who identifies the item in noncompliance or there is a disagreement with the assistance recipient.

If fraud, waste, abuse, or any violation of the law is suspected, the Office of Inspector General (OIG) should be contacted immediately. The OIG can be reached at 1- 888-546-8740 or [OIG\\_Hotline@epa.gov](mailto:OIG_Hotline@epa.gov). More information can be found at this website:

<https://www.epa.gov/office-inspector-general/epa-oig-hotline>.

**28) How do international trade agreements affect the implementation of the AIS requirements?**

The AIS provision applies in a manner consistent with United States obligations under international agreements. Typically, these obligations only apply to direct procurement by the entities that are signatories to such agreements. In general, SRF assistance recipients are not signatories to such agreements, so these agreements have no impact on this AIS provision. In the few instances where such an agreement applies to a municipality, that municipality is under the obligation to determine its applicability and requirements and document the actions taken to comply for the State.

## **Waiver Process**

The statute permits EPA to issue waivers for a case or category of cases where EPA finds (1) that applying these requirements would be inconsistent with the public interest; (2) iron and steel products are not produced in the US in sufficient and reasonably available quantities and of a satisfactory quality; or (3) inclusion of iron and steel products produced in the US will increase the cost of the overall project by more than 25 percent.

In order to implement the AIS requirements, EPA has developed an approach to allow for effective and efficient implementation of the waiver process to allow projects to proceed in a timely manner. The framework described below will allow States, on behalf of the assistance recipients, to apply for waivers of the AIS requirement directly to EPA Headquarters. Only waiver requests received from states will be considered. Pursuant to the Act, EPA has the responsibility to make findings as to the issuance of waivers to the AIS requirements.

## **Definitions**

The following terms are critical to the interpretation and implementation of the AIS requirements and apply to the process described in this memorandum:

**Reasonably Available Quantity:** The quantity of iron or steel products is available or will be available at the time needed and place needed, and in the proper form or specification as specified in the project plans and design.

**Satisfactory Quality:** The quality of iron or steel products, as specified in the project plans and designs.

**Assistance Recipient:** A borrower or grantee that receives funding from a State CWSRF or DWSRF program.

## **Step-By-Step Waiver Process**

### **Application by Assistance Recipient**

Each local entity that receives SRF water infrastructure financial assistance is required by section 436 of the Act to use American made iron and steel products in the construction of its project. However, the recipient may request a waiver. Until a waiver is granted by EPA, the AIS requirement stands, except as noted above with respect to municipalities covered by international agreements.

The waiver process begins with the SRF assistance recipient. In order to fulfill the AIS requirement, the assistance recipient must in good faith design the project (where applicable) and solicit bids for construction with American made iron and steel products. It is essential that the assistance recipient include the AIS terms in any request for proposals or solicitations for bids, and in all contracts (see Appendix 3 for sample construction contract language). The assistance recipient may receive a waiver at any point before, during, or after the bid process,

if one or more of three conditions is met:

1. Applying the American Iron and Steel requirements of the Act would be inconsistent with the public interest;
2. Iron and steel products are not produced in the United States in sufficient and reasonably available quantities and of a satisfactory quality; or
3. Inclusion of iron and steel products produced in the United States will increase the cost of the overall project by more than 25 percent.

Proper and sufficient documentation must be provided by the assistance recipient. A checklist detailing the types of information required for a waiver to be processed is attached as Appendix 1.

Additionally, it is strongly encouraged that assistance recipients hold pre-bid conferences with potential bidders. A pre-bid conference can help to identify iron and steel products needed to complete the project as described in the plans and specifications that may not be available from domestic sources. It may also identify the need to seek a waiver prior to bid, and can help inform the recipient on compliance options.

In order to apply for a project waiver, the assistance recipient should email the request in the form of a Word document (.doc) to the State SRF program. It is strongly recommended that the State designate a single person for all AIS communications. The State SRF designee will review the application for the waiver and determine whether the necessary information has been included. Once the waiver application is complete, the State designee will forward the application to either of two email addresses. For CWSRF waiver requests, please send the application to: [cwsrfwaiver@epa.gov](mailto:cwsrfwaiver@epa.gov). For DWSRF waiver requests, please send the application to: [dwsrfwaiver@epa.gov](mailto:dwsrfwaiver@epa.gov).

### Evaluation by EPA

After receiving an application for waiver of the AIS requirements, EPA Headquarters will publish the request on its website for 15 days and receive informal comment. EPA Headquarters will then use the checklist in Appendix 2 to determine whether the application properly and adequately documents and justifies the statutory basis cited for the waiver – that it is quantitatively and qualitatively sufficient – and to determine whether or not to grant the waiver.

In the event that EPA finds that adequate documentation and justification has been submitted, the Administrator may grant a waiver to the assistance recipient. EPA will notify the State designee that a waiver request has been approved or denied as soon as such a decision has been made. Granting such a waiver is a three-step process:

1. Posting – After receiving an application for a waiver, EPA is required to publish the application and all material submitted with the application on EPA’s website for 15 days. During that period, the public will have the opportunity to review the request and provide informal comment to EPA. The website can be found at: <https://www.epa.gov/cwsrf/state-revolving-fund-american-iron-and-steel-ais-requirement>

2. Evaluation – After receiving an application for waiver of the AIS requirements, EPA Headquarters will use the checklist in Appendix 2 to determine whether the application properly and adequately documents and justifies the statutory basis cited for the waiver – that it is quantitatively and qualitatively sufficient – and to determine whether or not to grant the waiver.
3. Signature of waiver approval by the Administrator or another agency official with delegated authority – As soon as the waiver is signed and dated, EPA will notify the State SRF program, and post the signed waiver on our website. The assistance recipient should keep a copy of the signed waiver in its project files.

### Public Interest Waivers

EPA has the authority to issue public interest waivers. Evaluation of a public interest waiver request may be more complicated than that of other waiver requests so they may take more time than other waiver requests for a decision to be made. An example of a public interest waiver that might be issued could be for a community that has standardized on a particular type or manufacturer of a valve because of its performance to meet their specifications. Switching to an alternative valve may require staff to be trained on the new equipment and additional spare parts would need to be purchased and stocked, existing valves may need to be unnecessarily replaced, and portions of the system may need to be redesigned. Therefore, requiring the community to install an alternative valve would be inconsistent with public interest.

EPA also has the authority to issue a public interest waiver that covers categories of products that might apply to all projects.

EPA reserves the right to issue national waivers that may apply to particular classes of assistance recipients, particular classes of projects, or particular categories of iron or steel products. EPA may develop national or (US geographic) regional categorical waivers through the identification of similar circumstances in the detailed justifications presented to EPA in a waiver request or requests. EPA may issue a national waiver based on policy decisions regarding the public's interest or a determination that a particular item is not produced domestically in reasonably available quantities or of a sufficient quality. In such cases, EPA may determine it is necessary to issue a national waiver.

If you have any questions concerning the contents of this memorandum, you may contact us, or have your staff contact Jordan Dorfman, Attorney-Advisor, State Revolving Fund Branch, Municipal Support Division, at [dorfman.jordan@epa.gov](mailto:dorfman.jordan@epa.gov) or (202) 564- 0614 or Kiri Anderer, Environmental Engineer, Infrastructure Branch, Drinking Water Protection Division, at [anderer.kirsten@epa.gov](mailto:anderer.kirsten@epa.gov) or (202) 564-3134.

Attachments

## Appendix 1: Information Checklist for Waiver Request

The purpose of this checklist is to help ensure that all appropriate and necessary information is submitted to EPA. EPA recommends that States review this checklist carefully and provide all appropriate information to EPA. This checklist is for informational purposes only and does not need to be included as part of a waiver application.

Items	✓	Notes
<p><b>General</b></p> <ul style="list-style-type: none"> <li>• Waiver request includes the following information: <ul style="list-style-type: none"> <li>— Description of the foreign and domestic construction materials</li> <li>— Unit of measure</li> <li>— Quantity</li> <li>— Price</li> <li>— Time of delivery or availability</li> <li>— Location of the construction project</li> <li>— Name and address of the proposed supplier</li> <li>— A detailed justification for the use of foreign construction materials</li> </ul> </li> <li>• Waiver request was submitted according to the instructions in the memorandum</li> <li>• Assistance recipient made a good faith effort to solicit bids for domestic iron and steel products, as demonstrated by language in requests for proposals, contracts, and communications with the prime contractor</li> </ul>	✓	
<p><b>Cost Waiver Requests</b></p> <ul style="list-style-type: none"> <li>• Waiver request includes the following information: <ul style="list-style-type: none"> <li>— Comparison of overall cost of project with domestic iron and steel products to overall cost of project with foreign iron and steel products</li> <li>— Relevant excerpts from the bid documents used by the contractors to complete the comparison</li> <li>— Supporting documentation indicating that the contractor made a reasonable survey of the market, such as a description of the process for identifying suppliers and a list of contacted suppliers</li> </ul> </li> </ul>		
<p><b>Availability Waiver Requests</b></p> <ul style="list-style-type: none"> <li>• Waiver request includes the following supporting documentation necessary to demonstrate the availability, quantity, and/or quality of the materials for which the waiver is requested: <ul style="list-style-type: none"> <li>— Supplier information or pricing information from a reasonable number of domestic suppliers indicating availability/delivery date for construction materials</li> <li>— Documentation of the assistance recipient's efforts to find available domestic sources, such as a description of the process for identifying suppliers and a list of contacted suppliers.</li> <li>— Project schedule</li> <li>— Relevant excerpts from project plans, specifications, and permits indicating the required quantity and quality of construction materials</li> </ul> </li> <li>• Waiver request includes a statement from the prime contractor and/or supplier confirming the non-availability of the domestic construction materials for which the waiver is sought</li> <li>• Has the State received other waiver requests for the materials described in this waiver request, for comparable projects?</li> </ul>		

## Appendix 2: HQ Review Checklist for Waiver Request

Instructions: To be completed by EPA. Review all waiver requests using the questions in the checklist, and mark the appropriate box as Yes, No or N/A. Marks that fall inside the shaded boxes may be grounds for denying the waiver. If none of your review markings fall into a shaded box, the waiver is eligible for approval if it indicates that one or more of the following conditions applies to the domestic product for which the waiver is sought:

1. The iron and/or steel products are not produced in the United States in sufficient and reasonably available quantities and of a satisfactory quality.
2. The inclusion of iron and/or steel products produced in the United States will increase the cost of the overall project by more than 25 percent.

Review Items	Yes	No	N/A	Comments
<p><b>Cost Waiver Requests</b></p> <ul style="list-style-type: none"> <li>• Does the waiver request include the following information? <ul style="list-style-type: none"> <li>— Comparison of overall cost of project with domestic iron and steel products to overall cost of project with foreign iron and steel products</li> <li>— Relevant excerpts from the bid documents used by the contractors to complete the comparison</li> <li>— A sufficient number of bid documents or pricing information from domestic sources to constitute a reasonable survey of the market</li> </ul> </li> <li>• Does the Total Domestic Project exceed the Total Foreign Project Cost by more than 25%?</li> </ul>				
<p><b>Availability Waiver Requests</b></p> <ul style="list-style-type: none"> <li>• Does the waiver request include supporting documentation sufficient to show the availability, quantity, and/or quality of the iron and/or steel product for which the waiver is requested? <ul style="list-style-type: none"> <li>— Supplier information or other documentation indicating availability/delivery date for materials</li> <li>— Project schedule</li> <li>— Relevant excerpts from project plans, specifications, and permits indicating the required quantity and quality of materials</li> </ul> </li> <li>• Does supporting documentation provide sufficient evidence that the contractors made a reasonable effort to locate domestic suppliers of materials, such as a description of the process for identifying suppliers and a list of contacted suppliers?</li> <li>• Based on the materials delivery/availability date indicated in the supporting documentation, will the materials be unavailable when they are needed according to the project schedule? (By item, list schedule date and domestic delivery quote date or other relevant information)</li> <li>• Is EPA aware of any other evidence indicating the non-availability of the materials for which the waiver is requested? <p>Examples include:</p> <ul style="list-style-type: none"> <li>— Multiple waiver requests for the materials described in this waiver request, for comparable projects in the same State</li> <li>— Multiple waiver requests for the materials described in this waiver request, for comparable projects in other States</li> <li>— Correspondence with construction trade associations indicating the non-availability of the materials</li> </ul> </li> <li>• Are the available domestic materials indicated in the bid documents of inadequate quality compared those required by the project plans, specifications, and/or permits?</li> </ul>				

### **Appendix 3: Example Loan Agreement Language**

ALL ASSISTANCE AGREEMENTS MUST HAVE A CLAUSE REQUIRING COMPLIANCE WITH THE AIS REQUIREMENT. THIS IS AN EXAMPLE OF WHAT COULD BE INCLUDED IN SRF ASSISTANCE AGREEMENTS. EPA MAKES NO CLAIMS REGARDING THE LEGALITY OF THIS CLAUSE WITH RESPECT TO STATE LAW:

Comply with all federal requirements applicable to the Loan (including those imposed by the 2014 Appropriations Act and related SRF Policy Guidelines) which the Participant understands includes, among other, requirements that all of the iron and steel products used in the Project are to be produced in the United States (“American Iron and Steel Requirement”) unless (i) the Participant has requested and obtained a waiver from the Agency pertaining to the Project or (ii) the Finance Authority has otherwise advised the Participant in writing that the American Iron and Steel Requirement is not applicable to the Project.

Comply with all record keeping and reporting requirements under the Clean Water Act/Safe Drinking Water Act, including any reports required by a Federal agency or the Finance Authority such as performance indicators of program deliverables, information on costs and project progress. The Participant understands that (i) each contract and subcontract related to the Project is subject to audit by appropriate federal and state entities and (ii) failure to comply with the Clean Water Act/Safe Drinking Water Act and this Agreement may be a default hereunder that results in a repayment of the Loan in advance of the maturity of the Bonds and/or other remedial actions.

#### **Appendix 4: Sample Construction Contract Language**

ALL CONTRACTS MUST HAVE A CLAUSE REQUIRING COMPLIANCE WITH THE AIS REQUIREMENT. THIS IS AN EXAMPLE OF WHAT COULD BE INCLUDED IN ALL CONTRACTS IN PROJECTS THAT USE SRF FUNDS. EPA MAKES NO CLAIMS REGARDING THE LEGALITY OF THIS CLAUSE WITH RESPECT TO STATE OR LOCAL LAW:

The Contractor acknowledges to and for the benefit of the City of \_\_\_\_\_ (“Purchaser”) and the \_\_\_\_\_ (the “State”) that it understands the goods and services under this Agreement are being funded with monies made available by the Clean Water State Revolving Fund and/or Drinking Water State Revolving Fund that have statutory requirements commonly known as “American Iron and Steel;” that requires all of the iron and steel products used in the project to be produced in the United States (“American Iron and Steel Requirement”) including iron and steel products provided by the Contractor pursuant to this Agreement. The Contractor hereby represents and warrants to and for the benefit of the Purchaser and the State that (a) the Contractor has reviewed and understands the American Iron and Steel Requirement, (b) all of the iron and steel products used in the project will be and/or have been produced in the United States in a manner that complies with the American Iron and Steel Requirement, unless a waiver of the requirement is approved, and (c) the Contractor will provide any further verified information, certification or assurance of compliance with this paragraph, or information necessary to support a waiver of the American Iron and Steel Requirement, as may be requested by the Purchaser or the State. Notwithstanding any other provision of this Agreement, any failure to comply with this paragraph by the Contractor shall permit the Purchaser or State to recover as damages against the Contractor any loss, expense, or cost (including without limitation attorney’s fees) incurred by the Purchaser or State resulting from any such failure (including without limitation any impairment or loss of funding, whether in whole or in part, from the State or any damages owed to the State by the Purchaser). While the Contractor has no direct contractual privity with the State, as a lender to the Purchaser for the funding of its project, the Purchaser and the Contractor agree that the State is a third-party beneficiary and neither this paragraph (nor any other provision of this Agreement necessary to give this paragraph force or effect) shall be amended or waived without the prior written consent of the State.



## Appendix 5: Sample Certifications

The following information is provided as a sample letter of step certification for AIS compliance. Documentation must be provided on company letterhead.

Date

Company Name

Company Address

City, State Zip

Subject: American Iron and Steel Step Certification for Project (XXXXXXXXXXXX)

I, (company representative), certify that the (melting, bending, coating, galvanizing, cutting, etc.) process for (manufacturing or fabricating) the following products and/or materials shipped or provided for the subject project is in full compliance with the American Iron and Steel requirement as mandated in EPA's State Revolving Fund Programs.

Item, Products and/or Materials:

1. XXXX
2. XXXX
3. XXXX

Such process took place at the following location:

If any of the above compliance statements change while providing material to this project we will immediately notify the prime contractor and the engineer.

Signed by company representative

The following information is provided as a sample letter of certification for AIS compliance. Documentation must be provided on company letterhead.

Date

Company Name

Company Address

City, State Zip

Subject: American Iron and Steel Certification for Project (XXXXXXXXXXXX)

I, (company representative), certify that the following products and/or materials shipped/provided to the subject project are in full compliance with the American Iron and Steel requirement as mandated in EPA's State Revolving Fund Programs.

Item, Products and/or Materials:

1. XXXX
2. XXXX
3. XXXX

Such process took place at the following location:

If any of the above compliance statements change while providing material to this project we will immediately notify the prime contractor and the engineer.

Signed by company representative

## SECTION 01069

### HEALTH & SAFETY REQUIREMENTS

#### PART 1 GENERAL

##### 1.01 SECTION INCLUDES

- A. Requirements for providing a Health and Safety Plan (HASP) and maintenance of health and safety while performing the Work.

##### 1.02 REQUIREMENTS

- A. Monitor working conditions at all times during construction and provide appropriate protective clothing, equipment and facilities for personnel, and establish workplace procedures to ensure personnel safety.
- B. Implement a Health and Safety protection program. The procedures for such implementation shall be submitted to the Engineer and Owner for approval. The procedures shall include provisions for stations allowing workers to wash and to put on and remove protective clothing, and stations for vehicles to be cleaned, if necessary, before leaving the site, air monitoring, and evaluation of areas where unsafe levels of gas has accumulated.
- C. Comply with all Federal, State, and local safety requirements related to the hazards anticipated to be encountered during the course of this project.
- D. In addition to the above requirements, comply with the following:
  - 1. All construction equipment on the site shall be equipped with vertical exhaust pipes or a spark proof exhaust.
  - 2. Smoking shall not be permitted in any area where gases can accumulate, or in areas where contaminated soil is present.
  - 3. Welding or open flames shall not be permitted in enclosed areas.
  - 4. Toxic gas indicators, an organic vapor analyzer, a combustible gas indicator, an oxygen indicator, and fire extinguishers shall be available at all times during operations. Periodic monitoring with portable monitoring devices shall be employed as dictated by the Health and Safety Plan.
  - 5. During operations, whenever unsafe levels of toxic gases are detected, all work will cease in that area until acceptable levels are reached.

##### 1.03 SHOP DRAWINGS

- A. Submit site specific Health and Safety Plan (HASP) that complies with all applicable OSHA requirements to the Engineer for review and acceptance within fifteen (15) working days of the Contractor's Notice to Proceed. Certified Industrial Hygienist must certify the Contractor's plan prior to submittal to and review by the Engineer. The Contractor is not to proceed with any subsurface or site work without review and acceptance of the submitted Health and Safety Plan by the Engineer.

##### 1.04 QUALITY ASSURANCE

- A. Engage an independent, qualified Health and Safety expert having experience in similar construction conditions, to monitor site conditions and recommend all necessary Health and

Safety protection. This person shall be a Certified Industrial Hygienist (CIH). The Contractor shall follow such recommendations and shall provide such protection to his personnel, and personnel of the Owner and Engineer, as may be affected.

## 1.05 REGULATORY REQUIREMENTS

- A. Establish workplace procedures, enforce the use of these procedures, and the associated equipment and facilities in accordance with the following guidelines:
  - 1. Safety and Health Regulations Promulgated by the U.S. Department of Labor OSHA, 29 CFR 1910 - Occupational Safety and Health Standards, and 29 CFR 1920 - Safety and Health Regulations for Construction.
  - 2. Occupational Safety and Health Standards, 29 CFR 1926 - Safety and Health Regulations for Construction.
  - 3. U.S. Environmental Protection Agency Medical Monitoring Program Guidelines.

## PART 2 PRODUCTS

NOT USED

## PART 3 EXECUTION

### 3.01 PROTECTION

- A. If, at any time, the Owner or the Engineer is apprised of a safety hazard which demands immediate attention because of its high potential for harm to the public travel, persons on or about the Work, or public or private property, the Owner or the Engineer shall have the right to order such safeguards to be erected and such precautions to be taken as necessary and the Contractor shall comply with such orders. If, under such circumstances, the Contractor does not or cannot immediately put the Work into proper and approved condition, or if the Contractor or his representative is not upon the site so that he can be notified immediately of the insufficiency of safety precautions, then the Owner may put the Work into such a condition that is, in his opinion, in all respects safe, and the Contractor shall pay all expenses of such labor and materials as may have been used for this purpose by him or by the Owner. The fact that the Owner or the Engineer does not observe a safety hazard or does not order the Contractor to take remedial measures shall in no way relieve the Contractor of the entire responsibility for any costs, loss or damage by any party sustained on account of the insufficiency of the safety precautions taken by him or by the Owner acting under authority of this Section.
- B. If the Contractor is alerted to the fact that conditions of high hazard are present or can be present at the site during the performance of the Work, it is the responsibility of the Contractor to take appropriate safety precautions to meet whatever conditions of hazard may be present during the performance of the Work, whether reasonably foreseeable or not. The safety conditions enumerated in the Specifications are the minimum permissible and neither the Owner nor the Engineer makes any representation that the safety standards provided herein will be adequate to meet all eventualities. The Contractor is therefore alerted to the fact that it shall be his responsibility to anticipate and provide such additional safety precautions, facilities, personnel and equipment as shall be necessary to protect life and property from whatsoever conditions of hazard are present or may be present.

- C. The Contractor shall supply and erect highly visible safety fencing a minimum of three feet in height around all construction areas that pose a threat to safety and post proper signage as required by Local, State and Federal requirements. The Contractor shall erect safety fencing as documented in the Contact Drawings or as directed by the Engineer and shall maintain such fencing and signage until such a time that the potential safety hazard has been rectified. Upon final completion of construction all safety fencing shall be removed off-site by the Contractor. Safety fencing requirements of OSHA shall be enforced by the Contractor.

END OF SECTION

SECTION 01090

REFERENCE STANDARDS

PART 1 GENERAL

1.01 SECTION INCLUDES

- A. Reference material, abbreviations, and terms used in the Construction Documents and establishes edition dates and complete titles for standards referenced elsewhere in the Specifications.

1.02 QUALITY ASSURANCE

- A. For products or workmanship specified by association, trade or Federal Standards, comply with requirements of the standard, except when more rigid requirements are specified or are required by applicable codes.
- B. Obtain copies of standards when required by Contract Documents.
- C. Maintain copy at jobsite during submittals, planning, and progress of the specific work, until Substantial Completion.
- D. Should specified reference standards conflict with Contract Documents, request clarification from Architect/Engineer before proceeding.
- E. The contractual relationship of the parties to the Contract shall not be altered from the Contract Documents by mention or inference otherwise in any reference document.

1.03 SCHEDULE OF REFERENCES

AA	Aluminum Association 1400 Crystal Dr. Suite 430 Arlington, VA 22202
AASHTO	American Association of State Highway and Transportation Officials 444 North Capitol Street, N.W. Washington, DC 20001
ACI	American Concrete Institute 38800 Country Club Dr. Farmington Hills, MI 48331-3439
AFBMA	Anti-Friction Bearing Manufacturers Association 2025 M. Street, NW Washington, DC 20036-3309
AGC	Associated General Contractors of America 2300 Wilson Blvd. Arlington, VA 22201

AGM	American Gear Manufacturers Association 1001 N. Fairfax Street Alexandria, VA 22314-1587
AI	Asphalt Institute 2696 Research Park Drive Lexington, KY 40511-8480
AISC	American Institute of Steel Construction One East Wacker Drive Chicago, IL 60601-1802
AISI	American Iron and Steel Institute 25 Massachusetts Drive Washington, DC 20001
AMCA	Air Movement and Control Association 30 West University Drive Arlington Heights, IL 60004
ANS	American National Standard
ANSI	American National Standards Institute 1899 L Street, NW, 11 <sup>th</sup> Floor Washington, DC 20036
API	American Petroleum Institute 1220 L Street, NW Washington, DC 20005
ARI	Air-Conditioning and Refrigeration Institute 2111 Wilson Boulevard Arlington, VA 22201
ASCE	American Society of Civil Engineers 1801 Alexander Bell Drive Reston, VA 20191
ASHRAE	American Society of Heating, Refrigerating and Air Conditioning Engineers 1791 Tullie Circle, N.E. Atlanta, GA 30329
ASME	American Society of Mechanical Engineers Two Park Avenue New York, NY 10016-5990
ASPA	American Sod Producers Association 1855 A Hicks Road Rolling Meadows, IL 60008

ASTM	American Society for Testing and Materials 100 Bar Harbor Drive PO Box C700 West Conshohocken, PA 19428-2959
AWG	American or Brown and Sharpe Wire Gage
AWPA	American Wood-Preservers' Association 100 Chase Park South Birmingham, AL 35244-1851
AWS	American Welding Society
AWWA	American Water Works Association 6666 West Quincy Avenue Denver, CO 80235
BIA	Brick Institute of America 1850 Centennial Park Drive Reston, VA 20191
CS	Commercial Standard
EJCDC	Engineers' Joint Contract Document Committee American Consulting Engineers Council 1015 15 <sup>th</sup> Street, N.W. Washington, DC 20005
FM	Factory Mutual System 1151 Boston-Providence Turnpike PO Box 688 Norwood, Massachusetts 02062
Fed Spec.	Federal Specification General Services Administration Specification and Consumer Information Distribution Section (WFSIS) Washington Navy Yard, Bldg. 197 Washington, DC 20407
HMA	Hot Mix Asphalt
IBR	Institute of Boiler and Radiator Manufacturers
ICBO	International Conference of Building Officials 900 Montclair Road Birmingham, AL 35213-2298
IPS	Iron Pipe Size
JIC	Joint Industry Conference Standards



MIL	Military Specification Naval Publications and Forms Center 5801 Tabor Avenue Philadelphia, PA 19120
NASSCO	National Association of Sewer Service Companies 2470 Longstone Lane Marriottsville, MD 21104
NBS	National Bureau of Standards
NCMA	National Concrete Masonry Association 13750 Sunrise Valley Drive Herndon, VA 20171
NCPWB	National Certified Pipe Welding Bureau
NEMA	National Electrical Manufacturers' Association 1300 North 17 <sup>th</sup> Street Arlington, VA 22209
NFPA	National Fire Protection Association Battery March Park Quincy, MA 02269
NPT	National Pipe Thread
OS&Y	Outside screw and yoke
PCA	Portland Cement Association 5420 Old Orchard Road Skokie, IL 60077
SMACNA	Sheet Metal and Air Conditioning Contractors' National Assoc. 4201 Lafayette Center Drive Chantilly, VA 20151-1219
Stl. WG	U.S. Steel Wire Washburn and Moen, American Steel and Wire or Roebling Gage
UL	Underwriters' Laboratories, Inc. 333 Pfingston Road Northbrook, IL 60062
USS Gage	United States Standard Gage
125-lb. ANS 250-lb. ANS	American National Standard for Cast-Iron Pipe Flanges and Flange Fittings, Designation B16.1-1975, for the appropriate class

1.04 EDITION DATES

- A. Reference to publications and reference material shall be understood to mean the latest edition, unless stated otherwise.

PART 2 PRODUCTS NOT USED

PART 3 EXECUTION NOT USED

END OF SECTION

## SECTION 01170

### ENVIRONMENTAL PROTECTION

#### PART 1 GENERAL

##### 1.01 SUMMARY

###### A. Section Includes

1. Requirements for environmental protection during and as the result of construction operations under this Contract except for those measures set forth in other provisions of these Specifications.
2. Environmental protection requires consideration of air, water and land, noise, solid waste management, vector and fire control.

###### B. Related Sections

1. Section 01300 - Submittals
2. Section 02228 - Waste Material Disposal

##### 1.02 QUALITY ASSURANCE

###### A. Requirements of regulatory agencies:

1. In order to prevent environmental pollution and to provide for environmental protection arising from construction activities related to the performance of this Contract, the Contractor and his subcontractors shall comply with all applicable Federal, State, and local laws and regulations concerning environmental protection, as well as the specific requirements stated in the Section and elsewhere in the Specifications.

##### 1.03 SUBMITTALS

###### A. Under the requirements of Section 01300 - Submit the following.

###### B. Implementation Plan

1. Prior to commencement of the work, the Contractor shall:
  - a. Submit in writing his plans for implementing this Section for environmental protection.
  - b. Meet with the Engineer to develop mutual understandings relative to compliance with the provisions of this Section and administration of the environmental protection program.

###### C. Temporary Excavation and Embankments

1. If the Contractor proposes to construct temporary roads or embankments and excavations for work areas, he shall submit the following for approval prior to scheduled start of such temporary work:
  - a. A layout of all temporary roads, excavations and embankments to be constructed within the work area.
  - b. Plans and cross-sections of proposed embankments and their foundations, including a description of proposed materials.
  - c. A landscaping plan showing the proposed restoration of the area. Removal of any necessary trees and shrubs outside the limits of existing cleared areas shall

be indicated. The plan shall provide for the obliteration of construction scars and shall provide for a reasonably natural appearing final condition of the area. Modification of the Contractor's plans shall be made only with the written approval of the Engineer. No unauthorized road construction, excavation or embankment construction, including disposal areas will be permitted.

D. Erosion Sedimentation Plan

1. The Contractor shall submit to the Engineer, a detailed erosion and sedimentation plan for approval at least 10 days prior to initiation of work. The plan shall include location and construction details of the Contractor's proposed dikes, basins, etc. The Contractor shall provide and submit his control measures for stockpile material.

PART 2 PRODUCTS

2.01 GENERAL

- A. All materials shall be as specified elsewhere in this Specification.

PART 3 EXECUTION

3.01 PROTECTION OF LAND RESOURCES

- A. It is intended that the land resources within the project boundaries and outside the limits of permanent work performed under this Contract be preserved in their present condition, or be restored to a condition after completion of construction, that will appear to be natural and not detract from the appearance of the project. The Contractor shall confine his construction activities to areas defined on the Drawings or in the Specifications except with written approval of the property owners and the Engineer.
- B. Limits of working areas include areas for storage of construction material, and shall be cleared in a manner which will enable satisfactory restoration and which will not affect the environment during or after the construction period. The Contractor shall not enter beyond the working limits of the working area except with written approval of the Engineer and Owner.
- C. The location of areas for storage of the Contractor's materials required temporarily in the performance of the work, shall be within the limits of the working area and shall require written approval of the Engineer prior to use. The preservation of the landscape shall be an imperative consideration in the selection of all such sites. Where temporary structures are constructed on sidehills, the Engineer may require cribbing to be used to obtain level foundation. Benching or leveling of earth may not be allowed, depending on the location of the proposed facility.
- D. The Contractor shall obliterate all signs of temporary construction facilities such as haul roads, work areas, structures, foundations of temporary structures, stockpiles of excess or waste materials, or any other vestiges of construction. It is anticipated that excavation, filling and plowing of roadways will be required to restore the area to near natural conditions which permit the growth of vegetation thereon. The disturbed areas shall be graded and filled as

required, and topsoil shall be spread to a depth of approximately 6 inches over the entire area and the entire area shall be seeded.

### 3.02 PROTECTION OF WATER RESOURCES

- A. The Contractor shall not pollute streams, lakes or reservoirs with fuels, oils, bitumen's, calcium chloride, acids or harmful materials. It is the responsibility of the Contractor to investigate and comply with all applicable Federal, State, County, and Municipal laws concerning pollution of rivers, streams and impounded water. All work under this Contract shall be performed in such a manner that objectionable conditions will not be created in streams through, or bodies of water adjacent to, the project area.
- B. Surface drainage from cuts and fills within the construction limits, whether or not completed, and from borrow and waste disposal areas, shall, if turbidity producing materials are present, be held in suitable sedimentation basins or shall be graded to control erosion within acceptable limits. Temporary erosion and sediment control measures such as berms, dikes, drains, or sedimentation basins, if required to meet the above standards, shall be provided and maintained until permanent drainage and erosion control facilities are completed and operative. The area of bare soil exposed at any one time by construction operations should be held to a minimum.
- C. Apply temporary mulch on denuded ground immediately after rough grading is completed. This shall apply to all areas not subject to appreciable traffic during construction, even those that are to receive some form of construction later if ground is to be exposed 30 days or more.
- D. Stream and drainage ditch crossings by fording with equipment shall be limited to control turbidity, and in areas of frequent crossings, temporary culverts or bridge structures shall be installed. Any temporary culverts or bridge structures shall be removed upon completion of the project. Fills and waste areas shall be constructed by selective placement to eliminate silts or clays on the surface that will erode and contaminate adjacent streams.
- E. At all times of the year, special measures shall be taken to prevent chemicals, fuels, oils, greases, bituminous materials, waste washings, herbicides and insecticides, and cement and surface drainage from entering public waters.
- F. Disposal of any materials, wastes, effluents, trash, garbage, oil, grease, chemicals, etc., in areas adjacent to streams or other waterways shall be disposed of by the Contractor in accordance with the applicable governing regulations. If any waste material is dumped in unauthorized area, the Contractor shall remove the material and restore the area to the condition of the adjacent undisturbed area. If necessary, contaminated ground shall be excavated, disposed of as specified hereinbefore, and replaced with suitable fill material, compacted and finished with topsoil, all at the expense of the Contractor.

### 3.03 MAINTENANCE

- A. The Contractor shall dispose of all discarded debris and aggregate samples in a manner approved by the Engineer. Toilet facilities shall be kept clean and sanitary at all times. Services shall be performed at such a time and in such a manner to least interfere with the operations. Services shall be accomplished to the satisfaction of the Engineer.

- B. The Contractor shall frequently remove materials no longer required on the site so that, at all times, the site, access routes to the site and any other areas disturbed by his operations shall present a neat, orderly, workmanlike appearance.
- C. Before semi-final payment, the Contractor shall remove all surplus material, plant of any description, and debris of every nature resulting from his operations, and put the site in a neat, orderly condition; and restore all areas which have been used for storage of materials and equipment, and all areas which have been disturbed by his operations, to their original condition or to a condition satisfactory to and approved by the Engineer.

#### 3.04 DUST CONTROL

- A. The Contractor shall maintain all excavations, embankments, stockpiles, haul roads, permanent access roads, waste areas, borrow areas and all other work areas within or without the project boundaries free from dust which would cause a hazard or nuisance to others or contaminate surface water.

#### 3.05 NOISE CONTROL

- A. The Contractor shall use every effort and means possible to minimize or eliminate noise caused by his operation which the Engineer may consider objectionable.
- B. All equipment utilized by the Contractor at the Landfill shall be equipped with adequate muffler systems to minimize on-site noise generation.

#### 3.06 LITTER CONTROL

- A. Any litter generated by the Contractor's operation, whether from disturbance of existing buried solid waste or generated in the course of performing the work under Contract, shall be collected and properly disposed of on a daily basis.

#### 3.07 VECTOR CONTROL

- A. Sanitary measures and conditions shall be maintained at the Landfill, by the Contractor, at all times in order to avoid harboring, feeding, and breeding of vectors.

#### 3.08 FIRE PREVENTION AND CONTROL

- A. Open burning of any type is prohibited.
- B. The Contractor shall take necessary precautions and implement procedures to prevent and control fires, whether on the Landfill or within a piece of equipment used in performing the work under Contract.

#### 3.09 PROHIBITED CONSTRUCTION PROCEDURES

- A. The Contractor is advised that the disposal of excess excavated material in wetlands, stream corridors, and floodplains is strictly prohibited. Any violation of this restriction by the Contractor or any person employed by him, will be brought to the immediate attention of the responsible regulatory agencies.

- B. The Contractor shall comply with the following requirements regarding prohibited construction procedures as follows:
1. Dumping of spoil material into any stream corridor, any wetland, any surface waters, or at unspecified locations.
  2. Indiscriminate, arbitrary or capricious operation of equipment in any stream corridors, any wetlands or surface waters.
  3. Pumping of silt-laden water from trenches or other excavations into any surface waters, any stream corridors or any wetlands.
  4. Damaging vegetation adjacent to, or outside of, the area of the work.
  5. Disposal of trees, brush and other debris in any stream corridors, any wetlands, any surface waters, or at unspecified locations.
  6. Permanent or unspecified alteration of the flow line of any stream.
  7. Open burning of project debris.
  8. Location of storage stockpile areas in environmentally sensitive areas.
  9. Disposal of excess or unsuitable excavation material in wetlands or floodplains even with permission of the property owner.

END OF SECTION

SECTION 01200

PROJECT MEETINGS

PART 1 GENERAL

1.01 SECTION INCLUDES

- A. Administrative and procedural requirements for project meetings.

1.02 PRECONSTRUCTION CONFERENCE

- A. The Engineer will schedule and administer a pre-construction conference.
- B. The pre-construction conference will be scheduled and administered within fourteen (14) calendar days after the dated "Notice to Proceed". The Contractor shall be prepared to address such topics as projected construction schedules, major personnel, critical work areas, construction facilities and shop drawing submittals.

1.03 PROGRESS MEETINGS

- A. The Engineer will schedule and administer progress meetings and specially called meetings throughout the duration of the Work at minimum monthly intervals.
- B. The time and location of such meetings shall be designated by the Engineer and shall be convenient for all parties involved.
- C. The Engineer will, prepare agenda with copies for participants, preside at meetings, record minutes, and distribute copies to participants, and those affected by decisions made.

PART 2 PRODUCTS

NOT USED

PART 3 EXECUTION

NOT USED

END OF SECTION



## SECTION 01300

### SUBMITTALS

#### PART 1 GENERAL

##### 1.01 SECTION INCLUDES

- A. Requirements for submission of schedules and shop drawings, including requirements for American Iron and Steel compliance.
- B. For submittal requirements related to contaminated soils, refer to Specification Section 02080 – Excavation and Management of Contaminated Soils.**

##### 1.02 RELATED SECTIONS

01631 – USE OF OTHER THAN FIRST NAMED MANUFACTURERS

01730 – OPERATIONS AND MAINTENANCE MANUALS

##### 1.03 PROJECT MANAGEMENT SOFTWARE

- A. The project will utilize Procore project management software. Veolia, as project manager, will own and administer the program. The Contractor shall be responsible for utilizing the program for all submittals, including shop drawings, RFIs, project schedules, and other project documents.

##### 1.04 PROGRESS SCHEDULE

- A. Within fourteen (14) calendar days following the receipt of the Notice to Proceed, the Contractor shall submit to the Engineer for review a construction progress schedule conforming to requirements specified (See Specification Section 01310). This schedule should show the proposed dates of commencement and completion of each of the various subdivisions of work required under this Contract and the anticipated monthly percentage of completion based on the total contract price. The Contractor shall be responsible for updating and/or revising this schedule whenever directed by the Engineer throughout the duration of the Contract.
- B. Special attention is directed to the requirement that the Contractor shall start the Work, as specified under this Contract, no later than thirty (30) calendar days after the execution of the Contract Documents, unless otherwise directed by the Owner. The Contractor shall comply with all pre-construction requirements as specified. The Owner reserves the right to delay the commencement of the Work or any part thereof if the specified requirements as determined by the Engineer have not been satisfied. The Owner further reserves the right to limit or, delay construction, or certain activities thereof, in certain areas of the Contract should the Owner deem it to be in the public's best interest and/or safety to do so.
- C. The Contractor shall contact the appropriate town or city authorities concerning any public or semi-public events that may occur during the construction period that may affect construction. The Contractor alone shall be responsible for arranging his construction

sequence to conform to any restrictions these events may impose. No claims for extras will be allowed because of any delay, extra materials handling, extra excavation, etc. caused by the imposed restrictions. However, additional time may be granted for completion of the work to compensate for delays caused by said restrictions.

#### 1.05 SHOP DRAWINGS

- A. Submit copies of all shop and working drawings of concrete reinforcement, structural details, piping layout, wiring, materials fabricated especially for the Contract, and materials and equipment for which such drawings are specifically requested.
- B. Shop drawings may be submitted electronically or via hard copy. Engineer's cover sheet, properly completed, shall accompany each submittal.
- C. A maximum of two (2) submittals of each shop drawing will be reviewed by the Engineer. If more submittals are required due to the Contractor's neglect or failure to fulfill the requirements of the Contract plans and specifications, or to make corrections or modifications required by the Engineer in the review of the first two submittals, the Engineer will review the submittal and the Contractor will be responsible for the cost of the review, as determined by the Owner based on the Engineer's documentation of time and rates for additional services established in the Engineering Agreement between the Owner and the Engineer.
- D. Such drawings shall show the principal dimensions, weight, structural and operating features, space required, clearances, type and/or brand of finish or shop coat, grease fittings, etc., depending on the subject of the drawing. When the dimensions are of particular importance, or when specified, the drawings shall be certified by the manufacturer or fabricator as correct for the Contract.
- E. When so specified or if considered by the Engineer to be acceptable, manufacturer's specifications, catalog data, descriptive matter, illustrations, etc., may be submitted in place of shop and working drawings.
- F. The Contractor shall be responsible for the prompt and timely submittal of all shop and working drawings to eliminate delay to the Work due to the absence of such drawings. All shop and working drawings must be submitted to the Engineer within thirty (30) calendar days prior to incorporation into the Work, unless otherwise permitted by the Engineer. **Prior to the submittal of any shop drawings, the Contractor shall submit a schedule of proposed shop drawing transmittals.** The schedule shall identify the subject matter of each transmittal, the corresponding specification section number and the proposed date of submission. Prior to and during the progress of the Work the schedule shall be revised and resubmitted as requested by the Engineer.
- G. No material or equipment shall be purchased or fabricated for the Contract until the required shop and working drawings have been submitted as hereinabove provided and reviewed for conformance to the Contract requirements. All such materials and equipment and the work involved in their installation or incorporation into the Work shall then be as shown in and represented by said drawings.

- H. Until the necessary review has been made, the Contractor shall not proceed with any portion of the Work (such as the construction of foundations) for which review is required.
- I. All shop and working drawings shall be submitted to the Engineer by and/or through the Contractor, who shall be responsible for obtaining shop and working drawings from his subcontractors and returning reviewed drawings to them. All shop and working drawings shall be prepared on standard size, 24 inch by 36 inch sheets, except those which are made by changing existing standard shop and working drawings. All drawings shall be clearly marked with the names of the Owner, Contractor, and building, equipment, or structure to which the drawing applies, and shall be suitable numbered. Submitted shop drawings shall be accompanied by a letter of transmittal, completed by the Contractor as approved by the Engineer.
- J. Only drawings which have been checked and corrected by the fabricator should be submitted to the Contractor by his subcontractors and vendors. Prior to submitting drawings to the Engineer, the Contractor shall check thoroughly all such drawings to satisfy himself that the subject matter thereof conforms to the Drawings and Specifications in all respects. All drawings which are correct shall be marked with the date, checker's name, and indication of the Contractor's approval, and then shall be submitted to the Engineer; other drawings shall be returned for correction.
- K. If a shop drawing shows any deviation from the Contract requirements, the Contractor shall make specific mention of the deviations in his letter of transmittal.
- L. If a material of piece of equipment other than the first named manufacturer in the specification is submitted, the submittal shall conform to the requirements of Specification Section 01631 – Use of Other than First Named Manufacturers.
- M. The review of shop and working drawings by the Engineer will be general only, and nothing contained in this Section shall relieve, diminish or alter in any respect the responsibilities of the Contractor under the Contract Documents and in particular, the specific responsibility of the Contractor for details of design and dimensions necessary for proper fitting and construction of the work as required by the Contract and for achieving the result and performance as specified. The Contractor shall be responsible for errors and omissions in shop drawings.
- N. Should the Contractor submit equipment that requires modifications to the structures, piping, electrical conduit, wires, appurtenances, or layouts etc., either existing or as detailed on the Drawings, he shall also submit details of the proposed modifications. If such equipment and modifications are accepted, the Contractor, at no additional cost to the Owner, shall do the work necessary to make such modifications.
- O. The Contractor shall furnish additional copies of shop drawings or catalog cuts when so requested.

1.06 AMERICAN IRON AND STEEL (AIS)

- A. **All shop drawings shall demonstrate compliance with the American Iron and Steel (AIS) requirements of P.L. 113-76, the Consolidated Appropriations Act of 2014. All “iron and steel products” shall be produced in the United States.**

In this section, the term “iron and steel products” means the following products made primarily of iron or steel: lined or unlined pipes and fittings, manhole covers and other municipal castings, hydrants, tanks, flanges, pipe clamps and restraints, valves, structural steel, reinforced precast concrete, and construction materials.

- B. Certification of compliance with AIS requirements shall consist of a certification letter from the product manufacturer. The Certification letter shall, at minimum, contain the following information:

1. Project Name – Taunton Wastewater Treatment Facility Improvements
2. Item(s) being provided to the Project
3. Location of manufacture (Factory Name, City and State)
4. Name of Contractor to whom product was delivered
5. Reference to American Iron and Steel requirements, and statement of compliance with them.
6. Signature of Company Representative.

A sample certification letter is attached to this section for the Contractor’s reference.

PART 2 PRODUCTS

NOT USED

PART 3 EXECUTION

NOT USED

END OF SECTION

**NOTE: The following information is provided as a sample letter of certification for AIS compliance. Documentation must be provided on company letterhead.**

Date

Company Name

Company Address

City, State Zip

Subject: American Iron and Steel Certification for Project (XXXXXXXXXXXX)

I, (company representative), certify that the following products and/or materials shipped/provided to the subject project are in full compliance with the American Iron and Steel requirement as mandated in EPA's State Revolving Fund Programs.

Item, Products and/or Materials:

1. XXXX
2. XXXX
3. XXXX

Such process took place at the following location:

\_\_\_\_\_

If any of the above compliance statements change while providing material to this project we will immediately notify the prime contractor and the engineer.

Signed by company representative

## SECTION 01310

### CONSTRUCTION PROGRESS SCHEDULE

#### PART 1 GENERAL

##### 1.01 SECTION INCLUDES

- A. Requirements for computer generated Critical Path Method (CPM) construction scheduling and Narrative progress report.
- B. No portion of this specification shall take precedent over SECTION 00500-Contract Agreement.

##### 1.02 SUBMITTALS

- A. Submit in accordance with SECTION 01300-Submittals
  - 1. The project will utilize Procore project management software. Veolia, as project manager, will own and administer the program. The Contractor shall be responsible for utilizing the program for all submittals, including shop drawings, RFIs, project schedules, and other project documents.
  - 2. Quality Assurance/Control Submittal
    - a. Name and version of CPM software proposed for use.
    - b. List of construction projects completed on which progress of work was controlled with CPM software.
  - 3. Schedule
    - a. Within **14 days** following the receipt of the Notice to Proceed, the Contractor shall submit a computer generated schedule and a list of activities to the Engineer. Following review by the Engineer and Owner the Contractor shall meet with the Engineer and Owner to discuss the review. The Contractor shall incorporate the Engineer's comments into the schedule and submit the revised schedule within 14 days following receipt of the Engineer's comments.
    - b. Following the commencement of construction activities, every two weeks the Contractor shall update the project schedule and submit a "look ahead" schedule which summarizes the anticipated construction activities for the upcoming two weeks.

#### PART 2 PRODUCTS

##### 2.01 SOFTWARE

- A. Computer based scheduling software used by the Contractor shall be the product of a recognized commercial computer software producer and shall be capable of meeting the requirements specified herein.

## PART 3 EXECUTION

### 3.01 PREPARATION

#### A. General

1. The Contractor shall prepare his proposed CPM schedule based on a breakdown of work tasks that he has developed.
2. The construction schedule and updates shall be prepared by the Contractor or the Contractor's qualified consultant.

#### B. Schedule

1. Each schedule shall be prefaced with the following summary data:
  - a. Contract name and number
  - b. Contractor's Name
  - c. Contract duration
  - d. The effective or starting date of the schedule
  - e. Revision date of the latest schedule.
2. The CPM schedule shall be sequenced by early start date and shall include the following minimum items:
  - a. Activity Name
  - b. Estimated duration
  - c. Activity description
  - d. Early start date (calendar date)
  - e. Early finish date (calendar date)
  - f. Latest allowable start date (calendar date)
  - g. Latest allowable finish date (calendar date)
  - h. Status (whether critical)
  - i. Estimated cost of the activity
  - j. Float (total and free)
  - k. Major milestones
3. Separate milestones shall be included for Notice-to-Proceed and Project Completion Date.
4. Activities shall include major components of the work including submittals that might impact the critical path, subcontractor work, major and critical equipment design, fabrication, testing, delivery and installation times, system/subsystem/component testing, process and facility startup, training, demobilization, project cleanup and closeout. Critical portions of process instrumentation and control system work, shall be defined in detail in a sub schedule.
5. The sum of the costs assigned to the activities shall be equal to the Contract price. Activity costs shall not be assigned to submittals or submittal reviews. Comply with SECTION 01026-Schedule of Values. Provide a table showing the anticipated monthly percentage of completion, based on the total contract price.
6. Critical activities, predecessors, free float and total float shall be clearly displayed on the schedule in graphical form. Schedules that contain activities showing negative float or that extend beyond the contract completion date will not be approved.
7. Each schedule submittal shall also include a list of activities in the order in which the activities will be performed, along with activity durations, activity predecessors, type of predecessor (finish-start, finish-finish, start-start, lead/lag), and any dependency or required date.

8. The schedule shall be based on a standard 5-day work week with allowance for holidays and adverse weather.
9. Engineer's approval of the CPM schedule is advisory only and shall not relieve the Contractor of responsibility for accomplishing the work prior to the contract completion date. Omissions and errors in the approved CPM schedule shall not excuse performance less than that required by the Contract. Approval by the Engineer in no way makes the Engineer an insurer of the CPM schedule's success or liable for time or cost overruns flowing from its shortcomings. The Owner hereby disclaims any obligation or liability by reason of approval by its agent, the Engineer, of the CPM schedule.

#### C. Narrative Progress Report

1. Include as a minimum:
  - a. Summary of work completed during the previous period (since submission of last narrative progress report).
  - b. Explanation for variations between actual work completed in previous period and planned work as reported in last period.
  - c. Summary of work planned during the next period.
  - d. Current and anticipated delaying factors and their estimated impacts on other activities and milestones, both critical and non-critical.
  - e. Corrective actions taken or proposed.
2. A Narrative Progress Report shall be submitted monthly to the Engineer, at least 5 working days prior to the progress meeting.
3. At the discretion of the Engineer, the Contractor may be required to submit a revised CPM schedule showing completion to date and any changes to the previous schedule.

### 3.02 MONITORING SCHEDULE

- A. The CPM approved construction schedule shall be used by the Contractor throughout the duration of the project for planning, organizing, and directing the Work, and for reporting progress of the Work
- B. The Contractor is solely responsible for monitoring schedule compliance. When a delay to the critical path occurs, the Contractor shall immediately notify the Engineer in writing. Within one week of the notification, the Contractor shall submit for the Engineer's approval, a description of proposed actions to return the project to schedule.

### 3.03 MODIFYING SCHEDULE

- A. If the Contractor desires to make changes in his method of operating which affect the approved CPM schedule, he shall notify the Engineer in writing stating what changes are proposed and the reason for the change. If the Engineer approves these changes, the Contractor shall revise and submit for approval, without additional cost to the Owner, all of the affected portions of the CPM schedule.
- B. It may be necessary for the contract schedule or completion time to be adjusted by the Owner to reflect the effects of job conditions, weather, technical difficulties, strikes, unavoidable delays on the part of the Owner or its representatives and other unforeseeable conditions which may indicate schedule adjustments or completion time extensions. Under such conditions, the Engineer will direct the Contractor to reschedule the work or contract



completion time to reflect the changed conditions and the Contractor shall revise his schedule accordingly.

- C. Float time is a project resource available to both the Contractor and the Owner to meet contract milestones and completion dates. Use of float suppression techniques such as preferential sequencing or logic, special lead/lag logic restraints, and extended activity times are prohibited, and use of float time disclosed or implied by use of alternate float suppression techniques shall be shared to proportionate benefit of OWNER and CONTRACTOR.
- D. If the Contractor provides an accepted schedule with an early completion date, the Owner reserves the right to reduce the Time of Completion to match the early completion date by issuing a deductive Change Order at no change in Contract Price.

END OF SECTION

## SECTION 01400

### QUALITY CONTROL

#### PART 1 GENERAL

##### 1.01 SECTION INCLUDES

- A. Requirements for Contractor's quality control of products, suppliers, manufacturers, services, site conditions, and workmanship, to produce Work of specified quality.

##### 1.02 QUALITY ASSURANCE/CONTROL OF INSTALLATION

- A. Comply fully with manufacturers' instructions, including each step in sequence.
- B. Should manufacturers' instructions conflict with Contract Documents, request clarification from Engineer before proceeding.
- C. Comply with specified standards as a minimum quality for the Work except when more stringent tolerances, codes, or specified requirements indicate higher standards or more precise workmanship.
- D. Perform work by persons qualified to produce workmanship of specified quality.
- E. Secure Products in place with positive anchorage devices designed and sized to withstand stresses, vibration, physical distortion or disfigurement.

##### 1.03 FIELD SAMPLES

- A. Install field samples at the site as required by individual specifications sections for review.
- B. Acceptable samples represent a quality level for the Work.
- C. Where field sample is specified to be removed, clear area only after field sample has been accepted by the Engineer.

##### 1.04 CERTIFIED WELDERS

- A. Structural welds shall be made only by operators who have been qualified by tests, as prescribed in the "Standard Qualification Procedure" of the American Welders Society, to perform the type of work required.
- B. Pipe welds shall be made only by operators who have been qualified by the National Certified Pipe Welding Bureau and each operator's qualification record shall be submitted to the Engineer before any work is performed.
- C. Shop welding shall be in accordance with the "Code for Welding in Building Construction".

PART 2 PRODUCTS

NOT USED

PART 3 EXECUTION

NOT USED

END OF SECTION

## SECTION 01410

### TESTING LABORATORY SERVICES

#### PART 1 GENERAL

##### 1.01 SUMMARY

###### A. Section Includes

1. Qualification, duties and responsibilities of testing laboratories for construction materials testing.
2. Coordination and scheduling responsibilities of the Contractor.
3. This section is for testing of construction materials only. For environmental testing requirements, refer to Specification Section 02080 – Excavation and Management of Contaminated Soils.

###### B. Related Sections

1. Section 01600 - Materials and Equipment
2. Section 02200 – Earth Excavation, Backfill, Fill, and Grading

##### 1.02 PAYMENT PROCEDURES

###### A. Initial Testing

1. The Owner will pay for initial testing services required by the Engineer.

###### B. Retesting

1. When initial tests indicate noncompliance with the Contract Documents, subsequent retesting occasioned by the noncompliance shall be performed by the same testing agency, and costs thereof will be deducted by the Owner from the Contract Sum.

###### C. Contractors Convenience Testing

1. Inspecting and testing performed exclusively for the Contractor's convenience shall be the sole responsibility of the Contractor.

##### 1.03 REFERENCES

###### A. American Society for Testing and Materials (ASTM)

1. E329, Agencies Engaged in Construction Inspection and/or Testing

## 1.04 REQUIREMENTS

### A. Work included:

1. Cooperate with the Owner's selected testing agency and all others responsible or testing and inspecting the Work.
2. Provide other testing and inspecting as specified to be furnished by the Contractor in this Section and/or elsewhere in the Contract Documents.
3. Where no testing requirements are described, but the Owner directs testing, the Contractor shall provide testing under the requirements of this Specification.

### B. Work not included:

1. Selection of testing laboratory: The Owner will select a qualified independent testing laboratory.

## 1.05 QUALITY ASSURANCE

### A. Qualifications

1. The testing laboratory will be qualified to the Owner's approval in accordance with ASTM E329.

### B. Regulatory requirements

1. Testing, when required, will be in accordance with all pertinent codes and regulations and with selected standards of the American Society for Testing and Materials.
2. Regulatory Requirements Inspections and tests required by codes or ordinances, or by a plan approved authority, and which are made by a legally constituted authority, shall be the responsibility of and shall be paid for by the Contractor, unless otherwise provided in the Contract Documents.

## 1.06 DELIVERY, STORAGE, AND HANDLING

### A. Comply with pertinent provisions of Section 01600 - Materials and Equipment.

### B. Promptly process and distribute, to the Engineer, required copies of test reports and instructions to assure necessary retesting and replacement of materials with the least possible delay in progress of the Work.

## 1.07 SCHEDULING

### A. Establishing schedule

1. By advance discussion with the testing laboratory selected by the Owner, determine the time required for the laboratory to perform its tests and to issue each of its findings.

2. Provide all required time within the construction schedule.
  3. Coordinate testing activity with the appropriate testing laboratory.
- B. Revising schedule
1. When changes of construction schedule are necessary during construction, coordinate all such changes with the testing laboratory as required.
- C. Adherence to schedule
1. When the testing laboratory is ready to test according to the established schedule, but is prevented from testing or taking specimens due to incompleteness of the Work, all extra charges for testing attributable to the delay may be back-charged to the Contractor and shall not be borne by the Owner.

## PART 2 PRODUCTS

NOT USED

## PART 3 EXECUTION

### 3.01 FIELD QUALITY CONTROL

#### A. Site Tests

1. Representatives of the testing laboratory shall have access to the Work at all times and at all locations where the Work is in progress. Provide facilities for such access to enable the laboratory to perform its functions properly.
2. All specimens and samples for testing, unless otherwise provided in the Contract Documents, shall be taken by the testing personnel. All sampling equipment and personnel will be provided by the testing laboratory. All deliveries of specimens and samples to the testing laboratory will be performed by the testing laboratory.

END OF SECTION

## SECTION 01441

### PROJECT SIGN

#### PART 1 GENERAL

##### 1.01 SECTION INCLUDES

- A. This specification covers the exterior project sign.

##### 1.02 RELATED SECTIONS

- A. SECTION 01300 – SUBMITTALS

##### 1.03 SUBMITTALS

- A. Shop Drawings in accordance with specification Section 01300.
- B. Submit a plan of the project sign, including location and size of logos, names of officials, and dimensions.

##### 1.04 MARKING, DELIVERY, STORAGE, AND HANDLING

- A. Sign shall be protected during delivery so as to be undamaged.

#### PART 2 PRODUCTS

##### 2.01 DESIGN

- A. Sign shall be as shown in Figure 1 of this specification. Sign size shall be 8'Wx4'H.

##### 2.02 MATERIALS

- A. Sign shall be constructed of durable materials so as to last the duration of the project with minimal wear.

##### 2.03 PAINTING/FINISHING

- A. Sign background shall be white. Writing shall be black. Logos shall be colored as shown in Figure 1.

#### PART 3 EXECUTION

##### 3.01 INSTALLATION

- A. Install with adequate support for site conditions and to resist wind loads.

FIGURE 1

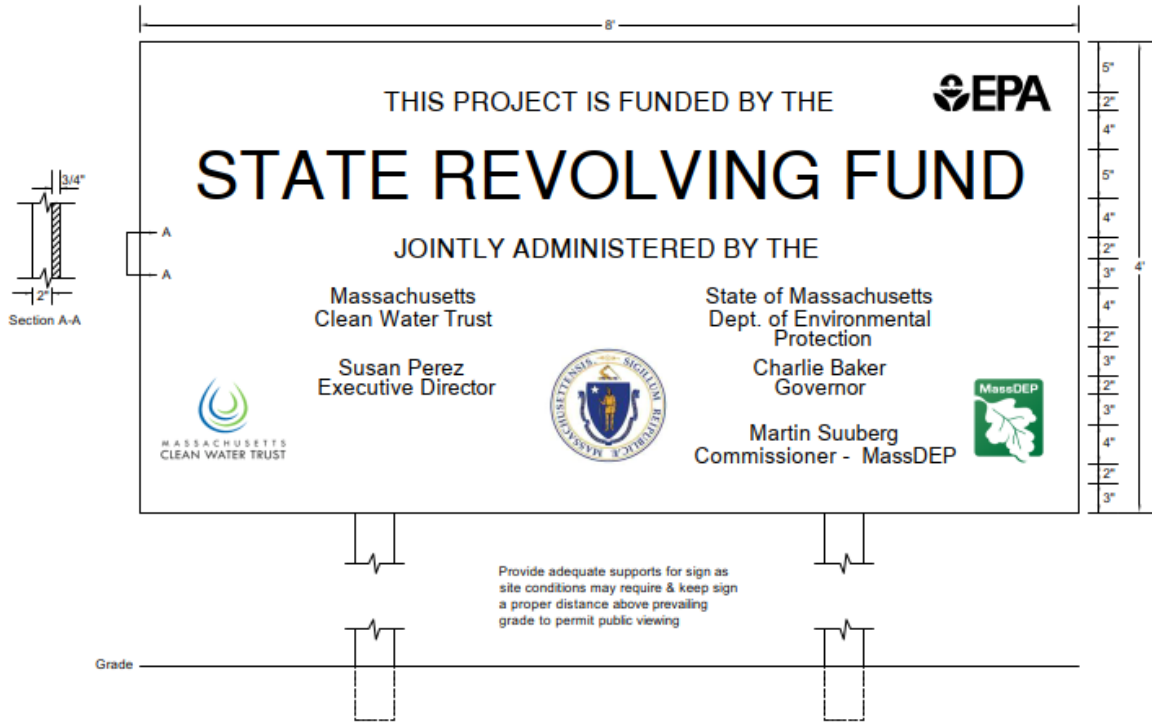

END OF SECTION



SECTION 01525

TEMPORARY ENCLOSURES

PART 1 GENERAL

1.01 SECTION INCLUDES

- A. Requirements for protecting portions of the Work which are affected by inclement weather conditions.
- B. Provide "Weather Protection" and heat to permit construction work to be carried on during the months of November through March. These Specifications are not to be construed as requiring enclosures or heat for operations that are not economically feasible to protect in the judgment of the Engineer. Included in the preceding category, without limitation, are such items as site work, excavation, pile driving, steel erection, erection of certain "exterior" wall panels, roofing, and similar operation.

1.02 SUBMITTALS

- A. Within 30 calendar days after execution of this contract, submit in accordance with Specification Section 01300, proposed methods for "Weather Protection".

1.03 WEATHER PROTECTION

- A. Weather Protection shall be provided for protection of that work adversely affected by moisture, wind and cold, by covering, enclosing and/or heating. This protection shall provide adequate working areas during dates consistent with the approved Progress Schedule to permit the continuous progress of all work necessary to maintain an orderly and efficient sequence of construction operations.
- B. Furnish and install all enclosures and be responsible for all costs, including heating required to maintain a minimum temperature of 40 degrees F., at the working surface. This provision does not supersede any specific requirements for methods of construction, curing of materials or the applicable general conditions set forth in the Contract Documents with added regard to performance obligations of the Contractor.
- C. Installation of weather protection and heating devices shall comply with all safety regulations including provisions for adequate ventilation and fire protection devices. Heating devices which may cause damage to finish surfaces shall not be used.

PART 2 PRODUCTS NOT USED

PART 3 EXECUTION NOT USED

END OF SECTION

## SECTION 01560

### TEMPORARY CONTROLS

#### PART 1 GENERAL

##### 1.01 SECTION INCLUDES

- A. Requirements for cleaning, maintenance of the site, barriers and fences required during construction.

##### 1.02 CLEANING DURING CONSTRUCTION

- A. Unless otherwise specified under the various trade Sections of the Specifications, the General Contractor shall perform clean-up operations during construction as herein specified.
  - 1. Control accumulation of waste materials and rubbish; periodically dispose of off-site. Bear all costs, including fees resulting from disposal.
  - 2. Clean interior areas prior to start finish work and maintain areas free of dust and other contaminants during finishing operations.
  - 3. Maintain project in accordance with all local, State and Federal Regulatory Requirements.
  - 4. Store volatile wastes in covered metal containers, and remove from premises.
  - 5. Prevent accumulation of wastes that create hazardous conditions.
  - 6. Provide adequate ventilation during use of volatile or noxious substances
- B. Conduct cleaning and disposal operations to comply with local ordinances and anti-pollution laws.
  - 1. Do not burn or bury rubbish and waste materials on site.
  - 2. Do not dispose of volatile wastes such as mineral spirits, oil, or paint thinner in storm or sanitary drains.
  - 3. Do not dispose of wastes into streams or waterways.
  - 4. Use only those materials which will not create hazards to health or property and which will not damage surfaces.
  - 5. Use only those cleaning materials and methods recommended by manufacturer of surface material to be cleaned.
  - 6. Execute cleaning to ensure that the buildings, the sites, and adjacent properties are maintained free from accumulations of waste materials and rubbish and wind blown debris, resulting from construction operations.
  - 7. Provide on-site containers for collection of waste materials, debris, and rubbish.
  - 8. Remove waste materials, debris, and rubbish from the site periodically and dispose of at legal disposal areas off the construction site.
  - 9. Handle material in a controlled manner with as little handling as possible. Do not drop or throw materials from heights.
  - 10. Schedule cleaning operations so that dust and other contaminants resulting from cleaning process will not damage surrounding surfaces.
  - 11. During its progress, the work and the adjacent areas affected thereby shall be kept cleaned up and all rubbish, surplus materials, and unneeded construction equipment shall be removed and all damage repaired so that the public and property owners will be inconvenienced as little as possible.
  - 12. Where material or debris has washed or flowed into or been placed in existing watercourses, ditches, gutters, drains, pipes, structures, work done under this contract, or

elsewhere during the course of the Contractor's operations, such material or debris shall be entirely removed and satisfactorily disposed of during the progress of the work, and the ditches, channels, drains, pipes, structures, and work, etc. shall, upon completion of the work, be left in a clean and neat condition.

#### 1.03 DUST CONTROL

- A. Provide adequate means for the purpose of preventing dust caused by construction operations throughout the period of the construction contract.
- B. This provision does not supersede any specific requirements for methods of construction or applicable general conditions or performance obligations of the General Contractor.

#### 1.04 EROSION AND SEDIMENT CONTROL

- A. Plan and execute construction by methods to control surface drainage from cuts and fills, from borrow and waste disposal areas. Prevent erosion and sedimentation.
- B. Minimize amount of bare soil exposed at one time.
- C. Provide temporary measures such as berms, dikes, and drains, to prevent water flow.
- D. Construct fill and waste areas by selective placement to avoid erosive surface silts for clays.
- E. Periodically inspect earthwork to detect evidence of erosion and sedimentation; promptly apply corrective measures.
- F. Construct sediment control devices for discharge from dewatering trenches.
- G. Construct all sedimentation control devices shown on the plans.

#### 1.05 NOISE CONTROL

- A. Develop and maintain a noise-abatement program and enforce strict discipline over all personnel to keep noise to a minimum.
- B. Execute construction work by methods and by use of equipment which will reduce excess noise.
  - 1. Equip air compressors with Silencers, and power equipment with mufflers.
  - 2. Manage vehicular traffic and scheduling to reduce noise.

#### 1.06 POLLUTION CONTROL

- A. Special care shall be taken to prevent contamination or muddying up or interfering in any way with the stream flows, if any along the line of work. No waste matter of any kind will be allowed to discharge into the stream flows or impounded water of any pools or other bodies of water.

## 1.07 SURFACE WATER CONTROL

- A. Take all precautions to prevent damage to the work or equipment by high waters or by storms. The Engineer with the approval of the Owner may prohibit the carrying out of any work at any time when in his judgment, high water or storm conditions are unfavorable or not suitable, or at any time, regardless of the weather, when proper precautions are not being taken to safeguard previously constructed work or work in progress.
- B. In case of damage caused by the failure of the Contractor to take adequate precautions, the Contractor shall repair or replace equipment damaged and shall make such repairs or rebuild such parts of the damaged work, as the Engineer may require, at no additional expense to the Owner.

## 1.08 BARRIERS AND ENCLOSURES

### A. Fences and Barricades

- 1. Provide and maintain temporary fences, barriers, lights, guardrails, and barricades as indicated in the Contract Documents, or as necessary to secure the Work and adjacent property, and protect persons and property.
- 2. Obtain necessary approvals and permits and provide temporary expedients as necessary to accommodate tasks requiring items mentioned herein.

### B. Protection of Trees

- 1. The Contractor shall take care not to harm trees along the sides of roads or with in the existing facility in which the construction work is to be done or trees on adjacent lands except as indicated on the drawings or with the written permission of the Owner and any other owner of the trees involved. Care shall be taken not to cut tree roots so as to harm the growth of trees to remain.
- 2. If, in the opinion of the Engineer, any trees damaged during construction can be repaired, the Contractor shall satisfactorily repair same at no further cost to the Owner.
- 3. If, in the opinion of the Engineer, any tree damaged during construction cannot be repaired and should be removed, the Contractor shall satisfactorily remove and replace, in kind, same at no further cost to the Owner.

## PART 2 PRODUCTS

NOT USED

## PART 3 EXECUTION

NOT USED

END OF SECTION

## SECTION 01600

### MATERIALS AND EQUIPMENT

#### PART 1 GENERAL

##### 1.01 SUMMARY

###### A. Section Includes

1. Requirements for delivery, storage, handling and installation of systems, materials, manufactured units, equipment, components, and accessories used in the work.

###### B. Related Sections

1. Section 01300 - Submittals

##### 1.02 DELIVERY

A. Refer to Specifications' Sections for requirements pertaining to delivery and handling of materials and equipment.

B. Transport products by methods to avoid product damage; deliver in undamaged condition in manufacturers' unopened containers or packaging, dry.

C. Provide equipment and personnel to handle products by methods to prevent soiling or damage.

D. Promptly inspect shipments to assure that products comply with requirements, that quantities are correct, and products are undamaged.

##### 1.03 STORAGE AND PROTECTION

A. Refer to Specifications' Sections for requirements pertaining to storage and protection of materials and equipment.

B. Store products in accordance with manufacturers' instruction, with seals and labels intact and legible. Store sensitive products in weather tight enclosures; maintain within temperature and humidity ranges required by manufacturers' instructions.

C. For exterior storage of fabricated products, place on sloped supports above ground. Cover products subject to deterioration with impervious sheet covering; provide ventilation to avoid condensation.

D. Store loose granular materials on solid surfaces in a well-drained area; prevent mixing with foreign matter.

E. Arrange storage to provide access for inspection. Periodically inspect to assure that products are undamaged, and are maintained under required conditions.

1.04 INSTALLATION STANDARDS

- A. Comply with Specifications and referenced standards as minimum requirements.
- B. Components required to be supplied in quantity within a Specification Section shall be the same, and shall be interchangeable.
- C. Do not use materials and equipment removed from existing structures, except as specifically required, or allowed, by the Contract Documents.
- D. Perform work by persons qualified to produce workmanship of specified quality.
- E. Secure products in place with positive anchorage devices designed and sized to withstand stresses, vibration, and racking.
- F. When work is specified to comply with manufacturers' instructions, submit copies as specified in Section 01300 - Submittals, distribute copies to persons involved, and maintain one set in field office.
- G. Perform work in accordance with details of instructions and specified requirements.

PART 2 PRODUCTS

NOT USED

PART 3 EXECUTION

NOT USED

END OF SECTION

## SECTION 01631

### USE OF OTHER THAN FIRST NAMED MANUFACTURERS

#### PART 1 GENERAL

##### 1.01 DESCRIPTION

- A. This Section includes requirements related to the Contractor's responsibilities when using a named manufacturer or product other than the first named.

##### 1.02 EQUIVALENT MATERIALS AND EQUIPMENT

- A. Whenever a material, article, or method is specified or described by using the name of a proprietary product or the name of a particular manufacturer(s) or vendor(s), followed by the phrase "or equal," the specific item mentioned shall be understood as establishing the type, function, dimension, appearance, and quality desired and is to be the basis upon which bids are to be prepared, subject to the provisions of this Section. Named manufacturers are listed to represent a required standard of quality. However, equipment furnished shall be required to meet all the requirements of the Section, regardless of the "standard offerings" of a given manufacturer. This may mean that a listed manufacturer will have to fabricate special order equipment in order to meet the full intent of this Section.
- B. In every instance, the design was completed using criteria required to accommodate the first named manufacturer. When practical, other named manufacturers were included in the Technical Specifications based upon performance and design criteria comparable to the first named. However, in some instances, the size, shape, loadings, configuration, and/or other design criteria for other named manufacturers may require redesign of the Work. Other named manufacturers may be used subject to the requirements of this Section.
- C. When the Contractor uses any manufacturer or product other than the first named in the specifications, which use requires modification to the Work, the Contractor shall, to the satisfaction of the Engineer, review and revise the design of the Work, including coordination with other Technical Specification sections to ensure that all component units fit and function as a whole, to properly accommodate the use of that product.
- D. Should equipment which differs from that named in any Section be offered and determined to be the equal of that specified, such equipment shall be acceptable only on the basis that any revision in the design and/or construction of the structure, piping, appurtenant equipment, electrical work, etc, required to accommodate such a substitution shall be made at no additional cost to the Owner and be as approved by the Engineer.
- E. The Contractor shall bear the costs and liability for all redesigned elements of the Work necessary to properly accommodate the proposed item.

##### 1.03 SUBMITTALS

- A. In addition to the requirements of Section 01300, the Contractor shall submit complete data and engineering documents that provide a complete analysis of the proposed item and the

extent of the redesign of the Work necessary to properly incorporate the proposed item into the Work. The Contractor shall:

- B. Identify each and every element of the design of the Work that must be modified to:
  - 1. Accommodate the proposed item.
  - 2. Coordinate the proposed item with the overall design, inclusive of all related disciplines.
  - 3. Ensure the proper functioning of the entire system in which the item is to be incorporated.
  
- C. Include complete engineering drawings, bearing the seal of a Professional Engineer registered in the State of Massachusetts, addressing all requirements in 1.02 above.

PART 2 PRODUCTS (NOT USED)

PART 3 EXECUTION (NOT USED)

END OF SECTION



## SECTION 01665

### SERVICES OF MANUFACTURER'S REPRESENTATIVES

#### PART 1 GENERAL

##### 1.01 SECTION INCLUDES

- A. Requirements for services provided by manufacturer's representatives.

##### 1.02 SERVICES OF MANUFACTURER'S REPRESENTATIVES

###### A. General

1. Arrange for a qualified factory trained service representative from each company manufacturing or supplying certain equipment and systems, as listed in the Table at the end of this section and as specified in Division 11 through Division 16, to perform the duties described herein.
2. Qualified factory trained service representative shall be approved by the Engineer
3. All 8-hour days specified herein and in other sections of the specifications are exclusive of travel time
4. Services of Manufacturer's Representative shall not commence until an Operation and Maintenance Manual has been submitted and approved for each piece of equipment and system.

###### B. Supervision of Installation

1. Provide on-site supervision and advice to the Contractor to insure that proper procedures are followed during equipment installation.

###### C. Equipment Checkout

1. Inspect, align, operate, test and adjust the equipment after equipment installation has been completed and equipment is presumably ready for operation, but before it is operated by others.
2. The inspection shall include, but shall not be limited to, the following points as applicable:
  - a. Soundness (without cracked or otherwise damaged parts)
  - b. Completeness in all details as specified
  - c. Correctness of setting, alignment, and relative arrangement of various parts
  - d. Adequacy and correctness of packing, sealing and lubricants.
3. Operate, test and adjust the equipment, as required, to prove that the equipment is left in proper condition for satisfactory operation under the conditions specified.
4. Upon completion of the work, submit a complete signed report of the result of the inspection, operation, adjustments and tests to the Engineer via the Contractor. The report shall include:
  - a. Detailed descriptions of the points inspected and work completed
  - b. Deficiencies noted and/or corrected
  - c. Tests and adjustments made
  - d. Quantitative results obtained if such are specified
  - e. Suggestions for precautions to be taken to ensure proper maintenance

- f. A certificate that specifically states that "... the equipment conforms to the requirements of the Contract and is ready for permanent operation and that nothing in the installation will render the manufacture's warrantee null and void".

#### D. Field Acceptance Test

1. Tests shall be conducted by the Contractor, with assistance from the manufacturer's representative, after the Engineer has reviewed completed and equipment checkout report
2. Manufacturer's representative shall be present during field acceptance tests

#### E. Pre-Startup Operator Training

##### 1. General

- a. Provision for classroom and hands on training to plant personnel in the operation and maintenance of the equipment prior to placing the equipment in full operation.
- b. Provide the Owner's personnel and their consultants with sufficient information and skills training on the theory, design, site specific operation and maintenance practices (including items such as routine monitoring with normal and abnormal parameters, troubleshooting techniques, and preventive and corrective maintenance requirements) to insure that equipment and systems can be efficiently and effectively operated and maintained by the trainees upon completion of the training.
- c. Training shall be a combination of classroom, field observance and hands-on applications.
- d. Provide the following as specified herein:
  - 1) Lesson Plans
  - 2) Trainee Manuals
  - 3) Catalog of training materials.
- e. The Contractor shall provide a credit to the Owner for any unused instructor hours.
- f. Training classes shall be based on the approved Contractor Operation and Maintenance Manual.
- g. Conduct the training at scheduled times in accordance with the Contractor's approved comprehensive training schedule for all equipment, system and components. All training shall be coordinated and scheduled with the Owner a minimum of 7 days in advance. All training sessions will be conducted during the day shift. Currently the day shift is approximately 7:00 AM to 3:00 PM. For scheduling and training effectiveness, no one class will be longer than 4 hours.

##### 2. Operations Sessions

- a. Overview of the equipment and its' auxiliary support/systems covering nomenclature, function and theory of operation.
- b. General safety requirements for operation of the equipment and its' auxiliary/support systems, including suggested safety equipment.
- c. Pre-start-up safety and equipment check.
- d. Equipment and auxiliary/support systems start-up procedures covering manual and automatic modes, if available.
- e. Routine operation and monitoring requirements; including specifics on normally expected ranges for items such as oil, water pressure and temperatures, discharge pressures, sensory observations, etc., procedures to change operating parameters (such as air or flow rates).
- f. Equipment/systems shut down procedures covering manual and automatic modes (if applicable).
- g. Operational troubleshooting of equipment and auxiliary/support systems.
- h. Procedures for handling non-routine operational problems such as response to alarms, power failures, emergency shutdown, auxiliary/support system failures, etc.

##### 3. Maintenance Sessions

- a. If session is specific to a discipline; (e.g., electrical, mechanical, I&C), include only appropriate maintenance items for the discipline. If session is to include multiple disciplines, include all items for those disciplines and indicate in submittal outline which discipline the material refers to.
- b. For All Disciplines provide:
  - 1) An overview of the equipment and its' auxiliary/support systems covering nomenclature, function and theory of operation.
  - 2) General safety requirements for maintenance of the equipment and its' auxiliary/support systems appropriate to each discipline including suggested safety equipment and practices. Cover local/remote lockout procedures, safe procedures for handling alarms and built in safety devices during preventive and corrective maintenance.
  - 3) Overview of pre-start-up, routine operation monitoring, and shutdown procedures covering automatic and manual modes (if applicable).
- c. For Each Specific Discipline provide:
  - 1) Preventive maintenance procedures to be followed; include parts' lube quantities, types, frequencies, application points, time requirements to perform procedures, etc.  
 Note: Information should be provided to trainees from the O&M manuals which cross references manufacturer's lube requirements.
  - 2) Specific procedures to cover adjustment requirements for alignment, wear, calibration, etc. for all preventive maintenance and corrective maintenance procedures, including time required to perform.
  - 3) Special tools, techniques or procedures required for either preventive or corrective maintenance of equipment or its' auxiliary support systems.
  - 4) Assembly/disassembly procedures required for preventive or corrective maintenance, including time required to perform.
  - 5) Maintenance troubleshooting of equipment and auxiliary/support systems.

#### F. Post-Startup Services

1. Provision for assistance to the Owner in the calibration, tuning and troubleshooting, plus any additional training which may be required during the one-year guarantee period.

### 1.03 SUBMITTALS

1. Submit instructor qualifications, training outline, and lesson plans 90 calendar days prior to pre-startup operator training. Qualifications of the factory trained service representative, as defined below.
2. Submit trainee manuals at least 30 calendar days prior to scheduled training.
3. Training Outline/ Lesson Plans:
  - a. 4 copies
  - b. Training outline/lesson plans to cover each major trainee group (i.e.: operations, electrical maintenance, instrumentation, etc). If the same session outline is to be used for more than one type of trainee group, such as one which would cover equipment identification and principals of operation, this information should be so indicated on the outline. The outline should be detailed and include length of session for each major topic and type of session; i.e., field or classroom.
  - c. The lesson plan shall be cross referenced to the trainee manuals provided and include instructor references for the use of training aids, training strategies, etc. They should contain sufficient technical material to guide the instructor in the delivery of the training material session. Lesson plans are to be provided for each separate technical discipline to be trained. Generic "informational" lesson plans may be used for

multiple trainee discipline target groups. The specific number of lesson plans for each session will be determined by the complexity, content and objectives of the subject equipment covered.

- d. The purpose of the manual is to provide specific guidance for the instructor and the trainees on what is to be taught and how, as well as to insure consistency and completeness of the sessions when they are presented to different groups of the same target trainee group.
4. Trainee Manuals
    - a. 4 final copies.
    - b. Key trainee manuals to the training outline. Copies should be available to pass out to each trainee at the session, they are to be retained by the trainee for future use. This trainee manual is not the O&M manual required in the specification, however, similar materials may be included as appropriate.
    - c. The purpose of the manual is to provide an organized package of information for the trainee, which will be used during the training sessions as well as for future reference material.
    - d. The organization of the manual should correspond to the training outline. Material in the manual should include information on the training topics, the training outline, and other relative reference material. Specifically, all manuals should be geared toward an eighth grade level of reading.
    - e. Manuals for Operations training sessions should include a description of the equipment, pre-start-up checks, start-up and shutdown procedure, specific monitoring checks including expected parameters, troubleshooting and safety procedures, etc. as described previously.
    - f. Manuals for Maintenance training sessions should include a description of the equipment, pre-start-up checks, start-up and shutdown procedure, specific monitoring checks including expected parameters, troubleshooting and safety procedures, etc. as described previously.
  5. 2 copies of a catalog of all training materials including training outline, lesson plans and trainee manuals.

#### 1.04 QUALITY ASSURANCE

##### A. Qualifications

1. Factory trained service representative shall have the training and experience to provide technical and/or process related advice, and/or assistance, relating to the installation, operation, maintenance and utilization of the products that he represents. Additional qualifications may be specified elsewhere.
2. Representative is subject to acceptance by Engineer. No Substitute representatives will be allowed unless prior written approval by Engineer has been given.

#### PART 2 PRODUCTS

NOT USED

#### PART 3 EXECUTION

- A. Equipment and Components Requiring Services is listed in the Table at the end of this section

B. Provide a credit to the Owner for unused service manhours as specified below, at the manufacturer's published field service rate plus travel costs.

<b>Specification Section</b>	<b>Section Number</b>	<b>Supervision of Installation</b>	<b>Equipment Checkout</b>	<b>Field Acceptance Tests</b>	<b>Pre-Startup Operator Training</b>	<b>Post-Startup Services</b>
Automatic Algae Sweeping System <sup>1</sup>	11100	4	8	8	8	4
Peristaltic Chemical Metering Pumps	11300	4	8	8	4	4
Submersible Mixers	11301	4	4	4	4	4
Submersible Sewage Dewatering Pumps	11305	4	8	4	4	4
Vertical Centrifugal RAS & WAS Pumps <sup>2</sup>	11312	4	8	8	4	4
Submersible Propeller Pumps	11315	4	4	4	4	4
Hyperboloid Mixer Aerators	11316	4	8	8	8	4
Final Clarifier Equipment <sup>1</sup>	11327	16	16	16	8	8
Positive Displacement Bowers	11372	4	4	4	4	4
Fine Bubble Aeration Equipment	11376	4	8	8	4	4
Single Stage Centrifugal Air Blowers	11378	8	8	8	8	8
HDPE Chemical Storage Tanks	11400	4	4	4	4	4

<sup>1</sup> Part of Additive Alternative #1

<sup>2</sup> Part of Bid Package #3

EQUIPMENT CERTIFICATION

Owner: \_\_\_\_\_ Date: \_\_\_\_\_

Project : \_\_\_\_\_  
\_\_\_\_\_

Contractor: \_\_\_\_\_  
\_\_\_\_\_

Equipment Manufacturer: \_\_\_\_\_  
\_\_\_\_\_

Equipment: \_\_\_\_\_

Specification Section: \_\_\_\_\_

As an authorized representative of the Equipment Manufacturer, the undersigned certifies that the equipment listed above conforms to the requirements of the construction contract between the Contract and the Owner. The undersigned further certifies that the equipment has been installed in accordance with the Manufacturer's written instructions, that the equipment is ready for permanent operation and that nothing in the installation will render the Equipment Manufacturer's warranty null and void.

\_\_\_\_\_  
(Authorized Manufacturer's Representative)

Date: \_\_\_\_\_

\_\_\_\_\_  
(Witness)

Date: \_\_\_\_\_

Remarks: \_\_\_\_\_  
\_\_\_\_\_  
\_\_\_\_\_  
\_\_\_\_\_

EQUIPMENT TRAINING CERTIFICATION

Owner: \_\_\_\_\_ Date: \_\_\_\_\_

Project: \_\_\_\_\_

\_\_\_\_\_

Contractor: \_\_\_\_\_

\_\_\_\_\_

Equipment Manufacturer: \_\_\_\_\_

\_\_\_\_\_

Equipment: \_\_\_\_\_

Specification Section: \_\_\_\_\_

As an authorized representative of the Equipment Manufacturer, I certify that I have trained the Owner's personnel in the proper operation and maintenance of the above equipment.

\_\_\_\_\_  
(Authorized Manufacturer's Representative)

Date: \_\_\_\_\_

The following personnel listed below attended the training session(s):

\_\_\_\_\_  
\_\_\_\_\_  
\_\_\_\_\_  
\_\_\_\_\_

\_\_\_\_\_  
(Owner's Representative)

Date: \_\_\_\_\_

\_\_\_\_\_  
(Beta Group, Inc. Witness)

Date: \_\_\_\_\_

END OF SECTION

## SECTION 01680

### EQUIPMENT AND SYSTEM CHECKOUT, CERTIFICATIONS AND TESTING

#### PART 1 GENERAL

##### 1.01 SECTION INCLUDES

- A. Requirements and procedures for physical checkout, certification, and testing of equipment.

##### 1.02 DEFINITIONS

- A. Shop Testing is defined as testing that is done by the manufacturer either at the place of manufacture, the place of assembly, or at another location where the required testing apparatus is located, for the purpose of proving that the equipment meets the requirements of the pertinent technical specification(s).
- B. Equipment Checkout, Inspection and Certification is defined as the process of physically inspecting products after they have been installed in the work, and then certifying that the products have been properly and completely installed, and are ready for field and/or functional testing.
- C. Field Testing is defined as testing that is performed by the Contractor with supplier assistance on products they have been installed in the work and after the performance of physical checkout, for the purpose of proving that the tested products meet the requirements of the pertinent technical specifications. While field testing can be described as "shop testing in the field", it may be required regardless of whether or not shop testing was performed on the same piece of equipment or material.
- D. System Testing is defined as testing performed on a "system" normally comprised of two or more pieces of equipment, after the equipment has been installed in the work, and after physical checkout and field testing has been completed, for the purpose of providing that the system meets requirements as specified and as indicated.
- E. Manufacturer's Representative, sometimes referred to as the Factory-Trained Service Technician, is defined as a person or persons provided by the manufacturer, who is qualified by having the training and experience to provide technical and/or process related advice, and/or assistance, relating to the installation or utilization of the products provided by that same manufacturer, for installation and utilization in the work. Such training and experience shall include a minimum of three years participation in similar work including no less than three similar projects during this three year period. The qualifications of each representative must be submitted to the Engineer for approval at least 30 days prior to their first site visit.
- F. The Testing Checkout Coordinator is defined as the person provided by the contractor to coordinate and oversee the total spectrum of testing and inspection activities required by the contract documents. The testing and checkout coordinator shall have been in responsible charge of at least two similar projects in the last four years.



### 1.03 ROLES AND RESPONSIBILITIES

- A. The Contractor shall provide all outside services, materials, labor, supplies, test equipment and other items necessary to perform the testing specified herein. In addition, arrange for and provide the participation or assistance of survey crews, engineers, quality control technicians, manufacturers' representative(s), and required governmental agency representatives.

### 1.04 CHECKOUT PLAN

- A. The Contractor shall submit a checkout plan based upon the requirements defined herein to the Engineer. Six copies of checkout plan (preliminary) shall be submitted for review within 90 calendar days prior to the proposed date of the first test, whichever occurs first. The plan shall define:
  - 1. The logical and systematic performance of physical inspections, shop, field, and system tests.
  - 2. A list of all shop tests, and supplier certifications, including those required by the applicable technical specifications. Provisions shall also be included for retesting in the event it is required.
  - 3. Participants in the testing.
  - 4. Special test equipment.
  - 5. Sources of the test media (water, power, air) and the proposed method of delivery of the media to the equipment to be tested.
  - 6. Ultimate disposal of the test media.
- B. The plan shall be reviewed by the Engineer, modified or revised as necessary by the Contractor, then approved by the Engineer. The Contractor shall continue to update the checkout plan, working in conjunction with the Engineer prior to the start of the scheduled equipment checkout and functional testing activities.
- C. The Contractor shall designate, in the checkout plan, a testing and checkout coordinator to coordinate and manage the activities defined in the checkout plan, as approved by the Engineer.

### 1.05 EQUIPMENT AND SYSTEM CHECKOUT AND CERTIFICATIONS

- A. Checkout is defined as inspection by the Contractor, Engineer and Owner to verify conformance to the contract drawings and specifications. Checkout procedures will be conducted by the Contractor in the presence of the Engineer and Owner to verify the presence, appropriateness, and proper construction or installation of each being "checked out". Typical elements of the checkout include the following:
  - 1. Verify exterior areas for backfill, grading, surfacing, drainage, landscaping, roadways, fencing, and gates.
  - 2. Verify buildings for structure, masonry, architectural, mechanical systems, electrical/lighting, communications, and HVAC.
  - 3. Verify concrete structures for structural integrity, finish tolerance, durability, appearance, embedded and inserted items, painting and surface applications.
  - 4. Verify steel structures for member alignment, connection bolts torque, connection welds integrity, painting, fire proofing and surface applications.
  - 5. Verify mechanical systems and items for setting, alignment and securing, check and adjust packing and seals, lubrication, drying out, drive connection and alignment

including rotation and belt/chain tension, painting or surface applications, and tagging for project system.

6. Verify piping systems for material, size, components, direction, alignment of joints and bolts/welding, packing and seals, screens and filters and strainers, leak and pressure hydro tests, painting and color coding, hangers and anchors and expansion provision and supports, clean out of foreign matter and tagging for project system.
  7. Verify electrical and control/instrumentation systems for conduit and tray installation, wire/cable material and size, circuit continuity and identification, voltage testing, ground continuity and testing, terminal installation and identification, jar switches and circuit breakers and transformers tested, substation operation tested, and tagging for project system.
  8. Verify communication system including telephone, fire/smoke alarm, security, page/part, closed circuit TV similar to electrical above.
  9. Verify computer systems by station, function, and network interface.
- B. Each piece of equipment and system must be certified by the manufacturer's representative as specified in Section 01665 Services of Manufacturer's Representatives.
- C. Certifications shall not be completed until an Operation and Maintenance Manual has been submitted and approved.

#### 1.06 FIELD TESTING OF EQUIPMENT

- A. When required by the technical specifications, perform field testing on installed equipment. Field testing shall be in addition to and not in lieu of, any shop testing either required or otherwise performed. Perform field testing as a part of the overall equipment and system testing process defined herein and in accordance with the approved checkout plan.
- B. Provide ninety days written notice indicating the date and time for testing one piece of equipment, or a series of equipment pieces. Submit with this notice the following for approval by the Engineer:
1. Description of the tests, specifically outlining how the test will prove conformance with the requirements in the technical specifications.
  2. Testing devices that will be used in the tests. Description shall state what portion of the tests that the devices will perform or measure, and device accuracy.
  3. Personnel used to perform the tests. Submit resumes, qualifications, and experience. As a minimum, personnel must have three years experience with the manufacturer and operation of the equipment to be tested and will have participated in five similar tests during this period of experience.
  4. Schedule of testing. Schedule shall include frequency of measurements, personnel present, and contingency plans for equipment and/or test failure.
  5. Test forms. Provide test forms for recording reporting on the field test data, prior to the test.
  6. Material and equipment required for the test. This material and equipment shall be supplied at no additional cost to the Owner.
  7. Water and Power Requirements. Water and power requirements shall be identified in the plan by the Contractor and will be supplied by the Contractor for field testing purposes. The Contractor shall provide all temporary piping and wiring required for field testing; and equipment and labor for the reuse of the test water. When testing is performed with water during freezing conditions, the Contractor shall take measures to prevent damage to the work caused by freezing of the water.

8. Operational Requirements. Include valve positions, set-ups, gate positions, including temporary arrangements that are required to run the tests so that the Owner can anticipate and plan for the testing situation.
  9. Provide seven days written notice to the Engineer prior to the actual start of any testing. This will include a statement by the Contractor that the equipment and facilities to be tested have been thoroughly inspected and cleaned of construction debris or other extraneous materials and all lubrication, materials, and preparations are completed.
- C. Field test procedures will be reviewed and returned by the Engineer within 30 days of receipt. Incorporate minor comments on the procedures, equipment, or personnel prior to testing. Major comments by the Engineer will require a resubmission of the field test procedure and proposed test date. The Contractor will be notified, in writing, by the Engineer if a formal resubmission is required with the transmittal of the review comments.
- D. Submit within one week after completion of the tests, the following to the Engineer for approval:
1. Completed test forms for each device tested.
  2. Completed certification documentation.
  3. A written summary of testing, reporting on the results and summarizing the entire procedure.
  4. A schedule for retesting, if necessary. Perform any retesting required to fulfill the intent of the technical specification test requirements at no additional cost to the Owner.

#### 1.07 SYSTEM TESTING

- A. Specific system tests shall be performed by the general contractor in addition to the requirement for shop, field, and other tests called for in the technical specifications. System tests will be performed with fluid or gaseous substances that are generally non-septic, non-corrosive, non-toxic, and non-inflammable.
- B. Provide 30 days written notice indicating the date and time during which the specific functional test is proposed. Submit with this notice, the following to the Engineer for approval:
1. Testing devices that will be used in the tests. Description shall state what portion of the tests that the devices will perform or measure, and device accuracy.
  2. Personnel used to perform the tests. Submit resumes, qualifications, and experience. As a minimum, personnel must have three years experience with the manufacturer and operation of the equipment to be tested and will have participated in five similar tests during this period of experience.
  3. Schedule for Testing: Schedule shall include frequency of measurements, personnel present, and contingency plans for equipment and/or system test failure.
  4. Test forms. Provide test forms for recording reporting on the field test data, prior to the test.
  5. Material and equipment required for the test. This material and equipment shall be supplied at no additional cost to the Owner.
  6. Water and Power Requirements. Water and power requirements shall be identified in the plan by the Contractor and will be supplied by the Contractor for system testing purposes. The Contractor shall provide all temporary piping and wiring required for field testing; and equipment and labor for the reuse of the test water. When testing is performed with water during freezing conditions, the Contractor shall take measures to prevent damage to the work caused by freezing of the water.

7. Operational Requirements. Include valve positions, set-ups, and gate positions that are required to run the tests in the written request so that the Engineer can anticipate and plan for the testing.
  8. Provide seven days written notice to the Engineer prior to the actual start of any testing. This will include a statement by the Contractor that the equipment and facilities to be tested have been thoroughly inspected and cleaned of construction debris or other extraneous materials and all lubrication, materials, and preparations are completed.
- C. The Engineer, and the Owner may witness the performance of these tests, at their option.
- D. A review of the system test package by the Engineer will be made within two weeks of receiving the package. The Contractor shall incorporate minor comments on the procedures, equipment, and personnel prior to testing. Major comments by the Engineer will require a resubmission of the system test package and test date.
- E. Submit within one week after completion of the tests, the following to the Engineer for approval.
1. Completed test forms, for each device.
  2. Completed certification.
  3. A written summary of testing, reporting on the results and summarizing the entire procedure.
  4. A schedule for retesting, if necessary, including changes to procedures, testing devices, or personnel. Any retesting required to fulfill the intent of the test requirements due to negligence, poor workmanship, or products that fail to meet the contract requirements, shall be at no additional cost to the Owner.

#### 1.08 CORRECTIONS TO THE WORK

- A. Correct any items of work failing to meet the specified requirements, at no additional cost to the Owner. Correct the nonconforming items by re-work, modification, or replacement, to the option of the Engineer. This includes the provision of all required labor, materials, and requirements for retesting as specified herein, to verify that the items conform with contract documents.

#### 1.09 SAFETY

- A. Conduct all specified test procedures in compliance with all applicable safety standards and regulations.

#### PART 2 PRODUCTS

NOT USED

#### PART 3 EXECUTION

NOT USED

END OF SECTION

## SECTION 01700

### CONTRACT CLOSE-OUT

#### PART 1 GENERAL

##### 1.01 SECTION INCLUDES

- A. Requirements for specific administrative procedures, record keeping, close-out submittals, and forms used at substantial and final completion of the Work.
- B. Contractor shall satisfy all administrative requirements within the Contract Documents and the Requirements listed in this section prior to Contract Close-out.

##### 1.02 FINAL CLEANING

- A. On or before the completion of the work, the Contractor shall, unless otherwise especially directed or permitted in writing, tear down and remove all temporary buildings and structures built by him; shall remove all temporary works, tools, and machinery or other construction equipment furnished by him; shall remove all rubbish from any grounds which he has occupied; and shall leave the roads and all parts of the premises and adjacent property affected by his operations in a neat and satisfactory condition.
- B. The Contractor shall restore or replace, when and as directed, any public or private property damage by his work, equipment, or employees, to a condition at least equal to that existing immediately prior to the beginning of operations. To this end, the Contractor shall do as required, all necessary highway or driveway, walk and landscaping work. Suitable materials, equipment, and methods shall be used for such restoration. The restoration of existing property or structures shall be done as promptly as practicable as work progresses and shall not be left until the end of the contract period.
- C. Unless otherwise specified under the various Sections of the Specifications, the Contractor shall perform final cleaning operations as herein specified prior to final inspection.
- D. At completion of work, remove waste materials, rubbish tools, equipment, machinery and surplus materials, and clean all sight-exposed surfaces; leave project clean and ready for occupancy.
- E. Cleaning shall include all surfaces, interior and exterior in which the Contractor and all Subcontractors have had access whether existing or new.
- F. Refer to Sections of the Specifications for cleaning of specific products or work.
- G. Use only those materials which will not create hazards to health or property and which will not damage surfaces.
- H. Use only those cleaning materials and methods that are recommended by the manufacturer of surfaces material to be cleaned.
- I. Employ experienced workmen, or professional cleaners, for final cleaning operations.

### 1.03 PROJECT RECORD DOCUMENTS

- A. Project Record Documents also referred here as Record Drawings shall consist of all the contract drawings.
- B. The Contractor and all Subcontractors shall be required to maintain one set of Record Drawings, as the work relates to their Sections of the Specifications, at the site.
- C. Record Drawings shall be stored and maintained in the General Contractor's field office apart from other documents used for construction. The Record Drawings shall be maintained in a clean, dry, and legible condition and shall not be used for construction purposes.
- D. Record Drawings shall be available at all time for inspection by the Engineer. All deficiencies noted shall be promptly corrected.
- E. The following information shall be indicated on the Record Drawings for building construction:
  - 1. Record all changes, including change orders, in the location, size, number, and type both horizontally and vertically of all elements of the projects which deviate from those indicated on all the contract drawings.
  - 2. The tolerance for the actual location of utilities and appurtenances within the building to be marked on the Record Drawings shall be plus or minus two (2) inches.
  - 3. The location of all underground utilities and appurtenances referenced to permanent surface improvements, both horizontally and vertically at ten (10) ft. intervals and at all changes of direction.
  - 4. The location of all internal utilities and appurtenances, concealed by finish materials, including but not limited to valves, coils, dampers, vents, clean outs, strainers, pipes, junction boxes, turning vanes, variable and constant volume boxes, ducts, traps and maintenance devices. The location of these internal utilities, appurtenances and devices shall be shown by offsets to the column grid lines on the drawings.
  - 5. Each of the utilities and appurtenances shall be referenced by showing a tag number, area served and function on the Record Drawings.
  - 6. Prior to the installation of all finish materials, a review of the Record Drawings shall be made to confirm that all changes have been recorded. All costs to investigate such conditions shall be borne by the applicable party as demonstrated by the Engineer.
- F. The following information shall be indicated on the Record Drawings for sewer construction:
  - 1. Location of manholes with 3 swing ties.
  - 2. Linear distance of sewer from manhole to manhole, including size and type of pipe.
  - 3. Manhole rim elevation and invert elevations of all pipes within manholes, including drops.
  - 4. Recalculated pipe slopes based on record elevations.
  - 5. Location in feet from downstream manhole of wyes and chimneys and vertical height of chimneys.
  - 6. Length of service connections.
  - 7. Location of service connection terminus (at property line) with 3 swing ties and depth from existing surface grade.
  - 8. Pumping station information as detailed in 1.03, E.
- G. The following information shall be indicated on the Record Drawings for water main construction:

1. Linear distance along watermain from appurtenance (i.e. vault to tee, tee to bends, bends to valves, blow offs and service corporations, including size and type of pipe).
  2. Depths of pipe and fittings.
  3. Location of vaults, valves, hydrants, bends, blow offs and service curb boxes with 3 swing ties.
  4. Rim elevation on vaults (meter, air release etc.).
- H. The following information shall be indicated on the Record Drawings for storm drain construction:
1. Rim elevations on inlets, catch basins, manholes and other structures.
  2. Invert elevations of all pipes within inlets, catch basins, manholes, end sections, headwalls, culverts and other structures.
  3. Linear distance along drain from structure to structure, and branch connections, including size and type of pipe.
  4. Recalculated pipe slopes based on record elevations.
  5. Location of manholes, inlets, catch basins, outlets, headwalls, other structures and service line connections with 3 swing ties.
- I. At the end of each month and before payment for materials installed, the Contractor, and his Subcontractors, shall review Record Drawings for purpose of payment. If the changes in location of all installed elements are not shown on the Record Drawings and verified in the field, then the material shall not be considered as installed and payment will be withheld.
- J. At the completion of the contract, each Subcontractor shall submit to the Contractor a complete set of his respective Record Drawings indicating all changes. After checking the above drawings, the Contractor shall certify in writing on the title sheet of the drawings that they are complete and correct and shall submit the Record Drawings to the Engineer.

#### 1.04 EQUIPMENT AND SYSTEM CHECKOUT, CERTIFICATIONS AND TESTING

- A. Comply with requirements of Section 01680 Equipment and System Checkout, Certifications and Testing.

#### 1.05 OPERATING AND MAINTENANCE MANUALS

- A. Comply with requirements of Section 01730 Operation and Maintenance Manuals.

#### 1.06 SPARE PARTS

- A. Comply with requirements of Section 01750 Spare Parts.

#### 1.07 LUBRICANTS

- A. Comply with requirements of Section 01751 Lubricants.

#### 1.08 WARRANTIES

- A. Comply with requirements of Section 01740 Warranties.

1.09 FINAL INSPECTION

A. The Contractor shall submit written certification that:

1. Project has been inspected for compliance with Contract Documents.
2. Equipment and systems have been tested in the presence of the manufacturer's representative and are operational and satisfactory.
3. Project is completed, and ready for final inspection.

PART 2 PRODUCTS

NOT USED

PART 3 EXECUTION

NOT USED

END OF SECTION



## SECTION 01710

### STARTUP

#### PART 1 GENERAL

##### 1.01 SECTION INCLUDES

- A. Startup requirements for processes, equipment and components, and the roles and responsibilities of the Contractor and the Owner.

##### 1.02 DEFINITIONS

- A. Startup: The initial operation of a sufficiently completed facility and/or plant by the Owner, utilizing wastewater and related substances (sludge, wastewater, scum), or other media, which the facility has been designed to process.

##### 1.03 DESCRIPTION OF WORK

- A. The primary responsibility for startup rests with the Contractor with assistance from the Owner as specified herein.
- B. The Contractor shall not operate any of the existing facilities at any time. This shall include the starting and stopping of equipment or opening and closing of valves. Whenever the Contractor believe his work will effect or be effected by the existing facilities operation he shall so notify the Engineer in writing three (3) working days prior to the intended start of the work. This notification shall clearly detail the work to be completed, the method by which the existing facilities operation may be effected and the assistance requested of the Owner.
- C. At the discretion of the Engineer, individual startups may be required for various phases of the work. If this occurs, the phase startups will be ordered by the Engineer when the following has been completed for all equipment and systems within each Phase. The Engineer may order the startups prior to the completion of non-essential items of work.
  - 1. Compliance with Section 01665 Services of Manufacturer's Representatives, including:
    - a. Supervision of Installation
    - b. Equipment Checkout
    - c. Field Testing of Equipment
    - d. Pre-Startup Operator Training
  - 2. Compliance with requirements of Section 01680 Equipment and System Checkout, Certifications and Testing
  - 3. Compliance with requirements of Section 01730 Operation and Maintenance Manuals
  - 4. Compliance with requirements of Section 01750 Spare Parts
  - 5. Compliance with requirements of Section 01751 Lubricants
- D. The Contractor shall be responsible for maintaining all equipment until the dates of substantial completion.
- E. The Contractor shall assist the Owner during startup in any way deemed appropriate by the Engineer.

- F. There will be a date of substantial completion certified by the Engineer for each Phase of construction. These dates will not be certified until the following requirements have been satisfied by the Contractor:
1. All Contract requirements are coordinated into a fully operational system. All individual units of equipment and treatment processes are fully operative and performing at specified efficiencies. Where efficiencies are not specified, performance must meet acceptable standards for the particular unit.
  2. All field tests have been completed and satisfactory reports forwarded to the Engineer.
  3. All pre-startup training has been completed by the manufacturer's representatives.
  4. All spare parts and lubricants have been satisfactorily delivered to the Owner.

#### 1.04 ROLES AND RESPONSIBILITIES

##### A. Contractor's Responsibilities

###### 1. Startup

- a. Develop specific startup plans and schedule.
- b. Provide specific startup material and operating supplies until substantial completion or until acceptance of a specific system. Supplies include lubricants, chemicals, gases, specialized fluids, electric power, water (City and non-potable process water) and all other required appurtenances.
- c. Provide the necessary craft or labor assistance, in the event of an emergency equipment failure requiring immediate attention, (emergency is defined as a failure of function which precludes the further operation of a critical segment of; or the whole of the work) with a response time of not less than four hours from the time of notification. The time of notification is defined as the time of contact between the Engineer's representative and the Contractor's representative.
- d. Clarify submittals, testing requirements, schedules, or other items related to the startup of the equipment and facilities specified and indicated in the Contract Documents.
- e. Correct all failures or equipment problems identified during startup when notified by the Engineer.
- f. Attend meetings related to the review of startup plan(s).

###### 2. Performance Testing (where specified in individual technical specifications Sections 11 through 16).

- a. Review procedures for performance testing.
- b. Provide manufacturer's representative to provide guidance during performance testing.
- c. Provide manufacturer's representatives and operating supplies for retesting of systems that fail to pass the initial performance tests due to deficiencies in products or workmanship at no additional cost to the Owner.
- d. Resolve and correct all equipment or system failures during the performance testing.

###### 3. Provide to the Engineer a list of 24 hour, "on call" representative supervisory persons who will monitor the startup and performance testing.

##### B. Owner's Responsibilities

1. Assist in the startup testing activities. The Owner will endeavor to be cooperative with the Contractor when required. However, it is emphasized that the existing facilities operations and treatment take precedence and only requests that do not adversely affect the flow or treatment will be considered. Additionally, any assistance given to the Contractor must be completed when the Owner's schedule and manpower permit. There

may be instances when the Owner cannot provide assistance at the time of the Contractor's request and this shall not be the basis for a claim by the Contractor.

2. Provide staff to operate and maintain equipment, systems, and facilities requiring startup.

1.05 SUBMITTALS

A. Specific Startup Plans and schedule for all phases of startup.

B. List of 24-hour "on call" representative supervisory persons.

PART 2 PRODUCTS

NOT USED

PART 3 EXECUTION

NOT USED

END OF SECTION

## SECTION 01730

### OPERATION AND MAINTENANCE MANUALS

#### PART 1 GENERAL

##### 1.01 SECTION INCLUDES

- A. Requirements for compiling and submitting operation and maintenance manuals.

##### 1.02 OPERATION AND MAINTENANCE MANUALS

###### A. General

1. Include all elements and components of the system including instrumentation. Provide a description of how the equipment or complete system works. Additionally, where a number of components are furnished to provide a complete system, describe the operation of components as they relate to the complete system.
2. Include all necessary instruction for the maintenance and operation of the equipment or system in accordance with the manufacturer's recommendations, and as herein specified.
3. Customize the manual so that only data pertaining to the specific equipment or system to be furnished is included. If a standard type manual is utilized, it shall be neatly annotated to highlight the data pertaining to, and deleting the data not pertaining to, the specific equipment or equipment being furnished.
4. Bind each manual for each type of equipment or system separately as specified below

###### B. Content of Manuals

1. Table of Contents and index. Provide title of Contract and schedule of products and systems, indexed to content of the volume.
2. Brief description of each system and components. Identify function, normal operating characteristics and limiting conditions. Include performance curves, with engineering data and tests. Include equipment Nameplate Data (Serial No., Model No., rating, voltage, etc.).
3. Names, addresses, and telephone numbers of subcontractors and suppliers, including local source of supplies and replacement parts.
4. One copy of each approved shop drawing and each Contractor's coordination and layout drawing
5. Record drawings of wiring diagrams and control schematics including external connection diagrams.
6. Test and balancing reports, calibration data, alignment records, and other information.
7. Copy of any applicable warranties, guarantees and bonds
8. Operating Procedures:
  - a. Include start-up, break-in, and routine normal operating instructions and sequence. Include regulation, control, stopping, shut-down, and emergency instructions. Include summer, winter, and any special operating instructions.
  - b. Manufacturer's printed operating instructions.
9. Maintenance Procedures:
  - a. Complete maintenance instructions (include routine, preventive and corrective maintenance).
  - b. Manufacturer's printed maintenance instructions, parts list, illustrations, and diagrams.

- c. Include maintenance schedule and types of lubricants. Cross-reference lubricants to products offered by at least three major lubricant suppliers.
10. Spare Parts:
- a. List of recommended spare parts, manufacturer's current price, and recommended quantity
  - b. Parts lists to include the specific part or identification number used by the manufacturer of the parts. Arbitrary sequential numbers or letters keyed to a sectional diagram are not satisfactory.
11. Additional Requirements: As specified in individual product specification sections.
- C. Format
- 1. Binder
    - a. Binders: Commercial quality, 8-1/2 x 11 inch three-ring binders with hardback, cleanable, plastic covers; two inch maximum ring size. When multiple binders are used, correlate data into related, consistent groupings. Provide a table of contents in each binder.
    - b. All binders to be of similar design and color, but sized to suit the individual manuals with a minimum allowable edge of width of 1 inch.
    - c. Identify each manual with a permanent label affixed to the outside binding of the binder and include the following information:
      - 1) Name of Contract, Contract Number
      - 2) Location of equipment or system (i.e. Primary Settling Tanks)
      - 3) Common name of equipment or system (i.e. Chain and Flight Sludge Collectors)
    - d. Provide tabbed fly leaf for each separate product and system, with typed description of product and major component parts of equipment.
  - 2. Material for Content
    - a. Loose leaf on 60 pound, punched paper
    - b. Holes reinforced with plastic cloth or metal
    - c. Page size, 8 1/2 by 11 inches
    - d. Diagrams, illustrations, and attached foldouts as required, of original quality, reproduced by dry copy method
    - e. Drawings: Provide with reinforced punched, binder tab. Bind in with text; fold larger drawings to size of text pages

### 1.03 SUBMITTALS

- A. Sample of typical binder, cover and tabbed fly leaf.
- B. Provide three (3) copies of O&M manuals for approval no later than the time that the equipment is delivered to the site. If the manual is satisfactory, the Engineer will retain all three (3) copies. If the manual is not satisfactory, the Engineer will retain one (1) copy and return two (2) copies to the Contractor. When manuals are resubmitted, three (3) copies will again be required. When the manual is satisfactory, except for some missing information, the Engineer may, at his option, retain all three (3) copies of the manual and request three (3) copies of the additional information to be provided.
- C. All manuals pertaining to equipment or a system within each specific components of construction must be completely approved prior to the Field Acceptance Tests of that component.

PART 2 PRODUCTS

NOT USED

PART 3 EXECUTION

NOT USED

END OF SECTION

## SECTION 01740

### WARRANTIES

#### PART 1 GENERAL

##### 1.01 SECTION INCLUDES

- A. General administrative and procedural requirements for warranties required by the Contract Documents, including manufacturers standard warranties on products and special warranties.

##### 1.02 SUBMITTAL

- A. Submit written warranties to the Owner prior to the date fixed by the Engineer for Substantial Completion. If the Certificate of Substantial Completion designates a commencement date for warranties other than a date of Substantial Completion for the Work, or a designed portion of the Work, submit written warranties upon request of the Owner.
- B. When a designated portion of the Work is completed and occupied or used by the Owner, by separate agreement with the Contractor during the construction period, submit properly executed warranties to the Owner prior to acceptance of this portion of the Work.
- C. Refer to individual Sections of Division 2 through 16 for specific content requirements, and particular requirements for submittal of special warranties.

##### 1.03 WARRANTY REQUIREMENT

- A. Related Damages and Losses: When correcting warranted Work that has failed, remove and replace other Work that has been damaged as a result of such failure or that must be removed and replaced to provide access for correction of warranted Work.
- B. Reinstatement of Warranty: When Work covered by a warranty has failed and been corrected by replacement or rebuilding, reinstate the warranty by written endorsement. The reinstated warranty shall be equal to the original warranty with an equitable adjustment for depreciation.
- C. Replacement Cost: Upon determination that Work covered by a warranty has failed, replace or rebuild the Work to an acceptable condition complying with requirements of Contract Documents. The Contractor is responsible for the cost of replacing or rebuilding defective Work regardless of whether the Owner has benefited from use of the Work through a portion of its anticipated useful service life.
- D. Owner's Recourse: Written warranties made to the Owner are in addition to implied warranties, and shall not limit the duties, obligations, rights and remedies otherwise available under the law, nor shall warranty periods be interpreted as limitations on time in which the Owner can enforce such other duties, obligations, rights, or remedies.
- E. Rejection of Warranties: The Owner reserves the right to reject warranties and to limit selections to products with warranties not in conflict with requirements of the contract Documents.

- F. Disclaimers and Limitations: Manufacturer's disclaimers and limitations on product warranties do not relieve the Contractor of the warranty on the Work that incorporates the products, nor does it relieve suppliers, manufacturers, and subcontractors required to countersign special warranties with the Contractor.

#### 1.04 DEFINITIONS

- A. Standard Product Warranties are preprinted written warranties published by individual manufacturers for particular products and are specifically endorsed by the manufacturer to the Owner.
- B. Special Warranties are written warranties required by or incorporated in the Contract Documents, either to extend time limits provided by standard warranties or to provide greater rights for the Owner.

#### PART 2 PRODUCTS

NOT USED

#### PART 3 EXECUTION

NOT USED

END OF SECTION



## SECTION 01750

### SPARE PARTS

#### PART 1 GENERAL

##### 1.01 DESCRIPTION

- A. Spare parts which are identical and interchangeable with original parts shall be provided with equipment as specified in each Section of the Specifications. Spare parts shall be individually packaged in boxes bearing the equipment reference, tag number, and part identification (Example: Primary Scum Pump No. 1).
- B. Subsequent to the approval of the appropriate operation and maintenance manuals but prior to the delivery of the spare parts, the Contractor shall prepare and submit an itemized tabulation of all spare parts to be provided. The tabulation shall include the name of the equipment for which the spare part is intended, type of spare part, manufacturer of spare part, manufacturer model or manufacturer identification number of spare part, quantity of spare part, and page in the appropriate operation and maintenance manual detailing the parts list.
- C. Spare parts shall be stored by the Contractor in a location approved by the Engineer. Unless otherwise directed by the Engineer, the Contractor shall deliver the spare parts to the Owner at the time of "Substantial Completion." Spare parts shall be stored in accordance with the manufacturer's written recommendations, and shall be protected against theft, vandalism, weather, and all other adverse conditions. Spare parts delivered to the Owner shall be in new, undamaged condition. Upon delivery to the Owner, spare parts shall be logged in against the above noted tabulation and inspected by the Contractor in the presence of the Engineer. Any missing or damaged spare parts shall be replaced by the Contractor at no expense to the Owner.

##### 1.02 SPECIAL TOOLS

- A. Provide special tools required for operation, service, or maintenance of the products as specified or as needed, as determined by the manufacturer's representative.
- B. Pack items to protect them during storage. Tag items and containers to clearly identify them.

##### 1.03 CONTRACT SPECIFIC REQUIREMENTS

- A. Specific requirements for spare parts for this contract are included in the technical specifications.

#### PART 2 PRODUCTS

NOT USED

#### PART 3 EXECUTION

NOT USED

END OF SECTION

## SECTION 01751

### LUBRICANTS

#### PART 1 GENERAL

##### 1.01 REQUIREMENTS

- A. The Contractor shall furnish and deliver to the Owner such oil, grease and any special lubricants that are necessary for proper operation of all equipment furnished under this contract. The quantity furnished shall be sufficient for one year's operation after the date of substantial completion. The grade of lubricants furnished shall be in accordance with the recommendations of the equipment manufacturers.
- B. Subsequent to the approval of the appropriate operation and maintenance manuals but prior to the delivery of the lubricants, the contractor shall prepare and submit an itemized tabulation of all lubricants to be provided. The tabulation shall include the name of the equipment for which the lubricant is intended, its tag number, type of lubricant, manufacturer of lubricant, frequency of lubrication, quantity of lubricant required for one year, and page in the appropriate operation and maintenance manual referencing the lubricant.
- C. All lubricants shall be delivered to the Owner prior to the start-up of the equipment. They shall be delivered in the manufacturer's unopened containers and shall be labeled with the equipment name for which it is to be used. At the time of delivery they shall be logged in against the above noted tabulation and inspected by the Contractor in the presence of the Engineer.
- D. The Contractor shall also furnish and deliver to the Engineer such grease guns and auxiliary lubricating devices as are required to conveniently maintain all equipment furnished. As a minimum, one grease gun and accessories will be furnished for each individual item of equipment requiring lubrication.
- E. Prior to substantial completion, the Contractor shall submit an "Equivalent Lubrication Table" which shall list equivalent products from at least four major oil companies for all lubricants that will be required for all the equipment provided under this Contract.

#### PART 2 PRODUCTS

NOT USED

#### PART 3 EXECUTION

NOT USED

END OF SECTION

## SECTION 01800

### MAINTENANCE

#### PART 1 GENERAL

##### 1.01 SECTION INCLUDES

- A. Procedures for maintaining work completed under this Contract.

##### 1.02 MAINTENANCE PERIOD

- A. The general maintenance period for all construction or materials under this Contract shall be one (1) year subsequent to the date of the acceptance of the work by the Owner, or as provided by other sections of this Specification.
- B. If the Owner puts any structure or equipment to use prior to acceptance of all work under the Contract, the maintenance period for such structures or equipment shall be calculated from the time use begins.
- C. Contractor agrees to replace the material which does not conform to the Contract requirements, and to repair any damage of material or work without cost to the Owner, to satisfaction of Engineer, in conformance with Contract Documents provided orders for replacement and/or repairs are received in writing by the Contractor within the one year period.
- D. This Section shall in no way limit the duration of the Contractor's responsibility for the correction of any defect due to workmanship or materials provided by the Contractor which are not in compliance with the Contract Documents.

##### 1.03 ABUSE OF WORK

- A. Contractor is not obligated to perform work of replacement or repair that he may prove is required because of abuse by parties other than the Contractor, after the date the Owner puts to continuous use the work requiring replacements or repair, or after date the Owner has approved the Certificate of Completion.

##### 1.04 EMERGENCY REPAIRS

- A. If the Owner deems necessary, the Owner shall order replacement or repairs be undertaken within 24 hours.
- B. If the Contractor delays or fails to make the ordered replacement or repairs within the time specified, the Owner shall have the right to make such replacements or repairs and the expense shall be deducted from moneys due the Contractor, or moneys of the Contractor retained by the Owner.

#### PART 2 PRODUCTS

NOT USED

PART 3 EXECUTION

NOT USED

END OF SECTION

## SECTION 01810

### MAINTENANCE OF PLANT OPERATION AND SEQUENCE OF CONSTRUCTION

#### PART 1 GENERAL

##### 1.01 GENERAL PROVISIONS

- A. The existing wastewater treatment facility will be maintained in continuous operation by the WWTF Operator (Veolia North America) at all times during the entire construction period. The Contractor shall schedule his operations to conform with the requirements specified herein, and shall include in his construction progress schedule all events which will impact operation of the existing treatment facilities.
- B. The Contractor shall at all times conduct his operations so as to interfere as little as possible with existing works. The Contractor shall develop a program, in cooperation with the Engineer, Operator and Owner, that will provide for the construction and commissioning of the new works in the most orderly manner possible. This program shall be adhered to except as deviations therefrom are expressly permitted. All work of connecting with, cutting into, and reconstructing existing pipes or structures shall be planned to interfere with the operation of the existing facilities for the shortest possible time and when the demands on the facilities best permit such interference, even though it may be necessary to work outside of normal working hours to meet these requirements. Before starting work that interferes with the operation of existing facilities, the Contractor shall perform all preparatory work and shall see that all labor, tools, materials, and equipment are made ready and at hand.
- C. The Contractor shall make minor modifications in the work relating to existing structures as may be necessary to satisfactorily complete the work, without additional compensation.
- D. The Contractor shall plan and conduct his work so that such work does not adversely impact the intended plant operation. The Contractor's operations shall in no way cause a reduction in the effluent quality or create any nuisance not normally attributable to such operation, unless approved by the Owner, Operator, Engineer and State regulatory agencies. It shall be the Contractor's responsibility to ensure complete compatibility with the plant operations in his working schedules.
- E. All costs associated with maintaining existing flows and plant operations, including providing, maintaining, operating, and removal of all equipment and required appurtenances, shall be considered part of the bid price for the work being constructed. It being understood and agreed to by the Contractor that the price, as indicated in the bid, shall constitute full and complete compensation for providing all provisions necessary and/or required for maintaining flow during construction.

- F. The Taunton WWTF is designed to treat an average daily flow of **8.4 MGD** and a maximum daily design flow of **17.4 MGD**. The plant may occasionally experience instantaneous peak flows of up to **22.4 MGD** during wet weather conditions. Unless specifically noted below, the construction activities under this Contract shall not, under any circumstances, reduce the treatment capability of the plant. The treatment capability of the plant refers to all portions of the wastewater treatment process including grit and screenings removal, primary treatment, biological treatment, disinfection, RAS and WAS sludge pumping, solids handling and removal, and on site utilities including but not limited to city water, plant effluent water, electrical power, and instrumentation wiring and chemical lines.
- G. The Taunton WWTF currently utilizes two treatment batteries that function separately to achieve secondary treatment. The treatment batteries are defined as:
1. Battery 1 – Existing Aeration Tank Nos. 1, 2 & 3, Final Clarifier Nos. 1 and 2, and Secondary Sludge Pump Station No. 1.
  2. Battery 2 – Existing Aeration Tank Nos. 4, 5 & 6, Final Clarifier Nos. 3 and 4, and Secondary Sludge Pump Station No. 2
- H. Any approved construction activity that will impact the performance of the treatment plant shall be done, unless otherwise approved by the Engineer, during low influent flow periods and/or outside of the timeframe where the seasonal effluent permit limits for ammonia are in effect as defined below.
1. Low influent flow periods are defined as early weekday and weekend mornings (between MIDNIGHT and 7 A.M.), during dry weather periods only. Shutdowns during low influent flow periods are considered “short term” in duration.
  2. The seasonal effluent permit limit for ammonia is in effect from June 1<sup>st</sup> through September 30<sup>th</sup>. The Contractor shall assume:
    - a. Biological Treatment Battery 1 cannot be taken offline from June 1<sup>st</sup> through September 30<sup>th</sup>.
    - b. Biological Treatment Battery 2 can adequately meet the discharge permit limits for influent flows up to **12.5 MGD**.
    - c. Any required diversion/isolation, whether pumping is required or not, of forward flow is the responsibility of the Contractor.
    - d. Shutdowns outside of the seasonal effluent permit timeframe are considered “long term” in duration. Influent flows during wet weather or otherwise that exceed the capacity of Battery 2 must be temporarily stored and reintroduced into the WWTF when influent flows subside.

## 1.02 RELATED WORK

- A. Section 00700 - General Conditions
- B. Section 01010 - Summary of Work

- C. Section 01300 - Submittals
- D. Section 01310 - Construction Progress Schedule
- E. Section 02050 - Demolition
- F. Section 02149 - Maintaining Existing Flow

### 1.03 SUBMITTALS

- A. Submit, in accordance with the provisions of Section 01300, complete descriptions of procedures to maintain plant operation to supplement the construction progress schedule developed in accordance with Section 01310. The description shall include step-by-step procedures, required duration, and specific procedures required to be performed by the Operator's personnel.

### 1.04 SCOPE OF WORK

- A. The general items of work in this construction contract include, but are not necessarily limited to the following:
  1. New Biological Treatment Tank Reactor, including new Blower System
  2. New Secondary Anoxic Reactor
  3. New Biological Effluent Flow Distribution Structure
  4. Existing Aeration Tanks 1, 2 & 3 modifications
  5. Final Clarifier Tanks 1, 2, 3 & 4 modifications
  6. Secondary Sludge Pump Stations 1 & 2 modifications
  7. New Carbon Feed System
  8. Operating and monitoring instrumentation and control system modifications
  9. Yard piping
  10. Electrical site work and power distribution

### 1.05 CONTRACTOR'S AND OWNER'S RESPONSIBILITIES AND LIMITATIONS

- A. The Contractor's construction activities shall not disrupt any treatment operations, no matter how minor, without the approval of the WWTF Operator and Owner.
- B. The Contractor shall not operate or utilize any existing plant facilities. This includes the starting and stopping of equipment, the opening and closing of valves or the use of existing piping. Whenever the construction work requires action by the WWTF Operator, the Contractor shall so notify the Engineer as described below.

- C. The Contractor shall notify the WWTF Operator and Owner in writing of any construction activity that will affect the treatment operations or require assistance from the WWTF Operator in operating existing facilities. This notification shall be received at least one week prior to the planned construction work. The request shall clearly detail the Contractor's planned work, how his work will affect the operation of the existing facilities, the estimated duration of the work, and any assistance required of the WWTF Operator. The Contractor's request shall also explain why other construction methods, which may have less of an impact on treatment operations, are not feasible.
- D. It is emphasized that the operations of the existing facilities take precedence over all construction activities. Denials of requests from the Contractor for the Operator's assistance in modifying his plant operations shall not be a basis for any claim by the Contractor. Any approved assistance given to the Contractor from the Operators will be provided when the Operator's schedule and manpower permit. The Contractor shall also provide and maintain access for the Owner's personnel to all existing facilities at all times throughout the construction period.

#### 1.06 SEQUENCE OF CONSTRUCTION

- A. Construction shall be based upon the schedule submitted by the Contractor and fully coordinated and approved by the WWTF Operator and their personnel, as specified above. However, as a guide for bidders in the preparation of their bid and for the Contractor in the preparation of his schedule, scheduling requirements are described below for specific portions of the work.
- B. The order of construction shall be subject to the approval of the WWTF Operator and Owner; such approval or direction, however, shall in no way relieve the Contractor's responsibility to perform the work in strict accordance with the Contract Documents. The construction plans and specifications have been developed to minimize the construction impacts on the operation of the Wastewater Treatment Facility. The Contractor shall note the requirements of Section 01010 with regard to the operation of the plant and the phasing of construction when developing his work sequence. The Contractor's work sequence must be specifically detailed in the CPM which is required under Section 01310.
- C. Whenever the Contractor's proposed work will require the Operator to deviate from the normal operation of the plant, the Contractor shall fully coordinate the construction activity with facility personnel and the coordination shall be documented and incorporated into the project files. Such notification shall be submitted two weeks prior to the planned construction activity and shall include all information as described in Section 01010.
- D. Contractor should note that other construction activities being performed under separate contracts will be underway at the time this contract is awarded. Contractor shall coordinate activities, as required, to minimize conflicts with other construction activities being performed on the property.



E. A large portion of the work under this Contract will be constructed in phases. Prior to proceeding to a second related phase of work, the first phase of work must be completed in its entirety, including all related appurtenant work. All items within that system must be operational including instrumentation and controls, including alarms. This may require temporary facilities at the cost to the Contractor and in coordination with his approved sequence of construction. In addition, compliance with the requirements of the following specifications must be achieved for a phase to be considered completed:

- Section 01665 – Services of Manufacturer’s Representative
- Section 01680 - Checkout, Certification and Testing
- Section 01710 - Startup
- Section 01730 - Operation and Maintenance Manuals
- Section 01735 - Services of Manufacturers Representatives
- Section 01736 - Spare Parts
- Section 01737 - Lubricants

F. The Contractor shall note the following scheduling requirements to maintain plant operations. These requirements should be incorporated into the planned work sequence. Also presented below are suggested sequences of construction for various work items. Note that these are only general suggested sequences of construction. The Contractor may wish, or may find it necessary, to alter the sequence of construction. All necessary details and items of work are not purported to be included.

G. Scheduling Requirements to Maintain Plant Operations

1. Overview

a. Scheduling Requirements

- Short term shutdowns shall be completed during low flow periods.
- Long term shutdowns shall be completed outside of the seasonal effluent permit timeframe for ammonia removal. The Contractor shall be responsible for managing wastewater flows in excess of the capacity of Train 2, defined above.
- Primary sludge line shutdowns shall be limited to 8 hours.
- Return activated sludge line shutdowns shall be limited to 30 minutes.
- Waste activated sludge line shutdowns shall be limited to 8 hours.

2. New Biological Treatment Reactor, New Secondary Anoxic Reactor and New Final Clarifier Flow Distribution Chamber

a. Scheduling Requirements

- Work must be completed in four phases.
- Phase A includes construction of:
  1. New Biological Treatment Reactor and New Secondary Anoxic Tank Reactor
  2. Portions of existing influent and effluent piping, and tank gates.

- The construction of Phase A is intended to occur without disruption of the existing treatment processes of Batteries 1 & 2 and provide a means of offline storage for use in later phases. Temporary diversion of forward flow to the New Biological Treatment Reactor, if required, will be the responsibility of the Contractor. The intent of Phase A is to construct the New Biological Treatment Reactor, including necessary structural and process mechanical equipment, to allow diversion and temporary storage of primary effluent in the New Biological Treatment Reactor tank during construction of Phase B.
- Phase B must be constructed outside of the seasonal effluent permit timeframe for ammonia, as defined above. It includes the construction of the New Final Clarifier Flow Distribution Chamber and all necessary primary and biological treatment effluent piping and valves. During Phase B, forward flow will be directed to Battery 2. The New Biological Treatment Reactor can be utilized for offline storage during wastewater influent flows in excess of **17.4 MGD**. Phase B also includes the installation of WAS and RAS connections for use during bypass of the Secondary Sludge Pump Stations. The intent of Phase B is to provide the ability to direct forward flow to the New Biological Treatment Reactor for startup, testing and acceptance.
- Phase C includes installation, startup and acceptance of the Blowers and New Biological Treatment Reactor. The intent of Phase C is to commission and place online the New Biological Treatment Reactor, with influent, effluent, WAS and RAS capabilities. The existing process mechanical equipment associated with Battery 1 must remain online and operational. Primary Effluent and RAS must be capable of being directed to either the existing Battery 1 or the New Biological Treatment Reactor.
- Phase D includes the remaining improvements and modifications to the Battery 1. The New Biological Treatment Reactor will treat the full flow from the Primary Clarifiers.

b. Suggested Sequence of Construction

Phase A

- Construct the New Biological Treatment Reactor and New Secondary Anoxic Tank. Underground piping that does not interfere with the existing Battery 1 forward flow can also be installed and made ready for Phase B.
- Construct portions of modifications to the existing Aeration Tanks 1, 2 & 3 influent piping to facilitate the ability to direct Primary Effluent to either the New Biological Treatment Reactor or Aeration Tanks 1, 2, & 3. It is assumed this work will require short term shutdowns of Battery 1.

Phase B

- Prior to Phase B, the ability to direct flow (pumped or gravity) to the New Biological Treatment Reactor must put in place for temporary storage by the Contractor.
- WWTF Operations will place Train 1 offline based on the Contractors approved schedule.
- Construct the New Final Clarifier Flow Distribution Chamber.
- Construct underground effluent piping for the New Biological Treatment Reactor, New Secondary Anoxic Reactor, and Existing Aeration Tank Nos. 1, 2 & 3.
- Connect New Final Clarifier Flow Distribution Chamber effluent piping to Battery 1 Final Clarifiers.
- Construct WAS & RAS connections for startup and testing of the New Biological Treatment Reactor. Refer to Secondary Sludge Pump Station Suggested Sequence of Construction.

#### Phase C

- The WWTF Operator will place Train 1 online in accordance with the Contractors approved schedule. Effluent from Existing Aeration Tank Nos. 1, 2 & 3 will be directed through the new Final Clarifier Flow Distribution Chamber.
- Complete installation of remaining process mechanical equipment within the New Biological Treatment Reactor. Install new blowers, pumps, piping valves, instrumentation and control.
- Startup, Test and Commission the New Biological Treatment Reactor. Note, during startup and testing, forward flow, RAS and WAS must be able to be directed to both Train 1, Train 2 or the New Biological Treatment Reactor.
- The intent of Phase C is to place the New Biological Treatment Reactor online and operational, including discharge through the New Final Clarifier Flow Distribution Chamber to the Battery 1 Final Clarifiers.

#### Phase D

- Complete Improvements to Battery 1 with the New Biological Treatment Reactor treating the Batter 1 flow.

### 3. Final Clarifier Nos. 1, 2, 3 & 4

#### a. Scheduling Requirements

- Three out of four Final Clarifiers must be online and operational at a time, with the exception of during Phase B of construction of the New Biological Tank Reactor, New Secondary Anoxic Reactor and New Final Clarifier Flow Distribution Chamber, described above. Final Clarifiers 1 & 2 can both be taken down at this time and the noted improvements constructed.

#### b. Suggested Sequence of Construction

- None
4. Secondary Sludge Pump Station Nos. 1 & 2
- a. Scheduling Requirements
- The Contractor shall provide means of temporarily pumping RAS and WAS from the existing RAS and Scum pits to the existing WAS and RAS lines.
  - Separate short-term shutdowns will be required for each Secondary Sludge Pump Station to install internal connections from the Final Clarifiers to the WAS and RAS pits.
  - Coordinate schedule with completion schedule for biological treatment tanks and associated yard piping.
- b. Suggested Sequence of Construction
- None

END OF SECTION

## **DIVISION 02**

## SECTION 02050

### DEMOLITION

#### PART 1 GENERAL

##### 1.01 SECTION INCLUDES

- A. Requirements for demolition of existing facilities and removal of equipment and materials for reuse or salvage.
- B. Buildings or areas scheduled for partial or selective demolition are shown on the Contract Drawings, as follows:

<u>Area</u>	<u>Description of Demolition</u>
3. Biological Treatment Tanks	As shown on Sheet M-3.1, E-3.1, E-3.2
4. Final Clarifiers/Secondary Sludge Pump Station	As shown on Sheets S-4.1, M-4.1, M-4.3, M-4.4, M-4.7, M-4.9, M-4.10, , H-4.1, H-4.3, P-4.1, P-4.3, E-0.3, E-4.1, E-4.5
9. Non-Process Buildings	M-9.1, H-9.2, P-9.1, E-0.4, E-9.3

##### 1.02 SUBMITTALS

- A. Shop Drawings
  - 1. In accordance with Specification SECTION 01300 1.03 Shop Drawings.
  - 2. Schedule of demolition included in and consistent with requirements of Specification SECTION 01300 1.02 Progress Schedules and SECTION 01310 Construction Progress Schedule.
- B. Quality Assurance/Control Submittals
  - 1. Methods of demolition and equipment proposed for use in demolition
  - 2. Copies of Permits required for demolition.

#### PART 2 PRODUCTS

NOT USED

## PART 3 EXECUTION

### 3.01 PREPARATION

#### A. Equipment Salvage and Reuse

1. Do not remove equipment or materials without approval of Engineer.
2. Properly store and maintain equipment and materials to be reused in the Work.

### 3.02 SEQUENCE

- #### A. See SECTION 01810 Maintenance of Plant Operation and Sequence of Construction.

### 3.03 SAFETY

- #### A. Protect persons and property throughout progress of work.
- #### B. Have acceptable fire extinguishers available at all times where demolition by burning torches is being conducted.
- #### C. Burning of demolition debris not permitted on or near site.
- #### D. Explosives not to be used or brought to site without prior written permission by Engineer.
- #### E. Maintain circulation of traffic within area of demolition operations.
- #### F. Provide and maintain lights, barriers and temporary passageways for safe access within area of demolition operation.
- #### G. Take precautions to minimize spread of dust and flying particles. Keep work area wet down to prevent dust from rising.
- #### H. Provide maximum practical protection from inclement weather to materials, equipment and personnel in partially dismantled structures.

### 3.04 DEMOLITION

- #### A. Dismantle and remove appurtenances indicated without damaging existing structures, equipment and appurtenances to remain.
- #### B. Confine demolition work, new construction and operations to areas that will not interfere with continued use and operation of entire plant.
- #### C. On exposed surfaces, where there will be in the finish work a joint between old and new concrete, the existing concrete at the face shall be removed to a straight rather than a rough line.

### 3.05 REPAIR/RESTORATION

- A. Repair or remove and replace items not scheduled for demolition damaged by Contractors operations to original condition as directed by Engineer.
- B. The Contractor shall exercise extreme caution when removing sections of concrete from slabs or walls that are to be utilized as part of the new construction. Demolition shall be to the exact limits indicated on the Drawings. Over-excavated concrete shall be replaced at the Contractor's expense and to the satisfaction of the Engineer. Any damage to the remaining structure caused by the Contractor's operations shall be satisfactorily repaired at the Contractor's expense.

### 3.06 DISPOSAL

- A. Debris from structures, including concrete, masonry, steel or other rubble shall become the property of the Contractor, unless otherwise directed by the Engineer, and shall be promptly removed from site at the Contractor's expense.

### 3.07 CLEANING

- A. Leave affected areas of demolition in a clean, safe and orderly condition, ready to accept new work if proposed.

END OF SECTION



SECTION 02075

MANAGEMENT OF UNDERGROUND STORAGE TANKS (USTs)

PART 1 GENERAL

1.01 WORK INCLUDED

- A. The project includes the removal of three (3) underground steel, fuel oil storage tanks including all piping and vent lines associated with the tanks, as shown on the Contract Drawings. The tanks are defined as follows:

<u>Designation</u>	<u>Location</u>	<u>Storage Capacity (gal.)</u>	<u>Stored Material</u>	<u>Status</u>
T-1	Administration	10,000	no. 2 fuel oil	Active
T-2	Solids Handling	20,000	no. 2 fuel oil	Active
T-4	Pump Station #1	10,000	no. 2 fuel oil	Abandoned

Note that the tank designations provided above correspond to those used when the tanks were originally installed.

Tank T-2, which was installed circa 1975, is contained within a reinforced concrete enclosure (four sides and bottom) that is approximately 37'-8" long, 21' wide and 10'-6" high. The space around the tank, within the enclosure, is filled with sand. The enclosure does not have an attached cover; however, there is a concrete pad above the tank that will need to be removed and disposed. The top of the tank is located approximately three feet below ground surface. The tank is anchored to the bottom slab with 1-inch threaded rods bolted to the side of the tank at a minimum of 8 locations. A sketch providing detail for the tank installation is attached to this Section.

Tanks T-1 and T-4 are replacement tanks for those that were installed in 1975. The actual date of their installation and the methods used to install them are unknown. It should be assumed that they are anchored to a concrete slab.

1.02 HEALTH AND SAFETY PLAN

- A. CONTRACTOR and any SUBCONTACTORS involved with the removal of the USTs shall maintain a health and safety plan (HASP) in compliance with the Occupational Safety and Health Administration (OSHA) Standards defined in 29 CFR 1910.120.
- B. CONTRACTOR's employees or Subcontractor's employees which will be cleaning the USTs and/or handling petroleum or petroleum-impacted soil or groundwater shall be required to have OSHA 40-hour health and safety training and the 8-hour refresher training if applicable. The CONTRACTOR shall provide certificates to the ENGINEER for the employees that will be performing the work.
- C. The level of dermal and respiratory protection shall be determined based upon continuous air monitoring to be performed by CONTRACTOR and the requirements of their Site-specific HASP. The ENGINEER may conduct duplicate air monitoring for quality control purposes. Level D protection shall be the minimum personal protective level for all on-site personnel.

### 1.03 HAZARDOUS WASTE LICENSES

- A. CONTRACTOR or Subcontractor, whichever shall be transporting the waste material from the tank cleaning, shall have a currently valid hazardous waste transporter license for the Commonwealth of Massachusetts and any other state for which the transporter shall pass through on its way to a licensed receiving facility. The CONTRACTOR shall provide copies of the license(s) to the ENGINEER prior to commencement of the work.
- B. CONTRACTOR shall provide the ENGINEER with the name and address of all licensed receiving facilities to be used for this project, a minimum of one week prior to the commencement of on-site activities. CONTRACTOR shall provide copies of the receiving facility's license(s) and license conditions.
- C. CONTRACTOR shall provide the ENGINEER with manifests, receipts or other documentation of disposal from the receiving facilities.

### 1.04 APPLICABLE LAWS AND REGULATIONS

- A. Tank closure shall be carried out in accordance with the requirements identified in 40 CFR Part 280, M.G.L c.148, Massachusetts Board of Fire Prevention Regulations 527 CMR 9.00, MADEP Policy #WSC-402-96, as well as any other applicable local and Commonwealth of Massachusetts regulations. Wherever there is a conflict or overlap of requirements, the most stringent provisions shall apply.
- B. Wastes generated under this Section must be handled, transported and disposed of in accordance with the Resource Conservation and Recovery Act (RCRA), 310 CMR 30.00, and 310 CMR 40.
- C. The CONTRACTOR shall obtain and pay for all local and state permits and make necessary arrangements with the local Fire Department prior to the removal of tanks.

### 1.05 RELATED WORK

- A. Section 01069 - Health and Safety Requirements
- B. Section 02080 – Management of Contaminated Soil
- C. Section 02200 - Earth Excavation, Backfill, Fill and Grading
- D. Section 02500 - Pavement
- E. Section 02930 - Loam and Seeding

## PART 2 PRODUCTS

NOT APPLICABLE

## PART 3 EXECUTION

### 3.01 UST REMOVAL REQUIREMENTS

- A. As noted in Paragraph 1.01 of this specification, Tanks T-1 and T-2 are in use. It is intended that the Owner/Operator will use as much fuel oil as possible prior to the removal of these tanks. However, depending on the quantity of fuel oil remaining prior

to tank removal, the Contractor shall be prepared to transfer usable product from the existing USTs to one of the new aboveground storage tanks (AST) to be provided under this contract. The AST replacing underground tank T-2 can be installed before T-2 is removed from service and should be used to accept transferred product to its maximum storage capacity.

For purposes of this bid, the Contractor shall assume that 200 gallons of fuel oil and residuals will be present in each UST, that will require proper handling and off-site disposal. This material shall be removed using a vacuum truck or a pneumatic pump and DOT approved 55-gallon drums in good leak free condition. Dissimilar materials (diesel fuel/waste oil) are to be kept separate for proper disposal.

- B. The tops of the USTs shall be uncovered along with any piping. For piping running under pavement, the pavement shall be saw cut as necessary to remove the pipe. Any pavement, concrete and other unsuitable backfill material shall be separated from the excavated soil.
- C. Cutting of steel or other metals by thermal methods shall occur in a non-explosive environment.
- D. The CONTRACTOR shall provide and maintain an adequate supply of fire extinguishers and safety equipment in close proximity to tank cleaning and removal activities.
- E. Tank cleaning
  - a. Power washer - The interior of the tank shall be washed with a power washer until all sludge and material have been loosened. All of the liquid, sludge, and materials are to be removed from the tank by the vacuum truck.
  - b. Manual cleaning - If a manway is located on the top of the UST and it is sufficient to allow for human entry, manual cleaning may take place. A written confined entry space procedure shall be followed during any manual cleaning of tank interiors. A copy of the confined space entry procedure shall be submitted to the ENGINEER at least one week prior to the tank removals. CONTRACTOR is responsible for enforcing the procedures for confined space entry.
- F. All liquid, sludge, and materials are to be removed from the tank and disposed in accordance with State and Federal Regulations.
- G. After the tank has been thoroughly cleaned, it is to be removed from the ground and set on the ground surface with the top openings down. The tank is to have blocks placed along its sides to prevent it from rolling.
- H. A representative from the Taunton Fire Department will inspect the tank prior to its being loaded on a truck for disposal. The tank cannot be transported off-site without approval of the fire department.
- I. The tank shall be loaded onto a truck and transported to an approved tank salvage yard. Fiberglass tanks may be crushed on-site. A receipt from the yard will be provided to the local fire department within 3 business days and a copy will be provided to the CITY and ENGINEER.
- J. CONTRACTOR shall also remove and dispose of all associated piping and material from the tank. All product piping associated with the boiler shall be drained and removed.
- K. The concrete enclosure(s) shall remain in place provided that they have not been

impacted by a release of fuel oil. The enclosures shall be backfilled with clean, compacted structural fill (12-inch lifts).

Following the removal of underground tanks (no enclosure) the tank graves shall be backfilled with clean compacted structural fill.

L. Surface Restoration:

- a. Tank T-2: Paved per requirements of specification Section 02500 - Paving
- b. Tanks T-1 and T-4: 4-inches of loam and seed in accordance with Specification Section 02930.

M. If suspect or contaminated soil (as defined in Specification Section 02080) is encountered, it shall be segregated at the direction of the ENGINEER and handled in accordance with the requirements of Specification Section 02080.

N. CONTRACTOR shall be responsible for providing barriers in accordance with State and local requirements, to surround open excavation pits, to prevent accidental entry and injuries.

O. CONTRACTOR shall arrange for and provide loading, transportation, and disposal/recycling of the contaminated soil at a licensed asphalt batching facility, a licensed lined landfill, or permitted incinerator. The ENGINEER will provide LSP services and Bills of Lading, if appropriate.

P. The Contractor shall obtain required permits from local and State agencies with jurisdiction over the work.

3.03 WORK INSPECTION AND TESTING

A. The ENGINEER will be the LSP and responsible for collecting confirmatory soil samples from the excavation for the UST Closure. Samples will be submitted for 48-hr turn-around from the laboratory. The CONTRACTOR shall assist the ENGINEER with sample collection.

*No claim will be entertained for reasonable delays associated with such environmental sampling, analytical services and decision making.*

B. The CONTRACTOR shall secure the open excavation while awaiting lab results and shall not backfill the excavation unless approved by the ENGINEER.

Before any portion of the work can be certified as complete, the ENGINEER must inspect it. The ENGINEER has final authority to determine if a portion of the work is complete or requires additional work to meet the requirements of this contract. The inspection will be visual and may include on-site soil tests. Laboratory testing of soils and groundwater may be conducted.

END OF SECTION

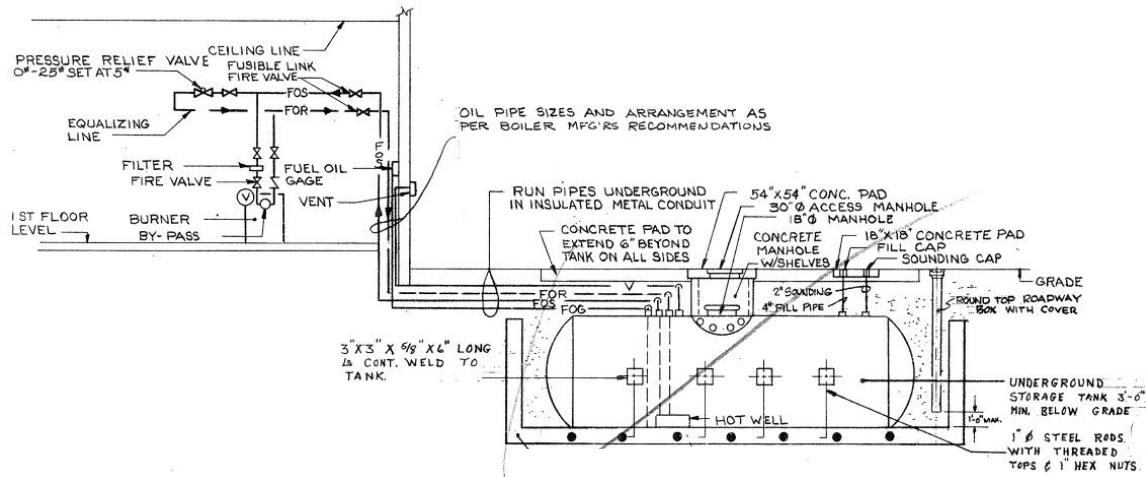

**TYPICAL UNDERGROUND OIL TANK & BURNER PIPING SCHEMATIC**

(Tank T-2)

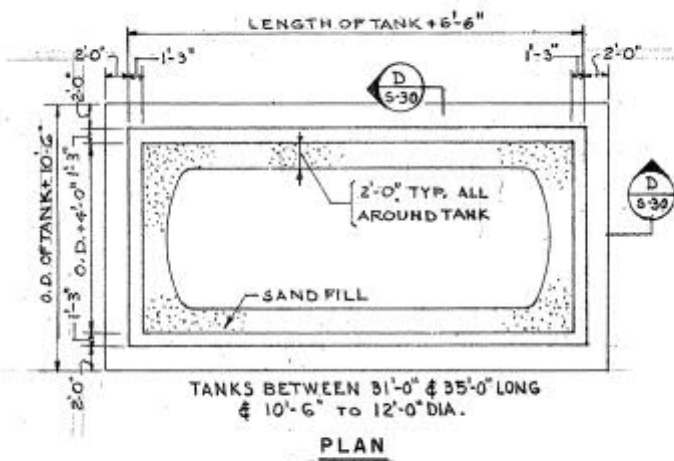

**PLAN**

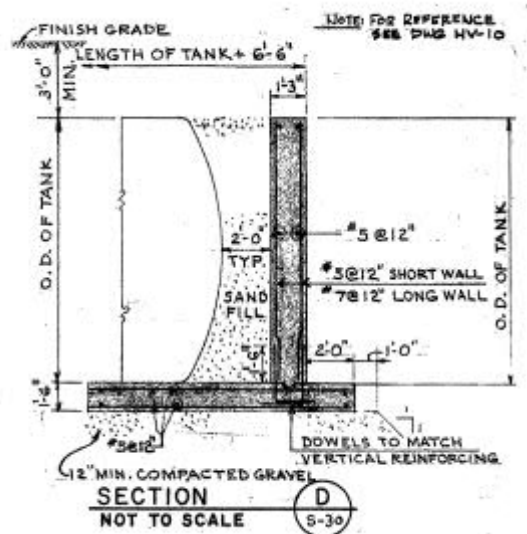

**SECTION**  
NOT TO SCALE

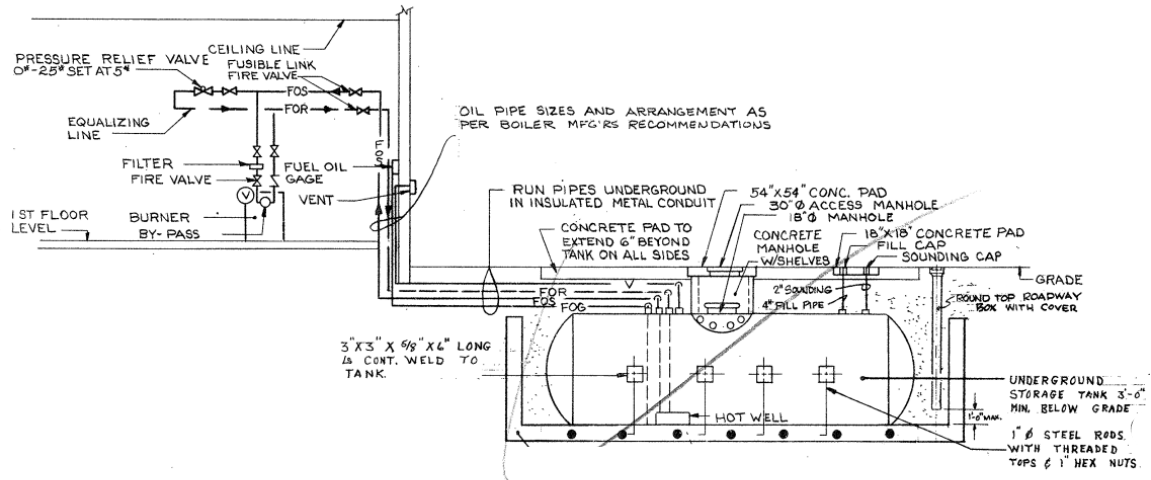

**TYPICAL UNDERGROUND OIL TANK & BURNER PIPING SCHEMATIC**

(Tank T-2)

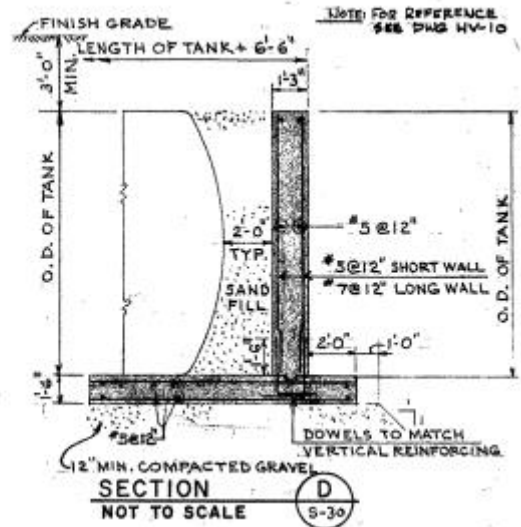
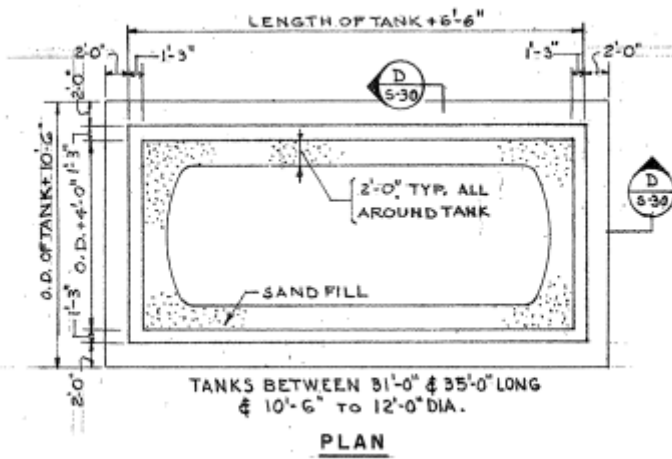

## SECTION 02080

### MANAGEMENT OF CONTAMINATED SOIL

#### PART 1 GENERAL

##### 1.01 SUMMARY

###### A. Section Includes

1. Requirements for disposal of excess natural or contaminated soil, as defined in this Section, generated from excavation activities at the Taunton Wastewater Treatment Facility. Areas where contaminated soil may be encountered include the former sludge landfill (new biological reactor) and the underground storage tanks.
2. Requirements for identifying, handling, stockpiling, and disposal of suspect or contaminated soil.

###### B. Related Sections

1. Section 01025 – Measurement and Payment
2. Section 01300 – Submittals
3. Section 02140 – Dewatering
4. Section 02075 – Management of Underground Storage Tanks

##### 1.02 WORK INCLUDED AND DEFINITIONS

A. In general, Work under this Section shall include all labor, materials, equipment, supervision and supplies necessary for the loading, handling, transportation, and off-site disposal of Suspect and Contaminated soil as directed by the ENGINEER.

1. “Natural” soils are those believed by the ENGINEER (but not yet confirmed by laboratory testing) to contain concentrations of oil or hazardous materials below reportable levels RCS-1. The designation of “Natural” soil will be made by the ENGINEER based on field screening, visual observation, and/or olfactory indicators.
2. “Suspect” soils are those believed by the ENGINEER (but not yet confirmed by laboratory testing) to contain concentrations of contaminants above reportable concentrations (Category RCS-1), as defined under the Massachusetts Contingency Plan (MCP). The designation of “Suspect” soil will be made by the ENGINEER based on field screening, visual observation, and/or olfactory indicators.
3. “Contaminated” soil shall be defined as those containing concentrations of contaminants above MassDEP’s RCS-1 reportable concentrations based on the ENGINEER’s laboratory analytical results.

B. The Contractor shall:

1. Secure all permits and licenses, as necessary;

2. Mobilize and demobilize of all personnel, equipment, materials and supplies required to perform the Work;
3. Assist ENGINEER in obtaining environmental samples;
4. Upon determination by the ENGINEER (based on laboratory sample results) that the soil qualifies as Contaminated soil, the CONTRACTOR shall coordinate off-site disposal of the soil at an appropriate disposal facility. As stipulated in Section 01025, the CONTRACTOR is responsible for the disposal of excess soil "Natural" as defined above at no additional cost to the OWNER;
5. Segregate boulders and other large rocks for off-site management, as directed by the ENGINEER;
6. To the extent practical, remove and segregate asphalt from the soil; and,
7. Perform general site cleanup at the completion of the work.

#### 1.03 SAMPLING

- A. The Contractor will provide all equipment, manpower, and machinery required to conduct test pits for collection of representative soil samples. The Contractor will backfill and restore each test pit to match existing grades.
- B. The ENGINEER will be responsible for sampling and analyses as may be required by the receiving disposal facility(ies) for off-site disposal of Contaminated soil. Any such sampling services shall be identified by Contractor as quickly as possible, and Engineer will respond as expeditiously as possible. Contractor shall schedule his/her activities to allow for sampling to be performed, analytical results to be compiled and management decisions to be made. No claim shall be made for reasonable delays associated with such supplemental sampling, analytical services and decision making. In most cases, Engineer will provide any necessary sampling services and analytical results within fourteen (14) days after formal request by Contractor. To accommodate a time critical project activity, and upon Contractor's request, Engineer will accelerate the supplemental sampling and analytical results to the extent reasonably possible.
- C. Any samples collected and/or tested by the CONTRACTOR shall be for his own convenience only, and shall not be the basis for classification, determination of limits, or payment.

#### 1.04 LICENSED SITE PROFESSIONAL (LSP) SERVICES

- A. All Licensed Site Professional (LSP) services for the work shall be provided by the ENGINEER, including all Massachusetts Department of Environmental Protection (MassDEP) response actions. The ENGINEER will be responsible for preparing all Massachusetts Contingency Plan (MCP) related filings including but not limited to Utility-related Abatement Measure (URAM) Plans, Release Abatement Measure (RAM) plans, Material Shipping Records, and Bills of Lading.



## 1.05 APPLICABLE LAWS AND REGULATIONS

- A. The CONTRACTOR is advised that Work under this Section may need to be performed under the requirements of 310 CMR 40.0000 et seq., also known as the Massachusetts Contingency Plan (MCP).
- B. Work under this Section shall be performed in strict compliance with all applicable Federal, State and local laws, rules, regulations related to the handling and off-site management of contaminated wastes and regulated soil.
- C. Pertinent Federal and State Authorities having jurisdiction over this project include:
  - 1. Occupational Safety and Health Administration (OSHA)
  - 2. U.S. Environmental Protection Agency (EPA)
  - 3. Massachusetts Department of Environmental Protection (MassDEP)
- D. The following OSHA regulations will apply:
  - 1. Occupational Safety and Health Standards, Hazardous Waste Operations and Emergency Response - 29 CFR 1910.120.
  - 2. Safety and Health Regulations for Construction - 29 CFR 1926.

## 1.06 SUBMITTALS

- A. Submittals shall be made in compliance with the requirements of Section 01300 except as provided for herein.
- B. No Work will be permitted to proceed until the required submittals have been received and approved by the ENGINEER. In the event the ENGINEER requests additional information, it shall be the CONTRACTOR's responsibility to provide such additional information in a complete and timely manner, so that construction can proceed by the date stipulated in the Notice to Proceed.
- C. Contaminated soil may be encountered during the work. Prior to the commencement of work, the CONTRACTOR shall submit the following to the ENGINEER for approval:
  - 1. Submittal of all required certifications demonstrating that personnel are properly trained and qualified to perform the Work in accordance with applicable OSHA regulations and all laws governing the Work.
  - 2. Names and qualifications of all proposed subcontractors, if any, identifying the tasks to be performed by each proposed Subcontractor.
- D. The CONTRACTOR's Site-Specific Health & Safety Plan pursuant to OSHA 1910.120 requirements.
- E. Approval of submittals by the ENGINEER shall not impose any liability upon the ENGINEER, nor shall any such approval relieve the CONTRACTOR of his/her

responsibilities to meet all of the requirements and comply with all applicable laws, regulations and other applicable requirements under this Contract.

#### 1.07 EXISTING ENVIRONMENTAL CONDITIONS

- A. The CONTRACTOR shall satisfy himself/herself as to the conditions existing at the Site, the type of equipment required to perform this Work, and the quality and quantity of the materials to be removed.
- B. Failure of the CONTRACTOR to become fully acquainted with the available information will not relieve him/her of the responsibility to completely and properly perform the work in full compliance with the Contract Documents. The ENGINEER assumes no responsibility for any conclusion or interpretation made by the CONTRACTOR on the basis of information made available by the Owner or ENGINEER.

#### PART 2 PRODUCTS [NOT USED]

#### PART 3 EXECUTION

##### 3.01 GENERAL

- A. The CONTRACTOR will provide adequate barriers and demarcation of excavations and exclusion zones to warn site visitors and the public of potential hazards.
- B. The CONTRACTOR will take appropriate means to prevent a release or the spread of contaminated materials as a result of the CONTRACTOR's operations.
- C. The ENGINEER will be responsible for collection of all samples, and the determination of the limits of contamination. The CONTRACTOR shall assist with sample collection.

##### 3.02 SITE HEALTH & SAFETY

- A. The CONTRACTOR is solely responsible for controlling Site health and safety, including the provision of a Site Health and Safety Officer. In the performance of its Work, the CONTRACTOR shall provide for the safety of all CONTRACTOR personnel, other CONTRACTOR's personnel, regulatory agency personnel, and the public for the duration of the Contract.
- B. The CONTRACTOR is solely responsible for his/her construction means and methods.
- C. The ENGINEER will be responsible for the health and safety of its personnel only.
- D. All personnel performing Work in contaminated or hazardous areas shall be fully trained in accordance with the OSHA 1910.120 and the HASP and shall be thoroughly briefed on anticipated hazards, safety equipment to be employed, safety practices to be followed, and emergency procedures and communications. The CONTRACTOR shall

have a medical monitoring surveillance program in place for all personnel in accordance with all applicable laws and regulations.

### 3.03 MISCELLANEOUS PROVISIONS

- A. CONTRACTOR must have a valid EPA identification number and any other permits or licenses required by federal, state, and local laws, regulations, ordinances, and procedures for the transportation of hazardous wastes.
- B. The CONTRACTOR shall be responsible for securing all necessary and applicable permits, certificates, licenses, and approvals required for the performance of this Work and shall be responsible for the payment of all associated fees.
- C. The CONTRACTOR shall comply with all required reporting and record keeping requirements in accordance with the provisions of this Contract and all applicable federal, state, and local laws, regulations, ordinances, and procedures.
- D. The CONTRACTOR shall be responsible for all notifications required by federal, state, and local laws, regulations, ordinances, and procedures. All notifications shall be coordinated with the ENGINEER.
- E. Material Shipping Records and/or Bills of Lading, as appropriate, will be provided and coordinated by the ENGINEER. The Owner will be responsible for signing all waste manifests and bills of lading. In order for CONTRACTOR's operations to proceed without interruption, complete and accurate information shall be provided by the CONTRACTOR during the Submittals process. CONTRACTOR shall be responsible for preparing applications to disposal facilities.

### 3.04 DUST MONITORING & CONTROL MEASURES

- A. The CONTRACTOR is responsible for monitoring the Work for evidence of airborne particulates (dusts) emanating from the Work area. It shall be the CONTRACTOR's responsibility to continuously monitor the work area for dust levels.
- B. The CONTRACTOR shall take appropriate measures to substantially eliminate the generation of dusts within the Work Area, including use of water provided by the CONTRACTOR and covering all stockpiled wastes and/or soil, except in the immediate vicinity of the excavation, where water may be required to control dust emissions.
- C. The ENGINEER will also be monitoring the site for elevated levels of dusts. In the event that visible emissions are observed, the ENGINEER may direct the contractor to take appropriate measures to mitigate the condition. Failure of the CONTRACTOR to implement measures that reduce dust levels may be cause for suspension of the Work, until otherwise directed by the ENGINEER.

### 3.05 EXCAVATION OF SOIL

- A. Soil identified as “Natural” that is generated from excavation activities associated with the Taunton WWTF will become property of the CONTRACTOR. As stipulated in Section 01025, the CONTRACTOR is responsible for the disposal of excess “Natural” soil as defined above at no additional cost to the OWNER. The CONTRACTOR shall be responsible for documenting quantity and destination of natural soil removed from the site.
- B. Soil identified as “Suspect” shall be temporarily stockpiled until it can be tested and determined to be Natural or Contaminated (see Part 3.06).
- C. Soil identified as “Contaminated” that is generated from excavation activities associated with the Taunton WWTF will be transported off site by the CONTRACTOR to a facility approved by the Engineer. A Material Shipping Record or Bill of Lading is required for shipment of all “Contaminated” soil.
- D. The CONTRACTOR shall minimize the spread and loss of Contaminated Soil during excavation activities as follows:
  - 1. The CONTRACTOR shall segregate boulders, asphalt, construction debris and other deleterious materials from excavated Soil to the extent practicable and as directed by the ENGINEER. This segregation shall occur at the point of excavation, prior to the transport of soil.

### 3.06 TEMPORARY SOIL STOCKPILING

- A. The ENGINEER anticipates the need for temporary stockpiling of soil. However, the work areas may not allow for stockpiling at the site of generation of the soil. Therefore, soil may be transported to and stockpiled at the OWNER’s property located at 100 Arlington Street in Taunton, Massachusetts (or another site designated by the OWNER). The following provisions shall apply to the stockpiling:
  - 1. Due to space limitations at 100 Arlington Street a maximum of 1,500 cubic yards total of soil can be stored at one time.
  - 2. Natural soil, suspect soil, and Contaminated soil stockpiles shall be maintained separately and delineated with jersey barriers.
  - 3. Straw wattles shall be provided on the downgradient side of all stockpiles.
  - 4. As directed by the ENGINEER, Suspect soil and Contaminated soil shall be stockpiled out of the immediate work area and in a location designated by Owner (such as 100 Arlington Street), on 6-mil polyethylene sheeting. All stockpiled Suspect soil and Contaminated soil shall be covered with 6-mil polyethylene sheeting at the end of every working day. Sheeting shall be properly secured such that it remains fully intact during inclement weather conditions.
  - 5. As directed by the ENGINEER, soil that is not pre-characterized shall be stockpiled out of the immediate work area and in a location designated by Owner (at 100 Arlington Street), on 6-mil polyethylene sheeting. All stockpiled soil that is not pre-

characterized shall be covered with 6-mil polyethylene sheeting at the end of every working day. Sheeting shall be properly secured such that it remains fully intact during inclement weather conditions.

6. All stockpiled soil shall be transported from 100 Arlington Street to an appropriate disposal facility as soon as possible. Excavated soil shall not remain stockpiled for more than 90 days from its excavation, or in the case of suspect soil, from the date of its determination.

### 3.07 OFF-SITE MANAGEMENT OF CONTAMINATED SOIL

- A. The CONTRACTOR shall be responsible for the off-site transportation and disposal of Contaminated soil.
- B. The CONTRACTOR shall be responsible for coordination of all transporter and receiving facility activities. Transporter vehicles used for the transportation of Contaminated soil shall be covered, substance compatible, licensed, insured, and permitted pursuant to federal, state, and local laws, regulations, ordinances, and procedures.
- C. Vehicles departing the site shall be properly logged by the ENGINEER. CONTRACTOR shall provide appropriate information, including the vehicle identification, driver's name, destination, and approximate volume and content of material carried.
- D. Contaminated soil shall not leave the site until the designated receiving facility has agreed in writing to accept the type and quantity of waste/soil to be shipped.
- E. The CONTRACTOR shall complete required facility applications and other pertinent forms for proper transportation and disposal. The ENGINEER shall review and a representative of the City of Taunton will sign the applications as the generator. Signatures from the receiving location of materials transported off-site are required. The CONTRACTOR shall be held accountable for ensuring that requirements of the transporter and receiving disposal facility(ies) and federal, state, and local laws, regulations, ordinances, and procedures are complied with and properly documented.
- F. Documentation shall be maintained indicating that applicable laws have been satisfied and that Contaminated soil has been successfully transported and received at the disposal facility(ies).
- G. Actual quantities and measurements shall be tabulated by the CONTRACTOR and confirmed by the Engineer on a daily basis. The CONTRACTOR will not be reimbursed for unit rate work performed without the prior approval.

### 3.08 SITE CLEANUP

- A. During the course of the Work, the CONTRACTOR shall keep the Site and his operations clean and neat at all times. The CONTRACTOR shall dispose of all residue resulting from the site operations; and at the conclusion for the day's Work, he shall remove and haul away surplus materials, lumber, equipment, temporary structures, and

any other refuse remaining from the site operations and shall leave the site in a neat and orderly condition.

### 3.09 DOCUMENTATION

- A. Within 21 days after substantial completion of the Work, the CONTRACTOR shall submit to the ENGINEER one (1) original copy of all manifests, certified weigh slips (tons), bills-of-lading, and records of final waste disposition from the accepting disposal facility(ies), and all other pertinent documentation, including a summary of dates and quantities relating to the off-site management of Contaminated soil.

END OF SECTION

## SECTION 02140

### DEWATERING

#### PART 1 GENERAL

##### 1.01 SUMMARY

- A. Dewatering specified in this section is applicable to all utilities and structures under the work.
- B. Section Includes
  - 1. Requirements for designing, furnishing, installing, maintaining, operating and removal of temporary dewatering systems required to lower and control water levels and hydrostatic pressures during construction.
  - 2. Requirements for disposing of pumped water.
- C. Related Sections
  - 1. Section 02160 – Excavation Support.
  - 2. Section 02200 – Earth Excavation, Backfill, Fill, and Grading.

##### 1.02 DEFINITIONS

- A. Dewatering: Lowering the zone of saturation and intercepting groundwater seepage which would otherwise emerge from the slopes or bottom of the excavations. The purposes of dewatering are to increase the stability of excavated slopes; prevent loss of material from beneath the slopes or bottom of the excavation; improve the excavating and hauling characteristics of on-site soil; prevent rupture or heaving of the bottom of an excavation; and dispose of pumped water. In addition, dewatering is required to place and compact structural fill.

##### 1.03 DESIGN REQUIREMENTS

- A. The Contractor is responsible for the adequacy of the dewatering system.
- B. Design dewatering systems to:
  - 1. Effectively reduce the hydrostatic pressure and lower the groundwater levels to a minimum of 2 feet below bottom of excavation in sandy soil; and lower the groundwater levels to a minimum of four (4) feet below bottom of excavation in silty soil;
  - 2. Design and install the dewatering system such that the excavation bottom remains stable through construction and so that groundwater does not seep out of open cut slopes thereby reducing the slope stability. Pumping from the bottom of the excavation as the sole means of dewatering will not be permitted.
  - 3. Develop a substantially dry and stable subgrade for the protection of subsequent operations;

- 4 Result in no damage to adjacent buildings, structures, utilities and other work, included in this contract.
- C. Dewatering shall be completed in accordance with the Contractor's chosen method capable of meeting the requirements of this specification.
- D. Monitoring wells shall be provided inside and outside of each excavation to demonstrate that the dewatering system is functioning as designed prior to the start of excavation (four for each excavation). The monitor well locations, depths, and descriptions, both inside and outside of the excavation, will be provided to the Contractor by the Engineer after review of the Contractor's Dewatering and Excavation Support submittals. The Contractor shall coordinate and work with the Engineer to implement the dewatering system monitoring requirements.
- E. The Contractor shall provide proposed structure buoyancy calculations (annotated) with any necessary drawings and sketches to support when the construction dewatering system can be safely turned-off and removed/abandoned without damage to the Work.
- F. During monitor well construction, the Contractor shall take a minimum of three (3) soil samples (minimum 8 oz jar size, larger preferred) during the installation of each monitoring well at the depth locations indicated by the Engineer, with one sample at mid slot/screen section level, for submission to the Engineer
- G. Methods may include sump pumping, single or multiple stage well point or jet eductor well point systems, deep wells, or combinations thereof.
- H. Locate dewatering facilities where they will not interfere with existing utilities, facilities and/or construction work to be done under this Contract.
- I. Contractor is responsible to obtain all necessary permits from state and local authorities, including Veolia, regarding the operation and discharge of the dewatering system, and to conduct all necessary sampling and testing that may be required by those authorities. The Contractor is responsible for **all associated costs.**
- J. Dewatering system performance shall be assessed by a program of groundwater well installations and well monitoring per this specification, and as approved by the Engineer.
- K. Design the dewatering system to provide adequate settling, and filtering facilities so that the discharge does not contain suspended soil particles. Design the discharge so that the discharge location is not damaged or eroded. The Contractor shall design their sediment removal system to meet the effluent requirements of the NPDES Construction General Permit.
- L. Coordinate the dewatering system design with excavation support system requirements.
- M. Design, provide, install, operate, maintain and remove a temporary surface water control program, which will divert surface water away from excavations, trenches, utilities, and all other work areas.



- N. Design shall include provisions to prevent freezing including but not limited to heat trace, insulation, low temperature alarms, and appurtenances required to insure continuous operation of the dewatering system.

#### 1.04 SUBMITTALS

##### A. Shop Drawings

1. Design of the excavation support and dewatering systems shall be coordinated and shall be submitted in the same transmittal.
2. In accordance with Section 01300 submit the following prior to dewatering system installation:
  - a. Proposed system components.
  - b. Operational plan to include locations and depth of components.
  - c. Method of disposal of pumped water, including method of insuring proper sediment removal should upset in dewatering system occur.

##### B. Quality Assurance/Control Submittals

1. In accordance with Section 01300 submit the following:
  - a. Dewatering systems to be designed under the direct supervision of a Professional Engineer registered in the State of Massachusetts.
  - b. Complete Certificate of Design at the end of this section.
  - c. Provide documentation demonstrating ability and experience of installing contractor for the type of conditions under this contract.
  - d. Names, addresses and telephone numbers of supervisory personnel actively involved in at least five successful projects requiring dewatering.

#### 1.05 PROJECT/SITE CONDITIONS

##### A. Subsurface Data

1. A Geotechnical Report including test borings and laboratory soil testing data, has been completed and are including in Appendix A to the Specification.
2. The data shown is for general bidding information. Bidders are expected to examine the site, review the provided reports, exploration logs and samples to evaluate the character of subsurface conditions. No warranty, express or implied, is made concerning the accuracy of the subsurface data.
3. The Contractor shall notify the Engineer immediately if subsurface conditions encountered during construction are different from those encountered in the explorations.
4. Upon notification to the Owner, bidders will be allowed to perform additional subsurface explorations to satisfy themselves of the existing subsurface conditions at no additional cost to the Owner.

B. Environmental Requirements

1. Dispose of pumped water in accordance with Notice of Intent and the associated Order of Conditions.

C. Existing Facilities

1. Discharge of dewatering effluent to the City of Taunton drainage system or directly to Waters of the United States is not permitted.

D. Existing Conditions

1. Groundwater Measurements have been made previously and are noted in Appendix A.
2. Groundwater surface is subject to seasonal fluctuations, tidal influences and fluctuation during periods of heavy precipitation

PART 2 PRODUCTS

NOT USED

PART 3 EXECUTION

3.01 GENERAL

- A. Operation and Performance: Once started, operate the dewatering system continuously, 24 hours per day, 7 days per week, until such time as construction work below existing groundwater levels is complete, and/or as directed by the Engineer.
  1. Measure and record the performance of the dewatering system at the same time each day using a flow measurement device and the groundwater monitoring well(s) installed to monitor dewatering system performance.
- B. Coordinate the dewatering Work schedule with the General Contractor, and other subcontractors performing related work.
- C. The Contractor shall coordinate a Pre-Construction Meeting with the Engineer to discuss Contractor means, methods, procedures and schedule for dewatering systems construction, operation and removal/abandonment when no longer needed.
- D. Complete installation of the dewatering system in accordance with the submittal design approved by the Engineer. Provide all labor, materials, equipment, and supervisory personnel required to perform the Work.
- E. Store materials at the designated locations in an organized fashion in order to execute the Work in an expeditious manner and to permit on-going existing pump station operations.
- F. Layout the Work in the field and mobilize labor, materials, equipment, and supervisory personnel necessary for the performance of dewatering work.
- G. The Contractor shall adapt and modify the dewatering and sedimentation treatment systems as required throughout the course of the Work to meet applicable requirements.

### 3.02 SITE PREPARATION

#### A. Surface Drainage

1. Construct dikes, ditches, pipelines, sumps or other means to intercept and divert precipitation and surface water away from excavations.

#### B. Drainage of Excavated Areas

1. Construct dikes, ditches, pipelines, sumps or other means to collect surface and seepage water which may enter the excavation.
2. Discharge water through settling basins or method approved by Engineer when water is to be deposited into an existing watercourse.

### 3.03 INSTALLATION

A. Advise Engineer of changes made to Operation Plan as submitted under article 1.04 of this section, made to accommodate field conditions

B. Install additional dewatering facilities as needed to adequately dewater as specified herein at no additional cost to the Owner.

C. Complete effluent sampling in accordance with the Industrial Pretreatment Permit.

D. All wells, wellpoints and sumps shall be provided with suitable filter materials to prevent the migration or pumping of existing soil fines and subsequent subgrade weakening and disturbance.

#### E. Monitoring (Observation) Wells:

1. The Contractor shall install nominal 2-inch diameter schedule 40 PVC pipe solid riser and slotted screen pipe section observation wells in conformance with this specification. Groundwater wells are proposed to monitor groundwater levels both inside the excavation to assess the adequacy of the dewatering system, and outside of the excavation to assess the extent of groundwater draw-down.
2. The Contractor shall take a minimum of three (3) soil samples (minimum 8 oz jar size) during the installation of each monitoring well at the depth locations indicated by the Engineer, with one sample at mid slot/screen section level, for submission to the Engineer.
3. The Contractor shall inform the Engineer a minimum of 48 hours prior to observation well installations so that the Engineer may witness the installations of all observation wells.
4. The Contractor shall monitor groundwater elevations and keep a log of groundwater elevations and maintain at least the minimum number of monitoring wells indicated by the Engineer; additional monitoring wells may be required by the Engineer.
5. The Contractor shall:
  - a. Observe and record the elevations of groundwater.

- b. Repair or replace, within 24 hours, observation wells that become inactive, damaged, or destroyed. In areas where observation wells are not functioning properly, suspend construction activities until reliable groundwater observations can be made. Add or remove water from observation well risers to demonstrate that observation wells are functioning properly, as/if directed by the Engineer.
- c. Fill observation wells with an approved flowable fill or other material approved by the Engineer when dewatering is completed, and the Engineer has approved observation well decommissioning.

### 3.04 OPERATION

- A. Operate dewatering systems to lower the groundwater level in excavations allowing the Work to be performed on a stable dry subgrade.
- B. Modify dewatering procedures which cause, or threaten to cause, damage to new or existing facilities, in the opinion of the Engineer, to prevent further damage. Modifications shall be made at no additional expense to the Owner.
- C. Prevent disturbance of foundation soils and loss of ground as water is removed.
- D. Notify the Engineer of disturbance to the foundation soils caused by an interruption or inadequacy of the dewatering system.
- E. Maintain on-site auxiliary equipment to operate the dewatering system continuously, while the excavation is open and as directed by the Engineer.
- F. Provide the Engineer access to the dewatering systems at all times to obtain samples of the dewatering effluent prior to and after treatment. A flow meter capable of measuring to the nearest 0.1 gallons shall be installed at the discharge point prior to discharge entry into the existing pump station's wet well.
- G. It shall be the responsibility of the Contractor to remove sediment and suspended particles from the dewatering effluent to comply with permit and project requirements. These methods shall include, as a minimum, baffled sedimentation tank(s) and/or basins of sufficient capacity, and other measures as required and as approved by the Engineer.
- H. If sediment or other materials discharged from the dewatering system accumulates in the drains, conduits or other utilities, the Contractor shall be responsible to completely clean and remove all sediment from impacted utilities to the satisfaction of the Owner and at no additional cost to the Owner.

### 3.05 COMPLETION

- A. Upon completion of the dewatering operations, dismantle and remove all material and equipment associated with the system. Seal all dewatering wells upon completion of the dewatering by pressure injecting a grout capable of sealing the wells and preventing leakage.

END OF SECTION

CERTIFICATE OF DESIGN

Re: Contract Between

OWNER: \_\_\_\_\_  
(Name)

and  
CONTRACTOR: \_\_\_\_\_  
(Name)

on  
CONTRACT: \_\_\_\_\_  
(Title)

\_\_\_\_\_ Dated: \_\_\_\_\_  
(Number)

Contractor hereby certifies that \_\_\_\_\_  
(Designer)

1. Is licensed or registered to perform professional engineering work in the state of \_\_\_\_\_  
(Location of Project)

2. Is qualified to design the \_\_\_\_\_  
(Item)  
specified in Section \_\_\_\_\_ of the subject contract;

3. Has designed \_\_\_\_\_ before;

4. Has prepared the design in full compliance with the applications and requirements of  
Section \_\_\_\_\_ of subject contract including all applicable laws, regulations, rules and  
codes; and

5. The work has been signed and sealed pursuant to the applicable state law.

FOR: \_\_\_\_\_  
(Contractor)

BY: \_\_\_\_\_  
(Signature)

\_\_\_\_\_ Dated: \_\_\_\_\_  
(Name and Title)

## SECTION 02149

### MAINTAINING EXISTING FLOW

#### PART 1 GENERAL

##### 1.01 SUMMARY

###### A. Section Includes

1. Requirements to maintain existing flow, including Return Activated Sludge (RAS) and Waste Activated Sludge (WAS), and implement and complete all flow diversions and/or bypass pumping required to complete all Work. Refer to Specification Section 01810 – Maintenance of Plant Operation and Sequence of Construction; and Drawing G-1.5 for additional requirements.

##### 1.02 SYSTEM DESCRIPTION

###### A. Performance Requirements

1. It is essential to the operation of the existing sewerage system that there be no interruption of the wastewater, WAS or RAS flow throughout the duration of this project. The wastewater treatment facility is a part of the sewerage system. An interruption shall be considered, but may not be limited to, any condition that in the sole opinion of the Engineer adversely affects or alters operation of the existing sewerage system and/or any other portion or component of the existing sewage treatment system including the associated flows; allows the level of sewage flow to increase, rise, collect, surcharge and/or overflow existing facilities in any manner; or results in any operational or permit violations being issued to the Owner.
  2. The Contractor shall provide, maintain, and operate temporary facilities such as dams, bulkheads, pumping equipment (both primary and backup units as required) conduits, electrical power, and all other labor and equipment to intercept and maintain the existing sewage flow before it reaches the point where it would interfere with his work, carry it past his work, and return it to the existing facilities beyond his work.
- B. The Contractor's attention is directed to the fact that the existing wastewater flow may be affected by high groundwater and rainfall. Increases in normal flow should be expected during periods of wet weather. The Contractor shall therefore take all precautions necessary including monitoring weather forecasts to fully accommodate, control and sufficiently handle the increases in flow during periods of wet weather and/or storms as well as periods of normal flow.
- C. The Engineer may prohibit the carrying out of any work at any time when in his sole judgment, increased flow conditions are unfavorable or not suitable, or at any time, regardless of the existing flows, when proper precautions are not being taken to

safeguard the existing sewerage system, previously constructed work, work in progress and/or the general public.

- D. In case of damage caused by the failure of the Contractor to take adequate precautions, the Contractor shall repair or replace equipment damaged and shall make such repairs or rebuild such parts of the damaged work, as the Owner may require, at no additional expense to the Owner.

### 1.03 SUBMITTALS

- A. Submittal shall be prepared in close coordination with the WWTF Operators, Veolia, North America.
- B. Submit detailed plans and descriptions outlining all provisions and precautions to be taken regarding the control and handling of existing sewage and sludge flows. Submission shall include such items as schedules, locations, elevations, capacities of equipment, materials, traffic maintenance plans, and all other incidental items necessary and/or required by the Owner to ensure proper protection of the facilities and compliance with the requirements herein specified.
- C. Submit qualifications as described herein.
- D. Submit detailed proposal for noise prevention measures for review of at least thirty (30) consecutive calendar days prior to anticipated usage.
- E. Submit shop drawings for all pumping, piping, controls and appurtenances for type and size of equipment required to perform the flow diversion and/or bypass pumping work as required herein.
- F. The Engineer reserves the right to limit and/or otherwise restrict the Contractor's overall proposal and/or operations without claim should the Engineer deem it to be in the Owner's or public's best interest to do so.

### 1.04 QUALITY ASSURANCE

#### A. Qualifications

1. The design, installation and operation of the temporary pumping system shall be the Contractor's responsibility. The Contractor shall employ the services of a vendor who can demonstrate to the Engineer that he specializes in the design and operation of temporary bypass pumping systems. The vendor shall provide at least five (5) references of projects of similar size and complexity in wastewater applications performed by his firm within the past three years within New England. The bypass system shall meet the requirements of codes and regulatory agencies having jurisdiction.
2. The vendor shall demonstrate the bypass pumping equipment is automated and is capable of functioning without the assistance of an operator.

3. The vendor shall demonstrate the pumping equipment can operate for an extended period of time running dry. After this period of time, the pump shall have the capability of pulling a 25” Hg vacuum without adjustment or repair.
4. The vendor shall demonstrate sufficient service resources and repair parts in stock to fulfill service or repair of rental equipment within one hour of a service call, twenty-four hours per day, seven days per week.
5. Temporary components of the bypass system including pumps, pipe, hose, valves, and fittings shall be provided by one bypass vendor. Hydraulic calculations and drawings required by the submittals shall be provided by the bypass vendor and stamped and certified by a Professional Engineer licensed in the Commonwealth of Massachusetts.

#### 1.05 SPECIAL BYPASS REQUIREMENTS

- A. Any required bypassing of the Secondary Treatment Process and the yard piping between the Primary Clarifiers, Aeration Tanks and Final Settling Tanks will require special requirements as described below. In addition, rehabilitation of each Secondary Sludge Pump Stations will require bypassing of WAS and RAS flow.

The bypass systems shall be sized to handle the following wastewater/sludge flows:

	Minimum	Average	Maximum
Total Wastewater Flow (mgd)	7	8.4	17.4
Battery 1 Flow (mgd)	2.3	2.8	5.8
Battery 2 Flow (mgd)	5.4	5.6	11.6
Battery 1 RAS (mgd)	1.7	2.8	3.9
Battery 2 RAS (mgd)	3.3	5.6	7.7
Battery 1 WAS (gpm)	-	250	-
Battery 2 WAS (gpm)	-	250	-

B. Yard Piping Between Primary Settling Tanks and Existing Aeration Tanks

1. To maintain existing flow from the existing primary settling tanks to the existing aeration tanks, the Contractor may be required to pump from the effluent end of each primary settling tank to the head end of each aeration tank. If bypass pumping between these two processes is required, the Contractor shall provide positive flow control by means of variable speed pumps with individual discharge pipes to each aeration tank, or by other means approved by the Engineer.
2. Bypass pumping system will include all pumps, controls, piping and valves as described above, as well as other power generating facilities and noise prevention measures described herein

C. Yard Piping Between Existing Aeration Tanks and Final Clarifiers

1. To maintain existing flow from the existing aeration tanks to the existing final clarifiers, the Contractor will be required to pump from the effluent end of each



aeration tank to a temporary common distribution header that discharges to each of the final clarifiers. Balancing valves shall be installed between the common distribution header and the individual pipes discharging to each final clarifier for flow control.

2. Pumping rate shall be variable to match plant flow, but in no case should the system deliver more than 5.6 mgd per clarifier.
3. Bypass pumping system will include all pumps, controls, piping and valves as described above, as well as other power generating facilities and noise prevention measures described herein

#### D. Secondary Sludge Pump Stations

1. To maintain existing RAS and WAS from from the Final Clarifier Pump Stations to the existing/new biological reactors. Refer to Specification Section 01810 and Drawing G-1.5 for temporary equipment locations, necessary temporary pump station modifications, underground pipe connections and additional requirements.
2. Pumping rate shall be variable to match plant flow based on the existing WWTF influent flow meter. The Operator shall be provided the ability to set the pump flowrate based on a percentage of the influent flow to the facility. The percentage shall be between 75% and 125% of the influent flow.
3. Bypass pumping system will include all pumps, controls, piping and valves as described above, as well as other power generating facilities and noise prevention measures described herein

## PART 2 PRODUCTS

### 2.01 EQUIPMENT

#### A. Pumping System(s)

1. All pumping units (primary and secondary) and appurtenances shall be sized properly to handle the flows encountered including increased flows due to wet weather.

#### B. Piping System(s)

1. All piping systems (primary and secondary) and appurtenance shall be sized properly to handle the flows encountered including increased flows due to wet weather.

#### C. Power Generating Facilities

1. Include power generating facilities capable of providing all power necessary to operate any primary and secondary pumping systems. Use of the Owner's standby power facilities will not be allowed.
2. Maintain facility to be ready for use if required.

#### D. Noise Prevention

1. Noise prevention measures for all equipment shall be used to insure minimum noise impact or surrounding areas.
2. Measures may include but shall not be limited to insulation, electric pumping units, and hospital grade silencers or mufflers.
3. Noise shall be kept to a minimum particularly if any night, Saturday, Sunday or holiday work be deemed necessary by the Engineer for work under this Contract.
4. Should at any time prior to or during the performance of above mentioned work, the Engineer determines the noise prevention measures being used are not adequate, the Contractor shall at no additional cost to the Owner suspend all work until acceptable measures are incorporated.

#### E. Backup Facilities for Bypass Systems

1. Provide adequate on-line back-up facilities for all equipment to be supplied so that service is not interrupted. Equipment and installation are subject to the approval of the Owner and the Engineer.

### PART 3 EXECUTION

#### 3.01 INSTALLATION

- A. Keep the Engineer advised at all times of any changes made to the overall operation(s) to accommodate field conditions.
- B. Flow diversions and/or bypass pumping, temporary screening facilities and other work described in this section shall be maintained at all times as long as it is necessary to maintain the flow through the limits of the project during construction.
- C. Maintain auxiliary and/or emergency equipment at the site to continue flow division and/or by-pass pumping operations in the event of a breakdown and/or loss of normal power.
- D. No work shall begin until all provisions and requirements of this Section have been reviewed and approved by the Engineer.
- E. The Engineer reserves the right to limit and/or otherwise restrict the Contractor's overall activities and/or operations at any time without claim should the Engineer deem it to be in the Owner's or public's best interest to do so.

END OF SECTION

## SECTION 02160

### EXCAVATION SUPPORT

#### PART 1 GENERAL

##### 1.01 DESCRIPTION

- A. The work specified in this section includes designing, furnishing, installing, and documenting excavation support systems; maintaining the excavation support system as required and partial removal when no longer needed. The Contractor shall properly design and furnish all labor and materials necessary, and shall construct complete, all sheeting, bracing, pipeline penetrations and appurtenances required to perform the Work of excavation support for construction of the Work as specified, as directed by the Engineer, or as required by agencies having jurisdiction over the Work.
- B. The word “Sheeting” as used in this specification section shall refer to the excavation support method utilized by the Contractor on the project.
- C. The support of excavation system is to be designed by the Contractor for Engineer review, evaluation and approval. The Contractor shall be responsible for all design and construction: means, methods and materials for the support of excavation system. The construction, maintenance, and removal of the excavation support system may not adversely affect new or existing construction. All excavation support at completion of the Work, shall be left-in-place and cut-off/removed to six (6) feet below finished grade or as directed by the Engineer. Excavation support removal may include bracing elements.
- D. The proximity of adjacent structures, manholes and pipelines shall be considered in the design, construction, maintenance and monitoring of the support of excavation system.
- E. The support of excavation and dewatering systems designs shall be coordinated.
- F. If steel sheeting is proposed for excavation supports steel “points” will be required due to the potential for hard installation conditions and resulting sheet pile damage/loss of groundwater seal.
- G. While not identified in the geotechnical borings, **boulders are present at the Taunton WWTF site and boulders should be expected while installing excavation support.** The contractor shall include provisions for addressing boulders encountered during installation of the excavation support at no additional cost to the Owner.
- H. Related Sections
  - 1. Section 02140 – Dewatering
  - 2. Section 02200 – Earth Excavation, Backfill, Fill, and Grading.
  - 3. Appendix A – Geotechnical Report

##### 1.02 REFERENCES

- A. ASTM, American Society of Testing and Materials

- B. AISC, American Institute of Steel Construction
- C. OSHA, U.S. Department of Labor, Occupational Safety and Health Administration, Construction Standards and Interpretations, 29 CFR Part 1926.

#### 1.03 DESIGN RESPONSIBILITY

- A. The Contractor shall be fully responsible for providing a complete and adequately designed support of excavation system as required and/or directed by the Engineer in accordance with the provisions set forth herein. The sheeting shall be designed to resist all hydrostatic pressures in accordance with the Contractor's dewatering design.
- B. The Contractor shall engage, at his own expense, the services of a fully competent and qualified Professional Engineer, hereinafter referred to as the "Contractor's Engineer", registered and in good standing with in the Commonwealth of Massachusetts for the design of all sheeting requirements to accomplish the Work specified, and for supervising the proper on-site installation associated therewith. The Contractor's Engineer shall be acceptable to the Engineer and demonstrate a minimum of ten (10) years documented experience in the field of sheeting/bracing design and implementation. Prior to the actual employment of the Contractor's Engineer, the Contractor shall submit to the Engineer, to the full extent deemed necessary, a detailed resume stating the Contractor's Engineer's professional qualifications, related experience and references, and examples of work similar to that required for the Work specified, for a general review by the Engineer and a means of documenting the requisite experience hereinbefore specified. Only after a satisfactory review of the Contractor's Engineer's overall qualifications by the Engineer in fulfillment of the requisite experience hereinbefore specified shall the Contractor finalize such employment and begin the design aspects of the Work.
- C. The Contractor's attention is directed to the fact that the acceptance of the Contractor's Engineer and/or his/her qualifications by the Owner and/or Engineer shall not be an overall approval of the Contractor's Engineer nor the sheeting designs and methods of installation employed during the Work. It being understood that all sheeting requirements necessary to accomplish the Work specified shall be designed by and installed under the direct supervision of the Contractor's Engineer who shall ultimately and fully bear the responsibility for that Work.
- D. The support of excavation design shall be coordinated with the dewatering system design to be submitted under Specification Section 2140, Dewatering.

#### 1.04 QUALITY ASSURANCE

- A. The Contractor's Engineer shall provide and maintain throughout the sheeting installation and/or Work sufficient supervision and technical guidance to the Contractor for proper sheeting/bracing materials, equipment, operations and methods to the extent necessary to assure strict compliance with the Contractor's Engineer's design, all safety procedures and standard requirements for such Work, and the successful completion of the Work. Failure to provide and/or maintain such supervision and/or technical guidance during the Work shall in no way relieve the Contractor's Engineer and/or the Contractor from their overall responsibilities and obligations under the Contract, nor shall it be a basis for any claim by either against the Owner and/or Engineer.
- B. The Contractor and Contractor's Engineer shall fully indemnify and save harmless the Owner and Engineer and their agents, employees and representatives, from and against any and all

claims as stipulated under the Agreement, whether directly or indirectly arising out of, relating to or in connection with the Work.

- C. Quality assurances and proper safety procedures must be maintained at all times and be in strict accordance with the Contractor's Engineer's requirements and consistent with all federal, state and local regulatory agencies having jurisdiction over the Work. Should any conflict in requirements, regulations, restrictions or codes exist between that which is specified by the Contractor's Engineer and any federal, state or local agency, the more stringent application shall prevail.
- D. Construction vibration monitoring during support of excavation installation and removal; excavation, soil/asphalt compaction and other construction activities producing significant vibration will be an Engineer function. The Engineer will provide vibration monitoring results to the Contractor. The Contractor may also monitor construction vibration as/if they deem necessary. The Contractor shall provide vibration monitoring data to the Engineer on a timely basis.
- E. A Geotechnical Report including test borings and laboratory soil testing data; are included as Appendix A to the Specifications. The locations of project geotechnical borings are provided in the Geotechnical Report and on the project drawings. The Contractor shall fully examine existing site conditions and provided information to ensure that this Work can be performed safely, as specified and in accordance with industry standards.

The Contractor shall provide all required equipment, modified if needed, to accommodate site conditions. Subsurface conditions may contain boulders, natural or manmade materials and/or other obstructions to the Work. The Contractor shall be prepared to penetrate through and/or remove such obstacles at no additional cost to the Owner. The indicated subsurface conditions are not intended as representations or warranties of the continuity of such conditions.

- F. The Contractor shall coordinate a Preconstruction Meeting with the Engineer to discuss the Contractor's design and construction: means, methods, procedures and schedule for support of excavation system construction and additionally include, but not be limited to:
  - 1. Review of existing buildings, utilities and subsurface conditions.
  - 2. Review coordination for interruption, shutoff, capping, and continuation of utility services.
  - 3. Review proposed support of excavation, excavation and dewatering systems design and construction including specific attention to the pipeline penetrations of the support of excavation system.
  - 4. Review proposed sequence of construction, equipment and back-up equipment to be on-site.
  - 5. Review instrumentation: required groundwater level monitoring; survey monitoring of support of excavation system and sheeting adjacent: ground, buildings, utility manholes and valve boxes and other facilities.
  - 6. Review the partial removal of support of excavation system and the abandonment of the dewatering system when no longer needed.
  - 7. Review measures to maintain continuity of existing pump station operations during construction of the Work.
- G. The Contractor shall, at all times, be responsible for maintaining the support of excavation system to:
  - 1. Permit the satisfactory and safe construction of the work.
  - 2. Provide adequate protection against damage to all existing adjacent/nearby utilities, structures, manholes, buildings and completed portions of the work.

3. Prevent injury to persons.
- H. The Contractor shall control surface water, and surface grades adjacent to excavations to prevent water from draining into excavated areas and to prevent damage to other structures or new construction.
- I. Welding Operations shall be conducted in accordance with AWS D1.1/D1.1M.
- J. The Engineer may perform support of excavation system inspections on a periodic basis. The Contractor shall provide the Engineer with access to structural steel work for inspections.

The Engineer shall visually verify structural steel materials, member sizes and connection details. The Contractor shall proceed with structural steel work only after unsatisfactory conditions have been corrected to the Engineer's satisfaction.

- K. Survey-Work Benchmarks: Resurvey benchmarks regularly with a frequency of weekly, or more frequent and as directed by the Engineer during construction of support of excavation system, excavation progress, and for as long as the excavation remains open. Maintain an accurate log of surveyed elevations and positions for comparison with original elevations and positions. Promptly notify the Engineer if changes in sheeting elevations or positions occur or if cracks, sags, or other damage is evident in the support of excavation structure or adjacent construction.
- L. Promptly correct detected bulges, breakage, or other evidence of movement to ensure that the support of excavation system remains stable and safe.
- N. Promptly repair damages to adjacent facilities caused by the installation or faulty performance of support of excavation system.

#### 1.05 PRODUCTS AND DESIGN CRITERIA

- A. The overall sheeting design, quality of materials and methods of installation for all sheeting applications necessary to accomplish the Work specified shall be consistent with the established standards of the construction industry and must, as a minimum, comply with the requirements for earth support systems for excavations as defined by current US Department of Labor, Occupational Safety and Health Act (OSHA) regulation applicable thereto, and any other federal, state and local agencies having jurisdiction and/or requirements pertaining thereto including Building Code requirements for the Commonwealth of Massachusetts. The design and implementation thereof shall be in accordance with sound engineering practice and modern accepted principles of soil mechanics and shall include the effects of hydrostatic forces and all surcharge loads which may be reasonably anticipated. The methods employed shall be to the extent necessary to permit the proper and satisfactory installation and construction of the Work specified; to withstand all loads and forces encountered; to provide soil restraint and control of water as required; to insure the safety of the workers and all other personnel on or near the site; to prevent injurious caving or erosion, or loss of ground; to maintain at all times proper and safe pedestrian, vehicular traffic on public and private streets, property and rights-of-way; and to stabilize unforeseen areas of work encountered during the execution of the Work as deemed necessary by the Owner and/or Engineer.
- B. The temporary shoring shall be designed in accordance with the 2017 American Association of State Highway and Transportation Officials LRFD Bridge Design Specifications (8th Edition). The temporary shoring design shall also include all

loads imposed by the temporary concrete barrier. Changes in the temporary shoring, subsequent to the Engineer review, shall be re-submitted to the Engineer for review prior to installation.

- C. The Contractor and Contractor's Engineer's attention is directed to the fact that should any additional investigations, subsurface explorations and/or other appurtenant information be required to fulfill the needs of this design, as determined by the Contractor's Engineer above and beyond that which is already provided under these Contract Documents, the Contractor shall obtain all such information and data required at his own expense.

#### 1.06 SHOP DRAWINGS AND/OR DESCRIPTIVE LITERATURE

- A. Submittals shall be provided in accordance with Specification Section 01300, SUBMITTALS. Construction shall not begin until submittal shop drawings are reviewed, evaluated and approved by the Engineer.

- B. Support of Excavation Submittals - The Contractor shall submit the following:

1. Provide shop drawings: A support of excavation system design prepared by and/or under the direct supervision of a qualified experienced and registered Professional Engineer in good standing with the Commonwealth of Massachusetts.

- i. Include plans, elevations, sections, and details.
- ii. Include complete and annotated calculations providing all necessary back-up information and technical references.
- iii. Show arrangement, locations, and complete design and construction details of sheeting, bracing, utility pipe penetrations, integration with the dewatering and instrumentation systems, and other components of support of excavation system. The Contractor shall utilize "zero-resonance" vibratory sheet pile driver(s) if used.
- iv. Indicate type and location of seepage mitigation components.
- v. Include a written plan for support of excavation system construction, including sequence of construction coordinated with the progress of excavation, construction dewatering, system movement monitoring and other instrumentation components.

2. Provide Contractor design calculations: For support of excavation system, provide complete and annotated calculations, analyses and other design information signed and sealed by a qualified registered Professional Engineer in good standing with the Commonwealth of Massachusetts responsible for their preparation. This submission will not relieve the Contractor of the sole responsibility for the adequacy of the system nor shall it be construed as an approval or guarantee that the Contractor's proposed equipment, materials and methods for the sheeting, bracing and/or appurtenances will be adequate for the Work required.

3. Survey Work: Engage and provide qualifications for the Professional Land Surveyor or Professional Engineer who are in good standing and registered in the Commonwealth of Massachusetts, who will survey the support of excavation structure, adjacent pump station, structures, utilities, manholes and other site improvements; establish exact elevations at fixed points to act as benchmarks, and clearly identify benchmarks and record existing elevations.

4. Qualifications: Contractor, Engineer and Land Surveyor: Qualifications shall be submitted to the Engineer for review and evaluation, which indicate that the Contractor, and the Contractor's design engineer and land surveyor have specialized in the design,

construction, monitoring and maintenance of similar support of excavation systems, as indicated on the project drawings and this specification, for a minimum of ten (10) years.

5. Provide Record Drawings: Identify locations and depths of active and capped utilities, abandoned-in-place utilities, support of excavation system, and other surface and subsurface structural and utility conditions.
6. Existing Utility Locations: After checking utility locations by field investigations, provide drawings to show the actual locations of utilities and excavation support system interference(s)/penetration(s) with proposed Work, and measures proposed to overcome such interferences.
7. Provide all materials - sizes and members, connections, means, methods and sequence of installation and removal, as required, for the support of excavation system.
8. Provide all details of support of excavation system structural connections to withstand loading and comply with project requirements. Welded connections shall comply with AWS D1.1/D1.1M for tolerances, appearances, welding procedures, weld quality and methods used in correction welding work.
9. Provide welder qualifications: provide qualifying procedures and personnel according to AWS D1.1/D1.1M "Structural Welding Code - Steel." Provide welder certifications.
10. Provide mill test reports for all structural steel including chemical and physical properties.
11. Provide means and method of preloading sheet pile bracing components.
12. Provide methods of resolving difficulties arising from misalignment of steel sheeting exposed during excavation, and criteria for implementing remedial procedures.
13. The excavation support design shall be coordinated with the dewatering system design that will be submitted to the Engineer under Specification Section 2140, DEWATERING. These submissions shall be made together in the same transmittal.

#### 1.07 CERTIFICATE OF DESIGN

The Contractor's attention is directed to the required "Certificate of Design", the form of which is provided at the end of this Section. The Contractor and Contractor's Engineer shall complete this "Certificate" in its entirety for each location of work to be done, and any revisions associated therewith, and submit it simultaneously with, as an integral part thereof, the sheeting submission. Any submission made without the completed "Certificate", appropriately signed and sealed, shall be returned to the Contractor. The Owner and/or Engineer hereby reserves the right to delay sheeting work and/or any work associated with, or dependent upon, the proper implementation of sheeting, without cause for claim against the Owner or Engineer, until a complete and appropriate submission is rendered. This Certification shall indicate that the sheeting, bracing and all appurtenances related thereto are designed to withstand the required loads, forces to be encountered, and to provide soil and water control, and are in compliance with these specifications and all federal, state or local agencies having jurisdiction over the Work to be performed.

## PART 2 PRODUCTS



## 2.01 MATERIALS

### A. Steel sheeting:

1. The steel sheeting shapes, sizes, and lengths to be utilized are optional for the Contractor's design, providing they are satisfactory to withstand all driving and construction stresses, shall remain viable for the duration of project use, are provided with continuous interlocks, meet all requirements of this specification, and are acceptable to the Engineer.

### B. Bracing, Hardware and Fastenings:

1. Steel bracing and other supports shall be of the strength and dimensions necessary to satisfactorily withstand the loads to which they will be subjected and shall be compatible in all aspects with the proposed excavation support sheeting. All bracing and other supports shall be free from any defects, which might impair this strength. The Contractor shall provide all necessary hardware and fastenings necessary in connections with satisfactory installation of all sheeting and bracing.

### C. All sheeting, bracing and other support of excavation material components shall be new.

## Part 3 EXECUTION

### 3.01 INSTALLATION

- A. The Contractor shall be fully responsible for ensuring adequate safety measures are provided at all times and shall comply with all safety requirements of federal, state and local agencies having jurisdiction over the Work. Installation of the sheeting including all bracing, supports, utility penetrations, tip points and sheet penetration into glacial till and/or bedrock to cut-off groundwater flow, and appurtenances, and shall be adequate to permit the performance of the Work and be in accordance with the requirements of the Contractor's Engineer's and the sheeting design and acceptable to the Engineer.
- B. Any movements of sheeting and/or appurtenances which prevent the proper completion of the work shall be corrected at the expense of the Contractor.
- C. Sheeting shall be installed in a manner which will prevent the disturbance of the surrounding surface, subsurface conditions, utilities and structures. Any such disturbances shall be corrected at the Contractor's expense and to the satisfaction of the Engineer.
- D. Limit vibrations, measured at existing utilities and at 50 feet from sheeting installation, to levels that do not exceed a peak particle velocity of 1.0 inch per second for impact event vibrations and 0.5 inch per second for continuous vibration events, and for threshold values as indicated in the Specification Section 02399 GEOTECHNICAL INSTRUMENTATION. The Contractor shall utilize "zero-resonance" vibratory sheet pile driver(s).
- E. The Contractor shall be responsible for maintaining the sheeting and bracing and shall take all precautions necessary to prevent movement/settlement of soil material along the sides of excavations, and to prevent the intrusion of groundwater beyond that which the dewatering system can control.
- F. It is expressly understood and agreed that whenever sheeting and bracing are used, it shall not relieve the Contractor of the sole responsibility for any damages, delays, or injury due to installation of the sheeting or bracing, or for the settling of any backfill; and adjacent: pipelines, manholes, pump station structure, pavements or grounds.

- G. Excavation to install internal bracing shall not extend more than two feet below any proposed brace level, before installing the brace.
- H. The Contractor shall use grout or other materials and/or methods to seal-off groundwater infiltrating into the excavation from around existing or proposed utility pipeline penetrations of the excavation support system, where they are encountered. The use of grout and/or other materials and methods of construction shall be such that they provide a positive groundwater cut-off.
- I. The Contractor shall monitor the performance/movement of the support of excavation system including: the horizontal and vertical support of excavation structure, adjacent building, pipelines, manholes and ground movement; and shall monitor excavation interior/exterior groundwater levels. If monitoring indicates excessive movement or groundwater level variation in according with specified threshold levels, the Engineer may direct the Contractor to modify the support of excavation design and/or construction method at no additional cost to the Owner. Refer to Specification Section 02399, GEOTECHNICAL INSTRUMENTATION. The Contractor may be required to add supplemental bracing or use other measures, as may be appropriate to the situation.
- J. The Contractor shall provide the Engineer access to systems monitoring instrumentation and maintain instrument monitoring locations free from damage.
- K. The Contractor shall install each sheet pile in plumb position interlocked with adjoining sheet piles for its entire length to form a continuous diaphragm throughout the length of each wall segment, tight against adjacent surrounding ground and extending into the glacial till or bedrock strata to cut-off groundwater flow into the excavation. The sheeting installation equipment, methods of installation, and removal shall conform to the project drawings, specifications and/or Engineer approved Contractor submittals
- L. Do not drive sheet piling within 100 feet of concrete less than 7 days old.
- M. The Contractor shall drive sheeting to the required depths to satisfy structural requirements and provide groundwater cutoff. Do not overdrive sheeting to cause damage to sheet pile tips or interlocks. The Contractor shall employ sheet pile “points” to mitigate sheet damage. Sheet pile shall be embedded sufficiently into the glacial till and/or bedrock stratum to cut-off groundwater flow into the excavation and minimize groundwater drawdown outside of the excavation to less than 5 feet from initial recorded groundwater levels.
- N. Sheet pile shall be installed in a manner to minimize seepage through the interlocking joints. Areas where excessive interlock seepage is observed shall be packed with oakum, grout, proprietary sheet pile interlock sealant, lagging or other product(s) proposed by the Contractor for Engineer evaluation or as directed by the Engineer.
- O. Sheeting, after installation, shall be in direct contact with the earth to be retained.
- P. Use wales and braces to provide internal system support. There shall be tight contact/bearing between wales, braces and sheet pile walls. There shall be ample bearing surface between support of excavation components using steel shims or other methods to make load transfer adjustments.
- Q. Install and maintain internal bracing support members in tight contact with each other and with the sheeting being supported. Attach braces to wales using direct connections, shimmed as needed.
- R. Support of Excavation System Preloading:

1. Preload internal bracing members to a suggested 50 percent  $\pm$  of the design compression load occurring during maximum excavation.
  2. Use procedures that produce uniform loading on bracing members without inducing appreciable eccentricities, overstressing or distortion.
  3. Make provisions for permanently fixing each member with steel shims or wedges welded into place.
  4. Accomplish preloading by jacking supports in-place against sheeting and/or wales.
  5. Do not use wooden wedges or components to preload bracing members.
  6. Include in the preloading system means to determine, within 5%  $\pm$ , the amount of preload induced into bracing members.
- S. Excavate below support of excavation brace level to allow brace installation(s). Install bracing, and preload immediately after installation and before continuing excavation.
- T. Protection: Protect structures, utilities and other facilities from damage caused by settlement, lateral movement, undermining, washout, and other hazards that could develop during support of excavation system operations.
4. Shore, support, and protect adjacent and encountered utilities.
- U. Site access/egress: Install support of excavation system to ensure minimum interference with roads, streets, walks, and other adjacent occupied and used facilities, e.g. existing WWTF operations.
1. Do not close or obstruct streets, walks, or other adjacent occupied or used facilities without permission from the Engineer and authorities having jurisdiction. Provide alternate routes around closed or obstructed traffic patterns if required by authorities having jurisdiction.
- V. Locate support of excavation system clear of permanent construction to avoid damage and so that construction and finishing of other work is not impeded.
- W. Tiebacks, if used:
1. Drill, install, grout, and tension tiebacks.
  2. Test load-carrying capacity of each tieback and replace and retest deficient tiebacks. Have test loading observed by a qualified registered Professional Engineer in good standing with the Commonwealth of Massachusetts responsible for the design of support of excavation system. Utilize the Post-Tensioning Institute's, "Recommendations for Prestressed Rock and Soil Anchors," latest edition as a tieback design, construction and testing guide.
  3. Maintain tiebacks in place until permanent construction is able to resist lateral earth, hydrostatic and surcharge pressures. Abandon tiebacks per industry standard procedures and as directed by the Engineer when no longer needed.

X. Bracing:

1. Locate bracing to clear columns, floor framing construction, and other permanent work. If necessary to move brace, install new bracing before removing original brace.
2. Do not place bracing where it will be cast into or included in permanent concrete work, unless otherwise approved by the Engineer.
3. Install internal bracing as required to prevent spreading or distortion of braced frames.
4. Maintain bracing until structural elements are supported by other bracing or until permanent construction is able to withstand lateral earth, hydrostatic and surcharge pressures.

3.02. ALLOWABLE STRUCTURE AND GROUND DEFORMATIONS

- A. Perform support of excavation monitoring in accordance with Specification Section 02399, GEOTECHNICAL INSTRUMENTATION.
- B. Monitoring Personnel shall define and use a procedure for reading and recording geotechnical instrumentation data, which compares the current readings to initial readings and to the last several readings taken. The procedure shall comply with Specification Section 02399, GEOTECHNICAL INSTRUMENTATION.
- C. Data gathering, reduction, processing, plotting, interpreting and reporting shall be in accordance with Specification Section 02399, GEOTECHNICAL INSTRUMENTATION.

3.03. MAINTENANCE OF SUPPORT OF EXCAVATION SYSTEM

- A. Maintain a sufficient quantity of support of excavation system components on hand throughout the conduct of the Work, including wales, bracing, sheets, shims and other system components for protection of the Work, personnel and for use in case of accident, emergency or required structure modification.
- B. Seal surface and groundwater leaks greater than approximately 2 gpm  $\pm$  or as directed by the Engineer, which are observed in the sheet pile walls as the excavation progresses.
- C. Inform the Engineer in writing of any changes made to the support of excavation, dewatering and/or monitoring systems to accommodate field conditions

3.04 REMOVAL

- A. No sheeting shall be removed except with specific written direction by the Engineer.
- B. Sheeting shall be cut-off six (6) feet below grade level, or as directed by the Engineer.
- C. Do not disturb or damage adjacent structures, new construction, or utilities during removal. Fill voids immediately with lean concrete or with backfill compacted to the density as specified in Specification Section 02200, EARTHWORK. Cut-off and removal of sheets may include

bracing components, per Engineer direction. Repair or replace, adjacent work damaged or displaced by removing support of excavation system.

- D. All sheeting cut-off materials shall become the property of the Contractor and shall be removed from the worksite immediately.
- E. All restoration and clean-up shall be as indicated, specified and/or directed by the Engineer.

**END OF SECTION**

**CERTIFICATE OF DESIGN**

\_\_\_\_\_ (Owner)

Contract Reference: \_\_\_\_\_

\_\_\_\_\_, dated

\_\_\_\_\_.

In accordance with the provisions of the above referenced Contract, as the designated Contractor,

\_\_\_\_\_

\_\_\_\_\_ (Contractor's Name and Address)

hereby certifies that \_\_\_\_\_

\_\_\_\_\_ (Contractor's Engineer's Name and Address)

(1) Is properly licensed and currently registered as a Professional Engineer in the Commonwealth of \_\_\_\_\_;

(2) Is fully qualified to design and supervise the \_\_\_\_\_

\_\_\_\_\_ (Item of work and location)

In accordance with the provision specified under the appropriate Section and/or Subsections of the Contract Documents:

(3) Has successfully designed and supervised \_\_\_\_\_

\_\_\_\_\_ (Item of work)

before and demonstrates a minimum of ten (10) documented years of proven experience in such field;

(4) Has personally examined the type(s) and locations(s) of the Work required under this Contract, and the overall conditions associated therewith, to the extent necessary to fully satisfy his or her professional responsibilities for designing and supervising the above referenced work;

- (5) Has prepared the attached design in full compliance with the applications and requirements of the Contract Documents, sound engineering practice, modern accepted principles of construction, and all applicable federal, state and local laws, regulations, rules and codes having jurisdiction over the Work;
- (6) Will provide sufficient supervision and technical guidance to the Contractor throughout the Work to ensure compliance with the design and all quality assurances necessary to successfully complete the Work;
- (7) Hereby indemnifies and holds harmless the \_\_\_\_\_  
 \_\_\_\_\_ and BETA Group, Inc.,  
 (name of owner)  
 and their agents, employees and representatives, from and against any and all claims, whether directly or indirectly, arising out of, relating to or in connection with the Work; and
- (8) This "Certificate of Design" together with all applicable designs, drawings, details, specifications on other related documents necessary to complete the Work as specified, have been signed and sealed pursuant to applicable state law.

In recognition and observance of the above referenced statements, the undersigned parties hereby acknowledge and accept the responsibilities and obligations associated therewith.

CONTRACTOR:

CONTRACTOR'S ENGINEER:

\_\_\_\_\_  
(Contractor's Name)

\_\_\_\_\_  
(Engineer's Name)

By: \_\_\_\_\_

By: \_\_\_\_\_

\_\_\_\_\_  
(Name and Title)

\_\_\_\_\_  
(Name and Title)

Date: \_\_\_\_\_

Date: \_\_\_\_\_

(SEAL)

(P.E. STAMP)

(Note: Contractor to fully reference all attachments below)

---

---

---

---

---

---

---

---

---

---

---

---

---

---

---

---

---

---

---

---

---

---

---

---

**END OF SECTION**



## SECTION 02200

### EARTH EXCAVATION, BACKFILL, FILL AND GRADING

#### PART 1 GENERAL

##### 1.01 SUMMARY

###### A. Section Includes

1. Requirements for; excavating in earth for trenches and structures; backfilling excavations; furnishing necessary material; compaction; constructing embankments and fills; miscellaneous earth excavations and miscellaneous grading.

###### B. Related Sections

1. Section 01410 - Testing Laboratory Services
2. Section 02140 – Dewatering
3. Section 01810 – Maintenance of Plant Operation and Sequence of Construction
4. Section 02215 - Aggregate Materials
5. Section 03300 - Cast-In-Place Concrete

##### 1.02 REFERENCES

###### A. American Society for Testing and Materials (ASTM).

1. D1557, Standard Test Methods for Laboratory Compaction Characteristics of Soil Using Modified Effort (56,000 ft-lbf/ft<sup>3</sup> (2,700 kN-m/m<sup>3</sup>)).

##### 1.03 QUALITY ASSURANCE

###### A. Field Samples

1. Provide samples of materials as requested by the Engineer, to the Quality Control Engineer hired by the Owner, prior to delivery of materials on site, in order to facilitate field testing of compaction operations and material properties.

##### 1.04 PROJECT/SITE CONDITIONS

###### A. Existing Conditions

1. There are pipes, drains, and other utilities in locations not indicated on drawings, no attempt has been made to show all services, and completeness or accuracy of information given is not guaranteed.

##### 1.05 MAINTENANCE

###### A. Maintain all work in accordance with SECTION 01800.

## PART 2 PRODUCTS

### 2.01 MATERIALS

#### A. Suitable Aggregate

1. The nature of materials will govern both acceptability for backfill and methods best suited for placement and compaction.
2. All material whether from excavations or from borrow pits, after being placed and properly compact, will make a dense stable fill and containing no vegetation, masses of roots, individual roots more than 18 inches long, or more than 1/2 inch in diameter, stones over 6 inches in diameter, or porous matter.
3. Organic matter to be well distributed and not to exceed minor quantities.

#### B. Trench and Excavation Backfill

1. In general, and unless other material is indicated on drawings or specified, material used for backfilling trenches and excavations shall be suitable material which was removed in the course of making the construction excavations. If sufficient suitable material is not available from the excavations, the backfill material shall be crushed stone, gravel borrow or select borrow as directed by the Engineer, in accordance to respective Specification Sections.
2. See Section 2.01.C for excavation backfill requirements under and adjacent to foundation walls.

#### C. Structure Backfill

1. Unless otherwise indicated or specified, all fill and backfill under and adjacent to structures, foundations walls, and pavement adjacent to structures shall be gravel borrow that consist of inert material that is hard, durable stone and coarse sand, free of loam and clay, surface coatings, and deleterious materials. Gradation requirements for backfill gravel shall be in accordance with SECTION 02215.
2. Excavated material shall not be permitted for backfill below structures or foundation walls.

#### D. Filling and Embankment Backfill

1. Suitable selected materials available from the excavations and not required for backfill around pipes or against structures may be used for filling and building embankments, except as otherwise specified. Material needed in addition to that available from construction operations shall be obtained from suitable gravel banks or other suitable deposits. The Contractor shall furnish, at his own expense, all borrow material needed on the work.

#### E. Additional materials

1. Concrete: In accordance with SECTION 03300.
2. Crushed stone: In accordance with SECTION 02215.
3. Gravel borrow: In accordance with SECTION 02215.
4. Select borrow: In accordance with SECTION 02215.

## 2.02 EQUIPMENT

### A. Well Points

1. Designed to drain soil and prevent saturated soil from flowing into excavation.

### B. Pumping Units

1. Designed for use with the wellpoints, capable of maintaining a high vacuum and, handling large volumes of air and water at the same time.

### C. Underdrain Pipe

1. HDPE pipe enclosed in crushed stone encased in filter fabric.
2. Sewer pipe of quality known as "seconds".

## 2.03 SOURCE QUALITY CONTROL

- A. Provide Engineer with access to location of off site sources of materials.

## PART 3 EXECUTION

### 3.01 EXAMINATION

- A. Verify all existing utilities and facilities prior to excavation.

### 3.02 PROTECTION

#### A. Utilities

1. Support and protect from damage existing pipes, poles, wires, fences, curbing, property line markers, and other structures, which the Engineer decides must be preserved in place without being temporarily or permanently relocated.
2. Restore items damaged during construction without compensation, to a condition at least equal prior to construction.

#### B. Trees

1. Enclose the trunks of trees adjacent to work with substantial wooden boxes of height necessary to protect trees from injury from piled material, equipment, operations or otherwise.
2. Employ excavating machinery and cranes of suitable type and size and operate with care to prevent injury to trees not to be cut and particularly to overhanging branches and limbs.
3. When trimming is required, make all cuts smooth and neat without splitting or crushing.
4. Cover cut areas with an application of grafting wax or tree healing paint.
5. Branches, limbs, and roots shall not be cut except by permission of the Engineer.

#### C. Plantings

1. Protect by suitable means or temporarily replant and maintain cultivated hedges, shrubs, and plants which may be injured by the Contractor's operations
2. Replant in their original positions and care for until growth is re-established, once the construction operations have been substantially completed.

3. If cultivated hedges, shrubs, and plants are injured to such a degree as to affect their growth or diminish their beauty or usefulness, they shall be replaced by items of kind and quality at least equal to which existed prior to the start of the Work.

D. Paved surfaces

1. Do not use or operate tractors, bulldozers, or other power-operated equipment with treads or wheels shaped as to cut or injure paved surfaces.
2. All surfaces which have been injured by the Contractor's operations shall be restored to a condition at least equal to which existed prior to start of the Work.
3. Suitable materials and methods shall be used for such restoration.

3.03 PREPARATION

A. Pavement Removal

1. Remove only existing pavement as necessary for the prosecution of the work.
2. Engineer may require that pavement be cut with pneumatic tools or saws without extra compensation to Contractor, where in the opinion of the Engineer it is necessary to prevent damage to the remaining road surface.
3. Dispose large of pieces of broken pavement before proceeding with excavation.

B. Top Soil Removal

1. From areas which excavations are to be made, loam and topsoil shall be carefully removed and separately stored to be used again as directed; or, if the Contractor prefers not to separate surface materials, he shall furnish, as directed, loam and topsoil at least equal in quantity and quality to that excavated.

C. Subgrade

1. Remove loam and topsoil, loose vegetable matter, stumps, large roots, etc., from areas where embankments will be built or material will be placed for grading.
2. Shape as indicated on the drawings and prepare by forking, furrowing, or plowing to bond first layer of the new material placed.

3.04 RELOCATION AND REPLACEMENT OF EXISTING STRUCTURES

A. The structures to which the provisions of this article apply include pipes, wires, and other structures which meet all of the following:

1. Are not indicated on the drawings or otherwise provided for.
2. Encroach upon or are encountered near and substantially parallel to the edge of the excavation.
3. In the opinion of the Engineer will impede progress to such an extent that satisfactory construction cannot proceed until they have been changed in location, removed (to be later restored), or replaced.

B. In removing existing pipes or other structures, the Contractor should use care to avoid damage to materials, and the Engineer shall include for payment only those new materials which, in his judgment, are necessary to replace those unavoidably damaged.

C. Whenever the Contractor encounters certain existing structures as described above and is so ordered in writing, he shall do the whole or such portions of the work as he may be directed to change the location of, remove and later restore, or replace such structures, or to assist the

Owner thereof in so doing. For all such work, the Contractor shall be paid under such items of work as may be applicable, otherwise as Extra Work.

- D. When fences interfere with the Contractor's operations, he shall remove and (unless otherwise specified) later restore them to a condition which existed prior to the start of the Work, all without additional compensation. The restoration of fences shall be done as promptly as possible and not left until the end of the construction period.

### 3.05 SHEETING AND BRACING

- A. Provide in accordance with Specification Section 02160.

### 3.06 DEWATERING

- A. Provide in accordance with Specification Section 02140.

### 3.07 EXCAVATION

- A. Execute operation of dewatering, sheeting and bracing without undermining or disturbing foundations of existing structures or of work previously completed under this contract.
- B. Excavate to widths that provide suitable room for:
  - 1. Building structures or laying and jointing piping.
  - 2. Placing all sheeting, bracing, and supports.
  - 3. Cofferdamming, pumping and draining.
- C. Render bottom of excavations firm, dry and acceptable in all respects.
- D. Do not plow, scrap or dig by machinery, earth at finished subgrade which results in disturbance of material below subgrade, unless indicated or specified, and remove with pick and shovel, last of material to be excavated, just before placing pipe, masonry or other structure.
- E. Make all excavations in open, except as otherwise specified or permitted.
- F. Excavation Near Existing Facilities
  - 1. As the excavation approaches pipes, conduits, or other underground structures, digging by machinery shall be discontinued and the excavation shall be done by means of hand tools. Such manual excavation when incidental to normal excavation shall be included in the work to be done under items involving normal excavation.
- G. Unauthorized Excavation
  - 1. If the bottom of any excavation is taken out beyond the limits indicated or prescribed, the resulting void shall be backfilled at the Contractor's expense with thoroughly compacted gravel borrow, if the excavation was for a pipeline, or with Class B concrete, if the excavation was for a masonry structure.
- H. Unsuitable Material

1. If material unsuitable for foundation (in the opinion of the Engineer) is found at or below the grade to which excavation would normally be carried in accordance with the Drawings and/or Specifications, the Contractor shall remove such material to the required width and depth and replace it with thoroughly compacted, crushed stone, gravel borrow, fine aggregate or concrete as directed.

### 3.08 TRENCHING

#### A. Trench Excavation

1. Where pipe is to be laid in specified bedding material or concrete cradle, the trench may be excavated by machinery to, or to just below, the designated subgrade, provided that the material remaining at the bottom of the trench is no more than slightly disturbed.
2. Where pipe is to be laid directly on the trench bottom, the lower part of trenches in earth shall not be excavated to subgrade by machinery, but, just before the pipe is to be placed, the last of the material to be excavated shall be removed by means of hand tools to form a flat or shaped bottom, true to grade, so that the pipe will have a uniform and continuous bearing and support on firm and undisturbed material between joints except for limited areas where the use of pipe slings may have disturbed the bottom.

#### B. Depth Of Trench

1. Excavate trench to depths permitting the pipe to be laid at the elevations, slopes, or depths of cover indicated on the drawings, and at uniform slopes between indicated elevations.

#### C. Width Of Trench

1. Excavate trench as narrow as practicable and do not widen by scraping or loosening materials from the sides. Every effort shall be made to keep the sides of the trenches firm and undisturbed until backfilling has been completed and consolidated.
2. Excavate trenches with approximately vertical sides between the elevation of the center of the pipe and an elevation 1 ft. above the top of the pipe.

#### D. Trench Excavation In Fill

1. If pipe is to be laid in embankments or other recently filled material, the material shall first be placed to the top of the fill or to a height of at least 1 ft. above the top of the pipe, whichever is the lesser. Particular care shall be taken to ensure maximum consolidation of material under the pipe location. The pipe trench shall then be excavated as though in undisturbed material.

- E. Length of trench open at any one time will be controlled by conditions, subject to any limits that may be prescribed by Engineer.

### 3.09 BACKFILLING

#### A. General

1. Frozen material shall not be placed in the backfill nor shall backfill be placed upon frozen material. Previously frozen material shall be removed or shall be otherwise treated as required, before new backfill is placed.

#### B. Fill And Backfill Under Structures

1. The fill and backfill materials shall be placed in layers not exceeding 6 in. in thickness. Unless otherwise indicated or specified, each layer shall be compacted to 95 percent in accordance with ASTM D1557.

#### C. Backfilling Around Structures

1. Do not place backfill against or on structures until they have attained sufficient strength to support the loads (including construction loads) to which they will be subjected, without distortion, cracking, or other damage. As soon as practicable after the structures are structurally adequate and other necessary work has been done, special leakage tests, if required, shall be made. Promptly after the completion of such tests, the backfilling shall be started and then shall proceed until its completion. Unequal soil pressures shall be avoided by depositing the material evenly around the structure.
2. The material shall be placed and compacted to 90 percent in accordance with ASTM D1557 unless otherwise indicated or specified.

#### D. Backfilling Pipe Trenches

1. As soon as practicable after the pipes have been laid and the joints have acquired a suitable degree of hardness, if applicable, or the structures have been built and are structurally adequate to support the loads, including construction loads to which they will be subjected, the backfilling shall be started and thereafter it shall proceed until its completion.
2. With the exception mentioned below in this paragraph, trenches shall not be backfilled at pipe joints until after that section of the pipeline has successfully passed any specified tests required. Should the Contractor wish to minimize the maintenance of lights and barricades and the obstruction of traffic, he may, at his own risk backfill the entire trench, omitting or including backfill at joints as soon as practicable after the joints have acquired a suitable degree of hardness, if applicable, and the related structures have acquired a suitable degree of strength. He shall, however, be responsible for removing and later replacing such backfill, at his own expense, should he be ordered to do so in order to locate and repair or replace leaking or defective joints or pipe.
3. No stone or rock fragment larger than 12 in. in greatest dimension shall be placed in the backfill nor shall large masses of backfill material be dropped into the trench in such a manner as to endanger the pipeline. If necessary, a timber grillage shall be used to break the fall of material dropped from a height of more than 5 ft. Pieces of bituminous pavement shall be excluded from the backfill unless their use is expressly permitted, in which case they shall be broken up as directed.
4. Zone Around Pipe
  - a. Backfilled with the materials and to the limits indicated on the drawings.
  - b. Material shall be compacted to 90 percent by tamping.
5. Remainder of Trench
  - a. Compact by water-jetting, or tamping, in accordance with the nature of the material to 95 percent in accordance with ASTM D1557. Water-jetting may be used wherever the material does not contain so much clay or loam as to delay or prevent satisfactory drainage. However, tamping shall be used if water-jetting does not compact the material to the density required.
6. Excavated material which is acceptable to the Engineer for surfacing or pavement subbase shall be placed at the top of the backfill to such depths as may be specified elsewhere or as directed. The surface shall be brought to the required grade and stones raked out and removed.

#### E. Placing And Compacting Embankment Material

1. After the subgrade has been prepared as hereinbefore specified, the material shall be placed thereon and built up in successive layers until it has reached the required elevation.
2. Layers shall not exceed 12 in. in thickness before compaction. In embankments at structures, the layers shall have a slight downward slope away from the structure; in other embankments the layers shall have a slight downward slope away from the center. In general, the finer and less pervious materials shall be placed against the structures or in the center, and the coarser and more pervious materials, upon the outer parts of embankments.
3. Each layer of material shall be compacted by the use of approved rollers or other approved means so as to secure a dense, stable, and thoroughly compacted mass. At such points as cannot be reached by mobile mechanical equipment, the materials shall be thoroughly compacted by the use of suitable power-driven tampers.
4. Previously placed or new materials shall be moistened by sprinkling, if required, to ensure proper bond and compaction. No compacting shall be done when the material is too wet, from either rain or too great an application of water, to compact it properly; at such times the work shall be suspended until the previously placed and new materials have dried out sufficiently to permit proper compaction, or such other precautions shall be taken as may be necessary to obtain proper compaction.
5. The portion of embankments constructed below proposed structures shall be compacted to 95 percent in accordance with ASTM D1557. The top 2 ft. of an embankment below a pavement base shall be compacted to 95 percent. All other embankments shall be compacted to 90 percent in accordance with ASTM D1557.

### 3.10 METHODS OF COMPACTION

#### A. Water-Jetting

1. Saturate backfill material throughout its full depth and at frequent intervals across and along the trench until all slumping ceases.
2. Furnish one or more jet pipes, each of sufficient length to reach the specified depth and of sufficient diameter (not less than 1-1/4 in.) to supply an adequate flow of water to compact the material.
3. Equip jet pipe with a quick-acting valve, supply water through a fire hose from a hydrant or a pump having adequate pressure and capacity to achieve the required results.

#### B. Tamping and Rolling

1. Deposit backfill material and spread in uniform, parallel layers not exceeding 12 in. thick before compaction. Before the next layer is placed, each layer shall be tamped to obtain a thoroughly compacted mass. Care shall be taken that the material close to the bank, as well as in all other portions of the trench, is thoroughly compacted. When the trench width and the depth to which backfill has been placed are sufficient to make it feasible, and it can be done effectively and without damage to the pipe, backfill may, on approval, be compacted by the use of suitable rollers, tractors, or similar power equipment instead of by tamping. For compaction by tamping (or rolling), the rate at which backfilling material is deposited in the trench shall not exceed that permitted by the facilities for its spreading, leveling, and compacting.
2. If necessary to ensure proper compaction by tamping (or rolling), the backfill material shall first be wet by sprinkling. However, no compaction by tamping (or rolling) shall be done when the material is too wet either from rain or too great an application of water to



be compacted properly; at such times the work shall be suspended until the previously placed and new materials have dried out sufficiently to permit proper compacting, or such other precautions shall be taken as may be necessary to obtain proper compaction.

C. Miscellaneous Requirements.

1. Whatever method of compacting backfill is used, care shall be taken that stones and lumps shall not become nested and that all voids between stones shall be completely filled with fine material. Only suitable quantities of stones and rock fragments shall be used in the backfill; the Contractor shall, as part of the work done under the items involving earth excavation and rock excavation as appropriate, furnish and place all other necessary backfill material.
2. All voids left by the removal of sheeting shall be completely backfilled with suitable materials, and thoroughly compacted.

3.11 DISPOSAL OF SURPLUS EXCAVATED MATERIALS

- A. No excavated materials shall be removed from the site of the work or disposed of by the Contractor except as directed or permitted by the Engineer.
- B. Surplus excavated materials suitable for backfill shall be used to backfill normal excavations in rock or to replace other materials unacceptable for use as backfill; shall be neatly deposited and graded so as to make or widen fills, flatten side slopes, or fill depressions; or shall be neatly deposited for other purposes within a haul of 1 mile from the point of excavation; all as directed or permitted and without additional compensation.
- C. Surplus excavated materials not needed as specified above shall be hauled away and dumped by the Contractor, at his expense, at appropriate locations, and in accordance with arrangements made by him.

3.12 DISPOSAL OF SPECIAL WASTES

- A. The Contractor's attention is directed to the requirements set forth by the State of Massachusetts, Department of Environmental Protection, (MA DEP) regarding "Special Wastes" and the proper disposal thereof. All waste materials and debris, as designated by the Owner and/or Engineer, including but not limited to any sewers, storm drains, catchbasins, and combined system pipelines and associated structures, or any portions thereof, including but not limited to sludge, grit, sediment, dirt, sand, rock, grease, roots and other liquid, solid or semi-solid materials contained therein, shall be considered "Special Wastes." In addition, any excavated soils contaminated in any manner, as designated by the Owner and/or Engineer, shall also fall under this category and shall be handled the same. When so encountered, all such materials and debris shall be removed to the extent so ordered by the Engineer and properly disposed of in strict compliance with the requirements of the MA DEP and other regulating authorities to an approved and certified waste disposal site. It shall remain the sole responsibility of the Contractor to apply for and obtain all required permits, bonds and/or insurance relative to such disposal. The Contractor shall also pay all costs associated with the disposal, required permits, bonds and insurance with no additional expense to the Owner. All handling of such "Special Waste" shall be done in strict compliance with the MA DEP requirements and/or any other federal, state or local agency having jurisdiction or authority over the same. Under no circumstances shall sewage, solids or other "Special Wastes" removed from the sewer lines be dumped or spilled onto the streets

or into ditches, catch basins or storm drains. The Contractor must use watertight and State approved vehicles in transporting any wastes as hereinbefore designated.

- B. The Contractor shall indemnify and save harmless the Owner and Engineer and all persons acting for or on behalf of the Owner and Engineer from all claims and liability of any nature or kind, and all damages, costs and expenses, including attorney's fees and penalties, arising from the improper handling, transportation or disposal of "Special Wastes" as determined by the MA DEP and/or any other federal, state or local agency having jurisdiction or authority over the same.

### 3.13 DUST CONTROL

- A. During the progress of the Work, maintain the area of activities, by sweeping and sprinkling of streets to minimize the creation and dispersion of dust. If the Engineer decides that it is necessary to use calcium chloride for more effective dust control, the Contractor shall furnish and spread the material, as directed.

### 3.14 BRIDGING TRENCHES

- A. Provide suitable and safe bridges and other crossings where required for the accommodation of travel, and to provide access to private property during construction. Remove once bridges and crossings are no longer needed.

### 3.15 FIELD QUALITY CONTROL

- A. Site Tests

- 1. In accordance with SECTION 01410

### 3.16 CARE AND RESTORATION OF PROPERTY

- A. Restoration of existing property or structures done as promptly as practicable and not left until the end of the construction period.

END OF SECTION

## SECTION 02215

### AGGREGATE MATERIALS

#### PART 1 GENERAL

##### 1.01 SUMMARY

###### A. Section Includes

1. Requirements for furnishing and placing materials, which include Crushed Stone, Gravel Borrow and Select Borrow.
2. Location of specified materials as detailed on the Drawings or as directed by the Engineer for excavation below normal depth, utility support, replacement of unsuitable material or elsewhere, as ordered.

###### B. Related Sections

1. Section 02200 - Earth Excavation, Backfill, Fill and Grading.
2. Section 02500 – Paving
3. Section 02220 – Riprap

##### 1.02 REFERENCES

###### A. American Association of State Highway and Transportation Officials (AASHTO).

1. T11, Amount of Material Finer than 0.075 mm Sieve in Aggregate
2. T27, Sieve Analysis of Fine and Coarse Aggregates.

###### B. American Society for Testing and Materials (ASTM).

1. D1557, Standard Test Methods for Laboratory Compaction Characteristics of Soil Using Modified Effort (56,000 ft-lbf/ft<sup>3</sup> (2,700 kN-m/m<sup>3</sup>)).

##### 1.03 DEFINITIONS

A. The term Screened Gravel as used in the Contract Documents shall mean Crushed Stone.

B. The term Structural Fill as used in the Contract Documents shall mean Gravel Borrow.

##### 1.04 SUBMITTALS

###### A. Shop Drawings

1. Provide sieve analysis when gradation requirements are given in the Specification.

###### B. Samples

1. Furnish representative sample including location of source with Shop Drawing transmittal sheet.

##### 1.05 QUALITY ASSURANCE

###### A. Field Samples

1. The attention of the Contractor is directed to the fact that under Specification SECTION 00700, 1.03 Materials and Equipment, all materials furnished by the Contractor to be incorporated into the Work shall be subject to the inspection of the Engineer. The Engineer shall be the sole judge as to the acceptability of proposed materials and said judgement shall be final, conclusive, and binding.

1.06 DELIVERY, STORAGE, AND HANDLING

A. Storage and Protection

1. In accordance with Specification SECTION 00700, 1.03 Materials and Equipment.

PART 2 PRODUCTS

2.01 MATERIALS

A. Crushed Stone

1. For bedding and pipe zone material for pipe larger than 3 inches diameter. Well graded in size from 3/8 inches to 3/4 inches or such other sizes as may be approved.
2. For bedding and pipe zone material for plastic pipe 3 inches diameter and less, maximum particle size shall be 3/8 inches.
3. Clean, hard, and durable particles or fragments, free from dirt, vegetation, or other objectionable matter, and free from an excess of soft, thin elongated, laminated or disintegrated pieces.
4. Screened Stone of similar size and grading to this specification may be used instead of Crushed Stone.

B. Gravel Borrow

1. Granular material well graded from fine to coarse with a maximum size of 3 inches, obtained from approved natural deposits and unprocessed except for the removal of unacceptable material and stones larger than the maximum size permitted.
2. Gravel shall not contain vegetation, masses of roots, or individual roots more than 18 inches long or more than 1/2 inches in diameter.
3. Gravel shall be substantially free from loam and other organic matter, clay and other fine or harmful substances.
4. Gradation requirements for gravel shall be determined by AASHTO-T11 and T27 and conform to the following:

<u>Sieve</u>	<u>Percent Passing</u>
1/2 inch	60-95
No. 4	50-85
No. 50	8-28
No. 200	0-8

C. Select Borrow

1. Use inorganic natural soils and/or rock, having not more than 8 percent by weight passing the No. 200 sieve and having a maximum stone size no greater than 6-inches.
2. Use only material well-graded throughout entire size range, free of roots, leaves and other organic material, ice or frost and aggregations of frozen soil particles.

3. Moisture content to be within plus minus 3 percent optimum at the borrow source.
4. Material must meet compaction requirements indicated or as specified.

D. Gravel Base Course

1. In accordance with SECTION 02500.

2.02 SOURCE QUALITY CONTROL

A. Test, Inspection

1. Engineer may elect to sample material supplied at the source.
2. Assist the Engineer and/or personnel from the designated testing laboratory in obtaining samples.

PART 3 EXECUTION

3.01 INSTALLATION

A. Crushed Stone

1. Spread in layers of uniform thickness not greater than 6 inches.
2. Compact thoroughly by means of a suitable vibrator or mechanical tamper.

B. Gravel Borrow

1. Spread in layers of uniform thickness not exceeding 12 inches before compaction and moistened or allowed to dry as directed.
2. Compact thoroughly by means of suitable power-driven tampers or other power-driven equipment.
3. Compaction shall conform to 95% of minimum dry density per ASTM D1557.
4. The percolation rate for the compacted bank-run gravel shall not exceed 5 minutes per inch.

C. Select Borrow

1. Spread in layers of uniform thickness not exceeding 12 in. (loose lift) before compaction and moistened or allowed to dry.
2. Compact thoroughly by means of suitable power-driven tampers or other power-driven equipment unless otherwise directed by the Engineer.

3.02 FIELD QUALITY CONTROL

A. Material and compaction testing

1. In accordance with SECTION 01410.

END OF SECTION

## SECTION 02224

### CONTROLLED DENSITY FILL (MASSACHUSETTS)

#### PART 1 GENERAL

##### 1.01 SUMMARY

###### A. Section Includes

1. Requirements for controlled density fill (CDF) to be used in place of compacted soil for general backfill of trenches and/or excavations.

##### 1.02 REFERENCES

###### A. American Association of State Highway and Transportation Officials (AASHTO)

1. AASHTO M 85 - Standard Specification for Portland Cement (Chemical and Physical)
2. AASHTO M 295, Class F - Standard Specification for Coal Fly Ash and Raw or Calcined Natural Pozzolan for Use in Concrete

###### B. This specification makes reference to the requirements of additional specifications as listed. The Contractor shall obtain and familiarize himself with all requirements referenced by this specification prior to preparation and installation of any materials.

1. Massachusetts Department of Transportation Highway Division (massDOT), Standard Specifications for Highways and Bridges, 1988 Edition, including all addenda, issued by the State of Massachusetts Department of Transportation, (referred to as the Standard Specification).

##### 1.03 DEFINITIONS

###### A. Controlled Density Fill, also known as "Flowable Fill" is a flowable, self-consolidating, rigid setting, low density material that can substitute for compacted gravel in backfills, fills and structural fills.

###### B. The two main categories of CDF's are Excavatable and Non-excavatable, with sub categories of flowable and very flowable.

###### C. Categories of CDF's:

1. Type 1            Very Flowable, non excavatable,
2. Type 1E        Very Flowable, excavatable,
3. Type 2           Flowable, non excavatable,
4. Type 2E        Flowable, excavatable.

###### D. Excavatable mixes shall be hand tool excavatable.

###### E. Very Flowable shall have very flowable characteristics for distances and small hard to reach areas.

#### 1.04 DESIGN REQUIREMENTS

- A. Provide a mixture of Portland cement, aggregates, water and mineral admixtures with a low cement content and high slump to reduce strength development for possible removal and minimize settlement after placement.
- B. The proposed mix should maximize the flow characteristics of the material while producing the necessary strength.
- C. The mixes shall have the following design strengths:
  - 1. Non excavatable fill,
    - a. Type I (very flowable) and Type 2 (flowable),
    - b. Compressive strength at 28 days = 30 to 150 psi, 200 psi maximum at 90 days.
  - 2. Excavatable fill,
    - a. Type 1E (very flowable) and Type 2E (flowable),
    - b. Compressive strength at 28 days = 30 to 80 psi, 100 psi maximum at 90 days.
- D. Specific compressive strength(s) for structural applications are noted on the Contract Drawings.
- E. Slump
  - 1. Standard method = 10 to 12-inches.
  - 2. Modified method consisting of a six inch long by three inch inside diameter straight tube of non-porous material = 9 to 14-inches.

#### 1.05 PERFORMANCE REQUIREMENTS

- A. Provide fill of homogeneous structure which when cured, will have the required strength, water tightness, and durability. To this end, it is essential that careful attention be given to the selection of materials, mixtures, placing and curing of the fill.

#### 1.06 SUBMITTALS

- A. In accordance with Section 01300, submit the following,
  - 1. Mix design data not limited to, but including maximum and minimum strengths, air content, setting times, flowability and yield.
  - 2. Certification by the supplier stating compatibility with the project requirements and the Contractor's installation methods.

#### 1.07 QUALITY ASSURANCE

- A. Furnish the supplier with information as to the intended use of the CDF.

### PART 2 PRODUCTS

#### 2.01 MATERIALS

- A. Portland cement,

1. In accordance with AASHTO M85.
- B. Fly Ash (very flowable),
  1. In accordance with AASHTO M295, Type F.
- C. Sand,
  1. In accordance with Standard Specification M4.02.02
- D. Water,
  1. Clean and potable.
- E. Air entraining admixtures,
  1. In accordance with Standard Specification M4.02.05.

### PART 3 EXECUTION

#### 3.01 GENERAL

- A. The Contractor shall follow the guideline set forth in ACI 229, except non standard materials shall not be used.

#### 3.02 PREPARATION

- A. Pipes and all other members to be encased in CDF shall be temporarily secured in place to prevent displacement during fill placement.
- B. To reduce hydrostatic pressure and limit displacement potential, Contractor may use a high air generator in the fill mixture to lower unit weights.
- C. Pre-job test all pump applications prior to day of placement with actual equipment.
- D. Secure site during the placement for the CDF. Cautions include but are not limited to barricades, fences, lights and steel plates.
- E. Work shall be sequenced so as to keep traffic flowing within the project area.

#### 3.03 INSTALLATION

- A. CDF shall be batched at concrete plants and hauled to job sites in ready-mix trucks with continuous agitating drums and be discharged with slumps as indicated.
- B. During waiting period prior to discharge, truck drums shall agitate mixture.
- C. CDF shall be installed in accordance with supplier's recommendations, be flowable and require no vibration.



3.04 FIELD QUALITY CONTROL

- A. All CDF to be used in the work shall be subject to testing to determine whether it conforms to the requirements of the specifications. The methods of testing shall be in accordance with the Standard Specification, and as approved by the Engineer.
- B. The place, time, frequency, and method of sampling will be determined by the Engineer in accordance with the particular conditions of this project.

3.05 PROTECTION

- A. Open excavations containing uncured CDF shall not be left uncovered overnight.

END OF SECTION

## SECTION 02272

### GEOTEXTILE MATERIALS

#### PART 1 GENERAL

##### 1.01 SUMMARY

###### A. Section Includes

1. Requirements for installation of geotextile filter fabric in trenches, around leaching pits or drywells, and under riprap.

###### B. Related Sections

1. Section 02200 – Earthwork
2. Section 02215 – Aggregate Materials
3. Section 02220 – Riprap

##### 1.02 REFERENCES

###### A. American Society for Testing and Materials (ASTM)

1. D3786, Test Method for Hydraulic Bursting Strength of Knitted Goods and Nonwoven Fabrics: Diaphragm Bursting Strength Tester Method
2. D4355, Test Method for Deterioration of Geotextiles From Exposure to Ultraviolet Light and Water (Xenon-Arc Type Apparatus)
3. D4491, Test Method for Water Permeability of Geotextiles by Permittivity
4. D4533, Test Method for Trapezoid Tearing Strength of Geotextiles
5. D4632, Test Method for Grab Breaking Load and Elongation of Geotextiles
6. D4751, Test Method for Determining Apparent Opening Size of a Geotextile
7. D4833, Test Method for Index Puncture Resistance of Geotextiles, Geomembranes and Related Products
8. D5261, Measuring Mass Per Unit Area of Geotextiles.

##### 1.03 QUALITY ASSURANCE

###### A. General

1. Producer of fabric to maintain competent laboratory at point of manufacture to insure quality control in accordance with ASTM testing procedures.
2. Laboratory to maintain records of quality control results.

##### 1.04 SUBMITTALS

###### A. Shop Drawings

1. Submit in accordance with SECTION 01300
  2. Include manufacturer's recommended method of joining of adjacent fabric panels.
- B. Certificate of Conformance
1. Upon each shipment/delivery of product to the work site, furnish mill certificate(s) from the company manufacturing the fabric attesting that the fabric meets the chemical, physical, manufacturing and performance requirements specified. Fabric will be rejected if it is found to have defects, rips, flaws, deterioration or other damage.

1.05 DELIVERY, STORAGE AND HANDLING

- A. Provide fabric in rolls wrapped with a heavy-duty protective covering to protect fabric from, mud, dirt, dust, debris and other deleterious sources until it is installed. Label each roll of fabric with number or symbol to identify production run.
- B. Do not expose fabric to ultraviolet radiation (sunlight) for more than 20 days total in period of time following manufacture until fabric is installed and covered.
- C. If Engineer determines material is damaged in any way or has excessive sunlight exposure, the Contractor shall immediately make all repairs and replacements as directed by the Engineer, at no additional cost to the Owner.

1.06 SCHEDULING

- A. Schedule Work so that the covering of the fabric with a layer of the cover material is accomplished immediately after inspection and approval of the placed fabric by the Engineer. Failure to comply with this requirement shall require replacement of the fabric.

PART 2 PRODUCTS

2.01 ACCEPTABLE MANUFACTURER/MATERIAL

- A. The geotextile fabric shall be nonwoven polypropylene designated as MIRAFI 140N as manufactured by Nicolon/Mirafi Group, Norcross, Georgia; or acceptable equivalent and shall meet the following minimum requirements:

<u>Property</u>	<u>Unit</u>	<u>Test Method</u>	<u>Requirements</u>
Weight	oz/sy	ASTM D5261	4.3
Grab Tensile Strength	lbs	ASTM D4632	120
Grab Tensile Elongation	%	ASTM D4632	50
Mullen Burst Strength	psi	ASTM D3786	240
Puncture Resistance	lbs	ASTM D4833	70
Trapezoid Tear Strength	lbs	ASTM D4533	50
Equivalent Opening Size (EOS)	US Std. Sieve (mm)	ASTM D4751	70 (0.21)
Permittivity	sec <sup>-1</sup>	ASTM D4491	1.5
Permeability	cm/sec	ASTM D4491	0.22
Flow Rate	gal/min/sf	ASTM D4491	120

Ultraviolet Resistance (strength retained at 500 hrs)	%	ASTM D4355	70
--	---	------------	----

- B. To keep the number of overlay joints to a minimum, fabric shall be provided in sections not less than fifteen (15) feet in width unless otherwise approved by the Engineer prior to delivery to the site.

## PART 3 EXECUTION

### 3.01 SUBGRADE PREPARATION

#### A. For Riprap

1. Prepared areas to receive geotextile in accordance with SECTION 02200
2. Clear subgrade of all sharp objects, large stones, roots, debris, or any other foreign materials that may contribute to puncturing, shearing, rupturing or tearing of the geotextile.
3. Grade area as smooth as possible and compact in accordance with SECTION 02200, with a vibratory roller or other method approved by the Engineer.
4. Inspect subgrade and repair all unstable areas or soft spots with the installation of gravel and recompact prior to the placement of geotextile.

### 3.02 FABRIC INSTALLATION

#### A. For Riprap

1. Place at the locations shown on the Contract Drawings.
2. Unroll directly onto the prepared slope in a continuous manner. Join adjacent sections by overlapping the fabric a minimum of 12-inches. Join end sections by overlapping the fabric a minimum of 2-feet with field-sewn joints or as recommended by the manufacturer.
3. Place fabric on slopes creating a “shingled” effect in the direction of anticipated water flow.
4. Lay fabric smooth, maximizing surface contact with the prepared subbase, free of tension, stress, folds, wrinkles, or creases.
5. Securely anchor fabric sections at the top of the slope as recommended by the manufacturer. Use anchoring pins, nails, staples or other such means to secure fabric to the subbase surface to prevent fabric movement caused by wind uplift, and/or placement of cover material.
6. Maintain sufficient amount of cover material (minimum depth of 6-inches) to protect fabric during placement of riprap. Dozer buckets or blades, or other heavy or damaging equipment shall not be in direct contact with the fabric.

7. Minimize the height from which cover material is dumped and/or dropped directly onto the fabric material in order to avoid fabric damage or movement. Equipment used for spreading and compacting the cover material shall be of the type and size to avoid damage or movement to the underlying geotextile fabric.
8. Spread cover material in the direction of fabric overlap and in a manner that avoids creating undue tension, stress, sagging, buckling and/or other movement of the underlying fabric.

B. Fabric Installation in Trenches

1. In accordance with manufacturers recommendations
2. Place fabric in trench prior to placing crushed stone pipe bedding.
3. Overlap fabric 18-inches minimum for unsewn lap joints.
4. Do not permit equipment to travel directly on fabric.
5. Place fabric in smooth condition to prevent tearing or puncture.
6. Lay fabric loosely, without wrinkles or creases.
7. Leave slack in fabric to allow for adjustment.

3.03 PROTECTION

- A. Protect the work before, during and after installation, and protect the installed work covered by other Sections.

3.04 REPAIR

- A. Geotextile fabric damaged during installation shall be repaired by a piece of geotextile material cut, placed and adequately anchored over the damaged area, subject to a 3-foot minimum overlap requirement or as directed by the Engineer.
- B. If detrimental movement of the geotextile fabric occurs during any step of the installation, as determined solely by the Engineer, the Contractor shall remove the cover material and/or sections of fabric to the limits deemed necessary and reinstall the fabric.
- C. Any fabric damage during its installation or during placement of cover materials shall be replaced by the Contractor at no additional cost to the Owner.

END OF SECTION

SECTION 02276

SILT FENCE

PART 1 GENERAL

1.01 SECTION INCLUDES

- A. Requirements to perform all operations in connection with the silt fence, as indicated on the drawings and as herein specified.

1.02 REFERENCES

- A. American Society for Testing and Materials (ASTM)
  1. D3786-01 Standard Test Method for Hydraulic Bursting Strength of Textile Fabrics-Diaphragm Bursting Strength Tester Method
  2. D4355-02 Standard Test Method for Deterioration of Geotextiles by Exposure to Light, Moisture and Heat in a Xenon Arc Type Apparatus
  3. D4632-91(1996) Standard Test Method for Grab Breaking Load and Elongation of Geotextiles
  4. D4533-91(1996) Standard Test Method for Trapezoid Tearing Strength of Geotextiles.

1.03 SUBMITTALS

- A. In accordance with Section 01300.

PART 2 PRODUCTS

2.01 ACCEPTABLE MANUFACTURER

- A. Silt Fence as manufactured by Amoco Fabrics and Fibers, or acceptable equivalent.

2.02 MATERIALS

- A. The silt fence shall be comprised of a sediment control fabric and reinforced netting stitched together with heavy duty thread top and bottom, stapled to hardwood posts.
- B. Hardwood posts shall be 4.0 feet long, spaced a maximum 8.0 feet apart with lower ends tapered to facilitate driving into compacted soil.
- C. A 6-inch flap at the bottom of the fence shall be used to toe in the sediment control barrier to prevent silt migration under the barrier.
- D. Each section of fence shall be supplied with a coupling to attach adjoining sections.
- E. Silt fence shall conform to the following test requirements:

<u>Property</u>	<u>Test Method</u>	<u>Value</u>
-----------------	--------------------	--------------

1. Grab Tensile	ASTM D4632	100 lbs.
2. Grab Elongation	ASTM D4632	15 %
3. Trapezoid Tear Strength	ASTM D4533	50 lbs.
4. Mullen Burst Strength	ASTM D3786	275 psi.
5. Equivalent Opening Size	US Std. Sieve	20/30
6. Ultraviolet Resistance	ASTM D4355	70 %

F. Roll Width: 3.0 feet.

G. Roll Length: 100.0 feet.

### PART 3 EXECUTION

#### 3.01 INSTALLATION

- A. Install silt fence in accordance with manufacturers written recommendations.
- B. Silt fence and hay bales shall be installed prior to any grubbing or earth excavation.
- C. Install silt fence along with hay bales or straw wattles at locations shown on the Contract Drawings or as directed by the Engineer.

#### 3.02 MAINTENANCE

- 1. Maintain fence throughout the duration of the project.
- 2. Remove sediments when depths accumulate to 50% of the depth of the fence height, or as necessary.

#### 3.03 REMOVAL AT PROJECT COMPLETION

- A. Remove all sediment collected by the silt fence, remove the silt fence, and restore the area to pre-construction condition to the satisfaction of the Engineer.

END OF SECTION

## SECTION 02277

### STRAW WATTLES

#### PART 1 GENERAL

##### 1.01 SECTION INCLUDES

- A. Requirements to furnish and install straw wattles, as indicated on the Drawings and as herein specified.

##### 1.02 SUBMITTALS

- A. In accordance with SECTION 01300 submit product details, manufacturers installation instructions and certifications.

##### 1.03 STORAGE

- A. Store wattles off the ground and covered to protect from site construction damage, precipitation, sunlight (ultraviolet light), chemicals, open flames, sparks or other conditions which may damage the rolls.

#### PART 2 PRODUCTS

##### 2.01 MATERIALS

- A. Straw Wattles
  1. Machine produced.
  2. Straw filled tubes of compacted straw of rice, wheat or barley.
  3. Straw wattles to be certified as weed free.
  4. Netting for tubes to be seamless, high density polyethylene with ultra violet inhibitors.
  5. Roll length to be 10.0 feet to 25.0 feet.
  6. Weight per linear foot,
    - a. 12-inch: 2.5 lbs. minimum
    - b. 9-inch: 1.5 lbs. minimum
  7. Stakes shall be wooden, 1 1/8-inch x 1 1/8-inch x 2.5 feet long, with lower ends tapered to facilitate driving into compacted soil. Rebar may be substituted for wooden stakes.

#### PART 3 EXECUTION

##### 3.01 INSTALLATION

- A. Straw Wattles
  1. Install at locations indicated on the Drawings or as directed by the Engineer.
  2. Remove all rocks, vegetation or other obstructions at straw wattle location.
  3. Excavate a trench approximately 2 to 3-inches deep to accept the straw wattle and place straw wattle in trench.
  4. Anchor straw wattle with stakes placed a maximum of 4-feet apart.



5. The end stakes shall be placed 6-inches from the end of straw wattle and angled toward previously laid straw wattle to force straw wattles together.
6. Refer to detail on Drawings for additional installation requirements.

### 3.02 MAINTENANCE

- A. Maintain straw wattles throughout the duration of the project.
  1. Damaged or displaced straw wattles shall be replaced by the Contractor at no additional cost to the Owner.
- B. Remove sediments when depths accumulate to 50% of the depth of the straw wattle height, or as necessary.

### 3.03 REMOVAL AT PROJECT COMPLETION

- A. Remove all sediment collected by the straw wattle, remove the straw wattle, and restore the area to pre-construction condition to the satisfaction of the Engineer.

END OF SECTION

SECTION 02500

PAVEMENT

PART 1 GENERAL

1.01 SUMMARY

A. Section Includes

1. Requirements for construction of all temporary and permanent pavement on paved areas affected or damaged by the Contractors operations, whether inside or outside the normal trench limits, as indicated on the Drawings and as herein specified.

B. Related Sections

1. Section 02200 - Earth Excavation, Backfill, Fill and Grading

1.02 REFERENCES

- A. This specification makes reference to the requirements of additional specifications as listed. The Contractor shall obtain and familiarize himself with all requirements referenced by this specification prior to preparation and installation of any pavements.

1. The Massachusetts Department of Transportation, Highway Division, Standard Specifications for Highways and Bridges, dated 1988, together with all errata addenda additional revisions, and supplemental specifications, all of which are hereinafter referred to as the MassDOT Standard Specifications.

1.03 PAVEMENT SCHEDULE

- A. The Contractors attention is directed to the various pavements required under this contract, and their locations as detailed below.

- B. All pavement thickness specified in this specification shall be of the thickness required after compaction.

1.	<u>Location:</u>	<i>Parking Lots and Driveways</i>
	Type:	Flexible - 4"
	Requirements:	12" Dense Graded/Gravel Sub-base Course 2.5" Bituminous Binder 1.5" Bituminous Surface

## PRODUCTS

### 1.04 MATERIALS

#### A. Asphalt Tack

1. Tack coat shall consist of emulsified asphalt, grade RS-1 or cutback asphalt, conforming to the requirements of the MassDOT Standard Specification Section M3.11.06.

#### B. Bituminous Base

1. Bituminous Base shall conform to the requirements of the MassDOT Standard Specification Section 420 and M3.11.00 for Base Course.

#### C. Bituminous Binder Trench Width (Permanent Pavement)

1. Bituminous Binder Course shall conform to the requirements of the MassDOT Standard Specification Section 420 and M3.11.00 for Binder Course.

#### D. Bituminous Surface, Trench Width (Permanent Pavement)

1. Bituminous Surface Course shall conform to the requirements of the MassDOT Standard Specification Section 460 and M3.11.00 for surface course Class I-1.

#### E. Bituminous Surface, Curb to Curb

1. Bituminous Surface Course shall conform to the requirements of the MassDOT Standard Specification Section 460 and M3.11.00 for surface course Class I-1.

#### F. Reinforced Concrete Base

1. Concrete Base shall conform to the requirements of the MassDOT Standard Specification, Section 430.

#### G. Bituminous Binder Trench Width (Temporary Pavement)

1. Temporary Pavement shall be Binder Course conforming to the requirements of the MassDOT Standard Specification Section 420 and M3.11.00 for Binder Course.

#### H. Dense-Graded Crushed Stone Sub-base Course (Temporary and Permanent)

1. The dense graded crushed stone sub-base course shall consist of coarse aggregates of crushed stone or gravel and fine aggregates of natural sand or stone screenings. Uniformly pre-mixed with a predetermined quantity of water and placed on the sub-base in close conformity with the lines and grades shown on the Contract Documents or established by the Engineer.
2. Coarse aggregate shall consist of hard, durable particles of fragments of stone. Materials that break up when alternately frozen and thawed or wetted and dried shall not be used.
3. Coarse aggregate shall have a percentage of wear, by the Los Angeles Abrasion Test (AASTO-T-96) of not more than 45.
4. Fine aggregate shall consist of natural or processed sand.
5. The composite material shall be free from clay, loam or other cohesive soil, and shall conform to the following grading requirements:

Sieve Designation Mesh Sieves	Percentage by Weight Passing Square
2 in.	100
1-1/2 in.	70-100

3/4 in.	50-85
No. 4	30-55
No. 50	8-24
No. 200	3-10

6. Sampling and testing shall be in accordance with the following standard AASHTO methods:

Sieve Analysis	T27
Passing No. 200 Sieve	T11

7. The dense-graded crushed stone sub-base course shall be spread and compacted in layers not to exceed 4 inches in compacted depth, to the same tolerances specified below for the gravel sub-base.
8. The dense-graded crushed stone sub-base course material shall meet the same requirements as specified in MassDOT Specification M2.01.7 except as noted above.

I. Gravel Sub-Base Course

1. The gravel sub-base course shall consist of Gravel Borrow Type b, (3-inches largest dimension) as specified in MassDOT Standard Specification Section M1.03.0
2. The gravel sub-base shall be spread and compacted in one layer, to not less than 95 percent of the maximum dry density of the material, as determined by the Standard AASHTO Test Designation T99 compaction test Method C within 5% of optimum moisture content as determined by the Engineer. If the material retained on the #4 sieve is 50% or more of the total sample, this test shall not apply and the material shall be compacted to the satisfaction of the Engineer. The specific density of the Gravel Sub-base shall be maintained by determining the number of passes of a roller required to produce a constant and uniform density, after conducting a series of tests either using the sand/volume or the nuclear density-testing device.
3. Any stone with a dimension greater than 3 inches shall be removed from the sub-base before the gravel is compacted. Compaction shall continue until the surface is even and true to the proposed lines and grades within a tolerance of 1/2-inch above or below the required cross sectional elevations and to a maximum irregularity not exceeding 1/2 inch under a 10 foot line longitudinally. Any specific area a gravel sub-base which, after being rolled, does not form a satisfactory, solid, stable foundation shall be removed, replaced and recompactd by the Contractor without additional compensation.

1.05 SOURCE QUALITY CONTROL

- A. The paving plant used by the Contractor for preparation of bituminous paving materials shall be acceptable to the Engineer who shall have the right to inspect the plant and the making of the material as specified in MassDOT Specification M2.01.7 except as noted above.

PART 2 EXECUTION

2.01 PREPARATION

- A. Prior to placing pavement, all backfill shall have been properly compacted as specified under Section 02200 to eliminate settling of backfill. No pavement shall be placed over poorly compacted backfill. Backfill and gravel base course shall be compacted, brought to the

- proper elevation, and dressed so that new pavement construction shall be at the required grade. The Contractor shall maintain the surfaces of all excavated and disturbed areas until the pavement is placed. If there is a time lapse of more than 24 hours between completion of preparation of subgrade or placing of gravel base course and placing of paving, or if subgrade or gravel base course has been eroded or disturbed by traffic, the subgrade or gravel base course shall be restored before placing pavement.
- B. When installing permanent pavement on bituminous concrete roadway the edges of existing pavement shall be cut back 12-inches, or more as required, from the trench excavation wall or damaged area to sound undamaged material, straightened, cleaned, and painted with an accepted asphalt emulsion to ensure a satisfactory bond between it and the newly placed surface courses. Existing surface courses shall be stripped from the bituminous concrete base course for at least a 6-inch width and trimmed square and straight so that new permanent surfacing shall be placed on undisturbed bituminous concrete base course. Existing pavement shall be swept clean prior to placing any asphalt emulsion over it. Existing pavement that will be under new pavement shall be painted with asphalt emulsion to ensure a satisfactory bond.
  - C. Before permanent pavement is installed, the base shall be brought to the proper grade, and temporary pavement and excess gravel base shall be removed.
  - D. All manhole covers, catch basin grates, valve and meter boxes, curbs, walks, walls and fences shall be adequately protected and left in a clean condition. Where required, the grades of manhole covers, catch basin grates, valve boxes, and other similar items shall be adjusted to conform to the finished pavement grade.
  - E. The Contractor shall remove and acceptably dispose of all surplus and unsuitable material.

## 2.02 INSTALLATION

### A. General

1. Unless indicated otherwise, all permanent bituminous pavement shall be installed in two courses or more. Bituminous base courses shall be carefully spread and raked to a uniform surface and thoroughly rolled before application of the top course.
2. All top courses of permanent paving shall be applied with acceptable mechanical spreaders in widths of at least 9 feet.
3. The rolling for all bituminous and gravel base courses shall conform to the standards listed in the appropriate Subsection of the Standard Specification.
4. Pavement shall be placed so that the entire roadway or paved area shall have a true and uniform surface, and the pavement shall conform to the proper grade and cross section with a smooth transition to existing pavement.

### B. Dense Graded Crushed Stone Base Course

1. The base course shall be placed to such depth that the furnished compacted base course is the depth as indicated on the Contract Drawings and specified herein.
2. The top of the base course shall be below the furnish grade a distance required to accommodate the compacted pavement material as indicated on the Contract Drawings and specified herein.
3. The base course as herein specified shall be 12-inches thick for flexible pavement and 6-inches thick for rigid pavement.

### C. Temporary Pavement

1. Temporary pavement shall be placed over all trenches in paved areas where directed by the Engineer.
2. The Contractor, upon completing the backfilling and compaction of the trenches in the streets and the placing of the gravel base courses, shall be required to construct temporary pavement unless otherwise directed by the Engineer.
3. Temporary Pavement in Town or City roads shall be placed in one course and shall consist of 4-inch compacted thickness of hot bituminous mix, on compacted gravel base as directed by the Engineer.
4. Temporary Pavement in State roads shall be placed in one course and shall consist of 3-inch compacted thickness of hot bituminous mix, on a 18-inch compacted thickness gravel base as directed by the Engineer.
5. The Contractor shall maintain temporary pavement in good repair and flush with the existing pavement at all times until the permanent pavement is placed.
6. The temporary pavement shall not be removed until 60 days after installation or until such time that the Engineer authorizes the placement of permanent pavement at an earlier time.

### D. Bituminous Base:

1. Bituminous Base shall be used in city streets and parking areas as listed in Article 1.03 of this specification.
2. Bituminous Base shall be placed to the thickness as indicated in Article 1.03 of this Specification and installed in accordance with the requirements of the MassDOT Standard Specification and as detailed in the Contract Drawings.
3. Prior to placing bituminous base, all temporary pavement and sufficient gravel base course shall be removed, to proper depths as detailed in the Contract Drawings.

### E. Reinforced Concrete Base:

1. Reinforced Concrete Base shall be used in the streets as listed in Article 1.03 of this specification.
2. Reinforced Concrete Base shall be 8-inch thick and installed in accordance with the requirements of the MassDOT Standard Specification.
3. Prior to placing reinforced concrete base, all temporary pavement and sufficient gravel base course shall be removed, to proper depths as detailed in the Contract Drawings.

### F. Bituminous Binder

1. Bituminous Binder shall be used in the streets as listed in Article 1.03 of this specification.
2. Bituminous Binder shall be placed to the thickness as indicated in Article 1.03 of this Specification and installed in accordance with the requirements of the MassDOT Standard Specification and as detailed in the Contract Drawings.

### G. Bituminous Surface

1. Bituminous Surface shall be used in the streets as listed in Article 1.03 of this specification.
2. Bituminous Surface shall be placed to the thickness as indicated in Article 1.03 of this Specification and installed in accordance with the requirements of the MassDOT Standard Specification and as detailed in the Contract Drawings.

### H. Sidewalks, Driveways, Parking Lots and Curbing

1. Sidewalks, driveways, parking lots and curbing that are removed or damaged by the Contractor's operations shall be restored to a condition at least equal to that in which they are found immediately prior to the start of operations. Materials and methods used for such restoration shall be in conformance with the requirements of the MassDOT Standard Specification.
2. Where the trench location is in a sidewalk, the entire width of the sidewalk shall be replaced with new material. Side forms shall be set so as to obtain and preserve a straight edge along both sides of the walk.
3. Where trench is in a driveway, the driveway shall be repaved across its entire width with even edges.
4. Parking lots shall be repaved in accordance with Article 3.01 of this section.
5. Gravel base course under sidewalks and driveways shall not be less than 16 inches thick.

I. Surface Maintenance

1. During the guarantee period, the Contractor shall maintain the bituminous surface and shall promptly make good all defects such as cracks, depressions, and holes that may occur. At all times, the surfacing shall be kept in a safe and satisfactory condition for traffic. If defects occur in surfacing constructed by the Contractor, the Contractor shall remove all bituminous concrete and base course as is necessary to properly correct the defect. After removing bituminous concrete and base course, the Contractor shall correct the cause of the defect and replace the base course and bituminous concrete in accordance with these specifications.

END OF SECTION

## SECTION 02607

### PRECAST CONCRETE MANHOLES AND STRUCTURES

#### PART 1 GENERAL

##### 1.01 SUMMARY

###### A. Section Includes

1. Requirements for modular precast concrete manhole sections and structures with tongue-and-groove joints, cast iron covers or aluminum hatches, accessories and appurtenances.

###### B. Related Sections

1. Section 02200 – Earth Excavation, Backfill, Fill and Grading
2. Section 02140 – Dewatering
3. Section 02160 – Excavation Support
4. Section 03200 - Reinforcement
5. Section 03300 – Cast-In-Place Concrete

##### 1.02 REFERENCES

###### A. American Society for Testing and Materials (ASTM)

1. A48, Standard Specification for Gray Iron Castings.
2. A615 Standard Specification for Deformed and Plain Billet-Steel Bars for Concrete Reinforcement.
3. C32, Standard Specification of Sewer and Manhole Brick (Made from Clay or Shale), AASHTO Designation M91-42, Red Sewer Brick Only Grade SS.
4. C144, Standard Specification for Aggregate for Masonry Mortar.
5. C150, Standard Specification for Portland Cement.
6. C207, Standard Specification for Hydrated Lime for Masonry Purposes.
7. C443, Standard Specification for Joints for Concrete Pipe and Manholes Using Rubber Gaskets.
8. C478, Standard Specification for Precast Reinforced Concrete Manhole Sections.
9. C890, Standard Practice for Minimum Structural Design Loading for Monolithic or Sectional Precast Concrete Water and Wastewater Structures.
10. C923, Standard Specification for Resilient Connectors Between Reinforced Concrete Manhole Structures, Pipes and Laterals.
11. C990, Standard Specification for Joints for Concrete Pipe, Manholes, and Precast Box Sections Using Preformed Flexible Joint Sealants
12. C1244, Standard Test Method for Concrete Sewer Manholes by Negative Air Pressure.
13. D4101, Standard Specification for Propylene Plastic Injection and Extrusion Materials.

###### B. American Concrete Institute

1. ACI 318, Building Code Requirements for Structural Concrete
2. ACI 350, Environmental Engineering Concrete Structures



## 1.03 SYSTEM DESCRIPTION

### A. Design Requirements

1. Manholes and structures shall conform in shape, size, dimensions, materials, and other respects to the details indicated in the Contract drawings.
2. All manholes and structures shall have concrete bases. Invert channels may be formed in the concrete of the base or brickwork upon the base.
3. Manhole and structure walls, barrels and cones shall be precast concrete sections. The top of the cone (not to be more than 12-in.) shall be built of brickwork to permit adjustment of the frame to meet the finished surface.
4. The inverts shall conform accurately to the size of the adjoining pipes. Side inverts shall be curved and main inverts (where direction changes) shall be laid out in smooth curves of the longest possible radius which is tangent, within the manhole, to the centerlines of adjoining pipelines.
5. For Structures, the thickness of the bottom slab of the pre-cast bases shall not be less than the top slab.

### B. Design Responsibility

1. The Contractor shall be fully responsible for providing a complete and adequately designed sanitary sewer structure as required in accordance with the provisions set forth herein.
2. The Contractor shall engage, at his own expense, the services of a fully competent and qualified Professional Engineer, hereinafter referred to as the "Contractor's Engineer", registered in the State of MA, for the design of all reinforced concrete, and for completing flotation calculations, as necessary to accomplish the Work specified.

The Contractor's Engineer shall be acceptable to the Program Manager/Construction Manager and demonstrate a minimum of five (5) years documented experience in the field of structural design.

### C. Design Criteria

1. Design load requirements shall be determined by local conditions, applicable codes, structure end use, and shall be in accordance with the Building Code of the State in which the structure is being constructed.
2. The structure shall be designed to adequately and safely support all live and dead loads to which the structure will be subjected, and to withstand all conditions that may be encountered, including burial depth, and the dead and live loads anticipated for the structure. The structures shall have adequate wall, base and top slab thickness and steel reinforcement sufficient for the depth of burial shown on the Drawings.
3. Design precast reinforced concrete structures to withstand earth and groundwater loads. Groundwater elevation shall be assumed to be at the top of the structure. An at-rest lateral soil pressure coefficient of 0.5 shall be used.
4. Design precast reinforced concrete structure to withstand an AASHTO HS-20 vehicle loading with an impact factor of 1.3. Design shall account for vehicle positions both above and alongside the structure, including directly on manhole covers and hatches.
5. Design and install the structures to withstand hydrostatic uplift caused by a groundwater elevation at grade level or equal to the top of the structure, whichever produces the most severe condition. Use only the weight of the empty structure (no fill) and submerged soil

directly over any base perimeter to resist hydrostatic uplift with a minimum safety factor of 1.10. The weight of submerged soil may be 60 pounds per cubic foot maximum. Do not include side friction of soil on walls.

6. Design, as a minimum, shall be in accordance with the requirements and recommendations of ACI 350 and ASTM C890 as referenced in Section 1.02 herein.

#### 1.04 SUBMITTALS

##### A. Shop Drawings

1. In accordance with Specification SECTION 01300 - SUBMITTALS.

##### B. Samples

1. Provide representative samples of materials if requested by the Program Manager/Construction Manager.

##### C. Design Calculations

1. Design calculations bearing the Professional Seal and signature of the Contractor's Engineer shall include reinforced concrete design and buoyancy calculations, and address design load requirements of Section 1.03.
2. Included as part of this submission, the Contractor's Engineer must provide a complete listing of all references, codes and specifications that are used by the Contractor's Engineer.

### PART 2 PRODUCTS

#### 2.01 PRECAST CONCRETE SECTIONS

- A. Reinforced precast concrete shall be produced in the United States in accordance with the American Iron and Steel requirements of P.L. 113-76, the Consolidated Appropriations Act of 2014
- B. Conform to the ASTM C478 with the following exceptions and additional requirements:
  1. All cast in place concrete shall be Class A and shall conform to the requirements specified under SECTION 03300.
  2. Wall sections to be 6-inch thick minimum.
  3. Type II cement in accordance with ASTM C150.
  4. Structures to have a minimum of 5,000 psi. - 28 days compressive strength except as otherwise permitted.
  5. No more than two lift holes may be cast or drilled in each section.
  6. The date of manufacture and the name of trademark of the manufacturer shall be clearly marked on the inside of the structure.
  7. Acceptance of the sections will be on the basis of material tests and inspection of the completed product.
  8. All sections shall have tongue and groove gasketed, leak proof joints.
  9. All sections shall be cured by an approved method and shall not be shipped nor subjected to loading until the concrete compressive strength has attained 5,000 psi and not before 5 days after fabrication and/or repair, whichever is longer.

10. The thickness of the bottom slab of the pre-cast bases shall not be less than the top slab.
11. Bottom slab shall extend minimum 6-inches from the exterior structure wall.

C. Manhole Cones

1. Cones shall be precast sections of construction similar to above.

D. Manhole Bases

1. The tops of the bases shall be suitably shaped by means of accurate bell-ring forms to receive the barrel sections.
2. All holes for pipes shall be cast in the base sections so that there is a clear distance of four inches minimum between the inside bottom of the base section and the pipe invert.
3. Base pad shall be pre-cast with extended base as indicated on drawings and herein specified.
4. Openings for pipe and materials to be embedded in the wall of the base for these joints

## 2.02 COMPONENTS

A. Pipe Seals

1. Premolded elastomeric-sealed joints fitted or cast integrally into the pipe opening of the manhole base and/or wall section.
2. Provide a watertight joint.
3. Maximum 10-degree omni-directional deflection.
4. Conform to ASTM C923.
5. Seals to be:
  - a. Lock Joint Flexible Manhole Sleeve made by Interpace Corp., Parsippany, NJ;
  - b. Kor-N-Seal made by National Pollution Control Systems, Inc., Nashua, NH;
  - c. A-LOK manhole pipe seal made by A-LOK Corp., Trenton, NJ;
  - d. or an acceptable equivalent product.
6. All materials, accessories and construction methods used in making the joints shall be supplied or approved by the manufacturer of the premolded elastomeric-sealed joint. Furnish manufacturer's written instructions to the Program Manager/Construction Manager.

B. Aluminum Manhole Steps

1. Cast into walls of the precast sections to form a continuous ladder with a distance of twelve inches (12) between steps.
2. Aluminum drop-front type.
3. Stock No. 12653B made by Aluminum Company of America, Pittsburgh, PA.
4. Stock No. F-14-2-B made by New Jersey Aluminum Co., New Brunswick, N.J.,
5. Or an acceptable equivalent product.
6. Before the steps are built into the masonry and after thorough cleaning, those parts of aluminum steps which will be embedded shall be given a protective coating of an acceptable, heavy-bodied, bituminous material. The cleaning shall be done by suitable means and with suitable cleaning agents to ensure that the surfaces to be coated are free from all foreign matter such as dirt, oil, and grease. The steps shall be thoroughly rinsed and dried before the coating is applied and the coating shall have become thoroughly dry before the steps are built into the masonry.

C. Plastic Manhole Steps

1. Install in walls of the precast sections to form a continuous ladder with a distance of twelve inches (12) between steps.
2. Copolymer Polypropylene plastic manhole step Model PS2-PFSL as manufactured by M. A. Industries, Inc., Peachtree City, Georgia.
3. Plastic steps to be in conformance with ASTM D-4101 for type II propylene copolymers.
4. Plastic to encase 1/2-inch grade 60 steel reinforcing rod conforming to ASTM A-615.

D. Exterior Coating

1. The material shall be:
  - a. Minwax Fibrous Brush Coat made by the Minwax Co., New York, N.Y. or
  - b. Tremco 121 Foundation Coating made by the Tremco Inc., Cleveland, OH; or
  - c. Non-fibrated type liquid asbestos-free emulsion, Sonneborn 700, Toch RIW marine mastic D or equal Acceptable equivalent product.

E. Rubber Gaskets (between manhole sections)

1. In accordance with ASTM C443.
2. Gasket configuration per manufacturers recommendation.

F. Butyl Resin Gaskets (between manhole sections)

1. In accordance with ASTM C990.
2. Gasket configuration per manufacturers recommendation.

## 2.03 ACCESSORIES

A. Manhole Frames and Covers

1. Manhole frames and covers shall be produced in the United States in accordance with the American Iron and Steel requirements of P.L. 113-76, the Consolidated Appropriations Act of 2014
2. Furnish all cast-iron manhole frames and covers conforming to the details shown on the drawings, or as hereinbefore specified.
3. Castings shall be of good quality, strong, tough, even-grained cast iron, smooth, free from scale, lumps, blisters, sandholes, and defects of every nature which would render them unfit for the service for which they are intended. Contact surfaces of covers and frame seats shall be machined to prevent rocking of covers.
4. Casting shall be thoroughly cleaned and subject to a careful hammer inspection.
5. Castings shall be at least Class 25 conforming to the ASTM A48.
6. Standard sewer manhole frames and covers to have 24-inch opening, and be East Jordan Iron Works Cover Model 2110A, Frame Model 2114Z, or approved equal. Pattern of cover and lettering shall comply with the Owner's standards.
7. For locations where the proposed rim elevation is within the 100-yr floodplain, provide watertight sewer manhole frames having 24 inch diameter covers with 4 bolts, and gasket, and be East Jordan Iron Works, or approved equal. Pattern of cover and lettering shall comply with the Owner's standards.

B. Structure Entrance Hatches:

1. Manufacturers:
  - a. Bilco Company, New Haven, CT.
  - b. Halliday Products, Orlando, FL.
  - c. Equivalent

2. Provide aluminum hatches of the type and size indicated on the drawings and as follows:
  - a. Fabricate hatch and frame with ¼ inch (6 mm) extruded aluminum frame and ¼ inch (6mm) diamond checkered aluminum plate covers.
  - b. Reinforce cover, with aluminum bars and angles welded to underside of covers, to withstand AASHTO H-20 wheel loading.
  - c. Provide hatch with hinges, hold-open safety lock bars and flush lift handles, factory assembled, and shipped complete ready for installation.
  - d. Provide stainless steel hardware throughout. Hinge covers to frames with heavy duty stainless steel concealed hinges and stainless steel pins. Attach hinges to covers and frames with countersunk/flathead stainless steel machine screws. Covers shall fit flush to frame.
  - e. Provide slam latch, flush-mounted grip handle, and removable plug and key wrench.
  - f. Fabricate gutter-type hatches with 1-½ inch (38mm) drainage coupling in one corner of the channel frame
  - g. Provide frost proof inner hatch.
  - h. Provide ladder-up safety post.
  - i. Provide safety grating under the hatch door(s). Grating shall be hinged and locked separately from the hatch door(s). Grating shall be designed to withstand 300 psf and be painted safety orange by the hatch manufacturer.
  - j. Provide a forged brass case padlock with hardened steel shackle. The padlock shall be furnished with two (2) keys that are compatible with the Owner's Master Locking System.
  - k. Install hatch in accordance with manufacturer's instructions.
  - l. The hatch shall be cast into the structural slabs. Coordination of the hatch installation is the responsibility of the Contractor.
  - m. All hatch operating equipment shall be manufactured to be flush or below the hatch surface.

#### C. Brick

1. Sound, hard, and uniformly burned brick, regular and uniform in shape and size, of compact texture, and satisfactory to the Engineer.
2. In accordance with ASTM C32, Red Sewer Brick Only Grade SS.
3. In accordance with AASHTO M91-42, Red Sewer Brick Only Grade SS.
4. Reject brick shall be immediately removed from the work.

#### D. Mortar for Brickwork

1. Composed of Portland cement, hydrated lime, and sand in which the volume of sand shall not exceed three times the sum of the volume of cement and lime.
2. The proportions of cement and lime shall be 1:1/4.
3. Cement shall be Type II Portland cement in accordance with Specification SECTION 03300.
4. Hydrated lime shall be Type S conforming to the ASTM C207.
5. Hydrated lime shall be "Mortaseal" manufactured by U.S. Gypsum or
6. "4X Hydrate" manufactured by the New England Lime Company or
7. An acceptable equivalent product.
8. The sand shall conform to ASTM C144.

## PART 3 EXECUTION

### 3.01 INSTALLATION

#### A. Manhole and Structure Sections

1. Set so as to be vertical and with sections and steps in true alignment.
2. Rubber gaskets shall be installed in all joints in accordance with the manufacturer's recommendations.
3. All holes in sections used for their handling shall be thoroughly plugged with rubber plugs made specifically for this purpose or with mortar. The mortar shall be one part cement to 1-1/2 parts sand, mixed slightly damp to the touch (just short of "balling"), hammered into the holes until it is dense and an excess of paste appears on the surface, and then finished smooth and flush with the adjoining surfaces.

#### B. Rubber and/or Butyl Resin Gaskets (between manhole sections)

1. In accordance with manufacturers recommendation.
2. Install in all joints between precast sections.

#### C. Brickwork

1. Only clean bricks shall be used.
2. Bricks shall be moistened by suitable means, until they are neither so dry as to absorb water from the mortar nor so wet as to be slippery when laid.
3. Each brick shall be laid in a full bed and joint of mortar without requiring subsequent grouting, flushing, or filling, and shall be thoroughly bonded.

#### D. Plastering And Curing Brick Masonry

1. Outside faces of brick masonry adjustment courses shall be plastered with mortar to a thickness of 1/2-inch.
2. If required, the masonry shall be properly moistened prior to application of the mortar.
3. The plaster shall be carefully spread and troweled. After hardening, the plaster shall be carefully checked by being tapped for bond and soundness.
4. Unbonded or unsound plaster shall be removed and replaced.
5. Brick masonry and plaster shall be protected from too rapid drying by the use of burlaps kept moist, or by other suitable means, and shall be protected from the weather and frost, to insure maximum strength.

#### E. Exterior Coating

1. The exterior surfaces of all manholes shall be given two coats of waterproofing material.
2. The waterproofing material shall be applied by brush or spray and in accordance with the instructions of the manufacturer.
3. Time shall be allowed between coats to permit sufficient drying so that the application of the second coat has no effect on the first coat.

### 3.02 SETTING MANHOLE FRAMES AND COVERS

- A. Manhole frames shall be set with the tops conforming accurately to the grade of the pavement or finished ground surface or as indicated on the drawings or directed. Frames shall be set concentric with the top of the masonry and in full bed of mortar so that the space between the top of the manhole masonry and the bottom flange of the frame shall be completely filled and made watertight. A thick ring of mortar extending to the outer edge of the masonry shall be

placed all around and on the top of the bottom flange. The mortar shall be smoothly finished and have a slight slope to shed water away from the frame.

B. Manhole covers shall be left in place in the frames on completion of work at the manholes.

### 3.03 CLEANING

A. Manholes and structures to be free of construction debris prior to final inspection.

END OF SECTION

## SECTION 02618

### DUCTILE-IRON PIPE AND FITTINGS FOR BURIED SERVICE

#### PART 1 GENERAL

##### 1.01 SECTION INCLUDES

- A. This specification covers requirements to furnish, lay, joint, and test buried ductile-iron pressure pipe, fittings (including special castings), and appurtenant materials and equipment indicated on the Drawings and specified in this Section.
- B. Ductile Iron pipe and fittings shall be produced in the United States in accordance with the American Iron and Steel requirements of P.L. 113-76, the Consolidated Appropriations Act of 2014**

##### 1.02 RELATED SECTIONS

- A. SECTION 01300 – SUBMITTALS
- B. SECTION 11961 – INTERIOR AND EXTERIOR PROCESS PIPING

##### 1.03 REFERENCES

- A. American National Standards Institute (ANSI)
  - 1. A21.4, Cement-Mortar Lining for Ductile-Iron and Gray-Iron Pipe and Fittings for Water.
  - 2. A21.10, Gray-Iron and Ductile-Iron Fittings, 3-inch. through 48-inch., for Water and Other Liquids.
  - 3. A21.11, Rubber-Gasket Joints for Ductile-Iron and Gray-Iron Pressure Pipe and Fittings.
  - 4. A21.15, Flanged Ductile Iron Pipe with Threaded Flanges.
  - 5. A21.50, Thickness Design of Ductile-Iron Pipe.
  - 6. A21.51, Ductile-Iron Pipe, Centrifugally Cast in Metal Molds, or Sand-Lined Molds, for Water or Other Liquids.
- B. American Water Works Association (AWWA)
  - 1. AWWA 600, Installation of Ductile Iron Water Mains and their Appurtenances

##### 1.04 SUBMITTALS

- A. In accordance with specification Section 01300 submit the following:



B. Shop Drawings

1. Piping layouts in full detail.
2. Location and type of backup block or device to prevent separation.
3. Schedules of all pipe, fittings, special castings, couplings, expansion joints, and other appurtenances.

C. Certificates

1. **Ductile Iron pipe and fittings shall be produced in the United States in accordance with the American Iron and Steel requirements of P.L. 113-76, the Consolidated Appropriations Act of 2014. Certificate of compliance with this requirement shall be submitted with shop drawing.**

D. Manufacturer's Literature

1. Catalog cuts of joints, couplings, harnesses, expansion joints, gaskets, fasteners and other accessories.
2. Brochures and technical data of coatings and lining's and proposed method of application.

1.05 QUALITY ASSURANCE

- A. Inspect and test at foundry according to ANSI Standards.
- B. Owner reserves right to inspect and/or test by independent service at manufacturer's plant or elsewhere at his own expense.
- C. Owner reserves right to perform visual inspection and hammer test before installation.

PART 2 PRODUCTS

2.01 MANUFACTURERS

- A. U.S. Pipe, Birmingham, AL
- B. American Cast Iron Pipe Company, Birmingham, AL
- C. Approved equal.

2.02 PIPE

A. Ductile-Iron Pipe

1. All ductile-iron pipe shall be designed in accordance with ANS A21.50 and shall be manufactured in accordance with ANS A21.15 or ANS A21.51.
2. Unless otherwise indicated or specified, ductile-iron pipe shall be at least thickness Class 52.

## B. Pipe For Use With Couplings

1. Pipe for use with sleeve-type couplings shall be as specified above except that the ends shall be plain (without bells or beads). The end shall be cast or machined at right angles to the axis.

## 2.03 FITTINGS

### A. General

1. Fittings shall conform to the requirements of ANS A21.10 and shall be at least Class 150.
2. Push-on or mechanical-joint fittings shall be all-bell fittings unless otherwise indicated or specified.

### B. Nonstandard Fittings

1. Fittings having nonstandard dimensions and cast especially for this project shall be of acceptable design. They shall be manufactured to meet the requirements of the same specifications and shall have the same diameter and thickness as standard fittings, but their laying lengths and types of ends shall be determined by their positions in the pipelines and by the particular piping to which they connect.

## 2.04 ADAPTERS

- A. Where it is necessary to joint pipes of different type, the Contractor shall furnish and install the necessary adapters unless solid sleeves are indicated on the drawings or permitted. Adapters shall have ends, conforming to the above specifications for the appropriate type of joint, to receive the adjoining pipe. Adapters joining two classes of pipe may be of the lighter class provided that the annular space in bell-and-spigot type joints will be sufficient for proper jointing.

## 2.05 JOINTS

### A. Restrained

1. Where so indicated, pipe and fittings shall be furnished with approved joints, lugs or hooks cast integrally for use with bolts or bridle rods and socket clamps to keep the piping from pulling apart under pressure.

### B. Push-On and Mechanical

1. Joints for push-on and mechanical-joint pipe shall conform to ANS A21.11.
2. The plain end of push-on pipe shall be factory machined to a true circle and chamfered to facilitate fitting the gasket.
3. Push-on and mechanical-joint pipe and fittings shall be provided with sufficient quantities of accessories conforming to ANS A21.11.

4. At Contractors option, joints in buried exterior pipelines shall be either push on joints or mechanical joints.

#### C. Gaskets

1. Gaskets shall be of a composition suitable for exposure to the product which the pipe is intended.

### 2.06 MECHANICAL JOINT RESTRAINTS

- A. Restraint devices for nominal pipe sizes 3 inch through 54 inch shall consist of multiple gripping wedges incorporated into a follower gland meeting the applicable requirements of ANSI/AWWA C110/A21.10. Restraints shall be Megalug by EBAA Iron or equal.
- B. The devices shall have a working pressure rating of 350 psi for 3-16 inch, 250 psi for 18-48 inch and 200 psi for the 54 inch size. Ratings are for water pressure and must include a minimum safety factor of 2 to 1 in all sizes.
- C. Gland body, wedges and wedge actuating components shall be cast from grade 65-45-12 ductile iron material in accordance with ASTM A536.
- D. Ductile iron gripping wedges shall be heat treated within a range of 370 to 470 BHN.

### 2.07 COUPLINGS

#### A. Flexible Connections

1. Where flexible connections in the piping are specified or indicated on the drawings, they shall be obtained by the use of sleeve-type couplings, split couplings, or mechanical-joint pipe and/or fittings as herein specified.

#### B. Sleeve-Type Couplings

1. To ensure correct fitting of pipe and couplings, all sleeve-type couplings and accessories shall be furnished by the supplier of the pipe and shall be of a pressure rating at least equal to that of the pipeline in which they are to be installed.
2. Sleeve-type couplings shall be style 38 or 138, made by Dresser Mfg. Div., Bradford, Pa.; or be acceptable equivalent products.
3. Couplings for buried pipe shall be of cast iron and shall be Dresser Style 153, or acceptable equivalent products. The couplings shall be provided with galvanized-steel bolts and nuts, unless noted otherwise.
4. All couplings shall be furnished with the pipe stop removed.
5. All couplings shall be provided with gaskets of a composition suitable for exposure to the liquid within the pipe.
6. All gaskets provided with metallic tips for electrical continuity through joints.

## 2.08 ACCESSORIES

### A. Tapped Connections

1. Tapped connections in pipe and fittings shall be made in such manner as to provide a watertight joint and adequate strength against pullout. The maximum size of taps in pipe or fittings without bosses, shall not exceed the listed size in the appropriate table of the Appendix to the above-mentioned ANS A21.51 based on 3 full threads for cast iron and 2 full threads for ductile iron.
2. Where the size of the connections exceeds that given above for the pipe in question, a boss shall be provided on the pipe barrel, the tap shall be made in the flat part of the intersection of the run and branch of a tee or cross, or the connection shall be made by means of a tapped tee, branch fitting and tapped plug or reducing flange, or tapping tee and tapping valve, all as indicated or permitted by the Engineer.
3. All drilling and tapping of cast-iron pipe shall be done normal to the longitudinal axis of the pipe; fitting shall be drilled and tapped similarly, as appropriate. Drilling and tapping shall be done only by skilled mechanics. Tools shall be adapted to the work and in good condition so as to produce good, clean-cut threads of the correct size, pitch, and taper.

## 2.09 FINISHES

### A. Lining

1. Inside of pipe and fittings shall be coated with double thickness cement lining and bituminous seal coat conforming to ANS A21.4. The standard bituminous coating is specified under the appropriate ANS Standard for the pipe and fittings.

### B. Coating

1. Outside of pipe and fittings shall be coated with the standard bituminous coating conforming to appropriate ANS Standard.
2. Outside surfaces of castings to be encased in concrete shall not be coated.
3. Machined surfaces shall be cleaned and coated with a suitable rust-preventative coating at the shop immediately after being machined.

## PART 3 EXECUTION

### 3.01 HANDLING

#### A. Pipe and Fittings

1. The Contractor's attention is directed to the fact that cast iron used for pipe and fittings is comparatively brittle. Every care shall be taken in handling and laying pipe and fittings to avoid damaging the pipe, scratching or marring machined surfaces, and abrasion of the pipe coatings.

2. Any fitting showing a crack and any fitting or pipe which has received a severe blow that may have caused a fracture, even though no such fracture can be seen, shall be marked as rejected and removed at once from the Work.
3. In any pipe showing a distinct crack and in which it is believed there is no incipient fracture beyond the limits of the visible crack, the cracked portions, if so approved, may be cut off by and at the expense of the Contractor before the pipe is laid so that the pipe used is perfectly sound. The cut shall be made in the sound barrel at a point at least 12-inches from the visible limits of the crack.

### 3.02 CUTTING

#### A. Pipe

1. Except as otherwise approved, all cutting shall be done with a machine having rolling wheel cutters, knives, or saws adapted to the purpose. Hammer and chisel or wheel span cutters shall not be used to cut pipe. All cut ends shall be examined for possible cracks caused by cutting.
2. Cut ends to be used with push-on joints shall be carefully chamfered to prevent cutting the gasket when the pipe is laid or installed.

### 3.03 INSTALLATION

#### A. Pipe and Fittings

1. All ductile iron water pipe and fittings shall be installed in accordance with AWWA 600.
2. No defective pipe or fittings shall be laid or placed in the piping, and any piece discovered to be defective after having been laid or placed shall be removed and replaced by a sound and satisfactory piece.
2. Each pipe and fitting shall be cleared of all debris, dirt, etc., before being laid and shall be kept clean until accepted in the complete work.
3. Pipe and fittings shall be laid accurately to the lines and grades indicated on the drawings or required. Care shall be taken to ensure a good alignment both horizontally and vertically.
4. Pipe shall have a firm bearing along its entire length.
5. The deflection of alignment at a joint shall not exceed the appropriate permissible deflection as specified in the tabulation titled PIPE DEFLECTION ALLOWANCES.

#### PIPE DEFLECTION ALLOWANCES

##### Maximum permissible deflection, in.\*

<u>Size of pipe, in.</u>	<u>push-on joint</u>	<u>Mechanical joint</u>
------------------------------	--------------------------	-----------------------------

4	19	31
6	19	27
8	19	20
10	19	20
12	19	20
14	11	13-1/2
16	11	13-1/2
18	11	11
20	11	11
24	11	9
30	11	9
36	11	8
42	7-1/2	7-1/2
48	7-1/2	7-1/2
54	5-1/2	--

\*Maximum permissible deflection for 18-ft. lengths; maximum permissible deflections for other lengths shall be in proportion of such lengths to 18 ft.

6. When mechanical joint, push-on joint, or similar pipe is laid, the bell of the pipe shall be cleaned of excess tar or other obstructions and wiped out before the cleaned and prepared spigot of the next pipe is inserted into it. The new pipe shall be shoved firmly into place until properly seated and held securely until the joint has been completed.

B. Castings

1. Immediately prior to being set, castings shall be thoroughly cleaned of all rust, scale and other foreign material.

C. Temporary Plugs

1. At all times when pipe laying is not actually in progress, the open ends of pipe shall be closed by temporary watertight plugs or by other approved means. If water is in the trench when work is resumed, the plug shall not be removed until all danger of water entering the pipe has passed.

D. Appurtenances

1. All valves, fittings and appurtenances shall be set and jointed as indicated on the drawings.

3.04 ASSEMBLING

A. Push-On Joints

1. Make up by inserting the gasket into the groove of the bell and applying a thin film of special nontoxic gasket lubricant uniformly over the inner surface of the gasket which will be in contact with the spigot end of the pipe.
2. The chamfered end of the plain pipe shall be inserted into the gasket and then forced past it until it seats against the bottom of the socket.

B. Bolted Joints

1. Before the pieces are assembled, rust-preventive coatings shall be removed from machined surfaces.
2. Pipe ends, sockets, sleeves, housings, and gaskets shall be thoroughly cleaned and all burrs and other defects shall be carefully smoothed.

C. Mechanical Joints

1. Surfaces against which the gasket will come in contact shall be thoroughly brushed with a wire brush prior to assembly of the joint. The gasket shall be cleaned. The gasket, bell, and spigot shall be lubricated by being washed with soapy water.
2. The gland and gasket, in that order, shall be slipped over the spigot, and the spigot shall be inserted into the bell until it is correctly seated.
3. The gasket shall then be seated evenly in the bell at all points, centering the spigot, and the gland shall be pressed firmly against the gasket.
4. After all bolts have been inserted and the nuts have been made up finger tight, diametrically opposite nuts shall be progressively and uniformly tightened all around the joint to the proper tension, preferably by means of a torque wrench.
5. The correct range of torque as indicated by a torque wrench and the length wrench (if not a torque wrench) used by an average man to produce such range of torque, shall not exceed the values specified in the tabulation titled TORQUE RANGE VALUES.

TORQUE RANGE VALUES

Nominal pipe size, <u>in.</u>	Bolt diameter, <u>in.</u>	Range of torque, <u>ft.-lb.</u>	Length of wrench, <u>in.</u>
3	5/8	40-60	8
4 thru 24	3/4	60-90	10
30, 36	1	70-100	12
42, 48	1-1/4	90-120	14

If the effective sealing of the joint is not attained at the maximum torque indicated above, the joint shall be disassembled and thoroughly cleaned, then reassembled. Bolts shall not be over stressed to tighten a leaking joint.

#### D. Sleeve-Type Couplings

1. Prior to the installation of sleeve-type couplings, the pipe ends shall be cleaned thoroughly for a distance of 8-inches
2. Soapy water may be used as a gasket lubricant.
3. A follower and gasket, in that order, shall be slipped over each pipe to a distance of about 6-inches from the end, and the middle ring shall be placed on the already laid pipe end until it is properly centered over the joint.
4. The other pipe end shall be inserted into the middle ring and brought to proper position in relation to the pipe already laid.
5. The gaskets and followers shall then be pressed evenly and firmly into the middle ring flares.
6. After the bolts have been inserted and all nuts have been made up finger tight, diametrically opposite nuts shall be progressively and uniformly tightened all around the joint, preferably by use of a torque wrench of the appropriate size and torque for the bolts.
7. The correct torque as indicated by a torque wrench shall not exceed the values indicated in the tabulation titled TORQUE.

#### TORQUE

Nominal pipe size, <u>in.</u>	Bolt diameter, <u>in.</u>	Maximum torque, <u>ft.-lb.</u>
3-24	5/8	75
30-36 (1/2 in. mid ring)	5/8	65
30-36 (3/8 in. mid. ring)	5/8	70
30-48	3/4	80
48-72	3/4	70

8. After assembly and inspection and before being backfilled, all exterior surfaces of buried sleeve-type couplings, including the middle and follower rings, bolts, and nuts, shall be thoroughly coated with an approved heavy-bodied bituminous mastic. Care shall be taken and appropriate devices used to ensure that the undersides, as well as the more readily accessible parts, are well coated.

#### 3.05 SOCKET PIPE CLAMPS, TIERODS, AND BRIDLES

- A. Where indicated or necessary to prevent joints or sleeve couplings from pulling apart under pressure, suitable socket pipe clamps, tie rods, and bridles shall be provided. Bridles and tie rods shall be at least 3/4 in. diameter except where they replace flange bolts of smaller size, in which case they shall be fitted with a nut on each side of the pair of flanges. The socket clamps and tie rods or bridles shall be coated with an approved bituminous paint after assembly or, if necessary, prior to assembly.



### 3.06 PIPING SUPPORT

- A. Where necessary, bends, tees, and other fittings in pipelines buried in the ground shall be backed up with concrete placed against undisturbed earth where firm support can be obtained. If the soil does not provide firm support, then suitable bridle rods, clamps, and accessories to brace the fitting properly shall be provided. Such bridle rods, etc., shall be coated thoroughly and heavily with an approved bituminous paint after assembly or, if necessary, prior to assembly.

### 3.07 CLEANING

- A. Prior to the pressure and leakage tests, the piping shall be thoroughly cleaned of all dirt, dust, oil, grease and other foreign material. This work shall be done with care to avoid damage to linings and coatings.

### 3.08 PRESSURE AND LEAKAGE TESTS

- A. Except as otherwise directed, all pipelines shall be given combined pressure and leakage tests in sections of approved length.
- B. The Contractor shall furnish and install suitable temporary testing plugs or caps; all necessary pressure pumps, pipe connections, meters, gages, relief valves, and other necessary equipment; and all labor required, to test the pipe specified in this Section.
- C. Subject to the approval of the Engineer, the Contractor may make the tests when he desires. The tests shall be made within a reasonable time considering the progress of the project as a whole, and the need to put the section into service. However, pipelines in excavation or embedded in concrete shall be tested prior to the backfilling of the excavation or placing of the concrete. Exposed piping shall be tested prior to field painting.
- D. The section of pipe to be tested shall be filled with water of approved quality, and all air shall be expelled from the pipe. If hydrants or blow offs are not available at high points for releasing air the Contractor shall make the necessary excavations and do the necessary backfilling and make the necessary taps at such points and shall plug said holes after completion of the test.
- E. The section under test shall be maintained full of water for a period of 24 hours prior to the combined pressure and leakage test being applied.
- F. The pressure and leakage test shall consist of first raising the water pressure (based on the elevation of the lowest point of the section under test and corrected to the gage location) to a pressure in pounds per square inch numerically equal to the pressure rating of the pipe but not to exceed 200 psi. Care shall be taken not to apply this pressure to items of equipment known to be incapable of withstanding such pressure.

- G. If the Contractor cannot achieve the specified pressure and maintain it for a period of one hour with no additional pumping, the section shall be considered as having failed to pass the test.
- H. If the section fails to pass the pressure and leakage test, the Contractor shall do everything necessary to locate, uncover, and repair or replace the defective pipe, fitting, or joint, all at his own expense and without extension of time for completion of the work. Additional tests and repairs shall be made until the section passes the specified test and is considered acceptable by the Engineer.
- I. If, in the judgment of the Engineer, it is impracticable to follow the foregoing procedure exactly for any reason, modifications in the procedure may be made as required and approved by the Engineer, but in any event the Contractor shall be fully responsible for the ultimate tightness of the line within the above leakage and pressure requirements.

### 3.09 DISINFECTING AND FLUSHING

- A. The Contractor shall disinfect all lines carrying potable water.
- B. The Contractor shall furnish all equipment and materials necessary to do the work of disinfecting, and shall perform the work in accordance with the procedure outlined in the AWWA Standard for Disinfecting Water Mains, Designation C651-92, except as otherwise specified herein.
- C. The chlorine dosage shall be such as to produce not less than 10 PPM. after a contact period of not less than 24 hours.
- D. After treatment, the main shall be flushed with clean water until the residual chlorine content does not exceed 0.2 PPM.
- E. During the disinfection period, care shall be exercised to prevent contamination of water in existing mains.
- F. The Contractor shall dispose of the water used in disinfecting and flushing in an approved manner.
- G. If, in the opinion of the Engineer and/or owner of the above method of disinfection is deemed impractical, the lines carrying potable water shall be disinfected by the method outlined in AWWA Standard C651-92-Section 9.

END OF SECTION

## SECTION 02620

### HIGH DENSITY POLYETHYLENE PIPE

#### PART 1 GENERAL

##### 1.01 SCOPE

- A. This specification defines the characteristics and properties of high-density polyethylene (HDPE) pipe. This specification governs the material, pipe, fittings, butt fusion, and general construction practice for HDPE piping systems.

##### 1.02 REFERENCES

- A. American Society for Testing and Materials:
1. D638 - Standard Test Method for Tensile Properties of Plastics
  2. D696 - Standard Test Method for Coefficient of Thermal Expansion of Plastics Between (-30°C) and 30°C
  3. D746 - Standard Test Method for Brittleness Temperature of Plastics and Elastomers by Impact
  4. D790 - Standard Test Method for Flexural Properties of Unreinforced and Reinforced Plastics and Electrical Insulating Materials
  5. D1238 - Standard Test Method for Flow Rates of Thermoplastics by Extrusion Plastometer
  6. D1505 - Standard Test Method for Density of Plastics by the Density-Gradient Technique
  7. D1603 - Standard Test Method for Carbon Black in Olefin Plastics
  8. D1693 - Standard Test Method for Environmental Stress Cracking of Ethylene Plastics
  9. D1928 - Standard Practice for Preparation of Compression-Molded Polyethylene Test Sheets and Test Specimens
  10. D2321 - Standard Practice for Underground Installation of Thermoplastic Pipe for Sewers and Other Gravity-Flow Applications
  11. D2774 - Standard Practice for Underground Installation of Thermoplastic Pressure Piping
  12. D2837 - Standard Test Method for Obtaining Hydrostatic Design Basis for Thermoplastic Pipe Materials
  13. D3350-02a Standard Specification for Polyethylene Plastics Pipe and Fittings Materials

14. D 3261 - Standard Specification for Butt Fusion Polyethylene (PE) Plastic Fittings for Polyethylene (PE) Plastic Pipe and Tubing
15. D 3035 - Standard Specification for Polyethylene (PE) Plastic Pipe (DR-PR) Based on Controlled Outside Diameter
16. F 714 - Standard Specification for Polyethylene (PE) Plastic Pipe (SDR-PR) Based on Outside Diameter

B. American Water Works Association (AWWA):

1. C906 – Polyethylene (PE) Pressure Pipe and Fittings, 4 in. Through 63 in., For Water Distribution

C. National Sanitation Foundation (NSF):

1. Standard 14, National Sanitation Foundation Standard for Plastic Piping System Components and Related Materials.
2. PPI TR31-9/79 - Underground Installation of Polyolefin Piping

### 1.03 RELATED SECTIONS

- A. Section 01600 – Materials and Equipment
- B. Section 02200 - Earth Excavation, Backfill, Fill and Grading

## PART 2 PRODUCTS

### 2.01 MATERIAL

- A. Materials used for the manufacture of polyethylene pipe and fittings shall be extra high molecular weight, high density PE 3408 polyethylene resin. The material shall be listed by PPI (Plastics Pipe Institute, a division of the Society of the Plastics Industry) in PPI TR-4 with a 73°F hydrostatic design basis of 1,600 psi and a 140°F hydrostatic design basis of 800 psi. The PPI listing shall be in the name of the pipe manufacturer and shall be based on ASTM D2837 testing.

### 2.02 PIPE AND FITTINGS

- A. Pipe. Pipe supplied under this specification shall have a nominal IPS (Iron Pipe Size) OD unless otherwise specified. The DR (Dimension Ratio) and the pressure rating of the pipe supplied shall be as specified by the engineer. The pipe shall be produced from approved HDPE pipe grade resin with the nominal physical properties outlined in Section III. Pipe having a diameter 3” and larger will be made to the dimensions and tolerances specified in ASTM F 714.

B. APPROVED PIPE MANUFACTURERS

1. Chevron Phillips Chemical Co., The Woodlands, TX
2. ISCO Industries, Louisville, KY
3. Approved equal.

C. The pipe shall contain no recycled compound except that generated in the manufacturer's own plant. The pipe shall be homogeneous throughout and free of visible cracks, holes, voids, foreign inclusions, or other defects that may affect the wall integrity.

D. The pipe will be extruded from resin meeting the specifications of ASTM D3350 with a minimum cell classification of 345464C.

E. Fittings. HDPE fittings shall be in accordance with ASTM D3261 and shall be manufactured by injection molding, a combination of extrusion and machining, or fabrication from HDPE pipe conforming to this specification. The fittings shall be fully pressure rated and provide a working pressure equal to that of the pipe with an included 2:1 safety factor. The fittings shall be manufactured from the same base resin type and cell classification as the pipe itself. The fittings shall be homogeneous throughout and free from cracks, holes, foreign inclusions, voids, or other injurious defects.

2.03 QUALITY AND WORKMANSHIP

A. The pipe and/or fitting manufacturer's production facilities shall be open for inspection by the owner or his designated agents with a reasonable advanced notice. During inspection, the manufacturer shall demonstrate that it has facilities capable of manufacturing and testing the pipe and/or fittings to standards required by this specification. Pipe which has been tested by the manufacturer and falls outside of the appropriate limits set forth in this specification will be cause for rejection.

B. QA Records. QA/QC records shall be maintained intact for a minimum of one year from the date of production.

2.05 PIPE MARKING

A. During extrusion production, the HDPE pipe shall be continuously marked with durable printing including the following information:

1. Nominal Size
2. Dimension Ratio
3. Pressure Class, psi
4. Manufacturer's Name and Product Series
5. Cell Class
6. ASTM Basis
7. "NSF-PW"

8. Pipe Test Category
  9. Plant Code & Extruder
  10. Production Date
  11. Operator Number (Shift Letter optional)
  12. Resin Supplier Code
- B. For pipe diameters greater than or equal to 3” IPS, PE345464C shall be used as a cell class and F714 shall be used as the ASTM Basis. An example of the print string will read as follows:

14”IPS DR21 PC80 Driscopipe 4100 PE345464C ASTM F714 NSF-PW  
C3 PR6 24Mar02 14A P

## 2.06 PIPE PACKAGING, HANDLING, & STORAGE

- A. In accordance with specification Section 01600.
- B. The manufacturer shall package the pipe in a manner designed to deliver the pipe to the project neatly, intact, and without physical damage. The transportation carrier shall use appropriate methods and intermittent checks to insure the pipe is properly supported, stacked, and restrained during transport such that the pipe is not nicked, gouged, or physically damaged. Pipe shall be stored on clean, level ground to prevent undue scratching or gouging. If the pipe must be stacked for storage, such stacking shall be done in accordance with the pipe manufacturer’s recommendations. The pipe shall be handled in such a manner that it is not pulled over sharp objects or cut by chokers or lifting equipment. Sections of pipe having been discovered with cuts or gouges in excess of 10% of the pipe wall thickness shall be cut out and removed. The undamaged portions of the pipe shall be rejoined using the heat fusion joining method. Fused segments of pipe shall be handled so as to avoid damage to the pipe. Chains or cable type chokers must be avoided when lifting fused sections of pipe. Nylon slings are preferred. Spreader bars are recommended when lifting long fused sections.

## PART 3 EXECUTION

### 3.01 JOINING

- A. Sections of polyethylene pipe shall be joined by the butt fusion process into continuous lengths at the job site. The joining method shall be the heat fusion method and shall be performed in strict accordance with the pipe manufacturer’s recommendations. The heat fusion equipment used in the joining procedures should be capable of meeting all conditions recommended by the pipe manufacturer. Properly executed electrofusion fittings may be used. Extrusion welding or hot gas welding of HDPE shall not be used for pressure pipe applications or fabrications where shear or

structural strength is important. Mechanical joint adapters, flanges, unions, grooved-couplers, transition fittings, and some mechanical couplings may be used to mechanically connect HDPE pipe. Refer to the manufacturer's recommendations.

### 3.02 TRENCHING

- A. Trenching shall be done in accordance with specification Section 02200.

END OF SECTION

## SECTION 02622

### POLYVINYL CHLORIDE GRAVITY PIPE

#### PART 1 GENERAL

##### 1.01 SUMMARY

###### A. Section Includes

1. Requirements for furnishing, installing and testing polyvinyl chloride (PVC) gravity pipe and fittings.

###### B. Related Sections

1. Section 02200 - Earthwork
2. Section 02215 - Aggregate Materials

##### 1.02 REFERENCES

###### A. American Society for Testing and Materials (ASTM) Publications

1. D3034, Specification for Type PSM Poly (vinyl chloride) (PVC) Sewer Pipe and Fittings.
2. D3212, Specification for Joints for Drain and Sewer Plastic Pipes Using Flexible Elastometric Seals.
3. F477, Specification for Elastometric Seals (Gaskets) for Joining Plastic Pipe.
4. F679, Specification for Poly (vinyl chloride) (PVC) Large - Diameter Plastic Gravity Sewer Pipe and Fittings.

##### 1.03 SUBMITTALS

###### A. Shop Drawings

1. In accordance with SECTION 01300 - SUBMITTALS.
2. Submit for review shop drawings showing pipe dimensions, joints, joint gaskets, and other details for each size of pipe to be furnished for the project.
3. All pipe furnished under the contract shall be manufactured only in accordance with the Specifications and the reviewed drawings.

###### B. Samples

1. Submit samples of products if requested by the Engineer.

##### 1.04 QUALITY ASSURANCE

###### A. Certifications



1. All pipe delivered to the job site shall be accompanied by test reports certifying that the pipe and fittings conform to the herein-mentioned ASTM specifications.
2. Pipe shall be subject to thorough inspection and tests, the right being reserved for the Engineer to apply such tests as he deems necessary.
3. All tests shall be made in accordance with the methods prescribed by the herein-mentioned ASTM specifications, and the acceptance or rejection shall be based on the test results.
4. Assist the Engineer in inspecting the pipe upon delivery.
5. Pipe not conforming to the requirements of this contract will be rejected and shall be immediately removed from the site by the Contractor.

#### 1.05 DELIVERY, STORAGE, AND HANDLING

##### A. Storage and Protection

1. All pipe shall be stored at the site until installation in accordance with the manufactures recommendations.

### PART 2 PRODUCTS

#### 2.01 MATERIALS

##### A. Pipe, Fittings, And Specials

1. All gravity sewer pipe shall be a minimum of 8 inches in diameter.
2. Pipe 15” in diameter and smaller shall be PVC SDR 35, in conformance with ASTM D3034 unless otherwise directed.
3. Pipe 18” in diameter and larger shall be PVC C905, DR 32.5, in conformance with ASTM F679 unless otherwise directed.

##### B. Straight Pipe

1. Lengths of not more than 13 ft..

##### C. Y-branches

1. Lengths of not more than 3 ft., unless otherwise permitted by the Engineer.
2. Saddle Y-branches will not be allowed.

##### D. Specials

1. Conform to the specifications for straight pipe as applicable and to the details indicated on the drawings or bound into the back of the specifications.

##### E. Joints

1. Conforming to ASTM D3212.
2. Push-on bell and spigot joints using elastomeric ring gaskets

#### F. Gaskets

1. Conforming to ASTM F477.
2. Securely fixed into place in the bells so that they cannot be dislodged during joint assembly.
3. Composition and texture which is resistant to common ingredients of sewage and industrial wastes, including oils and groundwater, and which will endure permanently under the conditions of the proposed use.

#### G. Lubricant

1. In accordance with manufacturers requirements.

### PART 3 EXECUTION

#### 3.01 PREPARATION

##### A. Inspection of Pipe

1. Inspect each pipe unit before being installed.
2. No single piece of pipe shall be laid unless it is generally straight and undamaged.
3. The centerline of the pipe shall not deviate from a straight line drawn between the centers of the openings at the ends of the pipe by more than 1/16 in. per ft. of length.
4. If a piece of pipe fails to meet this required check for straightness, it shall be rejected and removed from the site.
5. Any pipe unit or fitting discovered to be defective either before or after installation shall be removed and replaced with a sound unit.

##### B. Handling of Pipe

1. Each pipe unit shall be handled into its position in the trench, by such means as acceptable to the Engineer. Care shall be taken to avoid damaging the pipe and fittings.

#### 3.02 INSTALLATION

##### A. Placement

1. Except as otherwise indicated on the drawings, support pipe with compacted crushed stone in accordance with Specification SECTION 02215. No pipe or fitting shall be permanently supported on saddles, blocking, or stones.
2. Provide suitable depressions in crushed stone to accept pipe bells, so that after placement, only the barrel of the pipe receives bearing pressure from the supporting material.
3. Clear pipe and fittings of debris, dirt, etc., before being installed, keep clean until accepted in the completed work.
4. Install pipe and fittings to the lines and grades indicated on the drawings or as required by the Engineer. Care shall be taken to ensure true alignments and

gradients. Unless otherwise instructed, minimum acceptable pipe slope shall be as follows:

Pipe Size	Slope
8"	0.0040 ft/ft
10"	0.0028 ft/ft
12"	0.0022 ft/ft
15"	0.0017 ft/ft
18"	0.0012 ft/ft
24"	0.0008 ft/ft
36"	0.0005 ft/ft

#### B. Joining Pipe

1. Before any joint is made, the previously installed unit shall be checked to assure that a close joint with the adjoining unit has been maintained and that the inverts are matched and conform to the required grade.
2. The pipe shall not be driven down to the required grade by striking it with a shovel handle, timber or other unyielding object.
3. All joint surfaces shall be cleaned. Immediately before jointing the pipe, the bell or groove shall be lubricated in accordance with the manufacturer's recommendation.
4. Each pipe unit shall then be carefully pushed into place without damage to pipe or gasket.
5. Suitable devices shall be used to force the pipe units together so that they will fit with a minimum open recess inside and outside and have tightly sealed joints.
6. Care shall be taken not to use such force as to wedge apart and split the bell or groove ends.
7. Joints shall not be "pulled" or "cramped" unless permitted by the Engineer.
8. Where any two pipe units do not fit each other closely enough to enable them to be properly jointed, they shall be removed and replaced with suitable units.
9. Gasket installation and joint assembly shall follow the directions of the manufacturers of the joint material and of the pipe, all subject to review by the Engineer. The resulting joints shall be watertight and flexible.
10. Open ends of pipe and branches shall be closed with polyvinyl chloride stoppers secured in place in an acceptable manner.

#### C. Rejecting Pipe

1. Pipe of a particular manufacturer may be rejected if there are more than five unsatisfactory joint assembly operations or "bell breaks" in 100 consecutive joints, even though the pipe and joint conform to the appropriate ASTM Specifications as hereinbefore specified. If the pipe is unsatisfactory, as determined above, the Contractor shall, if required, remove all pipe of that manufacturer of the same

shipment from the work and shall furnish pipe from another manufacturer which will conform to all of the requirements of these specifications.

D. Bedding Pipe

1. After each pipe has been properly placed, enough crushed stone shall be placed between the pipe and the sides of the trench, and thoroughly compacted, to hold the pipe in correct alignment.
2. Bell holes (depressions) , provided for jointing, shall be filled with crushed stone and compacted, and then crushed stone shall be placed and compacted to complete the pipe bedding, as indicated on the drawings.

E. Protecting Pipe

1. Take all necessary precautions to prevent flotation of the pipe in the trench.
2. Close the open ends of the pipe with temporary watertight plugs, at all times pipe installation is not in progress.
3. If water is in the trench when work is to be resumed, the plug shall not be removed until suitable provisions have been made to prevent water, earth, or other substances from entering the pipe.
4. Pipelines shall not be used as conductors for trench drainage during construction.

F. Backfilling Pipelines

1. In accordance with SECTION 02200.

3.03 ALLOWABLE PIPE DEFLECTION

- A. Pipe provided under this specification shall be installed not exceeding a maximum deflection of 7.5 percent. Deflection shall be computed by multiplying the amount of deflection (nominal diameter less minimum diameter when measured) by 100 and dividing by the nominal diameter of the pipe.
- B. Upon completion of a section of sewer, including placement and compaction of backfill, the Contractor shall measure the amount of deflection by pulling a specially designed gauge assembly through the completed section. The gage assembly shall be in accordance with the recommendations of the pipe manufacturer and be acceptable to the Engineer.
- C. Should the installed pipe fail to meet this requirement, the Contractor shall do all work to correct the problem as the Engineer may require without additional compensation.

3.04 CLEANING

- A. Care shall be taken to prevent earth, water, and other materials from entering the pipeline. As soon as possible after the pipe and manholes are completed, clean out the pipeline and manholes, being careful to prevent soil, water, and debris from entering any existing sewer.

END OF SECTION

## SECTION 02627

### POLYVINYL CHLORIDE PIPE FOR BURIED LOW PRESSURE SERVICE

#### PART 1 GENERAL

##### 1.01 SECTION INCLUDES

- A. This Specification covers requirements to furnish, install, and test polyvinyl chloride (PVC) pressure pipe, fittings, and appurtenant materials to be used for buried low pressure service.

##### 1.02 RELATED SECTIONS

1. SECTION 02200 - EARTH EXCAVATION, BACKFILL, FILL AND GRADING
2. SECTION 02215 - AGGREGATE MATERIALS
3. SECTION 02629 - UNDERGROUND UTILITY MARKING TAPE
4. SECTION 11961 – INTERIOR AND EXTERIOR PROCESS PIPE

##### 1.03 REFERENCES

- A. American Society for Testing and Materials (ASTM)
  1. D1784, Specification for Rigid Poly (Vinyl Chloride) (PVC) Compounds and Chlorinated Poly (Vinyl Chloride) (CPVC) Compounds.
  2. D2241, Specifications for Poly (Vinyl Chloride) (PVC) Pressure Rated Pipe (SDR-Series).
  3. D3139, Specification for Joints for Plastic Pressure Pipe Using Flexible Elastometric Seals.

##### 1.04 SUBMITTALS

- A. Submit in accordance with SECTION 01300.
  1. Shop Drawings
    - a. Drawings showing pipe dimensions, joints, joint gaskets, restraintment and other details for each size of pipe to be furnished for the project.
    - b. Submit lay schedule delineating types and locations of restraintment.
  2. Samples
    - a. Submit samples of products if requested by the Engineer.

##### 1.05 MARKING, DELIVERY, STORAGE AND HANDLING

- A. Certifications
  1. All pipe delivered to the job site shall be accompanied by test reports certifying that the pipe and fittings conform to the referenced ASTM specifications.

## B. Marking

1. All pipe shall be properly marked by the manufacturer in accordance with ASTM D2241. Markings shall be spaced at intervals of not more than five feet and shall include the following:
  - a. Nominal pipe size
  - b. Type of material with designation code
  - c. Pipe diameter to wall thickness ratio
  - d. ASTM designation with which pipe complies
  - e. Manufacturer's name or trademark and code
- C. Pipe will be inspected upon delivery, and such as does not conform to the requirements of this Contract shall be rejected and shall immediately be removed by the Contractor.
- D. Store pipe at the site until installation, in accordance with the manufacturer's recommendations.

## PART 2 PRODUCTS

### 2.01 MANUFACTURERS

- A. PVC Pipe shall be manufactured by:
  1. J.M. Eagle, Los Angeles California
  2. United States Plastic Corp., Lima, OH
  3. Charlotte Pipe and Foundry, Charlotte, NC
  4. Approved equal

### 2.02 DESIGN

#### A. Pipe

1. Polyvinyl Chloride (PVC) pressure pipe shall conform to the requirements of ASTM D2241 for Class 200, SDR 21 pipe.
2. Manufactured from clean, virgin, approved Class 12454-B compounds, conforming to ASTM D1784, with an established hydrostatic design minimum of 2,000 psi for water at 73 degrees. F.
3. Pipe shall be furnished in maximum 20 foot laying lengths with integral bell joints formed so as to contain a rubber sealing gasket.
4. Joints to be Push-on bell and spigot conforming to the requirement of ASTM D3139.

#### B. Fittings

1. Fittings for use with polyvinyl chloride (PVC) pressure pipe shall be push on joint, conforming to ASTM D3139.
2. Joints shall conform to the requirements of ASTM D3139.
3. Fittings shall be of a pressure classification at least equal to that of the piping with which they are to be used.

4. Fittings related to low pressure sewer structures shall be as detailed on the Drawings.

#### C. Gaskets

1. Composition and texture which is resistant to common ingredients of sewage and industrial wastes, including oils and groundwater, and which will endure permanently under the conditions of the proposed use.

#### D. Lubricants

1. In accordance with manufacturer's requirements.

### 2.03 UNDERGROUND UTILITY MARKING

- A. In accordance with Specification SECTION 02629.

## PART 3 EXECUTION

### 3.01 INSTALLATION

#### A. Inspection of Pipe

1. No defective pipe or fittings shall be laid or placed in the piping, and any piece discovered to be defective after having been laid or placed shall be removed and replaced by a sound and satisfactory piece.

#### B. Handling

1. Each pipe shall be handled into its position in the trench only in such a manner, and by means as acceptable to the Engineer. Care shall be taken to avoid damaging the pipe fittings.

#### C. Installation

1. Each pipe and fitting shall be cleared of all debris, dirt, etc., before being laid and shall be kept clean until accepted in the complete work.
2. In buried pipelines, each pipe shall have a firm bearing along its entire length.
3. Except as otherwise indicated on the drawings, the pipe shall be supported by compacted crushed stone. No pipe or fitting shall be permanently supported on saddles, blocking, or stones. Crushed stone shall be in accordance with SECTION 02215.
4. Suitable bell holes shall be provided, so that after placement, only the barrel of the pipe receives bearing pressure from the supporting material.
5. If cutting is necessary the pipe shall be cut by means of a conventional hand or power saw or an acceptable pipe cutter in accordance with the recommendations of the manufacturer. All field cut ends shall be square and beveled to duplicate the machining of the factory ends as closely as possible in accordance with the recommendations of the manufacturer.

6. Provide restraint as required to keep joints from separating under working and test pressure.

#### D. Joining the pipe

1. Before any joint is made, the previously installed unit shall be checked to assure that a close joint with the adjoining unit has been maintained and that the inverts are matched and conform to the required grade. The pipe shall not be driven down to the required grade by striking it with a shovel handle, timber or other unyielding object.
2. All joint surfaces shall be cleaned. Immediately before jointing the pipe, the bell or groove shall be lubricated in accordance with the manufacturer's recommendation. Each pipe unit shall be then carefully pushed into place without damage to pipe or gasket. Suitable devices shall be used to force the pipe units together so that they will fit with a minimum open recess inside and outside and have tightly sealed joints. Care shall be taken not to use such force as to wedge apart and split the bell or spigot ends.
3. Joints shall not be "pulled" or "cramped" unless permitted by the Engineer.
4. Where any two pipe units do not fit each other closely enough to enable them to be properly jointed, they shall be removed and replaced with suitable units and new gaskets.
5. Details of gasket installation and joint assembly shall follow the directions of the manufacturer, all subject to review by the Engineer.

#### E. Bedding Pipe

1. After each pipe has been properly placed, enough gravel shall be placed between the pipe and the sides of the trench, and thoroughly compacted, to hold the pipe in correct alignment.
2. Bell holes (depressions), provided for jointing, shall be filled with crushed stone and compacted, and then crushed stone shall be placed and compacted to complete the pipe bedding, as indicated on the Drawings.

#### F. Protection of Pipe

1. Take all necessary precautions to prevent flotation of the pipe in the trench.
2. At all times pipe installation is not in progress, the open ends of the pipe shall be closed with temporary watertight plugs, or by other acceptable means.
3. If water is in the trench when work is to be resumed, the plug shall not be removed until suitable provisions have been made to prevent water, earth, or other substances from entering the pipe.
4. Pipelines shall not be used as conductors for trench drainage during construction.

#### G. Backfilling Pipelines

1. In accordance with SECTION 02200.



### 3.02 TESTING

#### A. Pressure and Leakage Tests

1. Except as otherwise directed, all pipelines shall be given combined pressure and leakage tests in sections of suitable length.
2. Furnish and install suitable temporary testing plugs or caps; all necessary pressure pumps, pipe connections, meters, gages, relief valves, and other necessary equipment: and all labor required.
3. Subject to the permission of the Engineer and provided that the tests are made with a reasonable time considering the progress of the project as a whole, and the need to put the section into service, the Contractor may make the tests when he desires.
4. Fill the section of pipe to be tested with water of acceptable quality. All air shall be expelled from the pipe. If blowoffs are not available at high points for releasing air then make the necessary taps at such points. Plug said holes after completion of the test.
5. The section under test shall be maintained full of water for a period of 24 hours prior to the combined pressure and leakage test being applied. The pressure and leakage test shall consist of first raising the water pressure (based on the elevation of the lowest point of the section under test and corrected to the gage location) to a pressure in pounds per square inch numerically equal to the pressure rating of the pipe but not to exceed 160 psi. Care shall be taken not to apply this pressure to items of equipment known to be incapable of withstanding such pressure.
6. If specified pressure cannot achieve and maintained for a period of one hour with no additional pumping, the section shall be considered as having failed to pass the test.
7. If the section fails to pass the pressure and leakage test, locate, uncover, and repair or replace the defective pipe, fitting, or joint, all at the Contractors expense and without extension of time for completion of the work. Additional tests and repairs shall be made until the section passes the specified test and is considered acceptable by the Engineer.
8. If, in the judgment of the Engineer, it is impracticable to follow the foregoing procedure exactly for any reason, modifications in the procedure may be made as required and permitted by the Engineer, but in any event the Contractor shall be fully responsible for the ultimate tightness of the line within the above leakage and pressure requirements.

### 3.03 UNDERGROUND UTILITY MARKING TAPE

- A. Install as detailed in the Contract Documents.

END OF SECTION

## SECTION 02629

### UNDERGROUND UTILITY MARKING TAPE

#### PART 1 GENERAL

##### 1.01 SECTION INCLUDES

- A. Requirements for furnishing and installing metallic (detectable) and non-metallic (non-detectable) marking tape over buried pipelines and conduits.

##### 1.02 REFERENCES

- A. A.P.W.A. - American Public Works Association

##### 1.03 SUBMITTALS

###### A. Shop Drawings

1. Submit in accordance with SECTION 01300 - SUBMITTALS

###### B. Samples

1. Provide samples of submitted products.

##### 1.04 DESCRIPTION

###### A. General

1. Marking tape to be installed over all pipe lines and conduits installed under this Contract.
2. Marking tape for non-ferrous pipe or conduits to be Detectable, magnetic type.
3. Marking tape for ferrous pipe or conduits to be Non-detectable, non-magnetic type.
4. Tape to be 6-inches wide.

#### PART 2 PRODUCTS

##### 2.01 MANUFACTURERS

###### A. Underground utility marking tape to be:

1. Detectable: Magnatec by THOR Enterprises, Inc., Sun Prairie, WI.
2. Non-detectable: Shieldtec by THOR Enterprises, Inc., Sun Prairie, WI.
3. Or product deemed equal by the Engineer.

##### 2.02 MATERIALS

###### A. Detectable Underground Utility marking Tape

1. Minimum overall thickness: 5.0 mil (0.005").
2. Aluminum foil core: 35 gauge (0.00035") minimum.
3. Foil visible from both sides of tape.
4. Protective plastic jacket applied to both sides of foil.

5. Jacket adhesive applied directly to the film and foil.
  6. No printing to extend to the edges of the tape.
  7. No Dilutants, pigments or contaminants in the adhesive.
  8. Adhesive formulated to resist degradation by elements normally found in soil.
- B. Non-detectable Underground Utility marking Tape
1. Minimum overall thickness: 4.0 mil (0.004”).
  2. Polyethylene plastic film: 100% virgin, low density acid and alkali-resistant.
  3. Printing: Permanent, black, environmentally safe.
  4. Coloring: color-fast, lead free, organic pigments suitable for direct burial and prolonged exposure to the elements normally found in soil.
- C. Marking
1. Tape to printed with “BURIED *UTILITY* LINE BELOW”, replacing the word “*UTILITY*” with the word “WATER”, “SEWER”, “DRAIN”, “ELECTRIC”, “GAS”, or otherwise appropriate, repeating continuously every 30-inches max.
- D. Color Code in accordance with A.P.W.A. Standards as follows:
- |                                  |  |
|----------------------------------|--|
| 1. Safety Red                    | Electric power and high voltage lines                              |
| 2. High Visibility Safety Yellow | Gas and oil distribution/Transmission<br>Dangerous materials/Steam |
| 3. Safety Alert Orange           | Fiber optic/telephone/CATV   |
| 4. Safety Precaution Blue        | Water and irrigation lines   |
| 5. Safety Green                  | Sewer/storm/sanitary systems, non-potable<br>water                 |
| 6. Safety Brown                  | Force mains and effluent lines                                     |
| 7. Alert Purple                  | Reclaimed and effluent re-use lines                                |

## PART 3 EXECUTION

### 3.01 INSTALLATION

- A. Install marking tape directly above the pipe line or conduit tape is to identify, approximately, 24-inches below the proposed finished grade.
- B. Install marking tape in accordance with manufacturers recommendations.
- C. Install marking tape over existing utilities disturbed by the Contractors operation.

END OF SECTION

## SECTION 02831

### CHAIN LINK FENCES AND GATES

#### PART 1 GENERAL

##### 1.01 SECTION INCLUDES

- A. Requirements to furnish and install the 10 foot high chain-link fence, gates, and accessories.

##### 1.02 DESIGN REQUIREMENTS

- A. The fence shall be of the height indicated and shall have a top and bottom rail.
- B. Fence materials and installation shall meet or exceed the standards of the Chain Link Fence Manufacturers Institute, Columbia, MD., except as otherwise specified in this section; also fence materials shall meet or exceed Fed. Spec. RR-F-191G/GEN for Fencing, Wire and Post Metal (and Gates, Chain-link Fence Fabric, and Accessories), and shall conform to the ASTM Standards noted in this Specification.

##### 1.03 RELATED SECTIONS

- A. Section 03300 - Cast-In-Place Concrete.

##### 1.04 REFERENCES

- A. Fed. Spec. RR-F-191/1A, Type V, for Fencing, Wire and Post, Metal (Chain-link Fence Fabric).
- B. American Society for Testing and Materials
  1. A392, Specification for Zinc-Coated Steel Chain-Link Fence Fabric.
  2. F 626, Specification for Fencing Fittings
  3. F668, Standard Specification for Poly (Vinyl Chloride) (PVC)-Coated Steel Chain Link Fence Fabric.
  4. F669, Standard Specification for Strength Requirements of Metal Posts and Rails for Industrial Chain Link Fence.
  5. F900, Standard Specification for Industrial and Commercial Swing Gates.
  6. F934, Standard Specification for Standard Colors for Polymer Coated Chain Link Fence Materials.
  7. F1043, Specification for Strength and Protective Coatings on Metal Industrial Chain Link Fence Framework
  8. F1083, Specification for Pipe, Steel, Hot-Dipped Zinc-Coated (Galvanized) Welded, for Fence Structures.
  9. F1234, Protective Coatings on Steel Framework for Fences.
  10. F1664, Specification for Poly (Vinyl Chloride) (PVC)-Coated Steel Tension Wire Used with Chain Link Fence.

## 1.05 SUBMITTALS

- A. Shop Drawings, submit in accordance with SECTION 01300.
  - 1. Include detailed information, specifications, sizes and dimensions for all materials, accessories, and finishes.
  - 2. Submittals shall include certification of compliance with the American Iron and Steel requirements of P.L. 113-76, the Consolidated Appropriations Act of 2014.
- B. Samples
  - 1. Submit samples of the fencing materials to be used, in accordance with the requirements of SECTION 01300.
  - 2. Each sample shall be identified by mark or tag.
  - 3. Samples to include:
    - a. 2-inch length of each type of post.
    - b. 2-inch length of each type of brace and railing.
    - c. 2-inch length of framework for gates.
    - d. 2-inch length of diagonal truss brace.
    - e. 2-inch length of tension wire.
    - f. Each type of fitting used at terminal posts.
    - g. Fittings used at line posts.
    - h. Fittings for the gate leaf frame.
    - i. Gate hinge.
    - j. Gate latch.
    - k. Stretcher bar, 2-inch length.
    - l. Bolt and nut fastener.
    - m. Fence fabric, 2 weaves, 2 meshes long.
    - n. Tie.
    - o. Padlock with key and steel chain, 6-inch length.
  - 4. Accompanying the samples, the Contractor shall submit a written statement that samples submitted comply with the requirements of these Contract Documents.
  - 5. Samples shall be submitted for review at least 30 days prior to fence installation.
- C. Quality Control Submittals
  - 1. Manufacturer's recommended installation instructions.
  - 2. Evidence of Supplier and installer qualifications.

## PART 2 PRODUCTS

### 2.01 GENERAL

- A. Match style, finish, and color of each fence component with that of other fence components.
- B. All fittings, post, fence and gate framework, and all accessories shall be galvanized steel, then coated with PVC.

### 2.02 CHAIN LINK FABRIC

- A. A. Vinyl-coated steel chain link fabric shall be No. 8 finished gauge, woven wire, to a uniform square mesh measuring  $2\pm 1/8$ -inches between its parallel sides. Galvanized core

wire shall be No. 9 gauge, of good commercial quality steel and shall be uniformly galvanized with a zinc-coat-weight of at least 0.30 oz per sq. ft. The galvanized wire shall then be coated with a molecular bonding layer and a minimum 20 mil vinyl coating, continuously extrusion-bonded (not sprayed or dipped) by a thermal extrusion-bonding process to insure a dense and impervious covering, free of voids and having a smooth and lustrous appearance. Unbonded coatings are not acceptable. The vinyl coating shall not be capable of being stripped from the wire with wire strippers. The wire shall be vinyl-clad before weaving and shall be free and flexible at all joints. The bond shall exhibit equal or greater strength than the cohesive strength of the vinyl. All cut ends shall be coated with vinyl at the factory during the weaving process.

- B. Fabric shall measure 6 feet in height and be knuckled at top selvage and twisted and barbed at bottom selvage.
- C. Color of the PVC coating: Black, and shall match the color of the total fence system.

## 2.03 FENCE POSTS, RAILS AND BRACES

### A. General

- 1. In accordance with ASTM F669, Heavy Industrial Fence.
- 2. Protective Coatings: Zinc Coating; ASTM F1234, Type A external and internal coating.
- 3. Color coating: ASTM F934, minimum 10 mils thickness of PVC over zinc coating to match color of chain link fabric.
- 4. All framework shall be SS-40 pipe.

### B. Line Posts

- 1. 2.875 inch outside diameter steel pipe weighing not less than 4.64 lb. per ft.,

### C. End, Corner, and Pull Posts

- 1. 4.00 inch outside diameter steel pipe weighing not less than 6.56 lb. per ft.,

### D. Top and bottom railings and railings for top, middle and bottom braces between terminal posts and adjacent line posts.

- 1. 1 5/8 inch outside diameter steel pipe weighing not less than 1.84 lb. per ft.,

## 2.04 TENSION WIRE

- A. No. 7-gage, marcelled, coated steel wire conforming to ASTM A824 Type II Zinc coated Class 2, 1.20 oz/sf.

## 2.05 TIE WIRES

- A. 6 gage (outside diameter) galvanized steel wire for fastening fence fabric to line posts and rails.

## 2.06 STRETCHER BARS

- A. Flat bars with minimum cross section dimensions of not less than 3/16 inch by 3/4 inch.

- B. Not less than 2 inches shorter than height of the fabric with which they are to be used.

## 2.07 BANDS OR CLIPS

- A. Bar bends of not less than 11-gage sheet steel,  $\frac{3}{4}$  inches wide for posts 4 inch OD or less and  $\frac{7}{8}$  inches wide for posts greater than 4 inch OD, in accordance with ASTM F626, and bolted with  $\frac{5}{16}$  inch diameter galvanized carriage bolts and nuts.

## 2.08 DIAGONAL TRUSS

- A. Use between terminal and adjacent line posts and for gate framework.
  - 1.  $\frac{3}{8}$  inch diameter steel rod.

## 2.09 FITTINGS

- A. Malleable iron or pressed steel of suitable size to produce strong construction.
- B. Post Caps
  - 1. Accommodate passage of top rail.

## 2.10 GATES

- A. General
  - 1. In accordance with ASTM F900.
  - 2. Gate capable of being opened and closed easily by one person.
  - 3. Paint welded steel joints with zinc-based paint.
  - 4. Attach chain link fabric securely to gate frame at intervals not exceeding 15 inches.
- B. Gate posts for gate leaves up to and including 6 ft. wide.
  - 1. 2.875 inch outside diameter steel pipe weighing not less than 4.64 lb. per ft.,
  - 2. or 3.50 inch by 3.50 inch roll-formed, steel corner section weighing not less than 5.00 lb. per ft.
- C. Gate posts for gate leaves over 6 ft. up to and including 12 ft. wide.
  - 1. 4.00 inch outside diameter steel pipe weighing not less than 6.56 lb. per ft.,
- D. Gate Posts for gate leaves over 13 ft. wide and up to and including 18 ft. 6.625 in. outside diameter steel pipe weighing not less than 18.02 lb. per ft.
- E. Gate Leaf framework
  - 1. 2 inch outside diameter steel pipe weighing not less than 2.28 lb. per ft.
- F. Hinges
  - 1. Heavy pattern of adequate strength for the gate size.
  - 2. Large bearing surfaces for clamping or bolting in position.
- G. Gate Stops
  - 1. Mushroom type or flush plate with anchors, suitable for setting in concrete.

#### H. Cantilever Sliding Gate

1. The cantilever sling gate shall be "freehanging" type, single leaf, and sized as shown on the Drawings. The gate manufacturer shall supply sliding gates of appropriate construction, which will be structurally stable and meeting the intended dimensions. The gate shall be manufactured by Anchor Fence/Master Halco Inc., Cyclone Fence, Page Fence, or approved equal.
2. The gate shall be provided with two roller truck assemblies, which operate within a combined track and top gate frame member. The roller truck assemblies shall provide vertical support and lateral movement control to insure alignment of the truck in the track. The roller truck assemblies shall be fastened to gate posts with 7/8-inch diameter ball bolts with 1/2-inch shank.
3. The gate frame shall be constructed of 2-inch square aluminum tubing alloy 6063-T6, weighing 0.94 lbs per linear foot, welded at the joints. The combined track and top frame member shall be extruded aluminum-sized per manufacturer's recommendations. The bottom frame member shall be 2-inch by 4-inch aluminum tubing weighting 1.71 pounds per linear foot.
4. Support posts for the cantilever slide gate shall be of 4-inch outside diameter, Schedule 40 steel pipe, ASTM A-120, as specified above.
5. Vertical uprights and diagonal truss rods shall be provided as necessary to insure rigidity of the gate frame and prevent sagging.
6. Appurtenant hardware including roller guide assemblies for each support post, latch assembly with provisions for padlocking, and gate stop assembly shall be provided.

#### I. Locking Mechanism

1. Provide with a suitable latch accessible from both sides and with provision for padlocking.
2. Double leaf swing gates shall have a center bolt, center stop, and automatic backstops to hold leaves in open position.
3. Padlocks
  - a. Solid brass cases.
  - b. Hardened steel shackles.
  - c. Removable core cylinders.
  - d. Galvanized steel chains attached to the shackle by a clevis.
  - e. Padlocks shall be manufactured by Eaton Corp Lock & Hardware Div., Yale Marketing Dept., Charlotte, N.C.; & P&F. Corbin, Div. of Emhart Corp., Berlin, Conn.; Best Universal Lock Co., Inc., Indianapolis, Ind.; or be an acceptable equivalent product.
  - f. Padlocks shall be furnished with four keys each.

#### 2.11 FOUNDATIONS

- A. Concrete for post foundation bases shall be in accordance with SECTION 03300.
- B. Grout for posts set in solid rock shall consist of one part Portland cement and three parts of clean, sharp, well-graded sand with just enough water for proper workability.



## PART 3 EXECUTION

### 3.01 GENERAL

- A. The fence and gates shall be erected by skilled mechanics.
- B. Any change in direction of the fence line of 30 degrees or more shall be considered corners. Pull posts shall be used at any abrupt change in grade.
- C. Maximum area of unbraced fence shall not exceed 1,500 square feet.
- D. Terminal posts shall be braced to adjacent posts with horizontal brace rails and diagonal truss rods brought to proper tension so that posts are plumb.
- E. There shall be no loose connections or sloppy fits in the fence framework. The fence framework shall withstand all wind and other forces due to the weather.

### 3.02 POST SETTING

- A. Post spacing shall uniform with maximum spacing of 10 ft. in fences erected along straight lines. All posts shall be placed plumb and centered in the concrete foundations.
- B. Post foundations in earth shall be concrete cylinders with a minimum diameter of 12 inches, crowned at grade to shed water, and shall not be less than 36 inches deep in the ground. Posts shall be set in the full depth of the foundations except for 3 inch of concrete under the posts.
- C. Coat portion of galvanized or aluminum-coated steel post that will be embedded in concrete with Bitumastic Super Service Black, manufactured by the Koppers Co.; 450 Heavy Themecol, manufactured by Tnemec Co., North Kansas City, MO; or an acceptable equivalent product. Extend coating to 1-inch above top of finished concrete.
- D. If foundation holes are excavated in peat or other unstable soil, the Engineer shall be notified for determination of suitable construction precautions.
- E. If solid ledge is encountered without overburden of soil, posts shall be set into the rock a minimum depth of 12 inch for line posts and 18 inch for terminal posts. Post holes shall be at least 1 inch greater in diameter than the post and the grout shall be thoroughly worked into the hole so as not to leave voids, and shall be crowned at the top to shed water. Where solid rock is covered by an overburden, the total setting depth shall not exceed the depths required for setting in earth, and the posts shall be grouted into the rock as described.

### 3.03 FENCE FABRIC

- A. Fabric shall be stretched taut and tied to posts, rails, and tension wires with the bottom edge following the finished grade not more than 2 inch above the grade. The fabric shall be installed on the security side of the fence and shall be anchored to the framework so that the fabric remains in tension after pulling force is released. The fabric shall be attached to line posts with tie wires spaced at not more than 15 inch intervals and to rails and braces at not

more than 24 inch intervals. The fabric shall be attached to the tension wire with hog ring ties on 24 inch centers.

3.04 GATES

- A. Gates shall be installed plumb, level, and secure for the full width of the opening and the hardware adjusted for smooth operation.

3.05 GATE OPERATOR SYSTEMS

- A. Install gate operator system in accordance with manufacturer's recommendations.
- B. Furnish with equipment and accessories necessary for complete installation.

3.06 ELECTRICAL GROUNDING

- A. Ground fences in accordance with applicable requirements of National Electric Safety Code.

END OF SECTION

## SECTION 02930

### LOAMING AND SEEDING

#### PART 1 GENERAL

##### 1.01 SECTION INCLUDES

- A. Requirements for loaming, fertilizing, seeding, and related work in areas disturbed in the process of performing the Work under this contract.

##### 1.02 SUBMITTALS

- A. In accordance with SECTION 01300 submit the following:
  - 1. Submit with seed, certificates confirming seed mixture, purity, germinating value, and crop year identification.
  - 2. Submit test samples of loam.

##### 1.03 DELIVERY, STORAGE AND HANDLING

- A. Fertilizer:
  - 1. Delivered mixed as specified in standard size, unopened containers showing weight, analysis, and name of manufacturer.
  - 2. Store in weather proof place.
- B. Seed:
  - 1. Delivered in original unopened containers with mixture listed.

#### PART 2 PRODUCTS

##### 2.01 LOAM

- A. Fertile, natural topsoil, typical of locality, without admixture of subsoil, refuse or other foreign materials, and obtained from well-drained arable site. Mixture of sand, silt and clay particles in approximately equal proportions. Free of stumps, roots, heavy or stiff clay, stones large than 1 inch in diameter, lumps, coarse sand, noxious weeds, sticks, brush or other deleterious matter.
- B. Not less than 4 percent nor more than 20 percent organic matter as determined by loss on ignition of oven-dried samples.
- C. Loam test samples dried to constant weight at temperature of 230 degrees. F., plus or minus nine degrees.
- D. Use loam, having prior vegetative growth that did not contain toxic amounts of either acid or alkaline elements.

2.02 LIME, FERTILIZER AND SEED

- A. Ground agricultural limestone containing not less than 85 percent of total carbonates.
- B. Complete fertilizer, at least 50 percent of nitrogen derived from natural organic sources of ureaform and containing following percentages by weight:

Nitrogen 10%                      Phosphorus 10%                      Potash 10%

- C. Turf grass seed, clean, high in germinating value and latest year's crop mixture as follows:

Name	<b>Minimum Proportion by Weight</b>	<b>Percent Purity</b>	<b>Percent Germination</b>
Kentucky bluegrass	20%	87%	85%
Merion Kentucky bluegrass	20%	87%	85%
Red Chewings fescue	45%	98%	85%
Italian rye	15%	98%	90%

PART 3 EXECUTION

3.01 GENERAL

- A. Supply suitable quantities of water, hose and appurtenances.

3.02 LOAM

- A. Spread loam on areas to 6-inch depth after compaction, fine grade and compact.

3.03 LIME, FERTILIZER AND SEEDING

- A. Apply lime by mechanical means at rate of 3000 pounds per acre.
- B. Apply fertilizer at rate of 1200 pounds per acre.
- C. Remove weeds or replace loam and reestablish finish grades, if any delays in seeding lawn areas and weeds grow on surface or loam is washed out prior to sowing seed and without additional compensation. Sow seed at rate of 175 pounds per acre on calm day, by mechanical means. "Hydro-Seeding" not permitted unless otherwise permitted or required by Engineer. Sow one-half of seed in one direction, and other half at right angles to original direction. Rake seed lightly into loam, to depth of not more than 1/4 inch and compact by means of an acceptable lawn roller weighing 100 to 150 pounds per linear foot of width.
- D. Water lawn areas adequately at time of sowing and daily thereafter with fine spray, and continue throughout maintenance and protection period.
- E. Seed during approximate time periods of April 1 to May 15 and August 15 to October 1, and only when weather and soil conditions are suitable for such work, unless otherwise permitted.

### 3.04 MAINTENANCE OF SEEDED AREAS

- A. Maintain lawn areas and other seed areas at maximum height of 2-1/2 inches by mowing at least three times. Weed thoroughly once and maintained until time of final acceptance. Reseed and refertilize with original mixtures, watering or whatever is necessary to establish over entire area of lawn and other seeded areas a close stand of grasses specified, and reasonably free of weeds and undesirable coarse native grasses.
- B. Begin maintenance immediately after each portion of lawn is seeded and continue for minimum of 45 days.
- C. Repair or replace all seeded areas which, in judgment of Engineer, have not survived and grown in satisfactory manner, for a period of one year after acceptance.
- D. Seeding replacement, same seed mixture as specified and furnished and installed as specified.

### 3.05 TEMPORARY COVER CROP

- A. Sow a temporary cover crop of buckwheat, domestic rye grass or other acceptable seed if there is insufficient time in the planting season to complete seeding, fertilizing, and permanent seeding at the option of Contractor or order of Engineer. Cut and water cover crop as necessary until the beginning of the following planting season, at which time it shall be plowed or harrowed into soil, the areas shall be fertilized and permanent seed crop sown as specified.

END OF SECTION

## **DIVISION 03**

## SECTION 03100

### CONCRETE FORMWORK

#### PART 1 GENERAL

##### 1.01 SUMMARY

###### A. Section Includes

1. Requirements for forms to be used for all concrete masonry including footings, except as otherwise permitted.

###### B. Related Sections

1. Section 03200 - Concrete Reinforcement.
2. Section 03300 - Cast-In-Place Concrete.

##### 1.02 REFERENCES

###### A. American Concrete Institute (ACI)

1. ACI 350, Code Requirements for Environmental Engineering Concrete Structures
2. ACI 347R, Guide to Formwork for Concrete.

##### 1.03 SUBMITTALS

###### A. Submit in accordance with Section 01300.

###### B. Shop Drawings:

1. Layout of panel joints, tie hole pattern, and form liners.
2. Form Ties - Tapered Through-Bolts: Proposed method of sealing form tie hole; coordinate with details shown.

###### C. Samples: One each as follows:

1. Form liners.
2. Form ties.

###### D. Quality Control Submittals:

1. Statements of qualifications for formwork designer.
2. Manufacturer's Certificate of Proper Installation. (After installation)

##### 1.04 QUALITY ASSURANCE

- ###### A. Qualifications: Formwork, falsework, and shoring designs prepared by an engineer licensed in the State of Massachusetts.

## PART 2 PRODUCTS

### 2.01 FORM MATERIALS

#### A. Surfaces to be given burlap-rubbed finish.

1. Form surface in contact with the concrete shall be made of heavy gage metal, new plywood (used plywood which, in the opinion of the Engineer, is substantially equal to new plywood may be used), tempered wood fiberboards with smooth surface, or similar materials.
2. Metal forms or form linings shall have square edges so that the concrete will not have fins or fluting. Joints between form panels shall be well fitted so as to be tight and result in substantially flush concrete surfaces on opposite sides of the joints.
3. Forms shall not be pieced out by use of materials different from those in the adjacent form or in such manner as will detract from the uniformity of the finished surface.

#### B. Surfaces other than those to be given burlap-rubbed finish.

1. Forms shall be made of wood, metal, or other acceptable material. Wooden forms shall be constructed of sound lumber or plywood of suitable dimensions, free from knotholes and loose knots. Plywood shall be reasonable good, as accepted. Metal forms shall be of an acceptable type for the work involved. Edges of forms in contact with concrete shall be flush within 1/16 in.

#### C. Forms shall be of suitable material, design, and construction as to be rigid, tight enough to prevent the passage of mortar, and plane surfaces shall be plane within 1/16 in. in 4 ft. Particular care shall be taken to ensure that forms are true to line where deviations in the concrete would be obvious or objectionable, as where building superstructures are to be built thereon, or where the tops of walls are exposed. All such deviations which may occur shall be corrected by, and at the expense of the contractor, as directed, even to the extent of tearing down and rebuilding the concrete.

#### D. Forms for walls, columns, or piers shall have removable panels at the bottom for cleaning, inspection, and scrubbing-in of bonding grout. Forms for thin sections (such as walls or columns) of considerable height shall be arranged with suitable openings so that the concrete can be placed in a manner that will prevent segregation and accumulations of hardened concrete on the forms or reinforcement above the fresh concrete, unless special spouts are used to place concrete, and so that construction joints can be properly keyed and treated.

#### E. Forms shall be sufficiently rigid to prevent displacement or sagging between supports, and so constructed that the concrete will not be damaged by their removal. The Contractor shall be entirely responsible for their adequacy.

#### F. Wall Forms and Underside of Slabs and Beams:

1. Materials: Plywood, hard plastic finished plywood, overlaid waterproof particle



board, or steel in “new and undamaged” condition, of sufficient strength and surface smoothness to produce specified finish. Use in combination with form liners where required.

G. All Other Forms: Materials as specified for wall forms.

H. Form Sealer:

1. Material: Surface sealer will not bond with, stain, or adversely affect concrete surfaces, and will not impair subsequent treatments of concrete surfaces, when applied to most forms of form liners. A ready-to-use water based material formulated to reduce or eliminate surface imperfections, containing no mineral oil or organic solvents. Environmentally safe, meeting local, state, and federal regulations and can be used in clean water treatment plants.
2. Manufacturer and Product: Master Builders, Inc.; Rheofinish; or Equal.

I. Rustication Grooves and Beveled Edge Corner Strips: Nonabsorbent material, compatible with form surface, fully sealed on all sides prohibiting loss of paste or water between the two surfaces. Match the rustication grooves with the existing configuration and style located at the plant.

## 2.02 FORM TIES

A. Form ties to be encased in concrete shall not be made of through-bolts or commonwire, but shall be of a well-established type, so made and installed as to embody the following features:

1. After removal of the protruding part of the tie, there shall be no metal nearer than 1 in. to the face of the concrete.
2. The part of the tie which is to be removed shall be at least 1/2 in. in diameter, or if smaller, it shall be provided with a wood or metal cone 1 in. long placed against the inside of the forms. cones shall be carefully removed from the concrete after the forms have been striped.
3. Ties which pass through walls subject to hydrostatic pressure shall be provided with acceptable water stops, such as washers, securely fastened to the ties.

B. Form Ties:

1. Material: Steel.
2. Spreader Inserts.
  - a. Conical or spherical type.
  - b. Design to maintain positive contact with forming material.
  - c. Furnish units that will leave no metal closer than 1 inch to concrete surface when forms, inserts, and tie ends are removed.
3. Wire ties not permitted.
4. Flat bar ties for panel forms, furnish plastic or rubber inserts with minimum 1 inch depth and sufficient dimensions to permit patching of tie hole.
5. Water Stop Ties: For water-holding structures, basements, pipe galleries, and accessible spaces below finish grade, furnish one of the following:
  - a. Integral steel water stop 0.103-inch thick and 0.625 inch in diameter tightly and continuously welded to tie.
  - b. Neoprene water stop 3/16-inch thick and 15/16 inch in diameter whose center

- hole is 1/2 diameter of tie, or a molded plastic water stop of comparable size.
- c. Water Stop: Oriented perpendicular to tie and symmetrical about center of tie.
- d. Design ties to prevent rotation or disturbance of center portion of tie during removal of ends and to prevent water leaking along tie.
- 6. Through-Bolts: Tapered minimum 1-inch diameter at smallest end.
- 7. Elastic Vinyl Plug: Design and size of plug to allow insertion with tool to enable plug to elongate and return to original length, and diameter upon removal forming a watertight seal.
  - a. Manufacturer and Product: Dayton Superior Co., Miamisburg, OH; Dayton Sure Plug, or equal.

## PART 3 EXECUTION

### 3.01 SYSTEM DESIGN REQUIREMENTS

- A. Design formwork in accordance with ACI 347R and ACI 318 to provide the concrete finishes specified in Section 03300, CAST-IN-PLACE CONCRETE.
- B. Make joints in forms watertight.
- C. Limit panel deflection to 1/360 of each component span to achieve tolerances specified.

### 3.02 ERECTION

- A. General: Unless specified otherwise, follow the applicable recommendations of ACI347R.
- B. Forms shall be so constructed and placed that the resulting concrete will be of the shape, lines, dimensions, and to the elevations indicated on the drawings or specified, and exposed concrete will be substantially free from board or grain marks, poorly matched joints, and other irregularities or defects.
- C. Beveled Edges (Chamfer):
  - 1. Form 3/4-inch bevels at concrete edges, unless otherwise shown.
  - 2. Where beveled edges on existing adjacent structures are other than 3/4-inch, obtain ENGINEER's approval of size prior to placement of beveled edge.
- D. Wall Forms:
  - 1. Do not reuse forms with damaged surfaces.
  - 2. Locate form ties and joints in an uninterrupted pattern for smooth and uniform surface.
  - 3. Inspect form surfaces prior to installation to assure conformance with specified tolerances.
- E. Forms for Curbs, Sidewalks, and Driveways:
  - 1. Provide standard steel or wood forms to prevent movement.
  - 2. Set forms to true lines and grades, and securely stake in position.
- F. Form Tolerances: Provide forms in accordance with ACI 347R and ACI 318 and the following tolerances for finishes specified:

1. Wall Tolerances:
  - a. Straight Vertical or Horizontal Wall Surface: Flat planes within tolerance specified.
  - b. Plumb within 1/4-inch to 10-feet.
  - c. Depressions in Wall Surface: Maximum 5/16-inch when 10-foot straightedge is placed on high points in all directions.
  - d. Thicknesses: Maximum 1/4-inch minus or 1/2-inch plus from dimensions shown.
2. Slab Tolerances:
  - a. Exposed Slab Surfaces: Comprise of flat planes as required within tolerances specified.
  - b. Slab Finish Tolerances and Slope Tolerances: Crowns on floor surface not too high as to prevent 10-foot straight edge from resting on end blocks, nor low spots that allow a block of twice the tolerance in thickness to pass under the supported 10-foot straightedge.
  - c. Steel gauge block 5/16-inch thick.
  - d. Slab drainage.
    - 1) Finish Slab Elevation: Slope slabs to floor drain and gutter, and shall adequately drain regardless of tolerances.
    - 2) Thickness: Maximum 1/4-inch minus or 1/2-inch plus from thickness shown, except where thickness tolerance will not affect slope, drainage, or slab elevation.

### 3.03 FORM SURFACE PREPARATION

- A. Thoroughly clean form surfaces in contact with concrete or previous concrete, dirt, and other surface contaminants prior to coating surface.
- B. Exposed Wood Forms in Contact with Concrete: Apply form sealer as recommended by the sealer material manufacturer.
- C. Steel Forms: Apply form sealer to steel forms as soon as they are cleaned to prevent discoloration of concrete from rust.

### 3.04 FORM COATINGS

- A. All forms shall be oiled with an acceptable nonstaining oil or liquid form coating before reinforcement is placed.
- B. Before form material is reused, all surfaces that are in contact with the concrete shall be thoroughly cleaned, all damaged pieces repaired, and all projecting nails withdrawn.

### 3.05 REMOVAL OF FORMS

- A. Except as otherwise specifically authorized by the Engineer, forms shall not be removed until the concrete has aged for the following number of day-degrees\*:
  1. Formwork not supporting weight of concrete, (i.e., sides of beams, walls, columns, and similar parts of the Work) may be removed after cumulatively curing at not less than a total of three 50-degree F days after placing concrete,

provided concrete is sufficiently hard to not be damaged by form-removal operations, and provided curing protection operations are maintained.

2. Leave forms and shoring for elevated structural slabs or beams in place, in accordance with ACI 318, Chapter 6, and until concrete has reached compressive strength equal to 80 percent of the specified 28-day compressive strength as determined by test cylinders.
3. \*Day-degree: total number of days times average daily air temperature at surface of concrete. For example, 5 days at a daily average temperature of 60 deg. F. equals 300 day-degrees.

### 3.06 MANUFACTURER'S SERVICES

- A. Provide form manufacturer's representative at site for installation assistance, and inspection.

END OF SECTION

## SECTION 03200

### CONCRETE REINFORCEMENT

#### PART 1 GENERAL

##### 1.01 SUMMARY

###### A. Section Includes

1. Requirements for reinforcing steel bars, wire fabric and accessories as shown on the drawings, specified herein, and as needed for a complete and proper installation.

###### **B. All concrete reinforcement specified in this section shall be produced in the United States in accordance with the American Iron and Steel requirements of P.L. 113-76, the Consolidated Appropriations Act of 2014.**

##### 1.02 RELATED SECTIONS

- A. Section 03100 - Concrete Formwork.
- B. Section 03300 - Cast-In-Place Concrete.

##### 1.03 REFERENCES

###### A. American Society for Testing and Materials (ASTM).

1. A82, Specification for Steel Wire, Plain for Concrete Reinforcement.
2. A185, Specification for Steel Welded Wire Fabric, Plain, for Concrete Reinforcement.
3. A497, Specification for Steel Welded Wire Fabric, Deformed, for Concrete Reinforcement.
4. A615, Specification for Deformed and Plain Billet Steel Bars for Concrete Reinforcement.
5. A706, Specification for Low-Alloy Steel Deformed Bars for Concrete Reinforcement.
6. A775, Specification for Epoxy-Coated Reinforcing Steel Bars.

###### B. American Concrete Institute (ACI).

1. ACI 350, Code Requirements for Environmental Engineering Concrete Structures

##### 1.04 SUBMITTALS

- A. In accordance with Section 01300 submit cutting and bending drawings and schedules for all reinforcement to be furnished.

###### B. Shop Drawings:

1. Prepare in accordance with Concrete Reinforcing Steel Institute (CRSI) Manual of Standard Practice and ACI SP-66 Detailing Manual:
  - a. Bending lists.
  - b. Placing drawings.
2. Welded splice, Cadweld splice, and mechanical threaded splice.

C. Quality Control Submittals:

1. Lab test reports for reinforcing steel showing stress-strain curves and ultimate strengths.
2. Mechanical Threaded Connections:
  - a. Current International Conference of Building Officials (ICBO) Research Report or equivalent code agency report listing findings to include acceptance, special inspection requirements, and restrictions.
  - b. Manufacturer's instructions.
  - c. Verification that device threads have been checked and meet all requirements for thread quality, in accordance with manufacturer's published methods.
3. Epoxy-Coated Reinforcing Bars: Written certification in accordance with paragraph 4.2.1 of ASTM A775.
4. Welding Qualification: Prior to welding, submit welder qualifications and radiographic nondestructive testing procedures.
  - . Test results to field testing.

1.05 QUALITY ASSURANCE

- A. The steel shall be newly rolled stock substantially free from mill scale, rust, dirt, oil, grease, or other foreign matter. Bars shall be of billet steel and, unless otherwise indicated, shall be Grade 60 bars.
- B. Billet steel bars shall conform to ASTM A 615.
- C. All bars shall be rolled by an acceptable mill. The Contractor shall submit at his own expense certified copies of tests of the bars furnished. The tests shall be as specified in the appropriate ASTM Specification referred to above and shall be made by an acceptable laboratory.
- D. Welder Qualifications: Certified in accordance with AWS D1.4-79.

1.06 DELIVERY, STORAGE, AND HANDLING

- A. Unload, store, and handle bars in accordance with CRSI publication "Placing Reinforcing Bars."
- B. Coated Bars:
  1. Protect epoxy-coated bars contact areas from handling equipment.
  2. Lift bundles of coated bars at multiple pickup points to minimize bar-to-bar abrasion from sags in bundles.
  3. Do not drop or drag coated bars or bundles of coated bars.
  4. Store coated bars on protective cribbing.
  5. Color fading of coating is not cause for rejection of epoxy-coated reinforcing bars.

## PART 2 PRODUCTS

### 2.01 MATERIALS

- A. Deformed Billet-Steel Reinforcing Bars:
  - 1. Includes stirrups, ties, and spirals.
  - 2. ASTM A615, Grade 60, including Supplemental Requirements S1 where welding is not required.
  - 3. ASTM A706, Grade 60, including Supplemental Requirements for reinforcing to be welded.
  
- B. Splices and Mechanical Connections:
  - 1. Metal Sleeve: Furnish with cast filler metal, capable of developing, in tension or compression, 125 percent of minimum tensile strength of the bar.
  - 2. Mechanical Threaded Connections: Furnish metal coupling sleeve for splicing reinforcing in secondary members or in areas of low stress with internal threads engaging threaded ends of bars developing in tension or compression 125 percent of yield strength of bar.
    - a. Manufacturers and Products:
      - 1) Erico Products, Inc., Cleveland, OH; Lenton Reinforcing Steel Couplers.
      - 2) Richmond Screw Anchor Co., Inc. Fort Worth, TX; Richmond DB-SAE Dowel Bar Splicers.
      - 3) Or equal.
  
- C. Epoxy-Coated Reinforcing Bars: ASTM A775, deformed bars, with bond strength not less than 80 percent of uncoated bars.
  
- D. Welded Wire Fabric:
  - 1. ASTM A185, or A497, and ACI 318/318R, using ASTM A82, wire of 75 ksi minimum tensile strength.
  - 2. Furnish flat sheets only, rolled sheets not permitted.
  
- E. Reinforcement shall be accurately formed to the dimensions indicated on the drawings. Stirrups and tie bars shall be bent around a pin having a diameter not less than two times the minimum thickness of the bar. Bends for other bars shall be made around a pin having a diameter not less than six times the minimum thickness except for bars larger than 1 in., in which case the bends shall be made around a pin of eight bar diameters. All bars shall be bent cold.
  
- F. Bars shall be shipped to the work site with bars of the same size and shape fastened in bundles with securely wired-on metal identification tags giving size and mark.
  
- G. Deformations on bars for concrete reinforcement shall conform to the requirements of the above-mentioned ASTM Specifications.

### 2.02 ACCESSORY MATERIALS

- A. Tie Wire:
  - 1. Black, soft-annealed 16-gauge wire.

2. Nylon-, epoxy-, or plastic-coated wire.
- B. Bar Supports and Spacers:
1. Precast concrete bar supports, cementitious fiber-reinforced bar supports, or all-plastic bar supports and side form spacers meeting the requirements of CRSI Manual of Standard Practice. Do not use other types of supports or spacers.
  2. In Beams, Columns, Walls, and Slabs Exposed to View After Stripping: Small rectangular concrete blocks made up of same color and strength as concrete being placed around them or all-plastic bar supports and side form spacers.
  3. Use supports made of dielectric material for epoxy-coated reinforcing bars supported from formwork.
  4. If epoxy-coated reinforcing is used, furnish epoxy-coated reinforcing bars for spreader bars.
  5. Precast concrete supports of same strength as concrete for reinforcing in concrete placed on grade.
- C. Welded steel wire fabric shall conform to the ASTM A 185. The gage and spacing of wires shall be as indicated on the drawings.
- D. Soffit Clips: Made galvanized steel wire not lighter than No. 12 Stl. W.C. They shall be spaced so that the greater portion of the wire is held about 1 in. from the flange of the steel beam, and shall be spaced not less than 9 in. on centers, the spacing being maintained by suitable longitudinal wires.

## 2.03 FABRICATION

- A. Follow CRSI Manual of Standard Practice.
- B. Bend all bars cold.

## PART 3 EXECUTION

### 3.01 PREPARATION

- A. Notify ENGINEER when reinforcing is ready for inspection and allow sufficient time for inspection prior to placing concrete.
- B. Repair epoxy coating damaged due to handling, shipment, and placing. Repair with patching material in accordance with ASTM A775, and manufacturer's recommendations.
- C. Clean metal reinforcement of loose mill scale, oil, earth, and other contaminants.
- D. Coat wire projecting from precast concrete bar supports with dielectric material, epoxy, or plastic.
- E. Before being placed in position, reinforcement shall be thoroughly cleaned of loose mill and rust scale, dirt, and other coatings, including ice, that tend to interfere with



development of proper bond. Where there is delay in depositing concrete after reinforcement is in place, bars shall be reinspected and cleaned when necessary.

- F. Reinforcement which is to be exposed for a considerable length of time after having been placed shall be painted with a heavy coat of cement grout, if required.

### 3.02 Reinforcing Bar Installation

- A. Bundle or space bars, instead of bending where construction access through reinforcing is necessary.

- B. Spacing and Positioning: Conform to ACI 350.

- C. Location Tolerances: In accordance with CRSI publication, "Placing Reinforcing Bars".

- D. Splicing:

1. Follow ACI 318/318R.
2. Use lap splices unless otherwise shown or permitted in writing by ENGINEER.
3. Welded Splices: Accomplish by full penetration groove welds and develop at least 125 percent of yield strength of bar.
4. Stagger splices in adjacent bars.
5. Metal sleeves may be used.

- E. Mechanical Splices and Connections:

1. Use only in areas specifically approved in writing by the ENGINEER.
2. Install as required by manufacturer with threads tightened and in accordance with ICBO Research Report.
3. Maintain minimum edge distance and concrete cover.

- F. Tying Deformed Reinforcing Bars:

1. Tie every other intersection on mats made up of Nos. 3, 4, 5, and 6 bars to hold them firmly at required spacing.
2. Bend all noncoated tie wire to prevent tie wire from being closer than 1 inch from the surface of concrete.
3. Epoxy-Coated Bars:
  - a. Use epoxy-coated or nonmetallic clips.
  - b. Repair coating damage at clipped or welded intersection.

- G. Reinforcement Around Openings: Place an equivalent area of steel bars or fabric around pipe or opening and extend as shown, on each side sufficiently to develop bond with each bar. See drawing details.

- H. Welding Reinforcement:

1. Only A706/A706M bars may be welded.
2. Do not perform welding until welder qualifications are approved.
3. Provide suitable ventilation when welding epoxy-coated reinforcing bars.

4. After completion of welding on epoxy-coated reinforcing bars, repair coating damage, welds, and steel splice members with same material as used for repair of coating damage.
- I. Straightening and Rebending: Field bending of reinforcing steel bars is not permitted.
- J. Unless permitted by Engineer, do not cut reinforcing bars in the field. When epoxy-coated reinforcing bars are cut in the field, coat ends of bars with same material used for repair of coating damage.
- K. Reinforcement shall be accurately positioned as indicated on the drawings, and secured against displacement by using annealed iron wire ties or suitable clips at intersections. Concrete blocks having a minimum bearing area of 2 in. by 2 in., and equal in quality to that specified for the slab, shall be used for supporting reinforcing bars for slabs on grade. Where the underside of slabs will be exposed to view in the finished work, stainless-steel supports shall be used
- L. Furnish and place all concrete reinforcement as indicated on the drawings and as herein specified. Concrete reinforcement in sizes No. 3 (3/8 in.) and larger shall be deformed steel bars of the shapes and sizes indicated on the drawings.

### 3.03 WELDED WIRE FABRIC INSTALLATION

- A. Extend fabric to within 2 inches of edges of slab, and lap splices at least 1-1/2 courses of fabric or minimum 8 inches.
- B. Tie laps and splices securely at ends and at least every 24 inches with tie wire.
- C. Place welded wire fabric on concrete blocks at correct distance as shown, above bottom of slab and rigidly support equal to that provide for reinforced bars. Do not use broken concrete, brick, or stone.
- D. Follow ACI 350 and current Manual of Standard Practice, Welded Wire Fabric.
- E. Do not use fabric that has been rolled. Install flat sheets only.

### 3.04 TESTS AND INSPECTION

- A. Test 10 percent of all welds using radiographic, nondestructive testing procedures referenced in AWS D1.4-79.
- B. Inspect each splice and verify each component is in accordance with manufacturer's instructions and ICBO Research Report.

END OF SECTION

## SECTION 03250

### EXPANSION, CONSTRUCTION, AND CONTROL JOINTS

#### PART 1 GENERAL

##### 1.01 SUMMARY

###### A. Section Includes

1. Requirements for making joints in concrete and masonry.

###### B. Related Sections

1. Section 03200 – Concrete Reinforcing
2. Section 03300 – Cast-In-Place Concrete
3. Section 03252 – Waterstops
4. Section 07900 – Joint Sealants

##### 1.02 REFERENCES

###### A. Army Corp. of Engineers.

1. CRD-C-572, Specification for Polyvinyl chloride Waterstop.

###### B. American Society for Testing and Materials (ASTM)

1. A36, Specification for Carbon Structural Steel.
2. D226, Specification for Asphalt-Saturated Organic Felt used in Roofing and Waterproofing.
3. D227, Specification for Smooth-Surfaced Asphalt Roll Roofing and Waterproofing.
4. D994, Specification for Preformed Expansion Joint Filler for Concrete (Bituminous Type).
5. D1506, Specification for Flexible Cellular Materials-Sponge or Expanded Rubber.
6. D1751, Specification for Preformed Expansion Joint Filler for Concrete Paving and Structural Construction (Nonextruding and Resilient Bituminous Types).

###### C. National Sanitation Foundation (NSF).

1. 61-90,

##### 1.03 SUBMITTALS

###### A. Shop Drawings:

1. Plastic Type Water Stops: Details of splices to be used and method of securing water stop in the forms and supporting water stop so as to maintain proper orientation and location during concrete placement.
2. Construction Joints: Layout and location indicating type to be used.
3. Joint fillers for horizontal and sloped joints.
4. Preformed control joints.
5. Water stop.

###### B. Samples: Splice, joint, and fabricated cross of each size, shape, and fitting of water stop(s) proposed for use.

###### C. Quality Control Submittals:

1. Water stop manufacturer's written instructions for product shipment, storage, handling, installation field splices, and repair.
2. Joint filler and primer. Manufacturer's written instructions for product shipment, storage, handling, application and repair.
3. Preformed Control Joint: Manufacturer's written instructions for product shipment, storage, handling, application, and repair.

#### 1.04 QUALITY ASSURANCE

- A. Regulatory Requirements: Acceptance of pourable joint filler for potable water structures by federal EPA or by a state health agency.
  1. Pourable Joint Filler: Certified as meeting NSF 61-90.

#### 1.05 DELIVERY, STORAGE AND HANDLING

- A. Acceptance at Site: Verify that water stops delivered are in accordance with cross-section dimensions as shown and manufacturer's product data prior to unloading and storing on site.

### PART 2 PRODUCTS

#### 2.01 WATERSTOPS

- A. In accordance with Specification Section 03252.

#### 2.03 BOND BREAKER

- A. Tape for Expansion Joints: Adhesive-backed glazed butyl or polyethylene tape, same width as the joint, that will not adhere to the premolded joint material.
- B. Use either bond breaker tape or a bond prevention material as specified in SECTION 03300, except where a tape is specifically called for.

#### 2.04 PREMOLDED JOINT FILLER

- A. Bituminous Type: ASTM D994 or D1751.
- B. Sponge Rubber: Neoprene, closed-cell, expanded; ASTM D1056-85, Type 2C5, with a compression deflection, 25 percent deflection (limits), 119 to 168 kPa (17 to 24 psi) minimum.
  1. Manufacturer and Product:
    - a. Rubatex Corp.; R451N
    - b. Or equal.

#### 2.05 PREFORMED CONTROL JOINT

- A. One-Piece, Flexible, Polyvinyl Chloride Joint Former:
  1. Manufacturer and Product:
    - a. Vinylex Corp., Knoxville, TN; Kold-Seal Zip-Per Strip KSF-150-50-50.
    - b. Or equal.
- B. One-Piece Steel Strip with Preformed Groove:
  1. Manufacturer and Product:
    - a. Burke Concrete Accessories, Inc., San Mateo, CA; Keyed Kold Retained Kap.
    - b. Or equal.

C. Furnish in full-length, unspliced pieces.

## 2.06 POURABLE JOINT FILLERS

A. Filler for Nonpotable Water Structure:

1. Specific Gravity: Greater than 1.0 for cured, in-place filler.
2. Sloped Joints: Furnish Gun Grade material that will remain as placed in joints and will not run down slope.
3. Manufacturers and Products:
  - a. W.R. Meadows, Inc., Elgin, IL: No. 164 Polymeric sealing compound, hot-pour, or Hi-Spec Polymeric joint sealing, hot-pour compound; or
  - b. A.C. Horn, Inc., North Bergen, NJ: No-Track two-component material (Code 2323), cold-applied, self-leveling filler; or
  - c. W.R. Meadows, Elgin, IL: Gardox, two-component, cold-applied compound filler.

## 2.07 STEEL EXPANSION JOINT DOWELS

A. Dowels: ASTM A36 round smooth steel bars.

B. Bar Coating: Two-coat system, fusion bonded, steel dowel coating, with a factory-applied lubricating coating.

## 2.08 ACCESSORIES

A. Joint Sealants: As specified in SECTION 07900.

B. Nonshrink Grout:

1. As specified in SECTION 03600.
2. Compatible with joint sealant.

C. Roofing Felt: ASTM D226, Type II, 30-pound asphalt-saturated or equal weight of ASTM D227 coal-tar saturated felt.

D. Reinforcing Steel: As specified in SECTION 03200.

E. Nails: As required for securing bituminous type premolded joint filler.

F. Masking Tape: As required to temporarily adhere to concrete at each side of joint to receive filler.

## PART 3 EXECUTION

### 3.01 GENERAL

A. Construct straight joints; make vertical or horizontal, except where walls intersect sloping floors.

B. Commence concrete placement after the joint preparation is complete.

C. Time Between Concrete Pours: As specified in SECTION 03300.

### 3.02 SURFACE PREPARATION

A. Construction Joints: Prior to placement of abutting concrete, clean contact surface:

1. Remove laitance and spillage from reinforcing steel and dowels.
  2. Roughen surface to a minimum of 1/4-inch amplitude:
    - a. Sandblast after the concrete has fully cured.
    - b. Water blast after the concrete has partially cured.
    - c. Green cut fresh concrete with high pressure water and hand tools.
  3. Perform cleaning so as not to damage water stop, if one is present.
- B. Expansion Joint with Pourable Filler:
1. Use motorized wire brush or other motorized device to mechanically roughen and thoroughly clean concrete surfaces on each side of joint from plastic water stop to the top of the joint.
  2. Use clean and dry high pressure air to remove dust and foreign material, and dry joint.
  3. Prime surfaces before placing joint filler.
  4. Avoid damage to water stop.
- C. Expansion Joint without Pourable Filler:
1. Coat concrete surfaces above and below plastic water stop with bond breaker.
  2. Do not damage water stop.
- D. Control Joint:
1. Coat concrete surfaces above and below plastic water stop with bond breaker.
  2. Do not damage water stop.
  3. Furnish correct type and size of reinforcing and dowels.

### 3.03 INSTALLATION OF WATER STOPS

- A. General:
1. Join water stops at intersections to provide continuous seal.
  2. Center water stop on joint.
  3. Secure water stop in correct position to avoid displacement during concrete placement.
  4. Repair or replace damaged water stop.
  5. Place concrete and vibrate to obtain impervious concrete in the vicinity of all joints.
  6. Joints in Footings and Slabs:
    - a. Ensure that space beneath plastic water stop is completely filled with concrete.
    - b. During concrete placement, make a visual inspection of the entire water stop area.
    - c. Limit concrete placement to elevation of water stop in first pass, vibrate the concrete under the water stop, lift the water stop to confirm full consolidation without voids, then place remaining concrete to full height of slab.
    - d. Apply procedure to full length of plastic water stops.
- B. Plastic Water Stop:
1. Install in accordance with manufacturer's written instructions.
  2. Splice in accordance with the water stop manufacturer's written instructions using a thermostatically controlled heating iron. Butt splice unless specifically detailed otherwise.
    - a. Allow at least 10 minutes before the new splice is pulled or strained in any way.
    - b. Finished splices shall provide a cross-section that is dense and free of porosity with tensile strength of not less than 80 percent of the unspliced materials.

3. Wire looped plastic water stop may be substituted for plastic water stop.

### 3.04 EXPANSION JOINT INSTALLATION

#### A. General:

1. Place bond breaker above and below water stop when premolded joint filler and pourable joint filler is not used.
2. Premolded Joint Filler:
  - a. Sufficient in width to completely fill the joint space where shown.
  - b. If a water stop is in the joint, cut premolded joint filler to butt tightly against the water stop and the side forms.
3. Precut premolded joint filler to the required depth at locations where joint filler or sealant is to be applied.
4. Form cavities for joint filler with either precut, premolded joint filler, or smooth removable accurately shaped material. Entire joint above water stop, in slabs, shall be formed and removed so that entire space down to water stop can be filled with the pourable joint filler.
5. Vibrate concrete thoroughly along the joint form to produce a dense, smooth surface.

#### B. Bituminous Type Premolded Joint Filler:

1. Drive nails approximately 1 foot 6 inches on center through the filler, prior to installing, to provide anchorage embedment into the concrete during concrete placement.
2. Secure premolded joint filler in forms before concrete is placed.
3. Install in walkways, at changes in direction, at intersections, at each side of driveway entrances, and at 45-foot intervals, maximum.

#### C. Pourable Joint Filler:

1. General: Install in accordance with the manufacturer's written instructions, except as specified below:
  - a. Apply primer prior to pouring joint filler.
  - b. Fill entire joint above the water stop with joint filler as shown.
  - c. Use masking tape on top of slabs at sides of joints; clean spillage. Remove masking tape afterwards.
2. Rubber Asphalt Type, Hot-Applied:
  - a. Heat filler material in a double-walled boiler.
  - b. Place filler in the joint by means of a nozzle from a portable pouring type container to prevent spillage outside of the joint.
  - c. Begin pouring joint filler at the bottom of the horizontal joint and proceed upwards in a manner that will preclude the possibility of trapping air in the joint.
3. Rubber Asphalt Type, Cold-Applied: Place cold-applied two-component fillers in accordance with manufacturer's written instructions.
4. Multicomponent Type for Potable Water Structures: Install in accordance with manufacturer's written instructions.

#### D. Steel Expansion Joint Dowels:

1. Install coated and lubricated bars parallel to wall or slab surface and in true horizontal position perpendicular to the joint in both plan and section view, so as to permit joint to expand or contract without bending the dowels.

2. Secure dowels tightly in forms with rigid ties.
3. Install reinforcing steel in the concrete as shown to protect the concrete on each side of the dowels and to resist any forces created by joint movement.

### 3.05 CONTROL JOINT INSTALLATION

- A. Locate reinforcing and dowels as shown.
- B. Install PVC water stop.
- C. Concrete surfaces shall be dense and smooth.
- D. Install bond breaker to concrete surfaces above and below water stop.

### 3.06 PREFORMED CONTROL JOINTS

- A. Use only where specifically shown; do not use in water-holding basins.
- B. Locate flush, or slightly below the top of slab.
- C. Install in accordance with manufacturer's written instructions in straight, full-length unspliced pieces.
- D. Steel Strip Type with Preformed Groove: Brace to withstand pressure of concrete during and after placement.

END OF SECTION



## SECTION 03252

### WATERSTOPS

#### PART 1 GENERAL

##### 1.01 SUMMARY

A. Section includes requirements for,

1. Flexible PVC waterstops at construction, contraction, and expansion joints in new concrete construction as shown on the Contract Drawings.
2. Hydrophilic rubber waterstops at construction joints between new and existing concrete, or where installation of center bulb-type waterstops is not possible.
3. Preparation of existing concrete surfaces where hydrophilic rubber waterstops are to be installed.

##### 1.02 RELATED SECTIONS

- A. Section 03250 – Expansion, Construction and Control Joints  
B. Section 03000 – Cast-In-Place Concrete

##### 1.03 REFERENCES

- A. Except as noted, work shall conform to the latest edition of the following codes specifications and standards:
1. American Society for Testing and Materials (ASTM)
  2. Army Corps of Engineers, “Specifications for Polyvinyl chloride Waterstop”, CRD-C572-74

##### 1.04 SUBMITTALS

- A. Submit shop drawings in accordance with Section 01300.
- B. Manufacturer’s Data: for all types and sizes of waterstops, including but not limited to:
1. Product data and material specifications
  2. Installation instructions
  3. Accessories including: crosses, tees, splices, fasteners and adhesives

##### 1.05 QUALITY ASSURANCE

- A. Manufacturer Qualifications: shall demonstrate five years (minimum) continuous, successful experience in production of waterstops.
- B. Installer Qualifications: Qualified to perform work specified by reason of experience or training provided by the product manufacturer.

## 1.06 DELIVERY, STORAGE AND HANDLING

- A. Store Products in a location protected from dampness, damage, construction activity, dirt, and direct sunlight in strict accordance with the manufacturer's recommendations.

## PART 2 PRODUCTS

### 2.01 MATERIALS

#### A. PVC Waterstop

1. Provide flexible PVC waterstop as detailed on the Contract Drawings.
2. The PVC waterstop shall be extruded from an elastomeric plastic material of which the basic resin is prime virgin polyvinyl chloride. The PVC compound shall not contain any scrapped or reclaimed material or pigment whatsoever.
3. Performance requirements are as follows:
  - a. Minimum Tensile Strength, 2000 psi
  - b. Specific Gravity, Approx. 1.4
  - c. Shore Durometer Type A Hardness, 65 to 80
4. Type: Center bulb with a number of parallel ribs or protrusions on each side of strip center.
5. Corrugated or tapered type waterstops are not acceptable.
6. Thickness: Constant from bulb edge to the outside stop edge.
7. Minimum Weight per Foot of Waterstop:
  - a. 0.90 pound for 3/16 inch by 4 inch.
  - b. 1.62 pounds for 3/8 inch by 6 inch.
  - c. 2.30 pounds for 3/8 inch by 9 inch.
8. Manufacturers of Products:
  - a. Greenstreak, Inc., St. Louis, MO; Style 702 (3/16 inch by 4 inch), Style 732 (3/8 inch by 6 inch) and Style 735 (3/8 inch by 9 inch).
  - b. Vinylex Corp., Knoxville, TN; No. RB4-316H (3/16 inch by 4 inch), No. RB6-38H (3/8 inch by 6 inch) and No. RB9-38H (3/8 inch by 9 inch).
  - c. Vulcan Metal Products, Birmingham, AL; Type 8069 (3/8 inch by 6 inch) and Type 8070 (3/8 inch by 9 inch).
  - d. Or approved equal.

#### B. Hydrophilic Rubber Waterstop

1. Provide hydrophilic rubber waterstop at construction joints between new and existing concrete and as indicated on the Contract Drawings.
2. The waterstop shall be a combination of chloroprene rubber and chloroprene rubber modified to impart hydrophilic properties.
3. The waterstop shall have a delay coating to inhibit initial expansion due to moisture present in fresh concrete.
4. Performance requirements are as follows:
  - a. Minimum Tensile Strength  
(Chloroprene Rubber) 1300 psi
  - b. Minimum Tensile Strength  
(Modified Chloroprene Rubber) 350 psi

- c. Specific Gravity Approx. 1.4
- d. Shore Durometer Type A Hardness 45 to 55
- 5. Manufacturers of Products
  - a. Hydrophilic Waterstop:
    - 1) Greenstreak, Inc., St. Louis, MO; No. CJ-0725-3K.
    - 2) Adeka Ultraseal North America, distributed by Unique Techniques, Inc., West Cossackie, NY; No. MC-2010M.
    - 3) Or approved equal.
  - b. Hydrophilic Sealant:
    - 1) Adeka Ultraseal North America, distributed by Unique Techniques, Inc., West Cossackie, NY; No. P-201.
    - 2) Greenstreak, Inc., St. Louis, MO; No. LV-1.
    - 3) Or approved equal.

## 2.02 ACCESSORIES

### A. PVC Waterstop

1. Provide factory made waterstop fabrications for all changes in direction, intersections, and transitions leaving only straight butt joint splices for the field.
2. Provide hog rings or grommets spaced at 12 inches on center along the length of the waterstop.
3. Provide Teflon coated thermostatically controlled splicing irons for field butt splices.

### B. Hydrophilic Rubber Waterstop

1. Provide manufacturer's recommended adhesives for the appropriate field conditions. Provide adhesives for each surface to be adhered to (wet or dry concrete, either rough or smooth).
2. Provide a one-component sealant for sealing exposed cells.
3. Provide manufacturer's recommended adhesive for all splices.

## PART 3 EXECUTION

### 3.01 INSTALLATION

#### A. PVC Waterstop

1. Field butt splices shall be heat fused welded using a Teflon coated thermostatically controlled waterstop splicing iron at the manufacturer's recommended temperature. Follow approved manufacturer's installation procedures.
  - a. Lapping of waterstop, use of adhesives, or solvents shall not be allowed.
  - b. Allow at least 10 minutes before the new splice is pulled or strained in any way.
  - c. Finished splices shall provide a cross-section that is dense and free of porosity.
2. Center waterstop in joint and secure waterstop in correct position using hog rings or grommets at 12 inches on center along the length of the waterstop and wire tie to adjacent reinforcing steel. In no case shall the waterstop be bent over inside the keyways.

3. Place concrete and vibrate to obtain impervious concrete in the vicinity of the waterstop area.
4. Joints in footings and slabs:
  - a. Ensure that the space beneath PVC waterstop is completely filled with concrete.
  - b. During concrete placement, make a visual inspection of the entire waterstop area.
  - c. Limit concrete placement to elevation of waterstop in first pass, vibrate the concrete under the waterstop, lift the waterstop to confirm full consolidation without voids, then place remaining concrete to full height of slab.
  - d. Apply procedure to full height of PVC waterstops. Follow similar procedures for joints in walls.

#### B. Hydrophilic Rubber Waterstop

1. Cut Coil ends square (or at proper angle for mitered corners) with shears or sharp blade to fit splices together without overlaps.
2. Apply a continuous bead of manufacturer's recommended hydrophilic sealant before fastening waterstop. The waterstop shall be fastened to the existing concrete surfaces with appropriate fasteners as recommended by the waterstop manufacturer.
3. Splices shall be made using the manufacturer's recommended splicing adhesive. Manufacturer's recommended adhesive sealant shall also be applied to all joints after gluing.
4. Seal watertight any exposed cells with appropriate sealant.
5. A continuous bead of manufacturer's recommended hydrophilic sealant shall be applied along the edge of the waterstop.
6. Follow approved manufacturer's installation procedures.
7. Place concrete and vibrate to obtain impervious concrete in the vicinity of the waterstop area. Care shall be taken to avoid displacing waterstop during concrete placement.

### 3.02 FIELD QUALITY CONTROL

- A. Waterstop splicing defects which are unacceptable include, but are not limited to the following:
1. Tensile strength that is less than 80 percent of parent section.
  2. Misalignment of center bulbs, ribs, and end bulbs greater than 1/16 inch.
  3. Bond failure at joint deeper than 1/16 inch or 15 percent of material thickness.
  4. Misalignment that reduces waterstop cross section more than 15 percent.
  5. Visible porosity in the weld.
  6. Bubbles or inadequate bonding.
  7. Visible signs of splice separation when cooled splice is bent by hand at a sharp angle.
  8. Charred or burnt material.
  9. Inadequate or incomplete bond between hydrophilic rubber waterstop and concrete surface.

END OF SECTION

## SECTION 03300

### CAST-IN-PLACE CONCRETE

#### PART 1 GENERAL

##### 1.01 SECTION INCLUDES

- A. Requirements for furnishing and installing forms, reinforcing steel, concrete and expansion and/or construction joints.
- B. **All concrete reinforcement shall be produced in the United States in accordance with the American Iron and Steel requirements of P.L. 113-76, the Consolidated Appropriations Act of 2014.**

##### 1.02 RELATED SECTIONS

- A. Section 03100 – Formwork
- B. Section 03200 – Reinforcement
- C. Section 03250 – Expansion, Construction, And Control Joints
- D. Section 03252 – Waterstops

##### 1.02 REFERENCES

- A. American Society for Testing and Materials (ASTM)
  - 1. A185, Specification for Steel Welded Wire Fabric, Plain, for Concrete Reinforcement.
  - 2. A615, Specification for deformed and Plain Billet-Steel Bars for Concrete Reinforcement.
  - 3. C31, Practice for Making and Curing Concrete Test Cylinders in the Field.
  - 4. C33, Specification for Concrete Aggregates.
  - 5. C39, Test Method for Compressive Strength of Cylindrical Concrete Specimens.
  - 6. C42, Test Method for Obtaining and Testing Drilled Cores and Sawed Beams of Concrete.
  - 7. C94, Specification for ready Mixed Concrete.
  - 8. C143, Test Method for Slump of Hydraulic Cement Concrete.
  - 9. C150, Specification for Portland Cement.
  - 10. C172, Practice for Sampling Freshly Mixed Concrete.
  - 11. C231, Test Method for Air Content of Freshly Mixed Concrete by the Pressure Method.
  - 12. C260, Test Method for Air-Entraining Admixtures for Concrete.
  - 13. C494, Specification for Chemical Admixtures for Concrete.
  - 14. C920, Specification for Elastomeric Joint sealants.
  - 15. D994, Specification for Preformed Expansion Joint Filler for Concrete (Bituminous Type)
  - 16. D1056, Specification for Flexible Cellular Materials-Sponge or Expanded Rubber.
  - 17. D1751, Specification for Preformed Expansion Joint Filler for Concrete Paving and Structural Construction (Nonextruding and Resilient Bituminous Types).

B. American Concrete Institute (ACI):

1. ACI 301, Specification for Structural Concrete for Buildings.
2. ACI 304, Recommended Practice for Measuring, Mixing, Transporting, and Placing Concrete.
3. ACI 305, Recommended Practice for Hot Weather Concreting.
4. ACI 306, Recommended Practice for Cold Weather Concreting.
5. ACI 315, Building Code Requirements for Reinforced Concrete.
6. ACI 347, Guide to Formwork for Concrete.

C. Concrete Reinforcing Steel Institute (CRSI):

1. Manual of Standard Practice.

1.03 SUBMITTALS

A. Submit Shop Drawings in accordance with SECTION 01300 for the following:

1. Reinforcing Steel
  - a. Furnish in detail and completeness that all fabrication and placement at the site can be accomplished without the use of contract drawings for reference.
  - b. Include number of pieces, sizes, and grade of reinforcing steel, accessories, and any other information required for fabrication and placement.
  - c. Show joint layout and design
  - d. Check structural and site drawings for anchor bolts, anchors, inserts, conduits, sleeves, and any other items which are required to be embedded in concrete, and make necessary provisions as required so that reinforcing steel will not interfere with the placement of such embedded items.
2. Concrete mix designs.
3. Grout manufacturer/design mix (if included in this section)
4. Manufacturer's data for ancillary materials such as joint fillers and sealants, epoxy bonding compound.

1.04 QUALITY ASSURANCE

A. Selection of testing laboratory in accordance with SECTION 01410.

B. Sample and Test Concrete as follows:

1. Test Specimens: Make, cure and have tested, a minimum of one set of four test specimens from the concrete of each day's pour and for each fifty cubic yards of concrete cast in accordance with ASTM C172, C31 and C39. One cylinder shall be broken after seven days and three cylinders after twenty-eight day.
2. Slump: A slump test shall be made for each truckload of concrete in accordance with ASTM C143. Slumps greater than design mix limit will be grounds for rejection of the concrete.
3. Air Content: An air content test shall be made from each day's pour of concrete by the pressure method in accordance with ASTM C231. Air contents above or below the limits specified will be grounds for rejection of the concrete.
4. In the event the compressive strength of the cylinders, when tested, is below the specified minimum, the Engineer may require test cores of the hardened structure

to be taken by the Testing Laboratory in accordance with ASTM C42. If such test indicates that the core specimen is below the required strength, the concrete in question shall be removed and replaced without cost to the Owner. Any other work damaged as a result of this concrete removal shall be replaced with new materials to the satisfaction of the Engineer at no additional cost to the Owner. The cost of coring will be deducted from the contract amount. Where the Testing Laboratory has taken core cylinders and the concrete proves to be satisfactory, core holes shall be filled in a manner satisfactory to the Engineer at no additional cost to the Owner.

5. The Contractor shall coordinate the date and location of tests with the Engineer before any concrete work is started.

## 1.05 PRODUCT DELIVERY, STORAGE AND HANDLING

### A. Reinforcing steel.

1. Transport to the site, store, and cover in a manner which will ensure that no damage shall occur to it from moisture, dirt, grease, or any other cause that might impair bond to concrete, or chip protective epoxy coating if applicable.
2. Store on the site at all times, a supply of approved reinforcing steel to ensure that there will be no delay of the work.
3. Identification of steel shall be maintained after bundles are broken.

## PART 2 PRODUCTS

### 2.01 MATERIALS

#### A. Portland Cement.

1. Portland Cement used for building footings, base slabs, foundation walls, columns, and beams shall be in accordance with ASTM C150, Type V of U.S. manufacture.
2. All other Portland Cement shall be in accordance with ASTM C150, Type II of U.S. manufacture.

#### B. Aggregates.

1. Fine aggregate, in accordance with ASTM C33, clean and graded from 1/4 inch to fines.
2. Coarse aggregate, in accordance with ASTM C33, clean and graded from 1/4 inch to maximum sizes hereinafter specified.

#### C. Air Entraining Agent.

1. In accordance with ASTM C260.

#### D. Water Reducing Agent.

1. In accordance with ASTM C494 Type A.

#### E. Microsilica Admixture.

1. Packaged in easily dispersing form.

#### F. Water.

1. Clean and potable,
2. Free of impurities detrimental to concrete.

G. Reinforcing Bars.

1. See Section 3200.

H. Welded Wire Fabric

1. See Section 3200.

I. Accessories.

1. See Section 3200.

J. Tie wire.

1. See Section 3200.

K. Form Ties and Spreaders.

1. See Section 3100.

L. Form Coatings.

1. Non-grain raising and non-staining type that will not leave residual matter on surface of concrete or adversely affect proper bonding of subsequent application of other material applied to concrete surface.
2. "Nox-Crete Form Coating" as manufactured by Nox-Crete Company, or approved equal.
3. Coatings containing mineral oils or the non-drying ingredients will not be permitted.

M. Grout.

1. See Section 3604.

2.02 CONCRETE STRENGTHS AND PROPORTIONS

- A. Cast-in-place concrete shall have the minimum compressive strength at 28 days as indicated on the Drawings.
- B. The exact proportions for the mix, including amounts admixture (if any), and water, shall be determined by the concrete supplier.
- C. The proportions of aggregate to cement for any concrete shall be such as to produce a mixture which will work readily into the corners and angles of the forms and around reinforcement, but without permitting the materials to segregate or excess free water to collect on the surface.
- D. Air-Entrainment: The air content in all concrete shall be maintained at 5 to 7 percent.

2.03 PREMOLDED JOINT FILLER

A. Bituminous Type.

1. In accordance with ASTM D994 or D1751.

B. Sponge Rubber Type.



1. Neoprene, closed-cell, expanded in accordance with ASTM D1056, Type 2C5, with a compression deflection, 25 percent deflection (limits), 17 to 24 psi (119 to 168 kPa) minimum.

## 2.04 POURABLE JOINT FILLERS

### A. Filler for Nonpotable Water Structures

1. Specific Gravity: Greater than 1.0 for cured, in-place filler.
2. Vertical and Sloped Joints: Furnish gun grade material that will remain as placed in joints and will not run down slope.
3. Suitable for continuous immersion and exposure to liquid being contained in the structure.

## 2.05 JOINT SEALANTS

### A. In slabs.

1. In accordance with ASTM C920 for poured 2-component polyurethane sealant.
2. Sikaflex-2c, as manufactured by Sika Corporation or approved equivalent.

### B. In walls.

1. Type II, Class A, compound conforming to Interim Federal Specification TT-S-00227E (3) (COM-NBS) for Sealing Compound; Elastomeric Type, Multi-Component (for Caulking, Sealing, and Glazing in Buildings and Other Structures).
2. Sikaflex-1a, as manufactured by Sika Corporation or approved equivalent.

## 2.06 EPOXY BONDING COMPOUND

- A. The epoxy bonding compound shall be a three-component, solvent-free, moisture-tolerant, epoxy modified, cementitious product specifically formulated as a bonding agent and anti-corrosion coating. The product shall have suitable contact time, fluidity, and application temperature for this type of application.

## PART 3 EXECUTION

### 3.01 FORMWORK

1. See Section 3100.

### 3.02 REINFORCING STEEL

1. See Section 3200.

### 3.03 CONCRETE

#### A. Mixing of Concrete

1. All concrete shall be ready-mixed concrete, and shall be mixed and delivered in accordance with ASTM C 94. The batch plant of the concrete producer shall be certified for compliance with the standards established by the National Ready-Mixed Concrete Association.
2. In the event concrete is mixed at a central batching plant, the delivery shall be arranged so that intervals between batches are kept to a minimum, and in any event

not more than thirty (30) minutes. Trucks shall be in first class condition and kept in constant rotation during delivery.

3. Concrete shall be placed within 90 minutes after cement has been mixed with aggregate or 45 minutes after addition of water and admixtures.
4. No admixtures, except those mentioned in paragraph 2.1 shall be used. Calcium chloride will not be permitted.
5. Truck delivery slips of all concrete delivered to the job shall indicate the quantity and quality of concrete, additives, date and time of batching and delivery, and the location of placement. Delivery slips shall be forwarded to the Engineer at the end of each pour.

B. Cold Weather Concreting.

1. In accordance with ACI 306.
2. Concrete shall not be mixed or placed when the temperature is below 40 degrees F, or when conditions indicate that the temperature will fall below 40 degrees F within 72 hours unless precautions are taken to protect the concrete.
3. Concrete temperature shall be maintained, when deposited, at not less than 60 degrees F. Reinforcement, forms, and ground which concrete will contact must be completely free of frost.
4. Concrete and formwork must be kept at a temperature of not less than 50 degrees F. for not less than 96 hours after placing.
5. Calcium chloride shall not be used.

C. Hot Weather Concreting.

1. In accordance with ACI 305.
2. The maximum temperature of the concrete, when deposited, shall be 85 degrees F. If the weather causes the placing temperature to exceed 85 degrees F., the mix shall be cooled by methods approved by the Engineer.
3. No concrete shall be deposited when the air temperature is greater than 90 degrees F.

D. Conveying and Placing Concrete.

1. In accordance with ACI 304.
2. Notification: Before placing concrete, forms shall be thoroughly inspected. All chips, dirt, etc., shall be removed, all temporary bracing and cleats taken out, all openings for pipes, etc., properly boxed, all forms properly secured in their correct position and made tight, all reinforcement, anchors, and embedded items secured in their proper places. Concrete which may be on the forms or reinforcement, and which is set and dry, shall be cleaned off, and the forms and steel washed off before proceeding. Remove all foreign matter from forms and excavations.
3. Water shall be removed from place of deposit before concrete is placed unless otherwise permitted by the Engineer. Any flow of water into an excavation shall be diverted through proper side drains into a sump, or shall be removed by other approved methods which will avoid washing away the freshly deposited concrete.
4. Soil on which concrete will be poured shall be thoroughly wetted (except in freezing weather).

5. Anchors and Embedded Items: Anchors, bolts, sleeves, inserts, wood blocking, and any other items to be embedded in concrete shall be accurately secured in position before the concrete is placed. Aluminum shall not be embedded in concrete.

#### E. Handling and Depositing

1. Before any concrete is placed, notify all whose work is in any way connected with or influenced by the concrete work, and give them reasonable time to complete all portions of their work that must be completed before concrete is deposited.
2. Immediately before concrete is placed, inspect all forms to insure that they are in proper position, sufficiently rigid, thoroughly clean, properly oiled and free from foreign materials, and that all reinforcement is in proper position.
3. Concreting, once started, shall be carried on as a continuous operation until the section of approved size and shape is completed.
4. Concrete shall be conveyed as rapidly as practicable from the mixer to the place of final deposit by methods that prevent the separation or loss of ingredients. It shall be deposited, as nearly as practicable, in its final position to avoid rehandling or flowing.
5. Concrete shall not be dropped freely where reinforcement will cause segregation, nor shall it be dropped freely more than six (6) feet. Concrete shall be deposited to maintain a plastic surface approximately horizontal.
6. Concrete that has partially hardened shall not be deposited in the work.

#### F. Pumping

1. Concrete may be placed by pumping if first approved in writing by the Engineer for the location proposed.
2. Equipment for pumping shall be of such size and design as to ensure a practically continuous flow of concrete at the delivery end without separation of materials.
3. The concrete mix shall be designed to the same requirements as herein before specified, and may be richer in lubricating components in order to allow proper pumping.
4. Concrete shall not be pumped through aluminum pipes.

#### G. Vibrating and Compacting

1. All concrete shall be thoroughly consolidated and compacted by suitable means during the operation of placing, and shall be thoroughly worked around reinforcement, embedded items, and into the corners of the forms. All concrete against forms shall be thoroughly spaded. Internal vibrators shall be used under experienced supervision, and shall be kept out of contact with reinforcement and wood forms. Vibrators shall not be used in a manner that forces mortar between individual form members.
2. Vibrators shall be flexible electric type or approved compressed air type, adequately powered and capable of transmitting to the concrete not less than seven thousand (7,000) impulses per minute. Vibration shall be sufficiently intense to cause the concrete to flow or settle readily into place without separation of the ingredients. A sufficient number of vibrators shall be employed so that complete compaction is secured throughout the entire volume of each layer of concrete. At

least one (1) vibrator shall be kept in readiness as a spare for emergency use. Vibrators shall be such that the concrete becomes uniformly plastic with their use.

3. Vibration shall be close to the forms but shall not be continued at one spot to the extent that large areas of grout are formed or the heavier aggregates are caused to settle. Care shall be taken to not disturb concrete that has its initial set.
4. Where conditions make compacting difficult, or where the reinforcement is congested, batches of mortar containing the same proportions of cement to sand as used in the concrete shall first be deposited in the forms, to a depth of at least one inch.
5. The responsibility for providing fully filled out, smooth, clean, and properly aligned surfaces free from objectionable pockets shall rest entirely with the Contractor.

#### H. Construction Joints

1. Construction joints shall be located a maximum of 40 feet apart. If, for any reason, the contractor feels a change is necessary, he shall prepare a placing plan and submit it to the Engineer for approval.
2. Where a joint is to be made, the surface of the concrete shall be sandblasted or thoroughly picked, thoroughly cleaned, and all laitance removed. In addition to the foregoing, joints shall be thoroughly wetted, but not saturated, and slushed with a coat of grout immediately before the placing of new concrete.
3. Approved keys shall be used at all joints, unless detailed otherwise.
4. Forms shall be retightened before placing of concrete is continued. There shall be an interval of at least 48 hours between adjacent pours.

#### I. Bonding Concrete at Construction Joints

1. To new concrete construction joints:
  - a. Thoroughly clean and saturate joint with water.
  - b. Cover horizontal wall surfaces as specified in this Section, and immediately place concrete.
  - c. Limit concrete lift placed immediately on top of bonding compound to 12 inches thick.
  - d. Thoroughly vibrate to mix and consolidate bonding compound and concrete together.

#### J. Bonding new concrete to old concrete:

1. Mechanically roughen existing concrete surfaces to a clean, rough surface using appropriate mechanical means to remove the existing concrete surface, and provide a minimum roughness profile of 1/4-inch.
2. Saturate surface with water for 24 hours, cover with epoxy bonding compound and place concrete as specified for new concrete.

#### K. Expansion Joints

1. Expansion joints shall be located as shown on contract drawings.
2. The joint shall include a joint filler, a bond breaker and joint sealant and installed as indicated on contract drawings.

#### L. Joint Sealants.

1. Prepare surface in accordance with manufacturers directions.
2. Apply primer as recommended by sealant manufacturer.
3. Install sealant with the proper tools and methods as directed by the sealant manufacturer.

#### M. Patching

1. Immediately after stripping forms, patch minor defects, form-tie holes, honeycombed areas, etc., before concrete is thoroughly dry.
2. Repair gravel pockets by cutting out to solid surface, form key, and thoroughly wet before placing patching mortar consisting of 1 part cement to 2 parts fine sand; compact into place and neatly finish. Honeycombed areas or gravel pockets which, in the Engineer's opinion are too large and unsatisfactory for mortar patching as described above, shall be cut out to solid surface, keyed, and packed solids with matching concrete to produce firm bond and surface.
3. The Contractor shall do all the cutting as required by himself or other trades. All such work shall be of the minimum size required. No excessive cutting will be permitted, or shall any structural members or reinforcement be cut.
4. The Contractor shall do all patching after work by other trades has been installed, where required, using Portland Cement Mortar 1:2 mix.

#### N. Protection and Curing

1. Protect concrete from injurious action of the elements and defacement of any nature during construction operations.
2. Keep concrete in a thoroughly moist condition from the time it is placed until it has cured, for at least (7) days.
3. Carefully protect exposed concrete corners from damage.
4. Allow no slabs to become dry at any time until curing operations are complete. In general, slabs shall be cured with non-staining curing paper, hosing or fog spray; vertical surfaces shall be curing with Burlene or fog spray or an approved curing compound.
5. Protect fresh concrete from drying winds, rain, damage, or spoiling. Curing paper shall be lapped 4 inches minimum at joints and sealed with waterproof tape.

#### O. Finishing Formed Surfaces

1. General: Addition of Material: The addition of cement, sand, water or mortar to slab surfaces while finishing concrete is strictly prohibited.
2. Rough-Formed Finish: This finish has an as-cast texture imparted by the form-facing material with tie holes and defective areas repaired and patched. Remove fins and other projections exceeding the limits specified by ACI 117 for the class of surface specified.
  - a. All surfaces that will be permanently concealed below grade shall have a Rough-Formed Finish.
3. Smooth-Formed Finish: This finish has an as-cast texture imparted by the form-facing material, arranged in an orderly and symmetrical manner with a minimum of seams. Repair and patch tie holes and defective areas. Remove all fins and other projections.

- a. Apply a Smooth-Formed Finish to all surfaces to be covered with a coating or covering material applied directly to the concrete such as waterproofing, dampproofing, veneer plaster or painting.
  - b. Apply to the interior surfaces of tanks holding process water.
  - c. Apply to baffle walls in the wet well.
  - d. Do not apply rubbed finish to smooth-formed finish.
4. Rubbed Finish:
- a. Smooth-Rubbed Finish: Not later than one day after form removal, moisten the concrete surfaces and rub with a silicon-carbide brick to produce a uniform color and texture. Do not apply cement grout other than that created by the rubbing process. Apply to the surfaces that will be permanently exposed to view.
  - b. Grout-Cleaned Finish: Wet the concrete surfaces and apply a grout of a consistency of thick paint to coat the surfaces and small holes. Mix one part Portland cement to one and one-half parts fine sand with a 1:1 mixture of bonding admixture and water. When the grout whitens, rub the surface with clean burlap and keep the surface damp with a fog spray for at least 36 hours. Apply Grout-Cleaned Finish to the surfaces of all channels that will carry flowing process water. This requirement is applicable to the concrete surfaces of the wet well.
5. Related Unformed Surfaces:
- a. At tops of walls, horizontal offsets and similar unformed surfaces adjacent to formed surfaces, strike off smooth and finish with a texture matching the adjacent formed surfaces. Continue the final surface treatment of formed surfaces uniformly across adjacent unformed surfaces unless otherwise specified.
6. Finishing Floors and Slabs
- a. General: Addition of Material: The addition of cement, sand, water, or mortar to slab surfaces while finishing concrete is strictly prohibited.
  - b. Comply with the recommendations of ACI 302.1R for screeding, restraightening and finishing operations for concrete surfaces.
  - c. Float Finish:
    - 1) Consolidate the surface with power-driven floats or by hand floating if the area is small or inaccessible to power-driven floats. Restraighten, cut down high spots and fill in low spots. Repeat float passes and restraightening until the surface is left with a uniform, smooth granular texture.
    - 2) Apply float finish surfaces to receive a trowel finish.
  - d. Trowel Finish:
    - 1) After applying float finish, apply first trowel finish and consolidate concrete by hand or power driven trowel. Continue troweling passes and restraighten until the surface is free of trowel marks and is uniform in texture and appearance. Grind smooth any surface defects that would telegraph through applied coatings or floor coverings.

- 2) Apply a trowel finish to interior floor and slab surfaces exposed to view or to be covered with resilient flooring, carpet or ceramic tile and the wet well trench floor.
  - 3) Finish surfaces to the following tolerances measured within 24 hours of troweling according to ASTM E 1155 for a randomly trafficked floor surface.
  - 4) Specified overall values of flatness, FF 25; and levelness, FL 20; with minimum local values of flatness, FF 17; and levelness, FL 15.
- e. Broom Finish
- 1) Immediately after float finishing, slightly roughen trafficked surface by brooming with a fiber-bristle broom. Broom transverse to traffic or at right angles to the slope of the slab. Permit surface to harden sufficiently to retain the scoring or ridges.
  - 2) Apply a broom finish to all exterior concrete pads, walkways and slabs on grade.

P. Defective Work

1. The following concrete work shall be considered defective and may be ordered by the Engineer to be removed and replaced at Contractor's expense:
  - a. Incorrectly formed.
  - b. Not plumb or level.
  - c. Not specified strength.
  - d. Containing rock pockets, voids, honeycomb, or cold joints.
  - e. Containing wood or foreign matter.
  - f. Otherwise not in accordance with the intent of the Drawings and Specifications.

END OF SECTION

## SECTION 03320

### CONCRETE SEALANT

#### PART 1 GENERAL

##### 1.01 SECTION INCLUDES

- A. Requirements to seal all exposed concrete shown on the drawings or specified herein.

##### 1.02 REFERENCES

- A. American Society for Testing and Materials (ASTM).
  - 1. C309, Specification for Liquid Membrane-Forming Compounds for Curing Concrete.

##### 1.03 SUBMITTALS

- A. In accordance with Section 01300.
- B. Shop Drawings:
  - 1. Curing methods proposed.
  - 2. Manufacturer's data for the following products as applicable:
    - a. Exposed aggregate finish retardant on formed surface.
    - b. Evaporation retardant.
    - c. Curing compound.
    - d. Clear sealer.
    - e. Clear floor hardener.
- C. Quality Control Submittals:
  - 1. Curing Compound: Manufacturer's Certificate of Compliance showing moisture retention requirements.
  - 2. Retardants for Exposed Aggregate Finish: Manufacturer's Certification of Compliance.

#### PART 2 PRODUCTS

##### 2.01 MATERIALS

- A. Curing Compound:
  - 1. Solvent-based, high chlorinated rubber solids content curing compound meeting requirements of ASTM C309.
    - a. Moisture Loss: 0.030 gm/square cm/72 hours maximum.
    - b. Capable of meeting moisture retention with one coat.
  - 2. Manufacturers and Products:
    - a. Master Builders Co., Cleveland, OH; Masterkure CR.
    - b. Euclid Chemical Co., Cleveland, OH; Euco Super Floor Coat.
    - c. Or equal.
- B. Evaporation Retardant:
  - 1. Optional: Fluorescent color tint that disappears completely upon drying.



2. Manufacturers and Products:
  - a. Master Builders Co., Cleveland, OH; CONFILM.
  - b. Euclid Chemical Co., Cleveland, OH; Eucobar.
  - c. Or equal.
- C. Clear Sealer (One-Component Penetrating Silane Siloxane Sealer):
  1. Manufacturers and Products:
    - a. Master Builders, Inc.; MASTERSEAL SL.
    - b. Euclid Chemical Co.; Eucoguard 200.
    - c. Or equal.
- D. Clear Floor Hardener:
  1. Colorless, aqueous premixed solution of zinc and magnesium fluosilicate.
  2. Each gallon of fluosilicate solution shall contain minimum 2 pounds of crystals.
  3. Manufacturers:
    - a. Master Builders Co., Cleveland, OH.
    - b. Euclid Chemical Co., Cleveland, OH.
    - c. Sonneborn, Minneapolis, MN.
- E. Waterproofing Membrane System
  1. Methacrylate to be a one or two coat rapid curing cold liquid spray applied seamless membrane.
  2. The membrane shall be able to bridge live cracks up the 1/8 inch in width and conform to ASTM C1305.
- F. Water: Clean and potable, containing less than 50 ppm of chlorides.

## PART 3 EXECUTION

### 3.01 CURING OF CONCRETE

- A. Use one of the following methods as approved by ENGINEER:
  1. Walls:
    - a. General: Where walls are to receive coatings, painting, cementitious material, or other similar finishes, or where solvent-based coatings are not permitted, use only water curing procedures.
    - b. Method 1: Leave concrete forms in place and keep entire surfaces of forms and concrete wet for 7 days.
    - c. Method 2: Apply curing compound, where allowed, immediately after removal of forms.
    - d. Method 3: Continuously sprinkle with water 100 percent of exposed surfaces for 7 days starting immediately after removal of forms.
  2. Slabs and Curbs:
    - a. Method 1: Protect surface by water ponding for 7 days.
    - b. Method 2: Cover with burlap or cotton mats and keep continuously wet for 7 days.
    - c. Method 3: Cover with 1-inch layer of wet sand, earth, or sawdust, and keep continuously wet for 7 days.
    - d. Method 4: Continuously sprinkle exposed surface for 7 days.

- e. Other agreed upon method that will keep moisture present and uniform at all times on surface of slabs. Do not use curing compounds.
  - f. Where water curing for slabs during cold weather is not possible, use an ENGINEER-approved curing compound at manufacturer's recommended coverage per gallon.
  - g. Where curing compound cannot be used, special methods using moisture shall be agreed upon prior to placing the concrete slabs.
  - h. Protect slabs during cold weather with plastic sheets or other materials inside required heated enclosure if foot traffic is permitted on slabs.
- B. Use only water curing on potable water structures.
  - C. Use only water curing methods where solvents in the curing compounds are prohibited by state or federal air quality laws.
  - D. Use only water curing where additional finishes such as clear sealer, hardeners, painting, and other special coatings are required.

### 3.02 EVAPORATION RETARDANT APPLICATION

- A. Spray onto surface of fresh flat work concrete immediately after screening to react with surface moisture.
- B. Reapply as needed to ensure a continuous moist surface until final finishing is completed.

### 3.03 CLEAR SEALER APPLICATION

- A. Apply where indicated in Finish Schedule.
- B. Before application, water cure concrete walls and floors to receive sealer for a minimum of 28 days, keep clean, unpainted, free from membrane curing compounds, with Work above them completed.
- C. Apply with stiff brush, short nap roller, squeegee, garden sprayer, or conventional paint spray equipment.
- D. Apply at a coverage rate of 125 to 200 square feet per gallon and cure the sealer on slabs for the following minimum cure time at the ambient temperatures shown prior to allowing foot traffic:
  - 1. 90 degrees F - 2 hours.
  - 2. 75 degrees F - 4 hours.
  - 3. 50 degrees F - 8 hours.
  - 4. 35 degrees F - 16 hours.

### 3.04 CLEAR HARDENER APPLICATION

- A. Before application, water cure floors to receive hardener for minimum 28 days, keep clean, unpainted, free to membrane curing compounds, and perfectly dry with all work above them completed.
- B. Apply hardener evenly, using three coats, allowing 24 hours between coats.
  - 1. First coat 1/3 strength, second coat 1/2 strength, and third coat 2/3 strength, mix with water
  - 2. Apply each coat so as to remain wet on surfaces for 15 minutes.

3. Apply approved hardeners in accordance with manufacturer's instructions.
4. After final coat is completed and dry, remove surplus hardener from surface by scrubbing and mopping with water.

### 3.05 MANUFACTURER'S SERVICES

- A. Provide manufacturer's representative at site for installation assistance, inspection, and certification of proper installation for products specified.
- B. Provide clear sealer manufacturer's representative to demonstrate proper application of product.
- C. Provide floor hardener manufacturer's representative to demonstrate proper mixing and application of product.
- D. Provide curing compound manufacturer's representative to demonstrate proper application of curing compound to show coverage in one coat.

END OF SECTION

## SECTION 03604

### NON-SHRINK CONSTRUCTION GROUT

#### PART 1 GENERAL

##### 1.01 SECTION INCLUDES

- A. This Section specifies furnishing and installing non-shrink grout for interior and exterior use, as indicated.

##### 1.02 REFERENCES

- A. U.S. Corps of Engineers CRP - C - 588
- B. ACI - 305, American Concrete Institute
- C. ACI - 306, American Concrete Institute

##### 1.04 SUBMITTALS

- A. Product Data: Provide data on non-shrink grout.
- B. Submit certificate of compliance attesting to conformance of products to the requirements of this Section.
- C. Submit manufacturers' installation and application instructions for products.

##### 1.05 PRODUCT DELIVERY, STORAGE, AND HANDLING

- A. Deliver materials in original, tightly sealed, polyethylene lined, multiple ply bags, clearly labeled with manufacturer's name, brand name and number, and batch number of the material.

##### 1.06 JOBSITE CONDITIONS

- A. Ensure surfaces to be grouted or patched are clean and sound, and are not feathered at edges. Handle grout as concrete with regard to temperature and curing, as specified in Section 03300.
- B. Observe safety precautions as outlined in the manufacturer's literature and as printed on containers and labels.

#### PART 2 - PRODUCTS

##### 2.01 GENERAL

- A. Premixed grout comprised of blended portland cements, graded silica aggregates, special plasticizing agents and other ingredients.
- B. Conform to requirements of U.S. Corps of Engineers CRD-C-588 and to the following performance requirements listed in Article 2.02 when tested at the moderate fluidity, flowable, level.
- C. The grout shall exhibit a small but predictable amount of expansion sufficient to counteract the normal shrinkage of cement, and shall be dimensionally stable. The expansion shall occur after initial set to insure maximum contact between grout and base plates. The grout shall be extremely flowable at low water levels and shall not bleed at the moderate fluidity level specified nor exhibit segregation of aggregates.

At a highly flowable consistency, high compressive strength shall be attainable in a 24-hour period with continuous build-up for 28 days. The resulting cured material shall be very hard and highly resistant to penetration and breakdown by oils, water or vibration grout shall contain no iron particles, gypsum, gas forming agents, no added chloride, and shall not react with magnesium.

## 2.02 PERFORMANCE REQUIREMENTS

- A. When tested as provided herein, grout shall meet the following performance requirements:
  - 1. When tested as provided herein, grout shall meet the following performance requirements:
    - a) Expansion at 3, 14, and 28 days: 0.4 percent maximum at any of these ages.
    - b) Expansion at 3 and 14 days: not greater than expansion at 28 days.
    - c) Shrinkage at 28 days: none, these requirements will be met if expansion tests give a positive value at 28 days.
    - d) Compressive strength:
      - 1) At seven days: 2500 psi min.
      - 2) At 28 days: 5000 psi min.
      - 3) Time of final setting: eight hours max.
    - e) Moderate fluidity, flowable: 124-145 (flow table, 5 drops, CRDC-277).

## 2.03 DEGREASING AND ETCHING CHEMICAL

- A. Composition and Materials: Blend of organic and inorganic acids with a special solvent system incorporating wetting agents for emulsification.
- B. Color: Water White
- C. Flash Point: Above 150°F
- D. Weight per gallon: 9.0 Pounds

## PART 3 EXECUTION

### 3.01 PREPARATION OF CONCRETE SURFACES

- A. Remove dust, laitance, grease, curing compounds, impregnations, waxes, foreign particles, and disintegrated materials by mechanical abrasion methods such as sandblasting. Sandblast structural and reinforcing steel to remove loose material and expose sound metal.
- B. If the concrete surfaces are sound and it is only necessary to remove laitances, grease or dust, the Contractor may, with the prior written approval of the Engineer, forego sandblasting and wash the concrete with a degreasing and etching chemical applied in accordance with the manufacturer's written instructions and as specified herein.
- C. Application of Degreaser and Etching Compound. Prewet concrete surfaces with clean water. Brush concentrated cleaner onto concrete surface. Let stand three to four minutes and reapply, brushing stained areas vigorously. Rinse off with fresh water applied at a minimum pressure of 800 psi and a minimum volume of five gallons per minute.
- D. Construct appropriate sturdy forms to contain grout at the fluidity level at which it will be used. Saturate foundations and forms for a minimum of six hours prior to

grouting. Remove all standing water or puddles prior to application of grout. Take special care to eliminate water from bolt holes and other cavities.

### 3.02 MIXING

- A. Mix only with cool, clean, drinkable water. Do not overwater grout. Do not mix more grout than can be properly placed within 20 minutes of mixing.

### 3.03 APPLICATION

- A. Place grout only from one side of base plates to avoid entrapping air. Provide adequate air vent holes in large base plates. Work or flow grout into place, filling all cavities. Shut down near-by equipment which may cause vibration. Allow adequate curing time for strength development before placing a load on the grout.
- B. Place grout within twenty minutes of the addition of water to the batch.
- C. Reinforce grout pads or applications three inches or more in thickness with wire mesh or reinforcement bars.
- D. Rodding or chaining is acceptable to assist in placement or consolidation of grout. Excessive mechanical vibration may cause segregation of aggregates and will not be permitted.
- E. Cool mixing water and grout when temperature exceeds 80°F. in the area to be grouted. Comply with ACI-305. Cure and seal exposed grout with epoxy membrane curing compound to prevent rapid surfacing drying, shrinkage and cracking, or damp cure the grout.
- F. Heat mixing water and grout when temperature falls below 50°F in the area to be grouted. Do not exceed 80°F. Comply with ACI-306. Do not add accelerators to grout.

### 3.04 AGGREGATE EXTENSIONS

- A. Where indicated, extend the yield of expansive-cement type grout by utilizing aggregate filler in the size range of 3/8 inch washed pea gravel. Run trial mixes verifying the acceptability of this extended grout mix to the Engineer prior to use.

END OF SECTION

## SECTION 03930

### CONCRETE REHABILITATION

#### PART 1 GENERAL

##### 1.01 SCOPE OF WORK

- A. Furnish all labor, materials, equipment, and incidentals required to perform all concrete repair work as shown on the drawings and as specified herein. All existing interior tank walls shall be thoroughly blast-cleaned and inspected for concrete spalls and cracks. It is the Contractors responsibility to field determine area of concrete rehabilitation once surfaces are clean and clearly visible. Areas of repair shall be identified and marked for repair by the Contractor for approved by the Engineer. Concrete repairs shall be performed in accordance with these specifications and the contract drawings.
- B. Work under this item shall apply to all existing interior concrete walls of the following tanks during the following Phases:
  - a. Solids Handling Improvements: Sludge Thickeners #1 and #2
  - b. Phase 1 Improvements: Primary Clarifiers #1, 2, and 3, and Chlorine Contact Chamber
  - c. Phase 2 Improvements: Aeration Tank #1, 2, 3, 4, 5, and 6; Final Clarifiers #1, 2, 3, & 4 (Final Clarifiers are part of Additive Alternative #1)
- C. The work shall include but not limited to the following:
  - 1. Concrete Removal
    - i. The removal and disposal of all deteriorated and spalled concrete for Shallow or Partial Depth Repair shall be included as part of this Item.
    - ii. Included under this Section are all costs in connection with the cleaning, cutting, and bending of the existing reinforcing steel designated to be retained in the proposed construction. Also included as incidental to this item shall be the roughening of existing concrete surfaces for the placement of new concrete as shown on the Plans or directed by the Engineer.
  - 2. Shallow Depth Repair
    - i. This repair consists of furnishing and placing a polymer-modified, cementitious, 2-component, fast-setting, trowel grade patching mortar to patch vertical, horizontal, and overhead surfaces on the existing structure in areas of spalled concrete. This Item does not include the repair of any horizontal or vertical spalls which exceed

1½ inches in depth. The repairs to those areas shall be made with 4000 PSI, 3/8 IN., 660 Cement Concrete.

3. Partial Depth Repair

- i. The work to be done under this repair shall consist of replacing concrete removed in deteriorated or spalled areas greater than 1½" deep. The work shall also consist of furnishing and placing 4,000 PSI, 3/8 IN., 660 Cement Concrete Masonry to repair as directed.
- ii. The Contractor shall have the approval of the Engineer certifying that the existing concrete has been removed to the required limits and that adequate surface preparation has been achieved before any concrete is placed.
- iii. Bonding Agent: Immediately prior to all concrete pours, the Contractor will apply an bonding agent approved by the Engineer to the excavated surfaces of the concrete. The bonding agent will be worked into the surfaces with stiff brushes or brooms. Bonding Agent will be considered incidental to this Item. Products to be used for this item shall be approved by the Engineer before the Contractor begins his operations. If the bonding compound prematurely hardens, additional bonding compound shall be applied, if allowed by the bonding compound manufacturer or the hardened bonding compound shall be addressed as per the bonding compound manufacturer's recommendations.

4. Replacement and Coating of steel reinforcing within concrete repair areas.

- i. Any steel that is unsuitable for further use through no fault of the Contractor shall be replaced and coated under this Item and in accordance with Section 03200 – Reinforcement. All reinforcing steel that is loose shall be tied tightly together using wire ties.

1.02 RELATED WORK SPECIFIED ELSEWHERE

- A. Section 03200 - Reinforcement
- B. Section 03940 - Crack Repairs by Epoxy Injection
- C. Section 09880 - Concrete Protective Coating

1.02 REFERENCES

- A. American Society for testing and Materials (ASTM)
  1. ASTM C109 – Standard Test Method for Compressive Strength of Hydraulic Cement Mortars (Using 2 inch Cube Specimens)
  2. ASTM C882 – Standard Test Method for Bond Strength of Epoxy Resin Systems Used with Concrete by Slant Shear
- B. International Concrete Repair Institute (ICRI)



1. ICRI Guideline No. 310.1R-2008 Guide for Surface Preparation for the Repair of Deteriorated Concrete Resulting from Reinforcing Steel Corrosion (formerly Guideline No. 03730)
  2. ICRI 03732 – Selecting and Specifying Concrete Surface Preparation for Sealers, Coating, and Polymer Overlays
- C. The Society of Protective Coating
1. SSPC-SP13 – Surface Preparation of Concrete

### 1.03 SUBMITTALS

- A. Product Data: Manufacturer's specifications and installation instructions for factory packaged products.
1. Manufacturer's recommendation and product data sheets for all products supplied under this Section.
  2. Safety Data Sheets (SDS) for any materials brought on-site including materials, solvents, and abrasive blast media.
  3. Storage requirements including temperature, humidity, and ventilation for coating system materials.
- B. A list of three of the Contractor's projects for which the types of repair specified herein were successfully completed. Including documentation of qualifications for specified works.

### 1.04 QUALITY ASSURANCE

- A. Field Examples: Prior to performing the Work of this Section, prepare a sample panel, or a portion of existing concrete which is to be repaired, to represent each type of rehabilitation work required. Approved samples will be used as quality standards for the Work. Maintain approved samples at the site until the Work is completed.
- B. Contractor qualifications. Complete a program of instruction in the application of the approved manufacturer's material and provide certification from the manufacturer attesting to their training and status as an approved applicator.
- C. No existing structure or concrete shall be shifted, cut, removed, or otherwise altered until authorization is given by the Engineer.
- D. When removing materials or portions of existing structures, all precautions shall be taken and all necessary barriers, temporary support systems and other protective devices shall be erected to prevent damage to the structures beyond the limits necessary for the new work, protect personnel, control dust and to prevent damage to the structures or contents by falling or flying debris. Unless otherwise permitted, shown or specified, line drilling will be required in cutting existing concrete.

- E. The Contractor's supervisor shall have attended a training program sponsored by the manufacturer supplying the materials approved for this project.
- F. A representative of the product manufacturer shall be present for the first three days of installation to give instructions to the installation crew.
- G. A representative of the product manufacturer shall make periodic site visits to ensure the product is being installed in accordance with published instructions.
- H. The Contractor shall make available all locations and phases of the work for access by the Engineer or other personnel designated by the Engineer. The Contractor shall provide ventilation and safe access to the work.
- I. The Contractor is solely responsible for the workmanship and quality of the modification work. Inspections by the manufacturer, the Engineer, or others do not limit the Contractor's responsibility for the quality of the work.
- J. Material Container Labels: Material containers shall bear the manufacturer's label indicating manufacturer's name, trade name of product, lot number, shelf life of product, and mix ratio (if applicable).

#### 1.05 DELIVERY, STORAGE, AND HANDLING

##### A. Delivery of Materials:

1. Deliver new and unopened materials to the site in original, sealed containers. Do not deliver materials that have exceeded shelf life limitation set forth by the manufacturer.
2. Containers shall be clearly labeled with the following information:
  - i. Manufacturer's name
  - ii. Name or title of material, and other product identification
  - iii. Manufacturer's stock number and batch number
  - iv. Date of manufacture
  - v. Instructions
  - vi. Expiration or "use by" date

##### B. Storage of Materials:

1. Store the products in accordance with the manufacturers' recommendations, and supplementary requirements below.
2. Restrict storage to repair materials and related equipment.
3. Comply with health and fire regulations including the requirements of the Occupational Safety and Health Administration (OSHA).

##### C. Handling of Materials:

1. Comply with manufacturer's printed instructions for storing and handling materials.

2. Handle materials carefully to prevent inclusion of foreign materials.
3. Do not open containers or mix components until necessary preparatory work has been completed and application work will start immediately.

#### 1.06 PROJECT CONDITIONS

- A. Environmental Requirements: Comply with the product manufacturer's printed limitations and instructions.

#### 1.07 WARRANTY

- A. The Contractor shall warrant, and shall obtain from the manufacturers their warranties, that the products used will be free from defects in materials and workmanship for a period of five years from the date of substantial completion. Said manufacturer's warranty shall be in a form acceptable to and for the benefit of the Owner and shall be submitted by the Contractor as a condition of final payment. The Contractor shall repair or replace, at the sole option of, and at no cost to, the Owner, any work found to be defective within said warranty period. Such repair or replacement shall include the cost of removal and reinstallation.

### PART 2 PRODUCTS

#### 2.01 COMPANIES

- A. The Euclid Chemical Company, 19218 Redwood Rd., Cleveland, OH 44110-2799, (800) 321-7628, [www.euclidchemical.com](http://www.euclidchemical.com).
- B. Sika Corporation, 201 Polito Ave., Lyndhurst, NJ 07071, (800) 933-7452, [www.sikausa.com](http://www.sikausa.com).
- C. Kaufman Products, Inc., 3811 Curtis Ave., Baltimore, MD 21226, (800) 637-6372, [www.kaufmanproducts.net](http://www.kaufmanproducts.net).
- D. L&M Construction Chemicals, Inc., 14851 Calhoun Rd., Omaha, NE 68152, (800) 362-3331, [www.lmcc.com](http://www.lmcc.com).
- E. Conproco Corp., 17 Production Dr., Dover, NH 03820, (800) 258-3500, [www.conproco.com](http://www.conproco.com).
- F. BASF Building Systems, 889 Valley Park Dr., Shakopee, MN 55379, (800) 433-9517, [www.buildingsystems.basf.com](http://www.buildingsystems.basf.com).

#### 2.02 MATERIALS

- A. The following brand names are specified to establish product generic type and standard of quality. Other comparable products in the manufacturer's same product series may be required to closely fit the particular job conditions. Use appropriate product for depth of patch and temperature at time of application. More than one

product may be required for a particular type of patching mortar. When a color choice is available, select the color to match adjoining concrete as closely as practicable. A bonding agent/primer and/or sealer shall be used as recommended by the patching mortar manufacturer.

- B. Cement/Acrylic/Latex Base Patching Mortars for Shallow Depth Repair:
  - 1. Type C-2 Patching Mortar: “SikaTop 121 Plus”, “SikaTop 122 Plus” or “SikaTop 111 Plus” by Sika Corp.; “Patchwell Kit”, “Patchwell Deep”, “SureFlow 040”, or “SureFlow 042” by Kaufman Products, Inc.; “Thincoat” or “Concrete Coat” by The Euclid Chemical Company;
  - 2. Type E-3 Patching Mortar: High modulus, medium/low viscosity, moisture insensitive, epoxy resin and aggregate system; “Sikadur 35” or “Sikadur 52” by Sika Corporation, “Duralcrete” by The Euclid Chemical Company or “SurePoxy HM”, “SurePoxy HM, Class B”, “SurePoxy HMLV”, “SurePoxy HMLV, Class B”, “SurePoxy HMSLV”, “SurePoxy HiBild” by Kaufman Products, Inc.
- C. 4000 PSI, 3/8 Inch, 660 Cement Concrete for Partial Depth Repair shall be accordance with Section 03300.
- D. Steel Reinforcing shall be in accordance with Section 03200.
- E. Rebar Coating: “SurePoxy HMEPL” or SurePoxy HM 12” by Kaufman Products, Inc.; “ECB” by Conproco Corp.; or “MasterEmaco P122” or “MasterEmaco P124” by BASF Building Systems.
- F. Cleaning Agent, Bonding Agent/Primer, Sealer/Topcoat: As recommended by the patching mortar manufacturer, including primer for the reinforcing steel and primer for the concrete substrate.
- G. Concrete and Bonding Agent (for concrete): Normal weight cast-in-place concrete and adhesive bonding agent as specified in Section 03300.

## PART 3 EXECUTION

### 3.01 INSPECTION OF CONCRETE SURFACES

- A. The locations, details, and limits are to be field-determined by the Contractors after blast-cleaning all interior concrete tank walls. Repair areas are to be confirmed by the Engineer prior to commencing work.
- B. The Contractor will perform his own investigations and will “evaluate” and mark out the surfaces of the concrete to determine the areas for repairs. Methods for evaluation shall include nondestructive methods such as visual observations and acoustic impact method using a hammer or chain drag (for horizontal surfaces only). The Contractor is referenced to ACI Report 201.1R-92 “Guide for Making a Condition Survey of Concrete in Surface” and ACI Report 364.1R-94 “Guide for Evaluation of Concrete Structures Prior to Rehabilitation” in regard to evaluation methods. Before any existing concrete is removed, the Contractor will provide the Engineer clear access to the areas designated for repair. During this time, the Engineer will perform an inspection of the

areas and will approve and/or designate the areas where concrete removal and repair will be required.

- C. It shall be the responsibility of the Contractor to inform the Engineer, in writing, of the date that a structure will be available for inspection operations. Notification shall be given to the Engineer at least seven (7) days prior to the date that the area in question will be in a condition acceptable to the Engineer.
- D. The Contractor will not be allowed to do any further repair work until all necessary inspection operations have been performed, unless given permission by the Engineer.
- E. The Contractor will include any costs related to this inspection in the general cost of work related to this Section.

### 3.02 PREPARATION

- A. Protection: Cover or otherwise protect adjacent surfaces not being repaired.
- B. Preparation for Concrete Removal
  - 1. Areas to be repaired must be clean, sound, and free of contaminants. All loose and deteriorated concrete shall be removed by mechanical means. Mechanically prepare the concrete substrate to obtain a surface profile of +/- 0.25 inches with a new exposed aggregate surface. Area to be patched shall not be less than ½ inch in depth for repairs using Cementitious Mortar for Patching and 1½ inches for repairs using 4000 PSI, 3/8", 660 Cement Concrete.
  - 2. If reinforcing steel is exposed, then clean by mechanical cleaning and then high pressure washing with water that does not contain detergents or any bond inhibiting chemicals. Where active corrosion has occurred that would inhibit bonding, abrasion blast steel to white metal finish.
  - 3. After removals and edge conditioning are complete, remove bond inhibiting materials (dirt, grease, loosely bonded aggregate) by oil-free compressed air, abrasion blasting, or high pressure water blasting with water that does not contain detergents or any bond inhibiting chemicals. Check the concrete surfaces after cleaning to insure that surface is free from additional loose aggregate or that additional delaminations are not present.
  - 4. After the surface preparation has been accepted, every effort should be made to thoroughly wet the concrete surface, and all porous surfaces to be in contact with new concrete, for 12 hours. This may be accomplished by continuous wetting with soaker hoses or the use of burlap/burlene, etc. where moisture can be maintained. If, in the opinion of the Engineer, conditions or the situation prohibits this, then the surfaces should be wetted for as long as

possible. Surfaces must be wetted by a means acceptable to the Engineer using potable water.

5. The Contractor shall remove any puddles of free standing water with oil-free compressed air, and protect the surfaces from drying, so the existing concrete remains in a clean, saturated surface dry condition until placement of the new concrete.

### 3.03 CONCRETE REMOVAL

#### A. Removal of Deteriorated Concrete:

1. All deteriorated concrete designated for removal under this Item shall be removed within the limits identified by the Contractor and approved by the Engineer. The lateral limits of each area to be repaired will be delineated by the Contractor and suitably marked and subsequently approved by the Engineer. Where several areas are to be repaired are very close together, the Engineer may combine these individual repairs into a larger area. The outlines of each such area shall first be cut to a depth of ½ inch with an approved power-saw capable of making straight cuts. In the event that reinforcing steel is encountered within the outer ½ inch depth during sawing operations, the depth of sawcut shall immediately be adjusted to a shallower depth so as not to damage the steel bars. If so directed by the Engineer, sawcutting shall again be carried down to the ½ inch depth at other locations of repair provided reinforcing steel is not again encountered. Where over-breakage occurs resulting in a featheredge, the featheredge shall be squared up to a vertical edge in an approved manner. Where sawing is impractical, the area shall be outlined by chisel or other approved means.
2. After completion of concrete removal, the sides of the patch shall be vertical down to the bottom of the patch.
3. The minimum depth of concrete removal shall not be less than the specified minimum thickness of repair material.
4. If removal of deteriorated concrete results in full or partial exposure of reinforcing steel, but less than 1" clearance exists between the sound concrete and the inside surface of exposed reinforcing steel, enough sound concrete as is necessary to achieve this 1" minimum clearance shall be removed.
5. Where the existing reinforcing steel is damaged or deteriorated it shall be supplemented with new reinforcing steel of the same size. Pneumatic tools shall not be placed in direct contact with reinforcing steel. Any sound reinforcing steel damaged during the concrete removal operations shall be repaired or replaced by the Contractor at his expense as directed by the Engineer. New steel shall be attached beside existing steel with a minimum splice length as indicated on the Plans, or as directed by the Engineer. The concrete shall be removed to a minimum depth of 1 inch below the new steel. New reinforcing steel for concrete repairs shall be included as part of this Section.

- i. During the prosecution of the Work, the Engineer may reject the use of any method or equipment, which causes undue vibration or possible damage to the structure or any part thereof. In no event shall any pneumatic hammers heavier than the nominal 25 Lbs. (Chicago Pneumatic No. 111 or equal) be used, unless approved by the Engineer. Also, no use of pneumatic or power driven chipping hammers over the nominal 15 Lbs. will be permitted to remove any concrete from below any reinforcing bar.
- ii. The Contractor shall take all precautions necessary so as not to damage reinforcing steel that is to remain. This includes determining the concrete cover to the steel bars at the edge of each patch prior to excavating concrete.
- iii. All excavations shall be squared off by sawcutting. Any sawcut and removal of reinforcement required shall be considered incidental to this item. The Contractor shall not remove any concrete beyond the specified limits unless ordered to do so by the Engineer. Any existing concrete designated to be retained during construction that is damaged by the Contractor's operation shall be replaced at the Contractor's expense as directed by the Engineer.
- iv. Immediately before preparation for placement of new concrete, the exposed area to be patched shall be free of foreign materials. These materials shall be removed by grit blasting or wire brushing and by use of compressed air. No grease, dust, rust, or laitance will be allowed to remain on reinforcing steel and exposed concrete surfaces.
- v. Surplus materials obtained from any type of excavation, and not needed for further use, as determined by the Engineer shall become the property of the Contractor and shall be disposed of by the Contractor outside the location subject to the regulations and requirements of all authorities governing the disposal of such materials, at no additional compensation.
- vi. The Contractor is required to broom clean all work site areas after the removal of excavated debris regardless of preexisting conditions. This includes areas under the excavated repair area such as pier caps, revetment areas, and bridge shielding areas. Removal of debris, site cleaning, and disposal of debris is incidental to the Contract and no additional payment will be made.

#### 3.04 SHALLOW DEPTH REPAIR WITH CEMENTITIOUS MORTAR FOR PATCHING

- A. The polymer modified cementitious patching mortar shall be in accordance with Part 2.02 of this Section

#### B. Mixing

1. Mix manually or mechanically. The mortar shall be prepared in accordance with the Manufacturer's instructions.

#### C. Application Methods

1. At the time of application, surfaces should be damp (saturated surface dry) with no glistening water. Mortar must be worked into the substrate filling all pores and voids. Force the material against the edge of the repair, working towards the center. After filling, consolidate, then screed.
2. The maximum thickness of application in one pass shall be 1". If the depth of patch exceeds 1", the mortar shall be placed in two passes of approximate equal thickness. Before the first pass has achieved an initial set, the surface shall be prepared for the second pass by scratching with a trowel to form a grid of deformation on the surface.
3. Prime and work the mix into the substrate, filling all pores and voids. Avoid puddling of the primer on horizontal substrates.

#### D. Curing

1. Use of fine mist spray of water, wet burlap, or non-solvent approved curing compound if ambient conditions might cause premature surface drying, i.e., high temperature, low humidity, strong winds. If necessary, protect newly applied mortar from rain. To prevent freezing, the Contractor shall cover the application area with insulating material, to the satisfaction of the Engineer.

#### E. Manufacturers Field Representative

1. The Contractor shall arrange with the materials manufacturer or distributor to have the services of a competent field representative at the work site prior to any mixing of components to instruct the work crews in the proper mixing and application procedures. The field representative shall remain at the job site after work commences and continue to instruct until the representative and the Contractor, Inspector and/or Engineer are satisfied that the crew has mastered the technique of installing the system successfully. The representative shall make periodic visits to the project as the work progresses and shall confer on each visit with the Contractor, Inspector and/or Engineer.
2. The Manufacturer's field representative must be fully qualified to perform the work and shall be subject to the approval of the Engineer.
3. The Contractor shall be completely responsible for the expense of the services of the required field representative.

### 3.05 COATING REBAR

- A. Coat reinforcing as soon as possible after completion of surface preparation.
- B. Place reinforcement coating complying with manufacturers printed instructions.



### 3.06 PARTIAL DEPTH REPAIR WITH 4000 PSI, 3/8 INCH, 660 CEMENT CONCRETE

A. This specialized work includes, but is not limited to, the following:

1. Concrete and steel reinforcement placement shall be in accordance with Section 03300 and 03200, respectively.
2. Concrete Pump Truck: When so directed, the Contractor shall use an approved concrete pump truck to properly place the concrete and expedite work. Under no circumstances, will the pump truck be driven or parked on an existing tank.
3. Finishing Crew: When so directed, the Contractor will use a specialized finishing crew to properly finish the pours for exposed and visible repairs.
4. Any concrete cracks caused by shrinkage or temperature stresses during the curing of new concrete, poured under this item shall be sealed at no additional cost. This work includes:
  - i. Before sealing, the concrete must be dry, clean and free of contaminants. The concrete shall then be blown clean using oil free compress air immediately prior to applying the sealer.
  - ii. The cracks shall be v-notched to a minimum depth of 1/2 inch or a 1/4 inch bead of caulk shall be placed on both sides of the crack creating a trough. The crack sealer shall then be poured into the v-notch or trough. The crack shall then be observed for seepage of crack sealer and shall be refilled as necessary to ensure the crack is completely filled.
  - iii. During the application of the crack sealer, the Contractor will strictly adhere to all the manufacturer's instructions and specifications.
  - iv. The crack sealer to be used shall low viscosity, methacrylate crack sealer. The Contractors shall submit all applicable data sheets of the material to be used to the Engineer for approval.

B. Where reinforcing steel with active corrosion is encountered, the procedure shall be as follows:

1. Remove all contaminants and rust from exposed reinforcing steel.
2. When half of the diameter of the rebar is exposed, chip out behind the reinforcing steel, 1-in clear minimum.
3. The distance chipped behind the rebar shall be equal to or exceed the minimum placement depth of the material to be used.
4. Replacement of corroded reinforcement shall be in accordance with the Contract Drawings.

3.06 CLEANING

- A. Clean up spatters and droppings.

3.07 FIELD QUATITY CONTROL

- A. At completion of all repairs, the Contractor, Engineer, and installers of the materials used on the repairs shall inspect the work. Any leaky joints or cracks or repairs not in conformance with the Drawings and Specifications shall be repaired in accordance with the manufacturer's instructions at no additional cost to the Owner. At the completion of these repairs, the Contractor, Engineer, and installers of the materials shall inspect the repaired problem areas.

END OF SECTION

## SECTION 03940

### CRACK REPAIRS BY EPOXY INJECTION

#### PART 1 GENERAL

##### 1.01 SCOPE OF WORK

- A. Furnish all labor, materials, equipment, and incidentals required to perform all concrete crack repair work as shown on the drawings and as specified herein. All existing interior tank walls shall be thoroughly blast-cleaned and inspected for concrete spalls and cracks. It is the Contractor's responsibility to field determine location of concrete cracking to be repaired once surfaces are clean and clearly visible. Areas of repair shall be identified and marked for repair by the Contractor for approved by the Engineer. Concrete crack repairs shall be performed in accordance with these specifications and the contract drawings.
- B. Existing cracks designated by the Contractor, and approved by the Engineer, to be repaired by pressure injection, shall be bonded by penetration with an epoxy adhesive injected under pressure with special equipment and in accordance with the epoxy manufacturer's recommendations.
- C. The work done under this Section consists of repairing cracks in sound concrete.
- D. Work under this item shall apply to all existing interior concrete walls of the following tanks during the following Phases:
  - a. Solids Handling Improvements: Sludge Thickeners #1 and #2
  - b. Phase 1 Improvements: Primary Clarifiers #1, 2, and 3, and Chlorine Contact Chamber
  - c. Phase 2 Improvements: Aeration Tank #1, 2, 3, 4, 5, and 6; Final Clarifiers #1, 2, 3, & 4 (Final Clarifiers are part of Additive Alternative #1)

##### 1.02 RELATED WORK SPECIFIED ELSEWHERE

- A. Section 03930 - Concrete Rehabilitation
- B. Section 09880 - Concrete Protective Coating

##### 1.03 PERFORMANCE REQUIREMENTS

- A. Seepage of water through cracks repaired under the Work of this Section will be regarded as defective Work subject to the one year guarantee required by the General Conditions.

##### 1.04 SUBMITTALS

- A. Product Data: Manufacturer's printed specifications and installation instructions for epoxy adhesive and surface seal material.

B. Quality Control Submittals:

1. Test Reports:

- i. Submit reports for tests specified under Source Quality Control.
- ii. If requested, submit test reports for all specified characteristics and properties of the epoxy adhesive materials from an Independent Testing Laboratory.
- iii. Certificates: Affidavit required under QUALITY ASSURANCE Article.
- iv. Installation Contractor's Qualifications Data:
  - a. Firm name, address, and telephone number.
  - b. Period of time firm has performed crack repairs by epoxy injection.
- v. Installer's Qualifications Data:
  - a. Name of each person who will be performing the Work and their employer's name, business address and telephone number.
  - b. Period of time installer has performed crack repairs by epoxy injection.
  - c. Proof of satisfactory completion of a program of instruction in the epoxy injection process.

1.05 QUALITY ASSURANCE

B. Qualifications:

1. Installation Contractor: The firm performing the Work of this Section shall have been regularly engaged in crack repairs by epoxy injection for a minimum of 5 years, shall be licensed or approved by the epoxy adhesive manufacturer to perform such work, and shall have completed 5 similar projects in the last 5 years.
  2. Installer: The person(s) performing the Work of this Section and their Supervisor shall be personally experienced in crack repair by epoxy injection and shall have been regularly employed by a Company performing crack repair by epoxy injection for a minimum of 2 years, and shall have satisfactorily completed a program of instruction in the epoxy injection process.
    - i. The instruction shall include this specific method of repairing cracks in concrete, the technical aspects of correct material use, and the operation, maintenance and checking of equipment.
- A. Testing Agency: Tests for all specified characteristics and properties of the epoxy adhesive materials shall have been performed by a qualified Independent Testing Laboratory and copies of the test results shall be available. Tests indicated under Source Quality Control shall be performed by the adhesive manufacturer.
- B. Source Quality Control: The following quality control tests shall be performed on each lot of epoxy adhesive materials supplied for this Project. Tests shall be conducted using the test methods indicated in Part 2.

1. Resin viscosity at 77 degrees F and epoxide equivalent weight.
  2. Hardener viscosity at 77 degrees F and amine value.
  3. Combined components pot life at 77 degrees F.
  4. Cured (for 7 days) adhesive ultimate tensile strength and tensile elongation at break; and slant shear strength for wet/wet concrete cured 3 days.
- C. Material Container Labels: Material containers shall bear a manufacturer's label indicating manufacturer's name, trade name of product, lot number, shelf life of product, and mix ratio by volume.
- D. Equipment for Injection: The injection equipment shall meter and mix the adhesive components, and inject the mixed adhesive into the cracks. Equipment shall be a portable, positive displacement type pump unit with interlock to insure exact ratio control of the two components at the nozzle. Unit shall have metering pumps, electrically or air powered, which will provide in-line metering and mixing of the adhesive components.
1. Discharge Pressure: The injection equipment shall have automatic pressure control capable of discharging the mixed adhesive at any pre-set pressure up to 200 psi (within a tolerance of plus or minus 5 psi), and shall be equipped with a manual pressure control override.
  2. Ratio Tolerance: The injection equipment shall have the capability of maintaining the volume ratio for the adhesive, as prescribed by the manufacturer of the adhesive, within a tolerance of plus or minus 5 percent by volume at any discharge pressure up to 200 psi.
  3. Automatic Shut-Off Control: The injection equipment shall have sensors on both component reservoirs that will automatically stop the machine when only one component is being pumped to the mixing head.
- E. Certificates: Affidavit from the epoxy adhesive manufacturer certifying that each batch of epoxy adhesive material shipped for this Project complies with the requirements of these specifications.
- F. The Contractor shall arrange with the materials manufacturer or distributor to have the services of a competent field representative at the work site prior to any mixing of components to instruct the work crews in the proper mixing and application procedures. The field representative shall remain at the job site after work commences and continue to instruct until the Engineer is satisfied that the crew has mastered the technique of installing the system successfully. The representative shall make periodic visits to the project as the work progresses and shall confer on each visit with the Contractor and the Engineer.
1. The manufacturer's field representative shall be fully qualified to perform the work and shall be subject to the approval by the Engineer.
  2. The Contractor shall be completely responsible for the expense of the services of the required field representative.

## 1.06 DELIVERY AND STORAGE

- A. Deliver materials to the site in original, sealed containers bearing manufacturer's label. Do not deliver materials which have exceeded shelf life limitation set forth by the manufacturer.

- B. Comply with manufacturer's printed instructions for storing materials in original, sealed containers at a temperature between 32 degrees F and 90 degrees F.

## 1.07 PROJECT CONDITIONS

- A. Environmental Requirements: Comply with manufacturer's recommendations for conditions under which materials can be applied.

## PART 2 PRODUCTS

### 2.01 MATERIALS

- A. Epoxy Adhesive: Two component, low viscosity, epoxy resin adhesive system containing 100 percent solids, with no solvents or non-reactive diluents, which meets the following characteristics and properties:
  - 1. Resin: Blend of epoxy resins.
    - ii. Viscosity at 40 + 3 degrees F, cps (Brookfield RVT Spindle No. 4 at 20 rpm): 6,000 - 8,000.
    - iii. Viscosity at 77 + 3 degrees F, cps (Brookfield RVT Spindle No. 2 at 20 rpm): 300 - 700.
    - iv. Epoxide Equivalent Weight (ASTM D 1652): 160 - 220.
    - v. Ash Content, percent (ASTM D 482): 1 maximum.
  - 2. Hardener: Blend of amine curing agents.
    - i. Viscosity at 40 + 3 degrees F, cps (Brookfield RVT Spindle No. 2 at 20 rpm): 700 - 1,400.
    - ii. Viscosity at 77 + 3 degrees F, cps (Brookfield RVT Spindle No. 2 at 20 rpm): 100 - 400.
    - iii. Amine Value, mg KOH/g (ASTM D 664): 490 - 560.
    - iv. Ash Content, percent (ASTM D 482): 1 maximum.
  - 3. Pot Life of the Combined Components: When mixed in the ratio recommended by the manufacturer for use, material shall have pot life as follows:
    - i. 60 g at 77 + 3 degrees F: 13 - 55 minutes.
  - 4. Properties of the Cured Adhesive: When cured for 7 days at 77 + 3 degrees F, material shall have the following properties:
    - i. Ultimate Tensile Strength, psi (ASTM D 638): 5,000 minimum.
    - ii. Tensile Elongation at Break, percent (ASTM D 638): 4 maximum.
    - iii. Flexural Strength, psi (ASTM D 790): 10,000 minimum.
    - iv. Compressive Yield Strength, psi (ASTM D 695): 10,000 minimum.
    - v. Slant Shear Strength, psi (AASHTO T 237, 5,000 psi compressive strength concrete):
  - 5. Cured 3 days at 40 + 3 degrees F, wet/wet concrete: 3,500 minimum.
  - 6. Cured 7 days at 40 + 3 degrees F, wet/wet concrete: 4,000 minimum.
  - 7. Cured 1 day at 77 + 3 degrees F, dry/dry concrete: 5,000 minimum.

- B. Surface Seal: Material with adequate strength and adhesion to hold injection fittings firmly in place and to prevent leakage of epoxy adhesive during injection, and removable without damaging or defacing structure being repaired.
- C. Finishing Patching Materials: As required to match color, texture, and performance of adjoining surfaces as closely as practicable.

## PART 3 EXECUTION

### 3.01 PREPARATION

- A. Clean cracks and adjacent surfaces free of loose material, dust, dirt, grease, oil, efflorescence, and other foreign matter in accordance with epoxy adhesive manufacturer's printed instructions and as required for proper bonding of surface seal. Do not use acids or corrosives.
- B. Establish entry ports along each crack spaced at intervals not less than the thickness of the concrete member being repaired.
- C. Apply surface seal material to the face of each crack between the entry ports as required to prevent escape of injected epoxy adhesive. For cracks all the way through the concrete member, apply surface seal to both faces of cracks where accessible. Allow sufficient time for the surface seal material to gain adequate strength before proceeding with epoxy injection.
- D. If cracks extend into moving joints, plug or seal off the cracks at the joints.

### 3.02 EPOXY INJECTION

- A. Set up and check injection equipment and material in accordance with the manufacturer's instructions and as specified. Do not thin epoxy adhesive.
- B. Beginning at the lowest entry port in the crack, unless otherwise recommended by the installer because of the configuration of the crack, inject epoxy adhesive in the entry port until there is an appearance of adhesive at the next adjacent entry port. When epoxy adhesive travel is indicated at the next adjacent port, discontinue injection in the port, seal off the port, and resume injection in the next adjacent port. Continue this procedure until the crack has been injected full of epoxy adhesive for its entire length in one continuous operation. For horizontal cracks, proceed from one end of the crack to the other end in the same manner. Seal the last port, and allow the adhesive to cure.
- C. If port to port travel of epoxy adhesive does not result after a reasonable amount of pumping, stop injecting adhesive. Report abnormal conditions (if any) immediately to the Engineer and manufacturers field representative..

### 3.03 FINISHING

- A. Remove surface seal and entry port fittings when epoxy adhesive has sufficiently cured to allow removal without disturbing the adhesive.
- B. Fill the face of the crack out flush with the concrete surface plane with patching materials. Eliminate indentations and evidence of port fittings. Finish patches to match texture of adjoining concrete surface as closely as practicable.

### 3.04 FIELD QUALITY CONTROL

- A. Furnish equipment necessary to perform field testing.
- B. Pressure Test: The mixing head of the injection equipment shall be disconnected and the two supply lines shall be attached to a pressure check device. The pressure check device shall consist of two independently valved nozzles capable of controlling flow rate and pressure by opening or closing the valve. There shall be a pressure gauge capable of sensing the pressure build-up behind each valve. The valves on the pressure check device shall be closed and the injection equipment operated until the gauge pressure on each line reads 190 psi. The pumps shall be stopped and the gauge pressure shall not drop below 180 psi within 3 minutes.
- C. Ratio Tests: The mixing head of the injection equipment shall be disconnected and the two adhesive components shall be pumped simultaneously through a ratio check device. The ratio check device shall consist of two independently valved nozzles capable of controlling back pressure by opening or closing the valve. There shall be a pressure gauge capable of sensing the back pressure behind each valve. The discharge pressure shall be adjusted to 180 psi for both adhesive components, and then the components shall be simultaneously discharged into separate calibrated containers. The amounts discharged into the containers during the same time period shall be compared to determine the volumes and the ratio of the components. The test shall be repeated with the discharge pressure adjusted to 0 psi for both adhesive components.
- D. Frequency of Pressure and Ratio Tests: A pressure test and ratio tests shall be performed for each injection equipment unit at the beginning of each shift and after the meal break of each shift that the unit is used.
  - 1. Perform additional tests when directed by the Manufacturer's Representative.
- E. Records of Tests: Record the date and results of all tests, and furnish a copy of the test records to the Engineer.

### 3.05 CLEANING

- A. Remove adhesive runs and spills from existing surfaces by a method which will not deface the surfaces being cleaned.

END OF SECTION



**DIVISION 05**

## SECTION 05120

### STRUCTURAL STEEL FRAMING

#### PART 1 GENERAL

##### 1.01 DESCRIPTION OF WORK

1. Work Included: Provide labor, materials and equipment necessary to complete the work of this Section of the Specifications.
  - a. Structural Steel.
  - b. Architecturally exposed structural steel.
2. Related Work: The following items are not included in this Section and will be performed under the designated Sections:
  - a. Section 05500 – METALS FABRICATION

##### 1.02 DEFINITIONS

Structural Steel: Elements of structural-steel frame, as classified by AISC's "Code of Standard Practice for Steel Buildings and Bridges", that support design loads.

##### 1.03 PERFORMANCE REQUIREMENTS

Connections: Provide details of connections required by the Contract Documents to be selected or completed by the structural-steel fabricator to withstand loads indicated and comply with other information and restrictions indicated.

Select and complete connections using the American Institute of Steel Construction's (AISC) "Manual of Steel Construction, Load and Resistance Factor Design", Volume 2, Part 9.

Engineering Responsibility: Fabricator's responsibilities include using a qualified professional engineer to prepare structural analysis data for structural-steel connections.

##### 1.04 SUBMITTALS

- A. Product Data: For each type of product indicated.
- B. Shop Drawings: Show fabrication of structural-steel components.
  1. Include details of cuts, connections, splices, camber, holes, and other pertinent data.
  2. Include embedment drawings.
  3. Indicate welds by standard AWS symbols, distinguishing between shop and field welds, and show size, length and type of each weld.
  4. Indicate type, size and length of bolts, distinguishing between shop and field bolts. Identify pre-tensioned and slip-critical high-strength bolted connections.

5. For structural-steel connections indicated to comply with design loads, include structural analysis data signed and sealed by the qualified professional engineer responsible for their preparation.
- C. Welding Certificates: Certificate from AWS indicating certification in type of welding required for each welder and welding operator.
- D. Welding Records and Data:
1. Before welding, submit the procedure which will be used for qualifying welders and welding procedures. For procedures other than those pre-qualified in accordance with AWS D1.1, submit a copy of procedure qualification test records.
  2. Submit certified copy of qualification test records for each welder, welding operator, and tacker who will be employed in the work.
  3. If field welding is permitted, submit descriptive data for field welding equipment.
  4. Submit all NDE records (radiographs, ultrasonic, magnetic particle) and visual inspection reports upon completion or when otherwise requested by the Engineer.
- E. Qualification Data: For installer, fabricator, professional engineer, testing agency, welding inspectors, NDE inspectors and galvanizer. Submit prior to starting work.
- F. Mill Test Reports: Signed by manufacturers certifying that the following products comply with requirements:
1. Structural steel including chemical and physical properties.
  2. Bolts, nuts, and washers including mechanical properties and chemical analysis.
  3. Direct-tension indicators.
  4. Tension-control, high-strength bolt-nut-washer assemblies.
  5. Shear stud connectors.
  6. Shop primers.
  7. Nonshrink grout.

#### 1.05 QUALITY ASSURANCE

- A. Fabricator Qualifications: A qualified fabricator who participates in the AISC Quality Certification Program and is certified for: Steel Building Structures (STD).
- B. Galvanizer Qualifications: Engage the services of a qualified galvanizer who has demonstrated a minimum of five years experience in the successful application of galvanized coatings specified in this Section in the facility where the work is to be performed and who will apply the coatings within the same facility.
- C. Installer Qualifications: A qualified installer with previous experience in installing structural steel.
- D. Welding: Qualify procedures and personnel according to AWS D1.1, "Structural Welding Code--Steel".
- E. Comply with applicable provisions of the following specifications and documents:

1. AISC's "Code of Standard Practice for Steel Buildings and Bridges"
2. AISC's "Seismic Provisions for Structural Steel Buildings" and "Supplement No. 2"
3. AISC's "Specification for Structural Steel Buildings--Allowable Stress Design and Plastic Design" and "Load and Resistance Factor Design Specification for Structural Steel Buildings"
4. AISC's "Specification for the Design of Steel Hollow Structural Sections"
5. AISC's "Specification for Allowable Stress Design of Single-Angle Members" and "Specification for Load and Resistance Factor Design of Single-Angle Members"
6. RCSC's "Specification for Structural Joints Using ASTM A 325 or A 490 Bolts"

F. Tests and Inspection

1. The Contractor will test and inspect high-strength bolted connections and welded connections and prepare test reports. Specialty tests shall be performed at no expense to the Owner by an independent testing laboratory approved by the Engineer. Costs of specialty tests shall be borne by the Contractor. Test reports shall be submitted to the Engineer for approval.
2. The Engineer reserves the right to inspect high-strength bolted connections and weld connections. Provide access to places where structural steel work is being fabricated or erected so that required inspection and testing can be accomplished at no change in Contract Price. At times, inspection may require moving or handling of steel to permit proper inspection. Notify Materials Testing Laboratory not less than 48 hours prior to start of fabrication.
3. The Engineer may inspect structural steel at the plant before shipment; however, the Engineer reserves the right, at any time before final acceptance, to reject material not complying with specified requirements.
4. Correct deficiencies in structural steel work that inspections and laboratory test reports have indicated to be not in compliance with requirements at the Contractor's expense. Perform additional tests, at no expense to the Owner, as may be necessary to reconfirm any non-compliance of the original work, and as may be necessary to show compliance of corrected work.
5. Specialty Tests: Nondestructive examination of welds in accordance with provisions of AWS D1.1 and ASTM Standards noted shall be made in accordance with the following schedule:
  - a. Radiographic Examination of Welds, per ASTM E94 and E142:
    - 1) Field, complete joint penetration groove welds:
      - a. 1 out of 5 (20 percent) with thickness equal to or less than 3/4 inch.
      - b. 100 percent with thickness greater than 3/4 inch.
    - 2) Shop, complete joint penetration groove welds:
      - a. 1 out of 10 (10 percent) with thickness equal to or less than 3/4 inch.
      - b. 1 out of 2 (50 percent) with thickness greater than 3/4 inch and equal to or less than 1-1/2 inches.

- c. 100 percent for thickness greater than 1-1/2 inches.
  - b. Ultrasonic Examination, per ASTM E164: Complete joint penetration groove butt welds not accessible for radiographic examination shall be subjected to ultrasonic testing. The extent shall be the same as noted for radiographic examination. Ultrasonic examination shall be made 48 to 72 hours after welding at locations on weldments or welded joints subject to high restraint as indicated in order to check for lamellar tearing. The exact location of the areas to be inspected shall be determined with the Engineer at the time of fabrication. This examination shall be made according to the following schedule unless conditions of tearing require a greater number of tests, as directed:
    - 1) 1 out of 10 (10 percent) for thickness equal to or less than 3/4 inch.
    - 2) 1 out of 5 (20 percent) for thickness greater than 3/4 inch and equal to or less than 1-1/4 inches.
    - 3) 1 out of 2 (50 percent) for thickness greater than 1-1/4 inches.
  - c. Magnetic Particle Examination, per ASTM E709, field and shop:
    - 1) 1 out of 5 (20 percent) of complete joint penetration groove welds of tee and corner joints.
    - 1) 1 out of 10 (10 percent) of partial joint penetration groove and fillet welds.
  - d. Penetrant Examination, per ASTM E165: Shall be used for detecting discontinuities that are open to the surface use as appropriate.
- 6. Visual Examination: All welds whether otherwise examined or not shall be visually examined and faulty joints shall be marked for correction.
  - 7. When any testing, examination or inspection reveals faulty welds, all joints of the same type shall be checked at no expense to the Owner until the integrity of the weld is assured before resuming examination.
  - 8. After faulty welds have been corrected or repaired, they shall each be re-examined at no expense to the Owner in the manner specified for the original joint.
  - 9. It is intended that inspections shall be performed to permit an orderly flow of completed material from the shop. Work with the Engineer to establish a schedule that will permit this.
  - 10. Test result information shall be forwarded to the Engineer immediately after test results are available stating the acceptance or rejection of fabricated pieces in order that the repairs and re-inspection may be made as soon as possible.
- G. Pre-Installation Conference: Contractor shall schedule a meeting to be attended by Contractor, Engineer, fabricator and galvanizer. Agenda shall include the following: Project schedule, source for each fabrication, coordination between fabricator and galvanizer and adjacent Work, finish of surfaces, application of coatings, submittals, and approvals.

#### 1.06 DELIVERY, STORAGE, AND HANDLING

- A. Store materials to permit easy access for inspection and identification. Keep steel members off ground and spaced by using pallets, dunnage, or other supports and spacers. Protect steel members and packaged materials from erosion and deterioration.

1. Store fasteners in a protected place. Clean and re-lubricate bolts and nuts that become dry or rusty before use.
2. Do not store materials on structure in a manner that might cause distortion, damage, or overload to members or supporting structures. Repair or replace damaged materials or structures as directed.

#### 1.07 COORDINATION

- A. Furnish anchorage items to be embedded in or attached to other construction without delaying the Work. Provide setting diagrams, sheet metal templates, instructions and directions for installation.

### PART 2 – PRODUCTS

#### 2.01 STRUCTURAL-STEEL MATERIALS

- A. S-Shapes, W-Shapes: ASTM A 992, Grade 50.
- B. Channels, Angles, Plates and Bar: ASTM A 36.
- C. Cold-Formed Hollow Structural Sections: ASTM A 500, Grade B, structural tubing.
- D. Steel Pipe: ASTM A 53, Type E or S, Grade B.
- E. Medium-Strength Steel Castings: ASTM A 27, Grade 65-35 carbon steel.
- F. High-Strength Steel Castings: ASTM A 148, Grade 80-50, carbon or alloy steel.
- G. Welding Electrodes: Comply with AWS requirements.

#### 2.02 BOLTS, CONNECTORS, AND ANCHORS

- A. High-Strength Bolts, Nuts, and Washers: ASTM A 325, Type 1, heavy hex steel structural bolts; ASTM A 563 heavy hex carbon-steel nuts; and ASTM F 436 hardened carbon-steel washers.
  1. Finish: Hot-dip zinc coating, ASTM A 153, Class C.
- B. Tension-Control, High-Strength Bolt-Nut-Washer Assemblies: ASTM F 1852, Type 1, steel structural bolts with splined ends; ASTM A 563 heavy hex carbon-steel nuts; and ASTM F 436 hardened carbon-steel washers. Finish, mechanically deposited zinc coating, ASTM B 695, Class 50.
- C. Shear Connectors: ASTM A 108, Grades 1015 through 1020, headed-stud type, cold-finished carbon steel; AWS D1.1, Type B.
- D. Anchor Rods: ASTM F 1554, grade as applicable, hot-dip zinc coating, ASTM A 153, Class C.
- E. Threaded Rods: ASTM A 193, grade as applicable, hot-dip zinc coating, ASTM A 153, Class C.
- F. Eye Bolts and Nuts: ASTM A 108, Grade 1030, cold-finished carbon steel.

G. Sleeve Nuts: ASTM A 108, Grade 1018, cold-finished carbon steel.

## 2.03 MISCELLANEOUS MATERIALS

A. Galvanizing Repair Paint: Coatings meeting requirements of ASTM A 780.

B. Nonmetallic, Shrinkage-Resistant Grout: ASTM C 1107, factory-packaged, nonmetallic aggregate grout, noncorrosive, nonstaining, mixed with water to consistency suitable for application and a 30-minute working time.

## 2.04 FABRICATION

A. Structural Steel: Fabricate and assemble in shop to greatest extent possible. Fabricate according to AISC's "Code of Standard Practice for Steel Buildings and Bridges" and AISC's "Specification for Structural Steel Buildings--Allowable Stress Design and Plastic Design".

1. Camber structural-steel members where indicated.
2. Identify high-strength structural steel according to ASTM A 6/ A 6M and maintain markings until structural steel has been erected.
3. Mark and match-mark materials for field assembly.
4. Complete structural-steel assemblies, including welding of units, before starting shop-priming operations.

B. Architecturally Exposed Structural Steel: Comply with fabrication requirements, including tolerance limits, of AISC's "Code of Standard Practice for Steel Buildings and Bridges" for structural steel identified as architecturally exposed structural steel.

1. Fabricate with exposed surfaces smooth, square, and free of surface blemishes including pitting, rust, scale, seam marks, roller marks, rolled trade names, and roughness.
2. Remove blemishes by filling or grinding or by welding and grinding, before cleaning, treating, and shop priming.

C. Thermal Cutting: Perform thermal cutting by machine to greatest extent possible. Plane thermally cut edges to be welded to comply with requirements in AWS D1.1.

D. Bolt Holes: Cut, drill, or punch standard bolt holes perpendicular to metal surfaces.

E. Finishing: Accurately finish ends of columns and other members transmitting bearing loads.

F. Shear Connectors: Prepare steel surfaces as recommended by manufacturer of shear connectors. Use automatic end welding of headed-stud shear connectors according to AWS D1.1 and manufacturer's written instructions.

G. Steel Wall-Opening Framing: Select true and straight members for fabricating steel wall-opening framing to be attached to structural steel. Straighten as required to provide uniform, square, and true members in completed wall framing.

- H. Welded Door Frames: Build up welded door frames attached to structural steel. Weld exposed joints continuously and grind smooth. Plug-weld fixed steel bar stops to frames. Secure removable stops to frames with countersunk, cross-recessed head machine screws, uniformly spaced not more than 10 inches o.c., unless otherwise indicated.
- I. Holes: Provide holes required for securing other work to structural steel and for passage of other work through steel framing members.
  - 1. Cut, drill, or punch holes perpendicular to steel surfaces. Do not thermally cut bolt holes or enlarge holes by burning.
  - 2. Base-Plate Holes: Cut, drill, mechanically thermal cut, or punch holes perpendicular to steel surfaces.
  - 3. Weld threaded nuts to framing and other specialty items indicated to receive other work.

## 2.05 SHOP CONNECTIONS

- A. High-Strength Bolts: Shop install high-strength bolts according to RCSC's "Specification for Structural Joints Using ASTM A 325 or A 490 Bolts" for type of bolt and type of joint specified.
- B. Weld Connections: Comply with AWS D1.1 for welding procedure specifications, tolerances, appearance, and quality of welds and for methods used in correcting welding work. Complete welds in accordance with the Contract Drawings.
  - 1. Remove backing bars or runoff tabs, back gouge, and grind steel smooth.
  - 2. Assemble and weld built-up sections by methods that will maintain true alignment of axes without exceeding tolerances of AISC's "Code of Standard Practice for Steel Buildings and Bridges" for mill material.
  - 3. Insufficient welds shall be rejected and corrected until required profiles are met.
  - 4. Verify that weld sizes, fabrication sequence, and equipment used for architecturally exposed structural steel will limit distortions to allowable tolerances. Prevent weld show-through on exposed steel surfaces.
    - a. Grind butt welds flush.
    - b. Grind or fill exposed fillet welds to smooth profile. Dress exposed welds.
  - 5. No skip welds will be permitted for steel connections to be coated.

## 2.06 STEEL PRIMERS AND FINISHES

- A. Preparation for Shop Priming: Prepare uncoated ferrous-metal surfaces to comply with minimum requirements indicated below for The Society for Protective Coatings (SSPC) surface preparation specifications and environmental exposure conditions of installed metal fabrications:
  - 1. Exteriors (SSPC Zone 1B) and Items Indicated to Receive Zinc-Rich Primer: SSPC-SP 10/NACE No. 2, "Near White Metal Blast Cleaning"
  - 2. Interiors (SSPC Zone 1A): SSPC-SP 6, "Commercial Blast Cleaning"



3. Apply shop primer to uncoated surfaces of metal fabrications, except those with galvanized finishes and those to be field welded, embedded in concrete or masonry, unless otherwise indicated. Extend priming of partially embedded members to a depth of 2 inches.
  4. Comply with SSPC-PA 1, "Paint Application Specification No. 1: Shop, Field, and Maintenance Painting of Steel" for shop painting.
  5. Comply with SSPC-PA 2, "Measurement of Dry Coating Thickness with magnetic Gages"
- B. Zinc-Rich Primer: Urethane zinc rich primer compatible with topcoat Specified in Section 09900. Provide primer with a VOC content of 340 g/L (2.8 lb/gal.) or less per OTC ozone standards. Provide Tnemec Series 394 or Ameron 5105 or equal by DuPont or Carboline for exposed steel to be fireproofed, or Tnemec Series 901K97 Series or 90-97 or Ameron 68HS or equal by DuPont or Carboline for exposed steel to be finish painted at 3.0 mils DFT.
- C. Primer for Exposed Steel to Receive Multi-Coat Shop-Applied Coating: Tnemec Series 901K97 or 90-97 urethane zinc rich primer at 3.0 to 3.5 mils DFT, topcoated in shop with Tnemec Series V73 Endura-Shield, or use Ameron Series 68HS Primer at 3.0 to 5.0 mils DFT topcoated in shop with Ameron's Amercoat 450H, or use or equal primers and finish coats from DuPont or Carboline.
- D. Galvanizing: For steel exposed to the elements, weather or corrosive environments and other steel indicated to be galvanized, provide coating for iron and steel fabrications applied by the hot-dip process. Comply with ASTM A 123 for fabricated products and ASTM A 153 for hardware. Provide thickness of galvanizing specified in referenced standards. The galvanizing bath shall contain high grade zinc and other earthly materials. Fill vent holes and grind smooth after galvanizing.
- E. Hot-Dip Galvanizing And Factory-Applied Primer for Steel: Provide hot-dip galvanizing and factory-applied prime coat, certified OTC/VOC compliant less than 2.8 lbs/gal. and conforming to EPA and Commonwealth of Massachusetts requirements. Apply primer within 12 hours after galvanizing at the galvanizer's plant in a controlled environment meeting applicable environmental regulations and as recommended by the primer coating manufacturer. Blast cleaning of the surface is unacceptable for surface preparation. Primer shall have a minimum two year re-coat window for application of finish coat. Coatings must meet or exceed the following performance criteria:
1. Abrasion: ASTM D 4060, CS17 Wheel, 1,000 gram load.
  2. Adhesion: ASTM D 3359, Method B, 5 mm crosshatch.
  3. Humidity Resistance: ASTM D 4585.
  4. Salt Spray (Fog): ASTM B 117.

## PART 3 - EXECUTION

### 3.01 EXAMINATION

- A. Verify elevations of concrete- and masonry-bearing surfaces and locations of anchor rods, bearing plates, and other embedments, with steel erector present, for compliance with requirements. Elevations shall be verified by a surveyor licensed in the Commonwealth of Massachusetts.
- B. Proceed with installation only after unsatisfactory conditions have been corrected.

### 3.02 PREPARATION

- A. Provide temporary shores, guys, braces, and other supports during erection to keep structural steel secure, plumb, and in alignment against temporary construction loads and loads equal in intensity to design loads. Remove temporary supports when permanent structural steel, connections, and bracing are in place, unless otherwise indicated. Do not remove temporary shoring supporting composite deck construction until cast-in-place concrete has attained its design compressive strength.

### 3.03 ERECTION

- A. Set structural steel accurately in locations and to elevations indicated and according to AISC's "Code of Standard Practice for Steel Buildings and Bridges".
- B. Base and Bearing Plates: Clean concrete- and masonry-bearing surfaces of bond-reducing materials, and roughen surfaces prior to setting base and bearing plates. Clean bottom surface of base and bearing plates.
  - 1. Set base and bearing plates for structural members on wedges, shims, or setting nuts as required.
  - 2. Weld plate washers to top of base plate.
  - 3. Snug-tighten or pretension anchor rods as applicable after supported members have been positioned and plumbed. Do not remove wedges or shims but, if protruding, cut off flush with edge of base or bearing plate before packing with grout.
  - 4. Promptly pack grout solidly between bearing surfaces and base or bearing plates so no voids remain. Neatly finish exposed surfaces; protect grout and allow to cure. Comply with manufacturer's written installation instructions for shrinkage-resistant grouts.
- C. Maintain erection tolerances of structural steel and architecturally exposed structural steel within AISC's "Code of Standard Practice for Steel Buildings and Bridges".
- D. Align and adjust various members forming part of complete frame or structure before permanently fastening. Before assembly, clean bearing surfaces and other surfaces that will be in permanent contact with members. Perform necessary adjustments to compensate for discrepancies in elevations and alignment.
  - 1. Level and plumb individual members of structure.
  - 2. Make allowances for difference between temperature at time of erection and mean temperature when structure is completed and in service.
- E. Splice members only where indicated.
- F. Remove erection bolts on welded, architecturally exposed structural steel; fill holes with plug welds; and grind smooth at exposed surfaces.
- G. Do not use thermal cutting during erection unless approved by Engineer. Finish thermally cut sections within smoothness limits in AWS D1.1.

- H. Do not enlarge unfair holes in members by burning or using drift pins. Ream holes that must be enlarged to admit bolts.
- I. Shear Connectors: Prepare steel surfaces as recommended by manufacturer of shear connectors. Use automatic end welding of headed-stud shear connectors according to AWS D1.1 and manufacturer's written instructions.

### 3.04 FIELD CONNECTIONS

- A. High-Strength Bolts: Install high-strength bolts according to RCSC's "Specification for Structural Joints Using ASTM A 325 or A 490 Bolts" for type of bolt and type of joint indicated on the Drawings.
- B. Weld Connections: Comply with AWS D1.1 for welding procedure specifications, tolerances, appearance, and quality of welds and for methods used in correcting welding work.
  - 1. Comply with AISC's "Code of Standard Practice for Steel Buildings and Bridges" for bearing, adequacy of temporary connections, alignment, and removal of paint on surfaces adjacent to field welds.
  - 2. Remove backing bars or runoff tabs, back gouge, and grind steel smooth.
  - 3. Assemble and weld built-up sections by methods that will maintain true alignment of axes without exceeding tolerances of AISC's "Code of Standard Practice for Steel Buildings and Bridges" for mill material.
  - 4. Verify that weld sizes, fabrication sequence, and equipment used for architecturally exposed structural steel will limit distortions to allowable tolerances. Prevent weld show-through on exposed steel surfaces.
    - a. Grind butt welds flush.
    - b. Grind or fill exposed fillet welds to smooth profile. Dress exposed welds.
    - c. Re-profile all steel surfaces (using needle guns or other profiling methods) that have been welded and ground smooth to assure proper adhesion of primers and topcoats.

### 3.05 FIELD QUALITY CONTROL

- A. Testing Agency: Engage a qualified independent testing and inspecting agency to inspect field welds and high-strength bolted connections.
- B. Bolted Connections: Bolted connections will be inspected according to RCSC's "Specification for Structural Joints Using ASTM A 325 or A 490 Bolts". When using bolted connections prime with "slip critical class B" primer as specified in this Section. All surfaces of bolted or bearing connections may be primed. When welding, hold back primer a minimum of 2 inches each side of weld.
- C. Welded Connections: Field welds will be visually inspected according to AWS D1.1. In addition to visual inspection, specialty tests will be performed in accordance with AWS D1.1 and at the frequency stated in Article 1.5.F.5
- D. In addition to visual inspection, test and inspect field-welded shear connectors according to requirements in AWS D1.1 for stud welding and as follows:

1. Perform bend tests if visual inspections reveal either a less-than- continuous 360-degree flash or welding repairs to any shear connector.
  2. Conduct tests on additional shear connectors if weld fracture occurs on shear connectors already tested, according to requirements in AWS D1.1.
- E. Correct deficiencies in Work that test reports and inspections indicate do not comply with the Contract Documents.

### 3.06 REPAIRS AND PROTECTION

- A. Repair damaged galvanized coatings on galvanized items with galvanized repair paint according to ASTM A 780 and manufacturer's written instructions.
- B. Touchup Painting: After installation, promptly clean, prepare, and prime or reprime field connections, rust spots, and abraded surfaces of prime-painted joists and accessories, bearing plates, and abutting structural steel.
  1. Clean and prepare surfaces by SSPC-SP 3 power-tool cleaning.
  2. Apply a compatible primer of same type as shop primer used on adjacent surfaces.

END OF SECTION

SECTION 05500

METAL FABRICATIONS

PART 1 GENERAL

1.01 SECTION INCLUDES

A. This Section includes the following items:

1. Aluminum covers
2. Aluminum extrusions.
3. Aluminum grating.
4. Aluminum framing and supports for covers and grating.
5. Aluminum stop gates.
6. Stainless steel angle, for weirs.
7. Stainless steel fasteners for framing connections.
8. Pipe bollards

**B. Certain items in this specification section are subject to the American Iron and Steel requirements of P.L. 113-76, the Consolidated Appropriations Act of 2014.**

1.02 RELATED SECTIONS

- A. SECTION 05510 – ALUMINUM STAIRS AND LADDERS
- B. SECTION 05520 – ALUMINUM HANDRAILS AND RAILINGS
- C. SECTION 11282 – STAINLESS STEEL SLIDE GATES
- D. SECTION 13120 – PRE-ENGINEERED METAL BUILDING

1.03 SUBMITTALS

A. All submittals shall be made in accordance with the provisions of SECTION 01300 SUBMITTALS.

**B. Certification of compliance with the American Iron and Steel requirements of P.L. 113-76, the Consolidated Appropriations Act of 2014, is required with all submittals.**

C. Product Data: Submit manufacturer's technical data sheets for the following:  
Delete items below for which Product Data is not required.

1. Paint products, including bitumastic coating.
2. Grout.

- D. Shop Drawings: The fabrication and erection of each metal fabrication indicated shall be detailed. Plans, elevations, sections, and details of metal fabrications and their connections shall be included. Anchorage and accessory items shall be shown. The shop drawings shall furnish the required information in sufficient detail and completeness that the work may be accomplished without the use of the Contract Drawings as a reference.
- E. Welding Certificates: Copies of certificates for welding procedures and personnel.
- F. Qualification Data: Firms and persons specified in the "Quality Assurance" Article shall demonstrate their capabilities and experience. Firms shall include a list of at least three (3) recently completed projects with project names and addresses. The name, address, and phone number of a contact (architect, engineer, or owner) shall be provided for each project in the list, as well as any other required information hereinafter or hereinbefore specified.

#### 1.04 QUALITY ASSURANCE

- A. Fabricator Qualifications: The firm shall be experienced in the production of metal fabrications similar to those indicated for this Project, with a record of successful in-service performance, and shall have sufficient production capacity to produce the work required and complete the work within the duration of the contract.
- B. Welding: Procedures and personnel shall be qualified according to the latest revisions of the following:
  - 1. AWS D1.1, "Structural Welding Code—Steel."
  - 2. AWS D1.2 "Structural Welding Code—Aluminum."
  - 3. AWS D1.6 "Structural Welding Code—Stainless Steel."
  - 4. Certification shall be provided stating that each welder has passed the AWS qualification tests for the welding processes involved and has maintained that certification as required by AWS.

#### 1.05 PROJECT CONDITIONS

- A. Field Measurements: Where metal fabrications are indicated to fit within reinforced concrete walls and other construction, dimensions shall be verified by field measurements before fabrication. The fabrication schedule shall be coordinated with the construction progress to avoid delaying the Work.
  - 1. Established Dimensions: Where field measurements cannot be made without delaying the Work, proceed with fabricating metal fabrications upon receipt of Engineer reviewed and approved shop drawings, without field measurements. Consideration shall be made for extra material which will be required for trimming and fitting.

## 1.06 COORDINATION

- A. Installation of anchorages for metal fabrications shall be coordinated with the Contractor. Setting drawings, templates, and instructions for installing anchorages, including sleeves, concrete inserts, anchor bolts, items with integral anchors, and any items that are to be embedded in concrete shall be provided to the Contractor. Items to be embedded in concrete shall be delivered to Project site sufficiently in advance to allow time for installation, as determined by the Contractor.

## PART 2 PRODUCTS

### 2.01 MANUFACTURERS

- A. Mill City Steel Corp., Westport, MA
- B. Acceptable alternate.

### 2.02 METALS, GENERAL

- A. Metal Surfaces, General: For metal fabrications exposed to view in the completed Work, materials shall be provided with smooth, flat surfaces without blemishes. Materials with exposed pitting, seam marks, roller marks, rolled trade names, or roughness shall not be used.

### 2.03 FERROUS METALS

- A. Structural Stainless Steel Plates, Shapes, and Bars: Shall conform to ASTM A 276, type 316.
- B. Welding Rods and Bare Electrodes: Shall be compatible with the material to be welded per the AWS D1.6 specifications.

### 2.04 ALUMINUM ALLOYS

- A. Structural Aluminum Shapes: Shall conform to ASTM B 308, 6061-T6, with a mill finish and shall be shipped in accordance with ASTM B 660, complying with the commercial packing and preservation requirements.
- B. Aluminum Extrusions: Shall conform to ASTM B 221, 6061-T6, with a mill finish and shall be shipped in accordance with ASTM B 660, complying with the commercial packing and preservation requirements.
- C. Structural Aluminum Plates: Shall conform to ASTM B 209, 6061-T6, with a mill finish and shall be shipped in accordance with ASTM B 660, complying with the commercial packing and preservation requirements.

- D. Aluminum Tread Plate: Shall conform to ASTM B 632, 6061-T6, a clear, Class II, anodized finish per Aluminum Association Designation AA-A31, 0.4 mils thick minimum, and shall be shipped in accordance with ASTM B 660, complying with the commercial packing and preservation requirements.
- E. Structural Aluminum Tubes: Shall conform to ASTM B 429, 6063-T52, with a mill finish and shall be shipped in accordance with ASTM B 660, complying with the commercial packing and preservation requirements.
- F. Welding Rods and Bare Electrodes: Shall be compatible with the material to be welded per the AWS D1.2 specifications. Aluminum items to be anodized shall not be welded using 4043 weld rod.

#### 2.05 PAINT

- A. Bitumastic Coating/Paint: Shall be a paint-on epoxy type suitable for embedment in, or surface mounting to, concrete to prevent adverse reaction between aluminum and concrete surfaces. Acceptable products are TC Wet Bond Flexible Epoxy Mastic as manufactured by Tapecoat of Evanston, IL, and Bitumastic 300M as manufactured by Carbolite of St. Louis, MO, or engineer approved equivalent.

#### 2.06 GROUT

- A. Grout: Shall be provided per Section 03600 – GROUT.

#### 2.07 FASTENERS

- A. Bolts: Stainless steel fasteners conforming to ASTM F 593, Alloy Group 2, Type 316, CW with hexagonal heads shall be provided for connections.
- B. Nuts: Stainless steel nuts conforming to ASTM F 594, Alloy Group 2, Type 316, CW with hexagonal heads, and thread designation to match stainless steel bolts shall be provided for connections.
- C. Washers: Stainless steel washers shall conform to ASTM F 436, Circular except that the material shall be Type 316 stainless steel conforming with ASTM A 276.
- D. Machine Screws: Stainless steel machine screws shall conform to ASME B18.6.3, and shall be Type 316 stainless steel.

#### 2.08 ALUMINUM COVERS

- A. Shall be composed of aluminum tread plate, 1/4" thickness as specified on the Drawings.



## 2.09 ALUMINUM EXTRUSIONS

- A. Shall perform the basic function as indicated on the Drawings. All surfaces embedded in concrete shall be bitumastic coated.

## 2.10 ALUMINUM GRATING

- A. Shall be aluminum, swage locked, rectangular bar grating conforming to ASTM B221, 6063-T6 with a clear, Class II, anodized finish per Aluminum Association Designation AA-A31, 0.4 mils thick minimum. Grating layout shall be as indicated on the Drawings. Bearing Bars shall be of the depth noted on the drawings and shall be spaced at 1-3/16" on center. Cross bars shall be spaced at 4" on center. Individual grating panels shall be banded around their edges and clipped to framing members with the grating manufacturer's standard fastening devices. A serrated surface shall be provided where indicated on the Drawings.
- B. Grating shall be 19-SG-4 as manufactured by Ohio Gratings, Inc. of Canton, OH, Type BS as manufactured by IKG Borden of Paramus, NJ, or Engineer approved equal.

## 2.11 ALUMINUM FRAMING AND SUPPORTS FOR COVERS AND GRATING

- A. Shall be fabricated from structural aluminum shapes, structural aluminum tubes, and aluminum extrusions, of the size and quantity as indicated on the Drawings.

## 2.12 STAINLESS STEEL FASTENERS FOR FRAMING CONNECTIONS

- A. Shall be fabricated from bolts, nuts, and washers of the size and quantity as indicated on the Drawings. One nut shall be provided per each bolt unless otherwise indicated on the Drawings. A washer shall be provided at the contact surface between framing members or clips and the heads of bolts and nuts, minimum two (2) washers per bolt.
- B. Stainless Steel fasteners shall conform to the requirements of the American Iron and Steel Act.

## 2.13 PIPE BOLLARDS

- A. Pipe bollards shall be fabricated from Schedule 40, welded, galvanized steel pipe in accordance with the provisions of ASTM A53 of the size and quantity indicated on the Drawings.

## 2.14 FINISHES, GENERAL

- A. Aluminum finishes are specified in this section per the Aluminum Association's Designation system for aluminum finishes. Finishes shall conform to the

Specification for Anodized Architectural Aluminum (611-98), as published by the American Architectural Manufacturer's Association.

- B. Fabrications shall be finished after shop assembly.
- C. Anodized finishes damaged in the field during installation or transit shall be repaired using brush anodizing to restore the coating to its specified Class and thickness.

## PART 3 EXECUTION

### 3.01 FABRICATION, GENERAL

- A. Shop Assembly: Items shall be preassembled in shop to greatest extent possible to minimize field splicing and assembly. Units shall be disassembled only as necessary for shipping and handling limitations. Connections shall maintain the structural value of joined pieces through the use of properly sized holes, proper spacing and gage distances, tolerances, and other requirements as determined in the applicable codes listed elsewhere in this specification. Units shall be clearly marked for reassembly and coordinated installation.
- B. Metals shall be sheared and punched cleanly and accurately. Burrs shall be removed.
- C. Exposed edges shall be rounded to a radius of approximately 1/32 inch, unless otherwise indicated. Bent-metal corners shall be formed to the smallest radius possible without causing grain separation or otherwise impairing the work.
- D. Corners and seams shall be welded continuously to comply with the following:
  - 1. Materials and methods shall be used that minimize distortion and develop strength and corrosion resistance of the base metals.
  - 2. Fusion shall be obtained without undercut or overlap.
  - 3. Welding flux shall be removed immediately.
  - 4. At exposed connections, exposed welds and surfaces shall be finished smooth and blended so that no roughness is apparent and the contour of the welded surface matches that of the adjacent surface.
- E. Anchorage of the type indicated in the Contract Documents shall be provided for and coordinated with supporting structure. Anchoring devices shall be fabricated and spaced to secure metal fabrications in place and to support indicated loads.
- F. Metal fabrications shall be cut, reinforced, drilled, and tapped cleanly and accurately to receive finish hardware, screws, and similar items.

- G. Joints that will be exposed to weather shall be fabricated in a manner to exclude water. Drain holes shall be provided where water may accumulate.
- H. Exposed work shall be formed true to line and level, with accurate angles and surfaces, and straight rounded edges.
- I. Sharp or rough areas shall be removed on exposed traffic surfaces.
- J. Exposed connections shall be formed with hairline joints, flush and smooth, using concealed fasteners where possible. Exposed fasteners of type indicated on the Drawings shall be used; when not indicated, Phillips flat-head (countersunk) screws or bolts shall be used. Joints shall be located where least conspicuous.

### 3.02 INSTALLATION, GENERAL

- A. Fastening to In-Place Construction: Anchorage devices and fasteners shall be provided where necessary for securing metal fabrications to in-place construction. Refer to SECTION 03300 – CAST-IN-PLACE CONCRETE for information on approved anchorage devices.
- B. Cutting, Fitting, and Placement: Cutting, drilling, and fitting for the installation of metal fabrications shall be performed as required. Metal fabrications shall be set accurately in location, alignment, and elevation; with edges and surfaces level, plumb, true, and free of rack; and measured from established lines and levels.
- C. Temporary bracing or anchors shall be provided in formwork for items that are to be built into concrete.
- D. Exposed connections shall fit together to form hairline joints. Welded connections that can not be made in the shop due to shipping limitations shall be made in the field. Do not weld, cut, or abrade surfaces of exterior units that have been anodized after fabrication and are for bolted or screwed field connections.
- E. Field Welding: Comply with the following requirements:
  - 1. Materials and methods shall be used that minimize distortion and develop strength and corrosion resistance of base metals.
  - 2. Fusion shall be obtained without undercut or overlap.
  - 3. Welding flux shall be removed immediately.
  - 4. At exposed connections, welds and surfaces shall be finished smooth and blended so that no roughness shows after finishing and the contour of the welded surface matches that of adjacent surface.

### 3.03 SETTING BEARING AND LEVELING PLATES

- A. Concrete bearing surfaces shall be cleaned of bond-reducing materials, and roughened to improve bond to surfaces. The bottom surface of plates shall be cleaned.
- B. Bearing and leveling plates shall be set on wedges, shims, or leveling nuts. After bearing members have been positioned and plumbed, anchor bolts shall be tightened. Wedges and shims shall not be removed but, if protruding, shall be cut off flush with the edge of bearing plate before packing with grout.
  - 1. Provide grout per the requirements of SECTION 03600 – GROUT.
  - 2. Grout shall be solidly packed between bearing surfaces and plates to ensure that no voids remain.

### 3.04 INSTALLING PIPE BOLLARDS

- A. Bollards shall be anchored in place with concrete footings as detailed in the Contract Drawings. Bollards shall be supported and braced in position until their footings are cured.
- B. Fill bollards solidly with 3,000 psi concrete, mounding the top surface.
- C. Paint bollards Safety Yellow in accordance with:
  - 1. Exterior Steel - Non-Immersion
    - a. Shop Surface Preparation: SSPC SP6 Commercial Blast Cleaning
    - b. Shop Primer Coat: Series 91-K97 Organic Zinc
      - 1) Dry Film Thickness: 2.5 to 3.5 mils
    - c. Full Field Prime Coat: Series 66-color Hi-Build Epoxoline
      - 1) Dry Film Thickness: 3.0 to 5.0 mils
    - d. Finish Coat: Series 73-color Endura-Shield
      - 1) Dry Film Thickness: 2.5 to 5.0 mils
    - e. Total Dry Film Thickness: 8.0 to 13.5 mils.

### 3.05 ADJUSTING AND CLEANING

- A. Touchup Painting: Cleaning and touchup painting of field welds, bolted connections, and abraded areas of shop paint are specified in Division 9 Section "Painting."
- B. Anodized Surfaces: Clean field welds, bolted connections, and abraded areas and repair anodizing to match the quality of the coating provided by the shop.

END OF SECTION 05500

SECTION 05510

ALUMINUM STAIRS AND LADDERS

PART 1 GENERAL

1.01 SECTION INCLUDES

A. Section Includes

1. Requirements for the fabrication and installation of aluminum stair and ladder systems.

B. Related Sections

1. Section 05500 – Metal Fabrications
2. Section 05520 - Aluminum Handrails and Railings.
3. Section 05530 – Metal Grating

1.02 SYSTEM DESCRIPTION

A. Design Requirements

1. Comply with the provisions of the following codes, standards, and specifications, except as otherwise shown or specified.

a. The Aluminum Association Designations:

Structural rolled or extruded shapes	6061-T6
Extruded shapes	6063-T5
Plates	6061-T6
Gratings (bearing bars)	6061-T6
(crimp bars)	6063-T6
Sheets	Alcad 3003-H14 and 3003
Bolts and nuts	2024-T4

B. Performance Requirements

1. Stairs are to be fabricated to support a live load of 100 lbs. /sq. ft. and a moving concentrated load of not less than 300 lbs.

1.03 SUBMITTALS

A. In accordance with Section 01300 submit the following:

1. Complete shop drawings and design computations, stamped by a Professional Engineer registered in the State of Massachusetts who is experienced in this type of work. All computations shall be in conformance with the Specifications for Aluminum Structures, (SAS) 30, by the American Aluminum Association. This submission will be reviewed by the Engineer but design responsibility remains with the Contractor and the Contractor's Engineer and under no circumstances, does the Engineer assume responsibility for the means, methods, sequences, procedures or techniques in connection with the performance of any of the work of the Contractor.
2. Submit copies of manufacturer's specifications, load tables, dimension diagrams, anchorage, anchor, details and installation instructions for products to be used in the fabrication of aluminum stair work, include coating products. Transmit copy of instructions to the installer.
3. Shop drawings for the fabrication and erection of aluminum stair assemblies and ladders. Include plans and elevations at not less than 1" to 1'-0" scale, and include details of

sections and connections at not less than 3" to 1'-0" scale. Show anchorage and accessory items.

4. Mill certificates and a signed statement from the fabricator that all aluminum work furnished is of the proper alloys as specified herein.

#### 1.04 SEQUENCING

##### A. Inserts and Anchorages:

1. Furnish inserts and anchoring devices which must be set in concrete or built into masonry for the installation of the stairs, handrails, and railings work.
2. Provide setting drawings, templates, instructions and directions for installation of anchorage devices.
3. Coordinate delivery with other work to avoid delay.

### PART 2 PRODUCTS

#### 2.01 STAIR SYSTEMS

##### A. Aluminum stairs

1. Provide structural aluminum channel stringers and supports, aluminum tread plate treads and platforms, sheet aluminum risers, grating treads and platforms.

##### B. Plate treads

1. Formed from ¼ inch thick aluminum tread plate and the risers shall be formed from 0.080-inch thick sheet aluminum.
2. Treads shall be supported by and attached to 1-1/4 inch by 1-1/4 inch by 3/16 inch aluminum carrier angles bolted to the stringers.
3. Risers shall be bolted to the treads.

##### C. Plate platforms

1. Fabricated of ¼ inch thick aluminum tread plate and shall be supported on the edges by structural aluminum angles and at the mid spans by structural aluminum tees.

##### D. Aluminum tread plate for treads and platforms shall have an acceptable nonskid pattern surface.

##### E. Provide all structural aluminum angle hangers, struts, rod hangers, closure plates, and brackets indicated or necessary to complete the stairs.

##### F. Grating stair treads

1. In accordance with SECTION 05530 and the following:
2. Welded aluminum safety treads with 1-1/4 inch abrasive or extruded aluminum corrugated nosings, minimum 48" wide.
3. Punched and slotted integral carrier plates for attaching to the channel stringers.

##### G. Grating platforms

1. In accordance with SECTION 05530 and the following:
2. Constructed of the specified aluminum grating and shall have the same nosings as the treads.
3. Supported at the ends on structural aluminum angles and at the mid spans by structural aluminum tees.

## 2.02 LADDERS

- A. Constructed of pipe uprights with solid round rod rungs mortised and welded to the uprights. Securely anchor to the wall with angles or bent plates, welded to the uprights and expansion bolted to the wall. All welds shall be ground smooth.
- B. Interior ladders shall be secured to the floor slabs with floor flanges.
- C. The uprights of ladders to roofs or platforms shall widen at the top, extend above the roof or platform level, and shall be turned back to form guard rails.
- D. Construct from 1-1/2 inch IPS, Schedule 40 aluminum pipe uprights and 1 inch solid round aluminum rod rungs unless otherwise indicated on the drawings. After fabrication, the aluminum ladders shall be given an Aluminum Association Standard Finish, Designation M12C22A31 followed by a shop coat of methacrylate lacquer.

## 2.03 HANDRAILS

- A. In accordance with Specification SECTION 05520.

## 2.04 SHIP LADDER

- A. Constructed of aluminum channel stringers, aluminum pipe handrails and aluminum riveted grating treads. The treads to be Type K manufactured by Borden Metal products Co., Elizabeth, NJ; Reticuline Type M manufactured by IKG Industries, Long Island City, NY; Type KM manufactured by Kerrigan Iron Works, Inc., Nashville, TN; or acceptable equivalent product.
- B. Bearing bars of treads to be 3/16 inch thick by 1-1/4 inch deep and be fabricated of 6061-T6 aluminum alloy.
- C. Crimp bars to be fabricated of 6063-T5 aluminum alloy, riveted on 7 inch centers, and raised slightly above the bearing bars and serrated.
- D. Treads to be provided with integral slotted and punched end plates for attaching to stringers. Treads to be provided with 1-1/4 inch abrasive or extruded aluminum corrugated nosings.
- E. Provide structural aluminum clip angles, brackets and fasteners to complete the ship ladders.

## 2.05 FASTENERS

- A. Stainless steel in accordance with SECTION 05500.

## 2.06 FABRICATION

- A. Shop Assembly
  - 1. Use materials of the required size and thickness to produce adequate strength and durability in the finished product for the intended use. Work to conform to the dimensions accepted on shop drawings, using proven details of fabrication and support.
  - 2. Form exposed work true to line and level with accurate angles and surfaces and straight sharp edges. Ease exposed edges to a radius of approximately 1/32 of an inch. Form bent metal corners to the smallest radius possible without causing grain separation or otherwise impairing the work.
  - 3. Weld corners and seams continuously in accordance with the recommendations of the American Welding Society. Grind exposed welds smooth and flush, to match and blend with adjoining surfaces.
  - 4. Form exposed connections with hairline joints which are flush and smooth, using concealed fasteners wherever possible.

5. Provide for anchorage coordinated with the supporting structure. Fabricate and space anchoring devices as required to provide adequate support for the intended use of the work.
6. Pre-assemble items in the shop to the greatest extent possible, so as to minimize field splicing and assembly of units at the project site. Disassemble units only to the extent necessary for shipping and handling limitations. Clearly mark units for reassembly and coordinated installation.

## PART 3 EXECUTION

### 3.01 INSTALLATION

#### A. Anchorages

1. Furnish setting drawings, diagrams, templates instructions and directions for the installation of anchorages, such as concrete inserts, anchor bolts and miscellaneous items having integral anchors.
2. Install inserts and anchorage devices in accordance with Section 05500.
3. The use of impact imbedded fasteners will not be allowed.

### 3.02 FASTENING TO IN-PLACE CONSTRUCTION

- A. Provide anchorage devices and fasteners where necessary for securing stair items to in-place construction; including, threaded fasteners for concrete and masonry inserts, toggle bolts, through-bolts, lag bolts and other connectors as required.

### 3.03 CUTTING, FITTING AND PLACEMENT

- A. Perform all cutting, drilling and fitting required for the installation of the miscellaneous metal items. Set the work accurately in location, alignment and elevation, plumb, level, true and free of rack, measured from established lines and levels. Provide temporary bracing or anchors in framework for items which are to be built into concrete, masonry or similar construction.
- B. Fit exposed connections accurately together for form tight hairline joints. Weld connections which are not to be left as exposed joints, but cannot be shop-welded because of shipping size limitations.

### 3.04 FIELD WELDING

- A. Comply with AWS Code for the procedures of manual shielded metalarc welding, the appearance and quality of welds made, and the methods used in correcting welding work.

### 3.05 ALUMINUM WORK PROTECTION

- A. Aluminum surfaces be in contact with concrete or masonry to be protected by a coat of Coal Tar 46-465 H. B. Tnemecol manufactured by Tnemec Company, North Kansas City, MO; or an acceptable equivalent product.
- B. Areas where the paint has been damaged by abrasion or other cause shall be cleaned and repainted as directed so that the aluminum will have a complete protective paint film when brought into contact with the material against which it is being protected. Before application of coating, the surface shall be cleaned of all dirt, heavy deposits of grease or oil, and other foreign substances, and shall be immersed in or swabbed with an acceptable solvent. Next, the surfaces shall be rinsed with clear water and thoroughly dried.



- C. Protect against electrolysis where aluminum is to be used in conjunction with dissimilar metals.
- D. Where a shop coating of methacrylate lacquer has been specified on aluminum work to protect the surface from stain, the protective coating of lacquer worn off due to handling or erection shall be replaced in the field by a new coating of lacquer of the same type.
- E. During construction, care shall be taken to prevent damage to the aluminum work from splashing or by the accumulation of paint, concrete, mortar, or other similar materials.

3.06 CLEANING ALUMINUM WORK

- A. After aluminum has been erected, it shall be cleaned with mild soap and water, followed by a clear water rinse.

END OF SECTION

## SECTION 05520

### ALUMINUM HANDRAILS AND RAILINGS

#### PART 1 GENERAL

##### 1.01 SECTION INCLUDES

###### A. Section Includes

1. Requirements for fabrication and installation of aluminum handrails and railing.

###### B. Related Sections

1. Section 05500 – Metal Fabrications

##### 1.02 PERFORMANCE REQUIREMENTS

- ###### A. Railing assembly including anchoring of posts and framing members shall be capable of withstanding a minimum load of at least 200 lb. applied in any direction at any point on the top rail.

##### 1.03 SUBMITTALS

###### A. In accordance with Section 01300 submit the following:

1. Manufacturer's specifications, dimension diagrams, anchor details and installation instructions for products to be used in the fabrication of handrails and railings, include coating products. Transmit copy of instructions to the installer.
2. Shop drawings for the fabrication and erection of handrail and railing assemblies. Include plans and elevations, and include details of sections and connections. Show anchorage and accessory items.
3. **Certification that all iron or steel brackets, hardware, fittings or other components are produced in the United States in accordance with the American Iron and Steel requirements of P.L. 113-76, the Consolidated Appropriations Act of 2014**

##### 1.04 PROJECT CONDITIONS

###### A. Field Measurements.

1. Take field measurements prior to preparation of shop drawings and fabrication to ensure proper fitting of the work to existing features and work completed under this Contract.
2. Coordinate fabrication with Construction Schedule.

##### 1.05 SEQUENCING

###### A. Inserts and Anchorages:

1. Furnish inserts and anchoring devices which must be set in concrete or built into masonry for the installation of the handrails and railings work.
2. Provide setting drawings, templates, instructions and directions for installation of anchorage devices.
3. Coordinate delivery with other work to avoid delay.

## PART 2 PRODUCTS

### 2.01 HANDRAILS AND RAILINGS

#### A. Handrail systems shall be:

1. Series 500 by R&B Wagner, Inc., Milwaukee, WI
2. Aluminum Smooth Lite by Modular Railing Systems, Houston, TX
3. Approved equal.

#### B. General

1. Non-welded modular construction.
2. Fabricated as indicated on the Drawings.
3. Stanchions to be 1-1/2 inch IPS, Schedule 80 aluminum pipe, alloy 6063-T6
4. Top and intermediate rails and returns to be 1-1/2 inch Schedule 40 aluminum pipe.
5. Provide stainless steel anchor bolts and fasteners in accordance with SECTION 05500.

**Certification that all iron or steel brackets, hardware, fittings or other components are produced in the United States in accordance with the American Iron and Steel requirements of P.L. 113-76, the Consolidated Appropriations Act of 2014**

#### C. Removable pipe railings

1. Fabricated in the same manner as fixed railings.
2. Installed as indicated.

#### D. Brackets for wall-mounted handrails

1. Cast aluminum pipe rail brackets with curved tops.
2. 3 inch projection from wall to the center of the handrail.

#### E. Brackets for floor mounted stanchions

1. Cast aluminum of the round, flat base flange configuration.
2. Designed to withstand the required loading and to support and reinforce the post.

#### F. Brackets for side-mounted stanchions

1. Aluminum brackets as detailed on the Drawings.
2. Provide a 1-3/8 inch projection from wall to the center of the stanchion.

### 2.02 HANDICAPPED PROVISIONS

- #### A. Provide knurled, abrasive or other textured finish on portions of handrails, a distance of 4 feet from stairs and other openings, to indicate a danger signal in accordance with applicable ADA requirements.

### 2.03 FABRICATION

#### A. Shop Assembly:

1. Form exposed work true to line and elevation with accurate angles and surfaces and straight sharp edges. Ease exposed edges to a radius of approximately 1/32 of an inch, unless otherwise shown. Form bent-metal corners to the smallest radius possible without causing grain separation or otherwise impairing the work.
2. Provide for anchorage of the type shown, coordinated with the supporting structure. Fabricate and space anchoring devices as shown and as required to provide adequate support.

3. After fabrication, all aluminum pipe railings shall receive an Aluminum Association Standard Anodic Finish, Designation M12C22A31.

## PART 3 EXECUTION

### 3.01 INSTALLATION

#### A. Anchorages

1. Furnish setting drawings, diagrams, templates instructions and directions for the installation of anchorages, such as concrete inserts, anchor bolts and miscellaneous items having integral anchors.
2. Install inserts and anchorage devices in accordance with Section 05500.
3. The use of impact imbedded fasteners will not be allowed.

### 3.02 FASTENING TO IN-PLACE CONSTRUCTION

A. Provide anchorage devices and fasteners where necessary to secure handrails and railings to in place construction; including, threaded fasteners for concrete and masonry inserts, toggle bolts, through-bolts, lag bolts, wedge anchors and other connectors as required.

### 3.03 CUTTING, FITTING AND PLACEMENT

- A. Perform all cutting, drilling and fitting required for the installation. Set the work accurately in location, alignment and elevation, plumb, level, true and free of rack, measured from established lines and levels. Provide temporary bracing or anchors in framework for items which are to be built into concrete, masonry or similar construction.
- B. Fit exposed connections accurately together to form tight hairline joints.
- C. Adjust railings prior to securing in place to ensure proper matching at butting joints and correct alignment throughout their length. Space posts not more than 8 feet on centers, unless otherwise shown. Plumb posts in each direction. Secure posts and rail ends to building construction as follows:
1. Handrail stanchions shall be mounted on the top of stair stringers as indicated on the drawings.
  2. The stanchions set into concrete curbs shall be set into preformed holes and secured in place with nonshrinking grout. The holes shall be at least  $\frac{3}{4}$  inches greater in diameter than the outside diameter of the stanchions and shall be a minimum of 5 inches deep.
  3. Products offered by manufacturers to comply with the requirements for hydraulic cement include the following:
    - a. Embeco; Master Builder's
    - b. Ferrolith G; Sonneborn Bldg. Products, Inc.
    - c. Por-Rok; Halemite Mfg. Co.
  4. The stanchions to be side-mounted to structure walls shall be attached to brackets anchored to the structure wall with wedge anchors or suitable fasteners providing a system capable of withstanding the minimum load as specified.
- D. Secure handrails to walls as shown, or by means of wall brackets, and wall return fitting at handrail ends.
- E. Provide brackets with not less than 3 inch projection from the finish wall surface to the center of the pipe handrail, and with the wall plate portion of the bracket drilled to receive on  $\frac{3}{8}$  inch bolt. Locate brackets not more than 60 inches on center. Provide flush-type wall return fittings with the same projection as that specified for wall brackets. Secure wall brackets and wall return fittings to building construction as follows:

1. For concrete and solid masonry anchorage, use bolt anchor expansion shields and lag bolts.
2. For hollow masonry anchorage use toggle bolts having square heads.

#### 3.04 ALUMINUM WORK PROTECTION

- A. Aluminum surfaces be in contact with concrete or masonry to be protected by a coat of Coal Tar 46-465 H.B. Tnemecol manufactured by Tnemec Company, North Kansas City, MO; or an acceptable equivalent product.
- B. Areas where the paint has been damaged by abrasion or other cause shall be cleaned and repainted as directed so that the aluminum will have a complete protective paint film when brought into contact with the material against which it is being protected. Before application of coating, the surface shall be cleaned of all dirt, heavy deposits of grease or oil, and other foreign substances, and shall be immersed in or swabbed with an acceptable solvent. Next, the surfaces shall be rinsed with clear water and thoroughly dried.
- C. Protect against electrolysis where aluminum is to be used in conjunction with dissimilar metals.
- D. During construction, care shall be taken to prevent damage to the aluminum work from splashing or by the accumulation of paint, concrete, mortar, or other similar materials.

#### 3.05 CLEANING ALUMINUM WORK

- A. After aluminum has been erected it shall be cleaned with mild soap and water followed by a clear water rinse.

END OF SECTION

## SECTION 05530

### METAL GRATING

#### PART 1 GENERAL

##### 1.01 SECTION INCLUDES

###### A. Section Includes

1. Requirements for the fabrication and installation of metal gratings and appurtenances.

###### B. Related Sections

1. Section 05500 - Metal Fabrications.
2. Section 05510 - Aluminum Stairs and Ladders.

##### 1.02 REFERENCES

###### A. American Society for Testing and Materials (ASTM)

1. A36, Specification for Carbon Structural Steel.
2. A123, Specification for Zinc (Hot-Dipped Galvanized) Coatings on Iron and Steel Products.
3. A153, Specification for Zinc Coating (Hot-Dip) on Iron and Steel Hardware.
4. A167, Specification for Stainless and Heat-Resisting Chromium-Nickel Steel Plate, Sheet, and Strip.
5. A307, Specification for Carbon Steel Bolts and Studs, 60,000 PSI Tensile Strength.
6. A568, Specification for Steel, Sheet, Carbon, and High-Strength, Low-Alloy, Hot-Rolled and Cold Rolled.
7. B221, Specification for Aluminum and Aluminum-Alloy Extruded Bars, Rods, Wire, Profiles, and Tubes.
8. F593, Specification for Stainless Steel Bolts, Hex Cap Screws and Studs.
9. F594, Specification for Stainless Steel Nuts.
10. F844, Specification for Washers, Steel, Plain (Flat), Unhardened for General Use.

###### B. American National Standards Institute/National Association of Architectural Metal Manufacturers (ANSI/NAAMM)

1. MBG 531, Metal Bar Grating Manual.
2. MBG 532, Heavy Duty Metal Bar Grating Manual.

##### 1.03 SUBMITTALS

###### A. In accordance with Section 01300 submit the following:

###### 1. Shop Drawings

- a. Grating: Show dimensions, weight, and size, and location of connections to adjacent grating, supports, and other work.
- b. Grating Anchorage: Show structural calculations and details of anchorage to supports to prevent displacement from traffic impact.
- c. Grating Supports: Show dimensions, weight, size, location, and anchorage to supporting structure.
- d. Catalog information and catalog cuts.
- e. Manufacturer's specifications, to include coatings.

**f. Certification of compliance with the American Iron and Steel requirements of P.L. 113-76, the Consolidated Appropriations Act of 2014, is required with all submittals**

**B. Samples:**

1. Two samples of aluminum grating approximately 4 inches by 8 inches, showing at least four crossbars each and four bearing bars each.
2. One sample will be retained at the site to be used as a basis for acceptance or rejection of grating installed.

**C. Quality Control Submittals:**

1. Special handling and storage requirements.
2. Installation instructions.
3. Factory test reports.
4. Manufacturer's Certification of Compliance for specified products.
5. Written Test Report that swaged crossbars, if used on grating, meet the requirements of the specified test and additional requirements of these Specifications.

**1.04 PREPARATION FOR SHIPMENT**

- A. Insofar as is practical, factory assemble items provided.
- B. Package and clearly tag parts and assemblies that are of necessity shipped unassembled and protect the materials from damage, and facilitate identification and final assembly in the field.

**PART 2 PRODUCTS**

**2.01 FOOT TRAFFIC GRATING**

**A. Design:**

1. Uniform Service Load: 200 psf minimum uniform load and 300 pound minimum concentrated load, unless otherwise shown.
2. Maximum Deflection: 1/4 inch, unless otherwise shown.
3. Space bearing bars at 1-3/16-inch center-to-center.
4. Banding: 3/16-inch minimum.

**B. Material:**

1. Aluminum Bar Type Grating:
  - a. Press-locked rectangular design, as manufactured by IKG/Borden, Clark, NJ; IKG/Borden Type B or Type F.
  - b. Swage locked aluminum grating, rectangular bar type, as manufactured by:
    - 1) IKG/Borden, Clark, NJ; IKG/Borden Type BS or Type FS.
    - 2) Seidelhuber Metal Products, Inc., San Carlos, CA; Type A-2.
    - 3) Ohio Gratings, Inc., Canton, OH; Aluminum Flush Top, Type 19SGF2.
2. Stair Treads:
  - a. In accordance with this SECTION and the applicable requirements of SECTION 05510.

**2.02 LIGHT VEHICULAR TRAFFIC GRATING**

**A. Design:**

1. Maximum Load: 2,000 pounds per wheel, minimum wheel base and axle width of 4 feet 0 inch.
2. Space main bars at 1-3/16-inch center-to-center.
3. Banding: 1/4 inch.

B. Material:

1. Aluminum Bar Type Grating: Press-locked deep rectangular crossbar designed as manufactured by IKG/Borden, Clark, NJ, IKG/Borden; Type B or Type F.
2. Galvanized Steel Bar Type Grating:
  - a. After Fabrication: ASTM A123, zinc coating.
  - b. Manufacturer and Product: IKG/Borden, Clark, NJ; IKG/Borden heavy-weld Type HWF or Type HWB or press-locked, rectangular crossbar, Type FJ or BJ.

2.03 HEAVY VEHICULAR TRAFFIC GRATING

A. Design:

1. Loading: AASHTO HS 20-44.
2. Banding: 1/4 inch.

B. Material:

1. Galvanized Steel Bar Type:
  - a. Heavy-duty, main bars spaced at 1-7/8-inch maximum center-to-center.
  - b. After Fabrication: ASTM A123, zinc coating.
  - c. Manufacturer and Product: IKG/Borden, Clark, NJ; KG/Borden heavy-weld Type HWF or HWB or press-locked, rectangular crossbar, Type BJ or FJ.

2.04 ACCESSORIES

A. Anchor Bolts and Nuts:

1. Carbon Steel: ASTM A307 or A36.
2. Stainless Steel: ASTM F593 and ASTM F594, Type 316.
3. Galvanized Steel Bolts and Nuts: ASTM A153, zinc coating for ASTM A307 or A36.

B. Flat Washers

1. Carbon Steel: (Unhardened): ASTM F844; use ASTM A153 for zinc coating.
2. Stainless Steel: see SECTION 05500.

C. Removable Fastener Clips and Bolts:

1. Removable from above grating walkway surface.
2. Hat Bracket: Type 304 stainless steel.
3. Bolt: type 316 stainless steel.
4. Cast iron, galvanized body.
5. Manufacturer and Product: Struct-Fast, Wellesley Hills, MA; Gratefast.

D. Partially Removable Anchor:

1. Bolt: Threaded stud, Type 316 stainless steel.
  - a. Manufacturer: Nelson Stud Welding Co., Loraine, OH.
2. Hat Bracket: Type 304 stainless steel.
  - a. Manufacturer:
    - 1) Struct-Fast, Wellesley Hills, MA.
    - 2) Or equal.



## 2.05 FABRICATION

### A. General:

1. Exposed Surfaces: Smooth finish and sharp, well-defined lines.
2. Furnish necessary rabbets, lugs, and brackets so work can be assembled in a neat, substantial manner.
3. Conceal fastenings where practical.
4. Drill metalwork and countersink holes as required for attaching hardware or other materials.
5. Weld Connections: Not permitted on grating except at banding bars.

### B. Design:

1. Field measure areas to receive grating, verify dimensions of new fabricated supports, and fabricate to dimension required for specified clearances.
2. Section Length: Sufficient to prevent its falling down through clear opening when oriented in the span direction when one end is touching either the concrete or the vertical leg of grating support.
3. Minimum Bearing: ANSI/NAAMM MBG 531.
4. Metal Crossbar Spacing: 4-inch maximum, unless otherwise shown or specified.
5. Crossbars: Flush with top of main bar and extend downward a minimum of 50 percent of the main bar depth.
  - a. Swaged Crossbars:
    - 1) Within 1/4 inch of top of grating with 1/2-inch minimum vertical dimension after swaging, and minimum before swaging dimension of 5/16-inch square.
    - 2) Crossbar Dimension After Swaging: Minimum 1/8-inch wider than the opening at minimum of two corners at each side of each square opening in main bar.
    - 3) Crossbars may be a special extruded shape so that after swaging the top will be flat, 3/16 inches wide and will be flush with the top surface of the bearing bars for a minimum of 5/8 inches at center between bearing bars.
    - 4) Flush crossbar meeting all of the above except that after swaging shall overlap one corner by a minimum of 1/8 inch. A sample of one bearing bar and one crossbar shall be tested by holding the bearing bar and pulling on the crossbar. The crossbar to bearing bar shall sustain a minimum of 300 pounds without pullout of the bearing bar.
    - 5) Tightly fit main bars and crossbars allowing no differential movement.
6. Do not use weld type crossbars.
7. Banding: Same material as grating: ANSI/NAAMM MBG 531 and ANSI/NAAMM MBG 532.
8. Furnish stainless steel Type 316 threaded anchor studs, as fasteners for grating attachment to metal supports either not embedded or partially embedded in concrete, as manufactured by Nelson Studs Welding Co., Lorain, OH.

### C. Supports:

1. Seat angles and beams where shown:
  - a. Same material as rectangular bar grating.
  - b. Extruded aluminum frame with slot for recessed grating clips, as manufactured by Thompson Fabricating Co., for aluminum I-Bar type grating.
2. Coordinate dimensions and fabrication with grating to be supported.
3. Coordinate dimensions with increased depth due to serrations.
4. Welded Frames With Anchors: Continuously welded.

### D. Slip-Resistant Surface:

1. Rectangular Steel and Aluminum Bar Grating (as noted): As manufactured by:

- a. IKG/Borden, Clark NJ; EZ Weldslip-Resistant Coating.
  - b. Seidelhuber Metal Products, Inc., Hayward, CA; Safety Grit Non-Slip System.
  - c. Ohio Gratings, Inc., Canton, OH with "Slip-Not" Safety Surface manufactured by W.S. Molnar Co., Detroit, MI.
- 2. I-Bar grating aluminum shall incorporate a striated anti-skid walking surface produced during the extrusion process, as manufactured by:
    - a. IKG/Borden, Clark, NJ.
    - b. Seidelhuber Metal Products, Inc., Hayward, CA.
    - c. Klemp Corp., Chicago, IL.
- E. Aluminum:
- 1. ASTM B221 extruded shapes.
  - 2. Fabricate as shown and in accordance with manufacturer's recommendations.
  - 3. Grind smooth sheared edges exposed in the finished work.
  - 4. Swage crossbars, if used, with equipment strong enough to deform crossbars.
  - 5. Eliminate any loose crossbar intersections on swaged grating.
- F. Foot Traffic Grating: Any single grating section, individual plank, or plank assembly shall be not less than 1 foot 6 inches or greater than 3 feet 0 inch in width or weigh more than 150 pounds.

## EXECUTION

### 2.06 PREPARATION

#### A. Electrolytic Protection:

- 1. Aluminum surfaces in contact with dissimilar metals, other than stainless steel, and embedded or in contact with masonry, grout, and concrete, to be protected by a coat of Bitumastic Super Service Black manufactured by KOP-COAT, Inc., Pittsburgh, PA; 46-465 Heavy Themecol manufactured by Tnemec Company, North Kansas City, MO; or an acceptable equivalent product.

### 2.07 INSTALLATION

- A. Install supports such that grating sections have a solid bearing on both ends, and that rock and wobble grating movement does not occur under designed traffic loading.
- B. Install plumb or level as applicable.
- C. Install welded frames with anchors to straight plan without offsets.
- D. Anchor grating securely to supports using minimum of four fasteners clips and bolts per grating section.
- E. Use stainless steel anchors and accessories with aluminum gratings.
- F. Completed installation shall be rigid and neat in appearance.
- G. Commercially Manufactured Products:
  - 1. Install in accordance with manufacturer's recommendations.
  - 2. Secure grating to support members with fasteners.
  - 3. Welding is not permitted.
  - 4. Fasteners: Field locate and install.
  - 5. Permit each grating section or plank style grating assembly to be easily removed and replaced.

- H. Protect painted surfaces during installation.
- I. Should coating become marred, prepare and touch up surface in accordance with paint manufacturer's instructions.

END OF SECTION

**DIVISION 06**

## SECTION 06600

### FIBERGLASS REINFORCED PLASTIC PRODUCTS AND FABRICATIONS

#### PART 1 - GENERAL

##### 1.01 SECTION INCLUDES

- A. Requirements to furnish all labor, materials, equipment and incidentals necessary to install the fiberglass reinforced plastic (FRP) pultruded gratings and frames as specified herein.
- B. This section does NOT include FRP process elements, including:
  - a. Section 11600 – FRP Baffles
  - b. Section 11601 – FRP Weirs
  - c. Section 11602 – FRP Slide Gates

##### 1.04 QUALITY ASSURANCE

- A. The material covered by these specifications shall be furnished by a reputable and qualified manufacturer of proven ability who has regularly engaged in the manufacture and installation of FRP systems.
- B. Substitution of any component or modification of system shall be made only when approved by the Engineer.
- C. Fabricator Qualifications: Firm experienced in successfully producing FRP fabrications similar to that indicated for this project, with sufficient production capacity to produce required units without causing delay in the work.
- D. In addition to requirements of these specifications, comply with manufacturer's instructions and recommendations for work.

##### 1.05 DESIGN CRITERIA

- A. The design of FRP products including connections shall be in accordance with governing building codes and standards as applicable.
- B. Design live loads of FRP molded grating shall be in accordance with the following design loads based on the latest adopted International Building Code:
  - 60 psf live load (non-emergency exit walkways)
  - 300 lb concentrated load

- C. Structural members shall be designed to support all applied loads. Deflection in any direction shall not be more than  $L/180$  of span for structural members. Connections shall be designed to transfer the loads.

#### 1.06 SUBMITTALS

- A. Shop drawings of all FRP fabrications shall be submitted to the Engineer for approval in accordance with the requirements of Section 01300.
- B. Metal fasteners and accessories are subject to American Iron and Steel requirements. Submittals shall include certification of compliance with AIS requirements or inclusion in a De Minimis waiver.
- C. Manufacturer's catalog data showing:
  - 1. Dimensions, spacings, and construction of grating
  - 2. Design tables showing limits for span length and deflection under various uniform and concentrated loads
  - 3. Materials of construction
- D. Detail shop drawings showing:
  - 1. Dimensions
  - 2. Sectional assembly
  - 3. Location and identification mark
  - 4. Size and type of supporting frames required
- E. Samples of each type of product proposed shall be submitted for approval prior to placement of purchase orders.

#### 1.07 SHIPPING AND STORAGE INSTRUCTIONS

- A. All systems, sub-systems and structures shall be shop fabricated and assembled into the largest practical size suitable for transporting.
- B. All materials and equipment necessary for the fabrication and installation of the grating shall be stored before, during, and after shipment in a manner to prevent cracking, twisting, bending, breaking, chipping or damage of any kind to the materials or equipment, including damage due to over exposure to the sun. Any material which, in the opinion of the Engineer, has become damaged so as to be unfit for use, shall be promptly removed from the site of work, and the Contractor shall receive no compensation for the damaged material or its removal.
- C. Identify and match-mark all materials, items, and fabrications for installation and field assembly.

### PART 2 PRODUCTS

## 2.01 GENERAL

- A. Materials used in the manufacture of the FRP products shall be new stock of the best quality and shall be free from all defects and imperfections that might affect the performance of the finished product.
- B. All materials shall be of the kind and quality specified, and where the quality is not specified, it shall be the best of the respective kinds and suitable for the purpose intended.
- C. All FRP products noted in Part 1.02 shall be manufactured using a pultruded process utilizing either an isophthalic polyester or a vinyl ester resin with flame retardant and ultraviolet (UV) inhibitor additives. A synthetic surface veil shall be the outermost layer covering the exterior surface. The FRP shapes shall achieve a flame spread of 25 or less in accordance with ASTM test method E-84. (Isophthalic polyester resin is available without flame retardant and UV inhibitor additives.)
- D. After fabrication, all cut ends, holes and abrasions of FRP shapes shall be sealed with a compatible resin coating to prevent intrusion of moisture.
- E. FRP products exposed to weather shall contain an ultraviolet inhibitor. Should additional ultraviolet protection be required, a one mil minimum U.V. coating can be applied.
- F. All exposed surfaces shall be smooth and true to form.
- G. Acceptable Manufacturers
  - 1. Strongwell
  - 2. Approved alternative

## 2.02 GRATINGS AND TREADS

- A. General
  - 1. Grating shall be shipped from the manufacturer, palletized and banded with exposed edges protected by cardboard to prevent damage in shipment.
  - 2. Each piece shall be clearly marked showing manufacturer's applicable drawing number.
  - 3. Grating shall be DURADEK® or DURAGRID® as manufactured by Strongwell- Chatfield Division, Chatfield, MN, or approved equal.
- B. Design
  - 1. The panels shall be 1-1/2 inches deep and sustain a deflection of no more than 0.25 inches under a uniform distributed load of 100 psf for the span lengths shown on the plans.

2. The bearing bars shall be joined into panels by passing continuous length fiberglass pultruded cross rods through the web of each bearing bar. The pultruded cross rod assembly shall consist of two cross rod spacers that have notches cut into them at 6 inches on center to fit the distance between the web of each bearing bar. A continuous fiberglass pultruded bar shaped section shall be wedged between the two cross rod spacers mechanically locking the notches in the cross rod spacers to the web of the bearing bars. Continuous chemical bonding shall be achieved between the cross rod spacers and the bearing web and between the bar shaped wedge and the two cross rod spacers locking the entire panel together to give a panel that resists twist and prevents internal movement of the bearing bars.
4. The top surface of all panels shall have a non-skid grit affixed to the surface by an epoxy resin followed by a top coat of epoxy resin.
5. Panels shall be fabricated to the sizes shown on the drawings.
6. Hold down clamps shall be type 316L stainless steel saddle clips. A minimum of 4 each per panel.
7. Color shall be high visibility yellow.
8. All bearing bars that are to be exposed to UV shall be coated with polyurethane coating of a minimum thickness of 1 mil.

C. Products

1. The FRP grating shall be fabricated from bearing bars and cross rod manufactured by the pultrusion process. The bearing bars shall be 1.5 inches deep with a 0.6 inch wide top flange, a 0.6 inch wide bottom flange and a web thickness of 0.16 inch. The glass fiber reinforcement for the bearing bars shall be a core of continuous glass strand rovings wrapped with continuous strand glass mat. A synthetic surface veil shall be the outermost layer covering the exterior surfaces.
2. FRP Grating shall be made from a premium grade chemical resistant, fire retardant vinyl ester resin system with antimony trioxide added to meet the flame rating of 25 or less in accordance with ASTM E-84 testing and meet the self-extinguishing requirements of ASTM D-635. U. V. inhibitors are added to the resin.
4. All cut and machined edges, holes and abrasions shall be sealed with a resin compatible with the resin matrix used in the bearing bars and cross rods.
5. All panels shall be fabricated to the sizes shown on the approved shop drawing.

## PART 3 EXECUTION

### 3.01 PREPARATION

- A. Coordinate and furnish anchorages, setting drawings, diagrams, templates, instructions and directions for installation of anchorages, including concrete



inserts, sleeves, anchor bolts and miscellaneous items having integral anchors that are to be embedded in concrete or masonry construction. Coordinate delivery of such items to project site.

- B. Set sleeves in concrete with tops flush with finish surface elevations; protect sleeves from water and concrete entry.

### 3.02 INSPECTION AND TESTING

- A. The Engineer shall have the right to inspect and test all materials to be furnished under these specifications prior to their shipment from the point of manufacture.
- B. All labor, power, materials, equipment and appurtenances required for testing shall be furnished by the Contractor at no cost to the Owner.

### 3.03 INSTALLATION, GENERAL

- A. Fastening to in-place construction: Provide anchorage devices and fasteners where necessary for securing miscellaneous FRP fabrications to in-place construction; include threaded fasteners for concrete and masonry inserts, toggle bolts, through-bolts, lag bolts and other connectors as required.
- B. Cutting, fitting and placement: Perform cutting, drilling and fitting required for installation of miscellaneous FRP fabrications. Set FRP fabrication accurately in location, alignment and elevation; with edges and surfaces level, plumb, true and free of rack; and measured from established lines and levels.
- C. Provide temporary bracing or anchors in form work for items that are to be built into concrete masonry or similar construction.

### 3.04 ALL FRP INSTALLATION

- A. All field cut and drilled edges, holes and abrasions shall be sealed with a catalyzed resin compatible with the original resin as recommended by the manufacturer. The sealing of the edges shall prevent premature fraying at the field cut edges.
- B. Install items specified as indicated and in accordance with manufacturer's instructions.

END OF SECTION

**DIVISION 07**

## SECTION 07002

### WATERPROOFING, DAMP-PROOFING, AND CAULKING-GENERAL

#### PART 1 GENERAL

##### 1.01. REQUIREMENTS

- A. The work to be done under this classification is included in the following sections:
  - 1. SECTION 07190 – VAPOR AND AIR BARRIERS; excluding the requirement for Sheet Vapor Retarder which is to be placed under concrete slabs.
  - 2. SECTION 07900 – JOINT SEALANTS
- B. The Instruction to Bidders, Bid Forms, Agreement, Standard General Conditions, and Supplementary Conditions are hereby made a part of these specifications and the subcontractor shall consult them in detail for instructions.
- C. The work of this Section is based on:
  - 1. Specifications indicated above.
  - 2. Work shown on the General (G) drawings.
  - 3. Work related to the above specifications found on the architectural (A) and structural (S) and mechanical (M) drawings.
- D. Details of the procedure for filing sub-bids are contained in the Instruction to Bidders.

##### 1.02. RELATED SECTIONS

- A. All Division 1 specifications are considered to be related sections to the scope of work.

#### PART 2 PRODUCTS

Not used.

#### PART 3 EXECUTION

Not used.

END OF SECTION

## SECTION 07190

### VAPOR AND AIR BARRIERS

#### PART 1 GENERAL

##### 1.01 DESCRIPTION OF WORK

- A. Furnish and install vapor retarders, air barriers, and required accessories in accordance with the Contract Documents including, but not limited to, the following:
1. Sheet Vapor Retarder – For installation beneath concrete floor slabs.
    - a. Seam tape and other accessories for use with sheet vapor retarders.
  2. Air and Vapor Barrier – Fluid-applied elastomeric air and vapor barrier for installation to the exterior of concrete masonry unit walls; designated “AVB” on Drawings.
    - a. System includes all detail tapes, flashings, sealants, control joint treatment and adhesives required to provide:
      - i. Continuity of the air and vapor barrier across the masonry surface and connections to adjacent construction.
      - ii. Weather protection including positive drainage from the masonry wall cavity.
    - b. AVB, in conjunction with insulation, and veneer masonry, must comply with the regulatory requirements stated in Article 1.05 of this section.
  3. Cold-Applied, Single-Component Waterproofing – For exterior insulated slabs with heated spaces below

##### 1.02 RELATED SECTIONS

- A. SECTION 07212 – BOARD INSULATION
- B. SECTION 07710 – ROOF SPECIALTIES
- C. SECTION 07900 – JOINT SEALANTS

##### 1.03 REFERENCES

- A. Sealant, Waterproofing, and Restoration Institute (SWRI) – Sealants: The Professionals Guide
- B. ASTM D882 – Tensile Properties of Thin Plastic Sheeting
- C. ASTM D4833 – Index Puncture Resistance of Geotextiles, Geomembranes, and Related Products
- D. ASTM E84 – Standard Test Method for Surface Burning Characteristics of Building Materials
- E. ASTM E96 – Standard Test Method for Water Vapor Transmission of Materials

- F. ASTM E1643 – Installation of Water Vapor Retarders Used in Contact with Earth or Granular Fill Under Concrete Slabs
  - G. ASTM E1745 – Standard Specification for Water Vapor Retarders Used in Contact with Soil or Granular Fill Under Concrete Slabs
  - H. ASTM E2357 – Standard Test Method for Determining Air Leakage of Air Barrier Assemblies
  - I. ICC Evaluation Service (ICC-ES) – Evaluation Reports
  - J. NFPA 259 – Standard Test Method for Potential Heat of Building Materials
  - K. NFPA 285 – Standard Test Method for Evaluation of Fire Propagation Characteristics of Exterior Non-Load-Bearing Wall Assemblies Containing Combustible Components
- 1.04 PERFORMANCE REQUIREMENTS
- A. Materials of this Section shall provide continuity of the building enclosure Vapor or Air Barrier as indicated in the Contract Documents.
  - B. Where foam plastic insulation forms part of an exterior wall assembly, such assembly must comply with the regulatory requirements stated in Article 1.05.
- 1.05 REGULATORY REQUIREMENTS
- A. Completed exterior wall assemblies, including insulation, vapor barrier, air barrier, weather barrier, flashing, sealants, and adhesives are to match that of an assembly that has been tested and met the requirements of NFPA 285, or match that of an assembly described in an ICC-ES Evaluation Report that certifies the assembly as meeting IBC Section 2603.5
- 1.06 SUBMITTALS
- A. Provide in accordance with Section 01300, Submittals, and as supplemented herein. Submittals shall include, but not be limited to, the following:
  - B. Product Data
    - 1. For all sheet and fluid-applied materials, provide manufacturer’s technical literature indicating composition, tensile strength, permeability, and other relevant characteristics.
    - 2. For all vapor retarder, vapor barrier or air barrier materials, provide manufacturer’s technical literature describing all accessory materials required for a complete installation; including, but not limited to, flashings, detail membranes or tapes, edge sealants and adhesives.
    - 3. Provide detailed installation instructions indicating conditions necessary for fluid-applied membranes and associated accessories to function as an effective barrier system, integrated with the wall, window and door configurations specific to this project.
  - C. Submit manufacturer’s samples of sheet products.
  - D. Shop Drawings - Provide standard details, special details, and assistance to

Contractor for use by suppliers of products referenced in Sections listed in Article 1.02 in preparing detailed coordination drawings.

- E. Where foam plastic insulation forms part of an exterior wall assembly: submit proof of compliance with the regulatory requirements of Article 1.05.
- 1.07 QUALITY ASSURANCE
- A. Where relevant, perform work in accordance with SWRI Sealant and Caulking Guide Specification requirements for materials and installation
- 1.08 DELIVERY, STORAGE AND HANDLING
- A. Deliver materials to the site in manufacturer's original, unopened containers with labels clearly identifying product name and manufacturer.
  - B. Store materials in a clean dry area in accordance with manufacturer's instructions.
  - C. Protect materials during handling and installation to prevent damage.
- 1.09 ENVIRONMENTAL REQUIREMENTS
- A. Maintain temperature and humidity recommended by the materials manufacturers before, during, and after installation.
- 1.10 SEQUENCING
- A. Sequence work to permit installation of materials in conjunction with other materials and seals.
- 1.11 COORDINATION
- A. Coordinate the work of this section with all sections referencing this section or referenced by this section.

## PART 2 PRODUCTS

### 2.01 SYSTEMS

- A. 10 Mil Sheet Vapor Retarder – For installation beneath concrete floor slabs. To meet or exceed the requirements of ASTM E1745 for Class A. To include all accessories and components of a complete system by a single manufacturer, or with all components approved in writing by the sheet manufacturer.
  - 1. Griffolyn® Division of Reef Industries, Inc., Houston, TX
  - 2. Raven Industries, Sioux Falls, SD
  - 3. STEGO Industries, LLC, San Clemente, CA
- B. Air and Vapor Barrier (AVB) – Fluid-applied elastomeric air and vapor barrier for installation to the exterior of concrete masonry unit walls and to the top surface of precast concrete ceiling planks, designated “AVB” on Drawings. To include all accessories and components of a complete system by a single manufacturer, or with all components approved in writing by the membrane manufacturer.
  - 1. Performance

- a. Volatile organic compounds less than 52 µg/L.
  - b. Water Vapor Permeance per ASTM E96.B less than one Perm.
  - c. Air Leakage 0.0075 CFM/ft<sup>2</sup> or less per ASTM E2357.
  - d. Flame Spread Index less than 25, and Smoke Generation 200 or less per ASTM E84.
2. Manufacturers
- a. Carlisle Coating & Waterproofing, Inc.
  - b. W. R. Meadows Inc.
  - c. Tremco Commercial Sealants & Waterproofing, Inc.
- C. Cold –Applied, Single-Component Waterproofing - For exterior insulated slabs with heated spaces below. To meet or exceed the requirements of ASTM C 836. To include all accessories and components of a complete system by a single manufacturer, or with all components approved in writing by the manufacturer.
- 1. Hydralastic 836 - W. R. Meadows Company
  - 2. Henry CM100 – Henry Company
  - 3. ConSeal CS-1800 Waterproofing Membrane – Concrete Sealants Inc.

## PART 3 EXECUTION

### 3.01 EXAMINATION

- A. Verify that surfaces and conditions are ready to accept the work.

### 3.02. PREPARATION

- A. Remove objects which might impale/puncture sheet material.
- B. Remove loose or foreign material which might impair adhesion of seam and flashing tapes
- C. Prime surfaces where directed by manufacturer's instructions

### 3.03. INSTALLATION OF SHEET MATERIALS

- A. Install sheet materials in accordance with manufacturer's instructions; tape all seams
- B. Lap sheet materials and seal with tape. Position lap seal over firm bearing.
- C. Cut sheet materials tight to pipes and other slab penetrations. Seal to penetrating objects with tape. At pipe penetrations, seal with prefabricated pipe boots
- D. Repair holes or punctures with self-adhesive tape.

### 3.04. INSTALLATION OF FLUID-APPLIED SYSTEMS

- A. Install fluid-applied systems in accordance with manufacturer's instructions.

- B. Use self-adhesive flashing or detail material, in combination with compatible sealants and adhesives, to provide continuity between barrier membrane and window, door and louver frames.
  - C. Connect barrier membrane to flashings to provide continuous weather protection and positive drainage in wall assemblies.
  - D. Provide flexible and air-tight connections between membrane surfaces on either side of substrate movement joints.
- 3.05. PROTECTION OF FINISHED WORK
- A. Do not permit adjacent or subsequent work to damage work of this section.

END OF SECTION



SECTION 07212

BOARD INSULATION

PART 1 GENERAL

1.01. SECTION INCLUDES

- A. Board insulation at slabs-on-grade and perimeter foundation walls.
- B. Board insulation installed in unit masonry system cavity walls.
- C. Adhesive utilized for board insulation and as vapor retarder in cavity walls.

1.02. RELATED SECTIONS

- A. See Division 1 sections for contract requirements.
- B. SECTION 03300 - CAST-IN-PLACE CONCRETE
- C. SECTION 07190 - VAPOR AND AIR BARRIERS

1.03. REFERENCES

ASTM D1187	Standard Specification for Asphalt Base Emulsions for Use as Protective Coatings for Metal
ASTM D1227	Standard Specifications for Emulsified Asphalt Used as a Protective Coating for Roofing
ASTM C578	Standard Specification for Rigid, Cellular Polystyrene Thermal Insulation

1.04. PERFORMANCE REQUIREMENTS

- A. Materials of this section shall provide continuity of thermal barrier at building enclosure elements.

1.05. SUBMITTALS

- A. Submit under provisions of the Division 1 contract requirements.
- B. Product Data - Provide manufacturer's data on product characteristics, performance criteria, limitations, and installation methods.

1.06. ENVIRONMENTAL REQUIREMENTS

- A. Do not install insulation adhesives when temperature or weather conditions are detrimental to successful installation.

1.07. COORDINATION

- A. Coordinate work under provisions of the Division 1 contract requirements.
- B. Coordinate the work with Section 04810, Unit Masonry Assemblies, for installation of vapor retarder and mastic adhesive.

PART 2 PRODUCTS

2.01. MANUFACTURERS - INSULATION MATERIALS

- A. Dow Chemical Company.
- B. Owens Corning.
- C. Johns-Manville.
- D. Substitutions - Under provisions of the Division 1 contract requirements.

2.02. INSULATION MATERIALS

- A. Polystyrene Insulation - ASTM C578 Type IV or Type VI; extruded cellular type, conforming to the following minimum criteria:

Thermal Resistance	R of 5.0 per inch
Thickness	2 1/2-inch for cavity walls and foundation wall
Board Size	24 x 96 inch at foundation walls; 16 x 96 inch at cavity walls
Compressive Strength	Minimum 25 psi for stud wall installation (Type IV); minimum 40 psi for below-grade installation (Type VI)
Water Absorption	In accordance with ASTM C272 0.3 percent by volume maximum (both types)
Water Vapor Permeance	1.1 maximum in accordance with ASTM E96 (both types)
Edges	Square edges

2.03. ADHESIVE

- A. Adhesive - Fibered asphalt emulsion mastic conforming to ASTM D1187 Type I and ASTM D1227 Type II, Class 1.
  - 1. Karnak Corporation 920AF, Clark, NJ.
  - 2. Sonneborn Hydrocide 700, Shakopee, MN.
  - 3. Dow Corning Corporation, Auburn, MI.
  - 4. Approved equal as per insulation manufacturer recommendations.

PART 3 EXECUTION

3.01. EXAMINATION

- A. Verify site conditions under provisions of the Division 1 contract requirements.
- B. Verify that substrate, adjacent materials, and insulation boards are dry and ready to receive insulation and adhesive.
- C. Verify substrate surface is flat, free of honeycomb, fins, irregularities, materials or substances that may impede adhesive bond.

### 3.02. INSTALLATION

#### A. Foundation Perimeter

1. Apply insulation boards to exterior foundation walls as shown on construction drawings.
2. Adhere insulation to wall by applying 4-inch diameter spots of adhesive to walls 16 inches on center both ways. Press insulation firmly into adhesive immediately after placement of adhesive.

#### B. Cavity Walls

1. Verify that masonry veneer ties are in place and properly spaced before applying vapor retarder/adhesive.
2. Trowel on a full and continuous coating of vapor retarder/adhesive to the outside face of the inner wythe of the cavity wall. Apply at a coverage of 4 to 6 gallons per 100 square feet.
3. Once the continuous coating of vapor retarder and mastic adhesive has cured, apply 4-inch diameter spots of adhesive to walls 16 inches on center both ways. Press insulation firmly into adhesive immediately after placement of adhesive.
4. Fit insulation tightly around masonry veneer ties and other interruptions in the wall surface.

### 3.03. PROTECTION OF FINISHED WORK

- A. Protect finished work under provisions of the Division 1 contract requirements.
- B. Do not permit work to be damaged prior to covering insulation.

END OF SECTION

## SECTION 07840

### PENETRATION FIRESTOPPING

#### PART 1 GENERAL

##### 1.01. DESCRIPTION OF WORK

- A. Furnish and install firestop systems consisting of a material, or combination of materials, installed to retain the integrity of fire resistance rated construction by maintaining an effective barrier against the spread of flame, smoke and/or hot gases through penetrations, blank openings, construction joints, fire-resistive joints, and perimeter openings in or adjacent to fire-rated barriers in accordance with the requirements of the Building Code for this project.
- B. Firestop systems shall be used in locations including, but not limited to, the following:
  - 1. Penetrations through fire resistance rated floor and roof assemblies requiring protected openings, including both empty openings and openings containing penetrants.
  - 2. Penetrations through fire resistance rated wall assemblies including both empty openings and openings containing penetrants.
  - 3. Membrane penetrations in fire resistance rated wall assemblies where items penetrate one side of the barrier.
  - 4. Joints between fire resistance rated assemblies.
  - 5. Perimeter gaps between rated floors/roofs and an exterior (rated and non-rated) wall assembly.

##### 1.02. RELATED SECTIONS

- A. SECTION 03300 – CAST-IN-PLACE CONCRETE
- B. SECTION 07190 – VAPOR AND AIR BARRIERS
- C. SECTION 07212 – BOARD INSULATION
- D. SECTION 07900 – JOINT SEALANTS
- E. Division 15 Sections – Mechanical, HVAC and Plumbing Systems
- F. Division 16 Sections - Electrical; Lighting, Power, Alarms, and Communications

### 1.03. REFERENCES

#### A. American Society For Testing and Materials Standards (ASTM)

1. ASTM E84 - Standard Test Method For Surface Burning Characteristics of Building Materials
2. ASTM E119 - Methods of Fire Tests of Building Construction and Materials
3. ASTM E136 - Standard Test Method for Behavior of Materials in a Vertical Tube Furnace at 750 Degrees C
4. ASTM E814 - Standard Test Method For Fire Tests of Through-Penetration Firestops
5. ASTM E1399 - Test Method for Cyclic Movement and Measuring Minimum and Maximum Joint Width
6. ASTM E1966 - Test Method For Resistance of Building Joint Systems
7. ASTM E2174 - Standard Practice for On-Site Inspection of Installed Fire Stops
8. ASTM E2307 - Standard Test Method for Determining Fire Resistance of Perimeter Fire Barriers Using Intermediate-Scale, Multi-Story Test Apparatus
9. ASTM E2393 - Standard Practice for On-Site Inspection of Installed Fire Resistive Joint Systems and Perimeter Fire Barriers

#### B. Underwriters Laboratories Inc. (UL)

1. UL 263 - Fire Tests of Building Construction and Materials
2. UL 723 - Surface Burning Characteristics of Building Materials
3. UL 1479 - Fire Tests of Through-Penetration Fire Stops
4. UL 2079 - Tests for Fire Resistance of Building Joint Systems

#### C. UL Fire Resistance Directory - Volume 2

1. Through-Penetration Firestop Devices (XHJI)
2. Fire Resistive Ratings (BXUV)
3. Through-Penetration Firestop Systems (XHEZ)
4. Fill, Void, or Cavity Material (XHHW)
5. Perimeter Barrier (Fire Containment) System (XHDG)
6. Forming Materials (XHKU)
7. Curtain Wall Insulation (XHGU)

#### D. UL Building Materials Directory

#### E. Omega Point Laboratories (OPL) - Directory of Listed Building Products, Materials & Assemblies, Volume II

#### F. UL Qualified Firestop Contractor Program

G. Warnock Hersey (WH) - Certification and Listings Directory

H. NFPA - NFPA 101: Life Safety Code

1. NFPA 285, "Tests for Evaluation of Flammability Characteristics of Exterior Non-Load-Bearing Wall Assemblies Containing Combustible Components Using the Intermediate-Scale, Multi-Story Test Apparatus."

I. Current Building Code of Massachusetts and referenced standards.

#### 1.04. DEFINITIONS

- A. Firestopping - The use of a material or combination of materials in a fire-rated structure (wall or floor) where it has been breached, so as to restore the integrity of the fire rating of that wall or floor.
- B. System - The use of a specific firestop material or combination of materials around a specific penetrant(s) or into a specific joint in conjunction with a specific wall and/or floor construction type.
- C. Barrier - Any bearing or non-bearing wall or floor that has an hourly fire and smoke rating.
- D. Through-penetration - Any penetration of a fire-rated wall or floor that completely breaches the barrier.
- E. Membrane-penetration - Any penetration in a fire-rated wall that breaches only one side of the barrier.
- F. Fire-Resistive Joint - Any gap, joint, or opening, whether static or dynamic, between two fire-rated barriers including where the top of a wall meets a floor; wall edge to wall edge configurations; floor edge to floor edge configurations; floor edge to wall configurations.
- G. Perimeter Barrier - Any gap, joint, or opening, whether static or dynamic, between a fire-rated floor assembly and a non-rated exterior wall assembly.
- H. Engineering Judgment (EJ) - A firestopping assembly proposed for conditions where a tested and listed firestopping system does not exist.

#### 1.05. PERFORMANCE REQUIREMENTS

- A. Penetrations - Provide and install through-penetration firestop systems that are produced to resist the spread of fire, passage of smoke and other gases according to requirements indicated, to restore the original fire-resistance rating of barrier penetrated.
  1. Provide and install complete penetration firestopping systems that have been tested and approved by nationally accepted testing agencies per ASTM E814 or UL 1479 fire tests in a configuration that is representative of field conditions.
  2. F-Rated Systems - Provide through-penetration firestop systems with F ratings indicated, as determined per ASTM E814 or UL 1479, but not less than 1 hour or the fire resistance rating of the barrier being penetrated.

3. T-Rated Systems - Provide through-penetration firestop systems with T ratings indicated, as well as F-ratings, as determined per ASTM E814 or UL 1479, where required by the Building Code.
  4. L-Rated Systems - Provide through-penetration firestop systems with L ratings in addition to F and T ratings, as determined per UL 1479, where required by the Building Code.
  5. For piping penetrations for plumbing and wet-pipe sprinkler systems, provide moisture-resistant through-penetration firestop systems (W-rated systems) as determined per UL 1479, where indicated.
  6. For penetrations involving insulated piping, provide through-penetration firestop systems not requiring removal of piping insulation.
- B. Fire-Resistive Joints - Provide joint systems with fire resistance assembly ratings indicated, as determined by UL 2079 (ASTM E1399 and E1966), but not less than the fire resistance rating of the construction in which the joint occurs. Firestopping assemblies must be capable of withstanding anticipated movements for the installed field conditions.
1. For firestopping assemblies exposed to view, traffic, moisture, and physical damage, provide products that after curing do not deteriorate when exposed to these conditions both during and after construction.
  2. For floor penetrations exposed to possible loading and traffic, provide firestop systems capable of supporting floor loads involved either by installing floor plates or by other means.
- C. Building Perimeter Barrier (Fire Containment) Systems - Provide interior perimeter joint systems with fire resistance ratings indicated as determined per ASTM E2307, but not less than the fire resistance rating of the floor construction.
1. Provide products that upon curing, do not re-emulsify, dissolve, leach, breakdown or otherwise deteriorate over time from exposure to atmospheric moisture, ponding water or other forms of moisture characteristic during and after construction.
  2. Provide sealants sufficiently flexible to accommodate movement such as thermal expansion, inter-story differential building sway and other normal building movement without damage to the seal.
  3. Provide perimeter fire containment systems subjected to an air leakage test conducted in accordance with Standard, ANSI/UL2079 with published L-Ratings for ambient and elevated temperatures as evidence of the ability of the fire-resistive joint system to restrict the movement of smoke.
- D. Firestopping products shall have flame spread ratings less than 25 and smoke-developed ratings less than 450, as determined per ASTM E84.
- E. Where there is no specific third-party tested and classified firestop system available for a particular firestop configuration/condition, the firestopping contractor shall obtain from the firestopping material manufacturer an EJ or Equivalent Fire

Resistance Rated Assembly (EFRRA) to be submitted to the approving authority and authority having jurisdiction for approval prior to installation. The EJ shall follow International Firestop Council (IFC) guidelines.

#### 1.06. SUBMITTALS

- A. Provide in accordance with Section 01300, Submittals, and as supplemented herein. Submittals shall include, but not be limited to, the following:
1. Product Data - For each type of firestopping and/or barrier system product selected. Certify that firestopping materials are asbestos free and contain volatile organic compounds within limits of the local jurisdiction and are non-toxic to building occupants.
  2. Design Listings - Submit system design listings, including illustrations, from a qualified testing and inspecting agency that is applicable to each firestop configuration.
  3. Where there is no specific third party tested and classified firestop system available for a particular configuration, the firestopping contractor shall obtain from the firestopping material manufacturer an EJ or EFRRA for submittal.
  4. Qualification Data - For firms and persons specified in Article 1.07 to demonstrate their capabilities and experience. Submit document from manufacturer wherein manufacturer recognizes the installer as qualified.

#### 1.07. QUALITY ASSURANCE

- A. Provide firestopping and/or perimeter barrier system design listings from UL or OPL in accordance with the appropriate ASTM Standard(s) per Article 1.05.
- B. Contractor Qualifications - An acceptable installer shall meet any two of the following requirements:
1. Licensed by state or local authority where applicable.
  2. Trained and approved by the firestop manufacturer.
  3. Shown to have successfully completed not less than five comparable scale projects.
  4. FM approved in accordance with FM Standard 4991, Approval of Firestop Contractors.
  5. UL Qualified Firestop Contractor.
- C. Single Source Limitations - Obtain firestop systems, for each kind of penetration and construction condition indicated from a single manufacturer, where possible.
- D. Materials from different firestop manufacturers shall not be installed in the same firestop system or opening.
- E. Firestopping material shall be asbestos-free and lead-free and shall not incorporate nor require the use of hazardous solvents.



- F. Firestopping sealants must be flexible, allowing for normal movement of adjacent materials.
  - G. Firestopping materials shall not crack or pull back from contact surfaces such that a void is created.
  - H. Firestopping materials shall be moisture resistant, and may not dissolve in water after curing.
  - I. Materials used shall be in accordance with the manufacturer's written installation instructions.
  - J. Label each firestopping system installation with the following information:
    - 1. Firestopping product name.
    - 2. System listing number.
    - 3. Name and address of manufacturer
  - K. Inspection of penetrations through fire rated floor and wall assemblies shall be in accordance with ASTM E2174, Standard Practice for On-Site Inspection of Installed Fire Stops.
  - L. Inspection of fire-resistive joints and perimeter barriers shall be in accordance with ASTM E2393, Standard Practice for On-Site Inspection of Installed Fire Resistive Joint Systems and Perimeter Fire Barriers.
    - 1. Firestopping tests are performed by a qualified, testing and inspection agency. A qualified testing and inspection agency is UL or another agency performing testing and follow-up inspection services for perimeter fire containment systems acceptable to authorities having jurisdiction.
    - 2. Perimeter fire containment system products bear classification marking of qualified testing and inspection agency.
- 1.08. DELIVERY, STORAGE, AND HANDLING
- A. Deliver firestopping products to project site in original, unopened containers or packages with intact and legible manufacturer's labels identifying product and manufacturer, date of manufacture, lot number, UL or OPL classification marking, and mixing instructions for multi-component materials.
  - B. Store and handle materials per manufacturer's instructions to prevent deterioration or damage due to moisture, temperature changes, contaminants, or other causes.
  - C. All firestop materials shall be installed prior to expiration of shelf life.
- 1.09. PROJECT CONDITIONS
- A. Environmental Limitations - Install firestopping when ambient or substrate temperatures are within limits permitted by the manufacturer's written instructions. Do not install firestopping when substrates are wet due to rain, frost, condensation, or other causes.

- B. Ventilate per the manufacturer's written instructions on the product's Material Safety Data Sheet.
- C. Verify the condition of the substrates before starting work.
- D. Care should be taken to ensure that firestopping materials are installed so as not to contaminate adjacent surfaces.

#### 1.10. SEQUENCING

- A. Sequence work to permit installation of materials in conjunction with other materials and seals.

#### 1.11. COORDINATION

- A. Coordinate construction of openings and penetrating items to ensure that firestopping assemblies are installed according to specified requirements.
- B. Coordinate sizing of sleeves, openings, core-drilled holes, or cut openings to accommodate through-penetration firestop systems.
- C. Do not conceal firestopping installations until the Owner's inspection agency or authorities having jurisdiction have examined each installation.
- D. Schedule firestopping after installation of penetrants but prior to concealing the openings.

### PART 2 PRODUCTS

#### 2.01. FIRESTOPPING, GENERAL

- A. Firestopping products specified in system design listings by UL or OPL may be used providing they conform to the construction type, penetrant type, annular space requirements and fire rating involved in each separate assembly.
- B. Manufacturer of firestopping products shall have been successfully producing and supplying these products for a period of not less than three years and be able to show evidence of at least 10 projects where similar products have been installed and accepted.
- C. Accessories - Provide components for each firestop system that are needed to install fill materials and to comply with Article 1.05. Use only components specified by the firestopping manufacturer and approved by UL or OPL for the firestop systems indicated. Accessories include, but are not limited to the following items:
  - 1. Permanent forming/damming/backing materials, including the following:
    - a. Mineral wool insulation.
    - b. Foams or sealants used to prevent leakage of fill materials in liquid state.
    - c. Fire-rated form board.
    - d. Polyethylene/polyurethane backer rod.
    - e. Rigid polystyrene board.

2. Temporary forming materials.
  3. Substrate primers.
  4. Steel sleeves.
- D. All firestopping products and systems shall be designed and installed so that the basic sealing system will allow the full restoration of the fire resistance properties of the barrier being penetrated with minimal repair if penetrants are subsequently removed.

#### 2.02. MIXING

- A. For those products requiring mixing before application, comply with firestopping manufacturer's written instructions for accurate proportioning of materials, water (if required), type of mixing equipment, selection of mixer speeds, mixing containers, mixing time, and other items or procedures needed to produce products of uniform quality with optimum performance characteristics for application indicated.

#### 2.03. MANUFACTURERS

- A. Subject to compliance with the requirements, provide products by one of the following:
1. Grace Construction Products, 62 Whittemore Avenue, Cambridge MA 02140, (866) 333 3726
  2. Specified Technologies, Inc. (STI), Somerville, NJ, (800) 992-1180
  3. 3M Fire Protection Products, St. Paul, MN, (800) 328-1687
  4. Hilti, Inc., Tulsa, OK, (800) 879-8000
  5. Thermafiber, LLC, Wabash, IN
  6. Roxul, Inc., Milton, Ontario, CA
  7. Owens Corning, Toledo, OH
  8. Other manufacturers listed in the UL Fire Resistance Directory, Volume 2
  9. Or equal

#### 2.04. MATERIALS

- A. General - Use only firestopping products that have been tested for specific fire resistance rated construction conditions conforming to construction assembly type, penetrating item type, or joint opening width and movement capabilities, annular space requirements, and fire rating involved for each separate instance.
1. Specific manufacturers' products listed serve as a basis for design. Similar systems by named manufacturers that meet performance criteria of that section are also acceptable.
- B. Intumescent Firestop Sealants and Caulk - Single-component latex formulations that, upon cure, do not re-emulsify during exposure to moisture.

1. Flame Safe FS1900 - Grace Construction Products
- C. Elastomeric Water-Based Sealant - Single-component latex formulations that, upon cure, do not re-emulsify during exposure to moisture.
  1. Flame Safe FS1900, FS900+ - Grace Construction Products
- D. Elastomeric Silicone Sealant (Single-Component) - Moisture curing, single-component, silicone elastomeric sealant for horizontal surfaces (pourable or non-sag) or vertical surfaces (non-sag).
  1. FlameSafe Silicone - Grace Construction Products
- E. Silicone Foam - Multi-component, silicone-based liquid elastomers that, when mixed, expand and cure in place to produce a flexible, non-shrinking foam.
  1. Pensil 200 Silicone Foam - Specified Technologies, Inc.
- F. Firestop Putty and Pads
  1. Putty - Intumescent, non-hardening, water-resistant putties containing no solvents, inorganic fibers, or silicone compounds.
    - a. FlameSafe FSP1000 Putty - Grace Construction Products
  2. Putty Pads - Intumescent, non-hardening pads or inserts for protection of electrical switch and receptacle boxes to reduce horizontal separation to less than 24 inches.
    - a. FlameSafe FSP1077 Putty Pads
- G. Firestop Devices - Factory assembled steel collars lined to fit specific outside diameter of penetrating item.
  1. FlameSafe FSWSD Collar, FSIS Intumescent Sleeve, FlameSafe FSD Device - Grace Construction Products
- H. Wrap Strips - Single-component intumescent strips faced on both sides with plastic film.
  1. FlameSafe FSWS 100 Wrap Strip, FSWS 150 Wrap Strip - Grace Construction Products
- I. Firestop Mortars - Portland cement-based dry mix product formulated for mixing with water at project site to form a non-shrinking, water-resistant, homogeneous mortar.
  1. FlameSafe FSM Mortar - Grace Construction Products
- J. Firestop Bags/Pillows - Re-enterable, non-curing, mineral fiber core encapsulated with an intumescent coating contained in a flame-retardant poly bag.
  1. FlameSafe Bags, FlameSafe Pillows - Grace Construction Products
- K. Elastomeric Coating - A water-based, spray-applied elastomeric coating for joints between fire-resistive assemblies and perimeter barriers that cures to a strong flexible seal, accommodating seismic, wind, and thermal contraction/expansion movement. Used with partially compressed mineral fiber backing.

1. FlameSafe FS3000 - Grace Construction Products
- L. Fire-Rated Cable Pathway - Modular devices composed of steel raceway with intumescent foam pads permitting 0 to 100 percent cable fill.
  1. EZ-Path™ Fire-Rated Pathway - STI
- M. Curtain Wall Insulation - Faced or unfaced batts or blankets used for exterior curtain walls with the capacity to contribute to the fire resistance of the assembly.
  1. Firespan Insulation - Thermafiber, LLC
- N. Safing Insulation - Board or sheet products used as forming materials in slab edge openings with the capacity to provide a degree of the fire resistance required when used with an appropriate fill material.
  1. Type SAF - Thermafiber, LLC.

## PART 3 EXECUTION

### 3.01. EXAMINATION

- A. Examine substrates and conditions for compliance with requirements for opening configurations, penetrating items, substrates, and other conditions affecting performance. Notify Engineer of any unsatisfactory conditions.
- B. Proceed with installation only after unsatisfactory conditions have been corrected.
- C. Verify that all pipes, conduits, cables, and/or other items which penetrate fire-rated construction have been permanently installed prior to installation of firestops.

### 3.02. PREPARATION

- A. Surface Cleaning - Clean out openings immediately before installing firestop systems to comply with written recommendations of firestopping manufacturer and the following requirements:
  1. Remove from surfaces of opening substrates and from penetrating items foreign materials that could interfere with adhesion of firestop systems.
  2. Clean opening substrates and penetrating items to produce clean, sound surfaces capable of developing optimum bond with firestop systems. Remove loose particles remaining from cleaning operation.
  3. Surfaces to which firestop materials will be applied shall be free of dirt, grease, oil, scale, laitance, rust, release agents, water repellents, and any other substances that may inhibit optimum adhesion.
  4. Provide masking and temporary covering to prevent soiling of adjacent surfaces by firestopping materials.

### 3.03. PENETRATION FIRESTOP SYSTEMS

- A. General - Install through-penetration firestop systems to comply with Article 1.05 and firestopping manufacturer's written installation instructions and published drawings for products and applications indicated.
- B. Installation of firestopping shall be performed by an applicator/installer qualified as described in Article 1.07.
- C. Apply firestopping in accordance with UL or OPL listed system designs or manufacturer's EJ per the manufacturer's installation instructions.
- D. Install forming/damming/backing materials and other accessories required to support fill materials during their application and in the position needed to produce cross-sectional shapes and depths required to achieve fire resistance ratings required.
- E. Install fill materials for firestop systems by proven techniques to produce the following results:
  - 1. Fill voids and cavities formed by openings, forming materials, accessories, and penetrating items as required to achieve fire-resistance ratings indicated.
  - 2. Apply materials so they fully contact and adhere to substrates formed by openings and penetrating items.
  - 3. For fill materials that will remain exposed after completing Work, finish to produce smooth, uniform surfaces that are flush with adjoining finishes.

### 3.04. JOINT FIRESTOP SYSTEMS

- A. General - Install fire-resistive joint firestop systems to comply with required codes and ratings and with Article 1.05 and firestopping manufacturer's written installation instructions and published drawings for products and applications indicated.
- B. Installation of firestopping shall be performed by an applicator/installer qualified as described in Article 1.07.
- C. Apply firestopping in accordance with UL or OPL listed system designs or manufacturer's EJ per the manufacturer's installation instructions.
- D. Install joint forming/damming materials and other accessories required to support fill materials during their application and in the position needed to produce cross-sectional shapes and depths of installed firestopping material relative to joint widths that allow optimum movement capability and achieve fire resistance ratings required.
- E. Install fill materials for firestop systems by proven techniques to produce the following results:
  - 1. Fill joint as required to achieve fire-resistance ratings indicated.

2. Apply materials so they fully contact and adhere to substrates forming the openings.
3. Completely fill recesses provided for each joint configuration.
4. Tool non-sag firestop materials after their application and prior to the time skinning begins. Use tooling agents approved by the firestopping manufacturer.

### 3.05. PERIMETER BARRIER FIRESTOP SYSTEMS

- A. General - Install perimeter barrier firestop systems to comply with required codes and ratings and with Article 1.05 and firestopping manufacturer's written installation instructions and published drawings for products and applications indicated.
- B. Installation of firestopping shall be performed by an applicator/installer qualified as described in Article 1.07.
- C. Apply firestopping in accordance with UL or OPL listed system designs or manufacturer's EJ per the manufacturer's installation instructions.
- D. Install metal framing, curtain wall insulation, mechanical attachments, safing materials, and firestop materials as applicable within the system design.

### 3.06. FIELD QUALITY CONTROL

- A. Testing - The Owner will engage a qualified independent inspecting agency to inspect firestop systems, conduct material evaluation and application tests and prepare inspection reports. The Contractor shall cooperate fully and, when requested, permit samples of materials to be taken from original packaging as the materials are applied to building surfaces.
  1. Inspection of completed installations of firestop systems shall take place in successive stages as installation of firestop systems proceeds. Do not proceed with installation of firestop systems for the next area until inspecting agency determines completed work shows compliance with requirements.
  2. Inspection agency shall state in each report whether inspected firestop systems comply with or deviate from requirements.
- B. Cost of Testing - If tests indicate that materials or work does not comply with requirements, the Contractor shall pay for tests performed, all retesting, and shall repair non-complying work. Where repair is not possible the Contractor shall remove and replace the firestop materials.
- C. Proceed with enclosing firestop systems with other construction only after inspection reports are issued and firestop systems comply with requirements.

### 3.07. CLEANING AND PROTECTION

- A. Clean off excess fill materials adjacent to openings as work progresses by methods and with cleaning materials that are approved in writing by firestopping manufacturer(s) and that do not damage materials in which openings occur. Leave

finished work in neat, clean condition with no evidence of spillovers or damage to adjacent surfaces.

- B. Provide final protection and maintain conditions during and after installation that ensure firestop systems are without damage or deterioration at time of Substantial Completion. If, despite such protection, damage or deterioration occurs, cut out and remove damaged or deteriorated firestop systems immediately and install new materials to produce firestop systems complying with specified requirements.

END OF SECTION



## SECTION 07900

### JOINT SEALANTS

#### PART 1 GENERAL

##### 1.01. DESCRIPTION OF WORK

A. Furnish and install joint sealers and accessories in accordance with the Contract Documents including, but not limited to the following:

1. Sealants and caulking for non-submerged uses.
2. Backer rods and accessories

##### 1.02. RELATED SECTIONS

- A. SECTION 03300 – CAST-IN-PLACE CONCRETE
- B. SECTION 06200 – FINISH CARPENTRY AND CUSTOM CASEWORK
- C. SECTION 07190 – VAPOR AND AIR BARRIERS
- D. SECTION 07543 – TPO ROOFING
- E. SECTION 07710 – ROOF SPECIALTIES
- F. SECTION 07840 – PENETRATION FIRESTOPPING
- G. SECTION 08110 – HOLLOW METAL DOORS AND FRAMES
- H. SECTION 08331 – OVERHEAD COILING DOORS
- I. SECTION 08410 – ALUMINUM-FRAMED ENTRANCES AND STOREFRONTS
- J. SECTION 08520 – ALUMINUM WINDOWS
- K. SECTION 08800 – GLAZING
- L. SECTION 09900 – PAINTING
- M. SECTION 10441 –SIGNS

##### 1.03. REFERENCES

- A. ASTM C834 - Standard Specifications for Latex Sealants
- B. ASTM C919 - Standard Practice for Use of Sealants in Acoustical Applications
- C. ASTM C920 - Standard Specification for Elastomeric Joint Sealants
- D. ASTM C1330 - Standard Specification for Cylindrical Sealant Backing for Use with Cold Liquid Applied Sealants
- E. ASTM E1966 – Standard Test Method for Fire-Resistive Joint Systems
- F. ASTM E84 – Standard Test Method for Surface Burning Characteristics of Building Materials

- G. SWRI - Sealant, Waterproofing Restoration Institute. ANSI A117.1 – Specifications for Making Buildings and Facilities Accessible to and Usable by Physically Handicapped People

#### 1.04. SUBMITTALS

- A. Provide in accordance with Section 01300, Submittals, and as supplemented herein. Submittals shall include, but not be limited to, the following:
- B. Manufacturer's Product Data – Manufacturer's literature describing performance characteristics validating product compliance with performance criteria specified and application procedures.
- C. Samples – Submit samples illustrating manufacturer's extended color range.

#### 1.05. QUALITY ASSURANCE

- A. Manufacturer Qualifications - Company regularly engaged in manufacturing and marketing of products specified in this section.
- B. Installer Qualifications - Qualified to perform work specified by reason of experience or training provided by product manufacturer.
- C. Installation per manufacturer's instructions and SWRI.
- D. Perform acoustical sealant application work in accordance with ASTM C919.

#### 1.06. DELIVERY, STORAGE AND HANDLING

- A. Deliver products in original factory packaging bearing identification of product, manufacturer, and batch number. Provide Material Safety Data Sheets for each product.
- B. Store products in a location protected from freezing, damage, construction activity, precipitation, and direct sunlight in strict accordance with manufacturer's recommendations.
- C. Condition products to approximately 60 to 70 degrees F for use in accordance with manufacturer's recommendations.
- D. Handle all products with appropriate precautions and care as stated on Material Safety Data Sheets.
- E. Do not use material that has exceeded manufacturer's shelf life.

#### 1.07. PROJECT CONDITIONS

- A. Do not use products under conditions of precipitation or freezing weather. Use appropriate measures for protection and supplementary heating to ensure proper curing conditions in accordance with manufacturer's recommendations if application during inclement weather occurs.
- B. Ensure substrate is dry.

- C. Protect adjacent work from contamination due to mixing, handling, and application of flexible epoxy joint filler.

1.08. WARRANTY

- A. Include coverage for replacement of sealant materials which fail to achieve watertight seal, exhibit loss of adhesion or cohesion, or do not cure.

1.09. COORDINATION

- A. Coordinate the work of this section with all sections referencing this section or referenced by this section.
- B. Coordinate the work with existing opening construction and door hardware installation.

PART 2 PRODUCTS

2.01. MANUFACTURERS

- A. Provide all joint sealers of the same type from a single manufacturer.
  - 1. Manufacturer - Sika, BASF, Dow Corning, or equal.
- B. Provide USDA and NSF approved sealants when indicated.

2.02. MATERIALS AND MANUFACTURERS

- A. Multi-Component, Non-Sag Polyurethane Sealant - Sika "Sikaflex 2cNS," BASF "Sonolastic NP 2," or equal with +50 percent movement capability for vertical joints; ASTM C920, Type M, Grade NS, Class 25. USDA approved; SWRI validated; UL classified (fire resistance).
- B. Two Component, Self-Leveling Polyurethane Sealant - Sika "Sikaflex 2cSL," BASF "Sonolastic SL 2," or equal with +25 percent movement capability for horizontal joints; ASTM C920, Type M, Grade P, Class 25; USDA approved.
- C. Silicone Sealant - Sika "SikaSil C990 or 995," BASF "OmniPlus or Omniseal," Pecora "864," or equal. ASTM C920, Type S, Grade NS, Class 25 or 50.
- D. Single Component Siliconized Acrylic Latex Sealant – BASF "Sonolac," Bostik "Chem-Calk 600," Pecora "AC 20+ Silicone," or equal with +15 percent movement capability; ASTM C834.
- E. Single Component pre-pressurized expanding polyurethane foam sealant equal to Sika "Sika Boom."
- F. Single Component Spray Applied Elastomeric Sealant – 3M Fire Dam Spray 200, Specified Technologies SpecSeal AS200, Tremco TremStop Acrylic SP; or equal with ±25 percent movement capability; ASTM E84, max flame spread <25, smoke developed <50.

2.03. ACCESSORIES

- A. Low VOC Primer - As recommended by manufacturer for particular sealant and substrate.
- B. Joint Cleaner - Non-corrosive and non-staining type recommended by sealant manufacturer and compatible with joint forming materials.
- C. Soft Backer Rod - Industrial Thermo Polymers Limited "104 Soft-Type Backer Rod," Backer Rod Mfg. Inc. "Denver Foam" or equal; non-gassing, reticulated closed-cell polyethylene rod designed for use with cold-applied joint sealants.
  - 1. Comply with ASTM C1330.
  - 2. Size required for joint design.
- D. Closed-Cell Backer Rod - Industrial Thermo Polymers Limited "101 Standard Backer Rod," Deck-o-Seal "Kool-Rod" or equal closed-cell polyethylene rod designed for use with cold-applied joint sealants for on-grade or below-grade applications.
  - 1. Comply with ASTM C1330.
  - 2. Size required for joint design.
- E. Joint Filler - Canzac "Expansion Joint Filler," Sonneborn(R)/ChemRex "Expansion Joint Filler," or equal closed-cell polyethylene joint filler designed for use in cold joints, construction joints, or isolation joints wider than 1/4 inch (6 mm).
  - 1. Size required for joint design.
- F. Mineral Wool Batt Insulation – Owens Corning Thermafiber Safing or equal, 4.0 pcf, unfaced mineral fiber batts used as forming material for application of single-component spray-applied elastomeric sealant.
  - 1. Size required for joint design.
- G. Bond Breaker - Pressure-sensitive tape recommended by sealant manufacturer to suit application.

#### 2.04. COLOR

- A. Sealant Colors – From manufacturer's extended range of colors. Match to adjacent materials as directed by the Schedule of Joint Sealers at the end of this section.

### PART 3 EXECUTION

#### 3.01. EXAMINATION

- A. Inspect all areas involved in work to establish extent of work, access, and need for protection of surrounding construction.
  - 1. Verify that substrate surfaces and joint openings are ready to receive work.
  - 2. Verify that joint backing and release tapes are compatible with sealant.

#### 3.02. PREPARATION

- A. Remove loose materials and foreign matter which impair adhesion of joint filler.

- B. Clean joints and saw cuts by grinding, sandblasting, or wire brushing to expose a sound surface free of contamination and laitance. Prime joints.
- C. Ensure structurally sound surfaces, dry, clean, free of dirt, moisture, loose particles, oil, grease, asphalt, tar, paint, wax, rust, waterproofing, curing and parting compounds, membrane materials, and other foreign matter.
- D. Where the possibility of joint filler staining of adjacent areas or materials exists, mask joints prior to application.
  - 1. Do not remove masking tape before joints have been tooled and initial cure of joint filler has taken place.
  - 2. Work stained due to failure of proper masking precautions will not be accepted.

### 3.03. INSTALLATION

#### A. Back-Up Material

- 1. Install appropriate size backer rod, larger than joint where necessary according to manufacturer's recommendations.
- 2. Install polyethylene joint filler in joints wider than 1/4 inch (6 mm) to back-up material per manufacturer's recommendations.
- 3. Do not install epoxy joint filler over backer rod.
- 4. Install mineral wool backer material at locations where elastomeric spray applied sealants are scheduled to be used by pressure fitting snugly into joint space.

#### B. Bond Breaker - Install bond-breaker strip in joint to be sealed on top of back-up material to prevent adhesion of sealant to back-up material. Install per manufacturer's recommendations.

#### C. Sealant

- 1. Prepare sealants that require mixing. Follow manufacturer's recommended procedures, mixing thoroughly.
- 2. Mix only as much material as can be applied within manufacturer's recommended application time period.
- 3. Apply materials in accordance with manufacturer's recommendations. Take care to produce beads of proper width and depth, tool as recommended by manufacturer, and immediately remove surplus sealant.
- 4. Apply materials only within manufacturer's specified application life period. Discard sealant after application life is expired or if prescribed application period has elapsed.

### 3.04. CLEANING

- A. Remove uncured sealant and joint filler with sealant manufacturer's recommended solvent. Remove cured sealant and joint filler by razor, scraping, or mechanically.

- B. Remove all debris related to application of sealants from job site in accordance with all applicable regulations for hazardous waste disposal.

### 3.05. SCHEDULE OF JOINT SEALANTS

SEALANT TYPE	LOCATIONS FOR APPLICATION	COLOR	COMMENTS
Multi-component, non-sag polyurethane (UL classified)	Metal or FRP door, window, or louver frames at masonry openings	Match frame color	Prime frame as recommended by sealant manufacturer for particular factory finish
Multi-component, non-sag polyurethane	Vertical control or movement joints in masonry	Match mortar color	
Two-component, self-leveling polyurethane sealant	Control, movement, or perimeter joints in horizontal concrete	Match finished concrete color	
Silicone sealant	Glass at metal	Clear	
Silicone sealant	Plumbing fixtures abutting other materials	Match color of plumbing fixture	
Single-component acrylic latex	Intersections of non-structural interior finish materials	White	Paint to match adjacent material
Polyurethane foam sealant	Gaps at windows, doors, louvers, and other openings	--	--
Elastomeric spray sealant	Gaps at intersections between CMU wall and galvanized metal roof deck	Gray or red (manufacturer's standard)	Back with mineral wool batt insulation

END OF SECTION

**DIVISION 09**

## SECTION 09880

### CONCRETE PROTECTIVE COATING

#### PART 1 GENERAL

##### 1.01 SUMMARY

- A. This specification describes the coating of substrates with a non-vapor barrier, protective waterproofing, polymer-modified, portland cement slurry.
- B. Work under this item shall apply to all existing interior concrete walls to the following tanks during the following Phases:
  - a. Solids Handling Improvements: Sludge Thickeners #1 and #2
  - b. Phase 1 Improvements: Primary Clarifiers #1, #2, and #3, and Chlorine Contact Chamber
  - c. Phase 2 Improvements: Aeration Tank #1, 2, 3, 4, 5, and 6; Final Clarifiers #1, 2, 3, & 4; (Final Clarifiers are part of Additive Alternative #1)
- C. Work paid under this item shall include all tools, labor, equipment, and incidental items associated with application of the concrete protective coating.

##### 1.02 RELATED WORK SPECIFIED ELSEWHERE

- A. Section 03930 - Concrete Rehabilitation
- B. Section 03940 - Crack Repairs by Epoxy Injection.

##### 1.03 QUALITY ASSURANCE

- A. Manufacturing qualifications: The manufacturer of the specified product shall be ISO 9001 certified and have in existence a recognized ongoing quality assurance program independently audited on a regular basis.
- B. Contractor qualifications: Contractor shall be qualified in the field of concrete repair and protection with a successful track record of 5 years or more. Contractor shall maintain qualified personnel who have received product training by manufacturer's representative.
- C. Install materials in accordance with all safety and weather conditions required by manufacturer or as modified by applicable rules and regulations of local, state and federal authorities having jurisdiction. Consult Material Safety Data Sheets for complete handling recommendations.



## 1.05 DELIVERY, STORAGE, AND HANDLING

- A. All materials must be delivered in original, unopened containers with the manufacturer's name, labels, product identification, and batch numbers. Damaged material must be removed from the site immediately.
- B. Store all materials off the ground and protect from rain, freezing or excessive heat until ready for use.
- C. Condition the specified product as recommended by the manufacturer.

## 1.06 PROJECT CONDITIONS

- A. Environmental Conditions: Do not apply material if it is raining or snowing or if such conditions appear to be imminent. Minimum application temperature 40°F (5°C) and rising.
- B. Protection: Precautions should be taken to avoid damage to any surface near the work zone due to mixing and handling of the specified material.

## 1.07 SUBMITTALS

- A. Submit two copies of manufacturer's literature, to include: Product Data Sheets, and appropriate Material Safety Data Sheets (MSDS).
- B. Submit copy of Certificate of Approved Contractor status by manufacturer.

## 1.08 WARRANTY

- A. Provide a written warranty from the manufacturer against defects of materials for a period of one (1) year, beginning with date of substantial completion of the project.

## PART 2 PRODUCTS

### 2.01 MANUFACTURER

- A. Sika Corporation; SikaTop Seal 107 is considered to conform to the requirements of this specification.
- B. Approved equal

### 2.02 MATERIALS

- A. Polymer-modified portland cement coating:
  - 1. Component "A" shall be a liquid polymer emulsion of an acrylic co-polymer base and additives.
  - 2. Component "B" shall be a blend of selected portland cements, specially graded aggregates, and admixtures to control setting time and workability.
  - 3. The ratio of Component A: Component B shall be:

- a. Slurry 1:4 by weight
- b. Mortar 1:4.5 by weight

The material shall be non-combustible, either before or after cure.

2.03 PERFORMANCE CRITERIA

A. Properties of the mixed polymer-modified portland cement coating:

- 1. Pot Life: Approx. 60 minutes at 68F  
Approx. 30 minutes at 86F

- 2. Color: gray or white

B. Properties of the cured polymer-modified portland cement coating:

- 1. Tensile Strength (ASTM C-307) 28 days
  - a. Type White: 870 psi (Min.)
  - b. Type Gray: 990 psi (Min.)
- 2. Bond Strength (ACI 503R-30 Modified): Pull-off test  
28 days: 180 psi (Min.)
- 3. Moisture Vapor permeability (ASTM E96)  
28 days: 18 perms
- 4. Compressive Strength (ASTM D-695) at 28 days
  - a. Type White: 3000 psi (Min.)
  - b. Type Gray 3400 psi (Min.)
- 5. Flexibility (ASTM D522 Modified)  
Approximately 25%
- 6. Carbon Dioxide Diffusion  
Coefficient (uCO2) Approx. 35,000 equivalents to 6inches of concrete
- 7. Watertightness under Hydrostatic Pressure (DIN 1048 Mod.)

Water Pressure		Penetrated Water		Water Absorption	
Feet	(bar)	grains	(grams)	grains	(grams)
				Ft.2 * hours	m2 * hours
16	(0.5)	0	(0)	0	(0)
33	(1)	15	(1)	3	(2)
99	(3)	31	(3)	10	(7)

Rendering mortars absorbing less than 91 grains/ft.<sup>2</sup> \* h (64 grams/m<sup>2</sup> \*h) are considered watertight.

8. The material shall not produce a vapor barrier.
9. The material meets the chemical requirements in accordance with ANSI/NSF Standard 61- potable water approval.
10. The material shall be thermally compatible with portland cement mortar and concrete.

**Note: Tests above were performed with the material and curing conditions @ 71oF – 75oF and 45-55%relative humidity.**

## PART 3 EXECUTION

### 3.01 SURFACE PREPARATION

- A. If substrate contains spalls, cracks, or other forms of concrete deterioration, such areas shall be repaired prior to commencing work under this item. Shallow and deep repairs shall be performed and paid in accordance with Item 03930. Crack repairs shall be performed and paid under Item 03940.
- B. Substrate must be clean, sound, and free of surface contaminants. Remove dust, laitance, grease, oils, curing compounds, form release agents and all foreign particles by mechanical means. An open-textured, sandpaper-like substrate is ideal. Substrate shall be in accordance with ICRI Guideline No. 03732 for coatings and fall within CSP4. All surfaces must be saturated surface dry (SSD), with no standing water at time of application.

### 3.02 MIXING AND APPLICATION

- A. **Mixing:** Under normal circumstances, full quantities of both components are mixed together, a slurry consistency will result. For a trowelable consistency use only 90% of component A. Mix in a clean container by slowly adding the powder component to the liquid component and mixing with a slow speed (400-600rpm) drill and mixing paddle.
- B. **Coating Application:** Apply trowel, notched trowel, stiff bristle brush, or spray equipment. Work material into the prepared substrates, filling all pores and voids.  
  
For brush grade: Apply first coat, with horizontal brush strokes and leave to harden (4 to 8 hours). Apply second coat with vertical brush strokes.  
  
For trowel consistency: Apply the first coat with a notched trowel and leave to harden (4 to 8 hours). Apply the second coat with a flat trowel.  
  
For spray application: Use a hopper gun spray equipment, textured sprayer (e.g. Texspray E110c by Graco), or a rotor/stator pump equipment. Allow the first coat to

harden (4 to 8 hours) prior to the application of the second coat. As soon as the mortar layer starts to set, a uniform surface with a fine sponge or a plastic trowel.

- C. When applying the coating, never stop the application until the entire surface has been coated. Always stop application at an edge, corner, or joint. Never let a previously coated film dry; always coat into a wet film. Always apply the coating at a 45o angle to an edge, corner, or joint.
- D. Adhere to all limitations and cautions for the polymer-modified cement coating in the manufacturer's printed literature.

### 3.04 CLEANING

- A. The uncured polymer-modified portland cement coating can be cleaned from tools with water. The cured polymer-modified portland cement coating can only be removed mechanically.
- B. Leave finished work and work area in a neat, clean condition without evidence of spillovers onto adjacent areas.

END OF SECTION

## SECTION 09900

### PAINTING

#### PART 1 GENERAL

##### 1.01 SECTION INCLUDES

- A. Requirements for preparation and finishing of surfaces to be painted.

##### 1.02 REFERENCES

- A. American Society for Testing and Materials (ASTM).
  - 1. D16, Standard Terminology Relating to Paint, Varnish, Lacquer, and Related Products
- B. Steel Structures Painting Council (SSPC).
  - 1. SP-1, Solvent Cleaning.
  - 2. SP-2, Hand Tool Cleaning.
  - 3. SP-3, Power Tool Cleaning.
  - 4. SP-5, White Metal Blast Cleaning.
  - 5. SP-6, Commercial Blast Cleaning.
  - 6. SP-7, Brush-Off Blast Cleaning.
  - 7. SP-10, Near-White Blast Cleaning
  - 8. SP-13, Surface Prep of Concrete
  - 9. SP-16, Brush-off Blast Cleaning of Non-Ferrous Metals

##### 1.03 DEFINITIONS

- A. In accordance with ASTM-D16.
- B. Wherever the words “solvent cleaning”, “hand tool cleaning”, “wire brushing”, or “blast cleaning”, or words of similar intent are used in these specifications, it shall be understood to refer to the applicable SSPC Specification.
- C. The term “paint” or “coating” as used in this specification includes emulsions, enamels, paints, stains, varnishes, sealers, and other coatings, organic or inorganic, used as prime, intermediate or finish coats.

##### 1.04 SUBMITTALS

- A. Shop Drawings
  - 1. Submit product data and manufacturers application instructions in accordance with SECTION 01300.
- B. Samples
  - 1. Colors as required.

## 1.05 QUALITY ASSURANCE

### A. Qualifications

1. Manufacturer specializing in the production of paint and coatings for 10 years, minimum.
2. Applicator specializing in commercial, industrial and municipal painting for 5 years, minimum.

## 1.06 DELIVERY, STORAGE, AND HANDLING

### A. Packing, Shipping, Handling, and Unloading

1. In accordance with manufacturers recommendations.

### B. Acceptance at Site

1. Products to be delivered to site in sealed, labeled and unopened containers.
2. Labels to include Name, type, code, coverage, surface preparation, drying time, color, clean up procedure, and mixing and reducing instructions.
3. Remove unacceptable products immediately.

### C. Storage and Protection

1. Store materials between minimum ambient temperature of 45 degrees F. and a maximum of 90 degrees F.
2. Storage area to be well ventilated, or as required by manufacturer.

## 1.07 PROJECT/SITE CONDITIONS

### A. Environmental Requirements

1. Provide continuous ventilation and maintain ambient temperature above 45 degrees F., for 24 hours before, during, and 48 hours after application of finishes, unless otherwise required by coating manufacturer.
2. Do not apply coatings when exposed to rain or snow, or when relative humidity is above 50 percent.
3. Minimum application temperature for Latex paints:
  - a. 45 degrees F. for interiors.
  - b. 50 degrees F., for exteriors
4. Minimum application temperatures for other coatings:
  - a. 65 degrees for interior and exterior.
5. Lighting levels to be 80 ft. candles, measured mid height at substrate surface.

## 1.08 MAINTENANCE

### A. Extra Materials

1. Provide 1 gallon each color to Owner.

## PART 2 PRODUCTS

### 2.01 MANUFACTURERS

- A. Paints by the Thnec Company, Kansas City, Missouri have been used as the basis for the paint schedule, other manufactures considered equal:
  - 1. Valspar Coatings,
  - 2. Carboline.
  - 3. or product deemed equivalent by the Engineer.

### 2.02 MATERIALS

- A. Coatings
  - 1. Ready Mixed, except field catalyzed coatings.
  - 2. Process pigments to a soft paste like consistency, capable of being dispersed to a uniform coating.
  - 3. Readily applied by spray or brush.
  - 4. Dry free of streaks or sags.
- B. Accessories
  - 1. Linseed Oil, Shellac, Turpentine, Thinners to be of commercial quality, compatible to coatings used.

### 2.03 COLORS AND FINISHES

- A. Colors selected by the Owner from color chips submitted by the Contractor for review. The selection shall be in the form of a color schedule indicating the colors to be used on the various surfaces. The colors used in the final Work shall match the selected color chips.
- B. In general the finish coat shall be gloss or semi-gloss on metal work and flat finish on masonry, wood and drywall surfaces.

## PART 3 EXECUTION

### 3.01 EXAMINATION

- A. Site Verification of Conditions
  - 1. Verify surfaces are ready to receive work in accordance with manufacturers recommendations.
  - 2. Report conditions which may affect proper application to Engineer.
  - 3. Measure moisture content of substrates.
  - 4. Do not apply coatings when moisture exceeds levels below:
    - a. Plaster and Gypsum wallboards 12 percent.
    - b. Masonry and Concrete 12 percent
    - c. Wood 14 percent

## 3.02 PREPARATION

### A. Protection

1. Protect elements surrounding the Work required by this section from damage or marking.
2. Repair damage to other surfaces caused by Work of this section.
3. Furnish drop cloths, shields, and protective methods to prevent spray or paint spatter from disfiguring other surfaces.

### B. Preparation of surfaces to be coated

1. General
  - a. Remove electrical plates, light fixtures, hardware, and fittings.
  - b. Correct minor defects and clean surfaces.
  - c. Seal marks which may bleed through surface finish.
2. Impervious Surfaces
  - a. Remove mildew by scrubbing with solution of tri-sodium phosphate and bleach.
  - b. Rinse with clean water.
  - c. Allow to dry.
3. Aluminum
  - a. Remove surface contamination by steam or high pressure water.
  - b. Remove oxidation by sanding and solvent washing.
4. Insulated coverings
  - a. Remove dirt, grease, and oil from canvas and cotton.
5. Concrete
  - a. Blast-trak or brush blast.
  - b. Reference SSPC SP #13 Standard.
6. Wood
  - a. Remove dirt, oil, and other soil with scrapers, mineral spirits, and sand paper.
  - b. Sand surfaces exposed to view, and remove all sanding dust.
7. Gypsum board
  - a. Fill minor defects with latex fill.
  - b. Prime repaired areas.
8. Galvanized surfaces
  - a. Remove contamination and oils with solvent wash.
  - b. Reference SSPC SP #16 Standard.
9. Masonry and Concrete
  - a. Allow 28 days curing prior to coating application.
  - b. Remove dirt, loose mortar, scale, salt, alkali powder or other foreign matter.
  - c. Remove oil and grease with solution of tri-sodium phosphate.
  - d. Rinse with water.
  - e. Allow to dry.
  - f. Remove stains caused by weathering of corroding metals with a solution of sodium metasilicate after thoroughly wetting with water.
  - g. Allow to dry.
10. Uncoated steel and iron
  - a. Prepare all ferrous metals per coating manufacturer requirements.
  - B. Spot prime repaired areas.
11. Shop primed steel
  - a. Remove loose primer and rust by sanding or scraping.
  - b. Feather edges to make touch-up patches inconspicuous.
  - c. Clean surfaces per SSPC SP #1 Standard.



- d. Prime bare steel.
- 12. Stainless steel surfaces shall not be painted.

3.03 COATING APPLICATION

A. General

- 1. Apply in accordance with manufacturers recommendations.
- 2. Apply each coat to uniform finish.
- 3. Apply each coat slightly darker than preceding coat, unless instructed otherwise by the Engineer.
- 4. Sand lightly between coats.
- 5. Allow preceding coat to dry prior to application of next coat.
- 6. Prime back surfaces of all woodwork.

3.04 MECHANICAL AND ELECTRICAL EQUIPMENT

A. General

- 1. Paint shop primed equipment with compatible finish coat.
- 2. Remove or mask items not to be painted.
- 3. Prime and finish all associated pipes, and ducts, both insulated and exposed, all hangers, brackets, collars and supports, unless items are pre finished.
- 4. Do not paint identification markings or tags on equipment.
- 5. Paint exposed conduit and piping in finished areas.
- 6. Paint both sides and edges of plywood mounting boards.
- 7. Reinstall all trim, fittings, plates etc. After painting is complete.

B. Color Code

- 1. Piping and equipment in accordance with Article 3.06 of this specification.

C. Identification

- 1. Label piping by contents and arrows indicating direction of flow.
- 2. Labels to be twenty feet (20) apart maximum, and within each space through which pipe line passes.
- 3. Adjacent to each side of walls which pipeline penetrate.
- 4. Adjacent to valves, equipment, and pumps.
- 5. Locate labels where they are unobstructed from view and visible from valves.
- 6. Colors to be white or black as appropriate for the substrate.
- 7. Letters, numbers and flow arrows to be stenciled to pipeline and equipment or die cut from vinyl film as approved by the Engineer.

8. Lettering size as follows:	Pipe Diameter in Inches	Size of Letters in Inches
	3/4 to 1-1/4	1/2
	1-1/2 to 2	3/4
	2-1/2 to 6	1-1/2
	8 to 10	2-1/2
	Over 10	3

D. Metal tags

- 1. Pipelines smaller than 3/4 inches in diameter and for valves, securely fasten brass tags, 2-1/2 inches x 1/2 inches, with etched lettering filled with enamel paint.

3.05 CLEANING

- A. Promptly remove spilled, splashed and/or spattered paint.
- B. Maintain premises free of clutter, tools, equipment and material.
- C. Collect waste cloths and material which may constitute a fire hazard and and remove daily from site.

3.06 COLOR SCHEDULES

A. Architectural

- 1. Chosen by Owner.

B. Piping

- 1. Water lines                      Raw.....Olive Green  
   Settled or Clarified.....Aqua  
   Finished or Potable.....Dark Blue
- 2. Chemical Lines                Chlorine..... Yellow  
   Polymers.....Orange with Green Band  
   Sodium Bisulfite.....Grey  
   Lime Slurry..... Violet
- 3. Waste Lines                    Raw.....Gray  
   Sludge.....Brown
- 4. Miscellaneous                Compressed Air.....Dark Green  
   Fuel Oil.....Red

3.07 EXTERIOR COATING SYSTEM SCHEDULE

A. Miscellaneous Ferrous Metal Items

- 1. Shop surface preparation: SSPC-SP-10, Blast profile 1.5 - 2.5 mils.
- 2. 1<sup>st</sup> coat; (Shop applied)-Tnemec Series 94-H20, DFT 2.5-3.0 mils.
- 3. 2<sup>nd</sup> coat (Field applied)-Tnemec Series V69 Epoxoline, DFT 4.0-6.0 mils.
- 4. 3<sup>rd</sup> coat (Field applied)-Tnemec Series V69 Epoxoline, DFT 4.0 to 6.0 mils.

B. Ferrous Metals Scheduled for Immersion Service

- 1. Shop surface preparation: SSPC-SP-10, Blast profile 1.5 - 2.0 mils.
- 2. 1<sup>st</sup> coat; (Shop applied)-Tnemec V69-1211 Red Primer, DFT 3.0 mils.
- 3. 2<sup>nd</sup> coat (Field applied)-Tnemec 104 H.S. Epoxy, DFT 6.0 to 10.0 mils.  
    Scarify 1<sup>st</sup> coat prior to 2<sup>nd</sup> coat application.
- 4. 3<sup>rd</sup> coat (Field applied)- Tnemec 104 H.S. Epoxy, DFT 6.0 to 10.0 mils.

C. Ferrous Metals Scheduled for Immersion Service in Potable Water, NSF approved

- 1. Surface preparation: SSPC-SP-10, Blast profile 1.5 - 2.0 mils.
- 2. 1<sup>st</sup> coat; (Shop applied)-Tnemec Series 94H20, DFT 2.5 to 3.5 mils.
- 3. 2<sup>nd</sup> coat (Field applied)-Tnemec Series 22 DFT 15.0 mils.
- 4. 3<sup>rd</sup> coat (Field applied)- Tnemec Series 22 White, DFT 15.0 mils.

D. Galvanized Metal

- 1. Surface preparation: SSPC SP #16 Standard.

2. 1<sup>st</sup> coat: V69 Epoxoline, DFT 2.0 to 4.0 mils.
  3. 2<sup>nd</sup> coat: 1095 Endurashield, DFT 1.5 to 3.0 mils.
- E. Concrete, and Concrete Block Masonry (New)
1. 1<sup>st</sup> coat: Tnemec Series 180 Tneme-Crete WB, DFT 8.0 mils.
  2. 2<sup>nd</sup> coat: Tnemec Series 180 Tneme-Crete WB, DFT 8.0 mils.
- F. Concrete, and Concrete Block Masonry (New), (Clear finish)
1. 1<sup>st</sup> coat: Tnemec Prime-A-Pell H20.
  2. 2<sup>nd</sup> coat: Tnemec Prime-A-Pell H20.
- G. Asphalt
1. 1 coat Traffic Marking Paint.

### 3.08 INTERIOR COATING SYSTEM SCHEDULE

- A. Concrete Block
1. 1<sup>st</sup> coat: Tnemec 130-6602 Spray then back roll.
  2. 2<sup>nd</sup> coat: Tnemec V69 Epoxoline, DFT 6.0 mils.
  3. 3<sup>rd</sup> coat: Tnemec V69 Epoxoline, DFT 6.0 mils.
- B. Concrete Walls and Ceilings
1. 1st coat: Tnemec V69 Epoxoline, DFT 6.0 mils.
  2. 2nd coat: Tnemec V69 Epoxoline, DFT 6.0 mils.
- C. Drywall
1. 1<sup>st</sup> coat: Tnemec 151 Elasto-Grip Sealer
  2. 2<sup>nd</sup> coat: Tnemec Series 1029 Enduratone.
  3. 3<sup>rd</sup> coat: Tnemec Series 1029 Enduratone.
- D. Wood (to be painted)
1. 1<sup>st</sup> coat: Tnemec 151 Elasto-Grip.
  2. 2<sup>nd</sup> coat: Tnemec Series 1029 Enduratone.
  3. 3<sup>rd</sup> coat: Tnemec Series 1029 Enduratone.
- E. Metals, Structural Steel, Piping, Railways, Equipment, ect.
1. Shop surface preparation: SSPC-SP-6, Blast profile 1.5 - 2.0 mils.
  2. 1<sup>st</sup> coat; (Shop applied)-Tnemec 1 Omnithane, DFT 3.0 mils.
  3. 2<sup>nd</sup> coat (Field applied)-Tnemec Series N69 Epoxoline, DFT 3.0 to 4.0 mils.
  4. 3rd coat (Field applied)-Tnemec Series 1095 Endura Shield, DFT 1.5 to 2.5 mils.
- F. PVC Piping
1. Surface preparation: Scarify prior to coating.
  2. 1st coat: Tnemec Series N69 Epoxoline, DFT 1.5 to 2.0 mils.
  3. 2<sup>nd</sup> coat: Tnemec Series N69 Epoxoline, DFT 1.5 to 2.0 mils.
- G. Non-ferrous Metals (Galvanized, Copper, ect.)
1. Surface preparation: Per SSPC SP #16 Standard.
  2. 1<sup>st</sup> coat: Tnemec N69 Epoxoline, DFT 1.5 to 3.0 mils.
  3. 2<sup>nd</sup> coat: Tnemec 1095 Endurashield, DFT 2.0 to 3.0 mils.

H. Canvas and Cotton Insulation Coverings.

1. 1<sup>st</sup> coat: Tnemec 151 Elasto-Grip.
2. 2<sup>nd</sup> coat: Tnemec Series 1026 Enduratone.
3. 3<sup>rd</sup> coat: Tnemec Series 1026 Enduratone.

I. Interior concrete tanks in contact with potable water.

1. Surface preparation: SSPC-SP-13, with ICRI CSP #4
2. 1<sup>st</sup> coat: Surface entire concrete with Tnemec 217 or 218 Surfacer.
3. 2<sup>nd</sup> coat: Tnemec Series 22 Epoxoline white, DFT 25.0-35.0 mils.

3.09 CHEMICAL MIXING, FEED AND STORAGE AREA

A. Concrete Containment walls, tank pads and floors.

1. Surface preparation: SSPC-SP-13, with ICRI CSP #4
2. 1<sup>st</sup> coat: Fill large voids with Tnemec 215 Filler/Surfacer.
3. 2<sup>nd</sup> coat: Prime all surfaces with Tnemec Series 201 Epoxoline, DFT 6.0-8.0.
4. 3<sup>rd</sup> coat: Tnemec Series 282 Tneme-Glaze Gray DFT 8.0-10.0.
5. 4<sup>th</sup> coat: Tnemec Series 282 Tneme-Glaze Gray DFT 8.0-10.0.

Note: Detail all cracks per Tnemec Stratashield Detail requirements.

3.10 PIPING COATING SYSTEM SCHEDULE

A. Ductile Iron

1. Surface preparation: Per DIPRA DIP Standard.
2. 1<sup>st</sup> coat: (Shop Applied) Tnemec Series 1 Omnithane, DFT. 3.0 mils.
3. 2<sup>nd</sup> coat: (Field Applied) Tnemec V69 Color, DFT 4.0 mils.
4. 3<sup>rd</sup> coat (Field Applied) Tnemec Series V69 Color DFT 4.0 mils.

B. PVC

1. Surface preparation: Lightly sand to de-gloss finish
2. 1<sup>st</sup> coat: Tnemec series V69, Hi-Build Epoxoline, DFT 4.0 to 6.0 mils.

C. Carbon Steel

1. Surface preparation: Immersion Service- SSPC-SP-10.
2. 1<sup>st</sup> coat: (Shop Applied) Tnemec Series 1 Omnithane, DFT. 3.0 mils.
3. 2<sup>nd</sup> coat: (Field Applied) Tnemec V69, Color, DFT 4.0 mils.
4. 3<sup>rd</sup> coat (Field Applied) Tnemec Series V69 Color DFT 4.0 mils.

END OF SECTION

## SECTION 09920

### NON-SLIP EPOXY COATING

#### PART 1 GENERAL

##### 1.01. DESCRIPTION OF WORK

- A. Furnish and install a multi-coat seamless flooring system and all required accessories. The system is to be applied to new concrete slabs on grade in locations per Room Finish Schedule. The system includes, but is not limited to the following:
  - 1. Moisture vapor transmission testing. Corrective treatment if required to create proper application conditions.
  - 2. Surface preparation and cleaning, including abrasive blasting.
  - 3. VOC compliant epoxy primer and sealer.
  - 4. VOC compliant polyaspartic or polyamine epoxy top coating, applied in two coats, with embedded broadcast silica sand to achieve a slip-resistant surface.
  - 5. VOC compliant aliphatic urethane top coat in areas of two colors.
  - 6. Graphics, including stripes and lettering, of the same urethane material as the top coats, in a third and contrasting color, applied to the topcoat.
  - 7. Joint treatments at control joints, floor/wall intersections and other interruptions in slab surface.
- B. Mock-up location shall be of size and complexity as directed in Article 1.04 of this section.

##### 1.02. RELATED SECTIONS

- A. SECTION 03300 - CAST-IN-PLACE CONCRETE
- B. SECTION 04810 – UNIT MASONRY ASSEMBLIES
- C. SECTION 07900 – JOINT SEALANTS
- D. SECTION 09900 – PAINTING
- E. DIVISION 15

##### 1.03. REFERENCES

- A. ASTM D4258 – Standard Practice for Surface Cleaning Concrete for Coating
- B. ASTM D4259 – Standard Practice for Abrading Concrete
- C. ASTM D4263 – Standard Test Method for Indicating Moisture in Concrete by the Plastic Sheet Method
- D. ASTM E84 – Standard Test Method for Surface Burning Characteristics of Building Materials

- E. ASTM F1679 – Standard Test Method for Using a Variable Incidence Tribometer (VIT)
- F. ASTM F1869 – Standard Test Method for Measuring Moisture Vapor Emission Rate of Concrete Subfloor Using Anhydrous Calcium Chloride
- G. ASTM F2170 – Standard Test Method for Determining Relative Humidity in Concrete Floor Slabs Using in situ Probes
- H. NFPA 253 - Standard Method of Test for Critical Radiant Flux of Floor Covering Systems Using a Radiant Heat Energy Source
- I. SSPC-SP13/NACE 6 - Concrete

#### 1.04. SUBMITTALS

- A. Initial Submittal – Provide all initial submittal information concurrently under a single submittal number, and in accordance with Section 01300, Submittals. Submittals shall include, but not be limited to, the following:
  - 1. Product Data - Provide data on specified products, including test results demonstrating compliance with specified requirements. Include product literature for all accessory materials.
  - 2. Color Chart - Submit color charts showing the manufacturer's full range of available colors for top coat materials.
  - 3. Manufacturer's Installation Instructions - Indicate special procedures if required for this specific installation.
  - 4. Shop Drawings – Provide large scale details showing control joints, expansion joints, terminations at floor drains, transitions to adjacent floor materials, and cove base details for floating slabs at exterior frost walls and for slabs passing under steel stud framed walls with gypsum wallboard. Show specific details of adjacent construction for this project.
  - 5. Maintenance Data - Include maintenance procedures, recommended maintenance materials, procedures for stain removal, repairing surface, and suggested schedule for cleaning.
  - 6. Installer's Qualifications – Provide a letter from the finish system manufacturer verifying that the installing Contractor's personnel have been trained by the manufacturer in the installation of the specified system, or a system with similar installation requirements; and stating the manufacturer's approval of the installing Contractor for this work.
- B. Preconstruction Submittals – After approval of the specified products and selection of colors; provide the following submittals:
  - 1. Floor Finish and Graphics Mock-Up – To demonstrate workmanship and uniformity of coating thickness, install entire system, including color changes and stripes, to the floor as directed by the Engineer. Apply the field color for a distance of 4 feet out from the west, north and east walls of the room; and the walkway color in the remaining center area up to the edge of the slab under the

door threshold. Add a 6-inch wide stripe in the contrasting graphics color centered over the boundary between field and walkway colors. Stencil two lines of 6-inch tall letters, centered in the walkway area with the bottom edge of lettering parallel to the door threshold. The top line is to read “WALKWAY;” the bottom line is to read “DO NOT OBSTRUCT.”

If the mock-up work is sufficiently uniform and precise to satisfy the Engineer; it may remain part of the work. If not satisfactory, the finish in this area must be partially or wholly removed and reinstalled until it provides a satisfactory example of the standard expected for the locations scheduled to receive this finish.

2. Slabs scheduled to receive the epoxy floor finish are to be tested for humidity within the slab and moisture vapor transmission. After the building has been fully enclosed and HVAC systems have been in operation at occupied settings for a minimum of seven days; and prior to abrasive blasting and cleaning; humidity and moisture vapor transmission tests are to be taken. Data for ASTM D4263, ASTM F1869, and ASTM F2170 tests are to be recorded and copies submitted to the floor finish manufacturer’s representative and to the Engineer.
3. Letter from the floor finish manufacturer’s representative stating that s/he has reviewed the humidity and moisture vapor transmission reports, and has inspected the surface preparation for the floor finish, and certifies that these reports and observations indicate conditions that are compliant with the manufacturer’s recommended conditions.

#### 1.05. QUALIFICATIONS

- A. Manufacturer’s Representative – Individual qualified to inspect surface preparation conditions and assess the suitability of environmental conditions for successful application of the specified system. The individual must also be empowered to approve the granting of a warranty for the completed work.

#### 1.06. REGULATORY REQUIREMENTS

- A. Floor finish shall be classified under NFPA 253 as either Class I or Class II.
- B. Conform to COMAR 26.11.33 including the VOC content limits listed under 26.11.33.05.

#### 1.07. DELIVERY, STORAGE, AND HANDLING

- A. Store finish component materials in a dry, secure area.
- B. Maintain a minimum temperature of 55 degrees F.
- C. Store materials for three days prior to installation in area of installation to achieve temperature stability.

1.08. ENVIRONMENTAL REQUIREMENTS

- A. Do not install finish system unless substrate surface temperature, substrate moisture content, and air temperature and humidity are all within the recommended ranges specified by the system manufacturer.
- B. Maintain curing conditions as recommended by the system manufacturer.

1.09. WARRANTY

- A. Provide one-year warranty.
- B. Warranty - Include coverage against flooring delamination from substrate and degradation of surface finish.

1.10. EXTRA MATERIALS

- A. Provide 2 gallons of flooring material of each color selected.

PART 2 PRODUCTS

2.01. MANUFACTURERS

- A. Entire system is to be supplied by a single manufacturer.
- B. Acceptable manufacturers:
  - 1. Carboline Company, St. Louis, MO
  - 2. Tnemec Company Incorporated, Kansas City, MO
  - 3. Blome International, O'Fallon, MO
  - 4. Other manufacturer with product of same generic type and equal performance, as determined by Engineer

2.02. SYSTEMS

- A. Power-Tread Series 237 by Tnemec, consisting of:
  - 1. Primer – Surfacing Epoxy Series 215 – Modified Polyamine Epoxy filler and primer
  - 2. Power-Tread Series 237 Base Coat – Modified polyamine epoxy
  - 3. Silica Aggregate – Applied between base and intermediate coats to attain a slip-resistant texture to the floor finish
  - 4. Power-Tread Series 237 Intermediate Coat – Modified polyamine epoxy
  - 5. Everthane Series 248 – Aliphatic moisture cured urethane, applied in two colors: one designated as the “field” color; the other designated as the “walkway” color.
  - 6. Everthane Series 248 – Aliphatic moisture cured urethane, applied in a third, contrasting color for stripe and letter graphics.



- B. Sanitile 985 PA by Carboline, consisting of:
  - 1. Primer – Carboguard 1340 WB waterborne epoxy filler and primer
  - 2. Sanitile 985 PA Base Coat – High-solids polyaspartic
  - 3. Silica Aggregate – Applied between base and intermediate coats to attain a slip-resistant texture to the floor finish
  - 4. Sanitile 985 PA Intermediate Coat – High-solids polyaspartic
  - 5. Carbothane 134 VOC – Aliphatic acrylic polyurethane, applied in two colors: one designated as the field color; the other designated as the walkway color.
  - 6. Carbothane 134 VOC – Aliphatic acrylic polyurethane, applied in a third, contrasting color for stripe and letter graphics.
- C. System by another manufacturer that:
  - 1. Is of the same generic type.
  - 2. Conforms to the performance requirements of this section.
  - 3. Is approved by the Engineer as an equal.

#### 2.03. ACCESSORIES

- A. Vapor Blocking Mortar or Liquid Vapor Retarder
  - 1. To be used only if required to meet the installation requirements for humidity and moisture vapor transmission of the substrate.
  - 2. Type recommended by the finish system manufacturer for the particular project conditions.
- B. Installation Accessories for Control Joints, Movement Joints and Cove Base
  - 1. As recommended by the system manufacturer and shown on approved shop drawings.
  - 2. Include as needed: joint sealants, compressible backers, reinforcing fabrics and edge termination sealants or trim.
  - 3. Special installation tools recommended by the system manufacturer.

#### 2.04. COLORS

- A. Primer – Manufacturer’s standard color.
- B. Base Coat or Undercoat – Light, neutral color that contrasts with top or sealer coat so that coverage may be visually verified.
- C. Top Coat
  - 1. Field Area – Medium gray such as Carboline Sanitile 985 PA color C703.
  - 2. Walkway Area – Medium red such as Carboline Sanitile 985 PA color 0516.
  - 3. Stripes and Lettering – Light color that contrasts with Field and Walkway colors, such as Carboline Sanitile 985 PA color 9225.

## 2.05. BASE

- A. Primer – Manufacturer’s standard color.
- B. Base Coat or Undercoat – Light, neutral color that contrasts with top or sealer coat so that coverage may be visually verified.
- C. Base Details
  - 1. Cant cove where floor slab abuts or passes under concrete block or drywall partitions, 6 inches tall.
  - 2. Compatible urethane sealant over compressible filler where floating slab terminates adjacent to exterior walls.

## PART 3 EXECUTION

### 3.01. EXAMINATION

- A. Verify that surfaces are smooth and flat with maximum variation of 1/4 inch in 10 feet and are ready to receive work.
- B. Verify concrete floors have cured a minimum 28 days, meet manufacturer’s recommendations for humidity and moisture vapor transmission, and exhibit negative alkalinity, carbonization, or dusting.
- C. If moisture testing exceeds manufacturer’s limits, install manufacturer approved vapor barrier such as vapor blocking mortar. Verify that slabs with barrier meet manufacturer’s recommended limits.
- D. Verify floor is free of substances that may impair adhesion of new adhesive and finish materials.

### 3.02. PREPARATION

- A. Remove sub-floor ridges and bumps. Fill low spots, cracks, joints, holes, and other defects with sub-floor filler.
- B. Shot blast or mechanically abrade (scarify) to remove laitance, curing compounds, sealers, and other contaminants, and provide required surface profile per flooring manufacturer.
- C. Vacuum clean substrate.
- D. Conformance to ASTM D4258 and ASTM D4259, or SSPC-SP13/NACE 6, is the minimum acceptable level of preparation.

### 3.03. INSTALLATION - FLOORING

- A. Before starting installation: verify that substrate temperature, air temperature and relative humidity are within the manufacturer’s recommended ranges and will remain stable during curing times.
- B. Apply each layer of the system in accordance with manufacturer's instructions.
- C. Apply each layer at the upper end of the manufacturer’s recommended thickness.

- D. Broadcast silica or quartz aggregate at layer in system as recommended by the manufacturer to achieve the required slip resistance.
- E. Sequence the installation of joint and base accessories as recommended by the system manufacturer to achieve the details shown by approved shop drawings.
- F. Install stripes and lettering of top coat materials where shown on drawings and as directed by Engineer.

3.04. PROTECTION OF FINISHED WORK

- A. Prohibit traffic on floor finish for 48 hours after installation.
- B. Barricade area to permit uninterrupted curing.
- C. Install base divider strips at all boundaries between sections of finish installed at different times.

END OF SECTION

## **DIVISION 10**

## SECTION 10441

### SIGNS

#### PART 1 GENERAL

##### 1.01. SECTION INCLUDES

- A. Interior and exterior wall-mounted fiberglass signs.
- B. Exterior wall-mounted or post-mounted parking space designation aluminum signs.
- C. Safety warning signs.
- D. Instructional signs.

##### 1.02. SUBMITTALS

- A. Submit under provisions of Section 01300, Submittals.
- B. Manufacturer's Data - Submit descriptive literature and specifications, including color chart.
- C. Submit shop drawings depicting sign styles, lettering font, foreground and background colors, locations above finished floor and adjacent to doors, a list of all signs to be provided indicating sign location and text, and overall dimension of each sign and method of attachment.
- D. Submit manufacturer's standard warranty information.

##### 1.03. REGULATORY REQUIREMENTS

- A. Wall-mounted signs shall conform to ICC/ANSI A 117.1 – 2003 - Accessible and Usable Buildings and Facilities.
- B. Exterior wall-mounted or post-mounted signs designating accessible parking spaces shall conform to ICC/ANSI A 117.1 – 2003 - Accessible and Usable Buildings and Facilities, and shall also conform to the applicable sections of Chapter 11 of the 2009 IBC.

##### 1.04. DELIVERY, STORAGE, AND HANDLING

- A. Deliver products to site in accordance with Section 01600, Materials and Equipment.
- B. Store and protect products in accordance with Section 01600, Materials and Equipment.
- C. Sign packages shall have exterior labels indicating the name of the building or buildings where they are to be installed.
- D. Store adhesive or tape materials at temperatures within the manufacturer's recommended installation temperature range.

##### 1.05. ENVIRONMENTAL REQUIREMENTS

- A. For mounting methods utilizing adhesive or tape materials: do not install signs when ambient temperature is below 70 degrees F. Maintain this minimum during and after installation of signs.

## PART 2 PRODUCTS

### 2.01. MANUFACTURERS

#### A. For Interior and Exterior Wall-Mounted Fiberglass Signs

1. Best Sign Systems, Inc., Montrose, CO.  
[www.bestsigns.com](http://www.bestsigns.com)  
(800) 235-2378
2. Apco Signs, Atlanta, GA.  
[www.apcosigns.com](http://www.apcosigns.com)  
(877) 988-2726
3. Gemini Incorporated  
[www.geminisignproducts.com](http://www.geminisignproducts.com)  
(800) 538-8377
4. ACE Sign Systems, Inc.  
[www.Acesign.com](http://www.Acesign.com)  
(765) 288-1000

5. Or equal.

#### B. Exterior Post-Mounted Signs

1. Emed Co. Inc., Chicago, IL.  
[www.emedco.com](http://www.emedco.com) (800) 442-3633
2. Brimar Industries, Inc, Garfield, NJ  
[www.safetysign.com](http://www.safetysign.com) (800) 274-6271
3. Gemini Incorporated  
[www.geminisignproducts.com](http://www.geminisignproducts.com)  
(800) 538-8377

4. Or equal.

#### C. Safety Warning Signs

1. Seton Identification Products, Branford, CT.  
[www.seton.com](http://www.seton.com) (800) 571-2596
2. Emed Co. Inc., Chicago, IL.  
[www.emedco.com](http://www.emedco.com) (800) 442-3633
3. [www.SafetySigns.com](http://www.SafetySigns.com)  
(800) 274-6271

4. Or equal.

D. Instructional Signs - Interior and exterior wall-mounted fiberglass signs.

1. Best Sign Systems, Inc., Montrose, CO.  
[www.bestsigns.com](http://www.bestsigns.com) (800) 235-2378

2. Apco Signs, Atlanta, GA.  
[www.apcosigns.com](http://www.apcosigns.com) (877)988-2726

3. ACE Sign Systems, Inc.  
[www.Acesign.com](http://www.Acesign.com)  
(765) 288-1000

4. Or equal.

2.02. SIGNS

A. Interior Room Designation Signs

1. Etched fiberglass with non-glare, UV-resistant painted surface.
2. Base material thickness to be 0.125 inch.
3. Minimum Width - 10 inches; minimum height: 3 inches.
4. Room name lettering and Braille as required by ICC/ANSI A 117.1 – 2003.
5. Raised white letters on black background.
6. Vinyl foam tape mounting.
7. Best Sign Systems HC300, equal series by Apco Signs, or equal.

B. Exterior Room Designation Signs

1. Etched fiberglass with non-glare, UV-resistant painted surface.
2. Base material thickness to be 0.25 inch.
3. Minimum Width - 10 inches; minimum height: 3 inches.
4. Room name lettering and Braille as required by ICC/ANSI A 117.1 – 2003.
5. Raised white letters on black background.
6. Mounting by countersunk stainless steel screws in pre-drilled holes with expansion sleeves. Plastic spacing sleeves behind signs as required to attain plum and true alignment.
7. Best Sign Systems HC300, equal series by Apco Signs, or equal.

C. Exterior Wall-Mounted or Post-Mounted Parking Space Designation Aluminum Signs

1. Sign Material - Non-reflective aluminum.
  2. Duroshield Tedlar top coat.
  3. Handicapped Parking Space Designation Signs
    - a. Text and graphics shall be as required by the referenced regulatory requirements, with the International Symbol of Accessibility.
    - b. Width 12 inches; height 24 inches.
    - c. Emed Co. Item Number 30840, equal by Brimar Industries, Inc., or equal.
    - d. White lettering against a blue background.
- D. Mounting Posts for Exterior Signs
1. Hot-dipped G90 galvanized steel U-channel.
  2. Stainless steel bolts for attaching the sign.
  3. Minimum Length - Size so that the bottom edge of the sign is 5 feet minimum above the adjacent pavement or walking surface.
  4. Minimum Post Embedment - 3 feet.
- E. Safety Warning Signs/Equipment Signs
1. Where self-adhesive application is possible: flexible vinyl with a clear polyester coating or high-performance polyester.
  2. Where it is necessary to mount the sign on railings or other framework near the hazard: 0.063-inch aluminum secured with stainless steel U-bolts or other appropriate stainless steel fasteners.
  3. Rectangular signs are to be a minimum size of 10 inches wide by 7 inches high.
  4. Chemical hazard diamonds are to be vinyl decals or rigid plastic depending on mounting conditions. 11 inches by 11 inches minimum size, with hazard numbers intended for use on the sign material. Signs shall be supplied by manufacturer of chemical.
- F. Interior and Exterior Instructional Signs
1. Etched fiberglass with non-glare, UV-resistant painted surface.
  2. Base material thickness to be 0.25 inch.
  3. Minimum width 10 inches; minimum height 3 inches.
  4. Room name lettering and Braille as required by ICC/ANSI A 117.1 – 2003.
  5. Raised white letters on black background.



6. Mounting by countersunk stainless steel screws in pre-drilled holes with expansion sleeves. Plastic spacing sleeves behind signs as required to attain plumb and true alignment.
7. Best Sign Systems HC300, equal product by Apco Signs, or equal.

## PART 3 EXECUTION

### 3.01. EXAMINATION

- A. Verify that surfaces are ready to receive work.
- B. Beginning installation means installer accepts existing surfaces.

### 3.02. INSTALLATION

- A. Install in accordance with manufacturer's instructions.
- B. Install signs after doors and surfaces are finished.
- C. Room identification signs shall be mounted:
  1. So that the baseline of characters shall be no less than 48 inches above, and no more than 60 inches above, the adjacent floor or ground surface.
  2. Outside the room on the wall next to the door on the latch side. For double doors, the sign shall be mounted to the right of the right-hand door.
  3. Where there is no wall space on the latch side of a single door, or to the right side of double doors, signs shall be mounted on the nearest adjacent wall.
  4. If wall space is not available in any of the locations designated in Items 1 through 3 above, signs may be mounted on the push side of doors provided that the doors are equipped with closers but do not have hold-open devices.
  5. The same location specifications apply to signs associated with doors whether at the interior or at the exterior of buildings.
- D. Parking space designation signs shall be either wall or post mounted so that the bottom edge of the sign is 5 feet above the adjacent walking surface or pavement.
- E. Safety warning signs shall be mounted so as to be clearly visible to the person approaching the equipment or area referenced by the sign. Sign locations shall be in compliance with OSHA regulations. Where possible, signs are to be mounted directly on the tanks, cabinets, or equipment referenced by the safety message. Coordinate mounting locations with Engineer.
- F. Instructional signs shall be mounted:
  1. So that the baseline of characters shall be no less than 48 inches above, and no more than 60 inches above, the adjacent floor or ground surface.
  2. Outside and the room on the wall next to the operating hardware of the overhead door.

### 3.03. REQUIRED SIGNS

A. Room Designation Signs - Provide sign with room name on doorway or entrance to each room of each building. Room names are shown on the Drawings. Exterior doors are also to be labeled, on the exterior side of the wall, with the name of the room to which the door gives access.

B. Parking Space Designation Signs

1. Handicapped Parking Sign – Mount as designated by the Engineer. The bottom edge of the sign is to be positioned 5 feet above the pavement surface. One sign is required.

C. Provide red “NON-POTABLE WATER - DO NOT DRINK” safety signs at the following locations:

1. Hose bibbs.

2. Yard hydrants.

3. Chemical systems.

4. All other locations providing non-potable (plant water) or plant effluent water sources.

D. Provide “LIFTING CAPACITY \_\_\_\* TON”; red safety signs for all lifting monorails, and beams that are intended for lifting.

\*Insert capacity. The asterisk in the preceding text shall be replaced by the lifting beam capacity shown on the structural drawings, or the lifting capacity stated in the approved submittal for monorails, as applicable.

E. Tank and Channel Designation Signs – Provide sign with tank or channel name; handrail-mounted at every access point to the tank (stairway, platform, etc.). For tanks located at grade, provide one handrail mounted tank designation sign. Tanks to be identified shall include, but are not limited to:

1. Final Clarifiers #1-#4

2. Biological Treatment Reactor

3. Secondary Anoxic Tanks #1 and #2

4. Reaeration Tanks #1 and #2

F. Vault Designation Signs - Provide name of each vault engraved in the access hatch to the vault.

G. Equipment Designation Signs - Provide wall- or handrail-mounted equipment designation sign adjacent to each major equipment item, gate control or valve control shown on Drawings. Sign shall have full name of equipment and equipment I.D. both stated (i.e., Sludge Holding Tank Blower No. 1: WSB-451).

- H. Provide “CAUTION - EQUIPMENT STARTS AUTOMATICALLY” red safety signs at the following equipment:
  - 1. Submersible mixers.
  - 2. Process pumps.
  - 3. Chemical feed pumps.
  - 4. Motor-operated slide and gates.
- I. Provide “SAFETY GLASSES REQUIRED” safety signs at the following locations:
  - 1. All chemical feed areas.
- J. Provide “NO SMOKING” signs inside all entrances to the following buildings:
  - 1. Control Building.
  - 2. Disinfection Chemical Building.
- K. Provide red “CONFINED SPACE” sign with wording required by OSHA at appropriate locations.
- L. Emergency Safety Shower/Eyewash – Provide OSHA approved identification sign at each unit.
- M. Fire Extinguisher – Provide identifying sign at each unit.
- N. Chemical Health Hazard Designation Signs - Provide colored signs with chemical name, concentration, and four-component NFPA rating system at each chemical storage and fill station area. Signs shall also be at each access to the room or area and at each exterior wall with a means of access to the building per NFPA 704.4.3.

(continued)

3.04. FIGURES

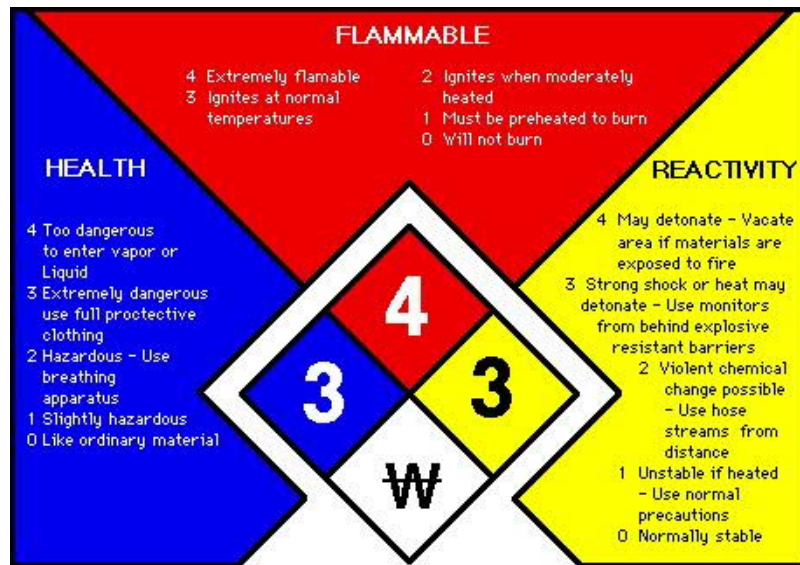
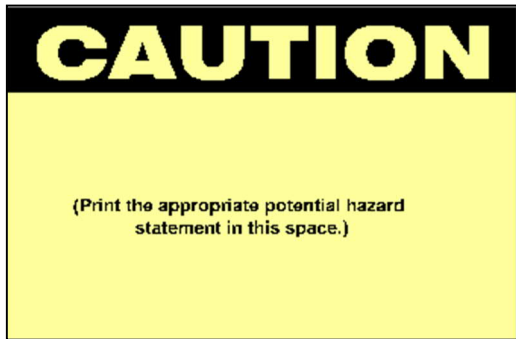

END OF SECTION

## **DIVISION 11**

## SECTION 11100

### AUTOMATED ALGAE SWEEPING SYSTEM (BID PACKAGE #1 ADDITIVE ALTERNATIVE #1)

#### PART 1 GENERAL

##### 1.01 SECTION INCLUDES

- A. This specification covers an automated algae sweeping system for cleaning algae and debris from the baffle, weir, spillway and effluent launder for each of the four (4) final clarifiers, as shown on the contract drawings.
- B. **Items in this specification section are subject to the American Iron and Steel requirements of P.L. 113-76, the Consolidated Appropriations Act of 2014.**

##### 1.02 RELATED SECTIONS

- A. SECTION 01300 – SUBMITTALS
- B. SECTION 01631 – USE OF OTHER THAN FIRST NAMED MANUFACTURERS
- C. SECTION 01665 – SERVICES OF MANUFACTURER’S REPRESENTATIVE
- D. SECTION 01680 – EQUIPMENT AND SYSTEM CHECKOUT, CERTIFICATION, AND TESTING
- E. SECTION 01730 – OPERATION AND MAINTENANCE MANUALS
- F. SECTION 01740 – WARRANTIES
- G. SECTION 11327 – FINAL CLARIFIER EQUIPMENT

##### 1.03 MANUFACTURER’S QUALIFICATIONS

- A. The manufacturer shall have a minimum of 500 automated brush systems (of their own units) in operation in the USA. A history of successful installations with contact names and phone numbers must be included and contacted for confirmation before approval.

##### 1.04 SUBMITTALS

- A. Shop Drawings in accordance with specification Section 01300.
- B. **Certification of compliance with the American Iron and Steel requirements of P.L. 113-76, the Consolidated Appropriations Act of 2014, is required with all submittals.**
- C. Operation and Maintenance Manual in accordance with specification Section 01730.

## PART 2 PRODUCTS

### 2.01 MANUFACTURERS

- A. Ford Hall Company, Inc. Richmond, KY
- B. Approved equal.
- C. Should equipment which differs from the first named in this Section be offered and determined to be the equal of that specified, such equipment shall be acceptable only on the basis that any revision in the design and/or construction of the structure, piping, appurtenant equipment, electrical work, etc, required to accommodate such a substitution shall be made at no additional cost to the Owner and be as approved by the Engineer

### 2.02 DESIGN

- A. The algae sweeping system shall consist of an attachment sleeve mounted to the skimmer(s) of the clarifier, a mainframe member to which the individual brush arms are attached, collars, spring mounts, brush arms, numerous brushes of various sizes, and an assortment of springs in different configurations to provide the biasing forces. A series of brush arm assemblies shall be mounted to the mainframe member and biased into engagement with the baffle, weir, spillway and walls of the effluent flow channel. Additionally, a ramp shall be attached to the scum beach to facilitate entrance and exit of inner baffle brush assembly. A bridging ramp shall be positioned over the effluent discharge outlet to support the launder brush assembly as it passes. Scum breach ramps and effluent discharge ramps shall be provided by the algae sweeping system manufacturer. All metallic parts of the automated brush system and ramps shall be made of stainless steel.
- B. Because of the custom designed application of the automated brush systems, variations in poured concrete, differences in various clarifier designs, variances in the height of the skimmer as it travels around the tank, and the out of round of each clarifier, the automated brush system shall be custom designed, field assembled and installed for the individual clarifier it is to be installed on.
- C. The automated brush system for algae and debris control shall be designed for a brush to make contact with each of the following surfaces:

- Inner Scum Baffle
- Outer Scum Baffle
- Inner Weir
- Outer Weir
- Top Spillway surface
- Angle Spillway surface
- Inner Launder wall
- Launder Bottom
- Outer Launder Wall

- D. The automated brush system shall be designed to work off the power of the existing clarifier drive motor. The system shall be constructed to avoid any noticeable torque increases. The unit shall be capable of encountering an indefinite stall without incurring damage.
- E. The automated brush system shall weigh less than 150 lbs. in total for each skimmer to minimize skimmer arm deflection. Distributing the brush system loading between each skimmer arm minimizes the total loading per skimmer arm and ensures the clarifier remains in balance to preserve the integrity of the clarifier drive and bearings.
- F. The unit shall be designed with an engaged position for cleaning, and a disengaged position allowing the system to ride idle around the clarifier.
- G. Automated brush cleaning system must be approved by the clarifier manufacturer on which it is to be installed to address compatibility and prevent any warranty issues.

### 2.03 SPECIAL REQUIREMENTS (CLARIFIERS)

- A. The clarifier mechanism manufacturer must approve the custom designed automated brush system.
- B. The automated brush system requires the clarifier to have the following:
  1. Clarifiers shall be circular in design and be completely free of obstructions around the entire periphery of the tank and compatible with automated brush cleaning systems.
  2. Walkway support – walkway should extend freely to the outer effluent launder wall or beyond and not be supported on the spillway surfaces.
  3. Upper scum baffle brackets shall be L-shaped. This shall allow the free passage of the brush system and to promote more efficient cleaning.
  4. Bolt protrusions – bolt protrusions should be minimized. Bolts / studs, which attach the weir and baffle, should protrude no more than ¼ inch past the nuts.
  5. Skimmer arm shall be of a standard design (no “ducking” or submersible skimmers). Skimmer arm must remain at consistent elevation (plus or minus 1”) around the entire periphery of the clarifier. Skimmer arm must be able to support addition of approximately 200 lbs. without inducing metal fatigue.
  6. Distance between baffle and weir shall be at least eight (8) inches.
  7. A clearance of at least eighteen (18) inches shall be provided between the top of the baffle and the lowest point of the walkway. (Includes water lines and electrical conduit).
  8. Interior concrete surfaces of the launder should be finished as smoothly as possible. This will allow for maximum brush life and increase the effectiveness of algae and debris removal.



9. Performance of automated brush system weir cleaning is greatly enhanced when the weirs are anchored in such a way as to allow for at least four inches of the weir surface above the horizontal concrete spillway.

## 2.04 SYSTEM CONSTRUCTION

### A. Attachment Assembly:

1. The attachment assembly shall provide a means of attaching the automated brush system to the skimmer arm so as not to interfere with any other operations of the skimmer arm (such as the effective skimming of floatable solids or the operation of the skimmer blade assembly at the scum box).
2. The attachment assembly shall be custom designed and approved for each specific clarifier. It shall be constructed of 304 stainless steel.

### B. Mainframe:

1. The automated brush system mainframe shall be constructed of 304 stainless steel and designed to slip easily into the attachment assembly and be tightened in position with the use of set screws. The mainframe shall be designed so that the brush arms can be positioned at any point on the mainframe.

### C. Brush Arms:

1. Brush arms shall be constructed of stainless steel tubing to allow for adequate strength to support spring loaded brush assembly and to keep the automated brush system within the required weight limits. Each brush arm will allow / contain the following:
  - a. Flexibility to clean effluent surfaces within a plus or minus four-inch radial variance (specifically: clarifier launders, both sides of weirs and baffle).
  - b. Opposite the mainframe end, a brush holder component allowing for the insertion of a brush.
  - c. The brush holder to be adjusted so that a maximum number of brush arm adjustments are possible.
  - d. An adjustable means of biasing the arm to the mainframe so as to provide sufficient force to remove algae and debris.
  - e. A component that allows for each brush arm to be “locked out” or disengaged. This will allow operators to customize cleaning schedule and extend life of the brushes.

### D. Spring Assemblies:

1. Each brush arm requires spring tension to bias the brush arm with the brush holder and brushes into tight engagement with the appropriate surface to be cleaned. The spring assemblies require the following:
  - a. A minimum of one spring assembly of 316 stainless steel is required for each brush arm.

- b. Spring assemblies consist of two 316 stainless steel springs and three stainless steel guides to allow for maximum adjustability.
  - c. Each spring will be composed of 316 stainless steel wire with a minimum diameter of 0.093 inch and a minimum of 240 active coils per spring length.
  - d. Spring coils will have a mean diameter 0.093 inch. A minimum inner coil diameter of 0.56 inch and an outer diameter of 0.75 inch are required for each spring.
  - e. Springs shall have a minimum initial spring tension of 9.8 lbs.
  - f. Each end of the spring shall include a self-aligning captured swivel hook with heavier diameter wire, making for a more rugged (long lasting) low wire stress design. The last three to four coils of the spring are gradually tapered by reducing the coil end diameters, leaving a proper interference that prevents the captured swivel hook from pulling out.
- E. Brush Holder:
- 1. At the end of each brush arm there shall be a 316 stainless steel brush holder to allow the insertion of a cleaning brush.
  - 2. A brush holder shall be aligned with each of the following surfaces: both sides of the baffle, both sides of the weir, and each of the effluent launder surfaces.
    - a. Each brush holder shall consist of a “bolted clamp design” to allow for the easy insertion of a cleaning brush.
    - b. Each brush holder shall include a factory supplied brush in the proper size suitable for prolonged exposure to wastewater environment.
    - c. Brush holder shall incorporate an anti-slip that compresses into the brush backing as brush holder is tightened. This provides additional security to ensure brush is firmly in brush holder.
    - d. Each brush holder shall contain a shear safety component at the point where the brush holder attaches to the brush arm to allow for safety breakaway.
  - 3. Each brush holder shall contain a shear safety component having a frangible point designed to break when subjected to a force within each brush holder.
- F. Brushes:
- 1. Brush construction shall be as follows:
    - a. The brush base shall be made of durable injection molded polypropylene that is infused with a foaming agent to reduce the weight of the block. The material shall be impervious to UV rays, temperature fluctuations and the corrosive elements typically found in wastewater.
    - b. The brush bristles shall consist of extruded polypropylene or polyester monofilament. Each filament type is extruded at a diameter not less than 0.055 inches. The filaments shall be secured into the base with a corrosion resistant anchor.

- c. The brushes shall be cut and shaped appropriately in order to clean their respective surfaces without binding.
  2. Replacement brushes shall be stocked by the manufacturer to the exact dimensions per clarifier and will be available for purchase. Brushes provided by the automated brush system manufacturer should average approximately one-year life span.
- G. Brush Bridge:
1. The manufacturer shall provide the automated brush system launder brush assembly with a “bridge” over/across the effluent discharge outlet.
  2. Brush bridge / ramp shall be provided at the scum box. An incline and a decline guide ramp shall be provided for each scum box in the clarifier.
  3. Brush bridge/s shall be constructed entirely of stainless steel.
- H. Brush System Weight & Counterbalances:
1. Weight of the automated algae sweep system will be less than 150 lbs. per skimmer including all attachments, brush arms, components and parts for each skimmer arm design.
  2. A counterbalance shall be installed on the rake mechanism opposite the skimmer to offset the weight of the brush system, if any. Manufacturer of the system shall provide additional counterbalances totaling the weight of the installed brush system, attachment sleeve, and mainframe and be responsible for the correct placement and installation. (This is an additional counterweight beyond the counterbalances provided by the clarifier manufacturer.)

## PART 3 EXECUTION

### 3.01 INSTALLATION

- A. Factory trained and employed technician(s) with five plus years’ experience shall be onsite for a minimum of two days per clarifier to custom install and certify the custom designed automated brush system.

### 3.02 SPARE PARTS

- A. Replacement brushes shall be stocked by the manufacturer to the exact dimensions per clarifier and will be available for purchase. Brushes provided by the automated brush system manufacturer should average approximately one-year life span.

END OF SECTION

## SECTION 11282

### STAINLESS STEEL SLIDE GATES

#### PART 1 – GENERAL

##### 1.1 RELATED DOCUMENTS

- A. Drawings and general provisions of the Contract, including General and Supplementary Conditions and other Division 1 Specification Sections, apply to this Section.
- B. Items in this specification section are subject to the American Iron and Steel requirements of P.L. 113-76, the Consolidated Appropriations Act of 2014.**

##### 1.2 SUMMARY

- A. Furnish, install and test stainless steel sluice gates and appurtenances as indicated and specified.
  - 1. Sizes are indicated in the gate schedules on the Drawings.
- B. Related Sections: The following sections contain requirements that relate to this Section:
  - 1. Division 1 - General Requirements
  - 2. Section 02050 – Demolition
  - 3. Division 16 – Electrical

##### 1.3 SUBMITTALS

- A. Shop Drawings and Product Data:
  - 1. Comply with the requirements of Section 01300 - Submittals.
  - 2. Submit Shop Drawings showing the following:
    - a. Complete description in sufficient detail to permit item-by-item comparison with the Specifications.
    - b. Dimensions.
    - c. Weights.
    - d. Capacity.
    - e. Maximum support reactions.
    - f. Performance characteristics.
    - g. Layout drawing for all equipment showing installation details.

- h. Wiring diagrams for all electrical items (both internal and external)
- i. Deviations from Drawings and Specifications.
- j. Manufacturer's installation and testing instructions.
- k. Affidavits of compliance with referenced standards and codes.
- l. Manufacturer's standard guarantee.
- m. Submit Manufacturer's installation report as specified in Part 3.

**B. Operation and Maintenance Manuals:**

1. Comply with the Requirements of Division 1 and the Supplemental Requirements Below.
2. Required Operation Data:
  - a. Complete, detailed operating instructions for each piece of equipment.
  - b. Explanations of all safety considerations relating to operation.
3. Required Maintenance Data:
  - a. Include all information and instructions required to keep equipment properly lubricated and adjusted so that it functions economically throughout its full design life.
  - b. Explanation with illustrations as necessary for each maintenance task.
  - c. Recommended spare parts lists.
  - d. Recommended schedule of maintenance tasks.
  - e. Lubrication charts and table of alternate lubricants.
  - f. Troubleshooting instructions.
  - g. List of special maintenance tools and equipment.
  - h. Name, address and phone number of manufacturer and manufacturer's local service.
  - i. Include copies of all approved Shop Drawings.

**C. Certification of compliance with the American Iron and Steel requirements of P.L. 113-76, the Consolidated Appropriations Act of 2014, is required with all submittals.**

1.4 QUALITY ASSURANCE

**A. Manufacturer's Qualifications:**

1. Manufacturer shall have a minimum of twenty years experience in producing similar type equipment, and shall show evidence of 100 installations in satisfactory operation upon request.

**B. Reference Standards: Comply with applicable provisions and recommendations**

of the following, except as otherwise shown or specified.

1. AWWA C561 - Standard for Fabricated Stainless Steel Slide Gates.
2. ASTM A276 - Stainless and heat-resisting steel bars and shapes.
3. ASTM A480 - Stainless steel plate, sheet, and strip.
4. ASTM B584 - Copper alloy and sand castings for general application.
5. ASTM D4020 - U.H.M.W. polyethylene molding and extrusion material.
6. ASTM D2000 - Standard classification system for rubber products in automotive applications.
7. ASTM B26 - Aluminum alloy sand castings.

#### 1.5 DELIVERY, STORAGE AND HANDLING

A. Provide in accordance with Section 01600 and as specified.

B. Shipping:

1. Ship equipment, material and spare parts complete except where partial disassembly is required by transportation regulations or for protection of components.
2. Pack spare parts in containers bearing labels clearly designating contents and pieces of equipment for which intended.
3. Deliver spare parts at same time as pertaining equipment. Deliver to Owner after completion of work.

C. Receiving:

1. Inspect and inventory items upon delivery to site.
2. Store and safeguard equipment, material and spare parts in accordance with manufacturer's recommendations. Store materials to permit easy access for inspection and identification. Keep all items off ground, using pallets, platforms or other supports. Do not store items in a manner that might cause distortion or damage to that item.
3. Unload, haul, and store items.
4. Pay demurrage charges if failed to promptly unload items.
5. Assume responsibility for equipment, material and spare parts just before unloading from carrier at site.

### PART 2 – PRODUCTS

#### 2.1 MANUFACTURERS

A. Whipps, Inc., Athol, MA.

- B. Rodney-Hunt Co., Orange, MA.
- C. Hydro Gate, Chattanooga, TN
- D. Or approved equal.
- E. Should equipment which differs from the first named in this Section be offered and determined to be the equal of that specified, such equipment shall be acceptable only on the basis that any revision in the design and/or construction of the structure, piping, appurtenant equipment, electrical work, etc, required to accommodate such a substitution shall be made at no additional cost to the Owner and be as approved by the Engineer

## 2.2 SERVICE CONDITIONS

- A. Stainless steel sluice gate sizes and other pertinent data are included in the gate schedules on the drawings.

## 2.3 GENERAL

- A. All gates produced by a single manufacturer and designed for installation in the structures as indicated on the drawings.

## 2.4 GATE ASSEMBLIES

- A. Type: self-contained, rising stem unless otherwise specified.
- B. Leakage not to exceed 0.025 gpm per foot of seal perimeter.
- C. Unless otherwise specified, all stainless steel parts, including fasteners shall be type 316 stainless steel.
- D. The gate shall utilize self-adjusting seals. Due to the difficulty of accessing gates when they are in service, gates that utilize adjustable wedges, wedging devices or pressure pads are not acceptable.
- E. All structural components of the frame and slide shall be fabricated of stainless steel having a minimum thickness of 1/4-inch and shall have adequate strength to prevent distortion during normal handling, during installation and while in service.
- F. Slide gate frames shall be shipped fully assembled with the invert member welded to the side frames and the slide installed in the frame unless the overall width of the slide gate exceeds 96 inches or the overall height of the slide gate exceed 25 feet.
- G. All welds shall be performed by welders with AWS D1.6 certification.

## 2.5 MANUAL CRANK ACTUATORS

- A. Indicate the direction of operation.
- B. See Paragraph 2.15.

## 2.6 FRAMES

- A. Formed or extruded stainless steel construction consisting of guides, an invert member and a top member where top closure is required. Suitable reinforcements will be provided to resist all operating loads.
- B. The guide members, invert members and yoke members shall be constructed of formed stainless steel plate with a minimum thickness of 1/4-inch.
- C. The structural portion of the frame that incorporates the seat/seals shall be formed into a one-piece shape for rigidity. Guide members that consist of two or more bolted structural members are not acceptable. Guide member designs where water loads are transferred through the assembly bolts are specifically not acceptable.
- D. Self-contained frames shall be provided with a support yoke for mounting the actuator.
  - 1. The support yoke shall consist of structural channel members welded or bolted to the extended guide members.
  - 2. The support yoke shall be located as required to provide full travel of the gate slide unless otherwise specified.
  - 3. The yoke shall be designed so that the maximum deflection is limited to 1/360th of the span when operating at maximum specified head.
  - 4. For gates with powered actuators, the yoke shall be designed to limit the maximum yoke stress to 18,000 PSI at operator stall.
- E. Frames that are attached with epoxy doweled anchor bolts shall be provided with bolts conforming to ICBO report 4285 regarding number of bolts, size, and placement.

## 2.7 SEALS

- A. The frames shall be equipped with seats/seals to prevent metal-to-metal contact and restrict leakage.
  - 1. The guides of all gates shall incorporate ultra high molecular weight polyethylene (UHMW) seat/seals on both the upstream and downstream sides of the gate slide. Each seat/seal will be shaped to act as both a bearing surface and a seal. The top seal, where required on upward opening gates, shall be mounted on the frame and be of low friction polymer construction. Seat contact pressure shall not exceed 600 psi at the design head.
  - 2. All upward opening gates shall contain a replaceable, flush bottom neoprene invert seal, mounted on the slide.
  - 3. All downward opening gates (weir gates) shall have low friction polymer seals mounted on the frame member at the invert of the waterway.
  - 4. All seals shall be attached to the frame with stainless steel retainers and/or stainless steel bolts. Arrangement with seals that are force fit or held in place with adhesives are unacceptable.



5. All gates shall be provided with a self-adjusting seal system to restrict leakage in accordance with the requirements listed in this specification. Gates that utilize rubber “J” seals or “P” seals or wedges are not acceptable.

## 2.8 SLIDES

- A. Stainless steel construction, reinforced with angle, channel, or plate stiffeners as required to limit the deflection at maximum specified head to 1/320 of the span or 1/16" whichever is smaller.
- B. All structural component shall have a material thickness of 1/4".
- C. Stem connectors shall consist of two vertical members welded to the slide. Each stem shall be bolted to the stem connector with two stainless steel attachment bolts.
- D. When the width of the gate opening in feet multiplied by the maximum design head in feet is greater than 80square feet the portion of the slide member that engages the guide shall be 1/2" thick. When the width of the gate opening in feet multiplied by the maximum design head in feet is greater than 120 square feet, the portion of the slide that engages the guide members shall be of a “thick edge” design. The thick edge portion of the slide shall have a minimum thickness of 2.5 inches.

## 2.9 STEMS

- A. The entire stem shall be from solid stainless steel rod.
- B. The stem shall have a minimum diameter of 1-1/2".
- C. The threaded portion of the stem shall have rolled or full depth acme threads polished to a 16 micro inch finish or better. Stub threads are not acceptable.
- D. The stem shall be of a size to safely withstand without buckling or permanent distortion the stresses induced by normal operating forces.
- E. The stem shall be designed to transmit in compression at least 2.5 times the output of the manual actuator with an 80 lb. effort or 1.43 times the stall thrust on electric motor actuators.
- F. A field adjusted threaded cast aluminum stop collar shall be provided on all stems with manual actuators to limit downward travel of the slide.
- G. A field-adjusted aluminum split collar upstop shall be provided on all submerged gates and weir gates to limit the upward travel of the slide.
- H. The maximum L/r ratio for the unsupported portion of the stem shall not exceed 200.

## 2.10 STEM GUIDES

- A. Provide integral frame mounted stem guides to limit the L/r ratio of the operating stem to 200 or less.
- B. Stem guides shall be bronze bushed and adjustable in two directions.

## 2.11 STEM COVERS

- A. All rising stem stainless steel sluice gates shall be provided with clear lexan or butyrate stem covers.
- B. The stem covers shall be properly vented and closed at the top with a plastic cap.
- C. The stem covers shall be provided with field mounted mylar travel indicator strips.

## 2.12 ANCHOR BOLTS

- A. Provide Type 316 stainless steel, epoxy doweled anchor bolts.
- B. Provide anchor bolts of no less than 1/2" diameter.
- C. Provide all anchor bolts with ample cross section to withstand the force created by operation of the gate.
- D. Install anchor bolts per manufacturer's instructions.

## 2.13 WALL THIMBLES

- A. Wall thimbles shall be a heavy one-piece stainless steel 316L construction of the type indicated on the gate schedule and shown on the contract drawings. Depth of the thimble shall be the same thickness as the wall. Minimum material thickness shall not be less than 3/16". All parts of wall thimble including the gussets and stiffeners shall be stainless steel 316L. The vertical centerlines shall be clearly marked at top and bottom to permit alignment of the front face into vertical plane.
- B. Wall thimbles shall be internally braced during concrete placement to prevent warping. Square thimbles shall be provided with holes in the invert to allow satisfactory concrete placement beneath the thimble, and shall be on centers of 24" or less. A suitable mastic or gasket shall be used to form a seal between the front face of the thimble and the back of the gate frame. "E" type thimbles shall have the back flange drilled for mounting to pipe flange.

## 2.14 PAINTING

- A. Any cast iron or carbon steel parts shall be completely shop primed and painted. Field painting, other than touch up, shall not be required.

## 2.15 MANUAL ACTUATORS

- A. The actuator shall be as shown in the Contract Drawings, provided that the effort to operate does not exceed a 40 lb. pull when the gate is subjected to the maximum unbalanced head.
- B. All manual actuators will be enclosed in a high strength cast aluminum or cast iron housing with a bronze operating nut.
- C. Non-Geared Handwheel Actuators

1. Roller-type bearings shall be provided above and below the operating nut.
2. Mechanical seals shall be provided above and below the operating nut.
3. The handwheel shall have a minimum diameter of 15" and a maximum diameter of 24".

D. Geared Crank Actuators

1. Gearboxes shall have a 1" minimum diameter stainless steel pinion shaft.
2. Roller-type bearings shall be provided above and below the operating nut.
3. Mechanical seals shall be provided on the top and bottom of the actuator housing and around the pinion shaft.
4. All gears are to be steel or bronze.
5. The crank shall have a minimum radius of 12" and a maximum radius of 15".

E. Interconnected Actuators

1. All stainless steel sluice gates 72" wide or larger or those with widths greater than twice their height shall be provided with two stems and two gearboxes connected by an aluminum or stainless steel interconnecting shaft for simultaneous operation via crank.
2. Gates shall also be equipped with dual actuators if deemed necessary for proper operation by the gate manufacturer.

F. Remote Actuator Drives

1. Remote actuator drives shall be provided in cases where the centerline of the handwheel (mounted on non-geared actuator) will be located 48" or greater from the operating floor, where the centerline of the handwheel (mounted on geared actuator) will be 54" or greater from the operating floor, or where the centerline of the crank will be located 48" or greater from the operating floor.
2. Remote drives shall be of the chain and sprocket type with an aluminum cover.
3. Remote drives shall be used in conjunction with geared crank actuators. The centerline of the crank shall be positioned 30" above the operating floor.

## 2.16 ELECTRIC MOTOR OPERATORS

A. Manufacturers:

1. Limitorque Corp. Lynchburg, VA.
2. Rotork Controls Inc., Rochester, NY.
3. AUMA Actuators, Cannonsburg, PA.
4. Or acceptable equivalent product.

B. Motor operators shall be furnished by gate manufacturer.

- C. Each operator includes electric motor, reduction gearing, reversing starter, thermal overloads, drive bushing or stem nut, control transformer and limit controls. Gears totally enclosed in NEMA 4X housing with integrally cast mounting for motor, and removable cover for limit controls.
  - 1. Provide strip heater in electrical compartment.
  - 2. Equip each operator with a handwheel for manual operation and hammerblow device, which permits motor to come up to speed before picking up load and unseating gate.
  - 3. Actuators shall be so designated that they are suitable for future operation by Instrumentation and Control SCADA system via hardware I/Os.
  - 4. Stem coupling shall be accomplished by means of a high tensile, manganese bronze stem nut. The nut shall be of the 2-piece design, permitting installation and removal without disassembly of the actuator, uncoupling of the actuator from the valve, or removal of the external power and control wiring conduit.
- D. Provide opening and closing speeds of approximately 12-in. per minute for motor operators.
- E. Mount operator for stainless steel sluice gates on a pedestal with flanged bases drilled for anchor bolts.
- F. Provide internal clutch that cannot engage handwheel operating mechanism and motor-operating mechanism at same time.
  - 1. Provide handwheel with arrow and word OPEN cast on wheel to indicate turning direction to open. The handwheel shall operate in the clockwise direction to close.
  - 2. Design for handwheel to not rotate during power operation. Design for motor not to rotate during manual operation.
  - 3. Provide 18-in. maximum diameter handwheel and gear ratio to give maximum rate of movement possible with 40-lb. pull on hand wheel.
  - 4. Should power be returned to the motor while the handwheel is in use, the design of the unit shall prevent transmission of the motor torque to the handwheel. Use of the handwheel shall not negate the hammer-blow feature.
- G. Reduction Unit of worm-gear type, worm and planetary spur type, modified planetary type, or acceptable reduction unit of spur-gear type.
  - 1. Provide spur gears with cut teeth.
  - 2. If worm gears are used, operate worm shaft in ball or roller bearings and provide machine cut, ground, and highly polished; bronze worm with large contact area.
  - 3. Accurately machine worm, spur gears, and all shafts of heat-treated steel.
  - 4. Operate output or driving shaft in bronze bearings or in ball or roller bearings.
  - 5. Make provisions to take thrust in both directions.

6. Lubricate gearing at all times.
- H. Fully wire electric motor operators at factory and furnish complete with terminal strips for external power and control connections as specified under appropriate electrical sections.
- I. Provide manual or automatic control as indicated or specified.
- J. Manual Control: Provide OPEN, STOP, and CLOSE push-button at operator.
- K. Remote Position Indication
  1. Provide open and closed position switches with I/O to be hardwired to RTU PLC
- L. Manufacture contacts and operating parts of non-corrodible metal.
- M. Starter panel and push-button station integral part of, or separate enclosure attached to side of each pedestal, or on adjacent structure for units without pedestals.
  1. Provide each unit with an unfused disconnect switch enclosed with contactor or in separate enclosure.
  2. Each actuator shall be supplied complete with open-stop-close push buttons. Push buttons shall be furnished integral.
  3. Enclosure: NEMA 4X (316 stainless steel/fiberglass).
  4. Red and green LED indicating lights furnished on operator. Green light on when gate is completely opened; red light on, when gate is completely closed. Both red and green lights on during operation at intermediate positions or when operator is stopped at any intermediate position. Provide a set of dry 10A, 120 VAC contacts for future remote indication.
  5. Control circuits: 120-volt, single-phase, 60-Hertz current, supplied by control transformer.
  6. Position indication shall be accomplished by means of an indicator dial in full step at all times with gate travel, whether in power or manual operation. The indicator dial shall be graduated in 25 percent increments as a minimum; closed, quarter open, half open, three-quarters open, and open.
  7. Terminal strips, space heater, limit and torque switches shall be housed in compartment(s) integral to the actuator. As a minimum, the compartment(s) shall be available to meet NEMA 4X requirements.
  8. Provide inverse time element overload relays.
  9. Provide control transformer.
- N. Limit Controls:
  1. Positive in action ensuring tight seating and full openings.
  2. Mechanism designed to minimize drift or over travel and to open or close gate to fixed, predetermined point at every operation.

3. Provide controls to disconnect driving mechanism from stem. Geared-limit or torque-limit type as required, but capable of ready adjustment for predetermined limits of opening and closing travel.
4. Provide torque switches for both directions of travel to break the control power circuit when the gate has reached the stops in the open or closed position or when an obstruction has been encountered in either direction of travel. Open and close torque switches shall be adjustable by means of individually calibrated dials (marked open and close). Provide high torque pilot light in the push-button station.
5. Friction devices or setscrew arrangements shall not be used to maintain the setting.
6. The switches shall be of the adjustable type, capable of being set either fully open, fully closed, or at any intermediate point. Limit switch gearing shall be totally enclosed to prevent entrance of foreign matter or loss of lubricant.

O. Motor Provisions:

1. Specifically designed for service intended, NEMA 4X minimum weatherproof construction.
2. 460-volt, 3-phase, 60-Hertz, squirrel-cage, reversible, high-torque motors of standard make with grease packed ball bearings.
3. Motors shall be capable of operating through one complete cycle, open-close-open or close-open-close, under the maximum specified operating conditions when voltage to the motor is  $\pm 10$  percent of the specified voltage.
4. Service factor: 1.15.
5. Enclosure: TENV.
6. Insulation: Class B minimum.
7. Maximum Speed: 1800 rpm.
8. Provide motor starters with overload protection on all three phases.

## 2.17 ACTUATOR MOUNTING

- A. The actuator shall be mounted to the gate yoke on self-contained gates. The yoke shall consist of two channel members that are welded or bolted to the top of the gate frame. The actuator shall be pedestal mounted on non self-contained gates. Pedestals shall be concentric, offset, or wall bracket mounted. Pedestal assemblies shall be fabricated stainless or carbon steel.

## 2.18 SHOP TESTS

- A. Shop testing shall be performed. Before final assembly, all seating and wedging surfaces shall be cleaned thoroughly of all foreign materials and final adjustments made. With the gate fully assembled and closed, the clearance between seating

faces shall be checked with a 0.0040-inch thickness gauge. If the thickness gauge can be inserted between seating faces, the wedging devices shall be readjusted or the gate slide or gate frame or both shall be remachined until insertion is no longer possible. In the event of remachining, clearances shall be checked again as stated above.

- B. After completion, all seating and wedging surfaces shall be cleaned thoroughly of all foreign materials, and final adjustments shall be made. The stainless steel sluice gate shall then be shop operated from the fully closed to the fully open position to verify that the assembly is workable.
- C. Operate floorstands and benchstands to insure proper assembly and operation.

## PART 3 – EXECUTION

### 3.1 GENERAL

- A. It shall be the Contractor's responsibility to handle, store, and install the gate, actuator mechanism, stem, stem guides, and accessories in accordance with the manufacturer's drawings, installation manual and recommendations. Care shall be taken to avoid warping the gate frame and to maintain tolerances between seating faces. All gates, stems, and actuators shall be plumbed, shimmed, bolted and aligned accurately. All gates shall be installed in a dry environment and in strict accordance with manufacturer's published instructions.
  - 1. Chemical Adhesive anchors for attaching stainless steel sluice gate components to wall material are specified.
- B. Prior to installation, protect stored gates and appurtenances from damage due to exposure to sunlight, heat, dirt, debris, freezing and thawing, vandalism, etc.
  - 1. Store gates and appurtenances in accordance with manufacturer's written recommendations.
- C. Clean debris, dirt, and gravel, from inside of gates and channels before placing gates.
- D. Install stainless steel sluice gates in completely assembled condition with discs wedged lightly but firmly into seats with nuts pulled up tight.
- E. Erect and support gates in respective positions free from distortion and strain on appurtenances during handling and installation.
- F. Inspect material for defects in workmanship and material.
- G. Clean out debris and foreign material from gate opening and seats, test operating mechanisms to check proper functioning, and check nuts and bolts for tightness. Repair, gates and other equipment that does not operate easily or are otherwise defective.
- H. All welds shall be performed by welders with AWS D1.6 certification.
- I. Finish: Mill finish on stainless steel. Welds shall be sandblasted to remove weld

burn and scale. All iron and steel components shall be properly prepared and shop coated with a primer.

### 3.2 FLOORSTAND OPERATORS AND STEM GUIDES

A. Set floorstand operators and stem guides so stems run smoothly in true alignment. Anchor guides firmly to walls. Check distances from centerlines of gates to operating level or base of floorstand and adjust if necessary to suit actual conditions of installation.

### 3.3 ACCEPTANCE TESTS

A. After installation of equipment, and after completion of the services of manufacturer's representative as stated in Section 01735, operate each gate to demonstrate its ability to operate smoothly and without jamming.

B. Leakage Test:

1. Seating Heads: Leakage not to exceed 0.025 gpm per foot of seating perimeter.
2. Unseating Heads: Leakage not to exceed 0.025 gpm per foot of seating perimeter.
3. Conduct tests at heads shown in the gate schedule.

C. Correct or replace defects and defective equipment at no additional compensation.

### 3.4 FIELD TOUCH-UP

A. After installation and testing of stainless steel sluice gates and approval of Engineer, provide field touch-up to all damaged and abraded surfaces. Engineer to determine surfaces to receive field touch-up.

B. Touch-up coating shall be similar to type, color and mil thickness applied in shop application.

### 3.5 CONTRACT CLOSEOUT

A. Provide in accordance with Section 01700.

END OF SECTION 11282



## SECTION 11300

### PERISTALTIC CHEMICAL METERING PUMP SYSTEM

#### PART 1 GENERAL

##### 1.01 SUMMARY

- A. Furnish, install, test, and place in satisfactory operation, a chemical metering pump system, including pumps, triplex pump skid, and all required appurtenances as indicated and specified.

##### 1.02 RELATED SECTIONS

- A. SECTION 01300 – SUBMITTALS
- B. SECTION 01631 – USE OF OTHER THAN FIRST NAMED MANUFACTURERS
- C. SECTION 01665 – SERVICES OF MANUFACTURER’S REPRESENTATIVES
- D. SECTION 01680 – EQUIPMENT AND SYSTEM CHECKOUT, CERTIFICATIONS, AND TESTING
- E. SECTION 01730 – OPERATION AND MAINTENANCE MANUALS
- F. SECTION 01740 – WARRANTIES
- G. SECTION 01750 – SPARE PARTS
- H. SECTION 11400 – POLYETHYLENE CHEMICAL STORAGE TANKS
- I. SECTION 11961 – INTERIOR AND EXTERIOR PROCESS PIPING
- J. SECTION 13321 – INSTRUMENTATION AND CONTROL SYSTEM

##### 1.03 SUBMITTALS

- A. Shop Drawings in accordance with Specification Section 01300.
- B. Make, model, and weight of each equipment assembly.
- C. Complete catalog information, descriptive literature, specifications, and identification of materials of construction.
- D. Detailed mechanical and electrical drawings showing the equipment dimensions, size, locations of connections, and weights of associated equipment.
- E. Power and control wiring diagrams, including terminals and numbers.
- F. Functional description of internal and external instrumentation and controls to be supplied including list of parameters monitored, controlled, or alarmed.

##### 1.04 QUALITY ASSURANCE

- A. Pumps shall be manufacturer's standard product. Manufacturer of tubing pumps must have at least 20 operating installations in domestic water or wastewater treatment plants

located in the United States over a period of at least five years in the same service and size as specified.

- B. Pumps shall be 100 % integral in design with the pumphead, motor, controls, and pump case being manufactured by the pump manufacturer themselves. All controls, motors, and gear reduction shall be housed in a single chemically resistant pump case. Pumps that require separate base plates, external gear reducers and /or gear motors, and separate controls– even if mounted on a base plate and pre-wired to the motor- are not acceptable.
- C. To ensure pump performance and accuracy, only tubing provided by the pump manufacturer is acceptable.
- D. Chemical Metering System (skid) must be manufactured by the chemical metering pump manufacturer and must provide pumps and accessories as a complete turnkey system. Skids manufactured by third parties such as separate skid fabricators, pump distributors or pump representatives are not acceptable.

## PART 2 PRODUCTS

### 2.01 MANUFACTURERS

A. Pump System shall be:

- 1. Blue-White model M3 pumps with model CFPS-3 skid
- 2. Watson Marlow
- 3. Approved equal.
- 4. Should equipment which differs from the first named in this Section be offered and determined to be the equal of that specified, such equipment shall be acceptable only on the basis that any revision in the design and/or construction of the structure, piping, appurtenant equipment, electrical work, etc, required to accommodate such a substitution shall be made at no additional cost to the Owner and be as approved by the Engineer

### 2.02 CHEMICAL METERING PUMPS

- A. The pumps shall be a positive displacement, peristaltic type tubing pump with a brushless variable speed motor, non-spring-loaded roller assembly located in the pumphead, integral tube failure detection system, tube life roller revolution counter with user alarm set-point and flexible tubing with attached connection fittings
- B. There shall be no valves, diaphragms, springs, or dynamic seals in the fluid path. Process fluid shall contact the pump tubing assembly and connections fittings only.
- C. Pumps shall be capable of 24-hour continuous duty and self-priming and operating in either direction of flow at the rated maximum pressure of up to 125 PSI.
- D. Pumps shall be capable of running dry with no damage.
- E. Pump shall be capable of operating in either direction without output variation.
- F. Suction lift shall be 30 feet (9.14 m) of water.

- G. Pump shall be warranted by the manufacturer for a period of five years, and in accordance with Specification Section 01740. Warranty shall include chemical damage to the pump head and roller assembly for a period of two years.
- H. Tubing shall be chemically compatible with the pumped product.
- I. Provide pumps according to the schedule below:

<b>Pump Tag Nos.</b>	<b>Location</b>	<b>Service</b>	<b>Flow (gph)</b>	<b>PSI</b>	<b>Drive</b>
Micro C Pump No. 1 Micro C Pump No. 2 Micro C Pump No. 3	Micro C pump enclosure	Micro C	0-15	50	Variable Speed Motor

- J. Pump Head: Shall be a single, unbroken track with a clear removable cover.
1. Tube failure detection sensors shall be wholly located in the pump head. Tube failure detection system shall not trigger with water contact. Float type switches shall not be used. Process fluid waste ports or leak drains shall not be provided.
  2. Squeeze rollers with encapsulated ball bearings shall be directly coupled to a one-piece thermoplastic rotor. Four nylon rollers shall be provided; two squeeze rollers for tubing compression shall be located 180 degrees apart and two guide rollers that do not compress the tubing shall be located 180 degrees apart. The roller diameters and occlusion gap shall be factory set to provide the optimum tubing compression; field adjustment shall not be required. Spring-loaded or hinged rollers shall not be used.
  3. Rotor assembly shall be installed on a D-shaped, chrome plated motor shaft and removable without tools.
  4. For tubing installation and removal, rotor assembly shall be rotated by the motor drive at 6 RPM maximum when the pumphead cover is removed. Hand cranking of the rotor assembly shall not be required.
  5. Pump head and tubing compression surface shall be corrosion resistant Valox thermoplastic.
  6. The pump head cover shall be clear, polycarbonate thermoplastic with an integral ball bearing fitted to support the overhung load on the motor shaft. Cover shall include an imbedded magnetic safety interlock which will limit the motor rotation speed to 6 RPM when removed.
  7. Cover shall be positively secured to the pump head using a minimum of four thumb screws. Tools shall not be required to remove the pump head cover.
- K. Pump Tube Assembly:
1. To ensure pump performance and accuracy, only tubing provided by the manufacturer is acceptable.
  2. Pump tube shall be assembled to connection fittings of PVDF material.

3. Connection fittings shall be permanently clamped to the tubing with stainless steel clamps or over molded directly to the tubing. To prevent tubing misalignment and ensure accuracy, fittings shall insert into keyed slots located in the pump head and secured in place by the pump head cover.
  4. Connection fittings shall be 1/2" NPT
  5. Tube sizes and connections shall be measured in inches.
- L. Drive System: Shall be factory installed and totally enclosed in a NEMA 4X, (IP66) wash-down enclosure. Capable of operating on any input power from 110VAC to 240VAC, 50/60 Hz single phase supply without user configuration or selection switches.
1. Motor:
    - a. Reversible, brushless DC gear motor rated for continuous duty.
    - b. Motor shall include overload protection.
    - c. The maximum gear motor RPM shall be 125 RPM.
  2. Enclosure:
    - a. Bottom housing shall be pressure cast aluminum with acidic liquid iron phosphate three-stage clean and coat pretreatment and exterior grade corrosion resistant polyester polyurethane powder coat.
    - b. Top housing shall be structural foam molded Noryl engineered thermoplastic.
    - c. Rated NEMA 4X (IP66).
    - d. Provided with 316SS floor/shelf level mounting brackets and hardware.
    - e. M12 receptacles shall be located at the rear of the pump for input and output signals.
    - f. RJ45 receptacle shall be located at the rear of the pump for use with EtherNet/IP and Modbus TCP/IP.
    - g. One M12 receptacle shall be located at the rear of the pump for use with Profibus.
  3. Pump Controls: All control circuitry shall be integral to the pump.
    - a. All control circuitries shall be integral to the pump and capable of adjusting the pump motor speed from 0.01% to 100.0% in 0.01% increments less than 10% motor speed, in 0.01% and in 0.1% increments greater than 10% motor speed (10,000:1 turndown ratio).
    - b. The pump output shall be capable of being manually controlled via front panel touchscreen. The pump motor speed shall be adjustable from 0.01% to 100.0% in 0.01% increments less than 10% motor speed and in 0.1% increments greater than 10% motor speed.
    - c. The pump output shall be capable of being remotely controlled via 4-20mA analog input. The input resolution shall be 0.01 of input value and capable of adjusting the pump motor speed from 0% to 100.0% motor speed in 0.1% increments. Four values shall be user configurable to define the low and high

points on the output slope: a low input value, the required pump percentage of motor speed at the low input value, a high input value, the required pump percentage of motor speed at the high input value.

- d. The pump output shall be capable of being remotely controlled via TTL/CMOS digital high-speed pulse type input and an AC sine wave type pulse input in the range of 0 to 1,000 Hz. The frequency resolution shall be 1 Hz and capable of adjusting the pump motor speed from 0% to 100.0% motor speed in 0.1% increments. Four values shall be user configurable to define the low and high points on the output slope: a low input value, the required pump percentage of motor speed at the low input value, a high input value, the required pump percentage of motor speed at the high input value.
- e. The pump output shall be capable of being remotely controlled via pulse triggered batching. The pump shall accept a TTL/CMOS digital pulse type input and a contact closure type pulse input in the range of 1 to 5,629,499,534,21,312 pulses per batch. The batch time shall be adjustable from 1 to 5,629,499,534,21,312 seconds. The pump motor speed during the batch shall be adjustable from 0% to 100.0% motor speed in 0.1% increments.
- f. The pump output shall be capable of being controlled via EtherNet/IP, Modbus TCP/IP, or Profibus.
- g. Provide a front panel touchscreen control for stop/start, configuration menu access and navigation, operating mode selection, display options selection, tube info data, and reverse direction.
- h. Provide a multi-color LCD touchscreen display for menu driven configuration settings, pump output value, service alerts, tube failure detection (TFD) system and flow verification system (FVS) alarms status, remote input signal values, tubing life timer value. Display color shall be green when indicating run operation, blue when in idle, yellow when in stand-by, and red to indicate an alarm condition exists.
- i. Provide for remote stop/start pump via 6-30 VDC powered loop or non-powered contact closure loop.
- j. Provide a user selectable 4-20mA and 0-1,000Hz output signal which are scalable and proportional to pump output volume.
- k. Provide four contact closure alarm outputs. Three rated at 1A-115VAC, 0.8A-30VDC and one rated at 6A-250VAC, 5A-30VDC. Each alarm output shall be assignable to monitor any of the following pump functions: TFD system, FVS system, motor run/stop, motor failed to respond to commands, motor is running in reverse, general alarm (TFD, FVS, and/or motor over current), input signal failure, output signal failure, remote/local control status, revolution counter (tube life) set-point, or monitor which of the nine different pump operating modes is currently active.
- l. Provide a four-digit password protected configuration menu.

- m. Provide a flow verification system with programmable alarm delay time from 1-1000 seconds. FVS system shall monitor the FVS flow sensor while pump is running only. System shall not monitor pump while not running.
4. Safety:
- a. The pump shall be certified to NSF Standard 61 Drinking Water System Components, UL standard 778 motor operated pump and CSA standard C22.2 process control equipment.
  - b. Manufactured to ISO 9001:2015 requirements and processes.
  - c. Tube Failure Detection (TFD) system sensors shall be wholly located in the pump head. TFD system will stop the pump within three seconds of leak detection. To prevent false alarms due to rain, wash-down, condensation, etc., tube failure detection system shall not trigger with water contact. Process fluid waste ports or leak drains shall not be provided.
  - d. Pump head cover shall include an imbedded magnetic safety interlock which will stop the pump when removed. Pump rotor speed shall be limited to 6 RPM when cover is removed.
  - e. Secondary user confirmation input required for motor reversal, tube life revolution count reset, and factory default configuration reset.

#### 2.03 SKID SYSTEM & ACCESSORIES

- A. Pumps shall be integrally mounted on a chemically resistant polyethylene triplex skid prior to delivery to the site. The skid shall have the following:
- 1. Two side support walls and pump mounts.
  - 2. Chemical spill containment in the base, with drain port.
  - 3. Stainless steel mounting pads with pre-drilled holes for anchor bolts.
  - 4. Piping associated with the skid shall be sch. 80 PVC.
  - 5. Unions shall be sch. 80 PVC.
  - 6. Seals shall be FKM.
  - 7. Terminal Box with pumps pre-wired for easy access to all electrical signal wires.
  - 8. Electrical Outlet Box designed for use in wet, damp, or dry locations.
  - 9. All wetted materials shall be chemically compatible with the pumped product.
- B. Flow Indicator: System shall be provided with a clear flow indicator for visual confirmation of flow.
- 1. The flow indicator body shall be machined from clear cast acrylic with ceramic ball indicator and PVDF ball stop.
  - 2. The flow indicator shall be secured to the piping system with PVC or CPVC connections and polypropylene half unions.

- C. Ball Valve: System shall provide true union, vented, PVC ball valves with PTFE shaft bearings and seats as shown on the drawings.
- D. Check Valve: System shall provide check valves on the discharge side of the piping system at the pump injection points to prevent the back flow of fluid through the system.
  - 1. Check valves shall be PVC with a 1.0-1.5 PSI cracking pressure and manufactured by Plast-O-Matic series CKM or approved equal.
  - 2. The maximum inlet working pressure shall be 150 PSI.
- E. Pressure Relief Valve: System shall provide pressure relief valves on the discharge side of the piping system to prevent excessive pressure in the system. Fluid shall be returned to the inlet side of the system if the pre-set maximum system pressure is exceeded.
  - 1. The valve shall be PVC with a PTFE diaphragm seal.
  - 2. Non-wetted components: EPDM secondary seal, zinc plated steel spring, stainless steel external hardware, HDPE pressure adjustment screw.
  - 3. Infinite adjustment increments from 10 to 150 PSI.
- F. Pump Connections: Shall be flexible, reinforced braided PVC tubing rated for 200 PSI maximum continuous duty and terminated to half unions with stainless steel hose clamps. Tubing shall be NSF listed.
- G. Inlet Strainer: System shall provide strainers on the suction side of the piping system.
  - 1. The Y-type dampener shall be PVC with removable screen (1/32" mesh).
- H. Calibration Cylinder: System shall provide a calibration cylinder (column) on the inlet side of the system to permit metering pump output volume calibration, as shown on the drawings.
  - 1. The calibration column shall be sized by the manufacturer for 1-minute draw down at maximum capacity.
  - 2. Valves shall permit the cylinder to be filled by gravity or by by-passing the chemical metering pump output into the cylinder.
  - 3. The PVC cylinder shall have PVC end caps and 1/2" PVC pipe outlet vent.
  - 4. The calibration column shall be inscribed in the column with volume gradations. Main divisions shall be in gallons, subdivided in increments of 0.01 gallons.
  - 5. Columns shall be designed to accommodate the pressure requirements associated with full chemical tanks. Allowable design pressure shall be included in the shop drawing submittals.
- I. Pressure Gauge: Shall be provided on the discharge side of the system to indicate system pressure as shown on the drawings.
  - 1. The liquid filled gauge shall be stainless steel and include a blow-out plug.
  - 2. The gauge shall be bottom mounted to the guard with 1/4" NPT stainless steel threads.

3. The temperature compensated oil filled gauge guard shall be PVC.
- J. Anchor Bolts: Type 316 stainless steel epoxy doweled anchors, sized by equipment manufacturer, 7/16-inch minimum diameter, and as specified in Section 03300.
- K. Equipment Identification Plate: Provide black identification plates with white numbering stating equipment name and tag number as specified by the Engineer. Plates shall be securely mounted in a readily visible location.

#### 2.04 NITROGEN CONTROLLER

- A. System shall be provided with a Nitrack Controller by Environmental Operating Solutions, Inc. (EOSI) for control and monitoring of the metering pump skid. The controller shall provide automatic operation of the metering pumps based on flow and nitrogen concentration input signals. Note, there are two separate Biological Reactors with separate nitrogen analyzers. The controller must be capable of controlling the metering pumps independently, based on different input signals. The following I/O at a minimum shall be integrated into the SCADA system via ethernet connection. Refer to the Instrumentation and Control Specifications and Drawings for additional requirements.
  1. Start/Stop to Each Pump
  2. Status of each pump
  3. Speed output to each pump
  4. Speed feedback from each pump
  5. Common Fail from each pump

#### 2.05 TESTING

- A. Provide on-site services in accordance with Section 01665 – Services of Manufacturer's Representative and the following requirements.
  1. After cleaning, completely test each chemical pump with manufacturer's technical representative in presence of Engineer to demonstrate that equipment is capable of performing its specified function in satisfactory manner without mechanical or electrical defects, binding, or operational difficulties. Correct all defects and deficiencies and repeat all tests until satisfactory results are obtained. Correct excessive vibration or noise. Make all connections watertight.
  2. Demonstrate accuracy of all units and bring within limits specified herein.
  3. Test and calibrate all controls, switches, valves and other instrumentation and control equipment associated with equipment specified herein in accordance with manufacturer's printed instruction over full operating range of equipment, (25%, 50%, 75%, and 100% of full capacity).
  4. Water testing is permitted where appropriate for preliminary testing purposes; however, conduct all acceptance tests using appropriate chemicals for which each system was designed.



5. Prior to the Acceptance test, make all final adjustments necessary to place equipment in satisfactory working order.
6. Notify the Engineer in writing when all corrections have been made and all pumps are ready for Acceptance testing. Make no further changes or modifications without written consent of the Engineer.

### PART 3 EXECUTION

#### 3.01 INSTALLATION

- A. Install mixers according to the manufacturer's written instructions.
- B. Anchor Bolts: Accurately place equipment using templates supplied by pump manufacturer.

#### 3.02 CONTRACT CLOSEOUT

- A. Provide in accordance with Section 01700.

END OF SECTION

## SECTION 11301

### SUBMERSIBLE MIXERS

#### PART 1 - GENERAL

##### 1.01 SECTION INCLUDES

- A. This specification covers furnishing, installing, testing, and placing in satisfactory operation, twelve (12) submersible mixers, as shown on the contract drawings.
- B. Refer to instrumentation and control drawings for loop diagrams and other additional requirements.

##### 1.02 RELATED SECTIONS

- A. SECTION 01300 – SUBMITTALS
- B. SECTION 01631 – USE OF OTHER THAN FIRST NAMED MANUFACTURERS
- C. SECTION 01665 – SERVICES OF MANUFACTURER’S REPRESENTATIVES
- D. SECTION 01680 – EQUIPMENT AND SYSTEM CHECKOUT, CERTIFICATION, AND TESTING
- E. SECTION 01730 – OPERATION AND MAINTENANCE MANUALS
- F. SECTION 13350 – INSTRUMENTATION
- G. SECTION 14600 – HOISTING EQUIPMENT

##### 1.03 REFERENCES

- A. American Iron & Steel Institute (AISI)
- B. American Society for Testing and Materials (ASTM)
- C. National Electric Code (NEC)
- D. National Electrical Manufacturers Association (NEMA)
- E. Anti-Friction Bearing Manufacturers Association (AFBMA)
- F. International Standards Organization (ISO) - IS09001

##### 1.04 SUBMITTALS

- A. Shop Drawings in accordance with specification Section 01300.
- B. Operation and Maintenance Manual in accordance with specification Section 01730.

##### 1.05 QUALITY ASSURANCE

- A. It is the intent of these specifications to procure a quality product by an established manufacturer, incorporating the latest design.

- B. All materials shall be designed to withstand the stresses encountered in fabrication, erection and operation. All equipment shall be of corrosion resistant materials with corrosion resistant coatings approved by the Engineer.
- C. The mixer specified herein shall be the design and fabrication of a single manufacturer which shall have sole source responsibility for said equipment. The manufacturer shall have mixing equipment of this principal design and of comparable capacity in successful operation in the field for a minimum period of 10 years.

PART 2 - PRODUCTS

2.01 MANUFACTURERS

- A. Xylem/Flygt, SR 4650
- B. Sulzer/ABS
- C. KSB, Amamix C
- D. Approved Equal
- E. Should equipment which differs from the first named in this Section be offered and determined to be the equal of that specified, such equipment shall be acceptable only on the basis that any revision in the design and/or construction of the structure, piping, appurtenant equipment, electrical work, etc, required to accommodate such a substitution shall be made at no additional cost to the Owner and be as approved by the Engineer.

2.02 DESIGN

- A. The mixers specified and shown on the contract drawings are based on Xylem/Flygt model SR 4650.
- B. The mixer shall be capable of handling raw, screened sewage. It shall be possible to easily raise and lower the mixer without the need for personnel to enter the tank. The mixer shall be mounted on a square or rectangular guide bar system. A sliding guide bracket for the guide bar shall be an integral part of the mixer unit. The mixer, with its appurtenances and cable, shall be capable of continuous submergence without loss of watertight integrity to a depth of 20 m.
- C. Each mixer shall be designed for continuous duty in handling mixed media of a maximum temperature of 40° C.
- D. Each mixer shall be equipped with a submersible electric motor, capable to operate on a 460 volt, 3 phases, 60 hertz voltage supply.
- E. The mixers shall be capable to transport wastewater with 0.5% solids.
- F. Each mixer shall be capable of performing under the following operating conditions.

Basin	Length (ft)	Width (ft)	Max. Side Water Depth (ft)
Anoxic Zone 1	46	26	19.36
Anoxic Zone 2	46	26	19.36

Anoxic/Aerobic Swing Zone 1	46	26	19.36
Aerobic/Anoxic Swing Zone 2	59.5	26	19.36
Secondary Anoxic	113	21.5	17.8

Mixer Location	Rated Shaft Hp	Max. Motor Speed (RPM)	Total Trust Produced (N)	Max. Impeller Diameter (in.)	No. of Blades
Anoxic Zone 1	6	1200	1194	22.83	3
Anoxic Zone 2	6	1200	1194	22.83	3
Anoxic/Aerobic Swing Zone 1	6	575	1194	22.83	3
Aerobic/Anoxic Swing Zone 2	8	600	1705	22.83	3
Secondary Anoxic*	11	900	2528	22.83	3

\*Each Secondary Anoxic tank requires two (2) mixers

G. A performance chart shall be provided upon request showing curves for torque, current, power factor, input/output HP and efficiency. This chart shall also include data on starting and no-load characteristics.

## 2.03 MATERIALS

- A. Propeller & Inlet shroud: Stainless steel AISI 316 L, or AISI 316
- B. Motor casing: Stainless steel AISI 316 L, AISI 316, or ASTM A-48 Class 35B
- C. Fixing plate / Cable entry: Stainless steel AISI 316 L
- D. Lifting handle: Stainless steel AISI 316
- E. Stator housing: ASTM A-48 Class 35B
- F. Oil housing: Vinyl ester based SMC, ASTM A-48 Class 35B, or AISI 316
- G. Shaft: ASTM AISI 431, AISI type 316
- H. Cable outer sheath: Chlorinated polyethylene rubber (CPE)
- I. Shaft seal (Mixer side): Corrosion resistant silicon carbide, or tungsten carbide WCCR
- J. Shaft seal (Motor side): Corrosion resistant silicon carbide, or tungsten carbide WCCR
- K. Nuts and bolts: Stainless steel AISI 316 or better

- L. All castings must be blasted before coating. All wet surfaces are to be coated with two-pack oxyrane ester Duasolid 50, or two part epoxy. The total layer thickness should be at least 120 microns. Zink dust primer shall not be used.

#### 2.04 PROPELLER & INLET SHROUD

- A. The propeller shall be of a 3-bladed fixed pitch and factory balanced design. The blades shall be noticeably backward curved so that any clogging tendency is minimized. The propeller shall be capable of handling solids, fibrous materials, heavy sludge, and other matter found in normal sewage applications. The fit between the propeller and the shaft shall be a sliding fit employing a single screw and washer for securing the propeller to the shaft.
- B. The mixer assembly shall incorporate a bell-shaped inlet shroud (if applicable), 360 degrees around the propeller to maximize hydraulic efficiency and minimize power consumption.
- C. The Propeller shall be mounted on the motor shaft. Couplings or gear boxes shall not be accepted.

#### 2.05 BEARINGS

- A. All bearings shall have a minimum L10 rated life of 100,000 Hrs.
- B. Bearings construction shall be one of the following types:
  - 1. The mixer shaft shall rotate on three (3) permanently lubricated bearings. The main bearing shall be an angular contact ball bearing to take up axial loads. There shall be two support bearings – one single row angular contact ball bearing to take up axial and radial loads and one cylindrical roller bearing to take radial loads. The bearings shall be pre-loaded by a bearing loading nut located at the upper end of the motor shaft in order to reduce shaft deflection and increase bearing and seal life.
  - 2. The mixer shall rotate on two (2) high quality permanently lubricated bearings. Bearings are single row, deep grooved design and sized to transfer all radial and axial loads to the mixer housing and minimize shaft deflection for increased bearing and seal life. The rear bearing is preloaded with a wave spring washer for consistent load.

#### 2.06 SHAFT

- A. Mixer and motor shaft shall be the same unit. The mixer shaft is an extension of the motor shaft. Couplings shall not be acceptable.

#### 2.07 SHAFT SEAL

- A. Shaft Seal shall be one of the following types:
  - 1. Each mixer shall be provided with a liquid chamber for the shaft sealing system. Each mixer shall be provided with a dual mechanical shaft seal system consisting of two independent seals assembled into one plug-in unit. The seals

shall operate in a liquid reservoir that hydrodynamically lubricates the seal faces at a constant rate. The outer seal shall have rings of corrosion resistant cemented carbide (WCCR). Only the outer seal shall be exposed to the mixed media. Each seal interface shall be held in contact by its own spring system. The seals shall require neither maintenance nor adjustment. One face of the inner seal ring pair shall have spiral grooves laser etched in it, to provide a pumping action preventing leakage from the oil chamber to the stator housing.

2. The mixers offered are provided with a triple seal system consisting of one (1) mechanical seal on the outer side and one (1) mechanical seal and one (1) radial shaft seal in tandem on the inner side, each working independently of the other in its own separate oil chamber. The outer seal faces are industrial duty silicon carbide and the inner seal Sic/Carbon. Each seal interface is held in contact by its own spring system. The seals do not require routine maintenance, or adjustment, and are not be dependent on the direction of rotation for proper sealing. The seal system does not rely upon the mixed media for lubrication and will not be damaged when the mixer is run dry.
  - B. The oil chamber shall be designed to prevent overfilling and to provide lubricant expansion capacity. Separate fill and drain plugs shall be provided to facilitate oil replacement. Mixers which require propeller removal for oil change shall not be acceptable. The seal system shall not rely upon the pumped media for lubrication. The motor shall be able to operate dry without damage while pumping under load.
  - C. Seal lubricant shall be FDA Approved, non-toxic.

## 2.08 MOTOR

- A. The motor shall be an induction cage induction motor, housed in an air filled, watertight chamber. It shall be permanently submersible according to standard IEC 60034 and protection class IP 68.
- B. The motor shall be cooled by the pumped water flowing along the stator housing when the mixer is working. A water jacket or any external cooling system shall not be considered acceptable designs.
- C. The motor shall be capable of no less than 30 evenly spaced starts per hour and be able to operate throughout the entire mixer performance curve from shut-off through run-out.
- D. The motor and the mixer shall be produced by the same manufacturer.
- E. The stator windings and stator leads shall be insulated with moisture resistant Class H (180°C) insulation. The stator shall be trickle impregnated or applied by multiple dips and brakes with Class H varnish and shall be force fitted into the stator housing.
- F. The motor shall be protected by the following sensors:
  1. Thermal switches for thermal control of the stator
  2. Float switch or DI probe in leakage chamber to monitor leakage.

- G. Thermal switches shall be embedded in the stator lead coils to monitor the temperature of each phase winding. These thermal switches shall be used in conjunction with and supplemental to external motor overload protection and shall be connected to a control panel.

## 2.09 POWER CABLE & ENTRY HOUSING

- A. The motor shall be equipped with a sufficient length of screened cable suitable for submersible applications. The power cable shall be sized according to NEC and ICEA standards. The outer jacket of the cable shall be oil resistant chlorinated polyethylene rubber. The cable shall be capable of continuous submergence underwater without loss of watertight integrity to a depth of 65 feet. A cable support grip shall be supplied with the cable.
- B. The cable entry seal shall consist of two cylindrical elastomer bushings or two grommets without epoxies, silicones or other secondary sealing systems. The junction chamber and motor compartment shall be air-filled and separated by a terminal board which shall protect the motor interior from foreign material. Connection shall be made between the threaded compressed type binder posts thus securely affixing the cable wires to the terminal board. The terminal board housing shall be sealed off from the stator housing with two O-rings.

## 2.13 MIXER MOUNT ASSEMBLY

- A. A stainless steel, mixer mount assembly kit shall be supplied to mount the mixer during operation and guide the unit during installation and removal from service. The assembly shall consist of a mast, upper, lower and intermediate bracket(s) made of type 316 stainless steel. Type 304 stainless steel shall not be considered equal.
- B. A nylon coated 316 stainless steel lifting cable, permanently attached to each mixer, shall be provided in sufficient length for attachment of the upper end to the winch cable reel when the davit assembly is installed.
- C. The mast shall be constructed with a positioning locking plate which will work in conjunction with a lock pin on the upper guide holder to positively lock the mast in place at various operating angles.
- D. The mixer may have the capability of redirecting the centerline of its jet to 20 degrees in a vertical plane and 120 degrees (15 degree increments) in a horizontal plane and be repositioned for operation at any elevation along the complete safe slide assembly. All of the above can be accomplished without draining the tank.
- E. The assembly shall be provided with cable holders to secure the mixer electric power cable (one every 5 feet). Their purpose shall be to prevent the electric cable from becoming entangled in the mixer propeller during operation.

## 2.14 PORTABLE LIFTING DAVIT AND LIFTING CABLE

- A. Davit crane assemblies and pedestal bases shall be supplied in accordance with Specification Section 14600. The contractor is responsible for coordinating the lifting

davit with the supplied mixers. The mixers shall be removable from the tanks with the davit.

- B. Coordinate supplied davit with the tank depth and walkway elevation to provide mixer removal and placement on the walkway.

## 2.15 MANUAL CONTROLS

- A. The mixer manufacturer shall supply a manual control panel with each mixer that includes a combination circuit breaker/overload in an NEMA 4X, stainless steel, watertight enclosure. The panel shall provide manual ON/OFF function as well as short circuit and overload protection, and protection by motor stator thermal overload switches and seal leakage detection. Mini CAS module by Xylem/Flygt, or equal installed within. Panel shall have a non-LED elapsed time meter (reading shall be visible and not reset in a power outage). Refer to I-series drawings for additional requirements.

## 2.16 TESTING

- A. The manufacturer shall have the capability of acceptance testing the mixer regarding thrust and power according to ISO 21630:2007. The mixer manufacturer shall perform the following inspections and tests on each mixer before shipment from the factory:
  - 1. Thrust test
  - 2. Motor insulation test for detection of insulation defects.
  - 3. Tightness test of the assembled mixer using a vacuum method.
  - 4. Dry-run test to establish mechanical integrity and correct rotation.
- B. The manufacturer shall on request be able to provide a written report stating that the foregoing steps have been done for each mixer at time of shipment.

## PART 3 - EXECUTION

### 3.01 INSTALLATION

- A. Install mixers according to the manufacturer's written instructions.

### 3.02 STARTUP SERVICE

- A. The service of a factory trained representative shall be made available on the job site to check installation and start up and instruct operating personnel.
- B. Provide in accordance with Specification Section 01665.

### 3.04 SPARE PARTS

- A. Furnish the manufacturer's recommended spare parts required in the first year of operation for each mixer, packaged and labeled, including at least the following:



1. Mechanical seals
2. O-rings / Gaskets
3. Bearings

3.6 CONTRACT CLOSEOUT

- A. Provide in accordance with Section 01700.

END OF SECTION

## SECTION 11305

### SUBMERSIBLE SEWAGE DEWATERING PUMPS

#### PART 1 GENERAL

##### 1.01 SUMMARY

- A. Furnish, install, test, and place in satisfactory operation six (6) submersible sewage pumps, as shown on the Contract Drawings for dewatering the new Biological Treatment Reactor, Secondary Anoxic Tanks and Re-aeration Tanks.
- B. The work shall include all accessories, and appurtenances necessary to make a complete system including base elbow and guide rails. Work shall conform to requirements for installation, materials, and equipment approvals of state, local, Underwriters' Laboratories, Inc., or other applicable codes, whether or not called for in detail on the drawings or in these specifications.

##### 1.02 RELATED SECTIONS

- A. SECTION 01300 – SUBMITTALS
- B. SECTION 01631 – USE OF OTHER THAN FIRST NAMED MANUFACTURERS
- C. SECTION 01665 – SERVICES OF MANUFACTURER’S REPRESENTATIVE
- D. SECTION 01680 – EQUIPMENT AND SYSTEM CHECKOUT, CERTIFICATION, AND TESTING
- E. SECTION 01730 – OPERATION AND MAINTENANCE MANUALS
- F. SECTION 09900 – PAINTING
- G. SECTION 13321 – INSTRUMENTATION AND CONTROL SYSTEM
- H. DIVISION 16 – ELECTRICAL

##### 1.03 REFERENCES

- A. ASTM A48 - Standard Specification for Gray Iron Castings.
- B. AFBMA
- C. Hydraulic Institute Standards.
- D. National Electrical Manufacturer's Association.

##### 1.04 QUALITY ASSURANCE

- A. Pumps shall be the product of a single manufacturer with a minimum of ten years of experience with equipment of the size and type specified operating in a similar arrangement.

- B. Equipment and accessories shall be the standard cataloged products of the manufacturer except as otherwise specified or indicated.

#### 1.05 SUBMITTALS

- A. Submit to the Engineer for approval as provided in Section 01300, shop drawings showing details of construction and installation of all equipment furnished under this Section. The following shall be included:
  - 1. Manufacturer's rating curves showing pump characteristics of pressure, capacity, brake horsepower, allowable operating range, preferred operating range, and efficiency. This information shall be prepared specifically for the pump proposed. Catalog sheet showing a family of curves will not be acceptable.
  - 2. Literature and drawings describing the equipment in sufficient detail, including materials of construction and parts list, to indicate full conformance with the detail specifications.
  - 3. Complete parts list for equipment furnished.
  - 4. Motor data such as HP, Volts, RPM, FLC, Efficiency, and p.f. as described herein.
  - 5. Complete wiring diagrams and schematics of all controllers, control panels, control devices, and operators furnished under this Section.
  - 6. Complete wiring diagrams and schematics of all power and control systems.
  - 7. Floor plans, sections and elevations showing a complete layout to scale of all equipment, piping, electrical conduits and methods to provide watertight seals.
  - 8. Motor wiring diagrams for power and high temperature switches.
  - 9. Services of manufacturer's representative and warranties.
- B. In the event that it is impossible to conform to certain details of the specifications due to different manufacturing techniques, describe completely all non-conforming aspects.
- C. Submit under provisions of Section 01300.
- D. Pump and Motor Characteristics and Performance Data:
  - 1. Provide guaranteed performance curves based on actual shop tests of mechanically duplicate pumping units, showing they meet specified requirements for capacity, head, horsepower, efficiency, and NPSH. For units of same size and type, provide curves for a single unit.
  - 2. Catalog performance curves at required speed showing maximum and minimum impeller diameters available.
- E. Manufacturer's written warranty.
- F. Shop Test Results: Provide six (6) certified copies of pump performance test data, pump performance curves, hydrostatic test results and motor test results.
- G. Field Inspection Reports: Submit under provisions of Section 01700.

1.06 DELIVERY, STORAGE, AND HANDLING

- A. Ship equipment, material, and spare parts complete except where partial disassembly is required by transportation regulations or for protection of equipment.
- B. Pack spare parts in containers bearing labels clearly designating contents and pieces of equipment for which intended.
- C. Deliver spare parts at same time as pertaining equipment.
- D. Inspect and inventory items upon delivery to site and provide Engineer with inventory list.
- E. Store and safeguard equipment, material, and spare parts in accordance with manufacturer's instructions and deliver to Owner after completion of the work.

1.07 WARRANTY

- A. Manufacturer shall fully warrant the pumps and motors to the Owner against defects and workmanship and materials for a period of five (5) years under normal use and service. If any pump part, including the motor requires replacement, the part shall be replaced at no charge to the Owner. A copy of each warranty shall be provided to the Owner at start-up.

PART 2 PRODUCTS

2.01 MANUFACTURERS

- A. Xylem/Flygt
- B. Approved equal.
- C. Should equipment which differs from the first named in this Section be offered and determined to be the equal of that specified, such equipment shall be acceptable only on the basis that any revision in the design and/or construction of the structure, piping, appurtenant equipment, electrical work, etc, required to accommodate such a substitution shall be made at no additional cost to the Owner and be as approved by the Engineer.

2.02 DESIGN

- A. The pumps shown and specified are based on Flygt model NP 3102 MT 3 Adaptive 464.
- B. The pumps shall be capable to operate without any limitations between 50% and 125% of the best efficiency point of the performance curve.

	Flow (gpm)	TDH (ft)	Hydraulic Efficiency (%)
Required Duty Point	350	23.4	65.4

- C. The required shaft power in the guaranteed duty point shall be less than 3.67 HP. The motor speed shall be max.: 1745 rpm. A performance chart shall be provided upon

request showing curves for torque, current, power factor, input/output HP and efficiency. This chart shall also include data on starting and no-load characteristics

## 2.03 PUMP CONSTRUCTION

### A. Impeller

1. The impeller shall be wear resistant and made of high chromium cast iron with at least 24% chrome against sand and grit.
2. Impeller and insert ring shall be A 532 Alloy III A (25% Chrome)
3. Impellers that have surface hardening (by thermal, coating, etc.) will not be allowed.
4. The impeller blades shall be self-cleaning upon each rotation as they pass across a sharp relief groove in the Insert ring and shall keep the impeller blades clear of debris. The insert ring shall have a guide pin which moves fibers from the center of the impeller to the leading edges of the impeller. The impeller shall move axially upwards to allow larger debris to pass through and immediately return to normal operating position. The clearance between the insert ring and the impeller leading edges shall be adjustable.
5. The impeller shall be mounted on the motor shaft. Couplings shall not be accepted.

### B. Shaft and Shaft Seal

1. Pump and motor shaft shall meet ASTM A479 S43100-T
2. The shaft shall be sealed by a tandem mechanical shaft seal system consisting of two seals, each having an independent spring system. The seals shall require neither maintenance nor adjustment and shall be capable of operating in either clockwise or counter clockwise direction of rotation without damage or loss of seal function.
3. The pump side shaft seal shall be corrosion resistant tungsten carbide WCCR.
4. The motor side shaft seal shall be carbon-aluminum oxide (AL<sub>2</sub>O<sub>3</sub>)

### C. Volute/Casing

1. The volute material shall be made cast iron conforming to ASTM A48 Class 35B.
2. The outlet flange of the discharge connection shall be 4-inch, flat-faced per ANSI drilling.

### D. Power Cable & Entry Housing

1. The motor shall be equipped with 50 feet of screened cable suitable for submersible pump applications. The power cable shall be sized according to NEC and ICEA. The outer jacket of the cable shall be oil resistant chlorinated polyethylene rubber. The cable shall be capable of continuous submergence underwater without loss of watertight integrity to a depth of 65 feet.

2. The cable entry shall consist of dual cylindrical elastomer sleeves, flanked by washers, all having a close tolerance fit against the cable and the cable entry. Epoxies, silicones, or other secondary sealing systems shall not be considered acceptable.
- E. The pump shaft shall rotate on two bearings. Motor bearings shall be permanently grease lubricated and have a nominal L10 lifetime of 50,000 hours. The upper bearing shall be a single deep groove ball bearing. The lower bearing shall be a two row angular contact bearing to compensate for axial thrust and radial forces. Single row lower bearings are not acceptable.
- F. Each pump shall be provided with a lubricant chamber for the shaft sealing system. The lubricant chamber shall be designed to prevent overfilling and to provide lubricant expansion capacity. The drain and inspection plug, with positive anti-leak seal shall be easily accessible from the outside. The seal system shall not rely upon the pumped media for lubrication. Seal lubricant shall be non-hazardous.
- G. Where a seal cavity is present in the seal chamber, the area about the exterior of the lower mechanical seal in the cast iron housing shall have cast in an integral concentric spiral groove. This groove shall protect the seals by causing abrasive particulate entering the seal cavity to be forced out away from the seal due to centrifugal action.
- H. The junction chamber containing the terminal board shall be hermetically sealed from the motor by an elastomeric compression seal. Connection between the cable conductors and stator leads shall be made with threaded compression type binding posts permanently affixed to a terminal board. The motor and the pump shall be produced by the same manufacturer.
- I. Sealing of the pumping unit to the discharge connection shall be accomplished by a machined metal to metal watertight contact. Sealing of the discharge interface with a diaphragm, O-ring or profile gasket will not be acceptable.
- J. It shall be possible to lift and lower the pumps on parallel guide bars and connect them to wet well mounted discharge connection. There shall be no need for personal to enter the wet well when removing or reinstalling the pumps.
- K. The pump housing shall be prepared for the assembling of a sump mixing valve. The discharge flange of the pump housing shall be 4".

#### 2.04 MOTORS

- A. Each pump shall be equipped with a 5 HP submersible electric motor, capable to operate on a 460 volt, 3 phase, 60 hertz voltage supply.
- B. The pump motor shall be induction type with a squirrel cage rotor, shell type design, housed in an air filled, watertight chamber. It shall be permanently submersible according standard IEC 60034 and protection class IP 68.
- C. The motor shall be capable of no less than 30 evenly spaced starts per hour and be able to operate throughout the entire pump performance curve from shut-off through run-out even when the motor is not submerged.

- D. The motor shall be protected by 3 thermal switches embedded in the stator set to open at 260°F and one leakage sensor floating type located in the stator chamber. The sensor and the switches shall be connected to the control panel which shall stop the motor and send an alarm when the sensors are activated.
- E. The stator windings shall be insulated with moisture resistant Class H insulation rated for 356°F.
- F. The stator housing shall meet ASTM A-48, Class 35B

## 2.05 SHOP TESTS

### A. Pump Tests

1. Each completed and assembled pump/motor unit shall undergo the following factory tests at the manufacturer's plant prior to shipment. The Manufacturer shall provide on demand a copy of his quality control plan for these tests and an ISO 9001 factory certificate:
  - a. Minimum 3-point hydraulic performance test
  - b. No-Leak seal integrity test
  - c. Electrical integrity test
2. Demonstrate that all equipment is capable of continuous operation in satisfactory manner without mechanical or electrical defects or operational difficulties.
3. Repeat tests, if necessary, until satisfactory results are obtained.
4. Correct or replace all defects or defective equipment revealed by or noted during tests at no additional cost to the Owner.
5. Conduct all tests in accordance with the latest standards of the Hydraulic Institute.
6. If the specified tests indicate the pump or motor will not meet the specifications, the Engineer has the right to require complete tests for all pumps and motors at no additional cost to the Owner.

## 2.06 PAINTING

- A. All castings must be blasted before coating. All wet surfaces are to be coated with two-pack oxyrane ester Duasolid 50. The total layer thickness should be at least 120 microns. Zink dust primer shall not be used.
- B. Prime and finish paints for pumps and motors shall be factory applied. Paint shall be applied so as to obtain the coverage per gallon and the dry film thickness recommended by the manufacturer.
- C. Ferrous surfaces obviously not to be painted shall be given a shop coat of grease or other suitable rust-resistant coating.
- D. Coatings damaged in shipment or installation shall be cleaned to white metal and touched up in the field with the same materials as original coatings.

## 2.07 CONTROLS

- A. Pumping System Control Panel shall be provided under Division 13 – Instrumentation.

## PART 3 EXECUTION

### 3.01 INSTALLATION

- A. Install items in accordance with manufacturer's instructions.
- B. The pump(s) shall be automatically and firmly connected to the discharge connection, guided by no less than two parallel guide bars extending from the top of the station to the wet well mounted discharge connection. The material of the guide bars shall be Stainless steel AISI 316.
- C. The length of the guide bars shall be coordinated by the contractor and they shall be fastened at the top of the station with a guide bar holder made of Stainless steel AISI 316.
- D. For each pump the contractor shall supply and install a stainless steel lifting cable and cable holder made with 4 hooks of Stainless steel AISI 316.
- E. For each pump the contractor shall supply and install a discharge connection made of cast iron ASTM A-48, Class 35B.
- F. The sealing of the pumping unit to the discharge connection shall be accomplished by a machined metal to metal contact. Sealing of the discharge interface with a diaphragm, O-ring or profile gasket will not be accepted. The entire weight of the pump/motor unit shall be borne by the pump discharge elbow. No portion of the pump/motor unit shall bear on the sump floor directly or on a sump floor mounted stand.

### 3.02 MANUFACTURER'S FIELD SERVICES

- A. Provide services of factory trained service engineer to assist in location of anchor bolts; setting, leveling, field erection, etc.; and coordination of piping, electrical and miscellaneous utility connections. Provide in accordance with Section 01665.
- B. Provide services of manufacturer's representative as specified in Section 01665.
- C. Provide operation and maintenance training as specified in Section 01665.

### 3.03 SPARE PARTS

- A. Furnish one set of all special tools required for the proper servicing of all equipment supplied under these Specifications, packed in a suitable steel tool chest with a lock. Special tools shall include any tools not available in ordinary hardware stores.
- B. Furnish the manufacturer's spare parts including at least the following:
- (1) Mechanical seal set per pump

END OF SECTION



## SECTION 11312

### VERTICAL CENTRIFUGAL PUMPS (BID PACKAGE #3)

#### PART 1 GENERAL

##### 1.01 SUMMARY

- A. Furnish, install, test, and place in satisfactory operation vertical centrifugal, dry pit, non-clog pumping units, as shown on the Contract Drawings for pumping Return Activated Sludge (RAS) and Waste Activated Sludge (WAS) with minimum spherical diameter solids passage of 2.5-inches.
- B. Each unit shall be furnished with a pump and driver. Drivers shall be variable speed and mounted on a heavy-duty high ring base and connected to the pump with a flexible coupling. Driver shall have devices for detection of high temperature thermal overload and high motor current draw alarm conditions.
- C. The work shall include all accessories, and appurtenances necessary to make a complete system. Work shall conform to requirements for installation, materials, and equipment approvals of state, local, Underwriters' Laboratories, Inc., or other applicable codes, whether or not called for in detail on the drawings or in these specifications.

##### 1.02 RELATED SECTIONS

- A. SECTION 01300 – SUBMITTALS
- B. SECTION 01631 – USE OF OTHER THAN FIRST NAMED MANUFACTURER
- C. SECTION 01665 – SERVICES OF MANUFACTURER’S REPRESENTATIVE
- D. SECTION 01680 – EQUIPMENT AND SYSTEM CHECKOUT, CERTIFICATION, AND TESTING
- E. SECTION 01730 – OPERATION AND MAINTENANCE MANUALS
- F. SECTION 09900 – PAINTING
- G. SECTION 13321 – INSTRUMENTATION AND CONTROL SYSTEM
- H. DIVISION 16 – ELECTRICAL

##### 1.03 REFERENCES

- A. ASTM A48 - Standard Specification for Gray Iron Castings.
- B. ASTM A276 - Specification for Stainless and Heat-Resisting Steel Bars and Shapes.
- C. AFBMA
- D. Hydraulic Institute Standards.

E. National Electrical Manufacturer's Association.

#### 1.04 QUALITY ASSURANCE

- A. Pumps shall be the product of a single manufacturer with a minimum of ten years of experience with equipment of the size and type specified operating in a similar arrangement.
- B. Equipment and accessories shall be the standard cataloged products of the manufacturer except as otherwise specified or indicated.

#### 1.05 SUBMITTALS

- A. Submit to the Engineer for approval as provided in Section 01300, shop drawings showing details of construction and installation of all equipment furnished under this Section. The following shall be included:
  - 1. Manufacturer's rating curves showing pump characteristics of pressure, capacity, brake horsepower, allowable operating range, preferred operating range, and efficiency. This information shall be prepared specifically for the pump proposed. Catalog sheet showing a family of curves will not be acceptable.
  - 2. Literature and drawings describing the equipment in sufficient detail, including materials of construction and parts list, to indicate full conformance with the detail specifications.
  - 3. Complete parts list for equipment furnished.
  - 4. Motor data such as HP, Volts, RPM, FLC, Efficiency, and p.f. as described herein.
  - 5. Complete wiring diagrams and schematics of all controllers, control panels, control devices, and operators furnished under this Section.
  - 6. Complete wiring diagrams and schematics of all power and control systems.
  - 7. Floor plans, sections and elevations showing a complete layout to scale of all equipment, piping, electrical conduits and methods to provide watertight seals.
  - 8. Motor wiring diagrams for power and high temperature switches.
  - 9. Services of manufacturer's representative and warranties.
- B. In the event that it is impossible to conform to certain details of the specifications due to different manufacturing techniques, describe completely all non-conforming aspects.
- C. Submit under provisions of Section 01300.
- D. Pump and Motor Characteristics and Performance Data:
  - 1. Provide guaranteed performance curves based on actual shop tests of mechanically duplicate pumping units, showing they meet specified requirements for capacity, head, horsepower, efficiency, and NPSH. For units of same size and type, provide curves for a single unit.

- 2. Catalog performance curves at required speed showing maximum and minimum impeller diameters available.
- E. Manufacturer's written warranty.
- F. Shop Test Results: Provide six (6) certified copies of pump performance test data, pump performance curves, hydrostatic test results and motor test results.
- G. Field Inspection Reports: Submit under provisions of Section 01700.

#### 1.06 DELIVERY, STORAGE, AND HANDLING

- A. Ship equipment, material, and spare parts complete except where partial disassembly is required by transportation regulations or for protection of equipment.
- B. Pack spare parts in containers bearing labels clearly designating contents and pieces of equipment for which intended.
- C. Deliver spare parts at same time as pertaining equipment.
- D. Inspect and inventory items upon delivery to site and provide Engineer with inventory list.
- E. Store and safeguard equipment, material, and spare parts in accordance with manufacturer's instructions and deliver to Owner after completion of the work.

#### 1.07 WARRANTY

- A. Warranty shall be manufacturer's standard and shall extend 60 months from startup not to exceed 66 months from shipment. A copy of each warranty shall be provided to the Owner at start-up.

### PART 2 PRODUCTS

#### 2.01 MANUFACTURERS

- A. Fairbanks Nijhuis, Kansas City, KS
- B. Flowserve, Irving, TX
- C. Xylem/Flygt, Scottsdale, AZ
- D. KSB, Richmond, VA
- E. Wilo USA, Cedarburg, WI
- F. Approved equal.
- G. Should equipment which differs from the first named in this Section be offered and determined to be the equal of that specified, such equipment shall be acceptable only on the basis that any revision in the design and/or construction of the structure, piping, appurtenant equipment, electrical work, etc. required to accommodate such a substitution shall be made at no additional cost to the Owner and be as approved by the Engineer.

2.02 DESIGN

- A. The pumps shown and specified are based on Fairbanks Nijhuis model 5442 (WAS) & Fairbanks Nijhuis model 5711 (RAS).
- B. New pumps shall be capable of performing under the following operating conditions:

**Secondary Sludge Pump Stations No.1**

3-Pumps (WAS)

Tag Nos. WSP-4121, WSP-4122, & SCP-4131

<b>Pumps</b>	<b>Capacity (gpm)</b>	<b>TDH (ft)</b>	<b>Motor Horsepower</b>	<b>Speed (RPM)</b>
Single Pump Operation	220	34	7.5	1,175

**Secondary Sludge Pump Stations No.1**

3-Pumps (RAS)

Tag Nos. RSP-4111, RSP-4112, & RSP-4113

<b>Pumps</b>	<b>Capacity (gpm)</b>	<b>TDH (ft)</b>	<b>Motor Horsepower</b>	<b>Speed (RPM)</b>
Single Pump Operation	4,400	32	50	1,185
Parallel Pump Operation	3,200	40	Operating condition for each pump	

**Secondary Sludge Pump Stations No.2**

3-Pumps (WAS)

Tag Nos. WSP-4221, WSP-4222, & SCP-4231

<b>Pumps</b>	<b>Capacity (gpm)</b>	<b>TDH (ft)</b>	<b>Motor Horsepower</b>	<b>Speed (RPM)</b>
Single Pump Operation	220	40	7.5	1,175

**Secondary Sludge Pump Stations No.2**

3-Pumps (RAS)

Tag Nos. RSP-4211, RSP-4212, & RSP-4213

<b>Pumps</b>	<b>Capacity (gpm)</b>	<b>TDH (ft)</b>	<b>Motor Horsepower</b>	<b>Speed (RPM)</b>
Single Pump Operation	4,400	25	40	890

Parallel Pump Operation	3,200	31	Operating condition for each pump
-------------------------	-------	----	-----------------------------------

## 2.03 PUMP CONSTRUCTION

### A. Impeller

1. The impeller shall be single stage end suction mixed flow enclosed type, with a minimum of two vanes.
2. The clearance between the impeller and the outside diameter cutwater shall be capable of passing a minimum 2.5-inch diameter sphere.
3. The impeller shall be close-grained cast iron conforming to ASTM A48 Class 30, machined and polished to remove hollows or projections that might encourage cavitation.
4. Waterways through the impeller shall have extremely smooth contours, devoid of sharp corners so as to prevent rags or stringy, fibrous material from catching or clogging.
5. The impeller is to be balanced and secured to the shaft by means of a bolt, washer, and key, which shall prevent the impeller from being loosened by torque from forward or reverse rotation.
6. Wiper vanes on the back impeller shroud are not acceptable.

### B. Wear Rings

1. Wear rings shall be provided on both the impeller and casing so that clearance can be maintained throughout the life of the rings and maintain recirculation.
2. Wear rings shall be stainless steel.
3. Clearance adjustment shall be attained through impeller adjustment capscrews located at the end of the bearing frame.
4. Wear rings shall be attached using an interface fit and Loctite or by means of recessed stainless screws.

### C. Volute/Casing

1. The volute material shall be matched to the impeller and made of close-grained cast iron conforming to ASTM A48 Class 30.
2. The volute is to be of one-piece circular constant flow, equalizing pressure design with smooth fluid passages large enough to pass any size solid that can pass through the impeller.
3. The volute shall be side flanged centerline discharge and capable of rotation in 45° increments to accommodate piping orientation.

4. The volute shall be furnished with large cleanout openings located at the impeller centerline, to allow access to the impeller.
5. The casing shall have plugged vent, drain, and gauge connections.
6. Flanges shall be 125 lbs., flat-faced flanges per ANSI drilling. The casing shall be designed to permit the removal of the rotating assembly without disturbing the suction or discharge piping.
7. The casing shall be hydrostatically tested to 1.5 times the design head or 1.25 times the shutoff-head whichever is greater.
8. Diffusion vanes are not acceptable.

#### D. Backhead

1. A separately cast close-grained cast iron backhead with large access openings and integral sealing box conforming to ASTM A48 Class 30 shall be provided. The sealing box shall be designed for use with conventional packing or mechanical seal without requiring re-matching.
2. The sealing box shall be furnished with a ¼" injection and vent tap for a clear water or grease connection to a water seal ring to prevent air from entering the pump through the pump through the sealing box.
3. A ¾" minimum backhead drain tap shall be provided. Sealing box leakage will be collected by the backhead drain trough and piped directly to drain, eliminating any drippage to the floor.
4. A minimum of 5 rings of graphite impregnated synthetic packing and a split-Teflon water seal ring shall be furnished. Glands shall be two-piece split interlocking made of cast iron (bronze) held in place by studs and nuts.

#### E. Bearing Frame Assembly

1. The bearing housing shall be close-grained cast iron conforming to ASTM A48 Class 30 and of heavy, rugged design for carrying the bearings and machined for accurate and permanent bearing alignment completely enclosing the shaft between the bearings.
2. The bearing housing shall be of dust proof design incorporating lip type grease seals in contact with the shaft to prevent the entrance of contaminants. Jacking bolts for external impeller adjustment are required. Zerk-type grease fittings for bearing lubrication shall be supplied at the bearing housings.
3. The pump shaft shall be high-strength alloy steel with a minimum 100,000 PSI tensile strength and 75,000 PSI yield strength of sufficient diameter to carry the maximum loads imposed and to prevent vibration and fatigue. The shaft shall be accurately machined along its entire length and precision ground at bearing locations. Keyways shall be provided at both ends.
4. A renewable straight shaft sleeve, positive adhesive sealed to prevent leakage between the shaft and the sleeve, shall protect the shaft through the sealing box area. The shaft sleeve shall be stainless steel with a brinell hardness of 300-350.

5. Radial bearings shall be grease lubricated ball bearings designed to carry the hydraulic radial loads encountered in the service conditions. Thrust bearings shall be designed to carry the pump hydraulic axial and dead load thrust.
6. Bearings shall be designed for a nominal B10 life of 40,000 hrs. per AFBMA at best efficiency point.

#### F. Base and Elbow

1. The pump manufacturer shall provide a rugged heavy duty fabricated steel base, with openings large enough to permit access to the suction elbow and cleanout, bolted directly to the volute. The base shall be designed to support the assembled weight of the pump and driver.
2. A cast iron suction elbow with ½” gauge connection, contoured handhole cleanout, and 125 lb. flat-faced flange conforming to ANSI drilling shall be furnished.

#### G. Fits and Hardware

1. The volute/casing, backhead, and frame shall be manufactured with concentric shoulder fits to assure accurate alignment. All machine bolts, nuts and cap screws shall be of the hex head type and will not require the use of any special tools.

#### H. High Ring Base

1. The motor high ring base shall be cast iron or fabricated steel of adequate height to permit access to the coupling and furnished with a coupling guard.

### 2.04 MOTORS

- A. Motors shall be vertical, 460 volt, 3 phase, inverter duty rated, designed to conform to NEMA standards and specifications.
- B. Each phase of the motor shall contain a thermal switch imbedded in the motor windings. The thermal switches shall be connected to the control panel to provide a high stator temperature shutdown signal and are used in conjunction with external motor overload protection.
- C. Temperature measuring devices shall be supplied for the motor winding and bearings to provide actual temperature measurement at these locations.

### 2.05 SHOP TESTS

#### A. Pump Tests

1. Certified Performance Tests: Conduct performance tests on each pump to determine head, capacity, speed, and brake horsepower at not less than six points on the operating curve including rating point and best efficiency point from shutoff to 150% of design flow. Test data shall be sufficiently comprehensive to produce guaranteed performance curves showing head versus capacity, efficiency, and brake horsepower for the rated speed. Engineer shall be supplied

with the complete test procedure in advance of the testing. Test shall be witnessed and certified by a Professional Engineer.

2. Hydrostatic Pressure Tests: Conduct hydrostatic pressure tests on each pump.
3. Demonstrate that all equipment is capable of continuous operation in satisfactory manner without mechanical or electrical defects or operational difficulties.
4. Repeat tests, if necessary, until satisfactory results are obtained.
5. Correct or replace all defects or defective equipment revealed by or noted during tests at no additional cost to the Owner.
6. Conduct all tests in accordance with the latest standards of the Hydraulic Institute.
7. If the specified tests indicate the pump or motor will not meet the specifications, the Engineer has the right to require complete tests for all pumps and motors at no additional cost to the Owner.

#### 2.06 PAINTING

- A. Prime and finish paints for pumps and motors shall be factory applied. Paint shall be applied so as to obtain the coverage per gallon and the dry film thickness recommended by the manufacturer.
- B. Ferrous surfaces obviously not to be painted shall be given a shop coat of grease or other suitable rust-resistant coating.
- C. Coatings damaged in shipment or installation shall be cleaned to white metal and touched up in the field with the same materials as original coatings.

#### 2.07 CONTROLS

- A. All controls are to be provided by others.

#### 2.08 MISCELLANEOUS

- A. Manufacturer shall provide a dolly designed to maneuver the pumps above grade.
- B. Submit design for Engineer's review.

### PART 3 EXECUTION

#### 3.01 INSTALLATION

- A. Install items in accordance with manufacturer's instructions.
- B. Install pumping units in the bottom floor of the dry well structure and provide supports as required.
- C. After alignment is correct, grout as specified in Section 03300.
  1. Fill entire base and leave no gaps or voids.
  2. Do not embed leveling nuts in grout.



### 3.02 MANUFACTURER'S FIELD SERVICES

- A. Provide services of factory trained service engineer to assist in location of anchor bolts; setting, leveling, field erection, etc.; and coordination of piping, electrical and miscellaneous utility connections. Provide in accordance with Section 01665.
- B. Provide services of manufacturer's representative as specified in Section 01665.
- C. Provide operation and maintenance training as specified in Section 01665.

### 3.03 FIELD TESTING

- A. Certified Performance Tests: Conduct performance tests on each pump to determine head, capacity, speed, and brake horsepower at not less than six points on the operating curve including rating point and best efficiency point. Test data shall be sufficiently comprehensive to produce guaranteed performance curves showing head versus capacity, efficiency, and brake horsepower for the rated speed.
- B. Hydrostatic Pressure Tests: Conduct hydrostatic pressure tests on each pump.
- C. The Contractor shall conduct a running pump test for a minimum of 4 hours, in the presence of the Engineer. The test shall indicate that the pumps conform to the head and capacities specified. The contractor/supplier shall field measure the pump's operating voltage, starting amperes and running amperes including the pressure/flow readings with 0%, 25%, 50%, 75% and 100% discharge valve positions.
- D. The contractor/supplier shall provide both factory and field acceptance testing of the Variable Frequency Drives, RVNR Starters, I&C pumps control and alarm panels as specified in Division 13.
- E. A 14-day operating period of the pumps will be required before acceptance. If pump performance does not meet the Specifications, the Contractor shall take corrective measures or the pumps shall be removed and replaced with pumps that satisfy the conditions specified. The decision of the Engineer shall be final.
- F. The manufacturer shall furnish the services in the presence of the Engineer, of a qualified factory representative for a minimum of 8 hours to confirm the completed pump installation to be satisfactory. Compensation for such services shall be paid for by the Contractor.
- G. The pumps supplier, after successfully completing the pumps and I&C panels field testing, shall issue a letter of certification on the equipment's installation and operation with regards to its acceptability for its guarantee.
- H. Pump tests include all I&C testing. Test will include the testing of all associated controls.
- I. The pump motors shall also be field tested by the electrical contractor's NETA Testing Firm for acceptance prior to being placed into service.

### 3.04 SPARE PARTS

- A. Furnish the manufacturer's recommended spare parts required in the first year of operation including at least the following:

- (1) Seal per pump

END OF SECTION

## SECTION 11315

### SUBMERSIBLE PROPELLER PUMPS

#### PART 1 - GENERAL

##### 1.01 SECTION INCLUDES

- A. This specification covers furnishing, installing, testing, and placing in satisfactory operation, four (4) submersible, close coupled, propeller pumps for mixed liquor internal recycle, as shown on the contract drawings.

##### 1.02 RELATED SECTIONS

- A. SECTION 01300 – SUBMITTALS
- B. SECTION 01631 – USE OF OTHER THAN FIRST NAMED MANUFACTURERS
- C. SECTION 01665 – SERVICES OF MANUFACTURER’S REPRESENTATIVES
- D. SECTION 01680 – EQUIPMENT AND SYSTEM CHECKOUT, CERTIFICATION, AND TESTING
- E. SECTION 01730 – OPERATION AND MAINTENANCE MANUALS
- F. SECTION 13321 – INSTRUMENTATION AND CONTROL SYSTEM

##### 1.03 REFERENCES

- A. American Iron & Steel Institute (AISI)
- B. American Society for Testing and Materials (ASTM)
- C. National Electric Code (NEC)
- D. National Electrical Manufacturers Association (NEMA)
- E. Anti-Friction Bearing Manufacturers Association (AFBMA)
- F. International Standards Organization (ISO) - IS09001

##### 1.04 SUBMITTALS

- A. Shop Drawings in accordance with specification Section 01300.
- B. Operation and Maintenance Manual in accordance with specification Section 01730.

##### 1.05 QUALITY ASSURANCE

- A. It is the intent of these specifications to procure a quality product by an established manufacturer, incorporating the latest design.
- B. All materials shall be designed to withstand the stresses encountered in fabrication, erection and operation. All equipment shall be of corrosion resistant materials with

corrosion resistant coatings approved by the Engineer.

- C. The mixer specified herein shall be the design and fabrication of a single manufacturer which shall have sole source responsibility for said equipment. The manufacturer shall have mixing equipment of this principal design and of comparable capacity in successful operation in the field for a minimum period of 10 years.

## PART 2 - PRODUCTS

### 2.01 MANUFACTURERS

- A. Xylem/Flygt
- B. Sulzer/ABS
- C. KSB, Inc
- D. Approved Equal
- E. Should equipment which differs from the first named in this Section be offered and determined to be the equal of that specified, such equipment shall be acceptable only on the basis that any revision in the design and/or construction of the structure, piping, appurtenant equipment, electrical work, etc, required to accommodate such a substitution shall be made at no additional cost to the Owner and be as approved by the Engineer.

### 2.02 DESIGN

- A. Each biological treatment basin shall be equipped with two (2) submersible, closed-coupled propeller pumps.
- B. The pumps specified and shown on the contract drawings are based on Xylem/Flygt model PP 4660.
- C. The pump unit shall be designed for horizontal wet well installation on a wall mounted discharge column. It shall be possible to lower the pump into the process tank and put into operation even when tank is filled with water. There shall be no need for personal to enter the process tank when removing or reinstalling the pump. The pump shall not require any bolts, nuts or fasteners for connection to the discharge column.
- D. Each pump shall be inverter duty rated designed for handling mixed media of a maximum temperature of 40° C.
- E. Each pump shall be equipped with a 15 HP submersible electric motor, capable to operate on a 460 volt, 3 phases, 60 hertz voltage supply.
- F. The pump shall be capable to transport wastewater with 0.5% solids.
- G. Each pump shall be capable of performing under the following operating conditions.

<b>Capacity (gpm)</b>	<b>TDH (ft)</b>	<b>Max. Motor (hp)</b>	<b>Max. Pump Speed (RPM)</b>	<b>Min. Hydraulic Efficiency (%)</b>
6,944 (max.)	3.10 (max.)	16	650	52.8
4,340 (avg.)	1.50 (avg.)			

- H. The required shaft power (P2) in the guaranteed duty point shall be less than 16 HP. The pump speed shall be max.: 650 rpm. A performance chart shall be provided upon request showing curves for torque, current, power factor, input/output HP and efficiency. This chart shall also include data on starting and no-load characteristics.

### 2.03 MATERIALS

- A. Propeller & Inlet shroud: Stainless steel AISI 316 L, or AISI 316Ti
- B. Motor casing: Stainless steel AISI 316 L, AISI 316Ti, or ASTM A48 class 35B
- C. Fixing plate / Cable entry: Stainless steel AISI 316 L
- D. Lifting handle: Stainless steel AISI 316
- E. Stator housing: ASTM A-48 class 35B
- F. Oil housing: Vinyl ester based SMC, ASTM A-48 class 35B, or 316SS
- G. Shaft: ASTM AISI 431 or 420, or 316SS
- H. Cable outer sheath: Chlorinated polyethylene rubber (CPE)
- I. Shaft seal (Pump side): Corrosion resistant Silicon or Tungsten carbide WCCR
- J. Shaft seal (Motor side): Corrosion resistant Silicon or Tungsten carbide WCCR
- K. Nuts and bolts: Stainless steel AISI 316 or better
- L. All castings must be blasted before coating. All wet surfaces are to be coated with two-pack oxyrane ester Duasolid 50, or two part epoxy. The total layer thickness should be at least 120 microns. Zink dust primer shall not be used.

### 2.04 PROPELLER & INLET SHROUD

- A. The propeller shall be of a 3-bladed fixed pitch and factory balanced design. The blades shall be noticeably backward curved so that any clogging tendency is minimized.
- B. The pump assembly shall incorporate a bell-shaped inlet shroud, 360 degrees around the propeller to maximize hydraulic efficiency and minimize power consumption.

### 2.05 BEARINGS

- A. All bearings shall have a minimum L10 rated life of 100,000 Hrs. The outboard propeller bearing shall be an angular contact bearing. The motor shaft end shall be supported by two bearings. A roller bearing shall take up the radial loads while an angular contact bearing shall take up the axial loads.

### 2.06 SHAFT

- A. Pump and motor shaft shall be the same unit. The pump shaft is an extension of the motor shaft. Couplings shall not be acceptable.

## 2.07 SHAFT SEAL

### A. Shaft Seals shall be one of the following types:

1. Type 1: The motor shaft shall be sealed by a double mechanical cartridge seal which contains positively driven, corrosion resistant seal face rings for both the inner and outer seals. One face of the inner seal ring pair shall have spiral grooves laser etched in it, to provide a pumping action to move leakage from the stator housing back into the oil chamber. In order to avoid seal failure due to sticking, clogging, and misalignment from elements contained in the mixed media, only the seal faces of the outer seal assembly and its retaining clips shall be exposed to the mixed media. All other components shall be contained in the oil chamber.
  2. Type 2: The pump shall be provided with a double seal system consisting of a mechanical seal on the outer side and a radial shaft seal on the inner side, each working independently of the other. The mechanical seal shall contain both stationary and rotary silicon carbide faced rings. Each pump shall be equipped with a solids deflection ring to prevent seal failure due to interference from solids contained in the pumped liquid and to minimize solids that come into contact with the seals. Only the seal faces of the outer mechanical seal assembly and its retaining clips shall be exposed to the pumped liquid.
- B. The oil chamber shall contain two compartments consisting of an inner and an outer section with four ports to connect and facilitate oil flow. In the event that the pumped media bypasses the other seal, this design will allow the outer compartment to collect the heavier (denser) fluids by means of a simple gravity process. Pumps which require propeller removal for oil change shall not be acceptable. Separate fill and drain plugs shall be provided to facilitate oil replacement.
- C. Seal lubricant shall be FDA Approved, non-toxic.

## 2.08 MOTOR

- A. The motor shall be induction type with a squirrel cage rotor, shell type design, housed in an air filled, watertight chamber. It shall be permanently submersible according to standard IEC 60034 and protection class IP 68.
- B. The motor shall be cooled by the pumped water flowing along the stator housing when the pump is working. A water jacket or any external cooling system shall not be considered acceptable designs.
- C. The motor shall be capable of no less than 15 evenly spaced starts per hour and be able to operate throughout the entire pump performance curve from shut-off through run-out.
- D. The motor and the pump shall be produced by the same manufacturer.
- E. The motor shall be protected by the following sensors:
  1. (3) bi-metal thermal switches for thermal control of the stator

2. (1) float switch in leakage chamber or an electric probe shall be provided in the oil chamber to detect the presence of water in the oil.
- F. The stator shall be insulated according moisture resistant Class H or F. The stator windings shall be insulated with monomer-free polyester resin resulting in a winding fill rate of at least 96%. The design shall be inverter duty rated in accordance with NEMA MG1, Part 31.

## 2.09 POWER CABLE & ENTRY HOUSING

- A. The motor shall be equipped with a sufficient length of screened cable suitable for submersible pump applications. The power cable shall be sized according to NEC and ICEA standards. The outer jacket of the cable shall be oil resistant chlorinated polyethylene rubber. The cable shall be capable of continuous submergence underwater without loss of watertight integrity to a depth of 65 feet. A cable support grip shall be supplied with the cable.
- B. The cable entry housing shall be an integral part of the back plate. The cable entry shall have a single or double set of elastomer grommets in the event of a cable entry seal failure. The cable entry shall be comprised of one or two cylindrical elastomer grommets, each flanked by washers and a ferrule designed with close tolerance fit against the cable outside diameter and the entry inside diameter. This will provide a leak proof, torque-free seal at the cable entrance. The assembly shall bear against a shoulder in the stator casing opening and be compressed by a gland nut threaded into it. Interaction between the gland nut and the ferrule should move the grommet along the cable axially instead of with a rotary motion. The junction chamber and motor compartment shall be separated by a terminal board which shall protect the motor interior from foreign material gaining access into the pump top. Connection between the threaded compressed type binding posts permanently affixed to the terminal board and thus perfectly leak proof. Epoxies, silicones, or other secondary sealing systems shall not be considered acceptable.

## 2.10 JUNCTION CHAMBER

- A. The junction chamber containing the terminal board shall be hermetically sealed from the motor by an elastomeric compression seal. Connection between the cable conductors and stator leads shall be made with threaded compression type binding posts permanently affixed to a terminal board.

## 2.13 PUMP MOUNT ASSEMBLY

- A. For each pump the contractor shall supply a 24" wall mounted discharge pipe and a 24" pipe mounted discharge connection.
- B. A stainless steel, pump mount assembly kit shall be supplied to mount the pump during operation and guide the unit during installation and removal from service. The assembly shall consist of 2" diameter guide rails on the discharge connection fastened with a guide bar holder at the top of the process tank. The assembly shall be

made of type 316 stainless steel. Type 304 stainless steel shall not be considered equal.

- C. A 316 stainless steel lifting cable, permanently attached to each pump, shall be provided in sufficient length for attachment of the upper end to the winch cable reel when the davit assembly is installed.
- D. The upper guide bar holder shall have hooks and shackles to support the lifting cable and electric motor cable while the pump is in use.
- E. The assembly shall be provided with cable holders to secure the mixer electric power cable (one every 5 feet). Their purpose shall be to prevent the electric cable from becoming entangled in the mixer propeller during operation.

#### 2.14 PORTABLE LIFTING DAVIT

- A. Davit crane assemblies and pedestal bases shall be supplied in accordance with Specification Section 14600. The contractor is responsible for coordinating the lifting davit with the supplied pumps. The pumps shall be removable from the tanks with the davit.
- B. Coordinate supplied davit with the tank depth and walkway elevation to provide pump removal and placement on the walkway.

#### 2.15 MANUAL CONTROLS

- A. The pump manufacturer shall supply a manual control panel with each pump that includes a combination circuit breaker/overload in an NEMA 4X, stainless steel, watertight enclosure. The panel shall provide manual ON/OFF function as well as short circuit and overload protection, and protection by motor stator thermal overload switches and seal leakage detection. Mini CAS module by Xylem/Flygt, Sulzer CA462 relay module, or equal installed within. Panel shall have a non-LED elapsed time meter (reading shall be visible and not reset in a power outage). Refer to I-series drawings for additional requirements.

#### 2.16 TESTING

- A. Each completed and assembled pump/motor unit shall undergo the following factory tests at the manufacturer's plant prior to shipment. The Manufacturer shall provide, on demand, a copy of the quality control plan for these tests and an ISO 9001 factory certificate:
  - 1. Hi Hydraulic factory performance test to HI level 2B. Test reports shall be provided for engineer review and approval.
  - 2. No-Leak seal integrity test
  - 3. Electrical integrity test

### PART 3 - EXECUTION

#### 3.01 INSTALLATION



A. Install pumps according to the manufacturer's written instructions.

3.02 STARTUP SERVICE

A. The service of a factory trained representative shall be made available on the job site to check installation and start up and instruct operating personnel.

B. Provide in accordance with Specification Section 01665.

3.04 SPARE PARTS

A. Furnish the manufacturer's recommended spare parts required in the first year of operation for each mixer, packaged and labeled, including at least the following:

1. Mechanical seals
2. O-rings / Gaskets
3. Bearings

3.6 CONTRACT CLOSEOUT

A. Provide in accordance with Section 01700.

END OF SECTION

## SECTION 11316

### VERTICAL SHAFT HYPERBOLIC MIXER/AERATORS

#### PART 1 GENERAL

##### 1.01 GENERAL

- A. CONTRACTOR shall furnish all labor, materials, equipment, and incidentals required to install complete and ready for operation, (6) hyperbolic mixer/aerators complete with drive units as shown on the Drawings and as specified herein.
- B. The CONTRACTOR shall retain the services of the hyperbolic mixer/aerator manufacturer, who shall be responsible for the following:
  - 1. Design of the hyperbolic mixer/aerator units.
  - 2. Preparation of shop drawings.
  - 3. Performance testing and warranty liability.
  - 4. On-site assistance during installation, start-up and testing of the hyperbolic mixer/aerator units.
  - 5. On-site training of OWNER'S operations and maintenance staff.
- C. Equipment furnished under this Section shall be fabricated, assembled and tested in full conformity with drawings, specifications, engineering data, instructions and recommendations of the equipment manufacturer.
- D. Each unit shall be furnished and installed with all necessary accessory equipment and auxiliaries, whether specifically mentioned in this Section or not, and as required for an installation incorporating the highest standards for the type of service specified, including field technician representation during installation and startup of the unit and instruction of the OWNER'S operation and maintenance personnel in the care, operation and maintenance of all equipment.

##### 1.02 RELATED DOCUMENTS

- A. SECTION 01300 – SUBMITTALS
- B. SECTION 01631 – USE OF OTHER THAN FIRST NAMED MANUFACTURERS
- C. SECTION 01665 – SERVICES OF MANUFACTURER'S REPRESENTATIVES
- D. SECTION 01680 – EQUIPMENT AND SYSTEM CHECKOUT, CERTIFICATION, AND TESTING
- E. SECTION 01730 – OPERATION AND MAINTENANCE MANUALS
- F. SECTION 03604 – NON SHRINK GROUT
- G. SECTION 05500 – MISCELLANEOUS METALS
- H. SECTION 09900 – PAINTING

I. SECTION 11372 – POSITIVE DISPLACEMENT BLOWERS

J. SECTION 13350 – INSTRUMENTATION

1.03 SUBMITTALS

A. Submit the following in accordance with Section 01330, Submittals:

B. Hyperbolic Mixer/Aerator Drawings and Data

1. Submit complete assembly, layout and installation drawings, together with detailed specifications and data covering materials of construction, parts, devices and other accessories forming a part of the equipment furnished. Data and specifications for each unit shall include the following:
  - a. Descriptive literature, bulletins, catalog cuts and drawings for the equipment including minimum submergence requirements.
  - b. Certified shop and installation drawings showing all details of construction, dimensions and anchor bolt requirements.
  - c. Shaft size and material
  - d. Propeller size, type and material.
  - e. Type and ratings of bearings.
  - f. Complete bill of materials for the equipment.
  - g. Recommended spare parts list.
  - h. Description of surface preparation and shop prime painting, including certification that the paint to be used to shop prime the equipment is compatible with the finish coat paint to be applied to the equipment.
  - i. The weight of each component: motor, gearbox, shafting and impeller.
  - j. The total weight of the complete assembled mixer/aerator.
  - k. Complete motor data including size, make, type and characteristics of the electric motor along with wiring diagrams.

C. Design Data

1. Design calculations demonstrating that the equipment process design requirements are met

D. Certificates

1. After the equipment has been manufactured, the manufacturer shall submit to the ENGINEER a certification stipulating that the equipment has been manufactured in accordance with the design and complies with all requirements specified herein.

E. Test Reports

1. Copies of the test reports regarding the shop tests and field tests shall be submitted to the ENGINEER within 14 days of the completion of the tests.

F. Operation and Maintenance Manual Information

1. Submit O&M Manual information in accordance with Section 01730, Operations and Maintenance Manuals.

1.04 QUALITY ASSURANCE

A. Coordination

1. All equipment included in this Section shall be furnished by or through a single mixer/aerator equipment manufacturer who shall be responsible for the design, coordination, testing and the satisfactory performance of all the components.
2. The work of this Section shall be completely coordinated with the work of other Sections. Verify at the site both the dimensions and work of other trades adjoining items of work in this Section before fabrication and installation of items herein specified. Field measurements shall be taken at the site to insure proper fitting of all items.

B. Qualifications

1. The mixer/aerators shall be a product of a manufacturer experienced in the design and fabrication of equipment of this type. The manufacturer should provide evidence of having supplied similar equipment which has been operating successfully for at least five years and meeting or exceeding the performance and design requirements specified as justified by factory and on-site SOTR tests in a minimum of 5 U.S. municipal wastewater treatment facilities.

C. Mechanical Testing of the Speed Reducer

1. Upon installation, each complete assembly shall be run to demonstrate its ability to operate without overheating, jamming, excessive vibration and free from oil leaks during normal operation.

D. Services of Manufacturer's Representative

1. Provide services of a manufacturer's factory representative, as required in Section 01665, specifically trained on type of equipment specified. Submit qualifications of representative for approval. Man-day requirements listed in Section 01665 are exclusive of travel time, and do not relieve CONTRACTOR of obligation to provide sufficient service to place equipment in satisfactory operation.
  - a. Installation: Assist in installation and leveling of mixer/aerator and in coordinating electrical connections or any other miscellaneous coordination: 1 Man-days for each unit (non-consecutive).
2. If there are difficulties in operation of the equipment due to the manufacturer's design or fabrication, additional service shall be provided at no additional cost to the OWNER.

1.05 DELIVERY, STORAGE, AND HANDLING

- A. Delivery and storage of the mixer/aerators shall be in accordance with Section 01600.

- B. Care shall be taken to avoid supporting or lifting the mixer/aerators in a manner that will place excessive stress on parts or shafts that are not designed to support the weight of the unit. The mixer/aerator assembly shall be lifted by eyebolts provided in the top of motor drive or by slings.

## 1.06 WARRANTY

- A. The CONTRACTOR shall have the manufacturer of the mixer/aerator warrant that all equipment supplied by the manufacturer shall be free from defects in material and workmanship and that it will replace or repair, F.O.B, its factory or repair facility authorized by the manufacturer, any part or parts returned to it, which examination shows to have failed under normal use and service by the user within 12 months after the startup or 18 months after shipment, whichever is sooner.
- B. The warranty period shall begin at the date of substantial completion in accordance with the General Conditions.
- C. Warranties and guarantees by the suppliers of various components in lieu of a single source responsibility by the aerator/mixer manufacturer shall not be accepted. The aerator/mixer manufacturer shall be solely responsible for the warranty of the equipment and all related components.
- D. In the event a component fails to perform as specified or is proven defective in service during the warranty period, excluding items of supply normally expended during operation, the aerator/mixer manufacturer shall remove the faulty equipment from the aeration tank(s), provide a replacement part, install, test and calibrate the replacement equipment, all without cost to the OWNER.

## PART 2 PRODUCTS

### 2.01 MANUFACTURER

- A. Provide vertical shaft hyperbolic mixer/aerators as manufactured by one of the following:
  - 1. Invent Environmental Technologies, Inc.
  - 2. No substitution permitted.

### 2.02 DESIGN CONDITIONS

- A. Furnish and install (6) hyperbolic mixer/aerators in Re-Aeration Tanks 1 & 2 (3 units/tank) which shall be standard equipment provided with all of the necessary accessories. The equipment shall be capable of completely mixing the basin in which it is installed, maintaining homogeneously mixed liquor solids in suspension without introduction of air. Additionally, the equipment shall be capable of introducing air in the basin providing the oxygen transfer required in these design conditions. There shall be no dead zones present in the basin, and uniform dissolved oxygen levels shall be maintained throughout the zones of the basin.

- B. Equipment furnished under this Section shall be designed for marine environment in which the equipment is exposed to the atmosphere. The equipment shall be designed for operation in hot humid atmosphere and sub freezing temperatures, and shall be designed to operate continuously, 24 hours per day, 365 days per year.
- C. Each mixer/aerator shall operate independently. The mixer/aerators shall be variable speed units designed to operate continuously.
- D. The hyperbolic mixer/aerators shall be designed for the tank dimensions and water surface (peak, average and minimum) elevations as shown on the Drawings.

## 2.03 DETAILS OF CONSTRUCTION

### A. Mixer Design and Construction

#### 1. General:

- a. Each mixer/aerator assembly shall be a hyperboloid impeller type mixer/aerator with a dry installed heavy duty gear drive and a separate ring sparger to provide supplemental air. The mixer/aerators shall be designed to provide complete suspension of solids in the tank, to re-suspend heavy material on the tank bottom and to re-entrain foam from the surface. The shear ribs in the mixer body shall be capable of dispersing the air into fine bubbles while handling solids, fibrous materials, and heavy sludge. The shear ribs will be an integral part of the mixer body for smooth mixing flow acceleration and to minimize catch points for rags and debris.
  - b. Mixer/aerators shall be designed as a vertical shaft mixer/aerator, with a dry installed motor. The mixer/aerator shall not generate any upward forces on the bridge construction.
  - c. The mixer/aerator shall have a steady stationary flow directed downward parallel to the mixer/aerator shaft, the highest speeds and turbulent fluctuations shall be produced in the bottom area. On the water surface little or no surface turbulences or separation vortex shall appear.
  - d. There shall be no minimum airflow that would prevent the unit from operating in a balanced, efficient manner.
- 2. Shaft: Type 316Ti stainless steel of sufficient wall thickness to operate under the design conditions without warping, twisting, or any damage to proper mixer operation.
  - 3. Mixer body: The hyperboloid mixer body shall be fluid-mechanical optimized. The transport ribs which accelerate the flow are integrated in the mixer body, the stainless steel shear ribs which ensure the dispersing of the air into fine bubbles are fixed to the bottom side of the mixer body. The mixer body shall be made FRP composite and coated with a gel coat with a polished finished surface.
  - 4. Ring Sparger: The ring sparger shall be dimensioned on a maximum airflow of 150 scfm, shall be non-clogging and made of HDPE, the ring sparger will end 5 ft from the center of the mixer/aerator with a 4" flange. The mounting hardware and chemical anchors shall be provided by the manufacturer.

## B. Gear Drive

1. The gear shall be rated for 100,000 hour  $L_{10}$  bearing service life in adverse operating conditions. The driving shaft shall be mounted in a hollow shaft and secured by hex screw. Torque shall be transmitted by feather key connection. The hollow shaft shall be covered and sealed.
2. The gearbox housing shall be cast iron covered with a high-quality epoxy coating with a thickness of at least 70  $\mu\text{m}$ , and shall be connected to the mounting base with a flange connection with stainless steel nuts and bolts.

## C. Motors:

1. Motors shall be NEMA premium efficient, vertical, heavy-duty, weatherproof, Totally Enclosed Fan Cooled (TEFC) type, with solid shafts. The motor shall meet or exceed the efficiency levels from NEMA MG1. The motor efficiency shall be determined using the test standards in IEEE Standard 112-1984 or by internationally accepted methods.
2. Motors shall operate on 460 volts, 60 Hz, three-phase electric power.
3. Motors shall be suitable for use with solid-state variable frequency drives. Motors shall be squirrel cage induction, NEMA Design B units with ratings, characteristics, and features coordinated with and approved by drive manufacturer conforming to requirements of NEMA MG 1, Part 31. Include adequate thermal capacity for continuous operation under worst case temperature conditions with motor operating at rated torque, without reduction in insulation life of motor, under the range of conditions specified.
4. The temperature rise, by resistance, shall be 80°C or less when measured at rated load on sine wave power, on inverter power ratings shall be 105°C or less.
5. Service Factor and Ambient: Standard motors shall be rated for a 1.15 service factor on sine wave power and 1.0 service factor on VFD power in a 40°C ambient operating temperature.
6. Provide motor winding thermal protection system protecting against overload, high ambient temperature, abnormal voltage, ventilation failure, single-phase condition, and humidity and acid protection of the winding (tropical protection).
7. Motors shall be capable of carrying full load current continuously without injurious temperature rise in an ambient temperature of 40°C.
8. Locked rotor currents shall be as specified in NEMA standards.
9. Space Heaters shall be provided to prevent condensation.

## D. Mounting Base

1. Gear base plate mounted in rubber buffers connected permanently to the mixer/aerator support by bolted connection. The rubber buffers shall prevent any transfer of vibrations to the existing concrete structure.
2. Distortion-proof steel structure with an impact-proof powder-coated surface.

3. The plate shall be leveled using threaded bolts which can be adjusted in height.
4. The fastening set shall consist of through bolts for connecting to the concrete deck.

E. Bolts and Hardware

1. All assembly bolts, nuts, washers, fasteners and rigging hardware shall be Type 316 stainless steel as specified.

2.04 TOOLS AND SPARE PARTS

A. Furnish and the deliver the following boxed and labeled in accordance with Section 01750.

1. One set of all special tools required for normal operation and maintenance.

2.05 SURFACE PREPARATION AND SHOP PRIME PAINTING

A. The mixer/aerators shall be prepared, and shop primed as specified in Section 09900.

PART 3 EXECUTION

3.01 INSTALLATION

A. Each mixer/aerator, motor, shaft, associated equipment and accessories, and support shall be installed complete in strict accordance with the manufacturer's instructions and recommendations in the locations shown on the Drawings.

3.02 FIELD QUALITY CONTROL

A. Installation Check

1. After installation and prior to being placed in operation, each unit will be inspected and checked by a qualified representative of the equipment manufacturer, as required.

B. Make all adjustments to each unit as directed by the equipment manufacturer.

3.03 TESTING

A. Field tests shall not be conducted until such time that the entire installation is complete and ready for testing.

B. All mixer/aerators shall be checked for balance when operating in air briefly and when submerged in a factory test tank.

C. All mixer/aerators in the basin shall be checked with amperage and voltage measurements to assure that all mixer/aerators are operating at the same power draw. With all units operating, the transient power consumption of each size mixer/aerator as recorded by the wattmeter shall not vary more than plus/minus 5 percent from the average value for that mixer/aerator.



- D. All field tests shall be conducted in the presence of the OWNER and ENGINEER. All power and appurtenances necessary for the testing shall be furnished by the CONTRACTOR.
- E. In the event the equipment fails to meet the test requirements, the necessary changes shall be made and the equipment retested. If the equipment remains unable to meet the test requirements to the satisfaction of the ENGINEER, it shall be removed and replaced with satisfactory equipment at the CONTRACTOR's expense.

3.04 CONTRACT CLOSEOUT

- A. Provide in accordance with Section 01700.

END OF SECTION

SECTION 11327

FINAL CLARIFIER EQUIPMENT  
(BID PACKAGE #1 ADDITIVE ALTERNATIVE #1)

PART 1 GENERAL

1.01 DESCRIPTION

- A. Furnish, Install and Test four (4) final clarifier mechanisms for installation in existing concrete basins as shown on the contract drawings. Each basin is approximately 100 feet in diameter with a side water depth of approximately 12.15 feet, a freeboard of a minimum 18 inches and a floor slope of 1 inch to 12 inches.
- B. Each mechanism shall be a center column supported center feed unit with peripheral effluent collection. A center drive mechanism shall be provided for rotation of the rake arms and scum skimming mechanism.
- C. The equipment shall be designed to effectively settle mixed liquor suspended solids and remove them through rapid return suction piping mounted to the rake blades. Collected sludge shall be discharged from the suction piping to an open sight well and then to a withdrawal pipe located within the mechanism center column as shown on the contract drawings. The clarified effluent shall be collected uniformly by the peripheral launder. Surface scum shall be collected by full radius scum skimming equipment and discharged through the scum withdrawal pipe.
- D. The equipment furnished for each clarifier mechanism shall include but not be limited to: walkway, center drive assembly, center drive platform, center support column with inlet openings, energy dispersion inlet (EDI) well, feedwell, sludge collection box, center cage, sludge collection arms with rake blades, sludge piping and valves, surface scum skimming equipment, anchor bolts and assembly fasteners. Effluent weir plates and scum baffles shall be provided in accordance with specification Section 11601. Final clarifier equipment shall be coordinated with the density current baffles.
- E. Except where specifically indicated otherwise, all plates and structural members designated for submerged service shall have a minimum thickness of 1/4 inch. All structural steel will conform to ASTM A-36 requirements and steel plate will conform to ASTM A283C requirements. All anchor bolts and fasteners shall be 304 stainless steel.
- F. **Items in this specification section are subject to the American Iron and Steel requirements of P.L. 113-76, the Consolidated Appropriations Act of 2014.**

1.02 RELATED SECTIONS

- A. SECTION 01300 – SUBMITTALS
- B. SECTION 01631 – USE OF OTHER THAN FIRST NAMED MANUFACTURER
- C. SECTION 01665 – SERVICES OF MANUFACTURER’S REPRESENTATIVE

- D. SECTION 01680 – EQUIPMENT AND SYSTEM CHECKOUT, CERTIFICATION, AND TESTING
- E. SECTION 01730 – OPERATION AND MAINTENANCE MANUALS
- F. SECTION 05500 – METAL FABRICATIONS
- G. SECTION 09900 – PAINTING
- H. SECTION 11100 – AUTOMATIC ALGAE SWEEPING SYSTEM
- I. SECTION 11329 – DENSITY CURRENT BAFFLES
- J. SECTION 11601 – FIBERGLASS REINFORCED PLASTIC WEIRS AND SCUM BAFFLES
- K. SECTION 13321 – INSTRUMENTATION AND CONTROL SYSTEM
- L. DIVISION 16 – ELECTRICAL

### 1.03 REFERENCES

- |    |            |   |
|----|------------|---|
| A. | ASTM A-36  | American Society of Testing Materials<br>Structural Steel Specifications  |
| B. | ASTM A-325 | American Society of Testing Materials<br>Fastener Specifications  |
| C. | ASTM 304   | American Society of Testing Materials<br>Bolt Specifications  |
| D. | ASTM A-48  | American Society of Testing Materials<br>Cast Iron Specifications   |
| E. | ASTM A-536 | American Society of Testing Materials<br>Cast Iron Specifications   |
| F. | AISI 4142  | American Iron and Steel Institute<br>Heat Treated Steel Specifications  |
| G. | AGMA       | American Gear Manufacturers' Association Gear Ratings   |
| H. | AWS        | American Welding Society - Current Standards  |
| I. | AFBMA      | Anti-friction Bearing Manufacturers' Association – Bearing<br>Life Specifications                               |
| J. | ASTM A283C | American Society of Testing Materials<br>Steel Plate Specifications   |
| K. | NEMA       | National Electrical Manufacturer's Association - Motor<br>Design Standards and Standards for Control Enclosures |

### 1.04 SUBMITTALS

- A. Shop Drawings in accordance with specification Section 01300.

- B. **Certification of compliance with the American Iron and Steel requirements of P.L. 113-76, the Consolidated Appropriations Act of 2014, is required with all submittals.**
- C. Two copies of all materials required to establish compliance with these specifications shall be submitted for review. Submittals shall include at least the following:
  - 1. Certified general arrangement drawings showing all important details and materials of construction, dimensions, loads on supporting structures, and anchor bolt locations.
  - 2. Descriptive literature, bulletins, and/or catalogs of the equipment.
  - 3. Complete data on motors and speed reducers.
  - 4. Wiring diagrams and electrical schematics for all control equipment to be furnished.
  - 5. Calculations documenting the AGMA rating of the drive unit and life of the main bearing, prepared and signed by a registered professional engineer.
  - 6. Complete descriptive information and electrical schematic for the torque overload device.
  - 7. Complete sludge transport calculations substantiating the rake blade design, rake tip speed, and floor slope.
  - 8. Complete process calculations substantiating the sizing of the center column and ports, EDI and outlets, and outer feedwell.
- D. Operation and Maintenance Manual in accordance with specification Section 01730.

#### 1.05 MARKING, DELIVERY, STORAGE, AND HANDLING

- A. Fabricated assemblies shall be shipped in the largest sections permitted by carrier regulations, properly match-marked for ease of field erection.
- B. All components shall be erected immediately upon receipt from the final clarifier equipment manufacturer or stored in strict conformance with storage recommendations provided by the equipment manufacturer in the operations and maintenance manual.
- C. The mechanism shall be lubricated in strict accordance with the instructions of the final clarifier mechanism manufacturer's field service representative. The Contractor shall provide the required lubricants.

#### 1.06 QUALITY ASSURANCE.

- A. The clarifier equipment manufacturer shall modify his standard equipment to meet the minimum values specified for dimensions, design, and the intent of this specification.
- B. Manufacturers regularly engaged in the manufacture of the clarifier equipment as specified herein and who can demonstrate equipment of this specified design, in actual service for a period of not less than 10 years will be considered as acceptable manufacturers.

- C. Manufacturers shall show evidence of quality assurance in manufacturing and supplying equipment essential in details to the equipment herein specified. This assurance will be met by certification to the quality system requirement of ISO 9001 or equivalent standard as accepted by the engineer.
- D. The equipment specified herein shall be factory assembled as far as practical to verify that all mating parts can be field assembled. The manufacturer shall submit certification of shop trial assembly and photographs of assembly before shipment.
- E. Shop inspection shall be performed by a qualified inspector and certified by the manufacturer. The inspection shall be documented and all deficiencies noted, corrected, re-inspected and final completion formally authorized. Final shipment authorization shall be by the manufacturer to ensure completion of all fabrication, assembly, and inspection requirements. Inspection records and evidence of inspector qualification shall be submitted to the owner upon request.

#### 1.06 OPERATION AND MAINTENANCE MANUALS

- A. The equipment manufacturer shall furnish an electronic copy and two (2) printed copies of the operation and maintenance manual at least two weeks prior to shipment of all major equipment components, which will be retained at the installation site to assist plant operators.
- B. Each manual shall be a bound, indexed binder with drawings and parts lists prepared specifically for this project rather than general instructions that are not designed for this project.
- C. As a minimum, the manual shall contain:
  - 1. Certified as built drawings - General arrangement
  - 2. Certified as built drawings - General arrangement details
  - 3. Erection drawings.
  - 4. A complete bill of materials for the equipment including the weights of all structural steel components.
  - 5. Installation and maintenance instructions for the specific equipment including the erection sequence, maintenance and trouble-shooting check points, and complete lubrication procedures with recommended grades of lubricants.
  - 6. Cut sheets for all equipment items purchased from sub-vendors.
  - 7. A list of the final clarifier equipment manufacturer's recommended spare parts specifically denoting wear items, long delivery items, and all items convenient for stocking as optional replacement items.

## PART 2 PRODUCTS

### 2.01 MANUFACTURERS

- A. WesTech Engineering Inc., Salt Lake City, UT

B. Amwell, A Division of McNish Corp., Aurora, IL

C. Approved equal.

D. Should equipment which differs from the first named in this Section be offered and determined to be the equal of that specified, such equipment shall be acceptable only on the basis that any revision in the design and/or construction of the structure, piping, appurtenant equipment, electrical work, etc, required to accommodate such a substitution shall be made at no additional cost to the Owner and be as approved by the Engineer.

## 2.02 DESIGN

A. The Final Clarifier Mechanism shall be designed as follows:

Influent Flow (average):	2.6 MGD
Maximum Influent Flow (peak):	6.3 MGD
– Solids Loading (average):	16 lb/day/ft <sup>2</sup>
– Solids Loading Maximum (peak):	30 lb/day/ft <sup>2</sup>
Tank Diameter (ft):	100
Side Water Depth (ft):	12.15
Freeboard (ft):	1.5 (min.)
Bottom Slope (in/ft):	1/1
Center Support Outside Diameter (in):	36
Feedwell	
– Diameter (ft):	22
– Depth (ft):	5
Energy Dissipating Inlet (EDI)	
– Diameter (ft):	11
– Depth (ft):	5.67
Collector Tip Speed (ft/min):	12
Motor HP:	1
Torque (ft-lbs)	
– Design Running:	35,750
– Momentary Peak:	71,500

## 2.03 MATERIALS

A. All structural steel shall conform to AISC – Steel Construction Manual latest edition. All steel plates shall conform to ASTM A36. All structural steel shape series of M, MT, S, ST, C, MC, L shall conform to ASTM A36. Structural steel shapes W, WT,

HP shall conform to ASTM A992/A572. All pipe shall be ASTM A53, Grade B. All square and rectangular tubing shall be ASTM A500, Grade B, unless otherwise noted. Steel members in contact with liquids, either continuously or intermittently, shall have a minimum thickness of 1/4 inch unless otherwise noted. All aluminum shall be type 5052, 6061, 6063, or 2014 alloy unless noted. All stainless steel shall be type 304/304L unless noted.

## 2.04 CENTER DRIVE ASSEMBLY

A. Fabricated or cast drives will be permitted.

B. Design Parameters – Fabricated Drive

1. The drive unit shall be designed and manufactured by the equipment supplier to ensure unit responsibility. The drive unit shall be designed for the torque values previously listed. It shall turn the mechanism at the design collector tip speed. The drive main bearing shall be designed for the total rotating mechanism loads with a minimum L-10 life of 50 years or 438,000 hours. The drive unit shall be capable of producing and withstanding the previously listed momentary peak torque while starting. The drive main gear shall be designed to a minimum AGMA 6 rating when rated in accordance with the latest AGMA standard. Gear teeth shall be designed for proper load distribution and sharing. Stub tooth design and surface hardening of the main gear shall not be allowed. The main bearing shall be capable of withstanding the listed overturning moment without the aid of any underwater guides or bearings to ensure correct tooth contact for AGMA rating of the main gear.
  - a. All spur gearing shall be designed to the latest AGMA spur gear standard for strength and surface durability, based on a life of 175,000 hours. The design running torque rating of the drive gearing shall be based on the smaller of the strength and durability values determined from the above AGMA standard. To ensure safety and ease of maintenance, all components of the drive shall be direct coupled.
  - b. No overhung pinions shall be allowed on the speed reducing unit. The lower pinion bearing shall not be located below the turntable base.
  - c. Any and all welding on the drive unit shall be done using E70XX weld rod.
2. The drive unit shall consist of a solid internal main spur gear, bearing turntable, pinion, secondary speed reducer, support base, and drive unit bearing. The drive shall be mounted on the center column and support the entire rotating load of the mechanism. The main internal gear shall be forged of alloy hardened steel. The pinion shall be heat treated alloy steel. All speed reducers shall be fully enclosed and running in grease. Support base for the drive shall be of welded steel to assure rigidity. Lubricant and dust shields shall be provided. The drive bearing shall include a forged steel precision gear/bearing set, with fully contoured raceways hardened to a minimum 58-60 Rc and protected by a neoprene seal. Strip liners designed for periodic maintenance and replacement shall not be acceptable. The drive shall be designed so that the balls and nylon spacers can be replaced without

removing the access walkway. The main gear to pinion gear mesh shall be oil lubricated. An oil sight glass, fill pipe, and drain shall be provided for the reservoir. Lubrication fittings shall be readily accessible.

3. An overload device shall be provided in a stainless steel, weatherproof enclosure. The device shall be actuated by torque generated from the main drive, which shall operate two independently adjustable switches (the alarm switch at 100 percent of design running torque and the motor cutout switch at 120 percent of design running torque). Devices that require the worm to float and measure the thrust of the worm gear shall not be acceptable. These two switches shall be factory adjusted to accurately calibrate the alarm torque value and the overload position. A visual torque indicator shall be provided and oriented so that it may be read from the walkway. It shall be calibrated from 0 to 160 percent of design running torque.
4. The turntable base shall have an annular bearing raceway upon which the rotating assembly rests. It shall have a maximum allowable deflection in accordance with the bearing specifications. The allowable modulus of elasticity shall be a minimum of  $29 \times 10^6$  psi. The center cage shall be fastened to and supported from the gear casing. Ball bearings shall be of high carbon chrome alloy 52100 steel running in fully contoured races, as part of a precision gear/bearing set. The balls shall be grease oil lubricated and protected by elastomer seals. Felt seals that allow the entrance of moisture from outside the drive (i.e. rain water, condensate, etc.) will not be allowed.
5. The speed reducing unit shall consist of cycloidal, helical, or planetary speed reducers directly connected to a motor without the use of chains or v-belts, and shall be keyed to the pinion.
  - a. The main ring gear of cycloidal drives shall be made of high carbon chromium bearing steel and be fixed to the drive casing. An eccentric bearing on the high speed shaft shall roll cycloidal discs of the same material around the internal circumference of this main ring gear. The lobes of the cycloid disc shall engage successively with pins in the fixed ring gear. The movement of the cycloid discs shall be transmitted then by pins to the low speed shaft. Speed reducer efficiency shall be a minimum of 90% per reduction stage.
  - b. Speed reducer helical or planetary gearing shall be manufactured to AGMA standards and shall provide at least 95% power transmission efficiency per stage. The speed reducer shall have a minimum service factor of 1.25 based on the output torque rating of the drive.
  - c. The reducers shall be fitted with radial and thrust bearings of proper size for all mechanism loads and be grease lubricated. As a safety feature, the speed reducer shall be back driveable to release any stored energy as the result of an over torque condition.

#### C. Design Parameters – Cast Drive

1. Gear Design - The continuous output torque rating and the allowable stress values used in the design of the intermediate worm gear reduction unit and the final gear



reduction unit shall be in strict conformance with the latest revision of the following standards:

- a. Worm & Worm Gearing: ANSI/AGMA 6034-B92, "Practice for Enclosed Cylindrical Worm Gear Speed Reducers and Gearmotors."
- b. Spur and Pinion Gearing: ANSI/AGMA 2001-C95, "Fundamental Rating Factors and Calculation Methods for Involute Spur and Helical Gear Teeth."
- c. The continuous output torque rating of the spur and pinion gearing shall be based on the smaller of the rating values determined from the above ANSI/AGMA standard and a design life of 20 years. The drive shall be designed and rated to develop the following torque values.

The equipment manufacturer shall submit calculations to the ENGINEER for approval substantiating the continuous output torque rating and design life. Calculations shall include the spur gear, pinion, worm gear set, and all bearings used in the intermediate worm gear reduction unit and the final gear reduction unit.

The spur gear and pinion calculations shall clearly specify the values used for the following design parameters for surface durability and strength ratings:

- |   |                         |
|---|-------------------------|
| d. Number of Pinions                        | Pinion Pitch Diameter   |
| e. Actual Face Width                        | Tooth Diametrical Pitch |
| f. Tooth Geometry Factors (I and J Factors) | Hardness Ratio Factor   |
| g. Load Distribution Factor                 | Elastic Coefficient     |
| h. Aspect Ratio                             | Life Factor             |
| i. Allowable Contact Stress                 | Application Factor      |
| j. Allowable Bending Stress                 | Rim Thickness Factor    |

Load distribution factors (Cm and Km) used in the calculations shall not exceed 1.28. For parameters which are material dependent, such as allowable contact stress, the calculations shall include a full description of the materials, quality grade, and heat treatment used. Momentary peak torque calculations shall use a maximum of 75% of yield strength.

2. Primary Gear Reduction Unit - The primary gear reduction unit shall consist of a totally enclosed, horizontal type gearmotor or gear reducer with C-face mounted drive motor, mounted on top of the intermediate worm gear housing. The primary gear reducer shall be a heavy-duty parallel shaft helical type, conforming to ANSI/AGMA 6019-B89, and shall have a service factor of 1.4, based upon the specified continuous running torque.

All gearbox bearings shall be of the anti-friction type and running in oil in a cast iron or steel housing. The totally enclosed primary reduction unit shall operate on 3 phase, 60 hertz, 230/460 volt power source, and shall be at least 1.0 HP. The motor shall conform to NEMA specifications for AC motors and be designed for continuous operating in humid outdoor condition.

3. Chain Drive - Power transmission between the primary gear reduction unit and the intermediate worm gear reduction unit shall be through a steel roller chain and steel sprocket assembly. The chain drive shall be enclosed with a steel chain guard meeting OSHA requirements. The shear pin overload shall be easily accessible by removal of the chain guard.
4. Intermediate Worm Gear Reduction Unit - The intermediate worm gear reduction unit shall consist of a worm gear driven by an integral straddle mounted worm and shaft, supported by heavy duty anti-friction bearings running in an oil bath, and housing. Plain or sleeve type bearings will not be acceptable. All bearings shall have a minimum L10 life of 20 years, based on the continuous torque rating.

The integral worm and shaft shall be single piece and made from AISI 8620H alloy steel carburized, hardened and ground and shall have a case hardness of 55-60 RC. The worm gear shall be centrifugally cast, conforming to ASTM B271 and ANSI/AGMA 2004-B89, high strength, manganese bronze.

The worm gear shall have a minimum 200 Brinell hardness and shall have a minimum pitch diameter of 9.59 inches and have a minimum face width of 1.75 inches. The worm gear shall be keyed to the pinion shaft. The intermediate worm gear housing shall be ASTM A48 Class 40 cast iron complete with seals, oil fill, oil level sight gauge and drain plugs. The intermediate worm gear housing shall have full 360° contact and support from the final gear housing.

5. Final Gear Reduction Unit - The final gear reduction unit shall consist of a pinion, internal split spur gear, anti-friction ball bearing assembly, and a cast housing. The pinion shall be AISI 4150 minimum grade 2 steel, heat treated to a minimum 321 BHN hardness, have a minimum 4.00 inch pitch diameter.

The pinion shall be single piece, extending from the worm gear to the spur gear, straddle mounted between anti-friction ball or roller bearings to maintain accurate pinion to spur gear alignment and contact. All bearings shall have a minimum L10 life of 20 years based on the continuous torque. Overhung pinions shall not be acceptable. The pinion shall be manufactured to have a minimum AGMA quality class 8, in conformance with ANSI/AGMA 2000-A88.

The internal spur gear shall be ductile iron normalized, quenched & tempered, conforming to grade 120-90-02, with micro-structure of fine tempered pearlite, conforming to ASTM A536, manufactured to have a minimum base hardness of 270 BHN and have a minimum AGMA quality Class 6, in conformance with ANSI/AGMA 2000-A88. The spur gear shall have a minimum 28 inch pitch diameter. The internal spur gear shall be of split construction to provide for replacement of balls and race liners without removing the drive unit or other parts of the clarifier mechanism. Internal spur gears lacking split construction will not be acceptable.

The internal spur gear shall be mounted on a large, full compliment anti-friction ball bearing assembly designed to support the entire rotating clarifier mechanism.

The ball bearing assembly shall consist of a minimum 79, 1-1/4" diameter AISI E52100 GRADE 50 chrome alloy steel bearing balls (60-64 RC) running in an oil bath protected from contamination by a dust shield. Nylon spacer balls will not be acceptable. The balls shall bear both horizontally and vertically on four (4) renewable hardened alloy steel race liners inserted into the housing and the internal spur gear. The minimum ball race diameter shall be 31 inches, to assure stability. The race liner inserts shall be heat treated to a hardness of no greater than 39-43 RC to avoid fatigue cracking. The race liners and bearing balls shall be designed for a minimum L10 life of 20 years. Bearing life calculations shall include all combined horizontal and vertical loads on the bearing assembly.

The ball bearing assembly shall be mounted in an ASTM A48 Class 40 cast iron housing. The base of the housing shall be mounted on the top flange of the stationary center column and designed to support the internal spur gear, the rotating clarifier mechanism, and one end of the access bridge.

The housing shall be complete with seals, oil level gauge, oil fill, and valved oil and condensation drains. A positive means of removing condensation and contaminant from the lower pinion bearing pocket shall be provided.

Lubrication of the gear teeth shall be accomplished by means of an oil dam and the meshing action of the pinion and the internal gear teeth which shall force lubricant up the face of the teeth.

6. In addition to a mechanical shear pin sprocket, the drive assembly shall also include two (2) NEMA 4 limit switches located on the worm gear housing and operated by a spring loaded actuator and aluminum pivot arm from the worm shaft. One (1) limit switch (N.O. contact) is for alarm torque and one (1) limit switch (N.C. contact) is for cut-out torque. An aluminum pointer with aluminum graduated scale marked in 0, 25, 50, 75 and 100 percentages is provided for indicating load on drive at all times.
- D. The motor shall be a squirrel cage, induction type, TEFC, ball bearing heavy duty unit of ample power for starting and operating the mechanism without overload, with a minimum service factor of 1.15.
- a. Power supply to the equipment shall be 240/480 volt, 60 hertz, 3 phase.

## 2.05 WALKWAY & PLATFORM

### A. Walkway

1. One (1) 36 inch wide walkway and platform with handrails shall be supported by the drive unit and influent column at the center and concrete footing at its outer end (as shown on drawings), and shall be designed to safely withstand a live load of 50 pounds per square foot. Deflection shall not exceed  $L/360$  when both the dead load and live loads are applied. It shall consist of two trusses or beams with 1-1/4 inch aluminum I-bar grating between the trusses or beams. The walkway shall be diagonally braced against lateral movement, and provided with handrails 42 inches high, of double-row 1-1/2 inch diameter horizontal aluminum pipe, and

4 inch high kickplates on both sides. Walkway trusses may serve as the handrail if the top chord is 3 feet-6 inches above the walking surface.

- a. Stainless steel bearing plates, UHMW-PE slide plates, and anchor bolts for the wall support shall be provided by the equipment supplier and installed by the contractor. Bearing plate dimensions and anchor bolt diameter, length, quantity, and arrangement shall be per the equipment supplier. The contractor shall block out or otherwise modify the tank or support structure to accommodate walkway and supports, if required.

#### B. Center Drive Platform

1. A center drive platform shall be provided which allows 24 inches clearance outside the center drive components. It shall consist of 1/4 inch aluminum checkered plate with necessary stiffeners and supports, resting on the drive unit and center column, and provided with connections to the walkway. The entire platform shall be surrounded by handrails 42 inches high of double-row 1-1/2 inch diameter horizontal aluminum pipe with 4 inch high kickplates.

### 2.06 INFLUENT & SLUDGE REMOVAL

#### A. Stationary Center Influent Column

1. A stationary cylindrical steel influent column (36-inch nominal diameter) of 1/4" minimum wall thickness shall be provided. One end shall have a support flange for bolting to the tank floor over the influent line, with a similar flange at the top for supporting the drive unit and walkway. The structure and anchor bolts shall provide adequate support for the entire mechanism dead load plus live loads and torque with an adequate factor of safety to eliminate excessive deflection or vibration. Suitable openings shall be provided in the upper portion of the column to allow unrestricted passage of the flow into the energy dissipating inlet.
2. A rotating sludge collection box shall be mounted around the top of the center column to house the overflow valves from the suction pipes and arranged to convey the sludge from the suction pipes to the central RAS withdrawal pipe within the center column. The collection box shall be connected to and rotate with the cage truss. A replaceable neoprene seal shall be provided between the rotating collection box and the stationary center column.
3. A steel RAS withdrawal pipe shall be mounted within the center influent column, extending from a flexible connector at the base of the column to the sludge collection box. A plate mounted within the column shall be provided to convey sludge from the sludge collection box into the RAS withdrawal pipe. Minimum wall thickness of pipe shall be 1/4".
  - a. Prior to the center column being grouted in place, the drive unit shall be installed, positioned, and leveled.

#### B. Energy Dissipating Inlet (EDI)

1. A single gate rotating circular energy dissipating inlet shall be supported by the cage and be designed to diffuse the liquid into the feedwell in an impinged flow

direction without excessive disturbance or formation of vertical velocity currents. The EDI shall be designed to positively prevent sludge from depositing within the EDI and shall include bottom drain holes.

- a. The diameter, depth, and detention time of the EDI shall be included in the submittal with the design calculations.
- b. The rotating EDI shall be designed with a full bottom extending to within 1 inch of the center column. It shall include an upper rim angle for stiffness. Multiple, discharge ports shall be provided to induce impinged flow. The gates shall have a fixed bottom to prevent vertical currents as the flow exits the EDI.
- c. The EDI shall be made of not less than 3/16 inch thick steel plate with necessary stiffening angles.

#### C. Feedwell

1. The flocculating feedwell shall be located outside of the EDI to diffuse the liquid into the tank without disturbance or formation of velocity currents. Baffled openings shall be provided near the water surface to allow scum to exit the feedwell.
  - a. The supports for the feedwell shall be located either above the liquid extending from the cage or walkway, or on the rake arms. Submerged supports from the rake arms shall be designed so as to minimize horizontal flow disruption.
  - b. No feedwell support or feedwell spliced connection shall be contained within the annular space formed between the feedwell and EDI. The depth of the feedwell shall be such as to provide proper detention time and an exit velocity at maximum flow that will not scour the settled sludge. The diameter, depth, detention time, and exit velocities shall match the process application calculations.
  - c. The feedwell shall be made of not less than 3/16 inch thick steel plate with necessary stiffening angles.

#### D. Center Cage

1. The center cage shall be of steel box truss construction. It shall be provided with connections for the two sludge rake arms and feedwell supports if required. The cage top shall be bolted to the main gear which shall rotate the cage with the attached arms and feedwell. The cage and each arm shall be designed to withstand 150 percent of the design running torque of the drive without over stressing the members. Loading to develop the torque shall be considered as uniform loads applied to each arm individually.

#### E. Sludge Rake Arms

1. The mechanism shall include two sludge rake arms of steel truss construction with steel scraper blades and adjustable stainless steel squeegees. Squeegees shall be fastened to the rake blades with stainless steel fasteners. The blades shall be

properly sized to insure complete raking of the bottom twice per revolution. The blades shall rake the heavy sludge to a center sludge hopper while directing lighter solids to the inlets of the individual sludge suction pipes. The arms shall be adjustable at the cage to assure an even grout thickness over the tank bottom.

#### F. Sludge Suction Pipes and Control Valves

1. PVC suction pipes shall be provided on each rake arm. The lower end of each pipe shall be attached to the rake arm by means of a stainless steel U-bolt clamp and the pipes shall be supported by the rake arm and cage. The pipes shall be arranged to slope upward toward the tank center, in the same horizontal plane, and shall continue to the sludge collection box so that each pipe drains freely in the event the tank is drained.

Each sludge suction pipe shall terminate at the sludge collection box, and shall discharge into the box by means of an adjustable overflow valve located within the box. Each valve shall be a concentric tube type, consisting of a fixed riser having a vertical slot, surrounded by a rotatable sleeve also with a vertical slot. The sleeve shall be easily turned to control the flow through the slot. The sleeve shall also be completely removable to allow flushing of the suction pipe. The valves shall be so arranged that they can be operated from the walkway without the use of an access platform below the elevation of the walkway and so that the flow from each can be observed, estimated, and sampled. An operating handle shall be furnished to adjust the valves.

### 2.07 SCUM REMOVAL

#### A. General

1. The clarifier manufacturer shall furnish two (2) skimming devices as part of each clarifier mechanism. Each skimming mechanism shall be arranged to sweep the surface of the sedimentation compartment, automatically removing scum and floating material to a scum box at the periphery of the tank.

#### B. Skimmer Construction

1. The rotating scum skimmer shall include a horizontal steel plate skimmer blade supported by vertical steel members extending up from the rake arms. The blade shall extend from a point 6 inches away from the influent feedwell to the hinged scum skimmer assembly at the tank periphery.
2. The skimmer shall be designed to support an automated algae sweeping system with a maximum weight of 200 pounds. Refer to specification section 11100.

#### C. Scum Skimmer Assembly

1. A hinged scum skimmer assembly shall be mounted on the outer end of the skimmer blade. The hinged scum skimmer assembly shall be designed to form a pocket for trapping the scum. The hinged arrangement shall insure continual contact and proper alignment between wiper blade, scum baffle, and ramp as the blade travels up the scum box ramp. The wiper blade shall have a wearing strip on its outer end which contacts the scum baffle and a neoprene strip on its lower

and inner edge. The neoprene wipers shall be a minimum 1/4 inch thickness. The scum is trapped as the wiper blade meets the ramp and is raised up the ramp to be deposited into the scum trough for disposal.

#### D. Scum Box

1. The scum box shall be 4-feet, supported from the tank wall and connected to the scum withdrawal piping. It shall be made of 1/4 inch thick welded steel plate. The box shall have a scum trough, vertical steel sides, and a sloping approach ramp that extends from 1-1/2 inches above water level to 5-1/2 inches below. A similar ramp shall be provided at the opposite end to allow the skimmer blade to lower back to the operating position. A flexible connector shall be provided for connection to the contractor supplied scum withdrawal piping in the tank wall.

#### E. Scum Flushing Valve

1. A valve shall be attached to the scum box which automatically opens and allows clarified liquid into the scum box to flush out solids. The valve shall actuate at every pass of the scum skimmer over the scum box, allowing sufficient delay after deposit of the solids before flushing begins. Delay and flush duration shall be adjustable. The opening and closing of the scum flushing valve shall be one smooth continuous movement. The valve shall provide 2 to 5 gallons of flush water per each pass of the skimmer assembly.

#### F. Scum Baffle

1. An adjustable baffle shall be provided around the periphery of the tank at the water surface for removal of scum in accordance with specification Section 11601.
2. The distance between the baffle and weir plates shall be at least 8 inches. In the area of the scum box the scum baffle shall extend to 24 inches starting approximately 6 feet before and ending 2 feet after the scum box.

### 2.08 EFFLUENT REMOVAL

#### A. Launder

1. A rectangular effluent launder shall be provided around the perimeter of the tank. The launder shall be formed as part of the concrete wall. A drop-out box shall be provided in the bottom of the launder at one point for collection and discharge of the clarified effluent.

#### B. Weir

1. An adjustable weir shall be provided around the periphery of the tank at the water surface for removal of clarified effluent in accordance with specification Section 11601.

### 2.09 ELECTRICAL

- A. The equipment supplier shall furnish all electrical items specifically called for in this specification section. The contractor shall supply and install all other electrical items required to place the equipment into service.

- B. The contractor shall supply and install all field wiring required including but not limited to proper size wire, conduit, fittings, and supports.

## 2.10 ANCHORAGE AND FASTENERS

### A. Anchor Bolts

- 1. All anchor bolts shall be a minimum of 1/2 inch diameter and made of type 304 stainless steel. The equipment supplier shall furnish all anchor bolts, nuts, and washers required for the equipment.

### B. Fasteners

- 1. All structural fasteners shall be a minimum of 1/2 inch diameter and made of type 304 stainless steel. The equipment supplier shall furnish all fasteners required for the assembly of the equipment.

## 2.11 PAINTING/FINISHING

### A. Provide in accordance with Specification Section 09900 - Painting.

- B. Sharp projections of cut or sheared edges of ferrous metals shall be ground to a radius by multiple passes of a power grinder as required to ensure satisfactory coating adhesion.

- C. All iron and steel surfaces, except the drive unit, shall be field cleaned and painted by the contractor to ensure paint compatibility and assign unit responsibility for the coating system. The drive unit shall be coated with the manufacturer's standard enamel paint system.

## PART 3 EXECUTION

### 3.01 INSTALLATION

- A. The equipment shall be installed in strict accordance with the manufacturer's written instructions. The equipment shall be installed properly to provide a complete working system.

### 3.03 SERVICE

- A. Provide the services of a manufacturer's representative in accordance with Section 01735. The representative shall inspect and approve the installation, certify that the torque settings of the drive overload protection device are correct, perform the torque test and instruct the owner's personnel on maintenance and operation. If additional service is required due to the mechanisms not being fully operational, at the time of service requested by the contractor, the additional service days will be at the contractor's expense.

### 3.02 TESTING

- A. Torque Tests:



1. The entire sludge collector mechanism shall be statically load tested by loading the rake arm with 150 percent of the specified design running torque. The test shall verify the torque overload control device settings for alarm and motor cutout. One truss arm shall be anchored and the load measured to demonstrate the rake arms', cage's, and drive unit's ability to withstand the specified torque. Sketches and calculations shall be submitted illustrating how the torque will be applied prior to the test taking place.

B. Operation Tests:

- a. The contractor shall operate the mechanism in a dry tank for a minimum of 4 continuous hours before flow is allowed to enter the system. There shall be no binding, jerky, or unusual motion exhibited during this run in period. Motor amperage shall be checked at least hourly for any unusual or higher than normal figures. After the unit has successfully passed this initial test, flow shall be introduced into the tank and the same 4 hour observation test run. If the unit should fail under any of these conditions, the test shall be halted and the problem corrected. If, after several attempts, the unit does not successfully pass the field test, the faulty portion of the equipment shall be repaired or replaced and the test re-run.

3.03 STARTUP

- A. Provide startup services in accordance with Specification Section 01665
- B. The equipment supplier shall provide the service of a qualified representative for one trip and one day per mechanism to inspect the mechanism installation, assist in startup, and instruct personnel in the proper operation and maintenance of the mechanism.

3.04 SPARE PARTS

- A. The intent of this specification is to provide uninterrupted operation for a minimum period of two (2) years. To meet this objective the thickener manufacturer shall supply any spare parts, excluding lubricants that are required to meet this time frame.

END OF SECTION

## SECTION 11329

### DENSITY CURRENT BAFFLE SYSTEM (BID PACKAGE #1 ADDITIVE ALTERNATIVE #1)

#### PART 1 – GENERAL

##### 1.01 DESCRIPTION

- A. This specification covers furnishing, installing, and placing in satisfactory operation, density current baffle systems to improve performance of the four (4) existing final clarifiers. The existing concrete final clarifiers are approximately 100 feet in diameter with a side water depth of approximately 12.15 feet, a freeboard of a minimum 18 inches and a floor slope of 1 inch to 12 inches, as shown on the contract drawings.

##### 1.02 RELATED SECTIONS

- A. SECTION 01300 – SUBMITTALS
- B. SECTION 01631 – USE OF OTHER THAN FIRST NAMED MANUFACTURERS
- C. SECTION 01665 – SERVICES OF MANUFACTURER’S REPRESENTATIVE
- D. SECTION 01680 – EQUIPMENT AND SYSTEM CHECKOUT, CERTIFICATION, AND TESTING
- E. SECTION 01730 – OPERATION AND MAINTENANCE MANUALS
- F. SECTION 11327 – FINAL CLARIFIER EQUIPMENT

##### 1.03 SUBMITTALS

- A. Shop Drawings shall be submitted in accordance with specification section 01300 and shall include:
  - 1. Manufacturer’s catalog information, descriptive literature, specifications and identification of materials of construction, including resins and glass fiber content and layout for FRP constructions.
  - 2. Detailed drawings showing equipment fabrication, dimensions, method of attachment including number, locations and size of fasteners and weights of fabrications.
  - 3. Manufacturer’s recommended baffle dimensions, deflection angle and location for each application.
- B. **Certification of compliance with the American Iron and Steel requirements of P.L. 113-76, the Consolidated Appropriations Act of 2014, is required with all submittals.**
- C. Quality Control Submittals
  - 1. Manufacturer’s Certificate of Compliance.
  - 2. Special shipping, storage and protection and handling instructions.

3. Manufacturer's written/printed installation instructions.
4. Must be manufactured in the U.S.A.
5. A list of ten installations of comparable size in operation for at least ten years.
6. Certified test reports of the physical and mechanical properties of the product. Each panel shall have the following minimum physical properties:

<u>Property</u>	<u>Test</u>	<u>Min. Value</u>
Tensile Strength	ASTM D-638	18,000 psi
Flexural Strength	ASTM D-790	26,000 psi
Flexural Modulus	ASTM D-790	1.01 x 10 <sup>6</sup> psi
Barcol Hardness	ASTM D-2853	34
Notched Izod	ASTM D-256	10 ft-lbs/in
Water Absorption	ASTM D-570	0.08%

#### 1.04 WARRANTY

- A. Manufacturer shall warrant the Density Current Baffle to be free of defects in materials and workmanship for a period of five years after the date of Substantial Completion.

#### 1.05 COORDINATION

- A. Manufacturer shall coordinate the Density Current Baffle design and installation requirements with the clarifier mechanism, scum box and launder effluent channel configurations.

### PART 2 - PRODUCTS

#### 2.01 MANUFACTURERS

- A. NEFCO, Palm Beach Gardens, FL
- B. Enduro Composites, Houston, TX
- C. Approved Equal
- D. Should equipment which differs from the first named in this Section be offered and determined to be the equal of that specified, such equipment shall be acceptable only on the basis that any revision in the design and/or construction of the structure, piping, appurtenant equipment, electrical work, etc, required to accommodate such a substitution shall be made at no additional cost to the Owner and be as approved by the Engineer.

#### 2.02 DESIGN

- A. The Density Current Baffle System shall consist of a series of baffle panels that are attached to the wall of the clarifier to form an inclined, shelf-like surface around the entire inner periphery of the tank. Each panel shall be molded of corrosion-resistant, UV-treated fiberglass. The panels shall be a maximum of eight (8) feet in length and shall be curved to follow the curvature of the clarifier tank. The width, inclination angle and mounting location of the baffle shall be determined based upon the clarifier

configuration in order to provide optimum baffle performance. The panels shall be designed such that adjacent panels fit together without overlapping or cutting, and the completed baffle when installed, has a well-engineered and professional appearance.

- B. The inclination angle of the baffle shall be 30 degrees as measured from the horizontal and the horizontal projection of the baffle shall be defined by the following equation:
- $$\text{Horizontal Projection (Inches)} = 18 \text{ inches} + 0.3 \text{ in/ft} \times (\text{Tank Diameter (ft)} - 30)$$
- C. Provision shall be made to attach the panels to the clarifier wall and support them at the proper angle using a triangular panel bracket. The panel and bracket shall be molded as an integral part of each panel, forming a baffle module, or separate panels and brackets may be supplied. If the panel and bracket are molded as an integral unit with adequate stiffeners, only one bracket is required per panel. A specially formed "free-end" bracket shall be provided to support the free end of the last panel where the run of panels is interrupted by an obstruction. Panels may be cut as required to fit around obstructions.
- D. If separate panels and brackets are supplied, the panels shall be molded of fiberglass and shall meet the specifications of this section. The brackets shall be fabricated of 3" x 3" x 1/4" Type 304 stainless steel angle and shall be triangular in shape, with the corners welded. Brackets shall be installed at a maximum spacing of four (4) feet. The panels shall be fastened to the brackets with stainless steel nuts, bolts and lock washers every eight (8) inches.
- E. In the case of clarifiers/settling tanks with inboard launders, two scenarios are possible:
1. If there is sufficient vertical clearance between the top of the blanket and the bottom of the launder to position the bottom of the baffle at least two feet above the top of blanket, then the baffle shall be mounted directly to the tank wall at or above that position.
  2. Where the clearance is more restricted, the baffle shall be mounted to the lower inboard corner of the launder trough. In this case, the width of the trough shall be considered when calculating the horizontal projection of the baffle, and the horizontal projection shall not be less than 24".
- G. A method of interconnecting adjacent panels shall be provided such that the entire assembly forms a rigid structure capable of supporting its own weight plus snow and wind loads in the event the tank is out of service. The angled working surface of each baffle shall be sufficient in pitch and width to divert the flow and to create a self-cleaning action of the baffle itself.
- H. Provision shall also be made to vent gases that may form beneath the baffle through 3" diameter half-round openings molded into the panel at its highest point. The vents should aim radially towards the center of the tank, such that any bubbling and/or bypassing current is directed away from the weir, preventing short-circuiting. Specially in cases where the panels are to be launder-mounted, with the vents sitting directly below the weir and scum baffle.

## 2.02 MATERIALS

- A. Each baffle panel shall be molded of fiberglass-reinforced plastic. The resins and fiberglass reinforcing material shall be consistent with the environmental conditions and structural requirements.
- B. The resin shall be an isophthalic polyester resin with corrosion-resistant properties, Corezyn COR75-AQ-010 or equivalent, suitable for use in submerged waste treatment applications. The resin shall not contain fillers except as required for viscosity control. For viscosity control, a thixotropic agent up to 5% by weight may be added to the resin. The resin shall be treated to provide UV suppression.
- C. Glass reinforcement shall consist of chemically bonded surfacing mat and chopped strand roving. Surfacing mat shall be Type C veil. The glass reinforcement shall be 357-211 PLN CTC chopped strand roving or equivalent. The glass content of the finished laminate shall not be less than 30% by weight. The nominal thickness of each baffle panel shall be 1/4" ±1/16 inch thick with resin rich surfaces and edges to prevent migration of moisture and fiber "blooming." The baffle shall be black in color.
- D. The upper surface of each panel shall be mold smooth and no glass fibers shall be exposed. Laminations shall be dense and free of voids, dry spots, cracks or crazes. The upper surface of the baffle shall be reinforced with one layer of surfacing veil followed by 2 ounces or more of chopped strand roving. In addition, the vertical mounting flange (return flange on launder mount applications) shall be reinforced with one layer of 24 oz woven roving.
- E. No other glass product is permitted between these layers. All factory-trimmed edges shall be "hot coated" with resin to prevent wicking.

## PART 3 - EXECUTION

### 3.01 INSTALLATION

- A. The installation contractor shall field verify existing dimensions and install the baffle in accordance with the contract drawings approved shop drawings and manufacturer's recommendations. Mounting holes shall be factory drilled. Field cutting of baffle panels will be allowed to complete the structure and accommodate in-tank obstructions. All field cut or drilled edges shall be coated per the manufacturer's recommendations to prevent fiber blooming or fraying. All of the fasteners required for installation shall be supplied by the baffle manufacturer. The baffle panels shall be attached to the wall using 3/8" x 3-3/4" concrete expansion anchors with oversized 1/8" x 2-1/4" stainless steel washers, and hex nuts. Adjacent baffle panels are fastened together using 1/4" bolts, 2 flat washers, lock washer and hex nut. All of the installation fasteners shall be 316 stainless steel.
- B. The density current baffle shall extend completely around the tank and shall be level, rigid and free of sway that could work anchors loose or cause undue wear.

### 3.02 CONTRACT CLOSEOUT

- A. Provide in accordance with Section 01700.

END OF SECTION



SECTION 11372  
POSITIVE DISPLACEMENT BLOWERS

PART 1      GENERAL

1.01 SECTION INCLUDES

- A. This specification covers furnishing and installing positive displacement blowers, for outdoor installation at the re-aeration basins.
- B. Furnish all labor, materials, equipment, and incidentals required and install complete, ready for operation and field-test six (6) new rotary positive displacement blowers and appurtenances, as shown on the Drawings and as specified herein.

1.02 RELATED SECTIONS

- A. SECTION 01300 – SUBMITTALS
- B. SECTION 01631 – USE OF OTHER THAN FIRST NAMED MANUFACTURERS
- C. SECTION 01665 – SERVICES OF MANUFACTURER’S REPRESENTATIVE
- D. SECTION 01680 – EQUIPMENT AND SYSTEM CHECKOUT, CERTIFICATION, AND TESTING
- E. SECTION 01730 – OPERATION AND MAINTENANCE MANUALS
- F. SECTION 11961 – INTERIOR AND EXTERIOR PROCESS PIPING
- G. SECTION 13321 – INSTRUMENTATION AND CONTROL SYSTEM

1.03 SUBMITTALS

- A. Submit shop drawings in accordance with Section 01300, including copies of all materials required to establish compliance with this Section. Submittals shall include at least the following information:
  - 1. Certified general arrangement drawings showing materials, details of construction, dimensions and connections.
  - 2. Complete Blower Performance Data including:
    - a. RPM
    - b. Capacity – scfm and icfm
    - c. Discharge pressure
    - d. dB(A) noise pressure level
    - e. Maximum gear tip speed and rotor tip speed (fpm)
    - f. HP required at rated capacity and pressure
    - g. Rated maximum pressure rise of blowers
  - 3. List of recommended spare parts broken down into on hand parts and long term for 2 years operation and 3 to 5 years operation.
  - 4. Performance Curves

5. Motor Data
  6. Valves
  7. ISO-1217 Performance Test Results
  8. Declaration of Conformity, per Machinery Directive 2006/42/EC, Annex II, No.1
- B. Complete blower package operation and maintenance instructions professionally published, hard copy and electronic copy, shall be furnished for all equipment included under these specifications in accordance with Section 01730.

#### 1.04 DELIVERY, STORAGE AND HANDLING

- A. All equipment shall be completely factory assembled, skid mounted, crated and delivered to protect against damage during shipment.
- B. All exposed flanges shall be covered and sealed with shrink-wrap to prevent the entrance of moisture. Finished iron or steel surfaces not painted shall be properly protected to prevent rust and corrosion.
- C. All equipment delivered to the site shall be stored as specified in accordance with the manufacturer's instructions.

### PART 2 PRODUCTS

#### 2.01 MANUFACTURERS

- A. Aerzen, Model GM 3S
- B. Roots/Howden
- C. Gardner Denver-Sutorbilt
- D. Approved equal.
- E. Should equipment which differs from the first named in this Section be offered and determined to be the equal of that specified, such equipment shall be acceptable only on the basis that any revision in the design and/or construction of the structure, piping, appurtenant equipment, electrical work, etc, required to accommodate such a substitution shall be made at no additional cost to the Owner and be as approved by the Engineer.

#### 2.02 DESIGN

- A. The equipment shall be designed, constructed and installed in accordance with the best practices and methods and shall operate satisfactorily when installed as shown on the Drawings.
  1. The performance data and manufacturing methods shall achieve a Declaration of Conformity, per Machinery Directive 2006/42/EC, Annex II, No.1 A.

Quantity of Machines	6
Design Inlet Temperature	100 °F
Site Elevation	50 feet above sea level
Design Inlet Pressure	14.67 psia



Design Relative Humidity (%)	80 %
Design Flow	110 scfm per machine
Design Discharge Pressure	4.50 psig
Maximum Blower Speed	3,470 RPM
Brake Horsepower (Max)	3.9 bHp
Motor Size (Max)	5 Hp

2. Package BHP to include pressure loss through a clean inlet filter / silencer, pressure loss of the exhaust silencer and check valve.
  3. Package Performance shall be guaranteed to ISO 1217 with a tolerance is +/- 5% on volume flow and +/- 5% on package horsepower.
  4. Sound data shall be from an ISO 2151 method of measurement, in an ISO 3745 qualified test facility. Sound data shall be compliant with a Declaration of Conformity assessment standard.
- B. Blower packages shall be designed to minimize the life-cycle costs and maximize plant reliability. The design and the selection of the components shall be based on a minimum useful life of 15 years and a Mean Time Between Overhauls of 5 years of continuous operation.
- C. No special foundations shall be required. The blower packages will be installed directly on a concrete slab without grouting the base frame. There shall only be 4 easily accessible anchor points.
- D. Manufacturer shall guarantee that the rotary lobe blower shall provide oil-free operation and be certified to ISO 8573-1 Class Zero.

## 2.03 MATERIALS

### A. Blower Casing:

1. The blower casing shall be of one-piece construction, with separate sideplates that are bolted and pinned to the housing.
2. Materials shall be close-grained cast iron ASTM A48 suitably ribbed to prevent distortion under the specified operating conditions.
3. Minimum blower casing pressure rating shall be 36 psig.
4. Inlet and outlet shall be flanged connections.
5. The casing shall incorporate a proven means of pulsation cancellation.
6. The vibration level as measured at the blower casing, in the X/Y planes of the bearings, shall not exceed ½ “/ sec RMS when operating at the specified maximum operating pressure and speed in the actual blower package.

### B. Factory Testing:

1. Each blower stage shall be factory tested in accordance with ISO 1217 performance test to verify flow and brake horsepower at blower maximum conditions. A slip test shall not be acceptable.

2. The acceptance criteria are +5% tolerance on power and –5% tolerance on flow regardless of the size of the machine.
3. The manufacturer shall submit free field noise data for the complete blower package. The results have been obtained using an ISO 2151 method of measurement, in an ISO 3745 qualified test facility. The performance data shall include a Declaration of Conformity, per Machinery Directive 2006/42/EC, Annex II, No.1 A.

C. Rotors:

1. Each rotor shall be of the “stiff” design with first lateral critical speed at least 120% of the maximum allowable operating speed.
2. The rotors shall be of the straight, three-lobe type, and shall operate without rubbing or liquid seals or lubrication.
3. Rotor/shaft shall be drop forged in one single piece of AISI 1043 or equivalent. Cast, hollow rotors shall be capped, dust tight. Open rotors are not acceptable.
4. The rotors shall be statically and dynamically balanced per ISO1940/ANSI S2.19 G6.3.

D. Bearings:

1. Each rotor/shaft shall be supported by anti-friction bearings, and fixed to control the axial location of the rotor/shaft in the unit.
2. Regardless of theoretical bearing life calculations, the bearings shall be sized for a minimum expected life of 5 years between overhauls.

E. Timing Gears:

1. The rotors shall be timed by a pair of single helical AGMA 12 quality gears with hardened and ground teeth; minimum AGMA service factor of 1.70.
2. Gears shall be mounted on the shafts with a tapered interference fit, and secured by a locknut.

F. Seals:

1. Seal shall be designed to prevent lubricant from leaking into the air stream as well as to prevent oil from leaking out of the machine.
2. Four rotary piston ring shaft seals, an oil slinger and an O-ring seal shall be provided at the point where the shaft passes through the sideplates.
3. Further provision shall be made to vent the rotor side of the oil seal to atmosphere to eliminate any possible carry-over of lubricant into the air stream.

G. Lubrication:

1. The timing gears and the bearings shall be splash lubricated. Grease lubrication shall be not acceptable.

H. Oil Sight Glass:

1. A recessed oil sight glass must be provided on each oil sump.
2. Protruding sight glasses shall not be acceptable.

I. Painting:

1. Painting shall be per supplier's standard meeting the following criteria:
  - a. Except for machined sealing and machined mounting surfaces, the package shall be painted dark blue.
  - b. Aluminum, stainless steel, and brass shall not be painted.
  - c. The supplied motor shall not be over sprayed and will be supplied with the motor manufacturer's standard protection and paint color.
  - d. Painted Cast Iron and Carbon Steel shall be Alkyd Resin Primer and Final coat with a total dry film thickness of 70µm. Surface preparation SSPC10 or better.
  - e. Sound enclosure shall be powder-coated polyester base total dry film thickness 80µm.
  - f. Galvanized components shall only be painted with appropriate surface preparation.

## 2.02 BLOWER ACCESSORIES

### A. Inlet Filter / Silencer:

1. Each package shall be supplied with one combination inlet filter silencer.
2. The inlet filter silencer shall be mounted directly to the inlet flange of the blower.
3. The filter media efficiency must meet the requirements of ASHRAE 52.2 MERV7 50-70% @3-10 microns corresponding to EN779 G4.
4. The silencer portion shall be located upstream of the inlet filter.
5. Filter and silencer performance losses shall be included in the blower performance calculation.

### B. Base Frame / Discharge Silencer:

1. Each package shall be supplied with one combination base frame / discharge silencer.
2. The silencer shall be a chamber type design for maximum sound attenuation and shall not use fibrous or absorption materials of any kind.
3. The silencer shall be fabricated of a single shell of pressure vessel quality steel with continuous welds.
4. The silencer shall be subject to a pressure test for tightness and strength at a minimum of 1.65 times the maximum blower operating pressure.
5. The silencer shall have a machined inlet connection where the discharge flange of the blower stage bolts directly to, with no intermediary pieces.
6. Discharge silencer performance losses shall be included by the blower vendor in the blower performance calculation.
7. The base frame shall be constructed from welded carbon steel or cast iron that shall be designed to maintain alignment of the blower internal components and the drive during operation.
8. The base frame shall be designed to resist distortion while being installed on vibration isolating mounts.

9. The blower manufacturer shall supply a stainless steel grounding lug fully welded to the base.

C. Flexible Connectors:

1. Each package shall be connected to the plant piping via flexible connector(s) located downstream of the discharge silencer.
2. Flexible connectors shall prevent the transmission of noise and vibrations from the blower package into the piping.
3. Flexible discharge connectors shall be a silicone rubber type pipe sleeve with stainless steel hose clamps, rated for 356 °F at 17.4 psig.

D. Electric Motor:

1. Each package shall be supplied with a WEG manufactured TEFC motor that shall operate on 460 Volts, 3 Phase, 60 Hertz current, 3600 RPM.
  - a. Torque NEMA B
  - b. Temperature Rise Class B
  - c. Dust tight enclosures (Severe Duty)
  - d. Class F inverter rated insulation
  - e. 3:1 constant torque
  - f. All cast iron construction, including frame, end bells, conduit box and fan cover
  - g. NPT threaded and gasketed F3 top mounted conduit box
  - h. Copper winding
2. All frame sizes shall be NEMA standard, suitable for overhung belt drive and with the conduit box location on top of the motor. IEC frame motors shall not be allowed.
3. The motor shall be mounted on a pivoting base to provide automatic tensioning of the belts.
4. The motor nominal rating after any corrections for ambient conditions shall be 10% above the maximum operating bHp.
5. The motor shall have a 1.15 service factor.
6. Motor windings shall be supplied with a normally closed thermostat, one per phase, wired in series to form a fail-safe motor protection circuit for the external fault circuit of the motor controller.
7. Blower manufacturer shall be responsible for coordinating the starting torque requirement of the blower and the motor.

E. V-Belt Drive:

1. Each package shall be supplied with a V-belt drive that shall be of the high capacity type, oil and heat resistant. Drive shall be designed for a minimum service factor of 1.4 times operating power (bHp), or 1.1 times the motor nameplate Hp, whichever is larger to allow a minimum of 1.4-service factor based on the maximum blower bHp.

2. Belt tensioning shall be automatic without the use of any devices or interaction on the part of the operator. Neither slide rails nor load-adjusting springs shall be used.
3. Sheaves shall be dynamically balanced regardless of the operating speed.

F. Belt Guard:

1. The belt drive shall be guarded in compliance with OSHA regulations.
2. Portions of the guard shall be easily removable allowing for belt inspection and replacement.
3. Guard material shall be perforated carbon steel.

G. Vibration Isolators:

1. Each package shall be supplied with vibration isolating feet with a minimum efficiency of 80%.
2. Blower manufacture shall be responsible for attenuating noise and vibration in the blower package such that no special installation base shall be required, nor shall any additional measures be required to reduce vibrations from the blower package being transmitted to the base or the piping.

H. Pressure Safety Valve:

1. Each package shall be supplied with a single pressure safety valve on the discharge side of the blower mounted downstream of the discharge silencer and upstream of the check valve.
2. The safety valve shall be set to protect the blower from exceeding its maximum pressure rating, and shall be sized to pass 100% of the design flow.
3. The safety valve shall be field adjustable, spring loaded, and have a certificate of conformity to PED.
4. The pressure relief valve shall be housed by the sound enclosure and shall relieve into a segmented section of the sound enclosure.
5. The valve shall be manufactured by the blower manufacture.

I. Check Valve:

1. Each package shall be supplied with one check valve that shall be installed on the discharge line.
2. The check valve shall be of the full-bore low pressure-drop, EPDM flapper type design with full-contact seal.
3. Pressure losses produced by the check valve shall be included in the blower performance calculation.
4. The valve shall be manufactured by the blower manufacture.

J. Instrumentation:

1. Each package shall be supplied with the following instrumentation:
  - a. Inlet Vacuum Gauge (2-1/2" Gauges)
    - i. Wika model 611.10 with 2 1/2" dial and scale from 0 to -60 mbar.

- ii. Gauge to function as a filter maintenance indicator.
  - b. Discharge Pressure Gauge (2-1/2" Gauges)
    - i. Wika model 213.40 with 2 1/2" dial and scale from 0 to 23 psig.
    - ii. The pressure gauge shall have a forged brass case and be glycerin-filled for pulsation dampening.
    - iii. A pulsation snubber shall be provided.
  - c. Discharge Temperature Gauge / Switch (2-1/2" Gauges)
    - i. Wika type SC15608S205-0 with 2 1/2" dial and scale from 32°F to 572°F
    - ii. UL & CSA approved.
  - d. Terminal Strip
    - i. The switches and motor thermostat shall be prewired to a labeled terminal junction box inside the blower enclosure.
- K. Each blower shall receive its initial oil filling at the factory. Oil to be fully synthetic Delta Lube or Mobil SHC 629.
- L. Acoustical Sound Enclosure:
  - 1. Each package shall be supplied with a sound enclosure covering the entire blower package.
  - 2. The enclosure shall provide suitable protection for outdoor installation under the specified site conditions (wind load and snow load).
  - 3. The enclosure shall be designed so as to be able to install them side-by-side with all maintenance done from the front or back of the package.
  - 4. Details shall be as follows:
    - a. Panels shall be made of galvanized steel sheet, powder coated in a light reflecting, color per RAL 5001. The skid shall be of the same color.
    - b. Sound enclosure acoustic material shall comply with UL 94 - HF1 for fire-retardant, self-extinguishing, non-dripping materials.
    - c. The enclosure and the blower package shall both be mounted on a skid / oil-drip pan designed for meeting environment protection standards and for easy transportation and installation.
    - d. A grounding strap shall be installed between the blower base and the package skid to bypass any vibration isolating mounts.
    - e. Quick release panels, each less than 50 lb (as mandated by MSHA) must provide easy and quick access for routine maintenance of the blower and the package components.
    - f. Enclosure Cooling Fan:
      - i. A high efficiency blower shaft driven ventilation fan shall provide ventilation and cooling integral to the sound enclosure.

- ii. Cooling fan shall be sized for sufficient heat removal from the sound enclosure.
- g. Electrical components, instrumentation and instrument connections shall not be mounted or interface with moving panels of the sound enclosure.

## PART 3 – EXECUTION

### 3.01 INSTALLATION

- A. The Contractor shall install the blowers in accordance with the manufacturer's written instructions.
- B. Representatives of the blower manufacturer shall verify and adjust blower and motor alignment.
- C. The Contractor shall make all electrical and process connections to the blower package prior to the arrival of the manufacturer's representative.

### 3.02 FIELD TESTING

- A. After installation of all equipment has been completed and as soon as conditions permit, the manufacturer shall provide one (1) trip for a total of one (1) 8 hour days to verify the installation and conduct an acceptance test under actual operating conditions. The test shall consist of 4 hours operation of each blower with readings taken and recorded at 30-minute intervals.
- B. If required, Contractor shall make any changes, at his own expense, to the installation that may be necessary to assure satisfactory operation. Contractor shall be held liable for changes needed in the installation.
- C. Manufacturer shall provide a written field test / start up report after completion of testing.
  - 1. The blower(s) shall be covered by a warranty for 24 months from date of commissioning, or a maximum of 30 months from date of shipment.

### 3.04 SPARE PARTS

- A. Furnish the manufacturer's recommended spare parts required in the first year of operation for each mixer, packaged and labeled, including at least the following:
  - 1. Complete set of matched V-belts
  - 2. One filter element
  - 3. Volume of oil for first service interval
- B. Spare parts shall be properly bound and labeled for easy identification without opening the packaging.

### 3.05 CONTRACT CLOSEOUT

- A. Provide in accordance with Section 01700.

END OF SECTION

## SECTION 11376

### FINE BUBBLE AERATION EQUIPMENT

#### PART 1 GENERAL

##### 1.01 SCOPE OF WORK

- A. This section includes the design, manufacture, installation and start-up of a flexible membrane, fine pore aeration system including in-basin aeration components as shown on the Drawings and as specified herein.
- B. The aeration system manufacturer shall provide single source responsibility for the complete aeration system including in-basin piping, diffuser assemblies and support components.

##### 1.02 DEFINITIONS

- A. Diffuser Unit: Fabricated unit including diffuser support frame and flexible membrane which releases air to the water.
- B. Air Drop Pipe: Vertical piping section from out-of-basin header stub to in-basin aeration system.
- C. Air Manifold Piping: Air distribution piping from drop pipe to air distribution headers.
- D. Air Header Distribution Piping: Air distribution piping from air manifold and diffuser assemblies.
- E. Air Header Piping: Out-of-basin air distribution piping from the blower building to the header stubs.
- F. Blower Manifold Piping: Air distribution piping between the blower discharge and air header piping.
- G. Aeration Grid: Associated piping and diffuser components connected to a single drop pipe.
- H. Standard Cubic Feet per Minute (scfm): Air at 68°F (20°C), 14.7 psia (101.35 kPa) and 36% relative humidity.
- I. Maximum Pressure: Pressure in blower manifold piping at the specified airflow rate.
- J. Oxygen Transfer Efficiency: Percent of oxygen in the air stream that is dissolved to the wastewater under specified conditions of temperature, barometric pressure, airflow rate, and dissolved oxygen concentration.
- K. Standard Oxygen Transfer Efficiency: Percent of oxygen in the air stream that is dissolved to clean water under conditions of 68°F (20°C), 14.7 psia (101.35 kPa), and zero dissolved oxygen.
- L. Air Distribution Uniformity: Variation in air distribution between diffuser assemblies.



### 1.03 SYSTEM DESCRIPTION

#### A. Design Requirements:

1. Design in-basin air piping and diffusers to diffuse air throughout the aeration tank(s) in accordance with the specifications.
2. Design each diffuser assembly to provide uniform air release over the specified airflow range.
3. Design the aeration system to provide the minimum specified oxygen transfer efficiency at the specified airflow and operating pressure.

### 1.04 SUBMITTALS

#### A. General:

1. A detailed engineering submittal package shall be provided in sufficient detail and scope to confirm compliance with the requirements of this section. Submittals shall be complete for all required components. Partial submittals will not be accepted.

#### B. Shop Drawings:

1. Detailed layout drawings for in-basin aeration components. Layout drawings shall include:
  - a. Layout and configuration of aeration system.
  - b. Detail drawings of diffuser assemblies showing components, method of construction, and attachment mechanism to air header distribution piping.
  - c. Detail drawings of all piping connections including drop to manifold, manifold to header and inline connections for manifold and headers.
  - d. Detail drawings of pipe support components.

#### C. Product Data:

1. Detailed listing of materials and materials of construction.
2. Product literature.

#### D. System Design and Performance Data:

1. Design calculations showing oxygen transfer based on guaranteed performance.
2. Include complete air headloss calculations for the aeration equipment from the top of the dropleg to the farthest diffuser bubble release point.
3. Design calculations showing uniform air distribution (+10% maximum variation) through lateral piping and diffuser element orifice system.
4. Design calculations for piping and support components.
5. Product Experience:
  - a. The supplier shall have experience in the design, manufacture, supply and commissioning of fine pore, flexible membrane aeration equipment identical to the type specified for this project.

- b. The equipment submitted shall be of proven design and shall be referenced by at least three installations of similar size, having been in successful operation for a period of not less than four (4) years prior to bid date.
  - c. If the Contractor elects to submit a substitute aeration system that does not comply with the above experience requirements, a bond guaranteeing the replacement of the aeration system shall be provided with the submittal package.
    - 1) The bond term shall be for a period of five (5) years. This term shall include the specified warranty period plus three (3) additional years.
    - 2) If the operation of the aeration system as determined by the Owner is unsatisfactory, the Contractor shall repair, modify or replace the entire aeration system in a manner acceptable to the Owner.
    - 3) Normal wear or malfunctions due to neglect or abuse shall not be considered justifiable reasons for unsatisfactory operations.
    - 4) The presence of chemical compounds that are aggressive to the membrane material are not considered as normal wear or service.
    - 5) If the Contractor fails to correct deficiencies identified by the Owner within six (6) months of the date first notified in writing, the Owner shall at its own discretion make all necessary repairs or replacement and deduct all associated costs from the Contractor's bond.
6. Guarantee:
- a. All equipment furnished under this contract shall be warranted to be free from defects in materials and workmanship for twelve (12) months from startup of the equipment or eighteen (18) months from shipment, whichever occurs first. Defective part(s) shall be remedied by repair or replacement of the defective part(s) only shipped freight included, FOB original shipping point, by the Manufacturer. Labor is excluded in this warranty.

E. Installation Instructions:

- 1. Installation requirements and guidelines for all proposed equipment shall be provided.
- 2. Information on the aeration system shall include but not be limited to:
  - a. Diffuser unit assembly.
  - b. Diffuser assembly attachment.
  - c. Piping components and assembly.
  - d. Piping support components.

F. Operation and Maintenance Data:

- 1. Operations and maintenance data for all proposed equipment shall be provided.
- 2. Information on the aeration system shall include but not be limited to:

- a. Air flow balancing.
- b. Diffuser assembly maintenance and membrane replacement.

#### 1.05 RELATED SECTIONS

- A. SECTION 01631 – USE OF OTHER THAN FIRST NAMED MANUFACTURERS
- B. SECTION 11961 – INTERIOR AND EXTERIOR PROCESS PIPING

### PART 2 PRODUCTS

#### 2.05 MANUFACTURERS

- A. Environmental Dynamics International, Columbia, MO
- B. Sanitaire
- C. Pre-approved equal.
- D. Should equipment which differs from the first named in this Section be offered and determined to be the equal of that specified, such equipment shall be acceptable only on the basis that any revision in the design and/or construction of the structure, piping, appurtenant equipment, electrical work, etc, required to accommodate such a substitution shall be made at no additional cost to the Owner and be as approved by the Engineer.

#### 2.06 MATERIALS

- A. Welded Stainless Steel Components:
  - 1. Sheets and plates of Type 304L stainless steel conforming to AISI 304L and ASTM A240.
  - 2. Limit carbon content to 0.30% maximum.
- B. Non-welded Stainless Steel Components:
  - 1. Sheets and plates of Type 304 stainless steel conforming to AISI 304 and ASTM A240.
- C. Fasteners and Anchorage Components:
  - 1. 18-8 series stainless steel.
- D. PVC Pipe and Fittings (Schedule 40 and 80):
  - 1. Base material shall be ASTM D-1784.
  - 2. Pipe shall be manufactured in accordance with ASTM D-1785 and ASTM D-2665.

#### 2.07 AERATION EQUIPMENT

- A. System Performance:
  - 1. The aeration-mixing system shall be designed to meet the following:

<b>Design for each of Two (2) Treatment Trains</b>				
	Average Day	Min Month	Max Month	Max Day
SOR (lb O <sub>2</sub> /hr)	1,350	1,050	1,800	2,000
Max Airflow* (scfm)	4,000	3,000	5,250	5,900
Min SOTE* (%)	35	36	33	32.5

- a. Discharge Pressure = 8.2 psig max at top of drop
- b. Design Diffuser Submergence = 18.36 ft maximum
- c. Quantity of diffusers to provide performance above to be split 50% into Aerobic Zone 1, 30% into Aerobic Zone 2, and 20% into Aerobic Zone 3.
- d. Swing Zone 1 shall match diffuser density in Aerobic Zone 1, and Swing Zone 2 shall match diffuser density in Aerobic Zone 3.

**B. Flexible Membrane, Fine Pore Diffusers:**

1. Each diffuser assembly shall be factory assembled and include two diffuser units and mounting saddle.
2. Diffusers unit shall have nominal dimensions of 4.5 inches (114.3 mm) in diameter and 53.5 inches (1359 mm) long.
3. The diffuser membrane shall be fully supported over full length and circumference with a 4.5 inch (114.3 mm) PVC membrane support frame.
  - a. Use of a non-fully supported diffuser membrane is not acceptable.
4. The diffuser support frame shall have a full diameter mounting connection.
  - a. Use of non-full diameter mechanical connections including threaded connections is not acceptable.
5. The diffuser membrane shall be held in place by two 304 stainless clamps.
  - a. Retainer clamps shall be crimp type. Worm gear type clamps are not acceptable.
6. Installation of the diffuser membrane shall be accomplished with the removal and installation of the membrane clamps.
  - a. Disassembly of diffuser assembly to remove and install membranes is not acceptable.
7. Individual diffuser units shall be provided with an internal end cap.
  - a. Internal end cap placement shall minimize the operating uplift weight of the assembly.

8. The diffuser unit shall be fully capable of operating under continuous or intermittent conditions and shall be designed with check valve capabilities to prevent entry of mixed liquor into the diffuser unit or air piping on air shutdown or interruption of air supply. A minimum of three (3) check valve features shall be provided, not limited to the following:
    - a. Membrane shall be elastic and allow openings to close when the air supply is interrupted.
    - b. Membrane shall contract and close around full diameter support frame.
    - c. Membrane shall employ a non-perforated section that is aligned and seals against the support frame, air distribution orifices.
    - d. Use of independent or internal check valve components is not acceptable.
  9. Diffuser assemblies shall be completely factory assembled with diffuser units, membranes and mounting saddle factory installed.
    - a. Field solvent welding or assembly of diffuser is not acceptable.
  10. Diffuser assemblies shall be shipped to the jobsite assembled and properly crated and protected for shipment and handling.
  11. Diffuser saddle mount shall be ABS or PVC construction and shall be capable of withstanding an external force of 7,500 inch-pounds (850 N-m) without structural failure of the air distribution pipe, diffuser unit connection or mounting saddle.
    - a. Small diameter threaded connections to attach diffusers to the air distribution header are not acceptable.
    - b. Saddle mount shall fully encompass the air distribution header and reinforce the pipe section at the diffuser assembly connection.
    - c. Alignment plug shall be provided to ensure proper alignment and resistance to rotation.
    - d. An O-ring gasket shall be provided to ensure an air tight seal between the mounting saddle and air header.
  12. A minimum 3.5 inch (88.9 mm) diameter connection shall be provided between the saddle mount and diffuser assembly.
- C. Flexible Membrane:
1. Membrane material for the diffuser unit shall be EPDM rubber.
    - a. Alternate membrane materials are not acceptable.
  2. Membrane shall be extruded in a single piece with the following characteristics.
    - a. Perforated length on diffuser membrane shall be 1308 mm.
    - b. Membrane shall be perforated on the top half of the sleeve.
    - c. Non-perforated membrane section shall be provided to seal off air distribution orifices on the diffuser support structure.

#### D. Aeration System Piping:

1. Out-of-basin air piping including blower manifold, air header, and header stubs are required and are to be supplied by the Contractor.
  - a. Header stubs shall extend to the inside top of the wall and terminate with a full diameter, horizontal face, flange.
  - b. Out-of-basin piping may be unlined ductile iron, galvanized steel, stainless steel, or painted carbon steel.
  - c. The Contractor shall provide an isolating/balancing valve for control and distribution of air to the aeration grid and to allow isolating of the grid for inspection and maintenance on the header stub.
  - d. Isolation/balancing valve shall be positioned for accessibility from the top of the tank.
2. Drop pipe shall be provided with a flanged top connection and plain end.
  - a. Drop pipe shall extend from the top connection to within 2 feet (0.61 m) of the air manifold.
  - b. Material of construction for the drop pipe shall be schedule 5, stainless steel.
  - c. Drop pipe shall connect to air manifold piping by means of a wrap-around clamp adapter.
3. All submerged manifolds and header components shall be Schedule 40 PVC minimum.
  - a. Use of PVC piping shall only be employed when the expected mean wall temperature is less than 140°C. If temperature exceeds this limit, alternate materials shall be used or cooling loops added until the temperature is at the appropriate level.
  - b. Use of PVC piping shall only be employed when diffuser mounting system reinforces pipe wall at each mounting location.
  - c. Use of non-reinforced diffuser connections including threaded diffuser mounts is not acceptable.
4. Pipe supports shall be all stainless steel construction.
  - a. Supports shall accommodate longitudinal movement in the piping components due to the thermal expansion and contraction over a temperature range of 100°F (37.7°C).
  - b. Supports shall restrain the axial and rotational movement of the pipe while providing for unrestrained longitudinal movement.
  - c. Supports shall allow leveling of the air piping with 2 inch (50.8 mm) minimum vertical adjustment at each support.
  - d. Each pipe support shall be connected to basin floor by at least 2 anchor bolts.

- e. The integrated pipe support assembly shall be designed to withstand the associated uplift force of the piping and diffuser assemblies with a minimum design factor of safety equal to ten (10).

E. Spare Parts:

1. The Contractor shall furnish the following spare parts and store as directed:
  - a. Fifteen (15) - Diffuser assemblies completely factory assembled.
  - b. Fifty (50) – Membrane sleeves and stainless steel membrane clamps.

## PART 3 EXECUTION

### 3.01 INSTALLATION

- A. Contractor shall furnish, inspect, store, and install aeration system in accordance with manufacturer's written instructions and approved submittals.
- B. Diffuser assemblies on a common grid shall be installed within an elevation tolerance of  $\pm 1/2$  inch (12.7 mm).
- C. Contractor shall provide all valves, air header piping, wall sleeves with seals, wall pipes, and concrete pedestals as necessary to complete the system as shown on the plans.
- D. Air piping including blower manifold, header, and in-basin piping must be clean prior to delivering air up the diffusers.
- E. Contractor shall be responsible for cleanliness of piping and may be required to manually clean pipe, or air or water flush piping as required.

### 3.02 START-UP

- A. After installation is completed, the Contractor shall perform the following field tests in the presence of the Engineer and the Owner.
  1. Fill the reactor to the bottom of the diffuser assemblies.
  2. Adjust the pipe supports and diffuser assemblies such that all diffuser units are installed within  $\pm 1/2$  inch (12.7 mm) of the design diffuser elevation.
  3. Fill the reactor to a level of 2 feet (0.61 m) above the top of the diffusers.
  4. Release air to the system and inspect the system for air leaks at all piping or diffuser connections.
  5. Check all membrane for cuts or tears that may have occurred during the installation.
  6. Adjust any piping or diffusers that show leaks or disproportionate amount of airflow.
  7. Operate the blowers at the design air rate and observe air release and air distribution patterns.

8. All air, power, and labor associated with testing and adjustment of diffuser assemblies are to be supplied by Contractor. Plant water will be supplied by the WWTF operator. The contractor shall assume plant water will be available at a flowrate of 200 gpm. Contractor is responsible for pumps and piping required for testing.

**B. MANUFACTURER'S FIELD SERVICES**

1. A manufacturer's representative shall be present at the job site to inspect the installation of the equipment, start-up the system, and train operations and maintenance personnel on the supplied equipment.
2. Services including a total of three (3) trips with a total of six (6) days onsite shall be provided.

END OF SECTION



## SECTION 11378

### SINGLE-STAGE CENTRIFUGAL AIR BLOWERS

#### PART 1 - GENERAL

##### 1.01 SECTION INCLUDES

A. This specification covers furnishing, installing, testing, and placing in satisfactory operation four (4) electric motor driven single-stage centrifugal aeration blowers with constant speed motors and motor soft starters (by others). The supplier of the blowers shall also provide a master panel to control the air flow rates and dissolved oxygen concentrations in the biological treatment process. However, the supplier of the blowers will not be responsible for supplying the instrumentation and control devices within the biological treatment tanks. These instruments include:

- Dissolved Oxygen Sensors/Controllers
- pH Sensors/Controllers
- Nitrate Sensors/Controllers
- Ammonia Analyzers/Controllers
- Air Flow Meters and Air Flow Control Valves
- Air Header Pressure Transmitter

Signals from the Air Flow Meters and the Air Flow Control Valves will be wired to the master control panel supplied by the blower manufacturer, by the Contractor, for inclusion into the dissolved oxygen control strategy. Signals from the pH sensors, dissolved oxygen sensors, ammonia analyzers and nitrate sensors are being wired into the SCADA system and will be available over an Ethernet connection. A description of the master control panel is provided in Part 2 paragraph 2.20 of this Section.

B. The Drawings show the general location, orientation, and basic dimensions of the equipment to be furnished and installed. The Contractor shall verify all dimensions shown on the manufacturer's shop drawings. Equipment shall be installed and tested in strict accordance with the manufacturer's requirements and recommendations.

C. **Items in this specification section are subject to the American Iron and Steel requirements of P.L. 113-76, the Consolidated Appropriations Act of 2014.**

##### 1.02 RELATED SECTIONS

A. SECTION 01300 – SUBMITTALS

B. SECTION 01631 – USE OF OTHER THAN FIRST NAMED MANUFACTURERS

C. SECTION 01665 – SERVICES OF MANUFACTURER'S REPRESENTATIVES

D. SECTION 01680 – EQUIPMENT AND SYSTEM CHECKOUT, CERTIFICATION, AND TESTING

E. SECTION 01730 – OPERATION AND MAINTENANCE MANUALS

- F. SECTION 11376 – FINE BUBBLE AERATION EQUIPMENT
- G. SECTION 11961 – INTERIOR AND EXTERIOR PROCESS PIPING
- H. SECTION 13350 – INSTRUMENTATION
- I. SECTION 15066 – STAINLESS STEEL PIPE

### 1.03 REFERENCES

- A. American Iron & Steel Institute (AISI)
- B. American Society of Mechanical Engineers (ASME)
- C. National Electrical Manufacturers Association (NEMA)
- D. International Standards Organization (ISO)
- E. IEEE Standards association (IEEE)

### 1.04 SUBMITTALS

- A. Shop Drawings in accordance with specification Section 01300.
- B. **Certification of compliance with the American Iron and Steel requirements of P.L. 113-76, the Consolidated Appropriations Act of 2014, is required with all submittals.**
- C. Operation and Maintenance Manual in accordance with specification Section 01730.
- D. In addition, provide this information in the following format:
  - 1. Comments and exceptions paragraph by specification paragraph. Provide detailed information on structural, mechanical, electrical, or other changes or modifications necessary to adapt non-specified materials to the arrangement or details shown.
  - 2. General description of blower with all performance data, blower curves, and model.
  - 3. Mechanical drawings with general arrangement showing blower base dimensions, floor mounting, skid piping, overall weights, and weights of largest components requiring removal for maintenance.
  - 4. Process and instrumentation diagrams.
  - 5. Drawings of all control panels to include:
    - a. Electrical ladder diagram
    - b. Interconnects to all components outside the panel
    - c. Door layout
    - d. Interior layout
    - e. Sample Operator Interface screens for the local and master control panel
  - 6. Drawings of the main drive motor starter shall include:

- a. All installation dimensions
  - b. Access locations
  - c. Maintenance clearance requirements
  - d. Weights of assembly and any “rack out components”
  - e. Mounting requirements
7. Provide a main drive motor starter with an analysis demonstrating compliance with motor acceleration requirements, line current limits, and generally that the starter/motor combination will accelerate the load to full speed within the specified parameters.
  8. Starter installation, line and load wire sizing, installation, and connection hardware (lugs) is the responsibility of others.
  9. Operating description for the local (and master) control panels. As a minimum, provide a more detailed description than given in this specification, covering all logic and sequences of operation.
  10. Provide a detailed description of the data acquisition, remote monitoring, and predicted preventative maintenance software. Typical Operator Interface screens shall be provided with detailed descriptions, the various tattletale monitors, preventative maintenance items, and data logging features.
  11. Provide a detailed description that demonstrates the simultaneous and continuous efficiency optimization of the inlet guide vanes and variable diffuser vanes to obtain the lowest power consumption based on the three (3) variables of discharge temperature, differential pressure, and machine capacity.
  12. In addition to the above, Operation and Maintenance manuals shall include:
    - a. Unloading, handling, storage, and maintenance requirements.
    - b. Spare parts recommended list and those supplied per specifications.
    - c. Recommended lubricants
    - d. Surface preparation and shop paint specifications
    - e. Instrument settings
    - f. Troubleshooting guide
    - g. List of components and catalog cuts fully describing all items
    - h. Maintenance summary forms
    - i. Copy of the test results

#### 1.05 QUALITY ASSURANCE

- A. It is the intent of these specifications to procure a quality product by an established manufacturer, incorporating the latest design. The cost of the equipment shall include all royalties and costs arising from patents and licenses associated with furnishing the

specified equipment.

- B. All materials shall be designed to withstand the stresses encountered in fabrication, erection and operation. All equipment shall be of corrosion resistant materials with corrosion resistant coatings approved by the Engineer.

#### 1.06 WARRANTY

- A. The equipment manufacturer shall warrant all parts to be free from defective material and workmanship for a period of 24 months after start-up, however not longer than 30 months from delivery or supplier readiness notification. The manufacturer shall furnish to the Owner replacement for any such items found to be defective by the manufacturer.

### PART 2 - PRODUCTS

#### 2.01 MANUFACTURERS

- A. Next Turbo Americas, LLC
- B. Howden Roots (Turblex)
- C. Approved Equal
- D. Should equipment which differs from the first named in this Section be offered and determined to be the equal of that specified, such equipment shall be acceptable only on the basis that any revision in the design and/or construction of the structure, piping, appurtenant equipment, electrical work, etc, required to accommodate such a substitution shall be made at no additional cost to the Owner and be as approved by the Engineer.

#### 2.02 GENERAL

- A. The blowers shown and specified are based on Next Turbo model GTB-T20-XY. The blowers shall be equipped with a 200 HP motor 3-phase motor rated at 60 Hz. The capacity of each blower shall be 4000 SCFM at a discharge pressure of 8.7 psig. A total air flow rate of 12,000 SCFM with three blowers operating in parallel shall be achieved at a discharge pressure of 8.7 psig.
- B. The blowers will be used for supplying a variable volume of air to the aeration basins. The MCP, system software, air flow control valves (by others), instrumentation (by others) , and accessories shall optimize system operation. All items specified in this section shall be supplied by the Manufacturer to provide a sole source responsibility for a properly functioning aeration system with the objective to minimize power consumption while providing the proper volume of air to each aeration basin. All components shall be new. Both workmanship and materials shall be of the very best quality and conform to all applicable sections of these specifications. It shall be understood that components specified establish minimum requirements only, and do not relieve the Contractor of responsibility for providing a properly functioning system.

- C. The blowers shall be motor driven, single-stage centrifugal, vertical split type complete with integral gearbox and accessories as described herein. Each blower shall be provided with axial inlet, side discharge, with discharge adjustable radially in fifteen (15) degree increments.

## 2.03 DESIGN CONDITIONS

- A. Each of the four (4) aeration blowers shall be furnished for the design operating conditions and guarantee points as follows:

Design Point	Capacity %	Flow scfm	Discharge Pressure psig	Inlet Temperature °F	RH %	Specified Power HP	Evaluated Factor	Factored Power HP	
1	100	4200	8.7	95	50	188.4	0.10	18.8	
2	80	3360	8.7	40	50	138.8	0.40	55.5	
3	60	2520	8.7	0	20	107.2	0.40	42.9	
4	40	1680	8.7	75	50	83.3	0.10	8.3	
<b>Total Factored Power Draw (Hp)</b>									<b>125.5</b>

1. Blower Turndown, % of Capacity: 100% to 40%
- B. Blower power consumptions shall be guaranteed.
1. In the event the Total Factored Power Draw (as tested) is in excess of the specified Total Factored Power Draw, the units shall be re-worked and re-tested at no additional cost to the Owner, until they comply with the specifications.
  2. Alternately, the Owner may accept the blowers by imposing a power penalty of \$10,000 per horsepower per blower in excess of the Total Specified and Factored Power Draw. The penalty shall be calculated to the nearest tenth of a horsepower for each blower and deducted from the payments to the Contractor for the work performed. A credit will not be allowed for any blower whose tested Total Factored Horsepower Draw is under that specified.
- C. Blowers shall not surge or exceed the nameplate motor rating over the entire range of operation. Blowers shall maintain a minimum of 0.5 psig rise-to-surge over the range of operation. Blowers with a rise-to-surge margin less than 0.5 psig shall not be accepted.
- D. Blowers of a design requiring synchronization of air flow in order that two or more may operate in parallel shall not be acceptable; that is, the blowers shall operate in a cascade, not parallel, mode.

#### 2.04 BLOWER AND INTEGRAL GEARBOX

- A. Blower casing shall be made of Nodular GJS400 cast iron, it will have a maximum continuous duty design temperature of 200°C, and a design pressure of 6.5 bar. The discharge flange shall be faced and drilled to ANSI B16.1, Class 125 pound.
- B. The gear drive housing shall be of Nodular cast iron GJS400, vertically split and sufficiently rigid to maintain the shaft positions under maximum loads. Horizontally split gearboxes shall not be allowed.
- C. The gearbox shall have an inspection port on one side for visual inspection of the gears and gearbox internals. Gearboxes requiring disassembly of the gearbox to visually inspect the gears and gearbox internals shall not be allowed.

#### 2.05 IMPELLERS

- A. The impeller shall be of the open radial flow type, with backward leaning blades and milled from forged aluminum alloy. Impellers constructed of any other method or material shall not be acceptable. The impeller must withstand corrosion up to 10 ppm of H<sub>2</sub>S. The impeller shall be attached to the shaft by interference fit arrangement. The impeller shall be statically and dynamically balanced.
- B. For the purposes of reducing the complexity and time to preventatively maintain and clean the entire air-end, complete access to the impeller shall only be available from the front of the unit by removing the volute and diffuser plate assembly leaving the impeller intact. The requirement to remove the impeller and/or pinion shaft to clean the diffuser vane assembly shall not be acceptable.

#### 2.06 VARIABLE VANES

- A. The purpose of the inlet guide vane and variable discharge diffuser system shall be to facilitate turndown of each blower from 100% to 40% of capacity, while maximizing efficiency over the entire turndown range.
- B. An adjustable inlet guide vane assembly shall be provided to pre-rotate incoming air and, thus, maximize efficiency. Inlet guide vanes shall be made in an aerodynamic, streamlined design in cross-section and located in a radial fashion around the inlet. Inlet guide vane position shall be controlled by the efficiency optimization software matrix from the LCP. The inlet guide vane assembly shall incorporate sealed bearings to assure permanent lubrication, preventing the vane assembly from becoming dirty and immovable.
- C. The inlet guide vanes shall modulate simultaneously with the diffuser vanes to continuously optimize efficiency based on the three variables of discharge temperature, differential pressure, and machine capacity. The Manufacturer shall demonstrate, in submittals and testing, the simultaneous efficiency optimization based on these three variables. Step control of vanes for efficiency optimization or control using less than these three variables shall not be acceptable. The use of inlet guide vanes for primary capacity control shall not be acceptable.

- D. Variable discharge diffuser vanes shall be provided for capacity control and designed to obtain the highest efficiency over the entire regulating range. Vanes shall be aerodynamically shaped for maximizing efficiency. To avoid unwarranted and invasive maintenance and to preventively clean the vanes and linkage, the diffuser plate shall detach from the unit without removal of the impeller or pinion shaft. Variable diffuser vanes shall be machined from one piece of metal. Multi-part diffuser vanes shall not be acceptable.
- E. Flat steel plates shall not be used for inlet guide vanes or the variable diffuser vanes. Each inlet guide vane or variable diffuser vane shall be machined from a solid piece of metal. Vanes which are held to their respective shafts by screws are unacceptable. Vanes made from castings shall not be acceptable.
- F. Blowers with variable vane assemblies located external to the blower housing, and/or have ball-in-socket linkages or other moving parts requiring periodic lubrication shall not be acceptable.
- G. Each variable vane assembly shall include a skid mounted electric actuator, limit switches, and open/closed indication on the LCP. Independent floor mounting of the actuator or its operating mechanisms shall not be allowed.
- H. The position of each set of vanes, from fully open to fully closed, shall be transmitted to the LCP via an analog signal. Position of both sets of vanes shall be indicated by an adjustable manual lever arm and calibrated dial on the blower, per se. The inlet guide vane, and the diffuser vane position shall be indicated on the LCP.

## 2.07 SHAFTS, GEARS, AND SEALS

- A. The blower gear shafts shall be machined from heat-treated, forged steel and suitably ground. Any responsive lateral critical speed of the rotating assembly shall be at least fifteen (15) percent from the normal operating speed. Any torsional resonances of the package shall be at least ten (10) percent from the normal operating speed.
- B. The speed-increasing, helical, parallel shaft type gears shall be made of case-hardened alloy steel forgings with the gear teeth precision ground. All gears shall be rated in accordance with “Fundamental Rating Factors and Calculation Methods for Involute Spur and Helical Gear Teeth” The gears shall be manufactured to a minimum AGMA quality number of twelve (12) per “Gear Classification and Inspection Handbook”.
- C. The shaft seals shall be of a non-contact, multi-point, non-wearing labyrinth type and operated dry. A vented space between air and oil seals shall be provided. Any leakage shall be minimized by having small clearances between female and male parts. The female part shall be made of aluminum or bronze to avoid damage to the shaft in the event of a seal rub. Numerous slinger rings (diameter changes) on the shaft shall be provided in the sealing area to ensure oil is centrifugally slung off the shaft. Uniform shaft diameter without multiple slinger rings in each sealing area will not be acceptable. Lip seals shall also be used on the pinion

shaft.

- D. Oil lubricated angular contact hybrid roller bearings with steel race and Silicon Nitride (Si<sub>3</sub>N<sub>4</sub>) ceramic balls shall be used for the high-speed pinion shaft. Anti-friction bearings shall be used for the low-speed shaft. Oil film sleeve, journal, or tilting pad bearings shall not be acceptable.

## 2.08 OIL LUBRICATION SYSTEM

- A. A lube oil system shall be provided with each blower, installed integral with the blower skid. A gearbox shaft-driven oil pump shall supply lubrication for the air blower/gearbox. The oil reservoir shall be integral to the gearbox. Blowers requiring more than one oil pump shall not be acceptable.
- B. The simplex oil filter shall be of the full flow, replaceable cartridge type, capable of removing particles over 10 microns with a clean oil filter pressure drop not exceeding 15 psi at design temperature and flow. A visual gauge shall indicate when a filter is dirty and requires cleaning.
- C. Provide an air-to-oil cooler to maintain constant oil temperature, mounted on each blower skid.

## 2.09 COUPLING

- A. A flexible, jaw-type spacer or dry spacer coupling shall be furnished to connect the blower and motor. A steel guard shall be provided and installed over the coupling.

## 2.10 EQUIPMENT BASE AND MOUNTINGS

- A. Manufacturer shall furnish a base of adequate size to support the blower, gearbox, motor, and accessories. The units shall be factory aligned on the base prior to shipment. Furnish vibration isolators.

## 2.11 ELECTRIC MOTORS

- A. Each blower shall be provided with a horizontal, constant speed, TEFC, squirrel cage induction motor designed in accordance with current NEMA, ANSI and IEEE standards. The motor horsepower shall be equal to, or in excess of, maximum normal load that will be imposed at any point in the operating range of the design conditions specified. Each motor shall have a 1.15 service factor with Class "B" insulation. Each motor shall be premium balanced for reduced vibration and supplied with lifting lugs and space heaters.
- B. Motors shall be high efficiency design. Efficiencies shall be determined in accordance with NEMA. Motors shall be given a standard, short commercial test.
- C. All motors shall be suitable for operation on 480/60/3 power for ambient air temperature up to 105°F. Motors shall be suitable for full voltage, across the line start.



## 2.12 INLET FILTER SILENCER

- A. Each blower shall be provided with an inlet filter/silencer designed for maximum air flow at absolute minimum pressure drop and connected directly to the inlet of the blower via a flexible connector. Legs shall be adjustable for vertical positioning and leveling.
- B. The filter elements shall be rectangular, replaceable, and the coarse pre-filter shall have a rating of Merv 4 or better. The final filter element shall have a rating of Merv 8 or better. The filters shall be sized for a maximum face velocity of 575 feet/minute at peak air flow.
- C. Maximum clean filter pressure drop of the inlet filter/silencer with the elements installed shall be 2.5 in. w.c. (0.09 psig). Maximum pressure drop with dirty inlet filters shall be 4.2 inch w.c. (0.15 psig).

## 2.13 DISCHARGE EXPANSION JOINT

- A. Provide each blower with a discharge expansion joint, for field installation by the Contractor, capable of withstanding the vacuum, pressure, and high discharge air temperature under all operating conditions. The expansion joint shall be suitable for mounting between flanges drilled for standard ANSI 150 pound pattern.

## 2.14 DISCHARGE CONE/SILENCER

- A. Provide a discharge cone/silencer, for field installation by the Contractor, to increase the blower outlet size to the larger diameter air discharge piping. Maximum sidewall angle increase shall be 7° per side (14° total). Instrument connections shall be provided, for components mounted by the Contractor, on the cone/silencer. The inside of the discharge cone/silencer shall be lined with deep layers of sound absorbing material, resistant to high temperatures.

## 2.15 BLOWOFF (BYPASS) VALVE

- A. Provide each blower with a steel or cast iron, or ductile iron body wafer type butterfly valve for field installation and wiring to the LCP by the Contractor to allow unloaded start-up and stop. The valve shall be a resilient seated butterfly valve suitable for air service up to 250°F. The valve actuator shall be motorized (120V/60Hz/1phase) and NEMA 4 rated. The valve shall open/close in fifteen (15) seconds or less. Internal open/close limit switches shall be provided. Controls for the valve shall be mounted in each LCP with indicator lights to annunciate fully open or closed. Bolting and gaskets shall be provided by the Contractor.

## 2.17 CHECK VALVE

- A. Provide each blower with a wafer type discharge check valve of the dual, plate type with center hinge, spring closure, cast iron or ductile iron body, Viton-B seal and aluminum-bronze plates, Inkonel springs, and rated for temperatures up to 400°F. The check valve shall be mounted and installed by the Contractor, in a horizontal run of piping, as shown on the drawings.

## 2.17 BLOW-OFF SILENCER

- A. A carbon steel blow-off silencer shall be provided for each blower and the main air header blow-off valve (if provided). The blow-off silencer shall be an integral unit, fitted with one (1) flange for direct bolting to the blow-off valve, with installation by the Contractor. The silencer will be externally mounted off the discharge.

## 2.18 INSTRUMENTATION

- A. Instrumentation provided by the Manufacturer shall be mounted on the blower skid, except as noted, with all electrical connections external to the skid, brought to the skid-mounted LCP, by the Contractor.
- B. Instrumentation for each blower shall include, as a minimum:
  - 1. Inlet air filter differential pressure transmitter w/display specifically designed for filter monitoring in air handler units. The unit shall be installed on the filter housing and wired to the LCP by the Contractor.
  - 2. Inlet air temperature gauge
  - 3. Inlet air temperature transmitter 4-20 mA
  - 4. Surge switch
  - 5. Discharge air pressure gauge (installed by the Contractor)
  - 6. Differential pressure (inlet/discharge) transmitter 4-20 mA (1/4-inch tubing between the transmitter and the discharge cone provided by and installed by the Contractor)
  - 7. Oil temperature transmitter
  - 8. Oil temperature gauge
  - 9. Oil low pressure switch
  - 10. Oil filter differential pressure switch with integral dirty filter indication.
  - 11. Vibration transmitter (4-20 mA)
  - 12. Bearing temperature RTDs
  - 13. Variable diffuser position transmitter
  - 14. Inlet guide vane position transmitter
  - 15. Blow-off valve limit switches (integral with blow-off valve and wired to the LCP by the Contractor – power and valve position)
  - 16. Discharge valve limit switches (integral with discharge valve and wired to the LCP by the Contractor)
  - 17. Temperature Transmitter on the Discharge Cone (field wired to the Local Control Panel by the Contractor. )

## 2.19 LOCAL CONTROL PANEL (LCP)

- A. Each blower shall be furnished with a skid-mounted PLC-based sequencing panel. All controls and instruments shall fail into a safe condition. The controls shall be designed such that the blower cannot operate unless the controls are energized, nor can they operate with any defective controls.
- B. The NEMA 12 rated enclosure shall be mounted on the blower skid and fitted with a hinged door for front access. The Contractor shall provide and wire the 120/60/1, 30-amp power supply. Each assembled control panel shall carry a UL label certifying the assembled industrial control panel complies with UL 508.
- C. Each blower LCP shall contain controls for blower motor starting, surge and overload detection, shutdown control and sequencing, alarm and emergency shutdown systems, inlet guide vanes, variable diffuser vanes, discharge valve, bypass valve, and the oil lubrication system operation.
- D. Each LCP shall contain a main power disconnect, which interlocks the enclosure door. Starters for variable vane operators (air/oil cooler, if applicable) shall be mounted inside the panel. Provide a separate 24V DC regulated power supply for the guide vane actuators. Provide for power distribution to feed motorized valve motor controllers located at the valves. Soft starter for the main drive motor is located in the motor control center (MCC) and provided by others.
- E. An Allen Bradley CompactLogix controller shall start and shut down the blower in a permissive sequence, receive input, monitor and control operating variables. The PLC shall also contain a program for continuous optimization of blower efficiency with respect to changes in capacity, inlet temperature, and differential pressure across the blower.
- F. Identify each end of each wire by a unique wire number printed on sleeve label.
- G. Provide an Allen Bradley PanelView 5000 series HMI screen that incorporates all controls, alarms, and meters in easy-to-interpret color screens. Operator Interface shall have a 7-inch screen.
- H. The operating screens (pages) shall be custom tailored to provide not only start-stop and operational mode interface, but also alarm status, and diagnostics. The following general design protocol shall be incorporated:
  - 1. When an alarm occurs, it is displayed on all screens, and a message screen appears to identify the problem.
- I. Provide touch sensitive screen point control via the Operator Interface screens, status indication, and readout for the following functions.
  - 1. Starter blower
  - 2. Stop blower
  - 3. Local control
  - 4. Remote/Auto control

5. Open blow-off valve
  6. Close blow-off valve
  7. Open discharge valve
  8. Close discharge valve
  9. Open variable diffuser vane
  10. Close variable diffuser vane
  11. Open inlet guide vane
  12. Close inlet guide vane
  13. Low oil pressure indicator
  14. High oil temperature indicator
  15. Surge control indicator
  16. Inlet air high temperature (recirculation surge) indicator
  17. Inlet air filter high differential pressure indicator
  18. High vibration indicator
  19. General alarm indicator
  20. Global alarm reset
- J. Additional selector switches, pushbuttons, and indicators shall include:
1. Service/Normal - Located on the Operator Interface. This touch sensitive screen point allows permissive start of the blower components only in the Service Mode.
  2. Emergency stop mushroom button on panel door
  3. Separate, non-resettable hour meter.
- K. Monitor and indication of all analog signals shall be displayed on the Operator Interface, including, but not limited to:
1. Motor amps
  2. Variable diffuser vane position (40-100 percent capacity)
  3. Inlet guide vane position
  4. Temperature signals
  5. Pressure signals
- L. The blowers shall start under an automatic sequence initiated by the local start signal or the remote start signal when in remote/auto control. Upon signal to start, the PLC shall confirm that the inlet guide vanes and variable diffuser vanes are at minimum, the blow-off (bypass) valve is open, and the discharge valve is closed if actuated, or open if not actuated. All vanes and valves shall be equipped with limit switches on both the open and closed position to indicate position. If components are not properly

positioned, they shall move to their respective start positions automatically via the PLC logic.

Once all pre-start permissives are confirmed, the blower motor shall be started. A feedback signal from the MCC (by Contractor) shall confirm that the main drive motor starter has been energized. When the blower reaches operating speed, as determined by the motor start sequence, the PLC shall open the inlet guide vanes and discharge valve, close the blow-off (bypass) valve, and release control of the inlet guide vanes and variable diffuser vanes to local/remote control. If the components are not correctly positioned, interlocks shall be provided to prevent blower operation after the delay time during start-up. Provide sequence fail alarm and trip if any portion of the start, run, or stop sequence is not properly executed. The Operator Interface shall annunciate the function that caused the trip.

- M. The surge detection system shall sense unbalanced/surge conditions by use of pressure sensing devices. Detection of surge conditions shall trip the blower off-line.
- N. Motor overload protection software shall be provided to control the maximum vane setting on the blower, so that motor current does not exceed a pre-set level.
- O. There shall be three means of shutting down the blower:
  - 1. Normal Stop - Initiated by pushing the stop button or remote stop. The unit normally stops such that no surging occurs.
  - 2. Soft Stop - Initiated by:
    - a. High oil temperature
    - b. High inlet air temperature (recirculation/surge)
    - c. Discharge valve has not fully opened within two (2) minutes after receiving feedback signal from MCC
    - d. Blow-off valve has not closed within five (5) minutes after receiving feedback signal from MCC
    - e. Surge
      - Soft stop shall de-energize the main drive motor eight (8) seconds after alarm initiation to allow the blow-off valve to partially open.
  - 3. Emergency Stop – Initiated by:
    - a. Pushing emergency stop button
    - b. Low-low oil pressure
    - c. High vibration
    - d. No feedback signal from MCC during Start Sequence
    - e. Loss of feedback signal from MCC during Normal Operation
    - f. Sequence failure during start-up
    - g. PLC failure

- Emergency stop shall de-energize the main drive motor immediately. Normal stop functions follow.
- P. The high inlet air temperature (recirculation) alarm shall be active when there is no main motor feedback present at the LCP from the MCC. The purpose being to detect reverse air flow through the blower.
- Q. Data communication shall be provided between the PLC's, located in each LCP, the MCP, and the plant computer systems. This compatible interface shall be the responsibility of the systems integrator; however, the Manufacturer shall actively participate in this compatible interface. The Contractor shall field wire all items between components, as follows:

Data communication to/from the LCP shall be as follows via PLC interface:

To MCP (Master Control Panel):

1. Blower ready for start
2. Blower on
3. Maximum air flow
4. Minimum air flow
5. Common alarm
6. Blower in remote/auto

To and From Soft Starter/MCC (Motor Control Center) (by others) – (Hardwired digital signals by the Contractor):

1. Motor start signal to MCC (digital)
2. Run confirmation signal (digital feedback from MCC)
3. MCC alarm (digital)
4. Motor amps from MCC (analog)

## 2.20 MASTER CONTROL PANEL (MCP)

- A. The Master Control Panel (MCP) provides automatic control of multiple blowers based on air header pressure control or complete aeration system control through a touch screen operator interface (OI) monitor. In general, the MCP provides the following functions:
  - a. Lead-lag-lag2-standby blower assignment
  - b. Air header pressure control
  - c. Most open valve control (Dissolved Oxygen Setpoint with Optional Ammonia Trim)
- B. Lead-lag-lag2-standby blower assignment is based on the order in which the blowers are switched from local mode to remote mode. Switching from local to remote mode and vice versa can be done at the LCP (Local Control Panel) or MCP. By default,

the first unit switched to remote mode becomes the lead blower. The lag, lag 2 and standby blower positions are then determined by the order in which the subsequent blowers are switched to remote mode. A blower that is in the local mode or has an alarm will not be assigned a lead-lag position, and can operate independently of the master control. Lead-lag assignment will be automatically re-sequenced if a new lead blower is selected, or if a blower is switched back to local mode or taken out of sequence due to an alarm. There is also a lead-lag-lag2-standby selector switch on the MCP screen that may be used to select the sequence of blower start.

- C. A freestanding, NEMA 12 enclosure with a PLC-based sequencing program and 10-inch Operator Interface HMI shall be provided and tested by the Manufacturer for starting and stopping blowers automatically and to facilitate dissolved oxygen set point control. The Contractor shall provide and wire the 120/60/3, 30-amp power supply necessary for the MCP. Refer to the Electrical drawings and specifications for further requirements.

The Master Control Panel shall be Ethernet networked to the blower Local Control Panels and the plant SCADA system. All status, control and signals shall be available to SCADA over the connection.

D. Performance Requirements:

- a. The MCP shall provide air header pressure control over a range of 8.4 to 9.1 psig with any or all of the blowers in service. The PLC shall receive the main air header pressure 4-20 mA signal. The main air header pressure variable input is compared with an Operator adjustable air header set point, with the MCP directing increase or decrease of on-line blower volume to maintain the pre-set air header pressure. The discharge pressure set point shall be adjustable from the MCP or from a remote ethernet or analog input provided by others.
- b. The MCP shall provide two modes of air header pressure control:
  - 1. Fixed mode in which the set point is manually adjusted via controls on the front of the control panel.
  - 2. Most open valve control mode in which the pressure set point is based on air flow control valve position. In addition to the air header pressure 4-20 mA signal input, the MCP shall also receive position signal input from each air flow control valve). The pressure set point versus valve position function shall be a linear function derived from field operated experiments, which shall be designed and conducted by the Manufacturer during startup and testing (refer to Specification Section 01665) to determine the most efficient header pressure throughout the range of valve positions.
- c. The blower and aeration system control shall use inputs of dissolved oxygen, Ammonia Concentration, air flow, valve position, and main air header pressure to optimize system design, the objective being to operate at the lowest system pressure and DO to affect modulation of air flow to each online cell.

The MCP shall have process integrating control loops supporting two operator selectable means of control: 1) DO control and 2) DO control with Ammonia

Trim. Process data from instruments (provided by others) within the biological treatment process will be conveyed to the MCP through the plant SCADA system. Data will include DO in each treatment zone, air flow rates to each zone, the position of the air flow control valves and the ammonia concentration at the end of the aerobic process. Under both control schemes, the blowers shall be sequenced in a LEAD, LAG1, LAG2 and Standby configuration, with automatic and manual alternation being Operator adjustable via the HMI.

#### DO Control

DO in each aeration cell shall be maintained at a pre-set level from the MCP via a manual set point at the MCP for each aeration cell. The air flow meter shall be used as the control function and air flow control valve as the controlled function. The DO probes shall input to the MCP providing a secondary control loop to optimize the air flow rate with DO control. Maximum and minimum air flow set points limits and warning alarms shall not be operator adjustable and shall be coordinated with the fine bubble diffuser manufacturer based on design parameters set during the submittal stages by the Engineer.

#### DO Control with Ammonia Trim

Each Treatment Train will be equipped with an ammonia sensor that will be used to automatically adjust the DO setpoints in each aerobic cell based on the ammonia concentration. The “Ammonia Trim” control loop shall utilize an Ammonia concentration setpoint, deadband, lag time (time between changes to the DO setpoints), and minimum and maximum DO values. In general, if the ammonia concentration is at or near zero, the DO set points in the aerobic zones will be automatically adjusted downward in operator adjustable increments and times until the ammonia concentration rises to an operator adjustable ammonia setpoint. These parameters shall be operator adjustable. The objective is to operate the aerobic treatment process at the minimum possible DO concentration to achieve complete nitrification.

- d. Conversely, if the ammonia concentration is above a predetermined acceptable concentration, the targeted DO concentrations in the aerobic zones shall be increased incrementally until the ammonia concentration is at or near an operator adjustable ammonia setpoint. The MCP shall bring blowers on and off-line and increase/decrease on-line blower capacity based on cascade control logic. The result being operator adjustable increments of air throughout the entire range of one (1), two (2) or three (3) blowers on-line. In the event of a blower failure, the next blower in the pre-selected start sequence shall come on-line.
- e. The programmable electronic Operator Interface shall have multiple color screens to display operating variables, valve positions, and other relevant data. Operating screens shall have a touch sensitive screen point to select the start sequence of the blowers, a touch sensitive screen point for pressure set point adjustment and the local/remote touch sensitive screen point for local or remote pressure or most open valve system control. The operation shall be programmed to be user friendly



by providing sufficient prompting that an operator can intuitively follow through the commands to operate the blower system.

Displays and controls shall be provided to monitor all process variable input for master control and to monitor and modify set points, as required.

The monitor shall display screens identifying the blowers on-line including the lead blower and the ability to modify the lead blower selection.

The monitor shall provide options for control of the blowers and air flow control valves as a manual function, air header pressure controlled via manual set point, or via floating air header pressure set points based on most open valve philosophy. All valve positions shall be displayed with the most open valve being appropriately identified.

The color screens shall be submitted for review and approval during the Shop Drawing Phase. The screens shall be customized based on Engineers comments and shall provide operator adjustable process control parameters.

f. The MCP shall have status indicators for each blower as follows:

1. Blower in remote
2. Blower ready for start
3. Blower on
4. Common alarm

g. External signals from the MCP to each LCP shall be as follows:

1. Blower start/stop signal
2. Increase air flow
3. Decrease air flow

I. Data logging for troubleshooting purposes. The MCP shall log process data and blower data at a minimum of every 5 seconds to allow for quick troubleshooting of process or blower issues.

## 2.21 TESTING

A. One of each size main drive motor shall be given a standard, short commercial, non-witnessed test in accordance with IEEE test procedures. A certified motor data sheet shall be furnished for approval prior to shipment.

B. Each blower shall be tested in accordance with the ASME PTC-10-1997 edition or ISO 5389-2005. The test shall include determination of the surge point and verification of the guaranteed points. Test and calculation power tolerance shall not exceed  $\pm 4\%$ .

C. Test results of the motors, blower tests shall be included in the Operations & Maintenance Manual.

## PART 3 - EXECUTION

### 3.01 PRODUCT DELIVERY, STORAGE, AND HANDLING

- A. All equipment shall be skid mounted or crated to protect against damage during shipment. All parts shall be properly protected so that no damage or deterioration will occur during a prolonged delay from the time of shipment until installation is completed, and the units and equipment are ready for operation.
- B. Finished surfaces of all exposed flanges shall be protected by fiberboard blank flanges strongly built and securely bolted thereto.
- C. Shipment is not to be made until the Manufacturer coordinates shipment to the jobsite with the Contractor, assuring that the equipment will be properly received and stored.
- D. Upon receipt, store equipment in strict accordance with the Manufacturer's instructions, and connect and energize motor space heaters (and any other protective devices), as required.

### 3.02 SURFACE PREPARATION AND SHOP PAINTING

- A. All surfaces shall be prepared, shop primed, and finish painted with one finish coat of Manufacturer's standard paint system.
- B. Machine surfaces that are not painted shall be protected by coating with grease.

### 3.03 INSTALLATION

- A. The blowers, motors, all aeration instrumentation, and appurtenances shall be installed by the Contractor in accordance with the instructions of the Manufacturer and as shown on the drawings. All piping shall be supported so as to preclude the possibility of exerting undue forces and movements on the blower flanges. Each blower unit shall be mounted on a flat and level concrete pad or level floor ( $\pm 1/4$  inch) in accordance with the recommendations of the Manufacturer.
- B. The Contractor shall furnish the required piping, pipe supports, flange gaskets, bolts, nuts, oil, and grease for initial operation in accordance with the Manufacturer's recommendations.
- C. Start-up and training shall be completed as per Paragraph 3.04 for the aeration blowers. The main air header pressure transmitter, DO probe transmitters, air flowmeters, and air flow control valves shall all be started-up, and the system optimized for automatic, unattended operation. System time lags, speed of valve operation, fine tuning of control loops, and overall time lags shall all be set and optimized based on plant conditions. The entire system of aeration blowers, main air header pressure control, most open valve control, and overall aeration system automated operation shall be demonstrated to the satisfaction of the Engineer.

### 3.04 STARTUP SERVICE

- A. Provide in accordance with Specification Section 01665.
- B. The Manufacturer shall furnish experienced start-up/service personnel to inspect the final installation and supervise the field start-up tests of the equipment. The services shall be provided for a minimum of two (2), eight-hour (8-hr.) days for each unit, two (2) days for the MCP, and three (3) days for the aeration system valves, controls,

aeration system adjustment, and optimization. If there are difficulties in operation of the equipment due to the Manufacturer's fabrication or Contractor's installation, additional service shall be provided at no extra cost to the Owner.

- C. A factory representative, who has complete knowledge of proper operation and maintenance shall be provided for four (4) hours, if necessary, to instruct representatives of the Owner and Engineer on proper operation and maintenance, including start-up and shut-down procedures, proper lubrication practices, and troubleshooting of all equipment.

### 3.05 SPARE PARTS

- A. The Manufacturer shall furnish all special tools and appliances necessary to disassemble, service, repair, and adjust the equipment and appurtenances. The following spare parts shall be furnished:
  - 1. One complete set of all bearings for the blowers
  - 2. One complete set of o-rings, gaskets, and seals for the blowers
  - 3. One actuator for inlet guide vanes
  - 4. One actuator for variable diffuser vanes
  - 5. One set of oil filter cartridges for each unit
  - 6. One set of primary inlet air filters for each unit
- B. All spare parts shall be suitably packaged and clearly identified with indelible marking on the containers. Tools and spare parts (except for the air and oil filters) shall be supplied in a tool chest for long-term storage and marked with Manufacturer's name, along with a complete description of contents.

### 3.6 CONTRACT CLOSEOUT

- A. Provide in accordance with Section 01700.

END OF SECTION

## SECTION 11400

### POLYETHYLENE CHEMICAL STORAGE TANKS

#### PART 1 GENERAL

##### 1.01 SECTION INCLUDES

- A. This specification covers upright, double wall, high density polyethylene storage tank assemblies for chemical storage, including the Micro C storage tanks.
- B. **Items in this specification section are subject to the American Iron and Steel requirements of P.L. 113-76, the Consolidated Appropriations Act of 2014.**

##### 1.02 RELATED SECTIONS

- A. SECTION 01300 – SUBMITTALS
- B. SECTION 01631 – USE OF OTHER THAN FIRST NAMED MANUFACTURER
- C. SECTION 01730 – OPERATION AND MAINTENANCE MANUALS
- D. SECTION 02620 – HIGH DENSITY POLYETHYLENE PIPE
- E. SECTION 11300 – CHEMICAL METERING PUMPS
- F. SECTION 11961 – INTERIOR AND EXTERIOR PROCESS PIPING
- G. SECTION 13350 – INSTRUMENTATION

##### 1.03 REFERENCES

- A. ASTM D618 – Conditioning Plastics and Electrical Insulating Materials for Testing
- B. ASTM D638 – Tensile Properties of Plastics
- C. ASTM D790 – Flexural Properties of Unreinforced and Reinforced Plastics and Electrical Insulating Materials
- D. ASTM D883 – Definitions of Terms Relating to Plastics
- E. ASTM D1505 – Density of Plastics by the Density-Gradient Technique
- F. ASTM D1525 – Test Method for Vicat Softening Temperature of Plastics
- G. ASTM D1693 – Test Method for Environmental Stress-Cracking of Ethylene Plastics
- H. ASTM D1998 – Standard Specification for Polyethylene Upright Storage Tanks
- I. ASTM D2765 – Degree of Crosslinking in Crosslinked Ethylene Plastics as Determined by Solvent Extraction
- J. ASTM D2837 – Method for Obtaining Hydrostatic Design Basis for Thermoplastic Pipe Materials
- K. ASTM D3892 – Practice for Packaging/Packing of Plastics

- L. AATM F412 – Definitions of Terms Relating to Plastic Piping Systems
  - M. ARM (Association of Rotational Molders) Low Temperature Impact Resistance (Falling Dart Test Procedure)
  - N. ANSI B-16.5 Pipe Flanges and Flanged Fittings
  - O. OSHA 29 CFR 1910.106 Occupational Safety and Health Administration, Flammable and Combustible Liquids
- 1.03 SUBMITTALS
- A. Shop Drawings in accordance with specification Section 01300.
  - B. **Certification of compliance with the American Iron and Steel requirements of P.L. 113-76, the Consolidated Appropriations Act of 2014, is required with all submittals.**
  - C. Submit to the Engineer shop drawings showing details of construction and erection for each tank as follows:
    - 1. Dimensions of tank, fittings, and attachments, with bolt and gasket material.
    - 2. Locations of fittings and attachments and size of manway openings.
    - 3. Wall thickness calculations for each tank. Calculations shall be per ASTM D 1998-99 using 600 PSI design hoop stress @ 100° F.
    - 4. Resin used and a complete manufacturers specification of the resin use.
    - 5. Knuckle radius.
    - 6. Weight of tank.
    - 7. Corrosion data for all materials in contact with the chemicals.
    - 8. Certificate of Compliance stating:
      - i. All fittings, insulation, et cetera, have been installed by the tank manufacturer.
      - ii. Water tests have been performed by the manufacturer and all fittings were installed prior to water tests.
      - iii. All tanks are designed and manufactured in accordance with ASTM-D 1998 Type 1.
  - D. Operation and Maintenance Manual in accordance with specification Section 01730.
- 1.04 MARKING, DELIVERY, STORAGE, AND HANDLING
- A. In accordance with specification Section 01600.
  - B. The tanks shall be marked to identify the product, date (month and year) of manufacture, capacity, and serial number. The tank shall be shipped with a bar code label containing tank description, manufacturing order number, part number, serial number, manufacturer, and date.

- C. The proper caution or warning signs as prescribed by OSHA standard 29 CFR 1910.106 shall be customer determined and supplied.
- D. All packing, packaging, and marking provisions of ASTM Practice D3892 shall apply to this standard. Tank shall be wrapped in polyethylene to protect it from dirt, grease, oil, etc. during shipping and storage.
- E. Customer specified labeling shall be available.
- F. Tank shrink wrapping and bagging shall available upon customer request.
- G. All fittings shall be installed, removed, and shipped separately.

## PART 2 PRODUCTS

### 2.01 MANUFACTURERS

- A. Poly Processing Company Monroe, LA
- B. Assmann Corporation, Garrett, IN
- C. Snyder Industries, Inc., Lincoln, Nebraska
- D. Approved equal.
- E. Should equipment which differs from the first named in this Section be offered and determined to be the equal of that specified, such equipment shall be acceptable only on the basis that any revision in the design and/or construction of the structure, piping, appurtenant equipment, electrical work, etc, required to accommodate such a substitution shall be made at no additional cost to the Owner and be as approved by the Engineer.

### 2.02 DESIGN

- A. The assembly shall consist of one cylindrical inner primary tank and one blended form outer secondary tank. The tanks shall be designed for above-ground, vertical installation and be capable of containing chemicals at atmospheric pressure. The assembly shall be designed to prevent rainwater from entering the containment tank. The containment tank shall be designed to hold a minimum of 115% of the normal fill capacity of the primary tank.
- B. Each of the polyethylene storage tanks shall have a storage capacity of 5,400 gallons. The tanks shall have a maximum diameter of 12 feet.
- C. An atmospheric vent shall be provided at the top of each tank.

### 2.03 CHEMICAL COMPATIBILITY

- A. Tanks shall be capable of storing MicroC.
- B. Chemical compatibility shall be according to the following chemical resistance guides:
  - 1. Pruett, Kenneth M., "Chemical Resistance Guide for Elastomers", Compass Publications.

2. Pruett, Kenneth M., "Compass Corrosion Guide II", Compass Publications.

C. Construction

1. All tanks shall be:

a. Type I – molded from Cross-linked Polyethylene Resin

2.04 MATERIALS

A. The MicroC tank shall be molded from Grade I high density cross-linked polyethylene with an integral, internal lining molded from oxidation resistant polymer. The resin shall be Poly CL or Paxon 7000 Series, as manufactured by Exxon/Mobil Chemical Company with the anti-oxidant resistant liner being OR-1000 or approved equal.

B. For MicroC storage, the resin shall include additional medium density polyethylene (OR-1000) with four times (4X) the anti-oxidant properties of a standard polyethylene bonded to the interior surface during the manufacturing process. The oxidation resistant lining shall be an integrally molded part of the tank.

C. All polyethylene resin material shall contain a minimum of a UV-8 stabilizer as compounded by the resin manufacturer. Pigments shall not exceed 0.25% (dry blended) of the total weight.

D. Mechanical Properties of Type I tank material:

<u>PROPERTY</u>	<u>ASTM</u>	<u>VALUE</u>
Density (Resin)	D1505	0.938-0.946 g/cc
Tensile (Yield Stress 2"/min)	D638	3290 PSI
Elongation at Break (2"/min.)	D638	640%
ESCR (100% Igepal, Cond. A, F50)	D1693	>1000 hours
ESCR (10% Igepal, Cond. A, F50)	D1693	>1000 hours
Vicat Softening Degrees F. Temperature	D1525	248
Flexural Modulus	D790	88,700 PSI

2.05 TANK DESIGN

A. The double-wall tank capacity shall be as indicated on the tank schedule and consist of an inner and outer tank each molded separately. The inner tank shall be one piece molded with a domed top. The outer tank shall be open top style with an internal flange.

B. The tanks shall be designed for 1.9 Specific Gravity using a hoop stress value of no greater than 600 psi at 100° F, with a safety factor of no less than 2, using the Barlow Formula for calculating wall thickness. For applications in excess of 100° F design conditions, lower values for the design hoop stress shall be used.

C. All edges cut out for manway or other openings shall be trimmed to have smooth edges.

- D. The finished surface shall be as free as commercially practical from visual defects such as foreign inclusions, air bubbles, pin holes and craters.
- E. The knuckle radius at bottom to wall shall be a minimum of 1". The minimum thickness of the radius shall not be less than the maximum thickness of the cylinder wall.

## 2.06 DIMENSIONS AND TOLERANCES

- A. All dimensions will be taken with the tank in the vertical position, unfilled. Tank dimensions will represent the exterior measurements.
  - 1. The tolerance for the outside diameter of the primary tank, including out of roundness, shall be per ASTM D1998.
  - 2. The tolerance for fitting placements shall be +/- 0.5 in. in elevation and 2 degrees radial at ambient temperature.

## 2.07 TEST METHODS

### A. Test Specimens

- 1. Test Specimens shall be taken from fitting location areas or piggy-back test molds.

### B. Low Temperature Impact Test

- 1. Test specimens shall be conditioned at -40 degrees Fahrenheit for a minimum of 2 hours.
- 2. The test specimens shall be impacted in accordance with the standard testing methods as found in ASTM D1998. Test specimens < 1/2" thickness shall be tested at 100 ft.-lb. Test specimens > 1/2" thickness shall be tested at 200 ft.-lb.

### C. Degree of Crosslinking Test

- 1. The test method used is to be the o-xylene insoluble fraction (gel test) per ASTM D2765 Method C. This test method is for determination of the ortho-xylene insoluble fraction (gel) of crosslinked polyethylene.
- 2. The percent gel level on the inside 1/8 in. of the wall shall be a minimum of 60%.

### D. Ultrasonic Tank Thickness Test

- 1. All tanks 2000 gallons or larger shall be measured for tank wall thickness at 6", 1ft., 2ft. and 3ft. on the tank sidewall height at 0° and 180° around the tank circumference with 0° being the tank manway and going counter-clockwise per ANSI standard drafting specifications. A copy of this test report can be ordered when placing the original tank order. All tanks shall meet design thickness requirements and tolerances.



#### E. Hydrostatic Water Test

1. The hydrostatic water test shall consist of filling the tank to brim full capacity for a minimum of four hours and conducting a visual inspection for leaks. A hydrostatic water test will be conducted if ordered by the customer.

### 2.08 WORKMANSHIP

- A. The finished tank wall shall be free, as commercially practicable, of visual defects such as foreign inclusions, air bubbles, pinholes, pimples, crazing, cracking and delaminations that will impair the serviceability of the vessel. Fine bubbles are acceptable to the degree in which they do not interfere with proper fusion of the resin melt.
- B. All cut edges where openings are cut into the tanks shall be trimmed smooth.

### 2.09 TANK FITTINGS

#### A. DOME FITTINGS

1. All dome fittings shall be flanged Universal Ball Dome style. There shall be a single 150 Lb. ANSI PVC flange with a ¼" gasket attached to the outside tank wall. The flange shall be bolted to the tank from the inside with a minimum of four (4) ½" diameter all thread bolts with bolt heads encapsulated in polyethylene. The encapsulation shall be a minimum 2" in diameter x .75" thick and fully cover the bolt head and a minimum of ¼" of the threads closest to the bolt head. Each bolt shall have a ¼" gasket which is on the inside of the tank. All dome fittings shall be fume tight. Bolts and gaskets shall be as specified in the tank data sheet.

#### B. VENT FITTINGS

1. The vent shall be built into the manway cover as described in Part 2.10 (A) below.

#### C. SIDE WALL FITTINGS FOR OUTER TANK DRAIN AND/OR OVERFLOW FITTING

1. Outer tank drain fitting shall be bolted flange style. There shall be a single 150 Lb. ANSI PVC flange and a ¼" gasket attached to the outside tank wall. The flange shall be bolted to the tank from the inside with a minimum of four (4) ½" diameter all thread bolts with bolt heads encapsulated in polyethylene. The encapsulation shall be a minimum 2" in diameter x .75" thick and fully cover the bolt head and a minimum of ¼" of the threads closest to the bolt head. Each bolt shall have a ¼" gasket which is on the inside of the tank. Bolts and gaskets shall be as specified in the tank data sheet.

#### D. THRU-WALL OUTLET FITTING

1. A through the double wall pump suction fitting shall be provided on each double-wall tank. Nozzle construction shall be designed to maintain secondary containment integrity. The inner tank fitting shall be a bolted flange type fitting with internal siphon with bolts and gaskets as specified. Attached to the secondary containment tank shall be a bellows type transition fitting PTFE expansion joint as specified and designed to accommodate movement of primary tank in design accordance with ASTM-D 1998 tolerances. PTFE Expansion joint to have a minimum of 3 convolutions, stainless steel limit cables and composite flanges. Expansion joint must meet the following minimum performance requirements: Axial Compression  $\geq .67''$ , Axial Extension  $\geq 0.67''$ , Lateral Deflection  $\geq 0.51''$ , Angular Deflection  $\geq 14^\circ$ , Torsional Rotation  $\geq 4^\circ$ . Bellows transition fitting shall be capable of connecting to a double-wall piping system over the primary pipe. Bolts and gaskets shall be as specified in the tank data sheet.

## 2.10 TANK ATTACHMENTS

### A. TIE DOWN SYSTEM

1. Tank manufacturer shall supply an outdoor seismic and wind restraint system. Restraint clips and cables shall be supplied by the tank manufacturer. Material of construction shall be galvanized steel. There shall be no protrusions through the wall. Anchor bolts shall be supplied by the GENERAL CONTRACTOR

### B. ULTRASONIC LEVEL INDICATOR

1. In accordance with specification Section 13350.

## 2.11 TANK ACCESSORIES

### A. MANWAY AND VENT

1. The manway openings for tanks shall be a minimum of 24" and have a combination type manway cover. Covers shall be 16-bolt and have a 10" coarse threaded cover with a push plate and XLPE gasket. The cover shall have two (2) XLPE foam gaskets and the bolts shall be polyethylene.
2. Each tank must be properly vented for the type of material and flow rates expected. Vents must comply with OSHA 1910.106 (F) (iii) (2) (IV) (9) normal venting for atmospheric tanks or other accepted standard, or shall be as large as the filling or withdrawal connection, whichever is larger but in no case less than 1 in. nominal inside diameter.

### B. LADDERS

1. Ladders shall be constructed of FRP. Ladders must be mounted to the tank so as to allow for tank expansion and contraction due to temperature and loading changes. All top ladder mounts shall be connected to integrally molded in attachment lugs that allow for tank movement.

## PART 3 EXECUTION

### 3.01 INSTALLATION

- A. Install the tank in accordance with the drawings and the manufacturer's instructions.
- B. Install the process piping in such a manner which allows the tank to expand and contract when filled and drained, as per the manufacturer's recommendation. All piping must be supported in accordance with the pipe manufacturer's recommendations. The expansion joint shall isolate the tank from the rest of the piping.
- C. Upon successful completion of the field test, tanks and support members shall be anchored in their final position according to the manufacturer's recommendations.

### 3.02 FIELD TESTING

- A. After installation, each tank shall be field tested by filling with water. The tank and fittings shall hold water without loss, evidence of weeping or capillary action for a period of 24 hours prior to acceptance.

END OF SECTION

## SECTION 11600

### FIBERGLASS REINFORCED PLASTIC (FRP) BAFFLE WALLS

#### PART 1 - GENERAL

##### 1.01 SECTION INCLUDES

- A. This specification covers fiberglass reinforced plastic (FRP) baffle walls to be installed in the biological treatment reactor. Design, furnish, install and test, FRP baffle walls, including supports and fasteners as indicated and specified.
- B. **Items in this specification section are subject to the American Iron and Steel requirements of P.L. 113-76, the Consolidated Appropriations Act of 2014.**

##### 1.02 RELATED SECTIONS

- A. SECTION 01300 – SUBMITTALS
- B. SECTION 01631 – USE OF OTHER THAN FIRST NAMED MANUFACTURERS

##### 1.03 REFERENCES

- A. ASTM D638 – Standard Test Method for Tensile Properties of Plastics
- B. ASTM D790 – Flexural Properties of Unreinforced and Reinforced Plastics and Electrical Insulating Materials
- C. ASTM D695 – Standard Test Method for Compressive Properties of Rigid Plastics
- D. ASTM D756 – Practice for Determination of Weight and Shape Changes of Plastics under Accelerated Service Conditions

##### 1.04 SUBMITTALS

- A. Shop Drawings in accordance with Specification Section 01300
- B. Submit the following:
  - 1. Baffle layouts for each grit chamber in full detail.
  - 2. Manufacturer's catalog information, descriptive literature, specifications and identification of materials of construction, including resins and glass fiber content and layout for FRP constructions.
  - 3. Detailed drawings showing method of attachment including number, locations and size of fasteners, wall anchorage, supports, and weights of fabrications.
  - 4. Special shipping, storage, protection and handling, and installations instructions.
  - 5. Certified test reports for physical and mechanical properties.
- C. **Certification that all iron or steel brackets, hardware, fittings or other components are produced in the United States in accordance with the American**

**Iron and Steel requirements of P.L. 113-76, the Consolidated Appropriations Act of 2014**

1.05 DELIVERY, STORAGE AND HANDLING

- A. Panels and columns shall be suitably packaged to avoid damage during handling and shipment in accordance with the manufacturer's recommendations. Should it be necessary to store the panels, precautions should be taken to prevent permanent warping or distortion. Store panels in a dry location, off the ground, and allow for ventilation.

PART 2 - PRODUCTS

2.01 MANUFACTURERS

- A. Enduro Composites, Houston, TX
- B. Approved Equal
- C. Should equipment which differs from the first named in this Section be offered and determined to be the equal of that specified, such equipment shall be acceptable only on the basis that any revision in the design and/or construction of the structure, piping, appurtenant equipment, electrical work, etc, required to accommodate such a substitution shall be made at no additional cost to the Owner and be as approved by the Engineer.

2.02 DESIGN

- A. The Contractor shall furnish and install fiberglass baffle walls complete as described on the Contract Drawings and in these Specifications. All fiberglass-reinforced plastic (FRP) utilized on this project shall be a commercial grade fiberglass meeting the minimum ASTM standards for the intended use
- B. Panel Loading: The panels shall be designed by the manufacturer to support, within allowable stress and deflection limitations, the following loadings:
  - 1. Lateral Load: Panels shall be designed to withstand 6 inches differential head of water between both sides of baffle wall and have a minimum factor of safety of 5.0.
  - 2. Vertical Load: The FRP baffle panels shall be designed to carry 20 pounds per foot along the length of the baffle panel with a factor of safety of 2.0. The baffles shall not be allowed to bow, crush or deflect to a point that causes permanent deformation or failure. Stiffener plates may be installed by manufacturer to increase the strength of the panel as required.
  - 3. Wind Load: The baffle system shall be designed to withstand a 20.7 psf wind load and have a minimum safety factor of 2.0.

2.03 MATERIALS

- A. Minimum panel thickness shall be 0.25 inches with a weight of approximately 4 pounds per square foot. Materials specified herein establish a minimum quality and performance standard to be met by any substitution. Applications for substitution

must include samples and technical information and the manufacturer must have five years of proven industry experience.

- B. Resin: The resin shall be a premium grade, chemically resistant isophthalic polyester resin that has been certified to be FDA approved (ANSI/NSF 061).
- C. Ultraviolet Resistance: UV protection shall be provided through the use of the following two methods. Both of these methods are required.
  - 1. Resin shall be UV stabilized with an ultraviolet inhibitor.
  - 2. A UV surface coating shall be applied to all exterior surfaces.
- D. Surface: Panel surfaces shall be smooth. If necessary, all cut ends, holes, and abrasions of FRP shall be sealed with a compatible resin coating.
- E. Glass Reinforcing: Panels shall be reinforced with a minimum 50 percent (by weight) continuous glass fibers.
- F. All mounting hardware (angles, anchor bolts, etc.) shall be either FRP or Type 316 stainless steel.

## PART 3 – EXECUTION

### 3.01 INSTALLATION

- A. Installation by the Contractor of the baffle walls shall be in strict accordance with the Manufacturer's and Engineer's instructions and recommendations in the locations shown on the drawings.
- B. Baffle panels shall be mounted to the tanks as shown on the drawings with 3"x3"x1/4" FRP angle. Angles shall act as slide guides for the baffle panels. Angles shall be provided by the baffle manufacturer and shall be predrilled for anchors and bolt assemblies to the concrete.
- C. Baffle system fasteners shall be Type 316 stainless steel bolts, washers and nuts. Connections to concrete shall be with Type 316 stainless steel epoxy doweled anchor bolts. Anchors and bolts shall be 1/2" diameter and provided by the baffle manufacturer.

### 3.02 TESTING

- A. Shop Testing: Full scale testing shall be performed to insure that the materials meet specifications. Test results shall be submitted to the Engineer for review.
- B. The manufacturer shall maintain a continuous quality control program and, upon request, furnish the Engineer with certified test reports consisting of the mechanical and physical tests listed below. Procedure to be used in determining the properties listed in Table 1 below shall be in accordance with the latest ASTM Standards:
  - 1. Ultimate Tensile Strength - ASTM D638
  - 2. Flexural Strength - ASTM D790

3. Modulus of Elasticity - ASTM D790
4. Barcol Hardness - ASTM 2583
5. Water Absorption - ASTM D570

3.03 CONTRACT CLOSEOUT

- A. Provide in accordance with Section 01700.

END OF SECTION 11600

## SECTION 11601

### FIBERGLASS REINFORCED PLASTIC WEIRS AND SCUM BAFFLES

#### PART 1 GENERAL

##### 1.01 SECTION INCLUDES

- A. This specification covers fiberglass reinforced plastic (FRP) weirs and scum baffles to be installed in final clarifiers.
- B. Products in this specification for installation in the Final Clarifiers are part of Additive Alternative #1

##### 1.02 RELATED SECTIONS

- A. SECTION 01300 – SUBMITTALS
- B. SECTION 01631 – USE OF OTHER THAN FIRST NAMED MANUFACTURER

##### 1.03 REFERENCES

- A. ASTM D638 – Standard Test Method for Tensile Properties of Plastics
- B. ASTM D790 – Flexural Properties of Unreinforced and Reinforced Plastics and Electrical Insulating Materials
- C. ASTM D695 – Standard Test Method for Compressive Properties of Rigid Plastics
- D. ASTM D756 – Practice for Determination of Weight and Shape Changes of Plastics under Accelerated Service Conditions

##### 1.04 SUBMITTALS

- A. Shop Drawings in accordance with specification Section 01300.
  - 1. Include manufacturer's catalog information, descriptive literature, specifications and identification of materials of construction, including resins and glass fiber content and layout for FRP constructions
  - 2. Detailed drawings showing method of attachment including number, locations and size of fasteners, wall anchorage, supports, and weights of fabrications
- B. Certification that all iron or steel brackets, hardware, fittings or other components are produced in the United States in accordance with the American Iron and Steel requirements of P.L. 113-76, the Consolidated Appropriations Act of 2014**

##### 1.05 MARKING, DELIVERY, STORAGE, AND HANDLING

- A. Ship and store FRP products to protect them from damage.

#### PART 2 PRODUCTS

##### 2.01 MANUFACTURERS



- A. NEFCO, Palm Beach Gardens, FL
- B. Enduro Composites, Houston, TX
- C. Fiberglass Fabricators, Inc., Smithfield, RI
- D. Approved Equal
- E. Should equipment which differs from the first named in this Section be offered and determined to be the equal of that specified, such equipment shall be acceptable only on the basis that any revision in the design and/or construction of the structure, piping, appurtenant equipment, electrical work, etc. required to accommodate such a substitution shall be made at no additional cost to the Owner and be as approved by the Engineer.

## 2.02 DESIGN

- A. The Contractor shall furnish and install fiberglass weirs and scum baffles complete as shown on the Contract Drawings and described in the Specifications. All Fiberglass Reinforced Plastic (FRP) utilized on the project shall be a commercial grade

## 2.03 MATERIALS

- A. Except for bolts and hardware specified herein, the weirs, scum baffles, and supports shall be polyester plastic resin, reinforced with glass fiber. All weir plates, weir splice plates, scum baffle plates, scum baffle splice plates and baffle support brackets shall be fiberglass reinforced plastic molded to produce uniform smooth surfaces. The surface shall be resin rich, free of voids and porosity, without dry spots, crazes or unreinforced areas and shall provide for increased corrosion resistance and UV protection.
- B. Expansion anchors, nuts, bolts, washers, and other hardware shall be Type 316 stainless steel unless otherwise noted.

## 2.04 RECTANGULAR WEIRS

- A. Weir plates and splice plates shall be 1/4-inch thick plastic laminate. Each weir plate shall be 9-inches high. Oversized mounting holes in the weir plates shall be provided for vertical and horizontal alignment of at least 2 inches with 4" x 4" aluminum plate washers to cover the holes. The weir sections shall be fastened to the launder wall with 1/2" x 4-1/4" stainless steel expansion anchors 2-feet on center. Cut ends of non-standard lengths shall be sealed with resin.

## 2.05 TRIANGULAR V-NOTCH WEIRS

- A. Weir plates and splice plates shall be 1/4-inch thick plastic laminate. Each weir plate shall be 9-inches high with 3-1/2 inch deep 90-degree v-notches at 7-inch intervals. Oversized mounting holes in the weir plates shall be provided for vertical and horizontal alignment of at least 2 inches with 4" x 4" aluminum plate washers to cover the holes. The weir sections shall be curved and fastened to the launder wall

with 1/2" x 4-1/4" stainless steel expansion anchors 2-feet on center. Cut ends of non-standard lengths shall be sealed with resin.

## 2.06 SCUM BAFFLES

- A. Scum baffle plates and splice plates shall be 1/4-inch-thick plastic laminate. Each scum baffle plate shall be 12-inches high and shall not exceed 12-feet in length unless otherwise noted. Splice plates shall be 6" x 12". The scum baffle support brackets shall be 6" x 6" x 3/8" angle (L-shaped) with slotted holes to provide horizontal, vertical and radial adjustment of the baffle. The baffle sections shall be curved and fastened to the adjustable baffle support brackets 4-feet on center. The adjustable baffle support brackets shall be fastened to the launder wall with 1/2" x 4-1/4" stainless steel expansion anchors. Fastening holes in the scum baffle panel shall be countersunk to accommodate flat head fasteners. Cut ends of non-standard lengths shall be sealed with resin.
- B. The distance between the baffle and weir plates shall be at least 8 inches. In the area of the scum box the scum baffle shall extend to 24 inches starting approximately 6 feet before and ending 2 feet after the scum box.

## PART 3 EXECUTION

### 3.01 INSTALLATION

- A. Install in accordance with the drawings and the manufacturer's instructions.
- B. Contractor shall field verify existing dimensions. Field cutting and drilling shall be permitted, provided the contractor seal all cuts and penetrations per the manufacturer's instructions.
- C. Weirs and baffles shall be aligned and leveled to the elevations shown on the Contract Drawings. No variation in elevation greater than 1/8" per 10' of any weir shall be permitted.

END OF SECTION

## SECTION 11961

### INTERIOR AND EXTERIOR PROCESS PIPING

#### PART 1 GENERAL

##### 1.01 SUMMARY

- A. The work covered under this Section of the Specifications includes the furnishing of all labor, equipment, and materials, and in performing all operations in connection with the furnishing, installation and testing of interior and exterior process piping systems, including piping, pipe fittings and specials, wall fittings, valves, jointing materials, and accessories, of the various materials, sizes, classes, joints and types, and appurtenant work, at the locations and to the general arrangements and details as indicated and/or as directed, complete in place, in accordance with the Drawings and Specifications.
- B. Multiple types of pipe and fittings specified in this section shall be produced in the United States in accordance with the American Iron and Steel requirements of P.L. 113-76, the Consolidated Appropriations Act of 2014. These items include (but are not limited to) the following:**
  - 1. Ductile Iron Pipe and Fittings**
  - 2. Carbon Steel Pipe and Fittings**
  - 3. Iron and Steel Valves**

##### 1.02 RELATED SECTIONS

- A. Section 01631 – Use of Other than First Named Manufacturer
- B. Section 02618 – Ductile Iron Pipe for Buried Service
- C. Section 02620 – HDPE Pipe for Buried Service
- D. Section 02622 – PVC Pipe for Buried Service
- E. Section 09900 – Painting
- F. Section 15060 – Pipe Hangers and Supports
- G. Section 15066 – Stainless Steel Pipe and Fittings

##### 1.03 REFERENCES

- A. ASTM A716 – Standard Specification for Ductile Iron Culvert Pipe
- B. ASTM A746 – Standard Specification for Ductile Iron Gravity Sewer Pipe

##### 1.04 SUBMITTALS

- A. Submit the following in accordance with Division 1 Specification Sections.
- B. Shop Drawings: Include materials lists, catalog cuts, and complete specifications for all piping materials including gaskets and connections. Shop drawings for all pumps, valves, valve operators, strainers, hangers and supports, wall pipes, wall sleeves, flexible connections, hydrants, nozzles, cleanouts, and other like manufactured items. Detailed piping layout drawings of all interior and exterior piping. Drawings of exterior piping shall also show the relationship between the work included in this section and that included in others where in close proximity.
- C. **Certification of compliance with the American Iron and Steel requirements of P.L. 113-76, the Consolidated Appropriations Act of 2014, is required with all submittals**
- D. Operation and Maintenance Manuals: Submit materials for inclusion in Operation and Maintenance Manuals specified in Division 1.

#### 1.05 MARKING, DELIVERY, STORAGE AND HANDLING

- A. All pipe shall be properly marked by the manufacturer in accordance with ASTM D2241. Markings shall be spaced at intervals of not more than five feet and shall include the following:
  - Nominal pipe size
  - Type of material with designation code
  - Pipe diameter to wall thickness ratio or class, as applicable
  - ASTM designation with which pipe complies
  - Manufacturer's name or trademark and code

### PART 2 - PRODUCTS

#### 2.01 PIPE SCHEDULE

- A. Pipes, fittings and specials, appurtenances and jointing shall be in accordance with the Pipe Schedule on Sheet M-0.1. This schedule is set forth as a guide as to types of materials and jointing required. Substitution of any pipe type, joint type, etc. shall only be done with approval of the Engineer. The lack of mention of any specific pipe shall not relieve the Contractor from the responsibility of furnishing and installing all piping as required or directed for a complete job. The schedule indicates the types of pipe required for the principal piping systems included under this Section of the Specifications and is presented herein for convenience of references for the Contractor.

#### 2.02 MATERIALS

- A. Ductile Iron Pipe and Fittings
  1. **Ductile Iron pipe and fittings shall be produced in the United States in accordance with the American Iron and Steel requirements of P.L. 113-76, the Consolidated Appropriations Act of 2014**
  2. Ductile Iron Pipe and Fittings shall be manufactured by:

- a. U.S. Pipe, Birmingham, AL
  - b. American Ductile Iron Pipe, Birmingham, AL
  - c. McWane Ductile, Phillipsburg, NJ
  - d. Approved equal
3. All ductile iron pipe shall be minimum of special thickness Class 52 unless otherwise noted. All ductile iron fittings shall be minimum of Pressure Class 250 unless otherwise noted. Ductile iron pipe and ductile iron pipe fittings and specials shall have cast upon them the class, thickness designation and initials of the manufacturer.
  4. Ductile iron pipe with screwed-on flanges shall be centrifugally cast pipe conforming to ANSI Specification A-21.51 of latest editions. Flanges for flanged pipe shall conform to ANSI Specifications B16.1, latest edition, for American 125 Standard and shall have long hubs. After flanges have been screwed onto the pipe the face of the flange and end of the pipe shall be refaced together in the shop and the flange shall be sealed with epoxy compound to prevent corrosion of threads from the outside. Flanges shall be faced and drilled to American 125 Standard and to match the facing and drilling of the equipment, valves and to such other items to which they are attached. Ends of pipe connecting to flexible mechanical couplings shall be suitable for and properly prepared for making the joint with the flexible mechanical coupling. Pipe shall be lined as specified herein.
  5. Ductile iron pipe with mechanical grooved couplings shall be centrifugally cast pipe conforming to ANSI Specification A-21.51 of latest revision. The pipe shall be radius grooved conforming to Victaulic Company of American's specifications for rigid joints. Flexible joints may be used to design considerations, as shown on drawings or detailed elsewhere in these specifications. Installation shall be in accordance with Victaulic Company of American's recommendations. Grooving dimensions are the same for any one pipe OD regardless of pipe class and pressure. The outside surface of pipe between the groove and pipe end must be smooth and free from deep pits or swells to provide a leaktight seat for the Victaulic gasket. All rust, loose scale, oil, grease and dirt shall be removed. Penned surfaces may require corrective action in order to provide a leaktight gasket seal.
  6. Ductile iron flanged joint fittings shall be of the types indicated or as required and approved, and shall conform to the requirements of ANSI Specifications A21.10, latest edition, Pressure Class 250. Flanges shall be cast integral with the pipe fittings and specials and shall be faced and drilled in accordance with ANSI Specification B 16.1, latest edition, for American 125 Standard, and facing and drilling of all flanges shall match that of the equipment, valves, and such other items to which they are attached. Blank flanges shall be provided as required. Flanged fittings not available under ANSI Specification 21.10 shall be provided as required and shall conform to the application ANSI Specifications B 16.1 or B 16.2. Pipe fittings and specials shall be lined as specified herein. Pipe fittings, specials and adapters shall be of the sizes, dimensions and types as indicated, as specified, as required for the proper fitting of the completed work, and as approved by the Owner.
  7. Fittings for mechanical joint pipe shall conform to requirements of ANSI specification A-21.10 with the exception of the end preparation. The end preparation

shall be radius grooved conforming to Victaulic Company of America's recommendations for rigid joints. Coupling housings shall be malleable iron conforming to the requirements of ASTM specification A-47 or of ductile iron conforming to the requirements of ASTM Specification A-536. Sizes 3-inches through 12-inches shall be of two segments; sizes 14-inches and larger shall be four or more segments. Couplings shall be Style 31 as manufactured by Victaulic or approved equal. Lightly coat pipe ends and all gasket surfaces with Victaulic lubricant or other non-petroleum base lubricant. Bolts and nuts shall be carbon steel heat-treated and plated, conforming to ASTM Specification A-183, minimum tensile 110,000 psi. Bolts shall be of oval neck, track head design. Gaskets shall be of the mechanical grooved coupling design with short center leg to bridge pipe ends, and shall have properties as designated by ASTM Specification D-2000. Such gaskets shall be suitable for the required service. Victaulic-Style 341/342 transition flanges shall be used for direct connection of 125 pounds cast iron flanged valves, pumps or other equipment, directly to grooved pipe or fittings. Victaulic Style 341/342 transition flanges shall be malleable iron conform to the requirements of ASTM Specification A-47 or ductile iron conforming to the requirements of ASTM Specification A-536. Gaskets shall have properties as designated by ASTM Specification D-2000 and shall be suitable for the required service.

8. All fittings associated with exterior ductile iron pipe shall be ductile iron with restrained joints conforming with ANSI A-21.10. Push on joints for such fittings shall be in accordance with ANSI A-21.11. All fittings shall be coated and lined as specified for its associated pipe and use. Restrained joint ductile iron pipe fittings shall be TR Flex® by US Pipe or equal.
9. Cement-mortar linings: Ductile iron pipe and ductile iron pipe fittings and specials, where indicated, shall be cement-mortar-lined in accordance with ANSI A-21.4. Thickness of the mortar lining shall be 1/8-inch for pipe 12-inches and smaller and 3/16-inch for pipe 14-inches and larger.
10. Glass lining: Glass lining where indicated shall be a specially formulated internal coating on ductile iron pipe or ductile iron pipe fittings and specials. All metal preparation, application and processing will follow the manufacturer's recommended procedures.
  - a. The coating shall consist of special glasses and inorganic materials applied in a minimum of two (2) coats, separately fired, to internal surfaces prepared by blasting. Following application of the ground (base) coat, the items shall be exposed to an appropriate maturing temperature (above 1400°F) to fuse the glass to the base metal forming an integral molecular bond with the metal. The resulting bond shall be sufficient to withstand a metal yield point of 0.001-inch/inch without damage to the glass.
  - b. Subsequent coatings (finish coats) shall be processed in a similar manner, forming an integral molecular bond with the base coat.
  - c. The entire coating shall be from .008-inch to .012-inch thick. It shall have a

hardness of from 5 to 6 on the Mohs Scale, and a density of from 2.5 to 3.0 grams per cubic centimeter. The green glass lining shall be capable of withstanding a thermal shock of 350°F to corrosion by solutions between pH-3 and pH-10 at 125°F. There shall be no visible loss of surface glass on the glass lining after immersion of a normal production run sample in an 8 percent sulfuric acid solution at 148 degrees F for a period of ten (10) minutes. In addition, when tested according to ASTM Designation C283-54, it shall show a weight loss of not more than 3 milligrams per square inch.

- d. The glass lining shall be in accordance with the manufacturer's standard tolerances for coverage, continuity and gloss. Pin holes, crazing or fishscales, which substantially expose the metal substrate, shall be cause for rejection of the pieces.
  - e. Sizes, details, handling, stacking, etc. shall be in accordance with the manufacturer's recommendations.
  - f. No cutting or tapping of glass-lined pipe in the field shall be permitted.
11. Asphaltic exterior coating: All ductile iron pipe and fittings for buried service shall be given an asphaltic exterior coating. Coating shall be in accordance with ANSI A-21.51 for pipe and ANSI A-21.10/A-21.53 for fittings.
  12. Painting: Pipe exterior preparation and coating for interior and above grade pipe shall be in accordance with Specification Section 09900 – Painting.
  13. Pipe fittings with integrally cast bases shall be provided where indicated and as directed.
  14. All flanged joints for ductile iron pipe shall be made with bolts or bolt studs with a nut on each end and 1/8-inch thick neoprene gaskets extending at least to the inside of the bolts. Bolts and nuts shall be heavy unfinished hexagon head bolts and nuts of Grade B low-carbon steel. Bolt studs and nuts shall be of the same quality as machine bolts. Gaskets shall be Flange-Tyte® by US Pipe or equal.

#### B. Polyvinylchloride (PVC) Pipe and Fittings

1. PVC Pipe shall be manufactured by:
  - a. J.M. Eagle, Los Angeles California
  - b. United States Plastic Corp., Lima, OH
  - c. Charlotte Pipe and Foundry, Charlotte, NC
  - d. Approved equal
2. Three types of PVC pipe are specified on this project – Schedule 80 pipe for pressure service, SDR 21 pipe for pressure service, and SDR 35 pipe for gravity service.
3. Schedule 80 Pressure Pipe: Unplasticized polyvinylchloride pipe and fittings shall be Type 1, high chemical resistance, normal impact, Schedule 80 pipe made of virgin polyvinylchloride and conforming to ASTM D 1785. Pipe fittings shall be of the same material and shall be of the proper classification and wall thickness for use with Schedule 80 pipe. Joints in piping shall be solvent weld connections. A sufficient number of unions shall be provided to allow for convenient removal of piping. Connections to pipe of other materials, connections to equipment, and connections at

such other locations, as indicated or directed, shall be made with flanges. All flanges shall be 150-pound PVC pipe flanges and flanged connections shall be made using 1/16-inch thick neoprene rubber gaskets and type 316 stainless steel bolts and nuts. Flanges shall be faced and drilled to American 125 Standard and as required to match the facing and drilling of the flanges to which they are to be connected.

4. SDR 21 Pressure Pipe: Pipe shall conform to the requirements of ASTM D2241 for Class 200, SDR 21 pipe. Pipe shall be manufactured from clean, virgin, approved Class 12454-B compounds, conforming to ASTM D1784, with an established hydrostatic design minimum of 2,000 psi for water at 73 degrees. F. Pipe shall be furnished in maximum 20-foot laying lengths with integral bell joints formed so as to contain a rubber sealing gasket. Joints shall be Push-on bell and spigot conforming to the requirement of ASTM D3139. Fittings shall be push on joint, conforming to ASTM D3139. Fittings shall be of a pressure classification at least equal to that of the piping with which they are to be used.
    - a. SDR 21 PVC Pressure pipe shall conform to Specification Section 02627.
  5. SDR 35 Gravity Pipe: PVC pipe, couplings and fittings for gravity and sleeve service shall conform to ASTM D-3034 Type PSM with a SDR of 35.
    - a. SDR 35 PVC pipe shall conform to Specification Section 02622.
    - b. Joints for PVC pipe shall be push-on joints using permanently bonded elastomeric ring joints. Such joints shall be installed in accordance with the pipe manufacturer's written instructions. Any joint which is not properly made, shows signs of leakage or is, in the opinion of the Engineer, defective in any way shall be redone to the satisfaction of the Engineer.
    - c. Y-branches or tees utilized shall be of the same class and type as the pipe in which they are connected to.
- C. Copper Piping: Piping shall be of the thickness specified herein or as shown on the drawings, and shall be of the longest lengths commercially available.
1. Copper Pipe shall be manufactured by:
    - a. Mueller Streamline Co., Collierville, TN
    - b. Cambridge-Lee Industries, LLC, Reading PA
    - c. Approved Equal
  2. Copper tubing for city water and plant water shall be ASTM B-88, Type K.
  3. Copper pipe shall conform to ASTM B-42.
  4. Fittings shall be cast bronze for copper pipe and cast bronze or copper stream-lined fittings for copper tubing conforming to ASTM B-30 UNS Alloy No. C83800.
  5. Unions shall be bronze with ground joints and shall be semi-finished.
  6. Joints for copper fittings shall be made with solder composed of 95 percent tin and five percent antimony.
  7. For copper tubing, Type K shall be used for underground services; Type L shall be used for above ground interior services.



D. Fiberglass Reinforced Plastic (FRP)

1. FRP Pipe shall be manufactured by:
  - a. Perry Fiberglass Products, Elyria, OH
  - b. Fibrex, Victoria, TX
  - c. Approved equal
2. Pipe shall conform to ASTM D2996 and ASTM D4024. Pipe shall be suitable for industrial air service.
3. The pipe shall be manufactured by the filament winding process using an amine cured epoxy thermosetting resin to impregnate strands of continuous glass filaments, which are wound around a mandrel at a 35.25° helix (54.75° winding) angle under controlled tension. Pipe shall be heat cured and the cure shall be confirmed using a Differential Scanning Calorimeter. Pipe shall have a resin-rich corrosion barrier reinforced with surfacing veil. The corrosion barrier shall have minimum resin content of 80%. The minimum acceptable cured thickness of the corrosion barrier shall be as follows:

1" to 1-1/2" pipe	15 mil nominal
2" to 4" pipe	30 mil nominal
6" to 16" pipe	35 mil nominal

4. Pipe shall be supplied with a matching tapered coupling and a matching tapered spigot. Pipe shall have a minimum continuous cyclic pressure rating of 150 psig at 225 degrees F in accordance with ASTM D2992 Procedure A.
5. All fittings shall be manufactured using the same type materials as the pipe. Fittings may be manufactured either by compression molding or spray-up/contact molding methods. Fittings shall be adhesive bonded matched tapered bell and spigot, or flanged. Flanges shall have ANSI B16.5 Class 150 bolt hole patterns. Bonding adhesive shall be manufacturer's standard for the pipe specified.
6. Gaskets shall be 1/8" thick, 60-70 durometer full-face type suitable for the service specified as recommended in the manufacturer's standard installation procedures. Bolts, nuts and washers shall be type 316 stainless steel.
7. Pipe shall be Green Thread, by Smith Fiberglass Company, or equal.

E. High Density Polyethylene (HDPE)

1. HDPE Pipe shall be manufactured by:
  - a. Chevron Phillips Chemical Co., The Woodlands, TX;
  - b. ISCO Industries, Louisville, KY, or
  - c. Approved equal.
2. HDPE pipe for biofilter air service shall be SDR 17, and for liquid service (lime slurry, etc.) shall be SDR 17, unless otherwise noted or approved.
3. Pipes shall conform to Specification Section 02620 – HDPE pipe for buried service.

F. PVC/FRP Dual Laminate Pipe

1. PVC/FRP Pipe shall be manufactured by:
  - a. RPS Composites, Inc.; Mobile, AL
  - b. Approved Equal

2. PVC/FRP Pipe for foam spray service shall be dual laminate, seamless PVC liner with bonded fiberglass reinforced vinyl ester structure.
3. Pipe shall be rated for 150 psi and have a 20' standard length.
4. Fittings shall be flanged and drilled for Class 150 dimensions. Gasket materials shall be suitable for intended service conditions.
5. Pipe assembly shall be by welding by solvent, hot plate, or hot gas welding.

G. Stainless Steel Pipe

1. See Specification Section 15066

## 2.03 PIPE HANGERS AND SUPPORTS

- A. See Specification Section 15060

## 2.04 MECHANICAL JOINT RESTRAINTS

- A. Restraint devices for nominal pipe sizes 3 inch through 54 inch shall consist of multiple gripping wedges incorporated into a follower gland meeting the applicable requirements of ANSI/AWWA C110/A21.10. Restraints shall be Megalug by EBAA Iron or equal.
- B. The devices shall have a working pressure rating of 350 psi for 3-16 inch, 250 psi for 18-48 inch and 200 psi for the 54 inch size. Ratings are for water pressure and must include a minimum safety factor of 2 to 1 in all sizes.
- C. Gland body, wedges and wedge actuating components shall be cast from grade 65-45-12 ductile iron material in accordance with ASTM A536.
- D. Ductile iron gripping wedges shall be heat treated within a range of 370 to 470 BHN.

## 2.05 SHOP PAINTING

- A. Carbon steel, forged steel or ductile iron flanges and pipe support components shall be shop and finish coated.

## 2.06 WALL SLEEVES

- A. Wall sleeves shall be provided for all pipes passing through reinforced concrete structures, floors, walls, and brick or concrete masonry unit walls, except manholes. Wall sleeves shall be cast iron or HDPE. The Contractor shall be responsible for having wall sleeves readily available and tightly secured in the formwork at time of concrete placement.
- B. Cast iron wall sleeves shall be standard type, Class 250 with integrally cast wall flange. The wall sleeves shall be of the dimensions required and as directed with ends flush with both faces of the wall and for proper fitting of the carrying pipe

through wall sleeve with suitable annular space. Cast iron wall sleeves shall be of approved type, dimension and wall thicknesses.

- C. HDPE wall sleeves shall have integral water stop collars and end caps that hold the sleeve's circular configuration during concrete pours. Sleeves shall be molded with textured exteriors for concrete bonding. HDPE wall sleeves shall be Century-Line® Engineered Sleeves by Thunderline and shall be engineered to mate with Link-Seal® modular mechanical seals.
- D. The annular space created by the wall sleeve and the pipe shall be positively sealed with Link-Seal manufactured by Thunderline Corporation or an approved equal. Seals shall be the modular mechanical type, consisting of interlocking synthetic rubber links shaped to continuously fill the annular space between the pipe and wall opening. Links shall be loosely assembled with bolts to form a continuous rubber belt around the pipe with a pressure plate under each bolt head and nut. After the seal assemblies positioned in the sleeve, tightening of the bolts shall cause the rubber sealing elements to expand and provide an absolutely watertight seal between the pipe and wall opening. The seal shall be constructed so as to provide electrical insulation between the pipe and wall, thus reducing chances of cathodic reaction between these two members. All wall sleeves of which any portion is 25 feet or more below finished grade or where the wall sleeve penetrates a wall between a tank and an interior room shall have link seals on both the interior and exterior faces of the wall. All wall sleeves above this elevation shall have link seals on the interior wall only.
- E. The Contractor shall determine the required inside diameter of each individual wall opening or sleeve before ordering, fabricating or installing the seals. The inside diameter of each wall opening shall be sized as recommended by the manufacturer to fit the pipe and Link-Seal to assure a watertight joint.
- F. The Contractor shall familiarize himself with the installation of the seals through the manufacturers instruction bulletin that illustrates the proper procedure for installing and tightening the seal to provide a watertight pipe penetration.
- G. Wall and/or floor sleeves with closure for which the above sleeves are not suited as described shall be made by means of a sleeve capable of being bolted directly to the formwork to prevent misalignment. Seal of the annular space between the carrier pipe and the sleeve shall be by means of a confined rubber gasket and capable of withstanding 350 psi. Sleeve shall be manufactured from Ductile Iron with an integrally cast water-stop of 1/2" minimum thickness and 2-1/2" minimum height. Mechanical joint gaskets shall be EPDM. Wall sleeves shall be Omni Sleeve, Malden, MA or approved equal.

## 2.07 FLEXIBLE MECHANICAL PIPE COUPLINGS

- A. Flexible mechanical cast iron pipe couplings for joining of plain ends of ductile iron pipe shall be suitable for a 200 psi water working pressure and shall be of the proper

size and suitable for use on the piping on which it is installed. Couplings shall be of cast iron construction and shall be provided with middle ring not less than 5-inches in length, galvanized bolts and nuts with rolled threads, "Grade 42" molded rubber gaskets, follower rings and accessories as required for the complete installation. Where indicated, the coupling shall be provided with not less than four tie rods extended from flange connections on each side of the couplings. Thickness of middle rings shall be as approved. Follower rings shall be amply proportioned to take, without deformation, the strains imposed on the coupling by the installation. The ends of the pipes shall be prepared and the couplings installed in accordance with the printed recommendations of the manufacturer of the couplings, and the Contractor shall be responsible for verifying dimensions of piping materials necessary to insure the proper fabrication, installation and fitting of the contract work.

- B. Flexible non-metallic couplings for joining flanged ductile iron pipe at equipment shall be suitable for a 200 psi water working pressure and shall be of the proper size and suitable for use on the piping on which it is installed. Couplings shall be of EPDM construction and shall be provided with type 316 stainless steel retaining rings. Where indicated, the coupling shall be provided with not less than four tie rods extended from flange connections on each side of the couplings. Couplings shall be Redflex Type J-1W, Wide Arch Expansion Joints or equal.

## 2.08 FILLER RINGS

- A. Filler rings of the same materials, facing and drilling as the flanges they are used with shall be provided in flanged piping where necessary and approved for the proper fitting and layout of the piping.

## 2.09 TAPPED CONNECTIONS

- A. Tapped connections in pipe and fittings shall be made in such manner as to provide a watertight joint and adequate strength against pullout. The maximum size of taps in pipe or fittings without bosses shall not exceed that listed in the appropriate table of the Appendix to the ANSI A 21.51 based on three full threads for ductile iron.
- B. Where the size of the connection exceeds that given above for the pipe in question, a boss shall be provided on the pipe barrel, the tap shall be made in the flat part of the intersection of the run and branch of tee or cross, or the connection shall be made by means of a tapped tee, branch fitting and tapped plug or reducing flange, or tapping tee and tapping valve, all as indicated or approved.
- C. All drilling and tapping of ductile iron pipe shall be done normal to the longitudinal axis of the pipe; fittings shall be drilled and tapped similarly, as appropriate. Drilling and tapping shall be done only by skilled mechanics. Tools shall be adapted to the work and in good condition so as to produce good, clean cut threads of the correct size, pitch, and taper.

- D. Tapping is not allowed for glass-lined pipe. All taps for glass-lined pipe shall be done at a tapped flange, filler flange or unlined spool piece that can be readily removed for maintenance.

2.10 VALVES. Valves fitted with extension stems or valve boxes shall be NRS type. All other valves shall be O.S.& Y type except where space limitations require a NRS type valve. NRS valves shall be used as directed by the Engineer where limited space is a controlling criteria. All valves shall open when turned left unless specified otherwise.

A. Gate Valves (Process Lines)

1. Valve Construction. Gate valves shall be made in accordance with AWWA Specification C-500. Gate valves shall be iron body, bronze trim, solid wedge with tapered seat or double revolving disc, parallel seat construction. If of the parallel seat type, the discs and wedges shall be free of pockets and rib. The valves shall be designed for 125 psi working pressure. Interior gate valves shall be O.S. & Y. except where N.R.S. is called for, and have a packing seal. Interior valves shall be flanged unless otherwise shown on the drawings. Flanges shall be drilled to the ANSI 125/150 pound standard. Exterior gate valves shall have O-ring seals and mechanical joints.
2. Manual Actuators. Interior gate valves shall be hand-wheel operated with extension stems or chain operators as required. Exterior gate valves shall be operated by a two-inch operating nut set 18-inches below finished grade when buried. Valve boxes and extension stems shall be as specified hereinafter. Means of actuation shall be by lever, gear actuator, tee wrench, extension stem, motorized actuator, and the like, as specified or as shown on the drawings.
3. All valves larger than twelve inches shall be equipped with gear actuators. The actuator gear box shall be of totally enclosed oil or grease bath lubricated type, suitable for operation at any angle and provided with the appropriate filling and drain plugs. All shaft bearings shall be furnished with permanently lubricated bronze bearing bushings. Actuator shall clearly indicate valve position and an adjustable stop shall be provided. Construction of actuator housing shall be semi-steel. All exposed nuts, bolts, and washers shall be zinc plated. All valve actuators shall be as recommended by the valve manufacturer. Chain operators shall be used on all valves located six feet or more above the finished floor. Chain wheels and chains shall be provided by the valve manufacturer to operate the particular valve. All exterior valves shall be equipped with the specified actuator and shall be suitable for buried service.

B. Gate Valves (Potable Water Lines)

1. Gate valves shall be manufactured in full compliance with the content and

intent of the specification. Gate valves shall be cast iron body, bronze mounted, double disc, parallel seat, O-ring type stuffing box with double Buna O-rings and non-rising stem. Valves shall have a two-inch operating nut or hand-wheel as required for the particular application and as shown on the drawings. Gate valves shall conform in every respect to AWWA.

2. All exterior and interior gate valves shall be designed for a minimum of 150 psi working pressure. Exterior valves shall have mechanical joints and shall be bituminous coated. Exterior gate valves shall be operated by a two inch operating nut set 18 inches below finished grade when buried and have an extension stem or chain operator as required when in structures. Chain operators shall be as specified. Valve boxes and extension stems shall be as specified hereinafter.

C. Gate Valves (2" and smaller)

1. Gate valves shall be 125 pound bronze with solid wedge, screwed-in bonnet, inside screw, non-rising stem, and screwed ends.

D. Check Valves

1. Check valves larger than two inches shall be of swing design and with iron bodies. Valves shall have bronze faced cast iron disc plate suspended at the top from a stainless steel shaft. Valve shaft shall be supported by bronze bushings and bearings and shall be packed through externally accessible stuffing box. Disc shall seat against resilient seat installed in the valve body. Valve closure shall be assured by means of outside lever and weight.
2. The valves shall be compatible with 125 pound ANSI drilled flange. Valves shall be cleaned and shop primed on the outside with a rust inhibitive priming system. All check valves shall be horizontally mounted.
3. Check Valves. (Two inches and smaller). Check valves shall be 300 pounds bronze curving design with screwed-in bonnet, regrinding bronze disc, and screwed ends. Disc shall be suspended at the top with a stainless steel shaft. All check valves shall be horizontally mounted.

E. Elastomeric "Duckbill" Check Valves

1. The valve body shall be all rubber and the flow operated check type with an integral upstream flange. The entire valve shall be ply reinforced throughout the flange, body, saddle and bill, which is cured and vulcanized into a one-piece unibody construction. A separate valve body or pipe used as the housing is not acceptable. The valve shall be manufactured with no metal, mechanical hinges or fasteners, which would be used to secure any component of the valve to a valve housing. The entire valve with the exception to the flange shall fit within the pipe inside diameter.
2. The port area of the saddle shall contour into a circumferential sealing area

(the “bill”) that is concentric with the pipe which shall allow passage of flow in one direction while preventing reverse flow.

3. The saddle area of the valve must be flat, not conical, and integral with the rubber body above centerline in order to not produce any areas or voids that can collect or trap debris.
4. The valve shall incorporate multiple concave grooves molded integrally into the flat saddle wall thickness extending longitudinally a minimum of 80% of the length of the saddle to reduce opening resistance and reduce headloss.
5. The flanges shall be drilled to mate with ANSI B16.1, Class 125/ ANSI B16.5 Class 150 flanges. If the valve will not be installed between two mating flanges, the valve shall be furnished with one set of stainless steel 304 backing rings conforming to the same flange dimensions and drilling pattern as the valve flange.
3. Manufacturer must have available flow test data from an accredited hydraulics laboratory to confirm pressure drop data. Company name and location shall be cast onto the valve body. Valves are to be manufactured in the USA.
4. When line pressure inside the valve exceeds the backpressure outside the valve by a certain amount, the line pressure forces the bills of the valve open, allowing flow to pass. When back pressure exceeds the line pressure by at the same amount, the bills of the valve are forced closed.
5. All elastomeric “duckbill” check valves shall be Upstream Flanged CheckMate Ultraflex Valves as manufactured by Tideflex Technologies®, a division of Red Valve Co., of Carnegie, PA, or approved equal.

#### F. Plug Valves

1. Valves shall be of the non-lubricated, resilient seated, quarter-turn type furnished with flanged or mechanical joint end connections as required. Flanged valves shall have flanges in full compliance to ANSI B 16.1 Class 125 Standards, including facing, drilling and thickness. Face to face dimensions of flanged valves through 12" size shall be that of standard gate valves. Mechanical joint ends shall be in full conformance to ANSI Standard A21.11.
2. Port areas for all valves shall be at least 80% of full pipe area.
3. Valve bodies shall be of ASTM A-126 Class B, cast iron. Plugs shall be ductile iron (ASTM A-536, Grade 65-45-12) with upper and lower shafts internal. The valves must provide bidirectional sealing at 175 psi differential in sizes to 12" and 150 psi differential for sizes 14" and larger. Proof of design and cycle life testing shall be in full conformance to AWWA Standard C504-80. Valve seating shall provide a consistent opening/closing torque

that is not dependent on adjustment of stop. Resilient seating shall be field replaceable on the existing plug.

4. All surfaces are to be protected, both internally and externally, with a factory coated heat fused thermoset epoxy or thermoplastic nylon complying fully with AWWA Standard C-550-81. These fusion-bonded coatings shall provide protection from corrosion in the shaft areas. Bearing areas to be isolated from solid particulates. All valves shall be of the bolted bonnet, top entry design, capable of repacking without removing the bonnet or valve from the pipe line.
5. Valves larger than eight inches and valves located seven feet or more above the finished floor shall be provided with manual gear operators having a maximum rim pull of 80 pounds as per AWWA C-504. Gear operators shall be enclosed and provided with seals on all shafts to prevent entry of water, allow submerging of the operator and suitable for running the gears in oil. All shaft bearings shall be furnished with permanently lubricated bronze bearing bushings. Adjustable stops shall be provided.
6. Actuators for gear operated valves shall be by handwheel if within six feet of the finished floor, and in accessible areas valves above six feet from the finish floor shall be operated by a chain operator and chain wheel provided by the valve manufacturer to operate that particular valve.
7. Actuators for valves eight inches and smaller located within six feet of the finished floor in accessible locations shall be by a portable lever. One portable level shall be provided for 50 percent of the valves or 15 portable levers whichever is less.
8. Actuators for valves in inaccessible locations shall be by extension stem, stem guides, 2-inch operating nut with mounting bracket or floorbox, or floor stand, and lever or handwheel as appropriate. The plug valve manufacturer shall provide all operator accessories as required to make each operator system completely operational. Design criteria for extension stems and stem guides shall be as specified under the section title -Miscellaneous Metal Work.
9. Valve actuators for buried or submerged service shall have seals on all shafts and gaskets on the valve and actuator covers to prevent the entry of water. Actuator mounting brackets for buried or submerged service shall be totally enclosed and shall have gasket seals. All exposed nuts, bolts, springs and washers used in buried service shall be stainless steel.
10. Three-way plug valves shall be tapered design with resilient (EPT) coated plug, cast in semi-steel. Port opening shall be a minimum of 95 percent of pipe area. Shut off shall be dead-tight. Interior of valve body shall have a minimum 0.005-inch epoxy coating. Flanges shall conform to ANSI 125 pound standard. Valves shall have upper and lower stainless steel bushings and an adjustable gland to control turning torque. Other features as specified herein for plug valves shall apply except that three-way valves six inches and



larger shall be provided with gear operators. Unless otherwise shown on the drawings, three way plug valves shall be three port, three position, 180-degree turn design. Valves shall be as manufactured by Drum Owen Valve Company (Homestead), Bethlehem, PA, Style H, DeZurik, or equal.

#### H. Motor Operators

1. Motor operators shall be provided for plug valves as shown on the drawings. Operators shall be as manufactured by Flowserve-Limitorque, Rotork, Inc., or equal. It shall be the motor operator manufacturer's responsibility to mount and test the valve and actuator assembly to insure proper operation.
2. Motor operators shall be provided with a hand wheel for manual override and shall be provided with automatic electrical disengagement of the motor and automatic brake release when in the manual mode. Handwheel shall not turn when under electric operation and shall be of sufficient size as to require no greater than a 60-pound total rim effort. Handwheel shall be provided with an integral cutoff switch during manual operation.
3. Motor operator shall be designed to be removable from the valve without dismantling the valve and shall be provided with the following features:
  - a. Motor brake.
  - b. Heater with thermostat.
  - c. Limit switches. One switch shall be open and the second switch closed when the valve is fully open. When used with three-way valves, switches shall be used to indicate which outlet is open and which is closed.
  - d. NEMA 4X enclosure.
  - e. Operators shall operate on a 120 volt, single phase, 60 Hz, power supply up to 1/3 HP, and 480 volt, three phase, 60 Hz on greater than 1/3 HP.
  - f. Motor operator shall be capable of holding any valve position.
  - g. Motor operator controller shall be furnished with reversing motor starter, control power transformer, manual/automatic and open/stop/close manual controls, open and close indicator lights and torque switches.
  - h. Valve controllers shall be suitable for remote control and status via the facility I&C system.
4. Motor operator shall be provided with shaft seals and shall be totally enclosed and require no additional lubrication. Bearings shall be ball or roller type suitable for all loads encountered in the service conditions. Motor operator shall incorporate machine cut and hardened gears and shall have a bolting pattern to allow parallel or perpendicular mounting.
5. Motor operator shall produce the torques and speeds as listed below:

<u>Size (Inches)</u>	<u>Minimum Torque (Inch-Pounds)</u>	<u>Fastest Operating Speeds (Seconds)</u>
3	3,200	10
4	3,200	10
6	10,000	26
8	10,000	26
10	21,000	55
12	21,000	55
14	48,000	125
16	48,000	125

NOTE: It is the responsibility of the equipment supplier to verify minimum torques and fastest operating speeds for the motor operators supplied.

#### H. Knife Valves

1. Valves shall be of the bonnetless knife type with wafer face-to-face flanged connections. Flanges shall be drilled to the ANSI 125/150 pound standard. WOG valve rating shall be 150 psi in sizes two inches through 24 inches and 125 psi in sizes 30 inches and 36 inches.
2. Valves shall be metal seated and lapped. Metal seated valves shall have a round port. Valves bodies shall have wetted parts of Type 304 stainless steel.
3. Valve packing shall be multiple layers of square, braided flax and shall be impregnated with marine or petroleum base lubricants. The packing gland shall be plastic coated. The gate shall have a knife edge. Both sides of the gate shall be finish ground. The stem shall be stainless steel. Valve superstructure shall be fabricated or hot rolled angular steel.
4. Valves two inches through 24 inches shall have a raised face seat with relieved area around the seat to prevent jamming.
5. Unless otherwise shown or specified, stem shall have double pitch threads and be equipped with two to one ratio gear operators with handwheels, which shall provide adequate clearance. Valves shall be by DeZurik or equal.

#### I. Air Flow Control Valves

1. Air flow control valves on the drop legs into the biological treatment process shall be motor operated butterfly valves. Valves will be of the resilient seated type, with EPDM seats and seals rated for 250 degrees F. Each valve shall have a cast iron wafer style body, 316 SS discs and stainless steel shafts. Valves shall be rated for a minimum pressure of 150 psi. Sizes shall be as shown on the Contract Drawings. Valves shall be manufactured by Dezurik, Emerson-Keystone or approved equal.

2. Air Flow Control Valves shall be modulated via a motorized electric actuator powered from a 110V, single phase 60 Hz control signals from the Master Blower Control Panel (dissolved oxygen control) provided by the blower manufacturer. The actuator shall be equipped with a motor brake. The Contractor shall coordinate the installation and control of the valves with the Blower Manufacturer and the Instrumentation and Control System integrator.

Each actuator will include two sets of SPDT maximum and minimum position limit switches. Switches shall be independently adjustable for indication and travel limits. Valve movement shall be accomplished by applying power directly to the motor operator based on readings of the controlled process variable. Valve actuation time shall be 60 seconds for 90 degrees travel. The valve actuators shall provide discrete valve position commands (open and close) and a 4-20 mA position feedback. The actuators shall be capable of holding any position. Actuators shall be located in NEMA 4X enclosures. The valve actuators shall have Local/Remote selector switches with Open/Stop/Close pushbuttons. Actuators shall be equipped with a manual override valve position indicator. Actuators shall be manufactured by Rotork, Flowserve-Limitorque or equal.

#### J. Isolation Butterfly Valves

1. Isolation butterfly valves in air piping shall have cast iron, wafer-type bodies, as specified under ASTM A-126, Class B. Valves will be of the resilient seated type with a 316 SS disc and shaft, EPDM seats and seals rated for 250 degrees F. Valves shall be rated for a minimum pressure of 150 psi. Sizes shall be as shown on the Contract Drawings. Valves shall be manufactured by Dezurik, Emerson-Keystone or approved equal. Valve shall be of the lug body type for use between 125/150 ANSI flanges. Valves shall be by DeZurik, Emerson-Keystone or equal.
  - a. Isolation valves for the aeration headers shall be equipped with lockable manual lever operators that provide automatic, positive latching in the open, closed and at least eight intermediate positions. No position switch for this application.
  - b. Isolation valves for the main aeration blowers (within the blower building) shall be equipped with chain wheel actuators with sufficient chain to be operated from the blower building floor. The valve actuators shall be equipped with limit switches to provide valve position feedback. Actuators shall be C Series by Rotork or approved equal.

#### K. Solenoid Valves

1. Valves shall be direct acting packless two-way solenoid valves for water service. Valves shall be normally closed, unless otherwise shown suitable for operation with 120 volt, 60 Hertz power and have continuous duty Class A insulation and general purpose enclosure. Valve body shall be forged brass with safe body working pressure of at least 250 psi, NPT connections, with

Buna-N seat, wetted parts shall be of stainless steel. Valves shall operate satisfactorily when mounted in any position. Valves shall be by ASCO or equal.

L. Globe Valves

1. Valves shall have bronze body and fittings and shall be hand-wheel operated. Discs shall be bronze and renewable type. Valves shall be designed for 150 psi working pressure and shall have threaded connections unless otherwise specified. Valves shall be by Powell, Stockham or equal.

M. Ball Valves

1. Ball Valves shall be of Type 316 stainless steel construction, except for those valves specified PVC construction or installed in PVC piping. Body shall be of rigid construction and symmetrically cast. The shaft and ball shall be integrally cast.
2. Seats and seals shall be Teflon and shall be recessed in a machined groove. Shaft packing shall be a braided band. Packing shall be tightened by means of a gland bearing strip. Replacement of the packing shall be accomplished without removing the actuator.
3. Ball shall have a straight-through passageway, and shall be of the full-port design. Valves shall be rated for 150-psi service. Valves shall be by Apollo or equal.

N. PVC Valves

2. Polyvinylchloride (PVC) valves shall be manufactured of the same PVC Type 1 Grade 1 molding compound used for the fittings to assure proper compatibility of system components.
3. Ball valves and ball check valves for PVC pipelines shall be true union PVC valves. Valve design shall allow for entire valve body removal by turning back the union nut at both ends of the valve. Valves shall have Teflon seats and packing. Valves shall carry a pressure rating of 150 psi at 75 degrees F water.
4. Diaphragm Valves. Valves shall be constructed of PVC, except diaphragm, including bonnet and handwheel. Diaphragm shall be replaceable and fully supported in any position. Valve shall have a non-rising stem with a diaphragm position indicator. Diaphragm shall be constructed of Teflon and shall be replaceable without removing valve from the line. Valve shall be socket ends. Valves shall be by Nibco or equal.

O. V-Port Ball Valves

1. Valves shall have a stainless steel, segmented, v-port ball with hard chrome facing. The body shall be cast carbon steel, ASTM A216, Grade WCB. Valves shall have integrally cast flanges for ANSI class 150 service. Shafts shall be type 316 stainless steel with splined ball-to-shaft connections and positive blow-out protection. Bearings shall be reinforced PTFE. Seats shall be reinforced PTFE meeting ANSI leakage classification VI. Adjustable packing shall be PTFE Chevron. Operation shall be manual by handwheel or

chainwheel operators. Valves shall be DeZurik Type VPB or equal.

P. Pressure Reducing Valves. (Larger than two inch)

1. Valves shall be flanged globe body, bronze mounted, external pilot operated with a free floating piston and shall operate without springs, diaphragms or levers. The valve shall have a single seat with the seat bore equal to the size of the valve. Piston travel shall be a minimum of 25 percent of the seat diameter. The piston shall be guided above and below the seat no less than a length equal to 75 percent of the seat diameter. The piston shall be cushioned and designed to insure positive closure.
2. The valve shall be packed with leather and shall be furnished with an indicator rod to show the piston position. Gauge petcocks shall be furnished on the valve body. The pilot valve shall be easily accessible and shall be removable from the main valve under pressure. The pilot valve shall be adjustable without special tools or the removal of springs or weights. The main valve shall be designed to facilitate repairs internally without removing the valve from the line.
3. The valve shall be designed to maintain a preadjusted downstream pressure for varying rates of flow by piston positioning without water hammer.
4. The valve shall be suitable for 150 pound flanged service and shall conform to AWWA standards for flange thickness, drilling and the wall thickness of the body and caps. The valve body shall be constructed of grey iron, free from cold shuts and defects and having a minimum tensile strength of 35,000 psi.
5. The valve shall be hydrostatically tested at a minimum of two times the rated service pressure. All iron castings shall be coated on all surfaces with two coats of asphaltic base metal paint.

Q. Pressure Reducing Valves (two inches and smaller)

1. Pressure reducing valves two inches and smaller shall be of the single seated balanced design type globe body with threaded inlet and outlet ports. Valves shall be diaphragm operated, spring loaded, permitting convenient adjustment. The body shall be of bronze construction with stainless steel stem and furnished with a replaceable rubber seat. Valves shall be G-A Industries Figure 43-D, Watts No. 223, or equal.

R. Pressure Relief Valve

1. Pressure relief valve shall be cast iron frame and cover with a bronze body ring and rubber flap ring. Hinge pin shall be bronze and secured with cotter pins. Valve shall have two pivot points and shall have a flanged end. No leakage shall occur on a valve with at least 18 inches of water cover above the installed valve.

S. Air Release Valves

1. Air release valves shall allow for the admission or release of large quantities of air during the fillup or drainage of pipelines and shall be specially designed for use with raw sewage. The valve shall open when the operating pressure

falls below atmospheric pressure, and shall close and remain closed when the operating pressure is above atmospheric pressure.

2. Valves shall consist of a compact tubular all stainless steel fabricated body, HDPE hollow direct acting float, HDPE solid large orifice float, stainless steel nozzle and woven dirt inhibitor screen, nitrile rubber seals and natural rubber seat.
3. The valve shall have an integral anti-surge orifice mechanism which shall operate automatically to limit surge pressures rise or shock induced by closure to less than 2 times the valve rated working pressure. The intake orifice area shall be equal to the nominal size of the valve i.e., a 6" valve shall have a 6" intake orifice.
4. Large orifice sealing shall be by the flat face of the control float seating against a nitrile rubber O-ring housed in a dovetail groove circumferentially surrounding the orifice. The seating & unseating of a small orifice nozzle on a natural rubber seal affixed into the control float shall control discharge of pressurized air. The nozzle shall have a flat seating land surrounding the orifice so that damage to the rubber seal is prevented.
5. The valve construction shall be proportioned with regard to material strength characteristics, so that deformation, leaking or damage of any kind does not occur by submission to twice the designed working pressure.
6. Connection to the valve inlet shall be by flanged ends conforming ANSI B16.1 Class 125. Flanged ends shall be supplied with type 316 stainless steel screwed studs inserted for alignment to the specified standard. Provide type 316 stainless steel nuts and washers.
7. Air and vacuum valves shall be Series RGX by Vent-O-Mat©. Valves shall be sized as indicated on the Drawings.

T. Pinch Valves

1. Pinch valves shall be of the open body, full port design and shall be for service up to 75 psig. The valves shall be designed for a minimum of 50,000 cycles of operation. Valves shall incorporate a positive opening device to prevent collapsing under vacuum service. The manufacturer shall furnish certified test data of a bubble tight leakage test performance on each valve supplied.
2. Valves are to be of the full cast metal body, mechanical pinch type with flange joint ends on both the body and the sleeve trim. The valve shall have face-to-face dimensions of standard gate valves, in accordance with ANSI B16.10 up to 12" size. Sizes 14" and larger shall have a face to face dimension no longer than twice the nominal valve port diameter. The flanges shall be drilled to mate with ANSI B16.1, Class 125/ANSI B16.5, Class 150 flanges. The valve body halves are to be sealed with an elastomer sheet gasket cut to fit the contour of the valve body. Body shall be epoxy coated for additional corrosion protection.
3. The sleeve trim shall be one piece construction with integral flanges drilled to be retained by the flange bolts. The sleeve trim shall be reinforced with calendared nylon or calendared polyester fabric to match service conditions. The sleeve trim shall be connected to the pinch bar by tabs imbedded in the

sleeve trim reinforcing ply. All internal valve metal parts are to be completely isolated from the process fluid by the sleeve trim.

4. For full port and reduced port sleeves, the port areas shall be 100% of the full pipe area at the valve ends. For cone and variable orifice sleeves the inlet port area shall be 100% of the full pipe area, reducing to a smaller port at the outlet.
5. The steel mechanism shall be double acting with pinching of the sleeve trim occurring equally from two sides. ACME threads shall be used on all valve mechanisms. There shall be no cast parts in the operating mechanism.
6. For buried valve service, a torque tube shall be fitted to the body of the valve via a mounting plate. The tube shall extend from the valve to above grade level, providing protection for the operating stem and sealing the opening in the top body half. Valve shall be operated by turning a non-rising stem, contained within the torque tube, and connected to the pinch mechanism. Bevel gear operators shall be provided on all valves over 8" size, and on smaller sizes as specified on the purchase order. Torque tube shall be epoxy coated for additional corrosion protection. Valves shall be manufactured in the USA.
7. Rotating the handle clockwise, simultaneously lowers a pinch bar above the sleeve and raises a pinch bar below the sleeve, pinching the sleeve closed at the center of the valve. Turning the handle counter-clockwise separates the two pinch bars to open the valve.
8. Pinch valves shall be Series 75-B as manufactured by the Red Valve Co., Inc. of Carnegie, PA, or approved equal.

U. Vacuum Breakers

1. Vacuum breakers shall be provided as shown on the drawings. Breakers shall be series "VB" as manufactured by Past-o-matic Valves, Inc., Totowa, NJ, or equal. Breakers shall be of Type 1, Grade 1 construction with stainless steel fasteners and shall have a one inch NPT connection.

V. Sampling Valves

1. Sampling valves and fittings shall be provided on the discharge lines of pumps as shown on the Drawings. Valves shall be one inch stainless steel ball valves by Apollo or equal. The discharge side of each valve shall be provided with a 90 degree stainless steel elbow facing downward.

W. Floor Stands for Valves

1. Floor stands for valves shall be provided where shown on the drawings, and shall be the straight type design. The floor stands shall have a 15-inch long hand crank operator, and an operating reduction ratio of two to one. The floor stands shall be the rising stem type. The floor stands shall have a life nut, with Acme type threads, which shall engage an Acme threaded valve extension stem to raise or lower the valve. The threads and diameter of the lift nut shall be compatible with

threads and diameter of the associated valve extension stem. The two to one reduction shall be accomplished with steel or cast iron gears which shall be designed for smooth operation and shall be able to support the operating loads without undue stress. The lift nut shall be of bronze and shall be mounted with roller bearings, which shall properly support the upward and downward thrusts encountered when operating the valves. The pinion shaft shall be mounted with roller and/or needle bearings. Lubrication fittings shall be provided for all bearings. All gearing, bearings, shafts, and the lift nut shall be housed in a weatherproof cast iron housing. Nuts and bolts shall be rustproofed steel. Seals shall be provided on all shafts and on the lift nut, where required, to exclude dirt and moisture, and to prevent leakage of lubricant. Floor stands shall be provided with stainless anchor bolts for installation.

## 2.11 VALVE EXTENSION STEMS

- A. Valve extension stems shall be furnished as required and as shown on the drawings. Stems shall have a two-inch operating nut and a two-inch coupling for connection of the valves. Shaft lengths shall suit the particular installation. All exterior valves shall be provided with valve extension stems and valve boxes. All operating nuts shall be located 18 inches below finished grade.

## 2.12 VALVE BOXES

- A. Valve boxes shall be provided for buried valves. Valve boxes shall be cast iron, tar coated, sliding-type, adjustable together with a cast iron cover. For buried installations, bell end shall be sufficiently large to fit over the stuffing box of the gate valve.

## 2.13 VALVE TAGS

- A. NOT USED.

## 2.14 TAPPING SLEEVE AND VALVE

- A. Tapping sleeves and valves shall conform to the latest specifications adopted by the AWWA and be of the specific size to suit the existing conditions.
- B. The tapping sleeves shall be mechanical joint, two part castings flanged on the vertical centerline, and come complete with all joint accessories. The surface area of each flange shall be thoroughly machined, and the sleeve flanges shall be fitted with lead gaskets. Each gasket shall cover the entire surface area of each joint for the full length of the sleeve. Bolts used to assemble the sleeves shall pass directly through each flange and through each gasket. This shall be properly spaced to insure uniform gasket pressure and compression.
- C. Sleeve outlets shall have counterbored flanges to insure proper centering of the



tapping valve.

- D. All tapping valves shall be mechanical joint. Tapping valves shall conform to the specifications for gate valves (Municipal water lines).

## 2.15 DUPLEX STRAINERS

- A. Strainers shall be manual duplex units with cast iron bodies and 125 lb flanged connections. Sizes shall be as indicated on the Drawings.
- B. Strainers shall have quick-opening, yoke type with Buna-N gaskets and elastomers. Bodies shall have NPT plugged drains. Strainer baskets shall be type 316 stainless steel with 1/8-inch perforations and bow-type handles. Flow diverters shall be tapered bronze valve plugs.
- C. Flow capacities shall be as indicated on the Drawings. Operating pressure drop shall not exceed 0.5 psig when measured with clean baskets and water.
- D. Strainers shall be standard Model #50 Series Manual Duplex Strainers by Hayward.

## 2.16 PRESSURE SENSORS AND GAUGES

- A. See Specification Section 15050 – Gauges.

## 2.17 CLEANOUTS

- A. Cleanouts shall be installed in the exterior piping at all bends in all sludge and scum lines and in other lines where shown on the drawings so as to allow clearing of the pipe(s) by rodding in either direction. Some bends therefore require two cleanouts. The four-inch riser pipe shown on the cleanout detail on the drawings shall be equipped with a bronze four-inch diameter cap. The dust cap shall connect to the flange adapter coupling without the use of threads. Two female quick disconnect coupling hose adapters shall be supplied for connection to hose. The hose adapter shall be four inches.

## 2.18 RESTRAINTS

- A. All valves and fittings shall be restrained, so that all thrusts shall be supported independent of the piping system. All restraints shall conform to pipe manufacturer's recommendation.
- B. For interior piping, restraints shall be located as follows:
  - 1. Anchors shall be placed so all forces will be balanced.
  - 2. Tiedowns shall be used to hold the pipe in position where velocity and surge

forces will cause pipe movement. They shall control stress due to thermal expansion at wall pipes, sleeves and equipment.

3. Guides shall be used to prevent transverse motion at flexible couplings used as expansion joints.
- C. Tie Rods: On piping, where flexible couplings are located near fittings or valves, stainless steel tie rods shall span the coupling from the two adjacent flanges. Such restraints can be deleted at the discretion of the Engineer, if both pipe ends are anchored in a concrete structure with no fitting or valve within the span. Where the Engineer intends to have flexible couplings used as expansion couplings, tie rods may be omitted. All tie rods shall be sized, spaced and installed according to the manufacturer's recommended procedure, or as directed by the Engineer.
- D. Thrust blocks shall be constructed at all exterior pipe fittings 22-1/2° and over, and valves, unless specifically ordered otherwise by the Engineer. The blocks shall be placed against undisturbed soil or against soil which has been compacted as specified in Division 2 for structures and pipes. Concrete used for thrust blocks shall be 3000 psi strength.

## 2.19 PIPE INSULATION

- A. The insulation for the pipe shall be a cellular glass type. It shall be a product which is made specifically for thermal insulation of underground piping and is compatible with the piping material.
1. Insulation shall be composed of all glass sealed cells having no binders or fillers. The completed product shall be rigid and impermeable. Its ultimate compressive strength shall be at least 100 psi. The thermal conductivity of the cellular glass shall be no higher than 0.40 BTU/sq ft/F°/in.
  2. The cellular glass thickness shall be 2-inches thick. It shall comply with all requirements of federal specification HH-1-551 and ASTM C552.
  3. Bands for securing the insulation to the pipe shall be 0.5 inches wide by 0.020 inches thick and shall be made of stainless steel.
  4. Jacketing for buried insulation shall be flexible laminate consisting of asphalt and glass fabric. The material shall be prefabricated so that it can be wrapped around the insulation and easily secured in place. This flexible insulation covering shall be flexible and tough enough to be wrapped tightly around the insulation and secured without tearing or cracking.
  5. Jacketing for above ground insulation shall be standard gauge aluminum jacketing with stainless steel bands.

## 2.20 CHEMICAL INJECTION ASSEMBLIES

- A. Provide chemical injection assemblies for points of chemical introduction into process pipelines as indicated on the Drawings. Assemblies shall be SAF-T-FLOW

chemical injection assemblies by Ryan Herco Products Corporation or equal.

- B. Assemblies shall consist of ¾-inch brass corporations with wetted parts of PVC, Hastelloy C and Viton, and suitable for the chemical service intended. Check valve balls and seats shall be Teflon. Connections to chemical feed tubing shall be ½-inch NPT.
- C. Assemblies shall have stainless steel safety chains to allow the closing of the corporation stop without withdrawing the solution tube beyond the corporation packing.
- D. Assemblies shall be rated for 240 gallons per hour of chemical feed flow at 150 psig working pressure.

## 2.21 FOAM SPRAY NOZZLES

- A. Nozzles shall be low pressure, standard spray, full-cone jet nozzles. Nozzles shall be high-grade, Type 316 stainless steel with removable caps and vanes. Nozzles shall have ½-inch NPT connections and 0.188-inch nominal orifice diameter and 0.125-inch maximum free passage diameter. Nozzle Capacity shall be 2.5 gpm per nozzle at 10 psi and 2.1 gpm at 7 psi. Horizontal spray distance at 10 psi shall be 12.5 feet, 14 feet and 15.5 feet at nozzle heights of 3 feet, 5 feet and 7 feet above the water surface elevation respectively. Spray cone width at the tank water surface shall be 10.5 feet minimum at 10 psi. Twenty (20) spare spray nozzles shall be provided. Nozzles shall be Model ½ GG-316SS FullJet by Spraying Systems Company.

## 2.22 IN-LINE STATIC MIXERS

- A. In-line static mixers shall be of a compact ring body design for mounting between two standard pipe flanges as sized on the Drawings. The ring body shall be a minimum thickness of 0.875 inches and shall be fabricated from Derakane FRP or Schedule 80 PVC.
- B. Ring-type neoprene gaskets shall be furnished and adhered to both sides of the mixer body. The mixer plate shall be designed to provide a geometric shape to create mixing vortices to effectively mix the injected chemicals with the process stream. The average variation in the process stream from the injection fluid shall be within 1 percent of the mean 10 pipe diameters downstream from the mixer.
- C. The mixing plate shall be no less than 0.125 inches thick and shall be Type 316 stainless steel. The mixer plate shall be mounted in a machined cavity on the upstream side of the ring body. The mixer body shall include two Type 316 stainless steel injection fittings as sized on the Drawings. Injection systems shall be designed for 100 psi working pressure. The in-line static mixers shall be Model 2800 by Westfall Manufacturing Company, Bristol, RI or approved equal.

## PART 3 - EXECUTION

### 3.01 GENERAL

- A. **Handling of Pipe.** The loading, hauling, unloading and handling of pipes and appurtenances shall be accomplished without damage to same. Dropping of pipe and appurtenances directly to the ground or floor will not be permitted. Suitable buffers or runners shall be provided. The Contractor shall be liable for any damage to the pipe or appurtenances until they are accepted in the completed work. Each pipe section shall be handled into its final position only in such a manner and by such means as the Engineer approves as satisfactory, and these operations will be restricted to those considered safe for the workmen and such as to cause no injury to the pipe or to any property. As far as practicable, the Contractor shall be required to furnish slings, straps, and/or approved devices to permit satisfactory support of the pipe when it is handled. Transportation from delivery areas to the trench shall be restricted to certain operations which can cause no injury to the pipe units.
- B. **Tools for Pipe Installation.** The Contractor shall furnish all tools, torque wrenches, materials and labor necessary to make the joints in pipe in strict accordance with the manufacturer's specifications. Proper and suitable tools and appliances for the safe and convenient handling and installation of pipes shall be used. The Contractor shall exercise reasonable precaution during his operation in order to avoid damaging the material. All pipes, fittings or appurtenances which are so damaged shall be replaced by him at his sole expenses.
- C. **Installation.** All materials and equipment shall be installed in a neat workmanlike manner, and as recommended by the manufacturer. All piping shall be installed true to line and grade and rigidly supported. Pipe shall be installed with a constant slope and with a straight alignment between structures and fittings. When pipes are laid in a trench suitable coupling holes shall be dug to provide ample space for making joints and to allow the pipe to have bedding along its entire barrel length. Before setting wall sleeves and pipes to be cast-in-place, the Contractor shall check all plans and figures which may have a direct bearing on his pipe location and he shall be responsible for the proper location of his pipes during the construction of the buildings. A minimum of two, 1/4 lengths of pipe shall be used to connect to any manhole, pull box, foundation, building, structure and the like. All interior piping shall have sufficient number of unions or their equivalent to allow convenient disassembly and removal of piping. All valves and appurtenances shall be installed in accordance with manufacturer's directions at locations shown on the drawings. All in-line devices provided under instrumentation shall be installed as part of the work of this section.
- D. **Cleaning and Plugging Pipe.** The pipes and fittings shall be thoroughly cleaned before being laid and shall be kept clean until accepted in the finished work. The ends of all uncompleted lines shall be tightly closed with temporary plugs at all times when pipe laying is not in progress, and no trench water shall be permitted to enter

the pipe.

- E. Trenching and Backfill. Trenching and backfill shall conform to the applicable provisions of the Earthwork Section of these Specifications. All pipes shall have a bedding of 3/4-inch stone from the face of the structure for a distance of ten feet or to undisturbed material.
  - F. Screwed Connections. All threads shall be clean, machine cut, and all pipe shall be reamed before erection. Screwed joints shall be made up with good quality thread compound applied to the male thread only. After having been set up, a joint must not be backed off unless the joint is completely broken, the threads cleaned and new compound applied. Teflon tape or Teflon compound may be used for steel, polyvinyl chloride, chlorinated polyvinyl chloride and copper threaded connections.
  - G. Arrangements. Except as otherwise required, changes in direction shall be made using proper fittings, and unless shown otherwise piping shall run parallel and at right angles to walls and floors. Systems shall be arranged with low points and drains to permit complete drainage of the system. Control piping may be arranged with unions or union connections at low points to permit draining. Unions or flanges shall be provided close to main pieces of equipment and in branch lines to permit ready dismantling of piping without disturbing main pipe lines or adjacent branch lines.
  - H. Penetrations. All penetrations in walls, floors and ceilings shall be sealed watertight to the satisfaction of the Engineer.
- 3.02 PLASTIC PIPING (PVC and CPVC). The installation of plastic pipe for pressure service shall be strictly in accordance with the manufacturer's technical data and printed instructions and as follows:
- A. General. The solvent welding procedure detailed herein applies to all Polyvinyl Chloride (PVC) and Chlorinated Polyvinyl Chloride (CPVC) pressure piping systems including molded fittings and socket type pump and valve connections.
  - B. Cement. Shall be a grade specifically recommended by the piping manufacturer for the size and schedule of pipe specified.
  - C. Pipe Preparation.
    - 1. Cutting. Pipe shall be cut in accordance with the recommendations of the pipe manufacturer.
    - 2. Deburring and Beveling. All burrs, chips, filings, and the like shall be removed from both the pipe inside diameter and outside diameter before joining. All pipe ends shall be beveled approximately 1/16-inch to 3/32-inch back from the edge at an angle of 10 to 15 degrees.

- D. Fitting Preparation. Prior to solvent welding, all fittings and couplings shall be removed from their cartons and exposed for at least one hour to the same temperature conditions as the pipe in order to assure that they are thermally balanced before joining.
- E. Cleaning. Pipe and fittings shall be clean of all loose dirt and moisture from the inside diameter and outside diameter of the pipe end and the inside diameter of the fitting. DO NOT ATTEMPT TO SOLVENT WELD WET SURFACES.
- F. Priming. Apply primer to the pipe approximately 1/2 of the pipe diameter and in accordance with the manufactures recommendations. Apply primer freely in the socket keeping surface wet and applicator wet and in motion 5 to 15 seconds. Avoid puddling in socket. For checking penetration, you should be able to scratch or scrape a few thousandths of the primed surfaces away. Repeated applications to either or both surfaces may be necessary. Weather conditions do affect priming action. In cold weather more time is required for proper penetration.
- G. Solvent Cement Application. Solvent cement application shall be in accordance with the manufactures recommendation with a minimum of two coats. All excess cement shall be cleaned from the surfaces of the pipe and fittings.
- H. Joining. Joining of PVC pipe and fitting shall be in accordance with the manufacturers recommendations and only at the below solvent welding joining temperatures and joint drying times:
  - 1. THE ACTUAL JOINING SHOULD NOT BE DONE IN ATMOSPHERIC TEMPERATURES BELOW 40°F OR ABOVE 90°F, OR WHEN EXPOSED TO DIRECT SUNLIGHT.
  - 2. NOT LESS THAN 48 HOURS OF JOINT DRYING TIME SHALL ELAPSE FOR ALL SIZES OF PIPE AND DRYING TEMPERATURES BEFORE THE JOINT IS MOVED OR SUBJECTED TO ANY APPRECIABLE INTERNAL OR EXTERNAL PRESSURE.

NOTE: Joints for plastic pipe shall be solvent welded except flanged or screwed where required. For plastic to steel, cast iron pipe or ductile iron pipe connections, complete metal pipe assembly first. Use flanged connections and tighten bolts evenly to prevent warping of rigid plastic pipe. A torque wrench may be used for a tight seal on gasket. Joints shall conform to manufacturer's recommendations installation of valves and fittings shall be strictly in accordance with manufacturer's instructions. In making solvent weld connections, the solvent should not be spilled on valves or allowed to run from joints. All completed pipe lines shall remain undisturbed for 48 hours to develop complete strength at all joints.

3.03 PVC PIPING. The installation of PVC pipe for sewers and conduits shall be strict accordance with the manufacturer's technical data and printed instructions.

- A. General. The pipe shall be laid with extreme care as to grade and alignment. Each pipe shall be so laid as to form a close joint with the next adjoining pipe and to bring the inverts continuously to the required grade. In order to insure a minimum amount of movement or disturbance, no more than two lengths of pipe may be laid before backfilling to a minimum of 12-inches over the pipe. Suitable coupling holes shall be dug to provide ample space for making joints and to allow the pipe to have bedding along its entire length. After laying each length to the line and grade shown, the trench shall be backfilled to the midpoint of the pipe and the trench compacted with special care taken to ensure that compacted material is placed under the haunches of the pipe. No walking upon or working over the pipes after it is laid will be permitted until it is covered with earth to a depth of at least 12-inches, except as may be necessary in tamping the earth and backfilling. All openings to the pipelines shall be satisfactorily protected to prevent the entrance of earth or water.
- B. Laying Pipe. Excavations shall be made to accommodate the bedding materials as previously specified. All excavations shall be kept dry while pipe is being laid and until each joint and pipe has been inspected by the Engineer and approval given to commence backfilling operations. Any pipe which is not laid to grade and alignment shall be relaid to the satisfaction of the Engineer. No blocking shall be used.
1. The pipe is set with a laser beam. The laser beam projector shall be rigidly mounted with two point suspension, to its support platforms. This will assure that all ground equipment vibrations will be kept to a minimum and permit the laser beam to project itself coaxially through the center of the pipe. All units shall have equipment to control atmosphere conditions in the pipe that could affect the acceptable standard of construction. The laser aligning method selected shall be shown to have worked satisfactorily on at least three contracts, and is operated by competent, trained personnel. The Contractor shall establish center line and offset stakes at each manhole, plus one intermediate center line and offset stakes as a check point between manholes.
- C. Allowable Pipe Deflection for PVC Pipe. Pipe installed under this specification shall have a maximum deflection of five percent at the time of testing. Such deflection is defined as the amount of vertical deformation (nominal inside diameter less the minimum vertical diameter when measured) multiplied by one hundred and divided by the nominal diameter of the pipe. Upon completion of a pipe section, including the placement and compaction of backfill, and the cleaning of the pipe, the Contractor shall measure the amount of deflection in all of the lines. This testing shall be done by the use of deflectometer, calibrated television or photography, or a properly sized "go, no go" mandrel or sewer ball. All lines with a deflection angle of greater than five percent shall be repaired by a re-bedding or replacement of the pipe.

### 3.04 LINES AND SLEEVES.

- A. Lines, hoses, pipes, etc., installed in sleeves, including but not limited to chlorine solution, alum and lime discharges, shall have no joints, couplings, or fittings

installed or located within the sleeve. All joints, couplings, and fittings shall be installed outside, in buildings, in pull boxes, or in manholes. The annular spaces between lines and sleeves at all structures shall be sealed watertight to the satisfaction of the Engineer.

### 3.05 FIRE HYDRANTS.

- A. Fire hydrants and appurtenances shall be installed in accordance with the local municipal fire codes, and in accordance with specification Section 02641.

### 3.06 TESTING OF PROCESS PIPING

- A. General. All piping and piping systems shall be leak tested by the Contractor in the presence of the Engineer. The Contractor shall provide typed and witnessed test reports for all such tests. One of two types of tests is required depending upon the service of the pipe. Exfiltration/Infiltration tests shall be performed on all gravity sewers and on low pressure rated lines (five psi or less). Pressure tests shall be performed on all pressure lines including siphons and piping with pressure rated joints. All piping and piping systems not complying with the leak test shall be repaired or replaced by the Contractor to the satisfaction of the Engineer and be re-tested all at no additional cost to the Owner.

- B. Exfiltration/Infiltration Test

- 1. After the completed line including service connections, if any, has been installed, the trench has been compacted to specification requirements, and manhole or joints showing noticeable streams or jets have been repaired and/or replaced the Contractor shall perform all exfiltration/infiltration tests. The Contractor shall be responsible for furnishing all labor, materials and equipment so that such tests can be accomplished at the times and locations necessary. The rate of infiltration/exfiltration shall not exceed 200 gallons per inch of pipe diameter per mile of pipe per day.

THE ATTENTION OF THE CONTRACTOR IS DIRECTED TO THE STRICT REQUIREMENTS RELATIVE TO MAXIMUM RATES OF INFILTRATION/EXFILTRATION AND TO THE IMPORTANCE OF THESE SPECIFICATIONS RELATIVE TO TIGHT JOINTS REQUIRED. LINES NOT MEETING THE ABOVE REQUIREMENTS SHALL BE REPAIRED AS NECESSARY AT THE CONTRACTOR'S EXPENSE.

- 2. Test Procedure

- a. When infiltration is observed the Contractor shall conduct V-notch weir infiltration tests. If such tests shown that the infiltration rate exceeds the limits specified above he shall make all necessary repairs



- to reduce the infiltration to the specified limit.
- b. When the V-notch weir tests as specified in Paragraph 1 above show that the rate is within the specified limits or when no infiltration has been observed an exfiltration test utilizing water or air shall be performed.

3. Exfiltration Tests

- a. Water tests shall be performed by filling the pipe with water to a point four feet above the top of the pipe at the upper end and measuring the water loss during a one hour period.
- b. For making low-pressure air tests, the Contractor shall use equipment specifically designed and manufactured for the purpose of testing sewer pipelines using low-pressure air. The equipment shall be provided with an air regulator valve of air safety valve so set that the internal air test using low-pressure air shall be made on each structure-to-structure section of pipeline. Pneumatic plugs shall have a sealing length equal to or greater than the diameter of the pipe to be tested. Pneumatic plugs shall resist internal test pressure without requiring external bracing or blocking. All air used shall pass through a single control panel. Low-pressure air shall be introduced into the sealed line until the internal air pressure reaches four psig greater than the maximum pressure exerted by groundwater that may be above the invert of the pipe at the time of the test. However, the internal air pressure in the sealed line shall not be allowed to exceed eight psig. At least two minutes shall be allowed for the air pressure to stabilize in the section under test. After the stabilization period, the low-pressure air supply hose shall be quickly disconnected from the control panel. The time required in minutes for the pressure in the section under test to decrease from 3.5 to 2.5 psig (greater than the maximum pressure exerted by groundwater that may be above the invert of the pipe) shall not be less than that shown in the following table:

<u>Pipe diameter in inches</u>	<u>Minutes</u>
6	4.0
8	5.0
10	6.5
12	7.5
14	9.0
15	9.5
18	11.5

- c. For larger diameter pipe: Minimum time = 7.7 X Dia. (ft). When the pipe section to be tested contains more than one size of pipe, the

minimum allowable time shall be based on the largest diameter pipe in the section.

C. Pressure Test

1. After the completed line including connections, if any, has been installed, the trench has been compacted to specification requirements and/or all supports and restraints have been installed, the Contractor shall perform all pressure tests. The Contractor shall be responsible for furnishing all labor, materials, and equipment so that such tests can be accomplished at the times and locations necessary.
2. All lines shall be pneumatically or hydrostatically tested for a period of two consecutive hours. The test pressure shall be that of the pipe design pressure or 1.5 times the apparent working pressure, whichever is the greater. The piping and piping system shall withstand the test pressure with a maximum loss of ten percent of the test pressure.

3.07 DISINFECTING AND FLUSHING

- A. The Contractor shall disinfect the lines carrying potable water.
- B. The Contractor shall furnish all equipment and materials necessary to do the work of disinfecting, and shall perform the work in accordance with the procedure outlined in the AWWA Standard for Disinfecting Water Mains, Designation C651-92, except as otherwise specified herein.
- C. The dosage shall be such as to produce not less than 10 parts per million after a contact period of not less than 24 hours.
- D. After treatment, the main shall be flushed with clean water until the residual chlorine content does not exceed 0.2 PPM.
- E. During the disinfection period, care shall be exercised to prevent contamination of water in existing mains.
- F. The Contractor shall dispose of the water used in disinfecting and flushing in an approved manner.
- G. If, in the opinion of the Engineer and/or owner, the above method of disinfection is deemed impractical; the lines carrying potable water shall be disinfected by the method outlined in AWWA Standard C651-92-Section 9.

3.08 PAINTING

- A. All piping shall be painted in accordance with specification Section 09900 – Painting.

3.09 CONTRACT CLOSEOUT

- A. Provide in accordance with Section 01700.

END OF SECTION

## **DIVISION 13**

## SECTION 13320

### INSTRUMENTATION

#### 1.0 PART 1 – GENERAL

#### 1.1 DESCRIPTION

- A. The Work of this Section shall include all labor, materials, and equipment required to provide instrumentation system as specified herein. A single Instrumentation System Supplier shall provide all labor, materials, equipment and services required to achieve this scope as specified herein and within the Contract Documents.
- B. The work shall include providing equipment and instrumentation for the Taunton Wastewater Treatment Facility Upgrade project in Taunton, MA.
- C. The work shall include an interface for equipment provided under other Sections of the Contract Documents. In order for the equipment furnished and installed within this Section to function as a complete system there shall be close coordination with other equipment furnished under other Sections of the Contract Documents.
- D. Provide and configure all new instrumentation and related equipment.

#### 1.2 SUBMITTALS

- A. Detailed submittal packages identifying the equipment to be supplied and its operation shall be furnished. The intent of the submittals is to ensure complete project scope coverage and does not relieve the Instrumentation System Supplier from fulfilling any specified requirements. The submittal shall consist of legible printed text and high quality prints bound in three-ring notebooks with index tabs that identify major sections of the document.
- B. Submittals shall include at least the following:
  - 1. Data sheets for each piece of equipment following ISA S20 format as applicable.
  - 2. Manufacturer's data, order sheet or equivalent for each individual instrument, control panel, or device being supplied. The information shall include but not be limited to model number, exact chart, scale or calibration range, type of enclosure and mounting, input/output and power data and the instrument tag number (or loop number for auxiliary equipment). Sales literature will not be accepted.
  - 3. The Instrumentation System Supplier shall clearly identify in the Project Plan any exception to the Contract Documents. Failure to do this will be grounds for rejection of the submittal.

- C. For approval before release for manufacturing
  - 1. All equipment to be provided under this Section must be approved prior to any of this equipment being released for manufacturing unless otherwise noted by the Engineer.
  
- D. Shop drawings shall be submitted in accordance with Section 01300 and include the following special conditions:
  - 1. All material submitted for review shall be contained in one submission. The material shall be furnished in bound volumes, not to exceed three inches thick, with cover sheet, description of project and table of contents as required for a complete submittal. Loose material submitted will not be reviewed. Partial submittals, unless agreed to by the Engineer, will not be reviewed. Sales bulletins or other general publications are not acceptable as submittals.
  
- E. Operation and Maintenance Manuals shall be submitted in accordance with the requirements of this Contract and include the following:
  - 1. Index.
  - 2. Complete directions on equipment supplied, including: physical description, installation, adjustments, configuration as installed, operation, technical information and servicing including parts list with stock numbers.
  - 3. All material that is to be furnished as part of the Operation and Maintenance Manuals shall be submitted in bound volumes with hard cover binders. Each bound volume shall be no more than three inches thick. This material shall be furnished complete in one submittal for review and final acceptance.

### 1.3 DEFINITIONS

- A. The following terms are understood to have the following meanings:
  - 1. “Furnish” shall mean purchase and deliver to the project site, complete with every necessary accessory and appurtenance.
  - 2. “Install” shall mean unload at the delivery point at the project site and perform all work necessary to establish proper location, secure mounting and specified operation in the project.
  - 3. “Provide” shall mean furnish and install.
  - 4. “Coordinate” shall mean all Work provided under this Section of the Contract Documents shall be in compliance with the Work of other referenced Divisions and other referenced Sections of the Contract Documents.

### 1.4 DESIGN CRITERIA

- A. The Contractor shall provide a complete and operational instrumentation system. This equipment shall be provided as described in this Section. It shall be the Contractor's responsibility to coordinate the installation of this equipment with all other associated

equipment and to provide for a complete and operational system.

- B. The Work of this Section shall require field equipment interconnections. This Section shall describe the field equipment for interconnections but does not detail each specific point-to-point connection. It shall be the Contractor's responsibility to verify and coordinate final connections to all equipment.
- C. The Work of this Section shall adhere to the requirements of the standards listed below as applicable. The latest edition in effect at the time of bid opening shall apply.
  - 1. American Petroleum Institute (API)
  - 2. The Instrumentation, Systems and Automation Society (ISA)
    - a. ISA S5.4, Instrument Loop Diagrams.
    - b. ISA S20, Specification Forms for Process Measurement and Control Instruments, Primary Elements and Control Valves.
    - c. ISA RP60.3, Human Engineering for Control Centers
    - d. ISA RP60.6, Nameplates, Labels, and Tags for Control Centers
  - 3. National Electrical Manufacturers Association (NEMA)
  - 4. National Fire Protection Agency (NFPA)
    - a. NFPA 70, National Electrical Code (NEC).
    - b. NFPA 79, Standard for Industrial Machinery.
  - 5. Underwriters Laboratories, Inc. (UL)
    - a. UL 508, Standard for Industrial Control Equipment.
    - b. UL 698A, Industrial Control Panels Relating to Hazardous (Classified) Locations.
  - 6. American Society for Testing and Materials (ASTM)
    - a. ASTM A269, Standard Specification for Seamless and Welded Austenitic Stainless Steel Tubing for General Service.

#### 1.5 RESPONSIBILITY FOR EQUIPMENT

- A. The General Contractor shall be responsible for providing and placing in satisfactory operation all instruments and equipment necessary for a complete system. This shall include all piping, electrical connections, and system engineering as provided by a qualified Instrumentation and Control System Supplier, and accessories required by the Work of this Section or other related Work included under other Sections in the Contract Documents.
- B. The supply of control panels, instrumentation shall be by a single Instrumentation and Control System Supplier. The supplier shall be responsible to the General Contractor for:
  - (1) satisfactory detailed design of a complete and coordinated system (2), start-up and

testing services, (3) training, and (4) services to assure satisfactory operation.

- C. The General Contractor shall not purchase separate equipment and attempt to assemble a system. This Work is to be performed by a qualified Instrumentation and Control System Supplier as approved by the Engineer.
- D. The Instrumentation System Supplier shall be required to furnish equipment that is installed under other Sections in the Contract Documents. The General Contractor shall be responsible for coordinating this Section with the necessary equipment in order to provide for a complete installation. It shall be coordinated such that there is proper installation of this equipment between suppliers in order to avoid delays in completion due to availability of this equipment. The Instrumentation and Control System Supplier shall provide a separate submittal on this specific equipment for early approval in order to avoid delays.

## 1.6 INSTRUMENTATION SYSTEM SUPPLIER

- A. The Instrumentation and Control System Supplier shall be the following with no substitutions allowed.
  - 1. The following are pre-qualified Instrumentation and Control Contractors.
    - a. R.E. Erickson Co.,  
Inc. Walpole,  
Massachusetts 508-  
668-9330
    - b. NIC Systems  
Corporation Cromwell,  
CT 06416  
860-529-0110
    - c. Electrical Installations, Inc.  
Center Harbor, New  
Hampshire 603-253-4525
    - d. Harbor Controls  
North Kingstown,  
RI 401-667-0930

## 2.0 PART 2 – PRODUCTS

### 2.1 GENERAL

- A. All equipment shall be of the latest proven design. First generation equipment with less than three years general use shall have documentation on construction operation, field test and user list.
- B. All equipment shall be suitable for operation in the environment of the Project.
- C. Transmission to and from analog devices shall be 4-20 mA DC.



- D. Electronic transmitting equipment shall provide loop power. A true two-wire transmitter may have its loop power supplied in the receiving instrument, if available.
- E. The Instrument List included in this Section indicate the intent of the process design and interconnection between instruments. Equipment specified herein does not purport to cover all equipment that may be required to complete the process design intent.
- E. All shielded cable shall be grounded at the control panel end only. Shields shall be carried through junction boxes with the least possible resistance and kept isolated from ground at these points. The field end of the shield shall be insulated to prevent grounding.
- F. All field electronics and outdoor control panel equipment shall be suitable for operation in ambient temperatures of -40 degrees Fahrenheit to 140 degrees Fahrenheit. All indoor control panel located electronics shall be suitable for operation in ambient temperatures of 40 degrees Fahrenheit to 120 degrees Fahrenheit.

## 2.2 MAGNETIC FLOW METER

- A. Flow Element (FE)
  - 1. Type:
    - a. 316 SS self-cleaning bullet nose electrodes
    - b. Steel with Polyurethane Liner
    - c. Connections - ANSI Class 150, RF carbon steel flange
  - 2. Operation:
    - a. Purpose - To produce a low-level voltage output signal proportional to flow rate.
    - b. Operating Principle - Induced voltage proportional to flow rate is produced by the measured fluid (conductor) moving through a magnetic field. Voltage sensed across a pair of diametrically opposed electrodes in a pipe section.
  - 3. Functional:
    - a. Power Requirement - supplied by magnetic flow converter.
    - b. Max Power Consumption - 1 Watt per 5 mm (diameter).
    - c. Electrical Class - NEMA 4X plus temporary submergence at 25-ft for 48 hours.
  - 4. Physical:
    - a. Electrodes - Type 316 SS, field replaceable, configuration for periodic electrode inspection or cleaning.
    - b. Body - Carbon Steel.
    - c. Liner - Polyurethane.

- d. Coils - Completely potted with epoxy-based compound.
  - e. Ends - Carbon Steel flanges
  - f. Exterior Surface - Epoxy coated.
  - g. Grounding rings - Stainless steel grounding rings with grounding strap.
  - h. Approvals - FM.
5. Performance:
- a. Accuracy -  $\pm 0.5$  percent of rate between 10 percent and 100 percent of flow (including transmitter).
  - b. Documentation Required - Certified hydraulic lab calibration data.

B. Flow Transmitter (FIT)

- 1. Type:
  - a. Liquid crystal display with rate and total.
  - b. 4-20 mA DC Output.
  - c. NEMA 4X Enclosure.
- 2. Operation:
  - a. Purpose - Provides coil drive current to the flow tube and convert the electrode signal from the flow tube into 4-20 mA signal linear with flow.
  - b. Circuitry - Microprocessor-based with data stored in nonvolatile EEPROM memory, performing continuous self-diagnostics. Solid-state integrated circuitry, feedback electronically controlled. External contacts shall initiate circuitry that clamps the output to 4 mA under no flow conditions.
- 3. Functional:
  - a. Input - Low level input from electromagnetic flow element.
  - b. Power Requirement - 120 VAC  $\pm 10$  percent, 60 Hz.
  - c. Output - 4-20 mA DC into 0 to 750 ohms.
  - d. Indicator - LCD.
- 4. Physical:
  - a. Case Material - Cast aluminum.
  - b. Case Type - NEMA 4X.
  - c. Mounting - Wall mounted.

C. Performance:

- 1. Systems Accuracy -  $\pm 0.5$  percent of rate between 10 percent and 100 percent of flow (including flow element).

D. Manufacturer: Endress & Hauser, Krohne, ABB, Foxboro or equal.

### 2.3 ULTRASONIC FLOW METER – CLAMP ON

#### A. Flow Element (FE)

1. Type: Clamp on design, externally mounted to pipe.
2. Operation:
  - a. Purpose - To produce a low-level voltage output signal proportional to flow rate.
  - b. Operating Principle - Transit time flow measurement technique with an alternate Doppler measurement technique for liquids with high air or solid content. The meter shall auto toggle from Transit Time measurement to Doppler measurement if the signal decays due to high air or solid content, and toggle back automatically when the Transit Time signal recovers. The Transit Time/Doppler measurement shall be accomplished with a single set of flow transducers and with the use of only one metering channel.
3. Functional:
  - a. Power Requirement - supplied by ultrasonic flow transmitter.
  - b. Max Power Consumption - 15 Watts
  - c. Electrical Class - NEMA 4X.
4. Physical:
  - a. Transducer - Encased in fully sealed, water tight, stainless steel with integral armored stainless steel jacketed TRIAX cable. Provide manufacturer's coupling pads and stainless steel transducer track mounting system for permanent pipe installations. Frequent application of coupling pastes shall not be required for successful application.

#### B. Flow Transmitter (FIT)

1. Type:
  - a. Liquid crystal display with rate and total.
  - b. 4-20 mA DC Output.
2. Operation:
  - a. Purpose - Provides power to the ultrasonic transducer and convert the signal from the transducer into 4-20 mA signal linear with flow.

- b. Circuitry - Microprocessor-based with data stored in nonvolatile EEPROM memory, performing continuous self-diagnostics. Solid-state integrated circuitry, feedback electronically controlled. External contacts shall initiate circuitry that clamps the output to 4 mA under no flow conditions.
- 3. Functional:
  - a. Input - Signal input from transducer.
  - b. Power Requirement - 120 VAC  $\pm$ 10%, 60 Hz.
  - c. Output - 4-20 mA DC into 0 to 750 ohms.
  - d. Indicator - LCD.
- 4. Physical:
  - a. Case Material - Cast aluminum.
  - b. Case Type - NEMA 4X.
  - c. Mounting - Wall mounted.
- C. Performance:
  - 1. Accuracy -  $\pm$ 0.5% of rate.
  - 2. Documentation Required - Wet flow calibration certificate accredited from an international standards agency with an accuracy of better than 1%.
  - 3. All calibration and transducer data must reside on a non-volatile memory chip located in the transducer junction box or flow meter.
- D. Manufacturer: Endress & Hauser, Krohne, Siemens, or equal.

## 2.4 THERMAL GAS MASS FLOW METER

- A. Flow Element (FE)
  - 1. Type:
    - a. 316 SS, Immersible dual probe thermal dispersion.
  - 2. Operation:
    - a. Purpose - To produce a low-level signal output signal to the flow transmitter proportional to dispersed temperature.
    - b. Operating Principle – Dual immersible probes within the gas stream, the velocity sensor probe controls a heat output that the temperature sensor probes senses the dispersed temperature from and maintains a constant temperature differential across the two probes by adjusting

heat output that is utilized to calculate the mass flow.

B. Flow Transmitter (FIT)

1. Type:

- a. Liquid crystal display with rate and total.
- b. 4-20 mA DC Output.
- c. NEMA 4X Enclosure.

2. Operation:

- a. Purpose – Controls and monitors the flow sensor heat dispersion and calculation a mass flow rate.
- b. Circuitry - Microprocessor-based with data stored in nonvolatile EEPROM memory, performing continuous self-diagnostics. Solid-state integrated circuitry, feedback electronically controlled. External contacts shall initiate circuitry that clamps the output to 4 mA under no flow conditions.

3. Functional:

- a. Power Requirement - 120 VAC  $\pm$ 10 percent, 60 Hz.
- b. Output - 4-20 mA DC into 0 to 750 ohms.
- c. Indicator - LCD.

4. Physical:

- a. Case Material – Powder coated cast aluminum.
- b. Case Type - NEMA 4X.
- c. Mounting – Integral to flow sensor,  $\frac{3}{4}$ -inch compression fitting with 1-inch NPT male.

C. Performance:

1. Systems Accuracy -  $\pm$ 1 percent of rate between 0.5 percent of full flow scale (including flow element).
2. Temperature Coefficient – 0.03% per F
3. Pressure Coefficient – 0.02% per psi
4. Response Time - 63% of final velocity value.

D. Manufacturer: Sierra type 640S or equal by others.

2.5 LEVEL INDICATING TRANSMITTER – ULTRASONIC TYPE

A. Sensor

1. Type: Piezoelectric crystal with impedance matched facing.
2. Operation: Transducer transmits high frequency pulse and receives an echo signal back, which is passed on to the transmitter.

3. Functional: Temperature limits - minus 22° Fahrenheit to plus 150° Fahrenheit; relative humidity - 0 to 95 percent; Sensors shall be provided with automatic air temperature and density compensation; Beam width - as recommended by manufacturer for the application.
4. Physical: Mounting - 4 inches (125 lb. drilling) PVC flange with adapters as required to match flanges when used on closed tank application. Sensor shall be potted/ encapsulated in a chemical and corrosion resistant PVC or CPVC housing. Sensors shall be capable of being completely submersed without damage. Sensors located in areas where freezing condensation may occur shall be provided with heaters or other type of transducer protection designed to prevent sensor icing. Sensors shall be compatible with the chemical, which it is measuring.

B. Transmitter

1. Type: Sonic pulse; 4 wire; remote mounted microprocessor electronics package.
2. Operator: Generate pulse signal to transducer, receive echo signal back from transducer, calculate distance based on time difference; transmit a linear isolated 4-20 mA DC signal proportional to distance measured and provide local indication.
3. Functional: Output - 4-20 mA DC; built-in features required - self-adjusting operation; agitator discriminator; adjustable blanking down to 12-in; program selectable automatic volume calculation for horizontal or vertical tanks; programmable conversion tables for volume of odd shaped tanks; velocity/vapor compensation; EEPROM backup; temperature compensation; programmer keypad. Output alarm relays - SPDT contacts with individually adjustable set points with quantity as indicated. Temperature range - minus 15° Fahrenheit to plus 120° Fahrenheit, provide space heaters and thermostats as necessary.
4. Physical: NEMA 4X enclosure; mounting - wall mount; local indicator - 4 digit LCD, scaled to read in engineering units of flow, level, or volume as indicated on in instrumentation list; 120V AC, 60 Hz power input.
5. Performance: Accuracy  $\pm 0.25$  percent of range or  $\pm 0.24$ -in for ranges less than 10-ft; resolution of 0.1 percent of range or 0.08-in, whichever is greater; temperature error -  $\pm 0.01$  percent per °C.

C. Manufacturer: Endress & Hauser, Siemens or equal.

2.6 LEVEL SWITCH - FLOAT TYPE

- A. Float switches shall be of non mercury type, 3½-in diameter hermetically sealed, molded polypropylene construction and include a Form C, tilt-type, switch rated for switching 10 ampere resistive loads at 120 VAC. Switches shall include 40 feet of nitrile PVC jacketed, Type SO, 3-conductor, No. 14 AWG cable suitable for underwater service. Switches shall be rated for the NEMA area in which installed. Switches shall also include Type 316 stainless steel mounting hardware and weighted

cord collar. Switches shall be installed per the manufacturer's requirements.

- B. Level switches shall be manufactured by Consolidated Electric Co., Flygt, Magnetrol, or equal.

## 2.7 LEVEL SWITCHES – LIFTING

- A. Provide a level switches for the chemical containment areas.
- B. Type: Lifting foot type.
- C. Operation. To produce a contact output when lifted.
- D. Manufacturer: Rule-A-Matic 35A Float Switch by ITT, or approved equal

## 2.8 DISSOLVED OXYGEN (DO) SENSORS

- A. The sensor shall be submersible with luminescent technology for measuring dissolved oxygen and produce a signal output signal to a controller.
- B. The method of measuring dissolved oxygen will be a probe using luminescent sensor technology.
  - 1. Blue LED light excites platinum based luminescent material in the probe. Red light is emitted by luminescent material with characteristics that are directly proportional to the amount of dissolved oxygen present. The red light is measured with a photo detector.
  - 2. Red LED light is used to zero the instrument between measuring cycles.
- C. Performance Requirements
  - 1. Measurement range: 0.01 to 20.00 mg/L
  - 2. Resolution: 0.01 mg/L
  - 3. Accuracy: Less than 5 ppm:  $\pm 0.1$  ppm, Greater than 5 ppm:  $\pm 0.2$  ppm
  - 4. Repeatability:  $\pm 0.1$  ppm
  - 5. Response Time: Less than 40 seconds to 90% at 20 °C, Less than 60 seconds to 95% at 20 °C
  - 6. Temperature sensor: PT100 integrated, external sensor
  - 7. Temperature range: 0 to 50 °C
  - 8. Temperature accuracy:  $\pm 0.2^{\circ}\text{C}$

- D. Operational Criteria
  - 1. Operating temperature: 0 to 50 °C
  - 2. Relative humidity: 95%, non-condensing
  - 3. Immersion depth: 15 meters (50 ft.), maximum
  - 4. Immersion pressure: 345 kPa, maximum
  - 5. Sample pH range: 0.0 to 12.0
  - 6. Distance, analyzer to sensor: 1000 meters, maximum
- E. The sensor shall be made of polybutyl methacrolat mounted within an entirely corrosion- resistant and fully immersible probe housing made of CPVC and 316 stainless steel – 1.4404 with Viton o-rings, and utilizes a 1” NPT external thread for mounting hardware connections.
- F. The sensor cable length shall have polyurethane or equal jacket and be sufficient length to extend from the sensor to the controller unit without splices.
- G. Provide a PVC support arm.
- H. Provide all mounting hardware and devices for a complete installation. All mounting hardware and devices shall be PVC.
- I. Sensor shall be Hach LDO Probe Model 2 part # 9020000, no equal.

## 2.9 pH SENSORS

- A. The sensor shall be submersible with differential electrode measurement technique for measuring pH and an output signal to a controller.
- B. The method of measuring pH will be with a probe or sensor that uses differential electrode measurement technique using three electrodes.
  - 1. Two electrodes compare the process value to a stable internal reference standard buffer solution.
  - 2. The internal electrode is non-flowing, foul-resistant characteristics.
- C. Performance Requirements
  - 1. Measurement range: 0 to 14 pH
  - 2. Sensitivity: 0.01 pH
  - 3. Stability: 0.03 pH per 24 hours, non-cumulative



- D. Operational Criteria
  - 1. Temperature range: 23 to 158 °F (-5 to 70 °C)
  - 2. Sample flow rate: 3 meters (10 feet) per second, maximum
  - 3. Pressure: 100 pounds per square inch at 158 °F (6.9 bar at 70 °C)
  - 4. Transmission distance: 1000 meters (3240 feet), maximum
- E. The sensor shall be encapsulated with digital signal processor, pre-amplifier, reference electrode, measuring electrode, ground electrode, replaceable salt bridge, PEEK wetted material, and utilizes a 1" NPT external thread for mounting hardware connections.
- F. The sensor cable length shall have polyurethane or equal jacket and be sufficient length to extend from the sensor to the controller unit without splices.
- G. Provide a PVC support arm.
- H. Provide all mounting hardware and devices for a complete installation. All mounting hardware and devices shall be PVC.
- I. Sensor shall be Hach pH-SC Part # DPD1P1, no equal.

#### 2.10 NITRATE (NO<sub>3</sub>) SENSORS

- A. The sensor shall be submersible with ultraviolet (UV) light absorption measurement technique for measuring nitrates and an output signal to a controller.
- B. The method of measuring nitrate will be ultraviolet (UV) light absorption at 210 nm.
  - 1. A reference beam at 230 nm will provide a reference standard to correct for interference by turbidity and organic matter.
- C. Performance Requirements
  - 1. Measurement range (depending on model): 0.1 to 50 mg/L for nitrate (NO<sub>3</sub>-N)
  - 2. Accuracy (depending on model): ± 5 percent of mean ± 1.0 or better
  - 3. Resolution (depending on model): 0.1 or 0.5 mg/L
  - 4. Detection limit (depending on model): 0.1 to 50 mg/L
  - 5. When connected to a multi-parameter digital controller the overall status of the instrument performance is displayed as a percentage value via a measurement indicator
  - 6. When connected to a multi-parameter digital controller the overall time remaining until maintenance tasks are due is displayed in days

- D. Operational Criteria
  - 1. Operating temperature: 0 to 40 degrees C (36 to 104 degrees F)
  - 2. Operating pressure: 0.5 bar (7.2 psi) maximum
- E. The sensor shall be equipped with a self-cleaning wiper system to prevent erroneous values caused by surface films or particles and mounted within an entirely corrosion-resistant and fully immersible probe housing made of V4A stainless steel. The sensor shall not require reagents.
- F. The sensor compensates for interference from turbidity and organic contamination of up to 150 mg/L and uses a 2-beam ultraviolet absorption technology with 2-mm path length with measurement beam wavelength of 210 nm and is absorbed by nitrate and nitrite. The reference beam has a wavelength of 230 nm and is used to compensate for turbidity in the measured medium. The measurement interval is user-selectable from one to 30 minutes. Up to 12 signals can be averaged.
- G. The sensor cable length shall have polyurethane or equal jacket and be sufficient length to extend from the sensor to the controller unit without splices.
- H. Provide a stainless steel support arm.
- I. Provide all mounting hardware and devices for a complete installation. All mounting hardware and devices shall be stainless steel in their entirety.
- J. Sensor shall be Hach NITRATAX plus sc Part # LXV417.99.20002, no equal.

#### 2.11 AMMONIA (NH<sub>4</sub>) ANALYZER

- A. The sensor shall be submersible with gas selective electrode (GSE) that uses liquid to gas- phase conversion technique for measuring ammonia and an output signal to a controller.
- B. The method of measuring ammonium will be by gas selective electrode (GSE) that uses liquid to gas- phase conversion.
  - 1. Sample is mixed with sodium hydroxide that converts ammonium to ammonia which is expelled from the sample.
  - 2. The ammonia gas can pass the gas selective membrane.
  - 3. Ammonia changes the pH of the electrolyte and the electrode then measures the pH value and calculates the ammonium concentration.
- C. Performance Requirements
  - 1. Measurement range (depending on model):
    - a. 0.05 to 20 mg/L, or
    - b. 1 to 100 mg/L, or
    - c. 10 to 1000 mg/L

2. Lower detection limit (depending on model):
  - a. 0.05 mg/L, or
  - b. 1 mg/L, or
  - c. 10 mg/L
3. Accuracy (depending on model):
  - a. 3% ±0.05 mg/L, or
  - b. 3% ±1.0 mg/L, or
  - c. 4.5% ±10 mg/L
4. Reproducibility (depending on model):
  - a. 2% ±0.05 mg/L, or
  - b. 2% ±1.0 mg/L, or
  - c. 2% ±10 mg/L
5. Response time: Less than 5 minutes (T90) , including sample preparation (in combination with Hach Filterprobe sc)
6. Measurement interval: 5 to 120 minutes, adjustable
7. When connected to a multi-parameter digital controller the overall status of the instrument performance is displayed as a percentage value via a measurement indicator
8. When connected to a multi-parameter digital controller the overall time remaining until maintenance tasks are due is displayed in days

D. Operational Criteria

1. Sample temperature: 4 to 40 °C (39 to 104 °F)
  2. Sample pH: 5 to 9 pH
  3. Operating temperature: -20 to 45 °C (-4 to 114 °F)
  4. Operating humidity: 95% relative humidity, non-condensing
- E. Provide a Filtrax measuring sampler system consist out of a stainless steel control unit with including submersible membrane modules and heated sample hoses to cover distances between Filtrax system and analyzer(s). Unit shall be 120VAC Powered.
- F. The sensor cable length shall have polyurethane or equal jacket and be sufficient length to extend from the sensor to the controller unit without splices.
- G. Provide a stainless steel support arm.

- H. Provide all mounting hardware and devices for a complete installation. All mounting hardware and devices shall be stainless steel in their entirety.
- I. Sensor shall be Hach AMTAX sc Ammonium Analyzer, no equal.

## 2.12 DO, pH, NO<sub>3</sub> and NH<sub>4</sub> SENSOR CONTROLLERS

- A. The controller shall be dual channel microprocessor-based sensor controller with a local display and user interface capable
- B. Controller shall have the following capabilities:
  - 1. Actively monitor all internal components and present diagnostics on the overall health of connected sensors and time to next required maintenance, reducing user risk.
  - 2. Provide real-time alerts when sensor issues occur with built in workflows with step-by-step guidance to perform calibration and maintenance tasks, reducing user risk.
  - 3. Supports advanced communication protocols, including Profibus DPV1, Modbus TCP, Profinet IO, and Ethernet IP
  - 4. Change digital sensors connected to the controller by unplugging and plugging in sensors as necessary.
  - 5. Menu-driven operation system.
  - 6. Real-time clock.
  - 7. Two security levels.
  - 8. Worded operation menus in 8 24 languages.
  - 9. Equipped with an USB reader for data download and controller software
- C. Controller housing shall be NEMA 4X/ IP66 wall or pole mounted enclosure made of polycarbonate, aluminum (powder coated), and stainless steel metal enclosure.
- D. The controller accepts digital sensors in any combination to measure the following:
  - 1. pH/ORP
  - 2. Dissolved Oxygen
  - 3. Nitrate
  - 4. Ammonia
  - 5. Total suspended solids

6. Turbidity
  7. Free/total Chlorine
  8. Total suspended solids
- E. Operational Criteria
1. Operating temperature: –20 to 45 °C (–4 to 113 °F)
  2. Relative humidity: 0 to 95%, non-condensing
  3. Power Requirement – 100–240 VAC ±10%, 50/60 Hz;
  4. Output – (1) 4-20 mA DC, 500 ohms per sensor input.
  5. Indicator – LCD graphic display.
- F. Provide a sun shield.
- G. Provide all mounting hardware and devices for a complete installation. All mounting hardware shall be PVC.
- H. Sensor shall be Hach SC4500, no equal.

#### 2.13 PRESSURE INDICATING TRANSMITTER (ABSOLUTE, GAUGE)

- A. Type: Two-wire, capacitance or solid-state based; high performance “SMART” microprocessor pressure transmitter with HART based digital communications capabilities.
- B. Operation Purpose: To sense pressure and produce a standard current output signal linear with absolute or gauge pressure; indicator - integrally mounted and scaled in engineering units; manifold - stainless steel three (3) valve type.
- C. Functional: Power supply - DC (loop powered); output - 4-20 mA DC; communications protocol - HART; accuracy - ±0.1% of span; integral non-interactive zero and span adjustments; integral LCD indicator of process value in engineering units; non volatile memory; self diagnostic capability.
- D. Physical: Wetted parts - 316 SS, glass filled TFE; seals – Teflon coated; diaphragm – silicone filled; electronics housing - NEMA 4X; process connection – ½ inch NPT; conduit connection – ½-in NPT; wiring connection – screw terminals; mounting – 2 inch pipe mounting bracket; manifold – integral 316 SS 3-valve plus plug.

#### 2.14 TANK LEVEL ALARM STATIONS

- A. Provide tank level alarm stations consisting of a 120VAC red alarm beacon mounted on a NEMA 4X stainless steel enclosure. The stations shall be pre-wired with din rail mounted terminal blocks for field connections of power and high level float switch.

### 3.0 PART 3 – EXECUTION

#### 3.1 INSTALLATION

- A. Instrumentation and accessory equipment shall be installed in accordance with the best field and shop practices.
- B. The workmanship shall be in accordance with the best field and shop practices for instrumentation and control systems.
- C. All workmen shall be skilled in the work to which they are assigned and all work shall be performed under the direct supervision of an experienced and competent Instrumentation and Control System Supplier foreman.
- D. All internal wiring of control panel(s) shall be done by the Instrumentation and Control System Supplier in accordance with the drawings and instrument manufacturer's instructions and UL requirements.
- E. The Contract Documents indicate the extent of the interconnections between and the type of individual instrument. The proposed equipment shall be supplied complete with all mounting hardware and accessories to satisfy the functional requirements.
- F. All work shall be executed in full accordance with UL requirements and codes and local rulings. Should any work be performed contrary to said rulings, ordinances and regulations, the Instrumentation and Control System Supplier and ultimately the Contractor shall bear full responsibility for such violations and assume all costs arising there from this situation.
- G. Interfacing devices shall be compatible with the equipment to which they are attached and shall comply with the applicable specifications.
- H. Coordination with the process and equipment, in addition to standard quoted devices required to conform the instrumentation to the process, shall be the responsibility of the Contractor. The Instrumentation and Control System Supplier shall provide detailed information on the devices being supplied and the extent of the field installation required.
- I. Brackets and hangers required for mounting of equipment shall be provided as noted in the Contract Documents or as required. They shall be done in a workmanlike manner and not interfere with any other equipment. These devices shall be manufactured from non- corroding stainless steel, suitable to the installed environment.
- J. The Contractor shall investigate each space in the building through which equipment must pass to reach its final location. If necessary, the equipment manufacturer shall be required to ship his material in sections sized to permit passing through such restricted areas in the building.
- K. The shield on each process instrumentation cable shall be grounded as directed by the manufacturer of the instrumentation equipment or as noted in this Section, but in no case shall more than one ground be employed for each shield. Only one end of shielded cable shall be grounded.

- L. Maximum practical separation shall be maintained between signal (analog, alarm, and status) conduits and power feeders and AC systems.
- M. All field conductors shall terminate at the control panel terminal blocks. Millivolt signal wires (i.e., thermocouple) may be connected directly to the input terminals of the receiving instrument if so specified.
- N. All wire ends shall be identified at both ends with wire markers.
- O. Lifting rings from cabinets/assemblies shall be removed. Hole plugs shall be provided for the holes of the same color as the cabinet.

### 3.2 COMMISSIONING

- A. The instruments and equipment shall be tested for proper installation, interconnection, and function.
- B. Testing and calibration of equipment shall be performed as specified herein and per manufacture recommendation/requirements.
- C. Prior to electrical check out all breakers, switches and similar disconnect devices shall be placed in the off position.
- D. Control panel and other equipment grounding shall be verified. The systems shall be checked for improper or accidental grounding.
- E. Visual inspection and continuity testing shall be made to verify that no damaging wiring errors occur between power and signal wiring.
- F. The Contractor shall arrange for and obtain the services of a factory trained and qualified service engineer(s) from the Instrumentation and Control System Supplier and/or from the equipment manufacturer(s) to perform the calibration and commissioning of the instrumentation and equipment.
- G. Instrument calibration shall be the responsibility of the Instrumentation and Control System Supplier and the supplier of the equipment. Each applicable instrument shall be calibrated at 0 percent, 10 percent, 25 percent, 50 percent, 75 percent, 90 percent and 100 percent, ascending and descending, of the instrument's span using calibration equipment that is traceable to an instrument or group of instruments calibrated by the National Institute of Standards and Technology, as applicable. A certified calibration report and calibration curve for each applicable instrument shall be completed and submitted to the Engineer.

### 3.3 SUPPLIER'S SERVICES

- A. The supervisory service of a factory-trained service engineer specifically trained on the type of equipment specified herein shall be provided during construction to assist the Contractor in equipment installation, the location of sleeves, methods of installing conduit and special cable, mounting, piping and wiring of one of each type of device, and the methods of protecting all of the equipment prior to placing it into service.

- B. Upon completion of the installation, the service engineer's services shall be provided for calibration, testing and start-up of the equipment.

### 3.4 PRODUCT HANDLING

- A. Special instructions for proper field handling and installation required by the manufacturer for proper protection shall be securely attached to each piece of equipment prior to shipment.
- B. Each package shall be tagged to identify its location, tag number and function in the system. Identification shall be prominently displayed on the outside of the package.
- C. A permanent stainless steel or other non-corrosive material tag firmly attached and permanently and indelibly marked with the instrument tag number as given in the Instrument List and/or in the Contract Documents shall be provided on each piece of equipment supplied under this Section. The tag shall be attached by stainless steel screws or stainless steel chain/wire to a permanent part of the instrument. The tag number characters shall be a minimum 3/16-in high.
- D. Equipment shall not be stored out-of-doors. Equipment shall be stored in dry permanent shelters and, including in-line equipment, shall be adequately protected against mechanical injury. If any apparatus has been damaged, such damage shall be repaired or the damaged equipment replaced by the Contractor at the Contractor's cost and expense. If any apparatus has been subject to possible damage by water, it shall be thoroughly dried out and put through such tests as directed by the Engineer at the Contractor's cost and expense, or the apparatus shall be replaced by the Contractor at the Contractor's cost and expense.

### 3.5 GUARANTEE

- A. The instrumentation shall be warranted for one (1) year from date of substantial completion.



**INSTRUMENTATION LIST**

<b>TAG #</b>	<b>FACILITY</b>	<b>FUNCTION</b>	<b>INSTRUMENT</b>	<b>TYPE</b>	<b>LOCATION</b>	<b>RANGE</b>	<b>UNITS</b>	<b>REMARKS</b>
FIT-3171	Train #1 Biological Treatment Tank	Aerobic Zone #1 Aeration Flow	Flow Element/Transmitter	Thermal Mass	Train #1 Aerobic Zone #1	0 to 2000	CFM	--
FIT-3172	Train #1 Biological Treatment Tank	Aerobic Zone #2 Aeration Flow	Flow Element/Transmitter	Thermal Mass	Train #1 Aerobic Zone #2	0 to 2000	CFM	--
FIT-3173	Train #1 Biological Treatment Tank	Aerobic Zone #3 Aeration Flow	Flow Element/Transmitter	Thermal Mass	Train #1 Aerobic Zone #3	0 to 2000	CFM	--
FIT-3174	Train #1 Biological Treatment Tank	Aerobic Swing Zone 2B Aeration Flow	Flow Element/Transmitter	Thermal Mass	Train #1 Aerobic Swing Zone #2B	0 to 2000	CFM	--
FIT-3175	Train #1 Biological Treatment Tank	Aerobic Swing Zone 2A Aeration Flow	Flow Element/Transmitter	Thermal Mass	Train #1 Aerobic Swing Zone #2A	0 to 2000	CFM	--
FIT-3271	Train #2 Biological Treatment Tank	Aerobic Zone #1 Aeration Flow	Flow Element/Transmitter	Thermal Mass	Train #2 Aerobic Zone #1	0 to 2000	CFM	--
FIT-3272	Train #2 Biological Treatment Tank	Aerobic Zone #2 Aeration Flow	Flow Element/Transmitter	Thermal Mass	Train #2 Aerobic Zone #2	0 to 2000	CFM	--
FIT-3273	Train #2 Biological Treatment Tank	Aerobic Zone #3 Aeration Flow	Flow Element/Transmitter	Thermal Mass	Train #2 Aerobic Zone #3	0 to 2000	CFM	--
FIT-3174	Train #1 Biological Treatment Tank	Aerobic Swing Zone 2B Aeration Flow	Flow Element/Transmitter	Thermal Mass	Train #2 Aerobic Swing Zone #1B	0 to 2000	CFM	--
FIT-3175	Train #1 Biological Treatment Tank	Aerobic Swing Zone 2A Aeration Flow	Flow Element/Transmitter	Thermal Mass	Train #2 Aerobic Swing Zone #1A	0 to 2000	CFM	--
AE-3501	Train #1 Biological Treatment Tank	Anoxic Zone #2 Nitrate	NO3 Sensor	Electronic	Train #1 Anoxic Zone #2	0.1 to 50	Mg/L	--
AE-3502	Train #1 Biological Treatment Tank	Anoxic Zone #2 pH	pH Sensor	Electronic	Train #1 Anoxic Zone #2	0 to 14	pH	--

INSTRUMENTATION LIST								
TAG #	FACILITY	FUNCTION	INSTRUMENT	TYPE	LOCATION	RANGE	UNITS	REMARKS
AIT-3501/ AIT- 3502	Train #1 Biological Treatment Tank	Anoxic Zone #2 Nitrate and pH	NO3 and Ph Controller	Electronic	Train #1 Anoxic Zone #2 Tank	0.1 to 50 0 to 14	Mg/L pH	--
AE-3503	Train #1 Biological Treatment Tank	Aerobic Swing Zone 2A Dissolved Oxygen	DO Sensor	Electronic	Train #1 Aerobic Swing Zone #2A	0.01 to 20	Mg/L	--
AIT-3503	Train #1 Biological Treatment Tank	Aerobic Swing Zone 2A Dissolved Oxygen	DO Controller	Electronic	Train #1 Swing Zone #2A Tank	0.01 to 20	Mg/L	--
AE-3504	Train #1 Biological Treatment Tank	Aerobic Zone #1 Dissolved Oxygen	DO Sensor	Electronic	Train #1 Aerobic Zone #1	0.01 to 20	Mg/L	--
AIT- 3504	Train #1 Biological Treatment Tank	Aerobic Zone #1 Dissolved Oxygen	DO Controller	Electronic	Train #1 Aerobic Zone #1 Tank	0.01 to 20	Mg/L	--
AE-3505	Train #1 Biological Treatment Tank	Aerobic Zone #2 Dissolved Oxygen	DO Sensor	Electronic	Train #1 Aerobic Zone #2	0.01 to 20	Mg/L	--
AE-3506	Train #1 Biological Treatment Tank	Aerobic Zone #2 pH	pH Sensor	Electronic	Train #1 Aerobic Zone #2	0 to 14	pH	--
AIT-3505/ AIT- 3506	Train #1 Biological Treatment Tank	Aerobic Zone #2 Dissolved Oxygen and pH	DO and pH Controller	Electronic	Train #1 Aerobic Zone #2 Tank	0.01 to 20 0 to 14	Mg/L pH	--
AE-3507	Train #1 Biological Treatment Tank	Aerobic Zone #3 Dissolved Oxygen	DO Sensor	Electronic	Train #1 Aerobic Zone #3	0.01 to 20	Mg/L	--
AE-3508	Train #1 Biological Treatment Tank	Aerobic Zone #3 Nitrate	NO3 Sensor	Electronic	Train #1 Aerobic Zone #3	0.1 to 50	Mg/L	--
AIT-3507/ AIT- 3508	Train #1 Biological Treatment Tank	Aerobic Zone #3 Dissolved Oxygen and Nitrate	DO and NO3 Controller	Electronic	Train #1 Aerobic Zone #3 Tank	0.01 to 20 0.1 to 50	Mg/L Mg/L	--

INSTRUMENTATION LIST								
TAG #	FACILITY	FUNCTION	INSTRUMENT	TYPE	LOCATION	RANGE	UNITS	REMARKS
AE-3510	Train #1 Biological Treatment Tank	Aerobic Zone #3 Ammonia	NH4 Sensor	Electronic	Train #1 Aerobic/ Anoxic Swing Zone	0.01 to 20	Mg/L	--
AIT-3510	Train #1 Biological Treatment Tank	Aerobic Zone #3 Ammonia	NH4 Controller	Electronic	Train #1 Aerobic/ Anoxic Swing Zone Tank	0.01 to 20	Mg/L	--
AE-3511	Secondary Anoxic Tank #1	Secondary Anoxic Tank #1 Dissolved Oxygen	DO Sensor	Electronic	Secondary Anoxic Tank #1	0.01 to 20	Mg/L	--
AE-3512	Secondary Anoxic Tank #1	Secondary Anoxic Tank #1 Nitrate	NO3 Sensor	Electronic	Secondary Anoxic Tank #1	0.1 to 50	Mg/L	--
AIT-3511/ AIT- 3512	Secondary Anoxic Tank #1	Secondary Anoxic Tank #1 Dissolved Oxygen and Nitrate	DO and NO3 Controller	Electronic	Secondary Anoxic Tank #1	0.01 to 20 0.1 to 50	Mg/L Mg/L	--
AE-3513	Re-Aeration Tank #1	Re-Aeration Tank #1 Dissolved Oxygen	DO Sensor	Electronic	Re-Aeration Tank #1	0.01 to 20	Mg/L	--
AIT-3513	Re-Aeration Tank #1	Re-Aeration Tank #1 Dissolved Oxygen	DO Controller	Electronic	Re-Aeration Tank #1	0.01 to 20	Mg/L	--
AE-3521	Train #2 Biological Treatment Tank	Anoxic Zone #2 Nitrate	NO3 Sensor	Electronic	Train #2 Anoxic Zone #2	0.1 to 50	Mg/L	--
AE-3522	Train #2 Biological Treatment Tank	Anoxic Zone #2 #3 pH	pH Sensor	Electronic	Train #2 Anoxic Zone #2	0 to 14	pH	--
AIT-3521/ AIT- 3522	Train #2 Biological Treatment Tank	Anoxic Zone #2 Nitrate and pH	NO3 and Ph Controller	Electronic	Train #2 Anoxic Zone #2 Tank	0.1 to 50 0.2 0 to 14	Mg/L pH	--
AE-3523	Train #2 Biological Treatment Tank	Swing Zone 1A Dissolved Oxygen	DO Sensor	Electronic	Train #2 Swing Zone 1A	0.01 to 20	Mg/L	--
AIT-3523	Train #2 Biological Treatment Tank	Anoxic Zone 1A Dissolved Oxygen	DO Controller	Electronic	Train #2 Swing Zone 1A Tank	0.01 to 20	Mg/L	--

INSTRUMENTATION LIST								
TAG #	FACILITY	FUNCTION	INSTRUMENT	TYPE	LOCATION	RANGE	UNITS	REMARKS
AE-3524	Train #2 Biological Treatment Tank	Aerobic Zone #1 Dissolved Oxygen	DO Sensor	Electronic	Train #2 Aerobic Zone #1	0.01 to 20	Mg/L	--
AIT- 3524	Train #2 Biological Treatment Tank	Aerobic Zone #1 Dissolved Oxygen	DO Controller	Electronic	Train #2 Aerobic Zone #1 Tank	0.01 to 20	Mg/L	--
AE-3525	Train #2 Biological Treatment Tank	Aerobic Zone #2 Dissolved Oxygen	DO Sensor	Electronic	Train #2 Aerobic Zone #2	0.01 to 20	Mg/L	--
AE-3526	Train #2 Biological Treatment Tank	Aerobic Zone #2 pH	pH Sensor	Electronic	Train #2 Aerobic Zone #2	0 to 14	pH	--
AIT-3525/ AIT- 3526	Train #2 Biological Treatment Tank	Aerobic Zone #2 Dissolved Oxygen and pH	DO and pH Controller	Electronic	Train #2 Aerobic Zone #2 Tank	0.01 to 20 0 to 14	Mg/L pH	--
AE-3527	Train #2 Biological Treatment Tank	Aerobic Zone #3 Dissolved Oxygen	DO Sensor	Electronic	Train #2 Aerobic Zone #3	0.01 to 20	Mg/L	--
AE-3528	Train #2 Biological Treatment Tank	Aerobic Zone #3 Nitrate	NO3 Sensor	Electronic	Train #2 Aerobic Zone #3	0.1 to 50	Mg/L	--
AIT-3527/ AIT- 3528	Train #2 Biological Treatment Tank	Aerobic Zone #3 Dissolved Oxygen and Nitrate	DO and NO3 Controller	Electronic	Train #2 Aerobic Zone #3 Tank	0.01 to 20 0.1 to 50	Mg/L Mg/L	--
AE-3530	Train #2 Biological Treatment Tank	Aerobic Zone #3 Ammonia	NH4 Sensor	Electronic	Train #2 Aerobic/ Anoxic Swing Zone	0.01 to 20	Mg/L	--
AIT-3530	Train #2 Biological Treatment Tank	Aerobic Zone #3 Ammonia	NH4 Controller	Electronic	Train #2 Aerobic/ Anoxic Swing Zone Tank	0.01 to 20	Mg/L	--
AE-3531	Secondary Anoxic Tank #2	Secondary Anoxic Tank #2 Dissolved Oxygen	DO Sensor	Electronic	Secondary Anoxic Tank #2	0.01 to 20	Mg/L	--
AE-3532	Secondary Anoxic Tank #2	Secondary Anoxic Tank #2 Nitrate	NO3 Sensor	Electronic	Secondary Anoxic Tank #2	0.1 to 50	Mg/L	--

INSTRUMENTATION LIST								
TAG #	FACILITY	FUNCTION	INSTRUMENT	TYPE	LOCATION	RANGE	UNITS	REMARKS
AIT-3531/ AIT-3532	Secondary Anoxic Tank #2	Secondary Anoxic Tank #2 Dissolved Oxygen and Nitrate	DO and NO3 Controller	Electronic	Secondary Anoxic Tank #2	0.01 to 20 0.1 to 50	Mg/L Mg/L	--
AE-3533	Re-Aeration Tank #2	Re-Aeration Tank #2 Dissolved Oxygen	DO Sensor	Electronic	Re-Aeration Tank #2	0.01 to 20	Mg/L	--
AIT-3533	Re-Aeration Tank #2	Re-Aeration Tank #2 Dissolved Oxygen	DO Controller	Electronic	Re-Aeration Tank #2	0.01 to 20	Mg/L	--
LE-3611	Micro-C Tanks	Micro-C Tank #1 Level	Level Element	Ultrasonic	Micro-C Tank #1	0-20	FT	--
LIT-3611	Micro-C Tanks	Micro-C Tank #1 Level	Level Ind/Transmitter	Electronic	Micro-C Tank #1	0-20	FT	--
LSH-3611	Micro-C Tanks	Micro-C Tank #1 High Level	Level Switch	Float	Micro-C Tank #1	--	--	--
LAH-3611	Micro-C Tanks	Micro-C Tank #1 High Level Alarm	Tank Level Alarm Station	Level Alarm Station	Micro-C Tank #1	--	--	--
LE-3612	Micro-C Tanks	Micro-C Tank #2 Level	Level Element	Ultrasonic	Micro-C Tank #2	0-20	FT	--
LSH-3612	Micro-C Tanks	Micro-C Tank #2 High Level	Level Switch	Float	Micro-C Tank #2	--	--	--
LAH-3612	Micro-C Tanks	Micro-C Tank #2 High Level Alarm	Tank Level Alarm Station	Level Alarm Station	Micro-C Tank #2	--	--	--
LSH-3613	Micro-C Tanks	Micro-C Tank Leak	Level Switch	Lifting	Micro-C Tanks	--	--	--
LIT-3612	Micro-C Tanks	Micro-C Tank #2 Level	Level Ind/Transmitter	Electronic	Micro-C Tank #2	0-20	FT	--
LE-4131	Sludge Pumping Station #1	Finals Scum Well #1 Level	Level Element	Ultrasonic	Finals Scum Well #1	0-15	FT	--
LIT-4131	Sludge Pumping Station #1	Finals Scum Well #1 Level	Level Ind/Transmitter	Electronic	Finals Scum Well #1	0-15	FT	--
FE-4151	Sludge Pumping Station #1	Sludge Pumping Station #1 WAS Flow	Flow Element	Magnetic Meter	Sludge Pumping Station #1 WAS Line	0-500	GPM	--

INSTRUMENTATION LIST								
TAG #	FACILITY	FUNCTION	INSTRUMENT	TYPE	LOCATION	RANGE	UNITS	REMARKS
FIT-4151	Sludge Pumping Station #1	Sludge Pumping Station #1 WAS Flow	Flow Transmitter	Electronic	Sludge Pumping Station #1 WAS Line	0-500	GPM	--
FE-4161	Sludge Pumping Station #1	Sludge Pumping Station #1 RAS Flow	Flow Element	Magnetic Meter	Sludge Pumping Station #1 RAS Line	0-500	GPM	--
FIT-4161	Sludge Pumping Station #1	Sludge Pumping Station #1 RAS Flow	Flow Transmitter	Electronic	Sludge Pumping Station #1 RAS Line	0-500	GPM	--
LE-4231	Sludge Pumping Station #2	Finals Scum Well #2 Level	Level Element	Ultrasonic	Finals Scum Well #2	0-15	FT	--
LIT-4232	Sludge Pumping Station #2	Finals Scum Well #2 Level	Level Ind/Transmitter	Electronic	Finals Scum Well #2	0-15	FT	--
FE-4251	Sludge Pumping Station #2	Sludge Pumping Station #2 WAS Flow	Flow Element	Magnetic Meter	Sludge Pumping Station #2 WAS Line	0-500	GPM	--
FIT-4251	Sludge Pumping Station #2	Sludge Pumping Station #2 WAS Flow	Flow Transmitter	Electronic	Sludge Pumping Station #2 WAS Line	0-500	GPM	--
FE-4261	Sludge Pumping Station #2	Sludge Pumping Station #2 RAS Flow	Flow Element	Magnetic Meter	Sludge Pumping Station #2 RAS Line	0-500	GPM	--
FIT-4261	Sludge Pumping Station #2	Sludge Pumping Station #2 RAS Flow	Flow Transmitter	Electronic	Sludge Pumping Station #2 RAS Line	0-500	GPM	--
PIT-6501	Blower Building	Blower Header Air Pressure	Pressure Ind/Transmitter	Electronic	Blower Header Air Pressure	0-150	PSI	--
LSH-9360	Blower Building Tight Tank	Blower Building Tight Tank High Level	Level Switch	Float	Blower Building Tight Tank	--	--	--

END OF SECTION

## SECTION 13321

### INSTRUMENTATION AND CONTROLS

#### 1.0 PART 1 - GENERAL

#### 1.1 DESCRIPTION

- A. The Work of this Section shall include all labor, materials, and equipment required to provide a complete instrumentation and control system including a new full monitoring and control SCADA system to replace the existing SCADA system at the Taunton Waste Water Treatment Facility as specified within the Contract Documents. A single Instrumentation and Control System Supplier shall provide all labor, materials, equipment and services required to achieve a fully operational and reliable instrument and control system as specified herein and as shown in the Contract Documents.
- B. The work required by this section shall include interfacing to all existing and new primary instrumentation equipment and devices necessary to provide process data and monitoring as shown and as specified. The particular requirements of this section are specific in that this system supplier must furnish and install a system which will provide for a future input/output SCADA interface. All input/outputs (I/O) shall be collected as noted in the I/O lists of this project. In addition, the system shall include interface and connections to additional PLC's being provided under other Divisions of these specifications. The loop descriptions provide a functional description for the process portion of the system.
- C. The system supplier shall carefully review all requirements of this section in order to fully understand the limit of responsibility and the extent of what must be done to complete this portion of the system. It shall be understood that this system supplier will provide for a complete and operational I/O system that shall be completely documented and coordinated in order to provide for a complete system interface. Data collection shall be accomplished through a PLC to PLC Ethernet network, Flex I/O or hard-wired inputs to the main PLC. All input/outputs (I/O) shall terminate at each of the respective panels.
- D. The capacity and quality of instruments and equipment shall be provided such that they perform the function described in the SYSTEM DESCRIPTION, as shown on the Contract Drawings and as listed in the Instrumentation List at the end of this section. It is the intent of this section of the specifications to specify a complete instrumentation and monitoring system. Anything that is not shown on the drawings but is mentioned anywhere in the specifications or vice versa, or anything not expressly set forth in either but which is reasonably implied, shall be furnished and performed as though specified, shown and mentioned in both. If an item appears in one area of the contract documents but not in another, it shall be provided in its entirety. This system supplier shall obtain and review complete set of the specifications and drawings prior to submitting final costs for the work of this section and/or any related sections.



- E. Equipment under this section shall be fabricated, assembled, installed, and placed in proper operating condition in full compliance with details, drawings, specifications engineering data, instructions and recommendations of the equipment manufacturer as approved by the Engineer.
  
- F. The Instrumentation System Supplier shall closely coordinate and cooperate with the supplier of instrumentation furnished under the following sections:
  - 1. Section 11330 – Fine Screens
  - 2. Section 11345 – Lime System
  
- G. The Instrumentation System supplier under this Section shall insure total compatibility where interfacing between equipment is required and shall initiate and maintain close communication and cooperation with the supplier of the equipment throughout the shop drawing and equipment start-up and testing phases of the work and insure total compatibility of all required interfacing at no extra cost to the Owner.
  
- H. This system supplier shall be responsible for all input/output information transfer and communication between equipment PLC's. The existing ethernet network shall be extended and configured between the referenced systems and this instrumentation system in order to link input/output data to the SCADA system. A PLC to PLC network shall be established. All system suppliers shall be responsible to coordinate and finalize all input/output data. It shall be noted that any or all information configured at each system PLC shall be also configurable at the main SCADA PLC and HMI. All HMI screen configurations shall be the responsibility of this Instrumentation System Supplier. Provide all necessary man-hours as part of the final bid price for the work of this section to perform this work. Failure to do so and any associated additional costs shall be incurred by this system supplier and not the Owner.
  
- I. Due to the complexity of the work of this and other related sections and in order to establish a basis of bid for the equipment designed herein, a specific PLC manufacturer has been named within this section of the specifications. In order to properly establish the requirements of this and other related sections, all system equipment and components for this PLC (Programmable Logic Controller) system as designed shall be as manufactured by Allen Bradley. Any deviation or substitutions at this time which requires any direct additional costs or additional work and results in additional costs for the requirements of this section shall be incurred by this Contractor and not the Owner. Also, any cabling data exchange changes, equipment changes, etc. shall be the responsibility of this system supplier to coordinate and provide as necessary to allow acceptability of the approved system. This shall be completely understood and there shall be no additional costs incurred due to failure to provide these requirements as noted. It shall be noted that all applicable DIVISION 11 sections and Section 13300 must provide the same manufacturer of PLC equipment for a compatible and complete system.
  
- J. Specific equipment functionality has been established as part of the system design for this portion of the system. This shall generally be described as follows:

1. Main Terminal Unit Control Panel (MTU-CP)
  - a. Provide a PLC based main terminal unit (MTU) control panel for control and data collection of hardwired input/output analog, discrete and alarm points associated with the operation building and as specified. This PLC shall be networked with remote I/O modules, other PLC's and the new SCADA computer system via a Ethernet network as specified in this Section. The MTU-CP control panel shall be located in the SCADA monitoring room of the Operations Building.
  - b. The MTU control panel shall include a main PLC and a redundant active hot backup PLC so in the event of a main PLC failure the redundant backup PLC shall seamlessly take over all monitoring and control of the complete SCADA system.
2. Remote Terminal Unit Control Panel #2 (RTU-2)
  - a. Provide a remote terminal unit control panel consisting of remote I/O modules for the control and data collection of hardwired input/output analog, discrete and alarm points associated with the primary treatment process and as specified. The remote I/O modules shall be networked with the MTU PLC via an Ethernet network as specified in this Section. The RTU-2 control panel shall be located in the Primary Pipe Gallery.
3. Remote Terminal Unit Control Panel #3 (RTU-3)
  - a. Provide a remote terminal unit control panel consisting of remote I/O modules for the control and data collection of hardwired input/output analog, discrete and alarm points associated with the future biological treatment process, plant power systems, and as specified. The remote I/O modules shall be networked with the MTU PLC via an Ethernet network as specified in this Section. The RTU-3 control panel shall be located in the Blower Building.
  - b. All PLC and SCADA system configuration, programing, screens, report generation, and ect. to achieve a full functional system for Loop Descriptions falling within Loops 3000 to 3999 and 6000 to 6999 shall be provided as part of this contract and implemented, tested and commissioned as part of the future Phase 2 contract.
  - c. The Instrumentation/Controls Contractor shall provide as part of the Phase 1 Bid a line item bid price for the Phase 2 implementation, startup, testing and commissioning of the Loop Descriptions falling within Loops 3000 to 3999 and 6000 to 6999 that shall be awarded

under the Phase 2 contract.

4. Remote Terminal Unit Control Panel #4A (RTU-4A) – Provided under This Contract and Installed in Future Under Separate Contract
  - a. Provide a remote terminal unit control panel consisting of remote I/O modules for the control and data collection of hardwired input/output analog, discrete and alarm points associated with the final treatment process of Final Clarifiers #1 & #2. The remote I/O modules will be networked with the MTU PLC via an Ethernet network as specified in this Section. The RTU-4A control panel shall be properly stored on site and will be installed in the Sludge Pump Station #1 as part of the future Phase 2 contract. All PLC and SCADA system configuration, programing, screens, report generation, and ect. to achieve a full functional system for Loop Descriptions falling within Loops 4000 to 4999 shall be provided as part of this contract and implemented, tested and commissioned as part of the future Phase 2 contract.
  - b. The Instrumentation/Controls Contractor shall provide as part of the Phase 1 Bid a line item bid price for the Phase 2 implementation, startup, testing and commissioning of the Loop Descriptions falling within Loops 4000 to 4999 associated with RTU-4A I/O that shall be awarded under the Phase 2 contract.
  
5. Remote Terminal Unit Control Panel #4B (RTU-4B) – Provided under This Contract and Installed in Future Under Separate Contract
  - a. Provide a remote terminal unit control panel consisting of remote I/O modules for the control and data collection of hardwired input/output analog, discrete and alarm points associated with the final treatment process of Final Clarifiers #3 & #4. The remote I/O modules will be networked with the MTU PLC via an Ethernet network as specified in this Section. The RTU-4A control panel shall be properly stored on site and will be installed in the Sludge Pump Station #2 as part of the future Phase 2 contract. All PLC and SCADA system configuration, programing, screens, report generation, and ect. to achieve a full functional system for Loop Descriptions falling within Loops 4000 to 4999 shall be provided as part of this contract and implemented, tested and commissioned as part of the future Phase 2 contract.
  - b. The Instrumentation/Controls Contractor shall provide as part of the Phase 1 Bid a line item bid price for the Phase 2 implementation, startup, testing and commissioning of the Loop Descriptions falling within Loops 4000 to 4999 associated with RTU-4B I/O that shall be awarded under the Phase 2 contract.

6. Remote Terminal Unit Control Panel #5 (RTU-5)
  - a. Provide a remote terminal unit control panel consisting of remote I/O modules for the control and data collection of hardwired input/output analog, discrete and alarm points associated with the disinfection treatment process, plant water system, plant sanitary system, and as specified. The remote I/O modules shall be networked with the MTU PLC via an Ethernet network as specified in this Section. The RTU-5 control panel shall be located in the Chemical Building.
  
7. Remote Terminal Unit Control Panel #7 (RTU-7)
  - a. Provide a remote terminal unit control panel consisting of remote I/O modules for the control and data collection of hardwired input/output analog, discrete and alarm points associated with the solids handling process, headworks process, and as specified. The remote I/O modules shall be networked with the MTU PLC via an Ethernet network as specified in this Section. The RTU-7 control panel shall be located in the Solids Handling Building.
  
8. Lime System Control Panel (CP-1100)
  - a. This PLC controlled panel shall be provided under Section 11345 Lime Storage and Feed System. The CP-1100 PLC shall be networked with the SCADA system and MTU PLC via an Ethernet network as specified in this Section. All information collected through CP-1100 shall be available at the SCADA system. The CP-1100 control panel shall be located in base of the Lime Silo structure.
  
9. Screenings Control Panel (CP-1300)
  - a. This PLC controlled panel shall be provided under Section 11330 Influent Fine Screening System. The CP-1300 PLC shall be networked with the SCADA system and MTU PLC via an Ethernet network as specified in this Section. All information collected through CP-1300 shall be available at the SCADA system. The CP-1300 control panel shall be located in Headworks Electrical Enclosure.
  
10. Micro-C Control Panel (CP-3600)
  - a. This microprocessor-based control panel shall be provided in the future Phase 2 Project. The CP-3600 control panel will be networked with the SCADA system and MTU PLC via an Ethernet network as specified in this Section. All information collected through CP-3600 shall be available at the SCADA system. The CP-3600 control panel will be located in the New Blower Building

11. Aeration Master Control Panel (CP-6000)
  - a. This PLC controlled panel shall be provided in the future Phase 2 Project. The CP-6000 PLC will be networked with the SCADA system and MTU PLC via an Ethernet network as specified in this Section. All information collected through CP-6000 shall be available at the SCADA system. The CP-6000 control panel will be located in the New Blower Building
12. Centrifuge #1 Control Panel (CP-7301)
  - a. The Centrifuge #1 PLC control panel has been provided under previous Contract 1A. The CP-7301 PLC shall be networked with the SCADA system and MTU PLC via an Ethernet network as specified in this Section. All information collected through CP-7301 shall be available at the SCADA system. The CP-7301 control panel shall be located in the Solids Handling Building.
13. Centrifuges #2 Control Panel (CP-7302)
  - a. The Centrifuge #2 PLC control panel has been provided under previous Contract 1A. The CP-7302 PLC shall be networked with the SCADA system and MTU PLC via an Ethernet network as specified in this Section. All information collected through CP-7302 shall be available at the SCADA system. The CP-7302 control panel shall be located in the Solids Handling Building.
14. Plant Water Control Panel (CP-9100)
  - a. This PLC controlled panel shall be provided under Section 11311 Package Plant Water Pump Station. The CP-9100 PLC shall be networked with the SCADA system and MTU PLC via an Ethernet network as specified in this Section. All information collected through CP-9100 shall be available at the SCADA system. The CP-9100 control panel shall be located in the Chemical Building.
15. Existing Sewage Collection System Pump Stations and CSO Facility
  - a. The existing Sewage Pump Stations and CSO Facility in the City's Sewage Collection System have PLC based RTU control panels that communicate with existing SCADA system via a citywide fiber optic network. The new SCADA system shall monitor, display and alarm these facilities as described in the Loop Descriptions.

K. The existing SCADA system shall remain completely functional until the new SCADA

system has been installed and tested. The following criteria dictates the general requirements for the Instrumentation and Controls System Supplier for the change over from the existing system to the new system SCADA system:

- 1 The existing SCADA control panels shall be replaced with the new SCADA control panels.
- 2 The new SCADA system shall be completely networked together with point to point testing from each control cabinet I/O point to the SCADA HMI Screen.
- 3 Only a single process loop with an existing control panel shall be cut over to the new control panel at a time. The Instrumentation and Controls System Supplier shall supervise the cut over, the Division 16 contractor shall disconnect the I/O terminations within existing control and terminate the I/O connections in the new control panel.
- 4 Once an entire process loop has been cut over to the new control panel that loop shall be completely tested and commissioned prior to the next process loop cut over.
- 5 Coordinate with the general contractor, electrical contractor and owner with a minimum 2 week notice for when a control panel cut over shall be taken place.

## 1.2 SUBMITTALS

A. Submit the following in accordance with Section 01300:

1. Manufacturer's data, order sheet or equivalent for each individual instrument or device being supplied. The information shall include but not be limited to model number, exact chart, scale or calibration range, type of enclosure and mounting, input/output and power data and the instrument tag number (or loop number for auxiliary equipment). Sales literature will not be accepted.
2. Manufacturer's outline and mounting dimensions for all field mounted devices, and scaled layout drawings for primary and supplemental control panels, including interfacing details for equipment to be supplied under DIVISION 11.
3. Manufacturer's panel color selection with color samples.
4. Complete master wiring diagrams including field wiring requirement, elementary or control schematics including coordination with other electrical devices operating in conjunction with the instrument control panels. Suitable outline drawings shall be furnished for approval before proceeding with

manufacture and shall include number of conduits and wires, size, tubing and mounting. It shall be required that this system supplier also refer to all other interrelated specifications and drawings. Therefore it is imperative that this system supplier obtains a complete set of contract specifications and drawings as part of the work and requirements of this portion of the system. Due to the complexity of the control functions, it is imperative the above drawings be clear and carefully prepared to facilitate interconnections with other equipment. Standard preprinted sheets or drawings simply marked to indicate applicability to this contract will not be acceptable.

5. The system supplier shall clearly identify any exception to the specification or drawings. Failure to do this will be grounds for rejection of the submittal.
6. The services of the instrumentation system vendor's factory engineer shall be included as part of the bid price to meet with the Engineer at his office for a minimum of two, 8-hour days to review shop drawings for this Section prior to approval by the Engineer.
7. The services of the instrumentation system vendor's factory engineer shall be included as part of the bid price to meet with the Engineer at his/her office for a minimum of one (1) eight hour day to review shop drawings with Section 11600 Design Engineer as part of this coordination.

C. For approval before release for manufacturing:

1. Instrument and control panel layout to scale or dimensioned with overall size mounting and field entries dimensioned.
2. Preliminary loop diagrams and logic diagrams in the I.S.A. & NEMA standard and shall include piping and wiring requirements for each loop.
3. All equipment to be furnished under this Section must be approved prior to any of this equipment being released for manufacturing unless otherwise noted by the Engineer.

D. Prior to final acceptance:

1. Final loop diagrams containing start-up data (to I.S.A. standard).

E. Shop drawings shall be submitted in accordance with the Supplemental General Conditions and include the following special conditions:

1. All material submitted for review shall be contained in one submission. The material shall be furnished in bound volumes as required for a complete

submittal. Loose material submitted will not be reviewed. Partial submittals unless agreed to by the Engineer will not be reviewed. Sales bulletins or other general publications are not acceptable as submittals.

2. One set of reproducible drawings, size 22 inches x 34 inches. The Engineer reserves the right to accept or reject half size (11" x 17") reproducibles in lieu of 22 inches x 34 inches. Half size copies shall be bound with each copy of the submittal.
  3. If more than two submittals (initial submittal and one re-submittal) are required for approval, the system supplier shall be liable for back charges for the Engineer's services to review additional submittals.
  4. The instrumentation manufacturer shall furnish a complete set of the final approved wiring diagrams to the electrical contractor and supplier of filtration equipment.
- F. Shop drawing review period for this section shall extend beyond the specified period as defined under for General Conditions section of this contract. Due to the complexity of the system the review period allowed shall be a minimum of 45 days unless otherwise agreed to by the Engineer.
- G. Operation and Maintenance Manuals shall be submitted in accordance with the requirements of Section 01730 (Operation and Maintenance Data).

### 1.3 RESPONSIBILITY FOR EQUIPMENT

- A. The Contractor shall be responsible for furnishing, installing, and placing in satisfactory operation all instruments, appurtenant process equipment, piping, and accessories, and shall coordinate all instrumentation, telephone modems, and Ethernet communication system equipment, analytical equipment, computer hardware, software, and peripherals, etc., to guarantee a complete and operational system. All panels, instruments, signal conditioners, switches and other devices, including computer equipment and software, shall be furnished by the same supplier.
- B. System responsibility, under Section 13321 (Instrumentation and Control System) and 13322 (Supervisory Controls and Data Acquisition), shall be by a single instrument manufacturer. All instruments, equipment, panels, and computer hardware and software shall be provided by a single instrument system supplier. The system supplier shall be responsible to the Contractor for satisfactory startup, testing, calibration, operator training and successful operation of the entire integrated system.
- C. The Contractor shall coordinate the work of the system supplier's service personnel during construction, testing, start-up, calibration and acceptance of the system.



- D. The system supplier shall have in his employ the capable personnel for detail engineering, coordination, drafting, procurement and expediting, scheduling, construction inspection, installation, start-up service for calibration and commissioning, as specified and warranty compliance for the period specified.
- E. The instrumentation and control system supplier shall provide for complete operation of all signals from "point to point" and shall assure complete compatibility of all equipment specified herein in DIVISION 11 - EQUIPMENT. It shall be the instrumentation and control system supplier's sole responsibility to resolve any and all interconnecting and interfacing problems in order to provide a completely integrated and operational system. The instrumentation and control system supplier shall provide all necessary coordination with DIVISION 16 - ELECTRICAL in providing the proper I/O (Input/Output) required at all locations for a complete system.
- F. The supervisory service of a factory-trained service engineer, specifically trained on the type of equipment specified herein, shall be provided during construction to assist the Contractor in the location of sleeves, method of installing conduit and special cable, mounting, piping and wiring of each type of device and the method of protecting all of the equipment prior to placing it into service.
- G. It is the responsibility of the Contractor to assure that all instrumentation furnished under DIVISION 11 - EQUIPMENT is coordinated with equipment, hardware and software furnished under this Section. All primary sensing elements, transmitters, analyzers, and associated instruments being furnished under DIVISION 11 - EQUIPMENT shall be of the same manufacturer. It shall be this Contractor's responsibility, at the time of the bidding, to coordinate with the suppliers of each of these sections in order to assure that this requirement is upheld. Both suppliers shall agree, at the time of submitting their bids, that their bid prices reflect this requirement. Failure to meet this requirement, which results in any additional costs for this equipment, shall be the responsibility of this Contractor at no additional cost to the Owner. No exceptions shall be allowed.

#### 1.4 DESIGN CRITERIA

- A. All instrumentation shall meet or exceed I.S.A. Standards and Recommended Practices, ANSI, National Electrical Code, OSHA, and any other applicable code or local regulation. All panel instruments shall be of the same manufacturer and model type to provide uniform appearance.

#### 1.5 INSTRUMENTATION SYSTEM SUPPLIER

- A. The Instrumentation and Control System Supplier shall be the following with no substitutions allowed.
  - 1. The following are pre-qualified Instrumentation and Control Contractors.

- a. R.E. Erickson Co.,  
Inc. Walpole,  
Massachusetts 508-  
668-9330
- b. NIC Systems  
Corporation Cromwell,  
CT 06416  
860-529-0110
- c. Electrical Installations, Inc.  
Center Harbor, New  
Hampshire 603-253-4525
- d. Harbor Controls  
North Kingstown,  
RI 401-667-0930

## 1.6 SYSTEM DESCRIPTION

- A. Each loop description contains the basic functional description of the process. All components necessary to complete these functions shall be provided to satisfy the requirements of this section.
- B. Contacts referred to in the Loop Descriptions shall be "dry" type either normally open or normally closed as required for the function described. All contacts shall be rated 10 ampere at 120 volts.
- C. The scales of instruments and devices described in the instrument loop descriptions shall be as specified and noted in the Instrument List. All indicator scales shall read out in appropriate "Engineering" units. In cases where this information is not provided this shall be clarified and coordinated with the Engineer.
- D. Loop descriptions (and associated Loop Drawings) are intended to provide a conceptual overview of required system operation. Each of the loops may or may not show all specific components necessary for each system operation. The instrumentation system supplier shall provide all necessary equipment, devices, components, signal conditioners, software, and other requirements for complete and satisfactory system operation. The system supplier shall provide all necessary current-to-current converters (I/I's) required by loop description to provide proper signal loading.
- E. All signal interfacing compatibility is the responsibility of the supplier of equipment

under Section 13300 (Instrumentation and Control System) and requires close coordination and cooperation with the supplier of equipment under DIVISION 11 - EQUIPMENT. In the loop description, any equipment or device which is not noted but shown elsewhere on loop drawings, specifications, etc. shall be provided by this system supplier in its entirety. Anything that is not shown on the drawings but is mentioned anywhere in the specifications or vice versa, or anything not expressly set forth in either but which is reasonably implied, shall be furnished and performed as though specified, shown and mentioned in both. If an item appears in one area of the contract documents but not in another, it shall be provided in its entirety. This system supplier shall obtain and review complete copies of both the specifications and drawings prior to submitting final costs for the work of this section and/or any related sections. Any discrepancies shall be brought to the attention of the Engineer prior to submission of the final bid price in order to clarify any and all issues.

#### 1.7 INSTRUMENTATION LOOP DESCRIPTIONS

- A. See DIVISION 11 - EQUIPMENT for loops relating to the DIVISION 11 – EQUIPMENT and systems. These loops are not part of this section, but the supplier of equipment under this section shall coordinate and cooperate with the supplier of equipment under DIVISION 11 – EQUIPMENT, and provide appropriate signal conditioning, signal isolation and/or signal amplification, as specified herein or otherwise required to make a complete and satisfactory, totally compatible and integrated system. The supplier of equipment under this section shall insure total compatibility and functionality of all required signal/communication interfacing between equipment under this section and equipment under DIVISION 11 – EQUIPMENT.

#### 1.8 GENERAL MONITORING AND CONTROL REQUIREMENTS

- A. PLC programs shall be configured to allow operators, with the appropriate security clearance, to modify set points, pump sequencing, timer settings, etc. readily using the OITs as described herein or SCADA display screen. PLC programs shall be configured to allow logic modification by an operator, with the appropriate security clearance, using the programming devices and software provided under this Contract.
- B. Control logic, alarm logic and totalization calculations shall be executed via the PLC programs and not the OIT or SCADA graphic display software.
- C. Discrete alarms shall be configured with adjustable time delays (initially set at 3 seconds). Each discrete alarm time delay shall be independently adjustable.
- D. Analog inputs shall be provided with high and low alarm set points initially set at 80% and 20% of span, respectively, unless otherwise noted. High alarm set point dead bands shall default to a range from the set point to 3% of span below the set point unless plant personnel enter a different value. Low alarm set point dead bands shall default to a range from the set point to 3% of span above the set point unless plant

personnel enter a different value. Each alarm dead band shall be independently adjustable.

- E. Controlled equipment shall require two positive selections of the control action by an operator before the command is executed.
- F. Sequential operations and sequential logic shall incorporate timers to alarm an incomplete sequence or malfunction. An alarm shall be generated if a required action or sequence of actions is not completed within an adjustable time period.
- G. Alarm set points, dead bands and time delays shall be accessible from the OITs as applicable to the process or the SCADA display screen by an operator with the appropriate security clearance.
- H. An operator must acknowledge an alarm displayed at the OITs as applicable to the process or the SCADA display screen before it clears. Alarm and acknowledgement logic shall follow the ISA S18.1 standard for manual reset (sequence M, Manual Reset).
- I. All motors, valves and mechanical equipment shall have an “available” status indicator when the device is available for remote automatic or manual control. Provide an alarm to notify plant personnel when a component becomes “unavailable.”
- J. Equipment shall be restarted either automatically or manually, as determined by the Engineer and Owner. Equipment shall fail in last position, or an Owner and Engineer determined safe position.
- K. Equipment shall be manually controlled either locally or remotely through the OIT as applicable to the process and the SCADA display screen unless otherwise indicated.
- L. The control including equipment, programming, configuration, ect. for control panels, processes, and equipment stated as future shall be provided under this contract

## 1.9 CONTROL PANEL LOOP DESCRIPTIONS

### A. LOOP 0001: MTU-CP PANEL POWER FAILURE

- 1. Loss of 120 VAC power to the new MTU-CP control panel (JAL-0001) shall be annunciated at the SCADA HMI.

### B. LOOP 0002: MTU-CP 24VDC POWER SUPPLY FAILURE

- 1. A 24 VDC power supply failure in the new MTU-CP control panel (JAL-0002) shall be annunciated at the SCADA HMI.

- C. LOOP 0003: RTU-2 PANEL POWER FAILURE
  - 1. Loss of 120 VAC power to the new RTU-2 control panel (JAL-0003) shall be annunciated at the SCADA HMI.
  
- D. LOOP 0004: RTU-2 24VDC POWER SUPPLY FAILURE
  - 1. A 24 VDC power supply failure in the new RTU-2 control panel (JAL-0004) shall be annunciated at the SCADA HMI.
  
- E. LOOP 0005: RTU-3 PANEL POWER FAILURE
  - 1. Loss of 120 VAC power to the new RTU-3 control panel (JAL-0005) shall be annunciated at the SCADA HMI.
  
- F. LOOP 0006: RTU-3 24VDC POWER SUPPLY FAILURE
  - 1. A 24 VDC power supply failure in the new RTU-3 control panel (JAL-0006) shall be annunciated at the SCADA HMI.
  
- G. LOOP 0007: RTU-4A PANEL POWER FAILURE
  - 1. Loss of 120 VAC power to the new RTU-4A control panel (JAL-0007) shall be annunciated at the SCADA HMI.
  
- H. LOOP 0008: RTU-4A 24VDC POWER SUPPLY FAILURE
  - 1. A 24 VDC power supply failure in the new RTU-4A control panel (JAL-0008) shall be annunciated at the SCADA HMI.
  
- I. LOOP 0009: RTU-4B PANEL POWER FAILURE
  - 1. Loss of 120 VAC power to the new RTU-4B control panel (JAL-0009) shall be annunciated at the SCADA HMI.
  
- J. LOOP 0010: RTU-4B 24VDC POWER SUPPLY FAILURE
  - 1. A 24 VDC power supply failure in the new RTU-4B control panel (JAL-0010) shall be annunciated at the SCADA HMI.
  
- K. LOOP 0011: RTU-5 PANEL POWER FAILURE

1. Loss of 120 VAC power to the new RTU-5 control panel (JAL-0011) shall be annunciated at the SCADA HMI.

L. LOOP 0012: RTU-5 24VDC POWER SUPPLY FAILURE

1. A 24 VDC power supply failure in the new RTU-5 control panel (JAL-0012) shall be annunciated at the SCADA HMI.

M. LOOP 0013: RTU-7 PANEL POWER FAILURE

1. Loss of 120 VAC power to the new RTU-5 control panel (JAL-0013) shall be annunciated at the SCADA HMI.

N. LOOP 0014: RTU-7 24VDC POWER SUPPLY FAILURE

1. A 24 VDC power supply failure in the new RTU-5 control panel (JAL-0014) shall be annunciated at the SCADA HMI.

1.10 INFLUENT AND HEADWORKS LOOP DESCRIPTIONS

A. LOOP 1001: PLANT INFLUENT FLOW

1. The plant influent flow is being measured by an flow indicating transmitter (FIT- 1001) that is located at the collection system main lift pump station and is will be available to the MTU-PLC and over the existing city wide SCADA fiber optic communications network. The flow rate shall be indicated and trended at all of the OITs and SCADA HMI. The SCADA system shall record the signal (FIR- 1001).
2. Four flow totals shall be computed and displayed at the OIT and SCADA HMI.
  - a. Non-resettable total (FQI-106A)
  - b. Previous days total (FQI-106B)
  - c. Current days total (FQI-106C), automatically reset daily
  - d. Resettable total (FQI-106D)

B. LOOP 1100: LIME SYSTEM

1. The operation of the Lime System is through a manufacture supplied PLC based control panel, See Section 11345. All controls, alarms and indications data shall be transmitted via an Ethernet data exchange and displayed and trended at the SCADA HMI.
2. The following signal shall be made available to the Lime Control system via the Ethernet network connection:
  - a. Plant Influent Flow Rate (FIT-1001)
  - b. Train #1 Anoxic Selector #3 pH Level (AIT-3502)
  - c. Train #1 Aerobic Zone #2 pH Level (AIT-3506)
  - d. Train #2 Anoxic Selector #3 pH Level (AIT-3522)
  - e. Train #2 Aerobic Zone #2 pH Level (AIT-3526)

C. LOOP 1201: GRIT BLOWER #1

1. The Grit Blower #1 is controlled via a wall mounted motor starter. Operation of the Grit Blower shall be monitored and controlled automatically through the the MTU PLC via hardwired I/O in RTU-7. The Blower has a Hand/Off/Auto selector switch at a local operator station. When in the “Auto” position the remote automatic control and remote manual control through the SCADA HMI and the RTU-7 OIT is enabled.
2. The following control, status and alarm signals shall be wired to the PLC I/O and displayed at the SCADA HMI and the RTU-7 OIT:
  - a. Grit Blower #1 HOA switch in “Auto” position (YI-1201A)
  - b. Grit Blower #1 run status (YI-1201B)
  - c. Grit Blower #1 Start/Stop (YS-1201)
  - d. Grit Blower #1 Overload (YA-1201)
  - e. Grit Blower #1 high discharge pressure alarm (PSH-1201)
  - f. Grit Blower #1 low suction pressure alarm (PSL-1201)

- g. Grit Blower #1 emergency stop (YI-1201C)
  - 3. Non-resettable elapsed time meter shall be displayed at the SCADA HMI (KQI- 1201).
  - 4. A motor state disagreement alarm shall be displayed at the SCADA HMI if the called state of the motor and the state of the run status contact do not agree after a preset adjustable time (YA-1201A). The disagreement alarm is enabled if the H/O/A switch is in the “Auto” position. The disagreement alarm must be manually reset through the SCADA HMI before Remote Automatic Control and Remote Manual Control is enabled.
  - 5. Remote Automatic – When placed in automatic mode the Blower shall start (YS- 1201) and continuously run until removed from automatic mode.
  - 6. Remote Manual Control: The Blower is manually start/stopped (YS-1201) via the SCADA HMI and the RTU-7 OIT.
- D. LOOP 1202: GRIT BLOWER #2
- 1. Functionally identical to Loop 1201.
- E. LOOP 1203: GRIT BLOWER #1 INLET FILTER PRESSURE
- 1. The Grit Blower #1 inlet filter pressure shall be measured by a pressure transmitter that produces a 4-20ma signal proportional to the air differential pressure level (PIT-1203) and shall be monitored by the MTU PLC via hardwired I/O in RTU-7. The pressure level shall be indicated and trended at the SCADA HMI and the RTU-7 OIT. The SCADA system shall record the signal (PIR- 1203).
- F. LOOP 1204: GRIT BLOWER #2 INLET FILTER PRESSURE
- 1. Functionally identical to Loop 1203.
- G. LOOPS 1300: SCREENINGS SYSTEM
- 1. The operation of the Screenings System is through a manufacture supplied PLC based control panel, See Section 11330. All controls, alarms and indications data shall be transmitted via an Ethernet data exchange and displayed and trended at the SCADA HMI.
- H. LOOP 1306: HEADWORKS GAS DETECTION ALARMS



1. The following alarms shall be monitored by the MTU PLC via hardwired I/O in RTU-7 and displayed/annunciated at the SCADA HMI:
  - a. High combustion gas alarm (YA-1306A)
  - b. High toxic gas alarm (YA-1306B)
  - c. Low Oxygen alarm (YA-1306C)
2. The following alarm indications shall be hardwired to the gas controller.
  - a. Gas Alarm Horn (YH-1306)
  - b. Gas Alarm Beacon (YL-1306A)
  - c. Gas Alarm Beacon (YL-1306B)

#### 1.11 PRIMARY TREATMENT LOOP DESCRIPTIONS

##### A. LOOP 2101: PRIMARY CLARIFIER #1

1. The Primary Clarifier #1 is controlled via a wall mounted motor starter. Operation of the Clarifier shall be monitored and controlled automatically through the MTU PLC via hardwired I/O in RTU-2. The Clarifier has a Hand/Off/Auto selector switch at a local operator station. When in the "Auto" position the remote automatic control and remote manual control through the SCADA HMI and the RTU-2 OIT is enabled.
2. The following control, status and alarm signals shall be wired to the PLC I/O and displayed at the SCADA HMI and RTU-2 OIT:
  - a. Primary Clarifier #1 HOA switch in "Auto" position (YI-2101A)
  - b. Primary Clarifier #1 run status (YI-2101B)
  - c. Primary Clarifier #1 Start/Stop (YS-2101)
  - d. Primary Clarifier #1 Overload (YA-2101)
  - e. Primary Clarifier #1 high torque alarm (WSH-2101)

- f. Primary Clarifier #1 emergency stop (YI-2101C)
  - 3. Non-resettable elapsed time meter shall be displayed at the SCADA HMI (KQI- 2101).
  - 4. A motor state disagreement alarm shall be displayed at the SCADA HMI if the called state of the motor and the state of the run status contact do not agree after a preset adjustable time (YA-2101A). The disagreement alarm is enabled if the H/O/A switch is in the “Auto” position. The disagreement alarm must be manually reset through the SCADA HMI before Remote Automatic Control and Remote Manual Control is enabled.
  - 5. Remote Automatic – When placed in automatic mode the Clarifier shall start (YS-2101) and continuously run until removed from automatic mode.
  - 6. Remote Manual Control: The Clarifier is manually start/stopped (YS-2101) via the SCADA HMI and the RTU-2 OIT.
- B. LOOP 2102: PRIMARY CLARIFIER #2
- 1. Functionally identical to Loop 2101.
- C. LOOP 2103: PRIMARY CLARIFIER #3
- 1. Functionally identical to Loop 2101.
- D. LOOP 2104: PRIMARY CLARIFIER #4
- 1. Functionally identical to Loop 2101.
- E. LOOP 2201: PRIMARY SLUDGE PUMP #1
- 1. The Primary Sludge Pump #1 is controlled via a enclosed VFD. Operation of the Primary Sludge Pump shall be monitored and controlled automatically through the MTU PLC via hardwired I/O in RTU-2. The Pump has a Hand/Off/Auto selector switch at a local operator station, when in the “Auto” position the remote automatic control and remote manual control through the SCADA HMI and the RTU-2 OIT is enabled
  - 2. The following control, status and alarm signals shall be wired to the PLC I/O and displayed at the SCADA HMI and RTU-2 OIT:

- a. Primary Sludge Pump #1 H/O/A selector switch in “Auto” (YI-2201A)
  - b. Primary Sludge Pump #1 Run status (YI-2201B)
  - c. Primary Sludge Pump #1 Start/stop pump (YS-2201)
  - d. Primary Sludge Pump #1 speed feedback (SI-2201)
  - e. Primary Sludge Pump #1 speed control (SC-2201)
  - f. Primary Sludge Pump #1 Motor High Temperature (TSH-2201)
  - g. Primary Sludge Pump #1 VFD Alarm (YA-2201)
  - h. Primary Sludge Pump #1 emergency stop (YI-2201C)
  - i. Primary Sludge Pump #1 Water Seal Failure (PSH-2201)
3. Non-resettable elapsed time meter shall be displayed at the OIT and SCADA HMI (KQI-2201).
  4. A motor state disagreement alarm shall be displayed at the OIT and SCADA HMI if the called state of the motor and the state of the run status contact do not agree after a preset adjustable time (YA-2201A). The disagreement alarm is enabled if the H/O/A switch is in the “Auto” position. The disagreement alarm must be manually reset through the SCADA HMI or the RTU-2 OIT before Remote Control is enabled.
  5. Remote Automatic Flow Control: The Primary Sludge Pump shall automatically operate from a cycle timer (KC-2201) with adjustable on-state and off-state durations. At the beginning on-state of the pump is called to start (YS-2201) and shall run for duration of the on-state timer. The Primary Sludge Pump shall have an alternate/lead/lag configuration with Pump #2, Pump #3, and Pump #4 where the lead pump(s) are the next pump to cycle and the lag pump(s) are acting as backup in case of a lead pump alarm (YA-2201) or failure (YA-2201A). A SCADA HMI and RTU-2 OIT operator selection switch allows selection of the lead and lag pumps along with operator configuration alternate operation cycles. The VFD speed command (SC-2201) is automatically controlled to maintain the primary sludge flow (FIT-2205) to an operator configured flow setpoint divided by the number of Primary Sludge Pumps running (YI-2201B, YI-2202B, YI- 2203B, & YI-2204B). A pump must be in “Auto Position” to be designated as a lead pump.

6. Remote Automatic Manual Speed Control: Functional identical to the Remote Automatic Flow Control except the VFD speed command (SC-2201) is not based on flow and is manually set via the SCADA HMI and the RTU-2 OIT.
  7. Remote Manual Control: The Primary Sludge Pump is manually start/stopped (YS-2201) and VFD speed command (SC-2201) via the SCADA HMI and the RTU-2 OIT.
- F. LOOP 2202: PRIMARY SLUDGE PUMP #2
1. Functionally identical to Loop 2201.
- G. LOOP 2203: PRIMARY SLUDGE PUMP #3
1. Functionally identical to Loop 2201.
- H. LOOP 2204: PRIMARY SLUDGE PUMP #4
1. Functionally identical to Loop 2201.
- I. LOOP 2205: PRIMARY SLUDGE FLOW
1. The Primary Sludge Flow shall be measured by an magnetic flow meter that produces a 4-20ma signal proportional to the sludge flow (FE/FIT-2205) and shall be monitored by the MTU PLC via hardwired I/O in RTU-2. The sludge flow shall be indicated and trended at the SCADA HMI and the RTU-2 OIT. The SCADA system shall record the signal (FIR-2205).
  2. Four flow totals shall be computed and displayed at the SCADA HMI.
    - a. Non-resettable total (FQI-2205A)
    - b. Previous days total (FQI-2205B)
    - c. Current days total (FQI-2205C), automatically reset daily
    - d. Resettable total (FQI-2205D)
- J. LOOP 2301: PRIMARY SCUM PUMP #1
1. The Primary Scum Pump #1 is controlled via a wall mounted motor starter.

Operation of the Scum Pump shall be monitored and controlled automatically through the MTU PLC via hardwired I/O in RTU-2. The Scum Pump has a Hand/Off/Auto selector switch at a local operator station. When in the “Auto” position the remote automatic control and remote manual control through the SCADA HMI and the RTU-2 OIT is enabled.

2. The following control, status and alarm signals shall be wired to the PLC I/O and displayed at the SCADA HMI and the RTU-2 OIT:
  - a. Primary Scum Pump #1 HOA switch in “Auto” position (YI-2301A)
  - b. Primary Scum Pump #1 run status (YI-2301B)
  - c. Primary Scum Pump #1 Start/Stop (YS-2301)
  - d. Primary Scum Pump #1 Overload (YA-2301)
  - e. Primary Scum Pump #1 high motor temperature alarm (TSH-2301)
  - f. Primary Scum Pump #1 emergency stop (YI-2301C)
3. Non-resettable elapsed time meter shall be displayed at the SCADA HMI (KQI- 2301).
4. A motor state disagreement alarm shall be displayed at the SCADA HMI if the called state of the motor and the state of the run status contact do not agree after a preset adjustable time (YA-2301A). The disagreement alarm is enabled if the H/O/A switch is in the “Auto” position. The disagreement alarm must be manually reset through the SCADA HMI or the RTU-2 OIT before Remote Automatic Control and Remote Manual Control is enabled.
5. Remote Automatic – The Primary Scum Pump shall automatically start (YS-2301) when the level in the Scum Well #1 (LIT-2303) exceeds an operator configurable level set point and will continue to run until the Scum Well #1 level drops below an operator adjustable level set point.
6. Remote Manual Control: The Primary Scum Pump is manually start/stopped (YS-2301) via the SCADA HMI and the RTU-2 OIT.

K. LOOP 2302: PRIMARY SCUM PUMP #2

1. Functionally identical to Loop 2301.

L. LOOP 2303: PRIMARY SCUM WELL #1 LEVEL

1. The Primary Scum Well #1 level shall be measured by an ultrasonic level transmitter that produces a 4-20ma signal proportional to the well level (LE/LIT- 2303) and shall be monitored by the MTU PLC via hardwired I/O in RTU-2. The well level shall be indicated and trended at the SCADA HMI and the RTU-2 OIT. The SCADA system shall record the signal (LIR-2303).

M. LOOP 2304: PRIMARY SCUM WELL #2 LEVEL

1. Functionally identical to Loop 2303.

1.12 BIOLOGICAL TREATMENT LOOP DESCRIPTIONS

A. LOOP 3101: PRE-ANOXIC MIXER

1. The Pre-Anoxic Mixer will be controlled via a motor starter located in a motor control center. Operation of the Mixer shall be monitored and controlled automatically through the MTU PLC via hardwired I/O in RTU-3. The Mixer has a Hand/Off/Auto selector switch at a local operator station. When in the “Auto” position the remote automatic control and remote manual control through the SCADA HMI and the RTU-3 OIT is enabled.
2. The following control, status and alarm signals shall be wired to the PLC I/O and displayed at the SCADA HMI and RTU-3 OIT:
  - a. Pre-Anoxic Mixer HOA switch in “Auto” position (YI-3101A)
  - b. Pre-Anoxic Mixer run status (YI-3101B)
  - c. Pre-Anoxic Mixer Start/Stop (YS-3101)
  - d. Pre-Anoxic Mixer Overload (YA-3101)
  - e. Pre-Anoxic Mixer seal leak alarm (MSH-3101)
  - f. Pre-Anoxic Mixer motor high temperature (TSH-3101)
  - g. Pre-Anoxic Mixer emergency stop (YI-3101C)
3. Non-resettable elapsed time meter shall be displayed at the SCADA HMI (KQI- 3101).

4. A motor state disagreement alarm shall be displayed at the SCADA HMI if the called state of the motor and the state of the run status contact do not agree after a preset adjustable time (YA-3101A). The disagreement alarm is enabled if the H/O/A switch is in the “Auto” position. The disagreement alarm must be manually reset through the SCADA HMI before Remote Automatic Control and Remote Manual Control is enabled.
5. Remote Automatic – When placed in automatic mode the Mixer shall start (YS- 3101) and continuously run until removed from automatic mode.
6. Remote Manual Control: The Mixer is manually start/stopped (YS-3101) via the SCADA HMI and the RTU-3 OIT.

B. LOOP 3111: TRAIN #1 ANOXIC SELECTOR MIXER #1

1. The Train #1 Anoxic Selector Mixer #1 will be controlled via a motor starter located in a motor control center. Operation of the Mixer shall be monitored and controlled automatically through the MTU PLC via hardwired I/O in RTU-3. The Mixer has a Hand/Off/Auto selector switch at a local operator station. When in the “Auto” position the remote automatic control and remote manual control through the SCADA HMI and the RTU-3 OIT is enabled.
2. The following control, status and alarm signals shall be wired to the PLC I/O and displayed at the SCADA HMI and RTU-3 OIT:
  - a. Train #1 Anoxic Mixer #1 HOA switch in “Auto” position (YI-3111A)
  - b. Train #1 Anoxic Mixer #1 run status (YI-3111B)
  - c. Train #1 Anoxic Mixer #1 Start/Stop (YS-3111)
  - d. Train #1 Anoxic Mixer #1 Overload (YA-3111)
  - e. Train #1 Anoxic Mixer #1 seal leak alarm (MSH-3111)
  - f. Train #1 Anoxic Mixer #1 motor high temperature (TSH-3111)
  - g. Train #1 Anoxic Mixer #1 emergency stop (YI-3111C)
3. Non-resettable elapsed time meter shall be displayed at the SCADA HMI (KQI- 3111).

4. A motor state disagreement alarm shall be displayed at the SCADA HMI if the called state of the motor and the state of the run status contact do not agree after a preset adjustable time (YA-3111A). The disagreement alarm is enabled if the H/O/A switch is in the “Auto” position. The disagreement alarm must be manually reset through the SCADA HMI before Remote Automatic Control and Remote Manual Control is enabled.
  5. Remote Automatic – When placed in automatic mode the Mixer shall start (YS- 3111) and continuously run until removed from automatic mode.
  6. Remote Manual Control: The Mixer is manually start/stopped (YS-3111) via the SCADA HMI and the RTU-3 OIT.
- C. LOOP 3112: TRAIN #1 ANOXIC SELECTOR MIXER #2
1. Functionally identical to Loop 3111.
- D. LOOP 3113: TRAIN #1 ANOXIC SELECTOR MIXER #3
1. Functionally identical to Loop 3111.
- E. LOOP 3131: SECONDARY ANOXIC TANK #1 MIXER #1
1. Functionally identical to Loop 3111.
- F. LOOP 3132: SECONDARY ANOXIC TANK #1 MIXER #2
1. Functionally identical to Loop 3111.
- G. LOOP 3141: RE-AERATION TANK #1 ~~SURFACE AERATOR MIXER~~#1
1. The Re-Aeration Tank #1 ~~Surface Aerator Mixer~~ #1 will be controlled via an enclosed VFD. Operation of the ~~Surface Aerator Mixer~~ shall be monitored and controlled automatically through the MTU PLC via hardwired I/O in RTU-3. The Aerator has a Hand/Off/Auto selector switch at a local operator station, when in the “Auto” position the remote automatic control and remote manual control through the SCADA HMI and the RTU-3 OIT is enabled.



2. The following control, status and alarm signals shall be wired to the PLC I/O and displayed at the SCADA HMI and RTU-3 OIT:
  - a. Re-Aeration Tank #1 ~~Surface Aerator Mixer~~ #1 H/O/A selector switch in “Auto” (YI-3141A)
  - b. Re-Aeration Tank #1 ~~Surface Aerator Mixer~~ #1 Run status (YI-3141B)
  - c. Re-Aeration Tank #1 ~~Surface Aerator Mixer~~ #1 Start/stop pump (YS-3141)
  - d. Re-Aeration Tank #1 ~~Surface Aerator Mixer~~ #1 speed feedback (SI-3141)
  - e. Re-Aeration Tank #1 ~~Surface Aerator Mixer~~ #1 speed control (SC-3141)
  - f. Re-Aeration Tank #1 ~~Surface Aerator Mixer~~ #1 Motor High Temperature (TSH-3141)
  - g. Re-Aeration Tank #1 ~~Surface Aerator Mixer~~ #1 VFD Alarm (YA-3141)
  - h. Re-Aeration Tank #1 ~~Surface Aerator Mixer~~ #1 emergency stop (YI-3141C)
3. Non-resettable elapsed time meter shall be displayed at the OIT and SCADA HMI (KQI-3141).
4. A motor state disagreement alarm shall be displayed at the OIT and SCADA HMI if the called state of the motor and the state of the run status contact do not agree after a preset adjustable time (YA-3141A). The disagreement alarm is enabled if the H/O/A switch is in the “Auto” position. The disagreement alarm must be manually reset through the SCADA HMI or the RTU-3 OIT before Remote Control is enabled.
5. Remote Automatic Control: The ~~Surface Aerator Mixer~~ shall continuously operate (YS- 3141). The VFD speed command (SC-3141) is automatically controlled to maintain the tanks Dissolved Oxygen level (AIT- 35121) to an operator adjustable setpoint.
6. Remote Manual Control: The ~~Surface Aerator Mixer~~ is manually start/stopped (YS- 3141) and VFD speed command (SC-3141) is manually entered via the

SCADA HMI and the RTU-3 OIT.

- H. LOOP 3142: RE-AERATION TANK #1 ~~SURFACE AERATOR MIXER~~ #2
  - 1. Functionally identical to Loop 3141.
  
- I. LOOP 3143: RE-AERATION TANK #1 ~~SURFACE AERATOR MIXER~~ #3
  - 1. Functionally identical to Loop 3141.
  
- IA. LOOP 3144: RE-AERATION #1 BLOWER #1
  - 1. The Re-Aeration Tank #1 Blower #1 will be controlled via a motor starter located in a motor control center. Operation of the Blower shall be monitored and controlled automatically through the MTU PLC via hardwired I/O in RTU-3. The Blower has a Hand/Off/Auto selector switch at a local operator station. When in the “Auto” position the remote automatic control and remote manual control through the SCADA HMI and the RTU-3 OIT is enabled.
  
  - 2. The following control, status and alarm signals shall be wired to the PLC I/O and displayed at the SCADA HMI and RTU-3 OIT:
    - a. Re-Aeration Tank #1 Blower #1 HOA switch in “Auto” position (YI-3144A)
  
    - b. Re-Aeration Tank #1 Blower #1 run status (YI-3144B)
  
    - c. Re-Aeration Tank #1 Blower #1 Start/Stop (YS-3144)
  
    - d. Re-Aeration Tank #1 Blower #1 Overload (YA-3144)
  
    - e. Re-Aeration Tank #1 Blower #1 motor high temperature (TSH-3144)
  
    - f. Re-Aeration Tank #1 Blower #1 emergency stop (YI-3144C)
  
  - 3. Non-resettable elapsed time meter shall be displayed at the SCADA HMI (KQI- 3144).
  
  - 4. A motor state disagreement alarm shall be displayed at the SCADA HMI if the called state of the motor and the state of the run status contact do not agree

after a preset adjustable time (YA-3144A). The disagreement alarm is enabled if the H/O/A switch is in the “Auto” position. The disagreement alarm must be manually reset through the SCADA HMI before Remote Automatic Control and Remote Manual Control is enabled.

5. Remote Automatic – When placed in automatic mode the Blower shall start (YS- 3144) and continuously run until removed from automatic mode. If the Dissolved Oxygen level (AIT- 3511) goes above the operator setpoint and the Re-Aeration Mixer’s VFD speed command is at it’s minimum the Blower shall shutdown in a cascading order from Blower #3 to Blower #1 with a operator configured time delay between each shutdown until the DO level drops below the operator setpoint.
6. Remote Manual Control: The Blower is manually start/stopped (YS-3144) via the SCADA HMI and the RTU-3 OIT.

IB. LOOP 3145: RE-AERATION #1 BLOWER #2

1. Functionally identical to Loop 3144.

IC. LOOP 3146: RE-AERATION #1 BLOWER #3

1. Functionally identical to Loop 3144.

J. LOOP 3151: TRAIN #1 ANOXIC AEROBIC MIXER

1. Functionally identical to Loop 3111.

K. LOOP 3161: TRAIN #1 INTERNAL RECYCLE PUMP #1

1. The Tank #1 Internal Recycle Pump#1 will be controlled via an enclosed VFD. Operation of the Internal Recycle Pump shall be monitored and controlled automatically through the MTU PLC via hardwired I/O in RTU-3. The Pump has a Hand/Off/Auto selector switch at a local operator station, when in the “Auto” position the remote automatic control and remote manual control through the SCADA HMI and the RTU-3 OIT is enabled.
2. The following control, status and alarm signals shall be wired to the PLC I/O and displayed at the SCADA HMI and RTU-3 OIT:

- a. ~~Re-Aeration Tank #1 Surface Aerator~~ Train #1 Internal Recycle Pump #1 H/O/A selector switch in “Auto” (YI-3161A)
  - b. ~~Re-Aeration Tank #1 Surface Aerator~~ Train #1 Internal Recycle Pump #1 Run status (YI-3161B)
  - c. ~~Re-Aeration Tank #1 Surface Aerator~~ Train #1 Internal Recycle Pump #1 Start/stop pump (YS-3161)
  - d. ~~Re-Aeration Tank #1 Surface Aerator~~ Train #1 Internal Recycle Pump #1 speed feedback (SI-3161)
  - e. ~~Re-Aeration Tank #1 Surface Aerator~~ Train #1 Internal Recycle Pump #1 speed control (SC-3161)
  - f. ~~Re-Aeration Tank #1 Surface Aerator~~ Train #1 Internal Recycle Pump #1 seal leak alarm (MSH-3161)
  - g. ~~Re-Aeration Tank #1 Surface Aerator~~ Train #1 Internal Recycle Pump #1 Motor High Temperature (TSH-3161)
  - h. ~~Re-Aeration Tank #1 Surface Aerator~~ Train #1 Internal Recycle Pump #1 VFD Alarm (YA-3161)
  - i. ~~Re-Aeration Tank #1 Surface Aerator~~ Train #1 Internal Recycle Pump #1 emergency stop (YI-3161C)
3. Non-resettable elapsed time meter shall be displayed at the OIT and SCADA HMI (KQI-3161).
  4. A motor state disagreement alarm shall be displayed at the OIT and SCADA HMI if the called state of the motor and the state of the run status contact do not agree after a preset adjustable time (YA-3161A). The disagreement alarm is enabled if the H/O/A switch is in the “Auto” position. The disagreement alarm must be manually reset through the SCADA HMI or the RTU-3 OIT before Remote Control is enabled.
  5. Remote Automatic Control: The Internal Recycle Pump shall continuously operate (YS-3161). The Internal Recycle Pump #1 shall have a lead/lag configuration with Pump #2 where the lead pump is the continuous running pump and the lag pump is acting as backup in case of a lead pump alarm (YA-3161, MSH-3161, TSH-3161) or failure (YA-3151A). The VFD speed command (SC-3161) is automatically controlled automatically controlled to an operator adjustable proportional ratio to Influent Flow (FIT-1001). A pump

must be in “Auto Position” to be designated as a lead pump.

6. Remote Manual Control: The Internal Recycle Pump is manually start/stopped (YS-3161) and VFD speed command (SC-3161) is manually entered via the SCADA HMI and the RTU-3 OIT.

L. LOOP 3162: TRAIN #1 INTERNAL RECYCLE PUMP #2

1. Functionally identical to Loop 3161.

M. LOOP 3211: TRAIN #2 ANOXIC SELECTOR MIXER #1

1. Functionally identical to Loop 3111.

N. LOOP 3212: TRAIN #2 ANOXIC SELECTOR MIXER #2

1. Functionally identical to Loop 3111.

O. LOOP 3213: TRAIN #2 ANOXIC SELECTOR MIXER #3

1. Functionally identical to Loop 3111.

P. LOOP 3231: SECONDARY ANOXIC TANK #2 MIXER #1

1. Functionally identical to Loop 3111.

Q. LOOP 3232: SECONDARY ANOXIC TANK #2 MIXER #2

1. Functionally identical to Loop 3111.

R. LOOP 3241: RE-AERATION TANK #2 ~~SURFACE AERATOR MIXER~~ #1

1. Functionally identical to Loop 3141 except the VFD speed command (SC-3241) is automatically controlled automatically to maintain the tanks Dissolved Oxygen level (AIT-35321) to an operator adjustable setpoint.

- S. LOOP 3242: RE-AERATION TANK #2 ~~SURFACE AERATOR MIXER~~ #2
  - 1. Functionally identical to Loop 3241.
  
- T. LOOP 3243: RE-AERATION TANK #1 ~~SURFACE AERATOR MIXER~~ #3
  - 1. Functionally identical to Loop 3241.
  
- TA. LOOP 3244: RE-AERATION #2 BLOWER #1
  - 1. Functionally identical to Loop 3144 except the Blower is automatically shutoff based the tanks Dissolved Oxygen level (AIT-3531).
  
- TB. LOOP 3245: RE-AERATION #2 BLOWER #2
  - 1. Functionally identical to Loop 3244.
  
- TC. LOOP 3246: RE-AERATION #2 BLOWER #3
  - 1. Functionally identical to Loop 3244.
  
- U. LOOP 3251: TRAIN #2 ANOXIC AEROBIC MIXER
  - 1. Functionally identical to Loop 3111.
  
- V. LOOP 3261: TRAIN #2 INTERNAL RECYCLE PUMP #1
  - 1. Functionally identical to Loop 3161.
  
- W. LOOP 3262: TRAIN #2 INTERNAL RECYCLE PUMP #2
  - 1. Functionally identical to Loop 3161.
  
- X. LOOP 34011: TRAIN #1 BIOLOGICAL TANKS INFLUENT SLIDE GATE

1. The influent flow into the Train #1 Biological Tanks will be blocked via a ~~motorized~~ sluice gate (MGV-34011) that shall be monitored through RTU-3 PLC via hardwired I/O.
  2. The following status signals shall be wired to the PLC I/O and displayed at the SCADA HMI and RTU-3 OIT:
    - a. Gate Opened Status (ZSO-34011)
    - b. Gate Closed Status (ZSC-34011)
- Y. LOOP 34012: TRAIN #2 BIOLOGICAL TANKS INFLUENT SLIDE GATE
1. Functionally identical to Loop 34011.
- Z. LOOP 3431: SECONDARY ANOXIC TANK #1 INFLUENT SLIDE GATE
1. Functionally identical to Loop 34011.
- AA. LOOP 3432: SECONDARY ANOXIC TANK #2 INFLUENT SLIDE GATE
1. Functionally identical to Loop 34011.
- AB. LOOP 3441: RE-AERATION TANK #1 INFLUENT SLIDE GATE
1. Functionally identical to Loop 34011.
- AC. LOOP 3442: RE-AERATION TANK #2 INFLUENT SLIDE GATE
1. Functionally identical to Loop 34011.
- AD. LOOP 3443: RE-AERATION TANK #1 EFFLUENT SLIDE GATE
1. Functionally identical to Loop 34011.

AE. LOOP 3444: RE-AERATION TANK #2 EFFLUENT SLIDE GATE

1. Functionally identical to Loop 34011.

AF. LOOP 3501: TRAIN #1 ANOXIC SELECTOR #3 NO3 LEVEL

1. The Train #1 Anoxic Selector #3 Nitrate (NO3) level will be measured by an NO3 analyzer transmitter that produces a 4-20ma signal proportional to the NO3 level (AE/AIT-3501) and shall be monitored by the MTU PLC via hardwired I/O in RTU-3. The NO3 level shall be indicated and trended at the SCADA HMI and the RTU-3 OIT. The SCADA system shall record the signal (AIR-3501).

AG. LOOP 3502: TRAIN #1 ANOXIC SELECTOR #3 pH LEVEL

1. The Train #1 Anoxic Selector #3 pH level will be measured by a PH analyzer transmitter that produces a 4-20ma signal proportional to the PH level (AE/AIT-3502) and shall be monitored by the MTU PLC via hardwired I/O in RTU-3. The PH level shall be indicated and trended at the SCADA HMI and the RTU-3 OIT. The SCADA system shall record the signal (AIR-3502).

AH. LOOP 3503: TRAIN #1 ANOXIC SELECTOR #3 DO LEVEL

1. The Train #1 Anoxic Selector #3 Dissolved Oxygen (DO) level will be measured by a DO analyzer transmitter that produces a 4-20ma signal proportional to the DO level (AE/AIT-3503) and shall be monitored by the MTU PLC via hardwired I/O in RTU-3. The DO level shall be indicated and trended at the SCADA HMI and the RTU-3 OIT. The SCADA system shall record the signal (AIR-3503).

AI. LOOP 3504: TRAIN #1 AEROBIC ZONE #1 DO LEVEL

1. Functionally identical to Loop 3503.

AJ. LOOP 3505: TRAIN #1 AEROBIC ZONE #2 DO LEVEL

1. Functionally identical to Loop 3503.



AK. LOOP 3506: TRAIN #1 AEROBIC ZONE #2 pH LEVEL

1. Functionally identical to Loop 3502.

AL. LOOP 3507: TRAIN #1 AEROBIC ZONE #3 DO LEVEL

1. Functionally identical to Loop 3503.

AM. LOOP 3508: TRAIN #1 AEROBIC ZONE #3 NO3 LEVEL

1. Functionally identical to Loop 3501.

AN. LOOP 350910: TRAIN #1 AEROBIC ZONE #3 NH4 LEVEL

1. The Train #1 Aerobic Zone #3 Ammonia (NH4) level will be measured by an NH4 analyzer transmitter that produces a 4-20ma signal proportional to the NH4 level (AE/AIT-350910) and shall be monitored by the MTU PLC via hardwired I/O in RTU-3. The NH4 level shall be indicated and trended at the SCADA HMI and the RTU-3 OIT. The SCADA system shall record the signal (AIR-350910).

AO. LOOP 3511: SECONDARY ANOXIC TANK #1 DO LEVEL

1. Functionally identical to Loop 3503.

AP. LOOP 3512: SECONDARY ANOXIC TANK #1 NO3 LEVEL

1. Functionally identical to Loop 3501.

AQ. LOOP 3513: RE-AERATION TANK #1 DO LEVEL

1. Functionally identical to Loop 3503.

AR. LOOP 3521: TRAIN #2 ANOXIC SELECTOR #3 NO3 LEVEL

1. Functionally identical to Loop 3501.
- AS. LOOP 3522: TRAIN #2 ANOXIC SELECTOR #3 pH LEVEL
1. Functionally identical to Loop 3502.
- AT. LOOP 3523: TRAIN #2 ANOXIC SELECTOR #3 DO LEVEL
1. Functionally identical to Loop 3503.
- AU. LOOP 3524: TRAIN #2 AEROBIC ZONE #1 DO LEVEL
1. Functionally identical to Loop 3503.
- AV. LOOP 3525: TRAIN #2 AEROBIC ZONE #2 DO LEVEL
1. Functionally identical to Loop 3503.
- AW. LOOP 3526: TRAIN #2 AEROBIC ZONE #2 pH LEVEL
1. Functionally identical to Loop 3502.
- AX. LOOP 3527: TRAIN #2 AEROBIC ZONE #3 DO LEVEL
1. Functionally identical to Loop 3503.
- AY. LOOP 3528: TRAIN #2 AEROBIC ZONE #3 NO3 LEVEL
1. Functionally identical to Loop 3501.
- AZ. LOOP 350930: TRAIN #2 AEROBIC ZONE #3 NH4 LEVEL

1. Functionally identical to Loop 350910.

BA. LOOP 3531: SECONDARY ANOXIC TANK #2 DO LEVEL

1. Functionally identical to Loop 3503.

BB. LOOP 3532: SECONDARY ANOXIC TANK #2 NO3 LEVEL

1. Functionally identical to Loop 3501.

BC. LOOP 3533: RE-AERATION TANK #2 DO LEVEL

1. Functionally identical to Loop 3503.

BD. LOOP 1100: MICOR-C SYSTEM

1. The operation of the Mirco-C System will be through a manufacture supplied microprocessor based control panel with an OPC server. All controls, alarms and indications data shall be transmitted via an Ethernet data exchange with the Micro-C System's OPC server and displayed and trended at the SCADA HMI.
2. The following signal shall be made available to the Micro-C Control system via the Ethernet network connection:
  - a. Plant Influent Flow Rate (FIT-1001)
  - b. Train #1 Anoxic Selector #3 NO3 Level (AIT-3501)
  - c. Train #1 Aerobic Zone #3 NO3 Level (AIT-3508)
  - d. Secondary Anoxic Tank #1 NO3 Level (AIT-3512)
  - e. Train #2 Anoxic Selector #3 NO3 Level (AIT-3521)
  - f. Train #2 Aerobic Zone #3 NO3 Level (AIT-3528)
  - g. Secondary Anoxic Tank #2 NO3 Level (AIT-3532)

BE. LOOP 3611: MICRO-C TANK #1 LEVEL

1. The Micro-C Tank #1 level will be measured by an ultrasonic level transmitter that produces a 4-20ma signal proportional to the tank level (LE/LIT- 3611) and shall be monitored by the MTU PLC via hardwired I/O in RTU-3. The well level shall be indicated and trended at the SCADA HMI and the RTU-3 OIT. The SCADA system shall record the signal (LIR-3611).
2. The Micro-C Tank #1 high level will be monitored by a high level float switch (LSH-3611) that shall be hard wired to a Tank Level Alarm Station (LAH-3611).

BF. LOOP 3612: MICRO C TANK #2 LEVEL

1. Functionally identical to Loop 3611.

BG. LOOP 3613: MICRO-C TANK LEAK

1. A float switch (LSH-3613) will be located in the Micro-C Tank containment area and shall be monitored by the MTU PLC via hardwired I/O in RTU-3. Upon activation the leak shall be alarmed and indicated at SCADA HMI and RTU-3.

### 1.13 FINAL TREATMENT LOOP DESCRIPTIONS

A. LOOP 4101: FINAL CLARIFIER #1

1. The Final Clarifier #1 is controlled via a wall mounted motor starter. Operation of the Clarifier shall be monitored and controlled automatically through the MTU PLC via hardwired I/O in RTU-4A. The Clarifier has a Hand/Off/Auto selector switch at a local operator station. When in the "Auto" position the remote automatic control and remote manual control through the SCADA HMI and the RTU-4A OIT is enabled.
2. The following control, status and alarm signals shall be wired to the PLC I/O and displayed at the SCADA HMI and RTU-4A OIT:
  - a. Final Clarifier #1 HOA switch in "Auto" position (YI-4101A)
  - b. Final Clarifier #1 run status (YI-4101B)
  - c. Final Clarifier #1 Start/Stop (YS-4101)
  - d. Final Clarifier #1 Overload (YA-4101)

- e. Final Clarifier #1 high torque alarm (WSH-4101)
  - f. Final Clarifier #1 emergency stop (YI-4101C)
3. Non-resettable elapsed time meter shall be displayed at the SCADA HMI (KQI- 4101).
  4. A motor state disagreement alarm shall be displayed at the SCADA HMI if the called state of the motor and the state of the run status contact do not agree after a preset adjustable time (YA-4101A). The disagreement alarm is enabled if the H/O/A switch is in the “Auto” position. The disagreement alarm must be manually reset through the SCADA HMI or RTU-4A OIT before Remote Automatic Control and Remote Manual Control is enabled.
  5. Remote Automatic – When placed in automatic mode the Clarifier shall start (YS-4101) and continuously run until removed from automatic mode.
  6. Remote Manual Control: The Clarifier is manually start/stopped (YS-4101) via the SCADA HMI and the RTU-4A OIT.
- B. LOOP 4102: FINAL CLARIFIER #2
1. Functionally identical to Loop 4101.
- C. LOOP 4111: RAS SLUDGE PUMP #1
1. The RAS Sludge Pump #1 is controlled via a enclosed VFD. Operation of the RAS Sludge Pump shall be monitored and controlled automatically through the MTU PLC via hardwired I/O in RTU-4A. The Pump has a Hand/Off/Auto selector switch at a local operator station, when in the “Auto” position the remote automatic control and remote manual control through the SCADA HMI and the RTU-4A OIT is enabled.
  2. The following control, status and alarm signals shall be wired to the PLC I/O and displayed at the SCADA HMI and RTU-4A OIT:
    - a. RAS Sludge Pump #1 H/O/A selector switch in “Auto” (YI-4111A)
    - b. RAS Sludge Pump #1 Run status (YI-4111B)
    - c. RAS Sludge Pump #1 Start/stop pump (YS-4111)
    - d. RAS Sludge Pump #1 speed feedback (SI-4111)

- e. RAS Sludge Pump #1 speed control (SC-4111)
  - f. RAS Sludge Pump #1 Motor High Temperature (TSH-4111)
  - g. RAS Sludge Pump #1 VFD Alarm (YA-4111)
  - h. RAS Sludge Pump #1 emergency stop (YI-4111C)
  - i. RAS Sludge Pump #1 Water Seal Failure (PSH-4111)
3. Non-resettable elapsed time meter shall be displayed at the OIT and SCADA HMI (KQI-4111).
  4. A motor state disagreement alarm shall be displayed at the OIT and SCADA HMI if the called state of the motor and the state of the run status contact do not agree after a preset adjustable time (YA-4111A). The disagreement alarm is enabled if the H/O/A switch is in the “Auto” position. The disagreement alarm must be manually reset through the SCADA HMI or the RTU-4A OIT before Remote Control is enabled.
  5. Remote Automatic RAS Flow Control: The RAS Sludge Pump shall continuously operate (YS-4111). The RAS Sludge Pump shall have a lead/lag configuration with Pump #2 and Pump #3 where the lead pump(s) are the continuous running pump(s) and the lag pump(s) are acting as backup in case of a lead pump alarm (YA-4111, YI-4111C) or failure (YA-4111A). The VFD speed command (SC-4111) is automatically controlled to maintain the RAS sludge flow (FIT-4161) to an operator configured flow setpoint divided by the number of RAS Pumps running (YI-4111B, YI-4112B, & YI-4113B). A pump must be in “Auto Position” to be designated as a lead pump.
  6. Remote Automatic RAS Rate Control: Functional identical to the Remote Automatic RAS Flow Control except the VFD speed command (SC-4111) is automatically controlled to an operator adjustable proportional RAS flow rate (FIT 4161) to Influent Flow (FIT-1001) setpoint divided by the number of RAS Pumps running (YI-4111B, YI-4112B, & YI-4113B).
  7. Remote Manual Control: The RAS Sludge Pump is manually start/stopped (YS- 4111) and VFD speed command (SC-4111) is manually entered via the SCADA HMI and the RTU-4A OIT.

D. LOOP 4112: RAS SLUDGE PUMP #2

1. Functionally identical to Loop 4111.

- E. LOOP 4113: RAS SLUDGE PUMP #3
1. Functionally identical to Loop 4111.
- F. LOOP 4121: WAS SLUDGE PUMP #1
1. The WAS Sludge Pump #1 is controlled via a enclosed VFD. Operation of the WAS Sludge Pump shall be monitored and controlled automatically through the MTU PLC via hardwired I/O in RTU-4A. The Pump has a Hand/Off/Auto selector switch at a local operator station, when in the “Auto” position the remote automatic control and remote manual control through the SCADA HMI and the RTU-4A OIT is enabled.
  2. The following control, status and alarm signals shall be wired to the PLC I/O and displayed at the SCADA HMI and RTU-4A OIT:
    - a. WAS Sludge Pump #1 H/O/A selector switch in “Auto” (YI-4121A)
    - b. WAS Sludge Pump #1 Run status (YI-4121B)
    - c. WAS Sludge Pump #1 Start/stop pump (YS-4121)
    - d. WAS Sludge Pump #1 speed feedback (SI-4121)
    - e. WAS Sludge Pump #1 speed control (SC-4121)
    - f. WAS Sludge Pump #1 Motor High Temperature (TSH-4121)
    - g. WAS Sludge Pump #1 VFD Alarm (YA-4121)
    - h. WAS Sludge Pump #1 emergency stop (YI-4121C)
    - i. **WAS Sludge Pump #1 Water Seal Failure (PSH-4121)**
  3. Non-resettable elapsed time meter shall be displayed at the OIT and SCADA HMI (KQI-4121).
  4. A motor state disagreement alarm shall be displayed at the OIT and SCADA HMI if the called state of the motor and the state of the run status contact do not agree after a preset adjustable time (YA-4121A). The disagreement alarm is enabled if the H/O/A switch is in the “Auto” position. The disagreement alarm must be manually reset through the SCADA HMI or the RTU-4A OIT before Remote Control is enabled.

5. Remote Automatic Flow Control: The WAS Sludge Pump shall automatically operate from a cycle timer (KC-4121) with adjustable on-state and off-state durations. At the beginning on-state of the pump is called to start (YS-4121) and shall run for duration of the on-state timer. The VFD speed command (SC-4121) is automatically controlled to maintain the WAS sludge flow (FIT-4151) to an operator configured flow setpoint divided by the number of WAS Sludge Pumps running (YI-4121B, YI-4122B, and if applicable YI-4131B).
  6. Remote Automatic Manual Speed Control: Functional identical to the Remote Automatic Flow Control except the VFD speed command (SC-4121) is not based on flow and is manually set via the SCADA HMI and the RTU-4A OIT.
  7. Remote Manual Control: The WAS Sludge Pump is manually start/stopped (YS- 4121) and VFD speed command (SC-4121) is manually entered via the SCADA HMI and the RTU-4A OIT.
- G. LOOP 4122: WAS SLUDGE PUMP #2
1. Functionally identical to Loop 4121.
- H. LOOP 4131: FINAL SCUM PUMP #1
1. The Final Scum Pump #1 is controlled via a enclosed VFD. Operation of the Final Scum Pump shall be monitored and controlled automatically through the MTU PLC via hardwired I/O in RTU-4A. The Pump has a Hand/Off/Auto selector switch at a local operator station, when in the “Auto” position the remote automatic control and remote manual control through the SCADA HMI and the RTU-4A OIT is enabled.
  2. The following control, status and alarm signals shall be wired to the PLC I/O and displayed at the SCADA HMI and RTU-4A OIT:
    - a. Final Scum Pump #1 H/O/A selector switch in “Auto” (YI-4131A)
    - b. Final Scum Pump #1 Run status (YI-4131B)
    - c. Final Scum Pump #1 Start/stop pump (YS-4131)
    - d. Final Scum Pump #1 speed feedback (SI-4131)
    - e. Final Scum Pump #1 speed control (SC-4131)
    - f. Final Scum Pump #1 Motor High Temperature (TSH-4131)



- g. Final Scum Pump #1 VFD Alarm (YA-4131)
  - h. Final Scum Pump #1 emergency stop (YI-4131C)
  - i. Final Scum Pump #1 Water Seal Failure (PSH-4131)
3. Non-resettable elapsed time meter shall be displayed at the OIT and SCADA HMI (KQI-4131).
  4. A motor state disagreement alarm shall be displayed at the OIT and SCADA HMI if the called state of the motor and the state of the run status contact do not agree after a preset adjustable time (YA-4131A). The disagreement alarm is enabled if the H/O/A switch is in the "Auto" position. The disagreement alarm must be manually reset through the SCADA HMI or the RTU-4A OIT before Remote Control is enabled.
  5. Remote Automatic Scum Control: The Final Scum Pump shall automatically start (YS-4131) when the level in the Final Scum Well #1 (LIT-4132) exceeds an operator configurable level set point and will continue to run until the Final Scum Well #1 level drops below an operator adjustable level set point. The VFD speed command (SC-4131) is manually entered via the SCADA HMI and the RTU-4A OIT.
  6. Remote Automatic WAS Control: Functionally identical to the Remote Automatic control in Loop 4121.
  7. Remote Manual Control: The Final Scum Pump is manually start/stopped (YS-4131) and VFD speed command (SC-4131) is manually entered via the SCADA HMI and the RTU-4A OIT.

I. LOOP 4132: FINAL SCUM WELL #1 LEVEL

1. The Final Scum Well #1 level shall be measured by an ultrasonic level transmitter that produces a 4-20ma signal proportional to the well level (LE/LIT- 4132) and shall be monitored by the MTU PLC via hardwired I/O in RTU-4A. The well level shall be indicated and trended at the SCADA HMI and the RTU- 4A OIT. The SCADA system shall record the signal (LIR-4132).

J. LOOP 4151: WAS SLUDGE FLOW

1. The WAS Sludge Flow shall be measured by an ultrasonic strap on type flow meter that produces a 4-20ma signal proportional to the sludge flow (FE/FIT-

4151) and shall be monitored by the MTU PLC via hardwired I/O in RTU-4A. The sludge flow shall be indicated and trended at the SCADA HMI and the RTU- 4A OIT. The SCADA system shall record the signal (FIR-4151).

2. Four flow totals shall be computed and displayed at the SCADA HMI.
  - a. Non-resettable total (FQI-4151A)
  - b. Previous days total (FQI-4151B)
  - c. Current days total (FQI-4151C), automatically reset daily
  - d. Resettable total (FQI-4151D)

K. LOOP 4161: RAS SLUDGE FLOW

1. The RAS Sludge Flow shall be measured by an ultrasonic strap on type flow meter that produces a 4-20ma signal proportional to the sludge flow (FE/FIT-4161) and shall be monitored by the MTU PLC via hardwired I/O in RTU-4A. The sludge flow shall be indicated and trended at the SCADA HMI and the RTU- 4A OIT. The SCADA system shall record the signal (FIR-4161).
2. Four flow totals shall be computed and displayed at the RTU-4A OIT and SCADA HMI.
  - a. Non-resettable total (FQI-4161A)
  - b. Previous days total (FQI-4161B)
  - c. Current days total (FQI-4161C), automatically reset daily
  - d. Resettable total (FQI-4161D)

L. LOOP 4201: FINAL CLARIFIER #3

1. The Final Clarifier #3 is controlled via a wall mounted motor starter. Operation of the Clarifier shall be monitored and controlled automatically through the MTU PLC via hardwired I/O in RTU-4B. The Clarifier has a Hand/Off/Auto selector switch at a local operator station. When in the "Auto" position the remote automatic control and remote manual control through the SCADA HMI and the RTU-4B OIT is enabled.

2. The following control, status and alarm signals shall be wired to the PLC I/O and displayed at the SCADA HMI and RTU-4B OIT:
  - a. Final Clarifier #3 HOA switch in “Auto” position (YI-4201A)
  - b. Final Clarifier #3 run status (YI-4201B)
  - c. Final Clarifier #3 Start/Stop (YS-4201)
  - d. Final Clarifier #3 Overload (YA-4201)
  - e. Final Clarifier #3 high torque alarm (WSH-4201)
  - f. Final Clarifier #3 emergency stop (YI-4201C)
3. Non-resettable elapsed time meter shall be displayed at the SCADA HMI (KQI- 4201).
4. A motor state disagreement alarm shall be displayed at the SCADA HMI if the called state of the motor and the state of the run status contact do not agree after a preset adjustable time (YA-4201A). The disagreement alarm is enabled if the H/O/A switch is in the “Auto” position. The disagreement alarm must be manually reset through the SCADA HMI or the RTU-4B OIT before Remote Control is enabled
5. Remote Automatic – When placed in automatic mode the Clarifier shall start (YS-4201) and continuously run until removed from automatic mode.
6. Remote Manual Control: The Clarifier is manually start/stopped (YS-4201) via the SCADA HMI and the RTU-4B OIT.

M. LOOP 4202: FINAL CLARIFIER #4

1. Functionally identical to LOOP 4201.

N. LOOP 4211: RAS SLUDGE PUMP #4

1. The RAS Sludge Pump #4 is controlled via a enclosed VFD. Operation of the RAS Sludge Pump shall be monitored and controlled automatically through the MTU PLC via hardwired I/O in RTU-4B. The Pump has a Hand/Off/Auto selector switch at a local operator station, when in the “Auto” position the remote automatic control and remote manual control through the SCADA HMI

and the RTU-4B OIT is enabled.

2. The following control, status and alarm signals shall be wired to the PLC I/O and displayed at the SCADA HMI and RTU-4B OIT:
  - a. RAS Sludge Pump #4 H/O/A selector switch in “Auto” (YI-4211A)
  - b. RAS Sludge Pump #4 Run status (YI-4211B)
  - c. RAS Sludge Pump #4 Start/stop pump (YS-4211)
  - d. RAS Sludge Pump #4 speed feedback (SI-4211)
  - e. RAS Sludge Pump #4 speed control (SC-4211)
  - f. RAS Sludge Pump #4 Motor High Temperature (TSH-4211)
  - g. RAS Sludge Pump #4 VFD Alarm (YA-4211)
  - h. RAS Sludge Pump #4 emergency stop (YI-4211C)
  - i. RAS Sludge Pump #4 Water Seal Failure (PSH-4211)
3. Non-resettable elapsed time meter shall be displayed at the OIT and SCADA HMI (KQI-4211).
4. A motor state disagreement alarm shall be displayed at the OIT and SCADA HMI if the called state of the motor and the state of the run status contact do not agree after a preset adjustable time (YA-4211A). The disagreement alarm is enabled if the H/O/A switch is in the “Auto” position. The disagreement alarm must be manually reset through the SCADA HMI or the RTU-4B OIT before Remote Control is enabled.
5. Remote Automatic RAS Flow Control: The RAS Sludge Pump shall continuously operate (YS-4211). The RAS Sludge Pump shall have a lead/lag configuration with Pump #5 and Pump #6 where the lead pump(s) are the continuous running pump(s) and the lag pump(s) are acting as backup in case of a lead pump alarm (YA-4211) or failure (YA-4211A). The VFD speed command (SC-4211) is automatically controlled to maintain the RAS sludge flow (FIT- 4261) to an operator configured flow setpoint divided by the number of RAS Pumps running (YI-4211B, YI-4212B, & YI-4213B). A pump must be in “Auto Position” to be designated as a lead pump.

6. Remote Automatic RAS Rate Control: Functional identical to the Remote Automatic RAS Flow Control except the VFD speed command (SC-4211) is automatically controlled to an operator adjustable proportional RAS flow rate (FIT 4261) to Influent Flow (FIT-1001) setpoint divided by the number of RAS Pumps running (YI-4211B, YI-4212B, & YI-4213B).
  7. Remote Manual Control: The RAS Sludge Pump is manually start/stopped (YS- 4211) and VFD speed command (SC-4211) is manually entered via the SCADA HMI and the RTU-4B OIT.
- O. LOOP 4212: RAS SLUDGE PUMP #5
1. Functionally identical to LOOP 4211.
- P. LOOP 4213: RAS SLUDGE PUMP #6
1. Functionally identical to LOOP 4211.
- Q. LOOP 4221: WAS SLUDGE PUMP #3
1. The WAS Sludge Pump #3 is controlled via a enclosed VFD. Operation of the WAS Sludge Pump shall be monitored and controlled automatically through the MTU PLC via hardwired I/O in RTU-4B. The Pump has a Hand/Off/Auto selector switch at a local operator station, when in the “Auto” position the remote automatic control and remote manual control through the SCADA HMI and the RTU-4B OIT is enabled.
  2. The following control, status and alarm signals shall be wired to the PLC I/O and displayed at the SCADA HMI and RTU-4B OIT:
    - a. WAS Sludge Pump #3 H/O/A selector switch in “Auto” (YI-4221A)
    - b. WAS Sludge Pump #3 Run status (YI-4221B)
    - c. WAS Sludge Pump #3 Start/stop pump (YS-4221)
    - d. WAS Sludge Pump #3 speed feedback (SI-4221)
    - e. WAS Sludge Pump #3 speed control (SC-4221)
    - f. WAS Sludge Pump #3 Motor High Temperature (TSH-4221)

- g. WAS Sludge Pump #3 VFD Alarm (YA-4221)
  - h. WAS Sludge Pump #3 emergency stop (YI-4221C)
  - i. **WAS Sludge Pump #3 Water Seal Failure (PSH-4221)**
3. Non-resettable elapsed time meter shall be displayed at the OIT and SCADA HMI (KQI-4221).
  4. A motor state disagreement alarm shall be displayed at the OIT and SCADA HMI if the called state of the motor and the state of the run status contact do not agree after a preset adjustable time (YA-4221A). The disagreement alarm is enabled if the H/O/A switch is in the “Auto” position. The disagreement alarm must be manually reset through the SCADA HMI or the RTU-4B OIT before Remote Control is enabled.
  5. Remote Automatic Flow Control: The WAS Sludge Pump shall automatically operate from a cycle timer (KC-4221) with adjustable on-state and off-state durations. At the beginning on-state of the pump is called to start (YS-4221) and shall run for duration of the on-state timer. The VFD speed command (SC-4221) is automatically controlled to maintain the WAS sludge flow (FIT-4251) to an operator configured flow setpoint divided by the number of WAS Sludge Pumps running (YI-4221B, YI-4222B, and if applicable YI-4231B).
  6. Remote Automatic Manual Speed Control: Functional identical to the Remote Automatic Flow Control except the VFD speed command (SC-4221) is not based on flow and is manually set via the SCADA HMI and the RTU-4B OIT.
  7. Remote Manual Control: The WAS Sludge Pump is manually start/stopped (YS- 4221) and VFD speed command (SC-4221) is manually entered via the SCADA HMI and the RTU-4B OIT.
- R. LOOP 4222: WAS SLUDGE PUMP #4
1. Functionally identical to LOOP 4221.
- S. LOOP 4231: FINAL SCUM PUMP #2
1. The Final Scum Pump #2 is controlled via a enclosed VFD. Operation of the Final Scum Pump shall be monitored and controlled automatically through the MTU PLC via hardwired I/O in RTU-4B. The Pump has a Hand/Off/Auto selector switch at a local operator station, when in the “Auto” position the remote automatic control and remote manual control through the SCADA HMI and the RTU-4B OIT is enabled

2. The following control, status and alarm signals shall be wired to the PLC I/O and displayed at the SCADA HMI and RTU-4B OIT:
  - a. Final Scum Pump #2 H/O/A selector switch in “Auto” (YI-4231A)
  - b. Final Scum Pump #2 Run status (YI-4231B)
  - c. Final Scum Pump #2 Start/stop pump (YS-4231)
  - d. Final Scum Pump #2 speed feedback (SI-4231)
  - e. Final Scum Pump #2 speed control (SC-4231)
  - f. Final Scum Pump #2 Motor High Temperature (TSH-4231)
  - g. Final Scum Pump #2 VFD Alarm (YA-4231)
  - h. Final Scum Pump #2 emergency stop (YI-4231C)
  - i. Final Scum Pump #2 Water Seal Failure (PSH-4231)
3. Non-resettable elapsed time meter shall be displayed at the OIT and SCADA HMI (KQI-4231).
4. A motor state disagreement alarm shall be displayed at the OIT and SCADA HMI if the called state of the motor and the state of the run status contact do not agree after a preset adjustable time (YA-4231A). The disagreement alarm is enabled if the H/O/A switch is in the “Auto” position. The disagreement alarm must be manually reset through the SCADA HMI or the RTU-4B OIT before Remote Control is enabled.
5. Remote Automatic Scum Control: The Final Scum Pump shall automatically start (YS-4231) when the level in the Final Scum Well #1 (LIT-4232) exceeds an operator configurable level set point and will continue to run until the Final Scum Well #1 level drops below an operator adjustable level set point. The VFD speed command (SC-4231) is manually entered via the SCADA HMI and the RTU-4B OIT.
6. Remote Automatic WAS Control: Functionally identical to the Remote Automatic control in Loop 4221.
7. Remote Manual Control: The Final Scum Pump is manually start/stopped (YS-4231) and VFD speed command (SC-4231) is manually entered via the

SCADA HMI and the RTU-4B OIT.

T. LOOP 4232: FINAL SCUM WELL #2 LEVEL

1. The Final Scum Well #2 level shall be measured by an ultrasonic level transmitter that produces a 4-20ma signal proportional to the well level (LE/LIT- 4232) and shall be monitored by the MTU PLC via hardwired I/O in RTU-4B. The well level shall be indicated and trended at the SCADA HMI and the RTU- 4B OIT. The SCADA system shall record the signal (LIR-4232).

U. LOOP 4251: WAS SLUDGE FLOW

1. The WAS Sludge Flow shall be measured by an ultrasonic strap on type flow meter that produces a 4-20ma signal proportional to the sludge flow (FE/FIT-4251) and shall be monitored by the MTU PLC via hardwired I/O in RTU-4B. The sludge flow shall be indicated and trended at the SCADA HMI and the RTU- 4B OIT. The SCADA system shall record the signal (FIR-4251).
2. Four flow totals shall be computed and displayed at the SCADA HMI.
  - a. Non-resettable total (FQI-4251A)
  - b. Previous days total (FQI-4251B)
  - c. Current days total (FQI-4251C), automatically reset daily
  - d. Resettable total (FQI-4251D)

V. LOOP 4261: RAS SLUDGE FLOW

1. The RAS Sludge Flow shall be measured by an ultrasonic strap on type flow meter that produces a 4-20ma signal proportional to the sludge flow (FE/FIT-4261) and shall be monitored by the MTU PLC via hardwired I/O in RTU-4B. The sludge flow shall be indicated and trended at the SCADA HMI and the RTU- 4B OIT. The SCADA system shall record the signal (FIR-4261).
2. Four flow totals shall be computed and displayed at the SCADA HMI.
  - a. Non-resettable total (FQI-4261A)
  - b. Previous days total (FQI-4261B)



- c. Current days total (FQI-4261C), automatically reset daily
- d. Resettable total (FQI-4261D)

#### 1.14 DISENFECTION LOOP DESCRIPTIONS

##### A. LOOP 5101: SODIUM HYPOCHLORITE TANK LEVEL

- 1. The Sodium Hypochlorite Tank level shall be measured by an ultrasonic level transmitter that produces a 4-20ma signal proportional to the tank level (LE/LIT- 5101) and shall be monitored by the MTU PLC via hardwired I/O in RTU-5. The well level shall be indicated and trended at the SCADA HMI and the RTU-5 OIT. The SCADA system shall record the signal (LIR-5101).
- 2. The Sodium Hypochlorite Tank high level shall be monitored by a high level float switch (LSH-5101) that shall be hard wired to a Tank Level Alarm Station (LAH-5101).

##### B. LOOP 5102: SODIUM HYPOCHLORITE TANK LEAK

- 1. A float switch (LSH-5102) located in the Sodium Hypochlorite Tank containment area and shall be monitored by the MTU PLC via hardwired I/O in RTU-5. Upon activation the leak shall be alarmed and indicated at SCADA HMI and RTU-5.

##### C. LOOP 5201: SODIUM HYPOCHLORITE PUMP #1

- 1. The Sodium Hypochlorite Pump #1 shall be monitored and controlled automatically through the MTU PLC via hardwired I/O in RTU-5. The Pump shall have Hand/Off/Auto selector switch on the SCADA HMI and RTU-5 OIT, when in the "Auto" or "Hand" positions respectively the remote automatic control and remote manual control through the SCADA HMI and the RTU-5 OIT is enabled.
- 2. The following control, status and alarm signals shall be wired to the PLC I/O and displayed at the SCADA HMI and RTU-5 OIT:
  - a. Sodium Hypochlorite Pump #1 Run status (YI-5201)
  - b. Sodium Hypochlorite Pump #1 Start/stop pump (YS-5201)
  - c. Sodium Hypochlorite Pump #1 speed (SI-5201)

- d. Sodium Hypochlorite Pump #1 pace control (SC-5201)
  - e. Sodium Hypochlorite Pump #1 Alarm (YA-5201)
3. Non-resettable elapsed time meter shall be displayed at the OIT and SCADA HMI (KQI-5201).
  4. A motor state disagreement alarm shall be displayed at the OIT and SCADA HMI if the called state of the motor and the state of the run status contact do not agree after a preset adjustable time (YA-5201A). The disagreement alarm is enabled if the H/O/A switch is in the "Auto" position. The disagreement alarm must be manually reset through the SCADA HMI or the RTU-5 OIT before Remote Control is enabled.
  5. Remote Automatic Disinfection Control: The pump shall continuously operate (YS-5201) and shall be paced (SC-5201) to an operator configurable pacing set point proportional to the influent flow (FIT-1001) with a trim . The Sodium Hypochlorite chemical feed pump shall have a lead/lag configuration with Pump #2 or Pump #3 where the lead pump is continuous running pump and the lag pump is acting as backup in case of a lead pump alarm (YA-5201) or failure (YA-5201B), A SCADA HMI and RTU-5 OIT operator selection switch shall alternate the pumps as lead and lag. A pump must be in "Auto Position" to be designated as a lead pump.
  6. Remote Automatic Foam Spray: The pump shall continuously operate (YS-5201) and shall be paced (SC-5201) to maintain an operator entered pacing signal.
  7. Remote Manual Control: The Sodium Hypochlorite is manually start/stopped (YS-5201) and VFD speed command (SC-5201) is manually entered via the SCADA HMI and the RTU-5 OIT.
- D. LOOP 5202: SODIUM HYPOCHLORITE PUMP #2
1. Functionally identical to LOOP 5201.
- E. LOOP 5202: SODIUM HYPOCHLORITE PUMP #3
1. Functionally identical to LOOP 5203.
- F. LOOP 5301: SODIUM BISULFITE TANK LEVEL
1. The Sodium Bisulfite Tank level shall be measured by an ultrasonic level transmitter that produces a 4-20ma signal proportional to the tank level (LE/LIT- 5301) and shall be monitored by the MTU PLC via hardwired I/O in RTU-5. The well level shall be indicated and trended at the SCADA HMI and the RTU-5 OIT. The SCADA system shall record the signal (LIR-5301).

2. The Sodium Bisulfite Tank high level shall be monitored by a high level float switch (LSH-5301) that shall be hard wired to a Tank Level Alarm Station (LAH-5301).

G. LOOP 5302: SODIUM BISULFITE TANK LEAK

1. A float switch (LSH-5302) located in the Sodium Bisulfite Tank containment area and shall be monitored by the MTU PLC via hardwired I/O in RTU-5. Upon activation the leak shall be alarmed and indicated at SCADA HMI and RTU-5.

H. LOOP 5401: SODIUM BISULFITE PUMP #1

1. The Sodium Bisulfite Pump #1 shall be monitored and controlled automatically through the MTU PLC via hardwired I/O in RTU-5. The Pump shall have Hand/Off/Auto selector switch on the SCADA HMI and RTU-5 OIT, when in the “Auto” or “Hand” positions respectively the remote automatic control and remote manual control through the SCADA HMI and the RTU-5 OIT is enabled.
2. The following control, status and alarm signals shall be wired to the PLC I/O and displayed at the SCADA HMI and RTU-5 OIT:
  - a. Sodium Bisulfite Pump #1 Run status (YI-5401)
  - b. Sodium Bisulfite Pump #1 Start/stop pump (YS-5401)
  - c. Sodium Bisulfite Pump #1 speed (SI-5401)
  - d. Sodium Bisulfite Pump #1 pace control (SC-5401)
  - e. Sodium Bisulfite Pump #1 Alarm (YA-5401)
3. Non-resettable elapsed time meter shall be displayed at the OIT and SCADA HMI (KQI-5401).
4. A Pump failure alarm (YA-5401A) shall be generated and displayed at the SCADA HMI if Pump #1 is called to run and the effluent Chlorine level (AHH- 5504) high level alarm is active. The pump alarm must be manually reset through the SCADA HMI or the RTU-5 OIT before Automatic Control for the pump is enabled.

5. Remote Automatic Control: The pump shall continuously operate (YS-5401) and shall be paced (SC-5401) to an operator configurable pacing set point proportional to the influent flow (FIT-1001). An operator selectable pacing trim control shall allow the pump pacing signal to be trimmed based on an operator configurable Chlorine level set point at the Chlorine Contact Tank effluent (AIT- 5504). The Bisulfite chemical feed pumps shall have a lead/lag configuration with Pump #2 where the lead pump is continuous running pump and the lag pump is acting as backup in case of a lead pump alarm (YA-5401) or failure (YA-5401B), A SCADA HMI and RTU-5 OIT operator selection switch shall alternate the pumps as lead and lag. The lag pump shall also be called to run for a SCADA HMI operator configurable time period at a SCADA HMI operator configurable speed if the effluent Chlorine level (AHH-5504) high-high level alarm is active. A pump must be in “Auto Position” to be designated as a lead pump.
  
  6. Remote Manual Control: The Sodium Bisulfite is manually start/stopped (YS-5401) and VFD speed command (SC-5401) is manually entered via the SCADA HMI and the RTU-5 OIT.
- I. LOOP 5402: SODIUM BISULFITE PUMP #2
    1. Functionally identical to LOOP 5401.
  
  - J. LOOP 5501: CHLORINE MIXER
    1. The Chlorine Mixer is controlled via a manufacture supplied control panel. Operation of the Chlorine Mixer shall be monitored and controlled automatically through the MTU PLC via hardwired I/O in RTU-5. The Chlorine Mixer control panel has a door mounted Hand/Off/Auto selector switch. When in the “Auto” position the remote automatic control and remote manual control through the SCADA HMI and the RTU-5 OIT is enabled.
  
    2. The following control, status and alarm signals shall be wired to the PLC I/O and displayed at the SCADA HMI and OITs:
      - a. Chlorine Mixer HOA switch in “Auto” position (YI-5501A)
  
      - b. Chlorine Mixer run status (YI-5501B)
  
      - c. Chlorine Mixer Start/Stop (YS-5501)
  
      - d. Chlorine Mixer Alarm (YA-5501)
  
    3. Non-resettable elapsed time meter shall be displayed at the SCADA HMI

(KQI- 5501).

4. A motor state disagreement alarm shall be displayed at the SCADA HMI if the called state of the motor and the state of the run status contact do not agree after a preset adjustable time (YA-5501A). The disagreement alarm is enabled if the H/O/A switch is in the “Auto” position. The disagreement alarm must be

manually reset through the SCADA HMI before Remote Automatic Control and Remote Manual Control is enabled.

5. Remote Automatic – When placed in automatic mode the Chlorine Mixer shall start (YS-5501) and continuously run until removed from automatic mode.
6. Remote Manual Control: The Chlorine Mixer is manually start/stopped (YS-5501) via the SCADA HMI and the RTU-5 OIT.

K. LOOP 5502: EFFLUENT FLOW

1. The Effluent Flow shall be measured by a ultrasonic open channel type flow meter that produces a 4-20ma signal proportional to the effluent flow (FE/FIT-5502) and shall be monitored by the MTU PLC via hardwired I/O in RTU-5. The Effluent flow shall be indicated and trended at the SCADA HMI and the RTU-5 OIT. The SCADA system shall record the signal (FIR-5502).
2. Four flow totals shall be computed and displayed at the SCADA HMI and the RTU-5 OIT.
  - a. Non-resettable total (FQI-5502A)
  - b. Previous days total (FQI-5502B)
  - c. Current days total (FQI-5502C), automatically reset daily
  - d. Resettable total (FQI-5502D)

L. LOOP 5503: EFFLUENT FLOW

1. The Effluent Flow shall be measured by a ultrasonic open channel type flow meter that produces a 4-20ma signal proportional to the effluent flow (FE/FIT-5503) and shall be monitored by the MTU PLC via hardwired I/O in RTU-5. The Effluent flow shall be indicated and trended at the SCADA HMI and the RTU-5 OIT. The SCADA system shall record the signal (FIR-5503).

2. Four flow totals shall be computed and displayed at the SCADA HMI and the RTU-5 OIT.
  - a. Non-resettable total (FQI-5503A)
  - b. Previous days total (FQI-5503B)
  - c. Current days total (FQI-5503C), automatically reset daily
  - d. Resettable total (FQI-5503D)
  
3. Plant total flow (FQI-5500) shall be computed as the sum of the two Effluent Flow meters (FIT-5501 and FIT-5502). The SCADA system shall record the signal (FIR-5500). Four flow totals shall be computed and displayed at the SCADA HMI and the RTU-5 OIT.
  - a. Non-resettable total (FQI-5500A)
  - b. Previous days total (FQI-5500B)
  - c. Current days total (FQI-5500C), automatically reset daily
  - d. Resettable total (FQI-5500D)

M. LOOP 5504: POST CHLORINE CONTACT CHAMBER CHLORINE LEVEL

1. The Post Chlorine Contact Chamber Chlorine level shall be measured by an chlorine analyzer transmitter that produces a 4-20ma signal proportional to the effluent chlorine level (AE/AIT-5504) and shall be monitored by the MTU PLC via hardwired I/O in RTU-5. The Chlorine level shall be indicated and trended at the SCADA HMI and the RTU-5 OIT. The SCADA system shall record the signal (AIR-5504).

N. LOOP 5505: PRE-CHLORINE CONTACT CHAMBER CHLORINE LEVEL

1. The Pre-Chlorine Contact Chamber Chlorine level shall be measured by an chlorine analyzer transmitter that produces a 4-20ma signal proportional to the effluent chlorine level (AE/AIT-5505) and shall be monitored by the MTU PLC via hardwired I/O in RTU-5. The Chlorine level shall be indicated and trended at the SCADA HMI and the RTU-5 OIT. The SCADA system shall record the signal (AIR-5505).

## 1.15 AERATION BLOWERS LOOP DESCRIPTIONS

### A. LOOPS 6000: AERATION BLOWERS

1. The operation of the Aeration Blowers will be through a manufacture supplied PLC based Aeration Master control panel. All controls, alarms and indications data will be transmitted via an Ethernet data exchange and displayed and trended at the SCADA HMI.
2. The following signal shall be made available to the Lime Control system via the Ethernet network connection:
  - a. Plant Influent Flow Rate (FIT-1001)
  - b. Train #1 Anoxic Selector #3 DO Level (AIT-3503)
  - c. Train #1 Aerobic Zone #1 DO Level (AIT-3504)
  - d. Train #1 Aerobic Zone #2 DO Level (AIT-3505)
  - e. Train #1 Aerobic Zone #3 DO Level (AIT-3507)
  - f. Secondary Anoxic Tank #1 DO Level (AIT-3511)
  - g. Re-Aeration Tank #1 DO Level (AIT-3513)
  - h. Train #2 Anoxic Selector #3 DO Level (AIT-3523)
  - i. Train #2 Aerobic Zone #1 DO Level (AIT-3524)
  - j. Train #2 Aerobic Zone #2 DO Level (AIT-3525)
  - k. Train #2 Aerobic Zone #3 DO Level (AIT-3527)
  - l. Secondary Anoxic Tank #2 DO Level (AIT-3531)
  - m. Re-Aeration Tank #2 DO Level (AIT-3533)

## 1.16 SOLIDS HANDLING LOOP DESCRIPTIONS

### A. LOOP 7101: GRAVITY THICKENER #1

1. The Gravity Thickener #1 is controlled via a wall mounted motor starter. Operation of the Thickener shall be monitored and controlled automatically

through the MTU PLC via hardwired I/O in RTU-7. The Thickener has a Hand/Off/Auto selector switch at a local operator station. When in the “Auto” position the remote automatic control and remote manual control through the SCADA HMI and the RTU-7 OIT is enabled.

2. The following control, status and alarm signals shall be wired to the PLC I/O and displayed at the SCADA HMI and RTU-7 OIT:
    - a. Gravity Thickener #1 HOA switch in “Auto” position (YI-7101A)
    - b. Gravity Thickener #1 run status (YI-7101B)
    - c. Gravity Thickener #1 Start/Stop (YS-7101)
    - d. Gravity Thickener #1 Overload (YA-7101)
    - e. Gravity Thickener #1 high torque alarm (WSH-7101)
    - f. Gravity Thickener #1 emergency stop (YI-7101C)
  3. Non-resettable elapsed time meter shall be displayed at the SCADA HMI (KQI- 7101).
  4. A motor state disagreement alarm shall be displayed at the SCADA HMI if the called state of the motor and the state of the run status contact do not agree after a preset adjustable time (YA-7101A). The disagreement alarm is enabled if the H/O/A switch is in the “Auto” position. The disagreement alarm must be manually reset through the SCADA HMI or RTU-7 OIT before Remote Automatic Control and Remote Manual Control is enabled.
  5. Remote Automatic – When placed in automatic mode the Thickener shall start (YS-7101) and continuously run until removed from automatic mode.
  6. Remote Manual Control: The Thickener is manually start/stopped (YS-7101) via the SCADA HMI and the RTU-7 OIT.
- B. LOOP 7102: GRAVITY THICKENER #2
1. Functionally identical to LOOP 7101.
- C. LOOP 7201: THICKENED SLUDGE PUMP #1



1. The Thickened Sludge Pump #1 is controlled via a enclosed VFD. Operation of the Thickened Sludge Pump shall be monitored and controlled automatically through the MTU PLC via hardwired I/O in RTU-7. The Pump has a Hand/Off/Auto selector switch at a local operator station, when in the “Auto” position the remote automatic control and remote manual control through the SCADA HMI and the RTU-7 OIT is enabled.
2. The following control, status and alarm signals shall be wired to the PLC I/O and displayed at the SCADA HMI and RTU-7 OIT:
  - a. Thickened Sludge Pump #1 H/O/A selector switch in “Auto” (YI-7201A)
  - b. Thickened Sludge Pump #1 Run status (YI-7201B)
  - c. Thickened Sludge Pump #1 Start/stop pump (YS-7201)
  - d. Thickened Sludge Pump #1 speed feedback (SI-7201)
  - e. Thickened Sludge Pump #1 speed control (SC-7201)
  - f. Thickened Sludge Pump #1 Motor High Temperature (TSH-7201)
  - g. Thickened Sludge Pump #1 High Discharge Pressure (PSH-7201)
  - h. Thickened Sludge Pump #1 VFD Alarm (YA-7201)
  - i. Thickened Sludge Pump #1 emergency stop (YI-7201C)
3. Non-resettable elapsed time meter shall be displayed at the OIT and SCADA HMI (KQI-7201).
4. A motor state disagreement alarm shall be displayed at the OIT and SCADA HMI if the called state of the motor and the state of the run status contact do not agree after a preset adjustable time (YA-7201A). The disagreement alarm is enabled if the H/O/A switch is in the “Auto” position. The disagreement alarm must be manually reset through the SCADA HMI or the RTU-7 OIT before Remote Control is enabled.
5. Remote Automatic Control: The Thickened Sludge Pump shall automatically start (YS-7201) when the operator selected Centrifuges #1 or #2 provides a start signal. The VFD speed command (SC-7201) is automatically controlled to maintain the Thickened Sludge flow (FIT-7203) to an operator selected Centrifuges #1 or #2 sludge flow setpoint.
6. Remote Manual Control: The Thickened Sludge Pump is manually start/stopped (YS-7201) and VFD speed command (SC-7201) is manually entered via the SCADA HMI and the RTU-7 OIT.

7. The Thickened Sludge Pump #1 shall automatically shut down upon low flow (FALL-7203) for a preset adjustable time.
- D. LOOP 7202: THICKENED SLUDGE PUMP #2
1. Functionally identical to LOOP 7101 except the VFD speed command (SC-7201) in Remote Automatic Control is automatically controlled to maintain the Thickened Sludge flow (FIT-7204) to an operator selected Centrifuges #1 or #2 sludge flow setpoint.
  2. The Thickened Sludge Pump #2 shall automatically shut down upon low flow (FALL-7204) for a preset adjustable time.
- E. LOOP 7203: THICKENED SLUDGE PUMP #1 FLOW
1. The Thickened Sludge Pump #1 Flow shall be measured by a magnetic type flow meter that produces a 4-20ma signal proportional to the Thickened Sludge Pump #1 flow (FE/FIT-7203) and shall be monitored by the MTU PLC via hardwired I/O in RTU-7. The Thickened Sludge Pump #1 flow shall be indicated and trended at the SCADA HMI and the RTU-7 OIT. The SCADA system shall record the signal (FIR-7203).
  2. Four flow totals shall be computed and displayed at the SCADA HMI and the RTU-7 OIT.
    - a. Non-resettable total (FQI-7203A)
    - b. Previous days total (FQI-7203B)
    - c. Current days total (FQI-7203C), automatically reset daily
    - d. Resettable total (FQI-7203D)
- F. LOOP 7204: THICKENED SLUDGE PUMP #2 FLOW
1. Functionally identical to LOOP 7203.
- G. LOOP 7205: THICKENED SLUDGE GRINDER #1
1. The Thickened Sludge Grinder #1 is controlled via a wall mounted Grinder Control Panel and is automatically started/stopped via a hardwired signal from the Thickened Sludge Pump #1 VFD. Operation of Thickened Sludge Grinder #1 shall be monitored through the through the MTU PLC via hardwired I/O in RTU-7
  2. The following status and alarm signals shall be wired to the PLC I/O and displayed at the SCADA HMI and RTU-7 OIT:
    - a. Primary Sludge Grinder #1 HOA switch in “Auto” position (YI-7205A)

- b. Primary Sludge Grinder #1 run status (YI-7205B)
  - c. Primary Sludge Grinder #1 alarm (YA-7205)
- H. LOOP 7206: THICKENED SLUDGE GRINDER #6
  - 1. Functionally identical to LOOP 7205 except the Thickened Sludge Grinder #2 is automatically started/stopped via a hardwired signal from the Thickened Sludge Pump #2 VFD.
- I. LOOP 7302: CENTRIFUGE #1
  - 1. The operation of the Centrifuge #1 is through a manufacture supplied PLC based control panel. All controls, alarms and indications data shall be transmitted via an Ethernet data exchange and displayed and trended at the SCADA HMI.
  - 2. An operator selectable Thickened Feed Pump selector switch at the SCADA HMI and the RTU-7 OIT shall allow the operator to select either Thickened Sludge Pump #1 or #2 as the feed pump to the Centrifuge #1 which shall be based on the configuration of manually operator valves upstream of the Centrifuges.
  - 3. The following signal shall be made available to the Centrifuges #1 Control system via the Ethernet network connection:
    - a. Thickened Sludge Pump #1 Flow Rate (FIT-7203) or Thickened Sludge Pump #2 Flow Rate (FIT-7204) based on the Thickened Pump feed pump selector switch.
- J. LOOP 7303: CENTRIFUGE #2
  - 1. Functionally identical to LOOP 7302.
- K. LOOP 7303: SCREW CONVEYORS
  - 1. The Screw Conveyor is controlled via a manufacture supplied control panel. Operation of the Screw Conveyor shall be monitored through the MTU PLC via hardwired I/O in RTU-7. The Screw Conveyor control panel has a door mounted Hand/Off/Auto selector switch. When in the "Auto" position the remote automatic control through the Centrifuges Control Panels is enabled.
  - 2. The following control, status and alarm signals shall be wired to the PLC I/O and displayed at the SCADA HMI and OITs:
    - a. Screw Conveyor HOA switch in "Auto" position (YI-7303A)
    - b. Screw Conveyor run status (YI-7303B)
    - c. Screw Conveyor Alarm (YA-7303)

3. Non-resettable elapsed time meter shall be displayed at the SCADA HMI (KQI-7303).

L. LOOP 7305: LEVELER SCREW CONVEYOR

1. The Leveler Screw Conveyor is controlled via a manufacture supplied control panel. Operation of the Leveler Screw Conveyor shall be monitored and controlled automatically through the MTU PLC via hardwired I/O in RTU-7. The Leveler Screw Conveyor control panel has a door mounted Hand/Off/Auto selector switch. When in the “Auto” position the remote automatic control through the Screw Conveyor Panel is enabled..
2. The following control, status and alarm signals shall be wired to the PLC I/O and displayed at the SCADA HMI and OITs:
  - a. Leveler Screw Conveyor HOA switch in “Auto” position (YI-7305A)
  - b. Leveler Screw Conveyor run status (YI-7305B)
  - c. Leveler Screw Conveyor Alarm (YA-7305)
3. Non-resettable elapsed time meter shall be displayed at the SCADA HMI (KQI-7305).

M. LOOP 7401: SCUM CONCENTRATOR

1. The Scum Concentrator is controlled via a manufacture supplied control panel. Operation of the Scum Concentrator shall be monitored and controlled automatically through the MTU PLC via hardwired I/O in RTU-7. The Scum Concentrator control panel has a door mounted Start/Stop push buttons.
2. The following control, status and alarm signals shall be wired to the PLC I/O and displayed at the SCADA HMI and OITs:
  - a. Scum Concentrator run status (YI-7401B)
  - b. Scum Concentrator Alarm (YA-7401)
3. Non-resettable elapsed time meter shall be displayed at the SCADA HMI (KQI-7401).

N. LOOP 7402: SCUM MACERATOR

1. The Scum Macerator is controlled via a manufacture supplied control panel. Operation of the Scum Macerator shall be monitored and controlled automatically through the MTU PLC via hardwired I/O in RTU-7. The Scum Macerator control panel has a door mounted Hand/Off/Auto selector switch. When in the “Auto” position the remote automatic control and remote manual control through the SCADA HMI and the RTU-7 OIT is enabled.

2. The following control, status and alarm signals shall be wired to the PLC I/O and displayed at the SCADA HMI and OITs:
  - a. Scum Macerator HOA switch in “Auto” position (YI-7402A)
  - b. Scum Macerator run status (YI-7402B)
  - c. Scum Macerator Start/Stop (YS-7402)
  - d. Scum Macerator Alarm (YA-7402)
3. Non-resettable elapsed time meter shall be displayed at the SCADA HMI (KQI-7402).
4. A motor state disagreement alarm shall be displayed at the SCADA HMI if the called state of the motor and the state of the run status contact do not agree after a preset adjustable time (YA-7402A). The disagreement alarm is enabled if the H/O/A switch is in the “Auto” position. The disagreement alarm must be manually reset through the SCADA HMI before Remote Automatic Control and Remote Manual Control is enabled.
5. Remote Automatic – When placed in automatic mode the Scum Macerator shall start (YS-7402) and continuously run until removed from automatic mode.
6. Remote Manual Control: The Scum Macerator is manually start/stopped (YS-7402) via the SCADA HMI and the RTU-7 OIT.

O. LOOP 7500: POLYMER TANK LEVEL CONTROL PANEL

1. The Polymer Tank Level is controlled via an existing level control panel. Operation of the Polymer Level Control Panel shall be monitored and controlled automatically through the MTU PLC via hardwired I/O in RTU-7. The Polymer Level Control Panel control panel has a door mounted Hand/Off/Auto selector switch. When in the “Auto” position the remote automatic control and remote manual control through the SCADA HMI and the RTU-7 OIT is enabled.
2. The following control, status and alarm signals shall be wired to the PLC I/O and displayed at the SCADA HMI and OITs:
  - a. Polymer Level Control Panel HOA switch in “Auto” position (YI-7500A)
  - b. Polymer Level Control Panel run status (YI-7500B)
  - c. Polymer Level Control Panel Start/Stop (YS-7500)
  - d. Polymer Level Control Panel Alarm (YA-7500)
3. Non-resettable elapsed time meter shall be displayed at the SCADA HMI (KQI-7500).

4. A motor state disagreement alarm shall be displayed at the SCADA HMI if the called state of the motor and the state of the run status contact do not agree after a preset adjustable time (YA-7500A). The disagreement alarm is enabled if the H/O/A switch is in the “Auto” position. The disagreement alarm must be manually reset through the SCADA HMI before Remote Automatic Control and Remote Manual Control is enabled.
5. Remote Automatic – When placed in automatic mode the Polymer Level Control Panel shall be (YS-7500) allowed to automatically fill up the Polymer Batch Tank based on existing float switches.
6. Remote Manual Control: The Polymer Level Control is manually start/stopped (YS-7500) via the SCADA HMI and the RTU-7 OIT.

P. LOOP 7601: POLYMER FEED PUMP #1

1. The Polymer Feed Pump #1 is controlled via a wall mounted VFD. Operation of the Polymer Feed Pump shall be monitored and controlled automatically through the MTU PLC via hardwired I/O in RTU-7. The Pump has a Hand/Off/Auto selector switch at a local operator station, when in the “Auto” position the remote automatic control and remote manual control through the SCADA HMI and the RTU-7 OIT is enabled.
2. The following control, status and alarm signals shall be wired to the PLC I/O and displayed at the SCADA HMI and RTU-7 OIT:
  - a. Polymer Feed Pump #1 H/O/A selector switch in “Auto” (YI-7601A)
  - b. Polymer Feed Pump #1 Run status (YI-7601B)
  - c. Polymer Feed Pump #1 Start/stop pump (YS-7601)
  - d. Polymer Feed Pump #1 speed feedback (SI-7601)
  - e. Polymer Feed Pump #1 speed control (SC-7601)
  - f. Polymer Feed Pump #1 VFD Alarm (YA-7601)
  - g. Polymer Feed Pump #1 emergency stop (YI-7601C)
3. Non-resettable elapsed time meter shall be displayed at the OIT and SCADA HMI (KQI-7601).
4. A motor state disagreement alarm shall be displayed at the OIT and SCADA HMI if the called state of the motor and the state of the run status contact do not agree after a preset adjustable time (YA-7601A). The disagreement alarm is enabled if the H/O/A switch is in the “Auto” position. The disagreement alarm must be manually reset through the SCADA HMI or the RTU-7 OIT before Remote Control is enabled.

5. Remote Automatic Control: The Polymer Feed Pump shall automatically start (YS-7601) when the when the operator selected Centrifuges #1 or #2 provides a start signal. The VFD speed command (SC-7601) is automatically controlled to maintain the Polymer Feed flow (FIT-7603) to an operator selected Centrifuges #1 or #2 polymer flow setpoint.
6. Remote Manual Control: The Polymer Feed Pump is manually start/stopped (YS-7601) and VFD speed command (SC-7601) is manually entered via the SCADA HMI and the RTU-7 OIT.

Q. LOOP 7602: POLYMER FEED PUMP #2

1. Functionally identical to LOOP 7601 except the VFD speed command (SC-7602) in Remote Automatic Control is automatically controlled to maintain the Thickened Sludge flow (FIT-7604) to an operator selected Centrifuges #1 or #2 polymer flow setpoint.

R. LOOP 7603: POLYMER FEED PUMP #1 FLOW

1. The Polymer Feed Pump #1 Flow shall be measured by a magnetic flow meter that produces a 4-20ma signal proportional to the Polymer Feed Pump #1 flow (FE/FIT-7603) and shall be monitored by the MTU PLC via hardwired I/O in RTU-7. The Polymer Feed Pump #1 flow shall be indicated and trended at the SCADA HMI and the RTU-7 OIT. The SCADA system shall record the signal (FIR-7603).
2. Four flow totals shall be computed and displayed at the SCADA HMI and the RTU-7 OIT.
  - a. Non-resettable total (FQI-7603A)
  - b. Previous days total (FQI-7603B)
  - c. Current days total (FQI-7603C), automatically reset daily
  - d. Resettable total (FQI-7603D)

S. LOOP 7604: POLYMER FEED PUMP #2 FLOW

1. Functionally identical to LOOP 7603.

T. LOOP 7605: POLYMER TANK LEAK

1. A float switch (LSH-7605) located near the Polymer Tanks shall be monitored by the MTU PLC via hardwired I/O in RTU-7. Upon activation the leak shall be alarmed and indicated at SCADA HMI and RTU-7.

## 1.17 ODOR CONTROL LOOP DESCRIPTIONS

### A. LOOP 8101: HEADWORKS ODOR CONTROL BLOWER

1. The Headworks Odor Control Blower is controlled via a wall mounted VFD. Operation of the Odor Control Blower shall be monitored and controlled automatically through the MTU PLC via hardwired I/O in RTU-7. The Blower has a Hand/Off/Auto selector switch at a local operator station, when in the “Auto” position the remote automatic control and remote manual control through the SCADA HMI and the RTU-7 OIT is enabled.
2. The following control, status and alarm signals shall be wired to the PLC I/O and displayed at the SCADA HMI and RTU-7 OIT:
  - a. Headworks Odor Control Blower H/O/A selector switch in “Auto” (YI-8101A)
  - b. Headworks Odor Control Blower Run status (YI-8101B)
  - c. Headworks Odor Control Blower Start/stop pump (YS-8101)
  - d. Headworks Odor Control Blower speed feedback (SI-8101)
  - e. Headworks Odor Control Blower speed control (SC-8101)
  - f. Headworks Odor Control Blower Motor High Temperature (TSH-8101)
  - g. Headworks Odor Control Blower VFD Alarm (YA-8101)
  - h. Headworks Odor Control Blower emergency stop (YI-8101C)
3. Non-resettable elapsed time meter shall be displayed at the OIT and SCADA HMI (KQI-8101).
4. A motor state disagreement alarm shall be displayed at the OIT and SCADA HMI if the called state of the motor and the state of the run status contact do not agree after a preset adjustable time (YA-8101A). The disagreement alarm is enabled if the H/O/A switch is in the “Auto” position. The disagreement alarm must be manually reset through the SCADA HMI or the RTU-7 OIT before Remote Control is enabled.
5. Remote Automatic Control: When placed in automatic mode the Odor Control Blower shall start (YS-8101) and continuously run until removed from automatic mode. The VFD speed command (SC-8101) is set based on pre-determined speeds for 6 air changes per hour or 12 air changes per hour per an operator selectable air change rate switch on the SCADA HMI and the RTU-7 OIT.
6. Remote Manual Control: The Odor Control Blower is manually start/stopped (YS-8101) and VFD speed command (SC-8101) is manually entered via the SCADA HMI and the RTU-7 OIT.



- B. LOOP 8102: GRAVITY THICKENERS ODOR CONTROL BLOWER
  - 1. Functionally identical to LOOP 8101.
- C. LOOP 8103: SOLIDS HANDLING ODOR CONTROL BLOWER
  - 1. Functionally identical to LOOP 8101.
- D. LOOP 8110: SOLIDS HANDLING BUILDING SOLID BAY DOOR
  - 1. The Solids Handling Building Solids Bay door has position switch (ZSO-8110) shall be monitored by the MTU PLC via hardwired I/O in RTU-7 and upon opening shall alarm at the SCADA HMI and RTU-7 OIT.

#### 1.18 PLANT AUXILLARY SYSTEMS LOOP DESCRIPTIONS

- A. LOOP 9100: PLANT WATER SYSTEM
  - 1. The operation of the Plant Water System is through a manufacture supplied PLC based control panel, See Section 11311. All controls, alarms and indications data shall be transmitted via an Ethernet data exchange and displayed and trended at the SCADA HMI.
- B. LOOP 9115: PLANT WATER TO WAS FLOW
  - 1. The Plant Water to WAS Flow shall be measured by a magnetic flow meter that produces a 4-20ma signal proportional to the Plant Water to WAS flow (FE/FIT-9115) and shall be monitored by the MTU PLC via hardwired I/O in RTU-72. The Plant Water to WAS flow shall be indicated and trended at the SCADA HMI and the RTU-72 OIT. The SCADA system shall record the signal (FIR-9115).
  - 2. Four flow totals shall be computed and displayed at the SCADA HMI and the RTU-72 OIT.
    - a. Non-resettable total (FQI-9115A)
    - b. Previous days total (FQI-9115B)
    - c. Current days total (FQI-9115C), automatically reset daily
    - d. Resettable total (FQI-9115D)
- C. LOOP 9116: PLANT WATER TO WAS CONTROL VALVE
  - 1. The Plant Water to WAS Control Valve is controlled via an integral mounted modulating valve actuator. Operation of the valve shall be controlled automatically through the MTU PLC via hardwired I/O in RTU-72. Remote

automatic control and remote manual control shall be through the SCADA HMI and the RTU-72 OIT

2. Remote Automatic Control: The valve position command (XC-9116) is automatically controlled to maintain the Plant Water to WAS Flow (FIT-9115) to an operator selected water flow setpoint.
3. Remote Manual Control: The valve position command (XC-9116) is manually entered via the SCADA HMI and the RTU-72 OIT.

D. LOOP 9201: SANITARY WASTE PUMP #1

1. The Sanitary Waste Pump #1 is controlled via a wall mounted motor starter. Operation of the Scum Pump shall be monitored and controlled automatically through the MTU PLC via hardwired I/O in RTU-5. The Sanitary Pump has a Hand/Off/Auto selector switch on the motor starter. When in the “Auto” position the remote automatic control and remote manual control through the SCADA HMI and the RTU-5 OIT is enabled.
2. The following control, status and alarm signals shall be wired to the PLC I/O and displayed at the SCADA HMI and the RTU-5 OIT:
  - a. Sanitary Waste Pump #1 HOA switch in “Auto” position (YI-9201A)
  - b. Sanitary Waste Pump #1 run status (YI-9201B)
  - c. Sanitary Waste Pump #1 Start/Stop (YS-9201)
  - d. Sanitary Waste Pump #1 Overload (YA-9201)
3. Non-resettable elapsed time meter shall be displayed at the SCADA HMI (KQI-9201).
4. A motor state disagreement alarm shall be displayed at the SCADA HMI if the called state of the motor and the state of the run status contact do not agree after a preset adjustable time (YA-9201A). The disagreement alarm is enabled if the H/O/A switch is in the “Auto” position. The disagreement alarm must be manually reset through the SCADA HMI or the RTU-5 OIT before Remote Automatic Control and Remote Manual Control is enabled.
5. Remote Automatic – The two Sanitary Waste Pumps shall operate in a Lead/Lag configuration via a SCADA HMI or RTU-5 OIT operator selector switch. The lead pump shall automatically start (YS-9201) when the level in the Sanitary Waste Well (LIT-9203) exceeds an operator configurable level set point and will continue to run until the Sanitary Well level drops below an operator adjustable level set point. When the lead pump goes into alarm (YA-9201 or YA-9201A) the lag pump shall automatically take over as the lead pump.
6. Remote Manual Control: The Sanitary Waste Pump is manually start/stopped (YS-9201) via the SCADA HMI and the RTU-5 OIT.

- E. LOOP 9202: SANITARY WASTE PUMP #2
  - 1. Functionally identical to LOOP 9201.
- F. LOOP 9203: SANITARY WASTE WELL LEVEL
  - 1. The Sanitary Waste Well level shall be measured by an ultrasonic level transmitter that produces a 4-20ma signal proportional to the well level (LE/LIT-9203) and shall be monitored by the MTU PLC via hardwired I/O in RTU-5. The well level shall be indicated and trended at the SCADA HMI and the RTU-5 OIT. The SCADA system shall record the signal (LIR-9203).
- G. LOOP 9301: SODIUM HYPOCHLORITE TANK EYEWASH/SHOWER
  - 1. The Sodium Hypochlorite Tank eyewash/shower flow switch (FSH-9301) shall be monitored by the MTU PLC via hardwired I/O in RTU-5 and upon activation the alarm shall be indicated at the SCADA HMI and the RTU-5 OIT.
- H. LOOP 9302: SODIUM BISOLFITE ROOM EYEWASH/SHOWER
  - 1. The Sodium Bisulfite Room eyewash/shower flow switch (FSH-9302) shall be monitored by the MTU PLC via hardwired I/O in RTU-5 and upon activation the alarm shall be indicated at the SCADA HMI and the RTU-5 OIT.
- I. LOOP 9303: POLYMER EYEWASH/SHOWER
  - 1. The Polymer eyewash/shower flow switch (FSH-9303) shall be monitored by the MTU PLC via hardwired I/O in RTU-7 and upon activation the alarm shall be indicated at the SCADA HMI and the RTU-7 OIT.
- J. LOOP 9320: AUTOMATIC TRANSFER SWITCH
  - 1. The Automatic Transfer Switch (ATS) shall be monitored through the MTU PLC via hardwired I/O in RTU-3.
  - 2. The following status and alarm signals shall be wired to the PLC I/O and displayed at the SCADA HMI and the RTU-3 OIT:
    - a. ATS in normal position (YI-9320A)
    - b. ATS in emergency position (YI-9320B)
    - c. Utility power loss (YA-9320)
- K. LOOP 9321: GENERATOR #1
  - 1. Generator #1 is controlled via a manufacture supplied control panel. Operation of the Generator System shall be monitored through the MTU PLC via hardwired I/O in RTU-3.

2. The following status and alarm signals shall be wired to the PLC I/O and displayed at the SCADA HMI and the RTU-3 OIT:
  - a. Generator #1 not in Auto (YI-9321A)
  - b. Generator #1 running status (YI-9321B)
  - c. Generator #1 alarm (YA-9321A)
  - d. Generator #1 failure (YA-9321B)
  - e. Generator #1 low fuel (YA-9321C)
  - f. Generator #1 fuel leak (YA-9321D)
  
- L. LOOP 9322: GENERATOR #2
  1. Functionally identical to LOOP 9321.
  
- M. LOOP 9322: GENERATOR #3
  1. Functionally identical to LOOP 9321.
  
- N. LOOP 9325: FIRE ALARM
  1. The plant Fire Alarm System (YA-9325) shall be monitored by the MTU PLC via hardwired I/O in RTU-2 and upon activation the fire alarm shall be indicated at the SCADA HMI.
  
- O. LOOP 9330: ENERGY RECOVERY VENTILATION UNIT 2ERV-1
  1. The 2ERV-1 unit shall be monitored through the MTU PLC via hardwired I/O in RTU-2.
  2. The following status and alarm signals shall be wired to the PLC I/O and displayed at the SCADA HMI and the RTU-2 OIT:
    - a. 2ERV-1 running (YI-9330)
    - b. 2ERV-1 alarm (YA-9330)
  
- P. LOOP 9331: ENERGY RECOVERY VENTILATION UNIT 2ERV-2
  1. Functionally identical to LOOP 9330.
  
- Q. LOOP 9332: ENERGY RECOVERY VENTILATION UNIT 9ERV-1
  1. Functionally identical to LOOP 9330.

- R. LOOP 9333: ENERGY RECOVERY VENTILATION UNIT 3ERV-1
1. The 3ERV-1 unit shall be monitored through the MTU PLC via hardwired I/O in RTU-3.
  2. The following status and alarm signals shall be wired to the PLC I/O and displayed at the SCADA HMI and the RTU-3 OIT:
    - a. 3ERV-1 running (YI-9333)
    - b. 3ERV-1 alarm (YA-9333)
- S. LOOP 9334: ENERGY RECOVERY VENTILATION UNIT 4ERV-1
1. The 4ERV-1 unit shall be monitored through the MTU PLC via hardwired I/O in RTU-4A.
  2. The following status and alarm signals shall be wired to the PLC I/O and displayed at the SCADA HMI and the RTU-4A OIT:
    - a. 4ERV-1 running (YI-9334)
    - b. 4ERV-1 alarm (YA-9334)
- T. LOOP 9335: ENERGY RECOVERY VENTILATION UNIT 4ERV-2
1. The 4ERV-2 unit shall be monitored through the MTU PLC via hardwired I/O in RTU-4B.
  2. The following status and alarm signals shall be wired to the PLC I/O and displayed at the SCADA HMI and the RTU-4B OIT:
    - a. 4ERV-2 running (YI-9335)
    - b. 4ERV-2 alarm (YA-9335)
- U. LOOP 9336: ENERGY RECOVERY VENTILATION UNIT 5ERV-1
1. The 5ERV-1 unit shall be monitored through the MTU PLC via hardwired I/O in RTU-5.
  2. The following status and alarm signals shall be wired to the PLC I/O and displayed at the SCADA HMI and the RTU-5 OIT:
    - a. 5ERV-1 running (YI-9336)
    - b. 5ERV-1 alarm (YA-9336)
- V. LOOP 9337: ENERGY RECOVERY VENTILATION UNIT 7ERV-1

1. The 7ERV-1 unit shall be monitored through the MTU PLC via hardwired I/O in RTU-7.
  2. The following status and alarm signals shall be wired to the PLC I/O and displayed at the SCADA HMI and the RTU-7 OIT:
    - a. 7ERV-1 running (YI-9337)
    - b. 7ERV-1 alarm (YA-9337)
- W. LOOP 9338: ENERGY RECOVERY VENTILATION UNIT 7ERV-2
1. Functionally identical to LOOP 9337.
- X. LOOP 9339: ENERGY RECOVERY VENTILATION UNIT 7ERV-3
1. Functionally identical to LOOP 9337.
- Y. LOOP 9340: ENERGY RECOVERY VENTILATION UNIT 7ERV-4
1. Functionally identical to LOOP 9337.
- Z. LOOP 9341: ENERGY RECOVERY VENTILATION UNIT 7MAU-1
1. Functionally identical to LOOP 9337.
- AA. LOOP 9350: PRIMARY PIPE GALLERY FLOOD
1. A float switch (LSH-9350) located on the floor of the Primary Pipe Gallery shall be monitored by the MTU PLC via hardwired I/O in RTU-2. Upon activation the flood shall be alarmed and indicated at SCADA HMI and RTU-2.
- AB. LOOP 9351: OPERATIONS BUILDING BASEMENT FLOOD
1. A float switch (LSH-9350) located on the floor of the Operations Building Basement shall be monitored by the MTU PLC via hardwired I/O in RTU-2. Upon activation the flood shall be alarmed and indicated at SCADA HMI and RTU-2.
- AC. LOOP 9352: SUMP PUMP 4SP-1
1. The Sump Pump 4SP-1 high level (LSH-9352) shall be monitored by the MTU PLC via hardwired I/O in RTU-4A and upon activation the alarm shall be indicated at the SCADA HMI and the RTU-4A OIT.
- AD. LOOP 9353: SUMP PUMP 4SP-2
1. The Sump Pump 4SP-2 high level (LSH-9353) shall be monitored by the MTU PLC via hardwired I/O in RTU-4B and upon activation the alarm shall be indicated at the SCADA HMI and the RTU-4B OIT.

AE. LOOP 9354: SUMP PUMP 5SP-1

1. The Sump Pump 5SP-1 high level (LSH-9354) shall be monitored by the MTU PLC via hardwired I/O in RTU-5 and upon activation the alarm shall be indicated at the SCADA HMI and the RTU-5 OIT.

AF. LOOP 9355: SUMP PUMP 7SP-1

1. The Sump Pump 7SP-1 high level (LSH-9355) shall be monitored by the MTU PLC via hardwired I/O in RTU-7 and upon activation the alarm shall be indicated at the SCADA HMI and the RTU-7 OIT.

AG. LOOP 9356: THICKENED SLUDGE PUMP STATION FLOOD

1. A float switch (LSH-935) located on the floor of the Thickened Sludge Pump Station shall be monitored by the MTU PLC via hardwired I/O in RTU-7. Upon activation the flood shall be alarmed and indicated at SCADA HMI and RTU-7.

AH. LOOP 9360: BLOWER BUILDING TIGHT TANK HIGH LEVEL

1. A float switch (LSH-9360) mounted in the near Blower Building Tight Tank shall be monitored by the MTU PLC via hardwired I/O in RTU-3. Upon activation the high level shall be alarmed and indicated at SCADA HMI and RTU-3.
2. Provide an 8"x8" intrinsically safe electrical enclosure with a intrinsically safe relay for interface to the LSH-9360 relay. The relay shall receive power from the RTU-3 control panel.

1.19 COLLECTION SYSTEM LOOP DESCRIPTIONS

A. LOOPS 9500 to 9509: DEAN STREET SEWAGE PUMP STATION

1. The existing pump station has a wet well level transducer (LT-9500) and two raw sewage pumps (RSP-9501, RSP-9502, RSP-9503) controlled by variable frequency drives that are monitored and controlled by an existing RTU PLC. The RTU PLC shall be networked to the SCADA system via an existing town wide fiber optic network and the SCADA system shall display the following pump station's equipment status and alarms on the SCADA system HMI:
  - a. Wet Well level (LT-9500)
  - b. Wet Well level high alarm (LAH-9500)
  - c. Wet Well level high-high alarm (LAHH-9500)
  - d. Wet Well level low alarm (LAL-9500)

- e. Sewage Pump #1 running (YI-9501)
- f. Sewage Pump #1 alarm (YA-9501A)
- g. Sewage Pump #1 VFD alarm (YA-9501B)
- h. Sewage Pump #1 speed indication (SI-9501)
- i. Sewage Pump #2 running (YI-9502)
- j. Sewage Pump #2 alarm (YA-9502A)
- k. Sewage Pump #2 VFD alarm (YA-9502B)
- l. Sewage Pump #2 speed indication (SI-9502)
- m. Sewage Pump #3 running (YI-9503)
- n. Sewage Pump #3 alarm (YA-9503A)
- o. Sewage Pump #3 VFD alarm (YA-9503B)
- p. Sewage Pump #3 speed indication (SI-9503)
- q. ATS in emergency position (YI-9505)
- r. Utility Power Loss alarm (YA-9505)
- s. Generator #not in Auto (YI-9506A)
- t. Generator running status (YI-9506B)
- u. Generator alarm (YA-9506A)
- v. Generator failure (YA-9506B)
- w. Generator low fuel (YA-9506C)
- x. Generator fuel leak (YA-9506D)
- y. RTU control panel loss of 120 VAC power (JAL-9507).
- z. RTU control panel 24 VDC power supply failure (JAL-9508).

B. LOOPS 9510 to 9519: SOUTH STREET SEWAGE PUMP STATION

- 1. Functionally identical to LOOPS 9500 to 9509 except the existing pump station has a split wet well with two level transducers (LT-9510A, LT-9510B).



- C.    LOOPS 9520 to 9529: BURT STREET SEWAGE PUMP STATION
  - 1.     Functionally identical to LOOPS 9500 to 9509 except the third sewage pump is for future installation and shall be indicated as future on the SCADA HMI.
  
- D.    LOOPS 9530 to 9539: INDUSTRIAL PARK NW SEWAGE PUMP STATION
  - 1.     Functionally identical to LOOPS 9500 to 9509 expect the existing pump station has only two sewage pumps.
  
- E.    LOOPS 9540 to 9549: O'CONNELL WAY SEWAGE PUMP STATION
  - 1.     Functionally identical to LOOPS 9500 to 9509 expect the existing pump station has only two sewage pumps.
  
- F.    LOOPS 9550 to 9559: RED LANE SEWAGE PUMP STATION
  - 1.     Functionally identical to LOOPS 9500 to 9509 expect the existing pump station has only two sewage pumps.
  
- G.    LOOPS 9560 to 9569: ROUTE 140 SEWAGE PUMP STATION
  - 1.     Functionally identical to LOOPS 9500 to 9509 expect the existing pump station has only two sewage pumps.
  
- H.    LOOPS 9570 to 9579: SPRING STREET SEWAGE PUMP STATION
  - 1.     Functionally identical to LOOPS 9500 to 9509 expect the existing pump station has only two sewage pumps.
  
- I.    LOOPS 9580 to 9589: E. POLE SCHOOL PUMP STATION
  - 1.     Functionally identical to LOOPS 9500 to 9509 except the existing pump station utilizes a bubbler system for wet well level (LT-9580) monitoring and pump control in lieu of a level transducer. The following additional alarm shall be displayed the SCADA system HMI:
    - a.     Bubbler system pressure low (PSL-9589).
  
- J.    LOOPS 9590 to 9599: COLT CIRCLE SEWAGE PUMP STATION
  - 1.     Functionally identical to LOOPS 9500 to 9509 except the existing pump station has only two sewage pumps that are controlled by motor starters. Each pump has an overload alarm in lieu of the VFD alarm and do not have a speed indication.
  
- K.    LOOPS 9600 to 9609: SAKONET AVENUE SEWAGE PUMP STATION
  - 1.     Functionally identical to LOOPS 9500 to 9509 except the existing pump station has only two sewage pumps that are controlled by motor starters. Each pump has an overload alarm in lieu of the VFD alarm and do not have a speed indication.

L. LOOPS 9610 to 9619: WARNER BLVD. SEWAGE PUMP STATION

1. Functionally identical to LOOPS 9500 to 9509 except the existing pump station has only two sewage pumps that are controlled by motor starters. Each pump has an overload alarm in lieu of the VFD alarm and do not have a speed indication.

M. LOOPS 9620 to 9629: HART STREET SEWAGE PUMP STATION

1. Functionally identical to LOOPS 9500 to 9509 except the existing pump station has only two sewage pumps that are controlled by motor starters and utilizes float switches for wet well high level (LSH-9620), high-high level (LSHH-9620), and low level (LSL-9620) monitoring and pump control in lieu of a level transducer. Each pump has an overload alarm in lieu of the VFD alarm and do not have a speed indication.

N. LOOPS 9630 to 9639: SOUTH WALKER STREET SEWAGE PUMP STATION

1. Functionally identical to LOOPS 9500 to 9509 except the existing pump station has only two sewage pumps that are controlled by motor starters and utilizes float switches for wet well high level (LSH-9630), high-high level (LSHH-9630), and low level (LSL-9630) monitoring and pump control in lieu of a level transducer. Each pump has an overload alarm in lieu of the VFD alarm and do not have a speed indication.

O. LOOPS 9640 to 9649: TAUNTON HIGH SCHOOL SEWAGE PUMP STATION

1. Functionally identical to LOOPS 9500 to 9509 except the existing pump station has only two sewage pumps that are controlled by motor starters and utilizes float switches for wet well high level (LSH-9640), high-high level (LSHH-9640), and low level (LSL-9640) monitoring and pump control in lieu of a level transducer. Each pump has an overload alarm in lieu of the VFD alarm and do not have a speed indication.

P. LOOPS 9650 to 9659: WESTVILLE SEWAGE PUMP STATION

1. Functionally identical to LOOPS 9500 to 9509 except the existing pump station has only two sewage pumps that are controlled by motor starters and utilizes a bubbler system for wet well level (LT-9650) monitoring and pump control in lieu of a level transducer. Each pump has an overload alarm in lieu of the VFD alarm and do not have a speed indication. The following additional alarm shall be displayed the SCADA system HMI:

- a. Bubbler system pressure low (PSL-9659).

Q. LOOPS 9660 to 9669: MAIN LIFT PUMP STATION

1. Functionally identical to LOOPS 9500 to 9509 except the existing pump station has four sewage pumps in which pumps (RSP-9663, RSP-9664) are controlled by motor starters and the station utilizes a bubbler system for wet well level (LT-

9650) monitoring and pump control in lieu of a level transducer. The pumps controlled by motor starters have an overload alarm in lieu of the VFD alarm and do not have a speed indication. The following additional status and alarms shall be displayed the SCADA system HMI:

- a. Sewage Pump #4 running (YI-9644)
- b. Sewage Pump #4 alarm (YA-9644A)
- c. Sewage Pump #4 overload alarm (YA-9644B)
- d. Bubbler system pressure low (PSL-9669).

R. LOOPS 9670 to 9679: CSO FACILITY

1. The CSO Facility has a ultrasonic flow transducer (FIT-9670) that is monitored and by an existing RTU PLC. The RTU PLC shall be networked to the SCADA system via an existing town wide fiber optic network and the SCADA system shall display the following pump station's equipment status and alarms on the SCADA system HMI:

- a. CSO Flow (FIT-9670)
- b. UPS Failure (JAL-9676).
- b. RTU control panel loss of 120 VAC power (JAL-9677).
- c. RTU control panel 24 VDC power supply failure (JAL-9678).

1.19 SPARE PARTS

- A. Spare parts shall be provided as a part of the start-up services during the initial plant start-up and phase-in period. These items shall include accessories such as fuses, electrodes, membranes, fluids, charts, ink, lights, etc. required to start-up and operate the system for a period of 60 days. These items shall be packaged in separate containers and shipped to the job site with the instruments and shall be tagged "INSTRUMENT START-UP EQUIPMENT".
- B. Spare parts above and beyond those being provided for start-up services shall be provided under this Section. All spare parts shall be packaged and shipped at one time. Separate shipment of spare parts shall not be acceptable. The Engineer shall be notified of the shipment release in writing indicating that all items have been shipped. Each item shall be checked by the Engineer as being received and that all components have been provided as specified.
- C. Provide two complete lightning/surge protection units for both local and panel-mounted equipment as specified.
- D. Two boxes of spare fuses of each type being supplied. A box shall consist of a minimum of 24 fuses.

- E. Two spare lamps of each type.
- F. Two electrodes and/or membranes for each instrument being furnished for the system.
- G. One year supply of fluids and replacement parts required for all instruments and devices being furnished for the system.

## 2.0 PART 2 – PRODUCTS

### 2.1 GENERAL

- A. All equipment shall be of the latest proven design. First generation equipment with less than three years general use shall have documentation on construction operation, field test and user list.
- B. All equipment shall be suitable for operation in the environment of the Project.
- C. Transmission to and from analog devices shall be 4-20 mAdc.
- D. All signal converters, isolation transformers, uninterruptable power supplies (UPS), power regulators, or power converters shall be the responsibility of the instrument supplier. The loop descriptions herein do not specify all hardware required for proper operation. It is the responsibility of the Instrumentation supplier to furnish and install all necessary equipment for complete systems.
- E. All equipment necessary to complete the functional requirements of this Section shall be supplied by the Instrumentation and Control System Supplier and be of the same manufacturer unless otherwise specified (e.g. signal converters, integrators, computing devices alarm trips etc.) shall be of the same manufacturer as the recorders, controllers and indicators.
- F. All necessary fuses or switches required by the Instrumentation and Control System Supplier for his equipment shall be provided with the equipment. All instruments requiring an external power supply shall have an internal ON-OFF switch.
- G. Indicator, recorders, controllers, integrators, relays, and other receiving devices, when operating in a loop shall be of a design such that a failure of an individual device shall not effect the operation and integrity of the remaining loop functions. All indicators, recorders either remote or panel mounted shall have an individual internal on/off switch.
- H. Electronic transmitting equipment shall provide loop power. True 2-wire transmitter may have its loop power supplied in the receiving instrument, if available, or by a plug in power supply mounted in the receiving instrument panel.
- I. All conductors running from the field to the control panel shall be of a single, continuous length, without splices except at approved junction boxes. The junction boxes shall have terminal blocks with 20 percent spares in addition to terminals for all wires including spare wires. Special care shall be exercised to carry grounding lines through such junction boxes with the least possible resistance.

- J. Multi-conductor cable may be used between junction boxes and control panels.
- K. All shielded cable shall be grounded at the control panel end only. Shields shall be carried through junction boxes with the least possible resistance and kept isolated from ground at these points. The field end of the shield shall be insulated to prevent grounding.
- L. All field electronics and outdoor control panel equipment shall be suitable for operation in ambient temperatures of -40 degrees F to 140 degrees F. All indoor control panel located electronics shall be suitable for operation in ambient temperatures of 40 degrees F to 120 degrees F.
- M. All external connection points shall be made at terminal blocks with No. 6-32 or larger screws.
- N. Nameplates shall be provided on all field mounted transmitters, level relays, control panels, indicators, etc. Nameplates shall be identical to those specified for Control Panels.

## 2.2 CONTROL PANELS

- A. Control panels as noted in the table at the end of this Section shall be furnished under Section 13321 (Instrumentation and Control System). The panels shall be UL 508A Listed assembly.
- B. The instrumentation system supplier shall provide all instrument devices necessary for proper input/output (I/O) operation. This shall include all signal conditioning, isolation and operation equipment.
- C. The above panels shall be completely assembled and wired at the factory. See contract drawings and specifications for exact location of each of the control panels.
- D. All equipment shall be designed to operate on a 60-Hertz alternating current power source of 105 to 135 volts except as noted. All regulators and power supplies required for compliance with the above shall be provided between supply and interconnected instrument loop. Where equipment requires voltage regulation, constant voltage transformers shall be supplied. Materials and equipment used shall be U.L. approved wherever such approved equipment and materials are available.
- E. All controls for electrically operated or motor-driven equipment shall be complete, including all necessary auxiliary relays so as to require only wiring and connections to the equipment control circuit. All contacts for control of motor-operated or electrically operated equipment shall be rated not less than 120 VA unless otherwise specified herein.
- F. Nameplates and Nametags
  - 1. Nameplates shall be provided for all flush mounted equipment. The nameplates shall be approximately 1 inch x 3 inch constructed of black and white laminated, phenolic material having engraved letters approximately 1/4 inch high extending

through the black face into the white layer. Nameplates may be omitted if a nameplate of approximately the same dimension is more conveniently and suitable located on the instrument door or face. Nameplates shall be attached to panels by self-tapping stainless steel screws or rivets. Nameplates shall be provided for each control panel identifying the panel and shall be located at the top center of the panel. Size of nameplate shall be as required for proper visual identification.

2. Nametags shall be provided for all equipment located within the control panel. Each and every device shall be tagged with embossing tape nametags with identification reference which shall correspond to all drawings and wiring diagrams for the system. The nametags shall be neatly installed and shall be clearly visible for service and maintenance of the equipment.
- G. All panel equipment shall be pre-piped and/or pre-wired on or within the cabinet. All wiring shall comply with local and National Electrical Code in open bundles wired to numbered terminals. Each cabinet shall have at least an additional 25 percent spare terminals. A plug-in header with convenience outlets and flexible plug-in leads shall be supplied for each instrument power supply. Two spare convenience outlets shall be provided, and an overhead internal gasketed LED light shall be provided as specified. Cabinet layouts shall be submitted to the Engineer for approval. Materials and equipment used shall be U.L. approved wherever such approved equipment and materials are available.
- H. All equipment shall be designed and constructed so that in the event of a power interruption, the equipment specified hereunder shall resume normal operation without manual resetting of alarms or power source when power is restored.
- I. All interconnecting wire and wiring to terminals for external connections shall be not less than No. 16 AWG copper insulated for not less than 600 volts with a moisture and heat resistant material and flame retardant nonmetallic covering. Terminal blocks for No. 12 AWG external connections shall be furnished complete with marking strip, covers, and pressure connectors similar to G.F. Company Type BB-6 terminal boards. All wiring shall be grouped or cabled and firmly supported to the panel. All wiring shall be completely tagged and numbered throughout the panel. The number designation shall be the same throughout the panel and each wire shall be tagged with number strips at intervals of no less than 12 inches. Not less than 8-inch clearance shall be provided between the terminal strips and the base for conduit and wiring space. All instruments and devices shall be separately fused as required to protect the equipment. Shielded conductor pairs to control modules, and analog equipment shall be brought directly to terminals provided.
- J. Terminal strips shall be provided for the purpose of connecting all control, power, and signal wiring. Provide separate terminal strips for each in order to isolate the different wiring types (power, control, and signal). All terminal strips shall be completely labeled and numbered throughout for each and every unit. Direct inter-wiring between equipment will not be allowed.
- K. Control Panels shall receive an electrical service as specified herein and controls shall receive their power from this power source. Refer to these specifications further for

details. The control panel shall be provided with the required fuse protection. Provide a lug for grounding connection up to a No. 1/0 AWG conductor. Fuses shall not be in excess of 15 amperes. Panels shall be provided with a separate main circuit breaker and electrical panelboard with individual circuit breakers for feeding equipment located within the panel. Panelboard shall be arranged as required in this section.

- L. Only one side of a terminal block row shall be used for internal wiring. The field wiring side of the terminal shall not be within 6 inches of the side panel or adjacent terminal. Wiring troughs shall not be filled to more than 60 percent visible fill. Wiring trough covers shall be match marked to identify placement. If component identification is shown on covers for visibility, the I.D. shall also appear on the mounting sub-panel.
- M. Uninterruptible Power Supply (UPS)
  - 1. The Instrumentation and Control System Supplier shall provide UPSs, including internal/external batteries, for maintaining power to the control system devices and instrumentation as specified herein.
    - a. A UPS shall be provided within each control panel.
  - 2. Each UPS shall protect the system from noise, dips, spikes and planned reductions in voltage by utility companies. The UPS shall meet ANSI C62.41/IEEE 578 A&B standards for transients/lightning protection.
  - 3. Each UPS shall be a true UPS type that continuously operate from the inverter (zero transfer time) and shall output a true high quality low distortion sinusoidal waveform synchronized to the AC utility.
  - 4. The batteries shall be sealed, maintenance free lead-acid type. The batteries shall provide 30 minutes of backup power at full load when fully charged.
  - 5. Each UPS shall have a fail-safe transfer to bypass for UPS internal electronic failures.
  - 6. A UPS installed in a control panel shall be wired into the control panel power distribution circuit so that the UPS can be easily and quickly bypassed while maintaining AC utility power to panel devices and instruments. A UPS installed in a control panel shall be DIN-rail or shelf mounted so that the UPS is above the bottom of the control panel.
  - 7. UPS sizing shall be as follows:
    - a. A UPS shall be 750 VA minimum but shall be sized by the Instrumentation and Control System Supplier to provide back up power to the control panel instrumentation and devices for 30 minutes at full load.
  - 8. Provide UPS sizing calculations for review and approval by the Engineer.
  - 9. The UPS shall be by APC, MGE, Tripp-Lite, Behlman, or equal.

- N. All miscellaneous components shall be heavy-duty industrial type, or equal. Mounting hardware shall be stainless steel. All cutouts shall be made true and square with no ragged cuts. The finished cutout shall be deburred, with no sharp edges. All welds shall be ground smooth and be deburred with no sharp edges. Welding on the panel face should be minimized. Adequate stiffness and supports shall be provided to insure a rigid stable structure.
- O. The finished enclosure shall be properly degreased; prime painted (2 coats) and finish painted (2 coats) in accordance with the paint manufacturer's instructions, prior to the installation of equipment. The final finish shall be smooth, free of runs, and uniform in tone and thickness. Two, 1-pint containers of each color used shall be supplied with the panel for field touch up. Unless otherwise noted on the drawing or data sheets the colors to be used shall be selected by the Owner from color chips supplied by the panel manufacturer.
- P. Brushed anodized aluminum; stainless steel and F.R.P. panels with color gel coat will not require a paint finish.
- Q. The individual control panels shall be further identified within this section.

R. Control Panel

1. Control panel shall be wall a mounted enclosure with NEMA types as noted Control panels list at the end of this Section. The unit shall be properly sized to handle all equipment and instrumentation devices with sufficient spacing between all devices. Doors shall be hinged panel type for front access. The manufacturer of the panel shall provide all ventilation required to maintain proper operating temperature within the panel for all system components.
2. The panel shall be properly sized to handle all input/output and instrumentation devices with sufficient spacing between all devices. This shall include all terminal points and separation between signal and discrete I/O points.
3. The panel shall be properly sized to handle all internally mounted devices. This shall include PLC system, I/O rack, current to current converters, PLC telemetry equipment, terminals, current trip relays, etc., and all other equipment described in this section and as shown on the drawings.
4. The panel shall be free of dents or other defects.
5. Provide Ethernet switch to create an Ethernet network between equipment as specified herein.
6. Provide with a front door mounted data interface port with a CAT6 Ethernet port and a GFCI receptacle.
  - a. The data port shall be UL listed for outdoor use and have a lockable clear weather tight cover.



- b. The Ethernet port shall be connected to the control panel's Ethernet switch.
  - c. The GFCI receptacles shall be powered from the control panel's incoming 120V AC power via fuses or a circuit breaker.
7. Provide redundant 24VDC power supplies, power isolation and an uninterruptible power supply (UPS) system within the control panel.
  8. Provide ventilation equipment as required to properly maintain equipment operation and heat dissipation.
  9. Provide LED lighting fixtures inside at top of panel with light switch. Number of fixtures as required for sufficient lighting to perform maintenance and troubleshooting.
  10. Provide ground lug.
  11. Provide one duplex receptacle on either end of the control panel for convenience of 120 volt power during service and maintenance of equipment.
  12. Print storage pockets shall be provided on the inside of each panel and shall be of sufficient size to hold all of the prints required to service the equipment.

## 2.3 PROGRAMMABLE LOGIC CONTROLLERS (PLC's)

### A. General

1. Furnish and install a complete modular PLC based control system at the water treatment facility. This section of the specifications shall provide the hardware requirements for each of the PLC's to be provided for this project. In order to provide a complete and compatible system, this section of the specifications shall be referred to by other related sections. This has been done in order to provide equipment to be supplied by others, which is of the same manufacturer as this section for a completely compatible system architecture and structure.
2. Each PLC system provided at each control panel shall come equipped with 20 percent spare I/O of each type utilized and the capability for an additional 20 percent future I/O of each type utilized.

### B. PLC Platform

1. Furnish and install the control system in accordance with the Performance Criteria Section of this specification and as detailed on the Contract Drawings. Each PLC shall include but not to be limited to: processor module (CPU), communications interface module, power supplies, software for PLC programming, operator interface system diagnostics, communications, data acquisition, and module racks. The PLC shall collect data, process control functions, communicate with other PLCs, distribute process information along the data highway, and may have their program down loaded from programmer's

terminal, and be locally programmed from a portable laptop computer messages (report by exception) to an operator interface to reduce network traffic.

2. The PLC system shall be furnished by a single vendor who has actively been manufacturing programmable logic controllers of the required specified capabilities and whose products have operated successfully for a period of at least eight years. All PLC equipment shall have the following agency approval: UL, CSA, FM Class 1, Div. 2. All PLC equipment shall have a three (3) year factory warranty.
3. The PLC system manufacturer shall maintain, as part of a national network, engineering service facilities within 200 miles of the Project, to provide start-up service, emergency service calls, repair work, service contracts, maintenance, and training of Department personnel. Emergency service shall be available within twenty-four hours of notification.
4. PLC equipment and related hardware shall be Allen Bradley Controllogix.

#### C. Construction

1. The programmable logic controller and operator workstation shall be designed, manufactured and tested to the latest applicable NEMA, IEC, ANSI, and IEEE standards. The programmable logic controller shall meet or exceed the following industry standard specifications:
  - a. RFI Immunity: ICS 2-230
2. The PLC and operator workstation shall be solid state, modular, and field expandable design allowing the system to be tailored to meet the application. The design shall have the capacity to allow for the expansion of the system by the addition of hardware and/or software.
3. The PLC and all of its components shall be capable of operating in an ambient temperature of 0 to 60 degrees Celsius (32 to 140 degrees Fahrenheit) and shall function continuously in the relative humidity range of 0-95 percent non-condensing.
4. Each PLC system shall include, but not be limited to, the following:
  - a. I/O chassis
  - b. Local I/O modules
  - c. Power Supply
  - d. Processor modules
  - e. Remote I/O scanner module
  - f. Remote I/O module
  - g. Cables
5. Each unit shall be capable of handling the required number of process inputs and outputs as specified herein and shown on the Contract Drawings, plus 15 percent active spares, plus capacity to accommodate 20 percent future inputs and outputs

by the addition of the required circuit cards.

6. The PLC shall be capable of stand-alone operation in the event of a communication link failure.
7. All system modules, main and expansion chassis shall be designed to provide for free airflow convection cooling. No internal fans or other means of cooling, except heat sinks, shall be permitted.
8. Nameplates shall be provided for each module, device and equipment with appropriate data such as equipment number, rating, serial number, and manufacturer.

D. Central Processing Unit (CPU)

1. The CPU shall read the inputs, perform all system logic, conduct on-line diagnostics, and control the outputs. Diagnostics shall include memory checks, communications monitoring, I/O monitoring, watchdog timing, and user program validation. If an I/O module fault is detected, the processor shall turn off the affected module.
2. The CPU shall be a self-contained unit, and shall provide ladder rung program execution and support remote or local programming. The CPU shall provide I/O scanning and inter-processor and peripheral communication functions.
3. The CPU shall give visual indication by illuminating an indicator when no fault is detected and an indicator when a fault is detected.
4. The main CPU front panel shall include two communication ports, one USB for local programming the other a Ethernet port for connection into the Ethernet switch to allow Remote I/O, OIT, remote programming, data transfer, and SCADA connections. The Ethernet connector shall support communication to as many as 250 nodes.
5. The main chassis front panel shall include, but not be limited to the following:
  - a. Run mode of the CPU
  - b. Fault status of the CPU
  - c. Forced I/O
  - d. Battery Low Condition
  - e. If a remote device is communicating via the inter-processor communications link
6. A minimum of 20MB of internal, solid-state RAM memory shall be provided for storage of the control program. The full memory of the CPU shall be useable for program or data storage.

7. Program back-up shall be battery backed RAM along with EEPROM for reliable program back-up.
8. Program functions shall include standard functions: contacts, coils, timers, counters, math functions, (add, subtract, multiply, divide) shift registers, bit, and word operations; and advanced functions: floating point math calculations including integer to floating point conversion, floating point to integer conversion, add, subtract, multiply, divide, square root, compare, and trigonometric functions.
9. Program functions shall include PID closed loop and cascaded PID loop control. The PID loop shall perform:
  - a. Output tracking for bumpless transfer between auto and manual mode.
  - b. Reset windup limiting.
  - c. Process variable alarming.
  - d. Output preloading or bias.
  - e. Adjustable rate filtering.
  - f. Adjustable solution time base of 0.1 to 20.0 seconds.
10. The CPU shall include an integral real-time clock, backed up by an internal lithium or long term type battery, which can be accessed from the control program. The clock shall include functions for time of day (year, month, day, hour, minute, second, and day of the week), alarm, and operation hours counter.
11. The CPU shall permit changing ladder program and data values while running.
12. The CPU shall permit the addition of application specific instructions, created in a high level language, to augment the standard instruction set.

E. Power Supply

1. The programmable controller shall operate in compliance with a nominal electrical service of 85 to 132 VAC, single phase, and in the frequency range from 47 to 63 Hz.
2. The PLC power supply shall be of sufficient capacity to provide all required DC power to all PLC equipment, discrete and analog input/output circuitry under full load, and chassis-mounted communications equipment. The power supply shall be capable of providing 5 VDC, 12 VDC, 24 VDC or other required power to the CPU, I/O modules, chassis-mounted communication devices, and to other elements within the PLC.

F. PLC Modules

1. All field wiring shall be to a removable terminal block, which will permit prewiring of the module, or removal and replacement of a module without disturbing the field wiring or any other I/O modules. All I/O modules shall be firmly attached to the I/O chassis.

2. All discrete I/O wiring shall be minimum No 14 AWG, RHW-2, 600 volt.
3. All modules shall be enclosed in rugged plastic, or metallic housings.
4. Input and output modules shall have faceplates which shall be marked or labeled in accordance with the Contract Drawings.
5. Inputs shall be optically isolated to protect bus circuits from transients and surges. Light emitting diodes, one adjacent to each pair of input terminals shall be provided to indicate a closed contact, conducting transistor switch; a low positive logic level, or AC line voltage on conditions.
6. All DC output circuits shall incorporate reverse voltage protection and AC output circuits shall include fuses. Dry contact output contacts shall be rated for 10 amperes at 120 volts AC minimum. Isolation resistance shall be 1000 ohms minimum at 300 volts DC between any set of field terminals and any other set or earth ground. Isolation voltage shall be 1500 VAC rms. minimum between any set field terminals and any other set or earth ground. Light emitting diodes shall be provided adjacent to each pair of output terminals for on status indication. Dry output contacts shall be provided for all field device digital output control.
7. The analog input modules shall have a maximum of four isolated differential channels per module and shall accept 4-20 mADC from field-mounted transmitters. Over voltage protection shall be 7.5 Vac RMS. Input signal conversion shall be a minimum of 14-bit resolution.
8. Analog output modules shall have a maximum of four isolated differential channels per module and shall convert 14-bit data words into proportional, isolated 4-20 mA DC analog output signal. Output load drive capability shall be 500 ohms minimum for each output. Accuracy shall be +0.298 percent of full-scale output span. Analog output modules shall be selectable on a point per point basis to either hold the last state or to return to zero upon reset or stop of the programmable controller.

G. PLC Programming

1. The programming format shall be traditional relay ladder diagram.
2. It shall be possible to program a maximum instruction matrix of eleven wide by seven deep containing as many as 70 examine instructions.
3. The capability shall exist to change a contact from normally open to normally closed, add instructions, change addresses, etc. It shall not be necessary to delete and re-program the entire rung.
4. It shall be possible to insert relay ladder diagram rungs anywhere in the program, even between existing rungs, in so far as there is accommodated these additions.
5. Timer instructions shall include selectable time bases in increments of 1.0 second

and 10 milliseconds. The timing range of each timer shall be from 0 to 65,535 increments. It shall be possible to program and display separately the timer's preset and accumulated values.

6. The programmable controller shall store data in the following formats:
  - a. Single integer numbers ranging from 0 to 65,535.
  - b. Floating point numbers conforming to IEEE floating point format
  - c. Decimal numbers ranging from 0 to 9,999
7. At the request of the programmer, data contained in system memory shall be displayed on the CRT programming panel. This monitoring feature shall be provided for input/output status, timer/counter data, files, and system status. Ladder logic rungs shall be displayed on the CRT with rung numbers in sequential order.
8. The system shall have the capability to enter address comments and symbols.
9. The programming software shall also provide the following functions:
  - a. Full on-line and off line capabilities from one integrated software package.
  - b. Hot Keys: Keys for short cut to software functions.
  - c. File Management: Create, Delete, rename, and merge program files.
  - d. Memory Map: Display processor memory usage.
  - e. Data Monitor: Display the contents of data files.
  - f. Save & Restore: Save processor memory files to disk; restore processor memory files from disk.
  - g. I/O Configuration: Configure intelligent I/O modules.
  - h. General Utility: Display general system information and clear faults.
  - i. Forcing: Force I/O on and off.
  - j. Import & Export: Convert database files (which contain symbols, rung comments, instruction comments, and address comments) and processor memory files to ASCII and from ASCII to the programming software.
  - k. Display I/O module health status.
  - l. Password Protection: Allow up to eight password protected levels of functionality with each level increasing the capability to monitor, troubleshoot, and program.
  - m. The programming software shall reside in the operator workstation(s) or

portable programming unit.

#### 2.4 OPERATOR INTERFACE TERMINAL (OIT):

- A. An operator interface terminal shall be configured to enable operators to monitor and control equipment processes. Communications between the operator interface and the PLC shall be completely transparent to an operator.
- B. The operator interface shall have a Windows-based graphic editor. The graphics development kit shall include all necessary components for creation of graphic displays on Windows-based IBM compatible PC and a communications cable to facilitate downloads to the operator interface.
- C. The operator interface shall be powered from a 24 VDC power supply or 120 VAC, 60 Hz power supply. The operator interface shall be capable of operating in a temperature range of 0 to 55 C, and 5 to 95% relative humidity, non-condensing. The operator interface display shall be a 10" minimum color touch screen with a resolution of 800 by 600 SVGA 18 Bit color graphic.

#### 2.5 EQUIPMENT

- A. The INSTRUMENT LOOP DESCRIPTION, DIAGRAMS, AND INSTRUMENT LIST included at the end of this section indicate the intent of the process and interconnection between INSTRUMENTS. EQUIPMENT specified herein does not purport to cover all equipment that may be required to complete the process intent. Numbering identification is based on ISA standard. The instrument index sheets included within this section of the specifications have been furnished to summarize the system equipment and to list the operating parameters for this equipment. This list may not completely include all the required equipment necessary for a completely operational system. The instrument supplier shall provide all necessary equipment required in order to perform the function for the system.
- B. Industrial Ethernet Switch
  - 1. The industrial Ethernet switch shall have minimum eight 10BASE-T/100BASE-TX RJ-45 ports and two 100Mbps fiber optic ports. RJ-45 ports shall support auto negotiation or manual configuration for 10/100 MHz or full/half duplex.
  - 2. The industrial Ethernet switch shall be IEEE 802.3 compliant. The switch shall support 10BASE-T, 100BASE-TX and 100BASE-FX standards. The switch shall support IEEE 802.3x flow control. Port setting controls shall include enable/disable and speed selection. The switch shall use store-and-forward switching mode.
  - 3. The industrial Ethernet switch shall have an LED power indicator and shall operate from a 24 VDC power source if panel mounted and 120 VAC otherwise. The switch shall have LEDs for link status. The switch shall have a fault relay contact. The switch shall be suitable for operating from 0°C to 50°C and from 10 percent to 95 percent non-condensing relative humidity. The switch shall be UL approved. The switch shall be suitable for DIN-rail mounting if mounted within

a control panel.

4. The industrial Ethernet switch shall support a tree or ring network topology. The switch shall support SNMPv3 and IP addressing via BootP/DHCP. The port configurations shall be accessible through a standard Web browser.
5. The industrial Ethernet switch security features shall include capability to disable ports and password security for configuration. The switch shall support multicast messaging via IGMP protocol and shall utilize IGMP snooping. The switch shall support port based virtual LAN (VLAN) configuration. The switch shall support the IEEE 802.1p standard for QoS traffic prioritization. The switch shall come supplied with configuration and management software for installation on a Windows-based PC. The switch shall come supplied with all necessary cables to connect the switch to a Windows-based PC for configuration.

C. Electrical Relays

1. Electrical relays for handling power circuits shall be general purpose equal to IDEC, Omron, Allen-Bradley, Potter & Brumfield, or approved equal. Relays handling control, telemetering or alarm functions shall be heavy-duty, plug-in type, complete with dust and moisture proof enclosure equal to IDEC, Omron, Allen-Bradley, Phoenix Contact, Potter & Brumfield, or approved equal. Units shall be provided with integral indicating light to indicate if relay is energized. Units shall have DPDT relay contacts and be rated for 10 A at 120 VAC, 10 A at 24 VDC
2. Time delay relays shall have DPDT relay contacts and be suitable for on-delay or off-delay operation. Rated load shall be 10 A at 120 VAC, 10 A at 24 VDC. Units shall be provided with integral time-delay adjustment knob. Relays shall be provided with dust and moisture resistant covers. Relays shall be suitable for operating in a temperature range from -30° to 55° C. Units shall be adjustable and available in a single range or multiple ranges from 0.1 second to 10 hours. Time delay relays shall be UL listed. Mounting sockets matched to relay and mounting rails/holders shall be provided as required. Time delay relays shall be as manufactured by IDEC, Allen Bradley, or Engineer-approved equal.

D. Current-to-Current Converters

1. Current to current converters shall transform a current input signal (1-5, 4-20, or 10-50 mA) to a proportional 4-20 mA current output signal. The unit shall be of solid state electronic circuitry sealed in a protective epoxy compound, and shall be for surface or rear of panel mounting.
2. Current to current converters shall provide signal conversion capabilities, input/output isolation and output power boosting.
3. Signal output drive capability shall be 4-20 mA into 600 ohms load.
4. Accuracy shall be 0.25 percent of span.



E. Lightning/Surge Protection

1. Lightning/surge protection shall be provided to protect the instrumentation system from induced surges propagating along the signal and power supply lines. The protection systems shall be such that the protective level shall not interfere with normal operation, but shall be lower than the instrument surge withstand level, and be maintenance free and self-restoring. Ground wires for all surge protectors shall be connected to a good earth ground and where practical each ground wire run individually and insulated from each other.
2. Protection of all 120 volt ac instrument cabinet power supply lines and individual field instruments shall be provided. Cabinets shall be protected by isolation transformers and surge suppressers.
3. The unit shall be back panel mounted and is to be connected between the telephone line and the telemetry and control equipment. Transient voltages above 90V line to ground or 180V line to line will cause the gas discharge tubes to short to ground. If the peak lasts more than an instant, 1/4 amp fast blow fuses will open the line.
4. Protection of circuits connected over leased or private telephone lines shall be provided with surge and lightning protectors at signal terminal in addition to the normal fused lightning arrestor supplied by the telephone company.
5. Lightning/surge protection units shall be as manufactured by Joslyn Industries or equal.
6. All remote loop powered transmitters shall be provided with close-nipped lightning/surge protection units. The loop shall be terminated at the receiving device/panel with a receiving end lightning/surge protection unit. This shall be provided to all remote equipment for this project.

F. Power Supplies

1. All two-wire loop powered equipment and all devices requiring 24 VDC power shall be provided with individual power supplies or shall be powered from a redundant power supply configuration such that there is no interruption in power supplied upon a failure of one of the redundant power supplies.
2. The final requirements and exact locations for the power supplies shall be the responsibility of the Instrumentation and Control System Supplier. These units shall be provided and sized to handle all possible load conditions with sufficient capacity.
3. All power supplies shall be of the same manufacturer and of the same type wherever possible. Power supplies shall be DIN-rail mounted.
4. All power supplies shall be regulated and shall be suitably protected during the operation of the unit and also incorporate protection to the equipment it serves.
5. Each power supply shall have a Form C dry contact wired to the PLC I/O for

indication of power supply failure.

6. Power supplies shall be a manufactured by Sola, Phoenix Contact, Omron, or equal.

## 2.6 INSTRUMENTATION

- A. Refer to Specification 13320 – INSTRUMENTATION.

## 3.0 PART 3 – EXECUTION

### 3.1 INSTALLATION

- A. Instrumentation and accessory equipment shall be installed in accordance with the best field and shop practices.
- B. The workmanship shall be in accordance with the best field shop practices for the instrument and control systems.
- C. All workmen shall be skilled in the work to which they are assigned and all work shall be performed under the direct supervision of an experienced and competent instrument foreman.
- D. All wiring and piping shall be constructed perfectly plumb, square, level, and true to lines and surfaces indicated in a neat, substantial and workmanlike manner, and in such a way as to properly serve for the purpose intended. All members and parts, upon installation, shall be properly framed, secured together and anchored in place. All cuts shall be deburred and immediately cleaned from opposite end before connecting.
- E. All instruments shall be mounted, piped and connected in strict accordance with the manufacturer's instructions.
- F. All internal wiring of the instrument panel shall be done by the panel manufacturer in accordance with the drawings and instrument manufacturer's instructions.
- G. The loops on the drawings and the instrument specifications and index sheets indicate the intent of the interconnections between and the type of individual instrument. The proposed equipment shall be complete with all mounting hardware and accessories to satisfy the functional requirements.
- H. All work shall be executed in full accordance with codes and local rulings. Should any work be performed contrary to said rulings, ordinances and regulations, the Contractor shall bear full responsibility for such violations and assume all costs arising therefrom.
- I. All piping to and from field instrumentation shall be provided with necessary unions, test tees and shut-offs.
- J. Interfacing fixtures shall be compatible with the equipment to which they are attached and shall comply with the applicable specifications.

- K. In-line devices, flow or level elements, specified herein shall be installed under DIVISION 15 - MECHANICAL.
- L. Wiring of in-line devices, flow or level elements, specified herein shall be installed under DIVISION 16 - ELECTRICAL.
- M. Coordination with the process and equipment in addition to standard quoted fixtures require to conform the instrumentation to the process shall be the responsibility of the Contractor. The instrument and control system supplier shall provide detail information on the fixtures being supplied and the extent of the field installation required.
- N. Brackets and hangers required for mounting of equipment shall be provided as noted on the drawings or as required. They shall be done in a workmanlike manner and not interfere with any other equipment.
- O. Investigate each space in the building through which equipment must pass to reach its final location. If necessary, the manufacturer shall be required to ship his material in sections sized to permit passing through such restricted areas in the building.
- P. The shield on each process instrumentation cable shall be grounded as directed by the manufacturer of the instrumentation equipment but in no case shall more than one ground be employed for each shield.
- Q. Maximum practical separation shall be maintained between signal (analog, alarm, and status) conduits and power feeders and AC systems.
- R. All conductors running from the field to the control panel shall be a single, continuous length without splices, except at approved junction boxes. The junction boxes shall have terminal blocks with 20% spare in addition to terminals for all wires including spare wires. Special care shall be exercised to carry grounding lines through such junction boxes with the least possible resistance.
- S. Multi-conductor cable may be used between junction boxes and control panels.
- T. All field conductors shall terminate at the control panel terminal board. Millivolt signal wires (i.e., thermocouple) may be connected direct to the input terminals of the receiving instrument if so specified.
- U. All wire ends shall be terminated with hook fork type non-split compression lugs.
- V. All wire ends shall be identified at both ends with wire markers.
- W. Entry to field enclosures shall be through the back, side, or bottom (not top) with weatherproof hubs. Wiring shall enter near the terminal point and not obstruct access to removal of components.
- X. Lifting rings from cabinets/assemblies shall be removed. Hole plugs shall be provided for the holes of the same color as the cabinet.

### 3.2 START-UP

- A. Prior to final connection to the main instrument control panel, the Contractor shall thoroughly clean all work completed including the interior of all panelboards; and remove all dirt, trash, and foreign material. The outside of all instrument panelboards are to be cleaned and damaged painted surfaces touched up as required to leave the equipment in an acceptable condition. This shall include all nameplates, tags, and identification of equipment and devices within or on the front of the panels.
- B. No form of energy shall be turned on to any part of the instrumentation system prior to receipt by the Engineer of a certified statement of approval of the installation from the Contractor containing his supplier's authorization for turning on energy to the system.
- C. It shall be the responsibility of the vendor to provide a factory trained and qualified serviceman from the manufacturer's of the equipment to TEST AND CALIBRATE ALL EQUIPMENT and to INSTRUCT the Contractor on EQUIPMENT INSTALLATION and the ENGINEER on operation of the equipment.
- D. No other instrumentation system manufacturer's personnel other than those persons directly from the service department of the manufacturer of the equipment shall be acceptable to perform this work.
- E. The start-up services shall be performed by qualified personnel from the service department of the equipment manufacturer with a minimum of five years experience on the equipment being provided by this contract, or equal.
- F. During the start-up, the Contractor shall provide sufficient personnel to aid with the start-up of the instrument and control equipment to be provided and installed by this Section and by this Contract. This shall include services to correct any faults and to make the necessary adjustments for the proper operation of the equipment and installation.

### 3.3 TESTING AND CALIBRATING

- A. Testing and calibration of equipment shall be done in the presence of the Engineer.
- B. Prior to electrical check out all breakers, switches and similar disconnect devices shall be placed in the off position.
- C. The panel and other equipment grounding shall be verified.
- D. Visual inspection and continuity testing shall be made to verify that no damaging wiring errors occur between power and signal wiring.
- E. The systems shall be checked for improper or accidental grounding.
- F. Each system and component shall be energized and their inputs simulated. The output shall be checked to verify the proper calibration and interaction with associated hardware.
- G. Hypotting shall not be permitted on instrument systems unless specific instructions are

given to safeguard electronic equipment from damage.

- H. Prior to actuating a final control element (valve, level actuator, or variable frequency drive) the Contractor shall obtain the permission of the Engineer and any other involved contractors to prevent damage to associated equipment.
- I. The factory serviceman shall verify the calibration and direction of the final control element in accordance with the requirements for each portion of the system.
- J. Instrument and control calibration and control loop checkout shall be the responsibility of the manufacturer of the equipment.
- K. The Contractor shall arrange for and obtain the services of a factory trained service qualified engineer from the manufacturer's of the equipment to perform the calibration and commissioning of the entire system.
- L. Each instrument shall be calibrated at 10 percent, 50 percent, and 90 percent using test instruments that are rated to an accuracy of at least five times greater than the instrument being checked. The test instrument shall have its accuracy traceable to the National Bureau of Standard as applicable.
- M. Upon completion of the work, the Contractor shall demonstrate to the Engineer the proper operation of all equipment and systems.
- N. The Contractor shall deliver to the Engineer all test data, inspection test certificates, manufacturers' warranties certified calibration data, certified prints, manufacturers' installation, operation and maintenance manuals, electrical wiring and control diagrams with all noted field modification for an as-built record for the system, and required and suggested spare parts lists.
- O. A factory test shall be scheduled by the instrumentation system manufacturer for the entire system. A simulated system layout which shall include all equipment and interconnections shall be arranged to perform all system functions. The testing shall be performed in the presence of the Engineer. A two week written notification shall be provided to the Engineer to allow for scheduling the testing.
- P. Upon completion and satisfactory performance an approval notification shall be provided for this portion of the work for this Section. No equipment shall be allowed to be shipped from the factory without approval for this portion of the work.

### 3.4 MANUFACTURER'S SERVICES

- A. The supervisory service of a factory-trained service engineer who is specifically trained on the type of equipment herein specified shall be provided for a period of not less than four 8-hour days during construction to assist the Contractor in equipment installation, the location of sleeves, methods of installing conduit and special cable, mounting, piping and wiring of one of each type of device, and the methods of protecting all of the equipment prior to placing it into service. Upon completion of the installation, the services of the above service engineer shall be provided for a period of not less than six 8-hour days for calibration, testing and start-up of the equipment. The instrumentation

system supplier shall conduct a group training program on the operation and routine maintenance of the system. The training shall be conducted at the installation site and consist of five classroom and field training sessions, 8 hours a day during normal working hours. The text shall be the loop diagrams, operation and maintenance manual and shall concentrate on the operation of the equipment as applied to this process. The minimum days specified above do not relieve the manufacturer of providing sufficient service to place the system in satisfactory operation.

### 3.5 PRODUCT HANDLING

- A. Upon completion of shop assembly and testing, all control panels shall be enclosed in heavy-duty polyethylene envelopes or secured sheeting to provide complete protection from dust and moisture. Dehumidifiers shall be placed inside the polyethylene coverings. The equipment shall then be skid-mounted for final transport. Lifting rings shall be provided for moving the equipment without removing protective covering. Boxed weights shall be shown on shipping tags together with instructions for unloading, transporting, storing and handling at the job site.
- B. Special instructions for proper field handling and installation required by the manufacturer for proper protection shall be securely attached to each piece of equipment prior to shipment.
- C. Each package shall be tagged to identify its location, tag number and function in the system. Identification shall be prominently displayed on the outside of the package.
- D. A permanent stainless steel or other noncorrosive material tag firmly attached and permanently and indelibly marked with the instrument tag number as given in the tabulation shall be provided on each piece of equipment supplied under this section.
- E. Equipment shall not be stored out-of-doors. Equipment shall be stored in dry permanent shelters and, including in-line equipment, shall be adequately protected against mechanical injury. If any apparatus has been damaged, such damage shall be repaired or the damaged equipment replaced by the Contractor at his own cost and expense. If any apparatus has been subject to possible injury by water, it shall be thoroughly dried out and put through such tests as directed by the Engineer. This shall be at the cost and expense of the Contractor or the apparatus shall be replaced by the Contractor at his own expense.

### 3.6 WARRANTY

- A. The SCADA System shall be warranted for one year from the date of substantial completion.

**CONTROL PANEL LIST**

<b>Designation</b>	<b>Description</b>	<b>Location</b>	<b>NEMA Rating</b>	<b>Material</b>	<b>Min. Height</b>	<b>Min. Width</b>	<b>Min. Depth</b>	<b>Mounting</b>	<b>UPS</b>	<b>OIT</b>
MTU-CP	Main Terminal Unit SCADA Control Panel	Operations Building Control Room	12	Galvanized steel	60-in	30-in	12-in	Free Standing	YES	NO
RTU-2	Remote Terminal Unit #1 SCADA Control Panel	Primary Gallery	4X	Stainless steel	72-in	36-in	16-in	Free Standing	YES	YES
RTU-3	Remote Terminal Unit #3 SCADA Control Panel	Blower Building	12	Galvanized steel	72-in	36-in	16-in	Free Standing	YES	YES
RTU-4A	Remote Terminal Unit #4A SCADA Control Panel	Sludge Pumping Station #1	12	Galvanized steel	72-in	36-in	16-in	Free Standing	YES	YES
RTU-4B	Remote Terminal Unit #4B SCADA Control Panel	Sludge Pumping Station #2	12	Galvanized steel	72-in	36-in	16-in	Free Standing	YES	YES
RTU-5	Remote Terminal Unit #5 SCADA Control Panel	Chemical Building	12	Galvanized steel	72-in	36-in	16-in	Free Standing	YES	YES
RTU-7	Remote Terminal Unit #7 SCADA Control Panel	Solids Handling Building	12	Galvanized steel	72-in	36-in	16-in	Free Standing	YES	YES

**IO AND ALARM LIST**

<b>IO Tag No</b>	<b>Service</b>	<b>Location</b>	<b>IO Description</b>	<b>IO Type</b>	<b>IO Signal Range</b>	<b>CP Termination</b>	<b>LRL</b>	<b>URL</b>	<b>Units</b>	<b>Alarm List</b>	<b>Remarks</b>
JAL-0001	MTU-CP	MTU-CP	Power Failure	DI	--	MTU-CP	--	--	--	TRUE	--
JAL-0002	MTU-CP	MTU-CP	Power Failure	DI	--	MTU-CP	--	--	--	TRUE	Power Supply Alarms are wired in series.
JAL-0003	RTU-2	RTU-2	Power Failure	DI	--	RTU-2	--	--	--	TRUE	--
JAL-0004	RTU-2	RTU-2	Power Failure	DI	--	RTU-2	--	--	--	TRUE	Power Supply Alarms are wired in series.
JAL-0005	RTU-3	RTU-3	Power Failure	DI	--	RTU-3	--	--	--	TRUE	--
JAL-0006	RTU-3	RTU-3	Power Failure	DI	--	RTU-3	--	--	--	TRUE	Power Supply Alarms are wired in series.
JAL-0007	RTU-4A	RTU-4A	Power Failure	DI	--	RTU-4A	--	--	--	TRUE	--
JAL-0008	RTU-4A	RTU-4A	Power Failure	DI	--	RTU-4A	--	--	--	TRUE	Power Supply Alarms are wired in series.
JAL-0009	RTU-4B	RTU-4B	Power Failure	DI	--	RTU-4B	--	--	--	TRUE	--
JAL-0010	RTU-4B	RTU-4B	Power Failure	DI	--	RTU-4B	--	--	--	TRUE	Power Supply Alarms are wired in series.
JAL-0011	RTU-5	RTU-5	Power Failure	DI	--	RTU-5	--	--	--	TRUE	--
JAL-0012	RTU-5	RTU-5	Power Failure	DI	--	RTU-5	--	--	--	TRUE	Power Supply Alarms are wired in series.
JAL-0013	RTU-7	RTU-7	Power Failure	DI	--	RTU-7	--	--	--	TRUE	--
JAL-0014	RTU-7	RTU-7	Power Failure	DI	--	RTU-7	--	--	--	TRUE	Power Supply Alarms are wired in series.
YI-1201A	Grit Blower #1	Headworks	Grit Blower #1 HOA in Auto	DI	--	RTU-7	--	--	--	FALSE	--
YI-1201B	Grit Blower #1	Headworks	Grit Blower #1 Run Status	DI	--	RTU-7	--	--	--	FALSE	--
PSL-1201	Grit Blower #1	Headworks	Grit Blower #1 Low Suction Pressure	DI	--	RTU-7	--	--	--	TRUE	--



**IO AND ALARM LIST**

<b>IO Tag No</b>	<b>Service</b>	<b>Location</b>	<b>IO Description</b>	<b>IO Type</b>	<b>IO Signal Range</b>	<b>CP Termination</b>	<b>LRL</b>	<b>URL</b>	<b>Units</b>	<b>Alarm List</b>	<b>Remarks</b>
PSH-1201	Grit Blower #1	Headworks	Grit Blower #1 High Discharge Pressure	DI	--	RTU-7	--	--	--	TRUE	--
YA-1201	Grit Blower #1	Headworks	Grit Blower #1 Overload	DI	--	RTU-7	--	--	--	TRUE	--
YI-1201C	Grit Blower #1	Headworks	Grit Blower #1 Emergency Stop	DI	--	RTU-7	--	--	--	TRUE	--
YS-1201	Grit Blower #1	Headworks	Grit Blower #1 Start/Stop	DO	--	RTU-7	--	--	--	FALSE	--
YI-1202A	Grit Blower #2	Headworks	Grit Blower #2 HOA in Auto	DI	--	RTU-7	--	--	--	FALSE	--
YI-1202B	Grit Blower #2	Headworks	Grit Blower #2 Run Status	DI	--	RTU-7	--	--	--	FALSE	--
PSH-1202	Grit Blower #2	Headworks	Grit Blower #2 Low Suction Pressure	DI	--	RTU-7	--	--	--	TRUE	--
PSH-1202	Grit Blower #2	Headworks	Grit Blower #2 High Discharge Pressure	DI	--	RTU-7	--	--	--	TRUE	--
YA-1202	Grit Blower #2	Headworks	Grit Blower #2 Overload	DI	--	RTU-7	--	--	--	TRUE	--
YI-1202C	Grit Blower #2	Headworks	Grit Blower #2 Emergency Stop	DI	--	RTU-7	--	--	--	TRUE	--
YS-1202	Grit Blower #2	Headworks	Grit Blower #2 Start/Stop	DO	--	RTU-7	--	--	--	FALSE	--
PIT-1203	Grit Blower #1 Inlet Filter Pressure	Headworks	Grit Blower #1 Filter Pressure	AI	4-20 mA DC	RTU-7	0	150	PSI	TRUE	PAHH, PAH, PAL, PALL
PIT-1204	Grit Blower #2 Inlet Filter Pressure	Headworks	Grit Blower #2 Filter Pressure	AI	4-20 mA DC	RTU-7	0	150	PSI	TRUE	PAHH, PAH, PAL, PALL
YA-1306A	Headworks Combustible Gas Level High	Headworks Building	Headworks Combustible Gas High Alarm	DI	--	RTU-7	--	--	--	TRUE	--
YA-1306B	Headworks Hydrogen Sulfide Level High	Headworks Building	Headworks Hydrogen Sulfide Alarm	DI	--	RTU-7	--	--	--	TRUE	--

**IO AND ALARM LIST**

<b>IO Tag No</b>	<b>Service</b>	<b>Location</b>	<b>IO Description</b>	<b>IO Type</b>	<b>IO Signal Range</b>	<b>CP Termination</b>	<b>LRL</b>	<b>URL</b>	<b>Units</b>	<b>Alarm List</b>	<b>Remarks</b>
YA-1306C	Headworks Oxygen Level Low	Headworks Building	Headworks Oxygen Low Level Alarm	DI	--	RTU-7	--	--	--	TRUE	--
YI-2101A	Primary Clarifier #1	Primary Clarifier #1	Primary Clarifier #1 HOA in Auto	DI	--	RTU-2	--	--	--	FALSE	--
YI-2101B	Primary Clarifier #1	Primary Clarifier #1	Primary Clarifier #1 Run Status	DI	--	RTU-2	--	--	--	FALSE	--
WSH-2101	Primary Clarifier #1	Primary Clarifier #1	Primary Clarifier #1 High Torque	DI	--	RTU-2	--	--	--	TRUE	--
YA-2101	Primary Clarifier #1	Primary Clarifier #1	Primary Clarifier #1 Overload	DI	--	RTU-2	--	--	--	TRUE	--
YI-2101C	Primary Clarifier #1	Primary Clarifier #1	Primary Clarifier #1 Emergency Stop	DI	--	RTU-2	--	--	--	TRUE	--
YS-2101	Primary Clarifier #1	Primary Clarifier #1	Primary Clarifier #1 Start/Stop	DO	--	RTU-2	--	--	--	FALSE	--
YI-2102A	Primary Clarifier #2	Primary Clarifier #2	Primary Clarifier #2 HOA in Auto	DI	--	RTU-2	--	--	--	FALSE	--
YI-2102B	Primary Clarifier #2	Primary Clarifier #2	Primary Clarifier #2 Run Status	DI	--	RTU-2	--	--	--	FALSE	--
WSH-2102	Primary Clarifier #2	Primary Clarifier #2	Primary Clarifier #2 High Torque	DI	--	RTU-2	--	--	--	TRUE	--
YA-2102	Primary Clarifier #2	Primary Clarifier #2	Primary Clarifier #2 Overload	DI	--	RTU-2	--	--	--	TRUE	--

**IO AND ALARM LIST**

<b>IO Tag No</b>	<b>Service</b>	<b>Location</b>	<b>IO Description</b>	<b>IO Type</b>	<b>IO Signal Range</b>	<b>CP Termination</b>	<b>LRL</b>	<b>URL</b>	<b>Units</b>	<b>Alarm List</b>	<b>Remarks</b>
YI-2102C	Primary Clarifier #2	Primary Clarifier #2	Primary Clarifier #2 Emergency Stop	DI	--	RTU-2	--	--	--	TRUE	--
YS-2102	Primary Clarifier #2	Primary Clarifier #2	Primary Clarifier #2 Start/Stop	DO	--	RTU-2	--	--	--	FALSE	--
YI-2103A	Primary Clarifier #3	Primary Clarifier #3	Primary Clarifier #3 HOA in Auto	DI	--	RTU-2	--	--	--	FALSE	--
YI-2103B	Primary Clarifier #3	Primary Clarifier #3	Primary Clarifier #3 Run Status	DI	--	RTU-2	--	--	--	FALSE	--
WSH-2103	Primary Clarifier #3	Primary Clarifier #3	Primary Clarifier #3 High Torque	DI	--	RTU-2	--	--	--	TRUE	--
YA-2103	Primary Clarifier #3	Primary Clarifier #3	Primary Clarifier #3 Overload	DI	--	RTU-2	--	--	--	TRUE	--
YI-2103C	Primary Clarifier #3	Primary Clarifier #3	Primary Clarifier #3 Emergency Stop	DI	--	RTU-2	--	--	--	TRUE	--
YS-2103	Primary Clarifier #3	Primary Clarifier #3	Primary Clarifier #3 Start/Stop	DO	--	RTU-2	--	--	--	FALSE	--
YI-2104A	Primary Clarifier #4	Primary Clarifier #4	Primary Clarifier #4 HOA in Auto	DI	--	RTU-2	--	--	--	FALSE	--
YI-2104B	Primary Clarifier #4	Primary Clarifier #4	Primary Clarifier #4 Run Status	DI	--	RTU-2	--	--	--	FALSE	--
WSH-2104	Primary Clarifier #4	Primary Clarifier #4	Primary Clarifier #4 High Torque	DI	--	RTU-2	--	--	--	TRUE	--

**IO AND ALARM LIST**

<b>IO Tag No</b>	<b>Service</b>	<b>Location</b>	<b>IO Description</b>	<b>IO Type</b>	<b>IO Signal Range</b>	<b>CP Termination</b>	<b>LRL</b>	<b>URL</b>	<b>Units</b>	<b>Alarm List</b>	<b>Remarks</b>
YA-2104	Primary Clarifier #4	Primary Clarifier #4	Primary Clarifier #4 Overload	DI	--	RTU-2	--	--	--	TRUE	--
YI-2104C	Primary Clarifier #4	Primary Clarifier #4	Primary Clarifier #4 Emergency Stop	DI	--	RTU-2	--	--	--	TRUE	--
YS-2104	Primary Clarifier #4	Primary Clarifier #4	Primary Clarifier #4 Start/Stop	DO	--	RTU-2	--	--	--	FALSE	--
YI-2201A	Primary Sludge Pump #1	Primary Pipe Gallery	Primary Sludge Pump #1 HOA in Auto	DI	--	RTU-2	--	--	--	FALSE	--
YI-2201B	Primary Sludge Pump #1	Primary Pipe Gallery	Primary Sludge Pump #1 Run Status	DI	--	RTU-2	--	--	--	FALSE	--
TSH-2201	Primary Sludge Pump #1	Primary Pipe Gallery	Primary Sludge Pump #1 High Motor Temp.	DI	--	RTU-2	--	--	--	TRUE	--
YA-2201	Primary Sludge Pump #1	Primary Pipe Gallery	Primary Sludge Pump #1 VFD Alarm	DI	--	RTU-2	--	--	--	TRUE	--
YI-2201C	Primary Sludge Pump #1	Primary Pipe Gallery	Primary Sludge Pump #1 Emergency Stop	DI	--	RTU-2	--	--	--	TRUE	--
PSH-2201	Primary Sludge Pump #1	Primary Pipe Gallery	Primary Sludge Pump #1 Water Seal Failure	DI	--	RTU-2	--	--	--	TRUE	--
SI-2201	Primary Sludge Pump #1	Primary Pipe Gallery	Primary Sludge Pump #1 VFD Speed	AI	4-20 mA DC	RTU-2	0	100	%	FALSE	--
YS-2201	Primary Sludge Pump #1	Primary Pipe Gallery	Primary Sludge Pump #1 Start/Stop	DO	--	RTU-2	--	--	--	FALSE	--

**IO AND ALARM LIST**

IO Tag No	Service	Location	IO Description	IO Type	IO Signal Range	CP Termination	LRL	URL	Units	Alarm List	Remarks
SC-2201	Primary Sludge Pump #1	Primary Pipe Gallery	Primary Sludge Pump #1 VFD Speed Command	AO	4-20 mA DC	RTU-2	30	100	%	FALSE	--
YI-2202A	Primary Sludge Pump #2	Primary Pipe Gallery	Primary Sludge Pump #2 HOA in Auto	DI	--	RTU-2	--	--	--	FALSE	--
YI-2202B	Primary Sludge Pump #2	Primary Pipe Gallery	Primary Sludge Pump #2 Run Status	DI	--	RTU-2	--	--	--	FALSE	--
TSH-2202	Primary Sludge Pump #2	Primary Pipe Gallery	Primary Sludge Pump #2 High Motor Temp.	DI	--	RTU-2	--	--	--	TRUE	--
YA-2202	Primary Sludge Pump #2	Primary Pipe Gallery	Primary Sludge Pump #2 VFD Alarm	DI	--	RTU-2	--	--	--	TRUE	--
YI-2202C	Primary Sludge Pump #2	Primary Pipe Gallery	Primary Sludge Pump #2 Emergency Stop	DI	--	RTU-2	--	--	--	TRUE	--
PSH-2202	Primary Sludge Pump #2	Primary Pipe Gallery	Primary Sludge Pump #2 Water Seal Failure	DI	--	RTU-2	--	--	--	TRUE	--
SI-2202	Primary Sludge Pump #2	Primary Pipe Gallery	Primary Sludge Pump #2 VFD Speed	AI	4-20 mA DC	RTU-2	0	100	%	FALSE	--
YS-2202	Primary Sludge Pump #2	Primary Pipe Gallery	Primary Sludge Pump #2 Start/Stop	DO	--	RTU-2	--	--	--	FALSE	--
SC-2202	Primary Sludge Pump #2	Primary Pipe Gallery	Primary Sludge Pump #2 VFD Speed Command	AO	4-20 mA DC	RTU-2	30	100	%	FALSE	--
YI-2203A	Primary Sludge Pump #3	Primary Pipe Gallery	Primary Sludge Pump #3 HOA in Auto	DI	--	RTU-2	--	--	--	FALSE	--

**IO AND ALARM LIST**

IO Tag No	Service	Location	IO Description	IO Type	IO Signal Range	CP Termination	LRL	URL	Units	Alarm List	Remarks
YI-2203B	Primary Sludge Pump #3	Primary Pipe Gallery	Primary Sludge Pump #3 Run Status	DI	--	RTU-2	--	--	--	FALSE	--
TSH-2203	Primary Sludge Pump #3	Primary Pipe Gallery	Primary Sludge Pump #3 High Motor Temp.	DI	--	RTU-2	--	--	--	TRUE	--
YA-2203	Primary Sludge Pump #3	Primary Pipe Gallery	Primary Sludge Pump #3 VFD Alarm	DI	--	RTU-2	--	--	--	TRUE	--
YI-2203C	Primary Sludge Pump #3	Primary Pipe Gallery	Primary Sludge Pump #3 Emergency Stop	DI	--	RTU-2	--	--	--	TRUE	--
PSH-2203	Primary Sludge Pump #3	Primary Pipe Gallery	Primary Sludge Pump #3 Water Seal Failure	DI	--	RTU-2	--	--	--	TRUE	--
SI-2203	Primary Sludge Pump #3	Primary Pipe Gallery	Primary Sludge Pump #3 VFD Speed	AI	4-20 mA DC	RTU-2	0	100	%	FALSE	--
YS-2203	Primary Sludge Pump #3	Primary Pipe Gallery	Primary Sludge Pump #3 Start/Stop	DO	--	RTU-2	--	--	--	FALSE	--
SC-2203	Primary Sludge Pump #3	Primary Pipe Gallery	Primary Sludge Pump #3 VFD Speed Command	AO	4-20 mA DC	RTU-2	30	100	%	FALSE	--
YI-2204A	Primary Sludge Pump #4	Primary Pipe Gallery	Primary Sludge Pump #4 HOA in Auto	DI	--	RTU-2	--	--	--	FALSE	--
YI-2204B	Primary Sludge Pump #4	Primary Pipe Gallery	Primary Sludge Pump #4 Run Status	DI	--	RTU-2	--	--	--	FALSE	--
TSH-2204	Primary Sludge Pump #4	Primary Pipe Gallery	Primary Sludge Pump #4 High Motor Temp.	DI	--	RTU-2	--	--	--	TRUE	--

**IO AND ALARM LIST**

IO Tag No	Service	Location	IO Description	IO Type	IO Signal Range	CP Termination	LRL	URL	Units	Alarm List	Remarks
YA-2204	Primary Sludge Pump #4	Primary Pipe Gallery	Primary Sludge Pump #4 VFD Alarm	DI	--	RTU-2	--	--	--	TRUE	--
YI-2204C	Primary Sludge Pump #4	Primary Pipe Gallery	Primary Sludge Pump #4 Emergency Stop	DI	--	RTU-2	--	--	--	TRUE	--
PSH-2204	Primary Sludge Pump #4	Primary Pipe Gallery	Primary Sludge Pump #4 Water Seal Failure	DI	--	RTU-2	--	--	--	TRUE	--
SI-2204	Primary Sludge Pump #4	Primary Pipe Gallery	Primary Sludge Pump #4 VFD Speed	AI	4-20 mA DC	RTU-2	0	100	%	FALSE	--
YS-2204	Primary Sludge Pump #4	Primary Pipe Gallery	Primary Sludge Pump #4 Start/Stop	DO	--	RTU-2	--	--	--	FALSE	--
SC-2204	Primary Sludge Pump #4	Primary Pipe Gallery	Primary Sludge Pump #4 VFD Speed Command	AO	4-20 mA DC	RTU-2	30	100	%	FALSE	--
FIT-2205	Primary Sludge Flow	Primary Pipe Gallery	Primary Sludge Flow Rate	AI	4-20 mA DC	RTU-2	0	500	GPM	TRUE	FAHH, FAH, FAL, FALL
YI-2301A	Scum Pump #1	Primary Pipe Gallery	Scum Pump #1 HOA in Auto	DI	--	RTU-2	--	--	--	FALSE	--
YI-2301B	Scum Pump #1	Primary Pipe Gallery	Scum Pump #1 Run Status	DI	--	RTU-2	--	--	--	FALSE	--
TSH-2301	Scum Pump #1	Primary Pipe Gallery	Scum Pump #1 High Motor Temp.	DI	--	RTU-2	--	--	--	TRUE	--
YA-2301	Scum Pump #1	Primary Pipe Gallery	Scum Pump #1 Overload	DI	--	RTU-2	--	--	--	TRUE	--
YI-2301C	Scum Pump #1	Primary Pipe Gallery	Scum Pump #1 Emergency Stop	DI	--	RTU-2	--	--	--	TRUE	--
YS-2301	Scum Pump #1	Primary Pipe Gallery	Scum Pump #1 Start/Stop	DO	--	RTU-2	--	--	--	FALSE	--

**IO AND ALARM LIST**

<b>IO Tag No</b>	<b>Service</b>	<b>Location</b>	<b>IO Description</b>	<b>IO Type</b>	<b>IO Signal Range</b>	<b>CP Termination</b>	<b>LRL</b>	<b>URL</b>	<b>Units</b>	<b>Alarm List</b>	<b>Remarks</b>
YI-2302A	Scum Pump #2	Primary Pipe Gallery	Scum Pump #2 HOA in Auto	DI	--	RTU-2	--	--	--	FALSE	--
YI-2302B	Scum Pump #2	Primary Pipe Gallery	Scum Pump #2 Run Status	DI	--	RTU-2	--	--	--	FALSE	--
TSH-2302	Scum Pump #2	Primary Pipe Gallery	Scum Pump #2 High Motor Temp.	DI	--	RTU-2	--	--	--	TRUE	--
YA-2302	Scum Pump #2	Primary Pipe Gallery	Scum Pump #2 Overload	DI	--	RTU-2	--	--	--	TRUE	--
YI-2302C	Scum Pump #2	Primary Pipe Gallery	Scum Pump #2 Emergency Stop	DI	--	RTU-2	--	--	--	TRUE	--
YS-2302	Scum Pump #2	Primary Pipe Gallery	Scum Pump #2 Start/Stop	DO	--	RTU-2	--	--	--	FALSE	--
LIT-2303	Primary Scum Well #1 Level	Primary Scum Well #1	Primary Scum Well #1 Level	AI	4-20 mA DC	RTU-2	0	20	Feet	TRUE	LAHH, LAH, LAL, LALL,
LIT-2304	Primary Scum Well #2 Level	Primary Scum Well #2	Primary Scum Well #2 Level	AI	4-20 mA DC	RTU-2	0	20	Feet	TRUE	LAHH, LAH, LAL, LALL,
YI-3101A	Pre-Anoxic Mixer	Pre-Anoxic Chamber	Pre-Anoxic Mixer HOA in Auto	DI	--	RTU-3	--	--	--	FALSE	--
YI-3101B	Pre-Anoxic Mixer	Pre-Anoxic Chamber	Pre-Anoxic Mixer Run Status	DI	--	RTU-3	--	--	--	FALSE	--
MSH-3101	Pre-Anoxic Mixer	Pre-Anoxic Chamber	Pre-Anoxic Mixer Seal Leak	DI	--	RTU-3	--	--	--	TRUE	--
TSH-3101	Pre-Anoxic Mixer	Pre-Anoxic Chamber	Pre-Anoxic Mixer High Motor Temp.	DI	--	RTU-3	--	--	--	TRUE	--
YA-3101	Pre-Anoxic Mixer	Pre-Anoxic Chamber	Pre-Anoxic Mixer Overload	DI	--	RTU-3	--	--	--	TRUE	--
YI-3101C	Pre-Anoxic Mixer	Pre-Anoxic Chamber	Pre-Anoxic Mixer Emergency Stop	DI	--	RTU-3	--	--	--	TRUE	--
YS-3101	Pre-Anoxic Mixer	Pre-Anoxic Chamber	Pre-Anoxic Mixer Start/Stop	DO	--	RTU-3	--	--	--	FALSE	--



**IO AND ALARM LIST**

<b>IO Tag No</b>	<b>Service</b>	<b>Location</b>	<b>IO Description</b>	<b>IO Type</b>	<b>IO Signal Range</b>	<b>CP Termination</b>	<b>LRL</b>	<b>URL</b>	<b>Units</b>	<b>Alarm List</b>	<b>Remarks</b>
YI-3111A	Train #1 Anoxic Selector Mixer #1	Train #1 Anoxic Selector	Train #1 Anoxic Selector Mixer #1 HOA in Auto	DI	--	RTU-3	--	--	--	FALSE	--
YI-3111B	Train #1 Anoxic Selector Mixer #1	Train #1 Anoxic Selector	Train #1 Anoxic Selector Mixer #1 Run Status	DI	--	RTU-3	--	--	--	FALSE	--
MSH-3111	Train #1 Anoxic Selector Mixer #1	Train #1 Anoxic Selector	Train #1 Anoxic Selector Mixer #1 Seal Leak	DI	--	RTU-3	--	--	--	TRUE	--
TSH-3111	Train #1 Anoxic Selector Mixer #1	Train #1 Anoxic Selector	Train #1 Anoxic Selector Mixer #1 High Motor Temp.	DI	--	RTU-3	--	--	--	TRUE	--
YA-3111	Train #1 Anoxic Selector Mixer #1	Train #1 Anoxic Selector	Train #1 Anoxic Selector Mixer #1 Overload	DI	--	RTU-3	--	--	--	TRUE	--
YI-3111C	Train #1 Anoxic Selector Mixer #1	Train #1 Anoxic Selector	Train #1 Anoxic Selector Mixer #1 Emergency Stop	DI	--	RTU-3	--	--	--	TRUE	--
YS-3111	Train #1 Anoxic Selector Mixer #1	Train #1 Anoxic Selector	Train #1 Anoxic Selector Mixer #1 Start/Stop	DO	--	RTU-3	--	--	--	FALSE	--
YI-3112A	Train #1 Anoxic Selector Mixer #2	Train #1 Anoxic Selector	Train #1 Anoxic Selector Mixer #2 HOA in Auto	DI	--	RTU-3	--	--	--	FALSE	--
YI-3112B	Train #1 Anoxic Selector Mixer #2	Train #1 Anoxic Selector	Train #1 Anoxic Selector Mixer #2 Run Status	DI	--	RTU-3	--	--	--	FALSE	--
MSH-3112	Train #1 Anoxic Selector Mixer #2	Train #1 Anoxic Selector	Train #1 Anoxic Selector Mixer #2 Seal Leak	DI	--	RTU-3	--	--	--	TRUE	--

**IO AND ALARM LIST**

<b>IO Tag No</b>	<b>Service</b>	<b>Location</b>	<b>IO Description</b>	<b>IO Type</b>	<b>IO Signal Range</b>	<b>CP Termination</b>	<b>LRL</b>	<b>URL</b>	<b>Units</b>	<b>Alarm List</b>	<b>Remarks</b>
TSH-3112	Train #1 Anoxic Selector Mixer #2	Train #1 Anoxic Selector	Train #1 Anoxic Selector Mixer #2 High Motor Temp.	DI	--	RTU-3	--	--	--	TRUE	--
YA-3112	Train #1 Anoxic Selector Mixer #2	Train #1 Anoxic Selector	Train #1 Anoxic Selector Mixer #2 Overload	DI	--	RTU-3	--	--	--	TRUE	--
YI-3112C	Train #1 Anoxic Selector Mixer #2	Train #1 Anoxic Selector	Train #1 Anoxic Selector Mixer #2 Emergency Stop	DI	--	RTU-3	--	--	--	TRUE	--
YS-3112	Train #1 Anoxic Selector Mixer #2	Train #1 Anoxic Selector	Train #1 Anoxic Selector Mixer #2 Start/Stop	DO	--	RTU-3	--	--	--	FALSE	--
YI-3113A	Train #1 Anoxic Selector Mixer #3	Train #1 Anoxic Selector	Train #1 Anoxic Selector Mixer #3 HOA in Auto	DI	--	RTU-3	--	--	--	FALSE	--
YI-3113B	Train #1 Anoxic Selector Mixer #3	Train #1 Anoxic Selector	Train #1 Anoxic Selector Mixer #3 Run Status	DI	--	RTU-3	--	--	--	FALSE	--
MSH-3113	Train #1 Anoxic Selector Mixer #3	Train #1 Anoxic Selector	Train #1 Anoxic Selector Mixer #3 Seal Leak	DI	--	RTU-3	--	--	--	TRUE	--
TSH-3113	Train #1 Anoxic Selector Mixer #3	Train #1 Anoxic Selector	Train #1 Anoxic Selector Mixer #3 High Motor Temp.	DI	--	RTU-3	--	--	--	TRUE	--
YA-3113	Train #1 Anoxic Selector Mixer #3	Train #1 Anoxic Selector	Train #1 Anoxic Selector Mixer #3 Overload	DI	--	RTU-3	--	--	--	TRUE	--
YI-3113C	Train #1 Anoxic Selector Mixer #3	Train #1 Anoxic Selector	Train #1 Anoxic Selector Mixer #3 Emergency Stop	DI	--	RTU-3	--	--	--	TRUE	--

**IO AND ALARM LIST**

<b>IO Tag No</b>	<b>Service</b>	<b>Location</b>	<b>IO Description</b>	<b>IO Type</b>	<b>IO Signal Range</b>	<b>CP Termination</b>	<b>LRL</b>	<b>URL</b>	<b>Units</b>	<b>Alarm List</b>	<b>Remarks</b>
YS-3113	Train #1 Anoxic Selector Mixer #3	Train #1 Anoxic Selector	Train #1 Anoxic Selector Mixer #3 Start/Stop	DO	--	RTU-3	--	--	--	FALSE	--
YI-3131A	Secondary Anoxic Tank #1 Mixer #1	Secondary Anoxic Tank #1	Secondary Anoxic Tank #1 Mixer #1 HOA in Auto	DI	--	RTU-3	--	--	--	FALSE	--
YI-3131B	Secondary Anoxic Tank #1 Mixer #1	Secondary Anoxic Tank #1	Secondary Anoxic Tank #1 Mixer #1 Run Status	DI	--	RTU-3	--	--	--	FALSE	--
MSH-3131	Secondary Anoxic Tank #1 Mixer #1	Secondary Anoxic Tank #1	Secondary Anoxic Tank #1 Mixer #1 Seal Leak	DI	--	RTU-3	--	--	--	TRUE	--
TSH-3131	Secondary Anoxic Tank #1 Mixer #1	Secondary Anoxic Tank #1	Secondary Anoxic Tank #1 Mixer #1 High Motor Temp.	DI	--	RTU-3	--	--	--	TRUE	--
YA-3131	Secondary Anoxic Tank #1 Mixer #1	Secondary Anoxic Tank #1	Secondary Anoxic Tank #1 Mixer #1 Overload	DI	--	RTU-3	--	--	--	TRUE	--
YI-3131C	Secondary Anoxic Tank #1 Mixer #1	Secondary Anoxic Tank #1	Secondary Anoxic Tank #1 Mixer #1 Emergency Stop	DI	--	RTU-3	--	--	--	TRUE	--
YS-3131	Secondary Anoxic Tank #1 Mixer #1	Secondary Anoxic Tank #1	Secondary Anoxic Tank #1 Mixer #1 Start/Stop	DO	--	RTU-3	--	--	--	FALSE	--
YI-3132A	Secondary Anoxic Tank #1 Mixer #2	Secondary Anoxic Tank #1	Secondary Anoxic Tank #1 Mixer #2 HOA in Auto	DI	--	RTU-3	--	--	--	FALSE	--

**IO AND ALARM LIST**

IO Tag No	Service	Location	IO Description	IO Type	IO Signal Range	CP Termination	LRL	URL	Units	Alarm List	Remarks
YI-3132B	Secondary Anoxic Tank #1 Mixer #2	Secondary Anoxic Tank #1	Secondary Anoxic Tank #1 Mixer #2 Run Status	DI	--	RTU-3	--	--	--	FALSE	--
MSH-3132	Secondary Anoxic Tank #1 Mixer #2	Secondary Anoxic Tank #1	Secondary Anoxic Tank #1 Mixer #2 Seal Leak	DI	--	RTU-3	--	--	--	TRUE	--
TSH-3132	Secondary Anoxic Tank #1 Mixer #2	Secondary Anoxic Tank #1	Secondary Anoxic Tank #1 Mixer #2 High Motor Temp.	DI	--	RTU-3	--	--	--	TRUE	--
YA-3132	Secondary Anoxic Tank #1 Mixer #2	Secondary Anoxic Tank #1	Secondary Anoxic Tank #1 Mixer #2 Overload	DI	--	RTU-3	--	--	--	TRUE	--
YI-3132C	Secondary Anoxic Tank #1 Mixer #2	Secondary Anoxic Tank #1	Secondary Anoxic Tank #1 Mixer #2 Emergency Stop	DI	--	RTU-3	--	--	--	TRUE	--
YS-3132	Secondary Anoxic Tank #1 Mixer #2	Secondary Anoxic Tank #1	Secondary Anoxic Tank #1 Mixer #2 Start/Stop	DO	--	RTU-3	--	--	--	FALSE	--
YI-3141A	Re-Aeration Tank #1 <del>Surface Aerator</del> Mixer #1	Re-Aeration Tank #1	Re-Aeration Tank #1 <del>Surface Aerator</del> Mixer #1 HOA in Auto	DI	--	RTU-3	--	--	--	FALSE	--
YI-3141B	Re-Aeration Tank #1 <del>Surface Aerator</del> Mixer #1	Re-Aeration Tank #1	Re-Aeration Tank #1 <del>Surface Aerator</del> Mixer #1 Run Status	DI	--	RTU-3	--	--	--	FALSE	--

**IO AND ALARM LIST**

IO Tag No	Service	Location	IO Description	IO Type	IO Signal Range	CP Termination	LRL	URL	Units	Alarm List	Remarks
TSH-3141	Re-Aeration Tank #1 <del>Surface Aerator Mixer</del> #1	Re-Aeration Tank #1	Re-Aeration Tank #1 <del>Surface Aerator Mixer</del> #1 High Motor Temp.	DI	--	RTU-3	--	--	--	TRUE	--
YA-3141	Re-Aeration Tank #1 <del>Surface Aerator Mixer</del> #1	Re-Aeration Tank #1	Re-Aeration Tank #1 <del>Surface Aerator Mixer</del> #1 VFD Alarm	DI	--	RTU-3	--	--	--	TRUE	--
YI-3141C	Re-Aeration Tank #1 <del>Surface Aerator Mixer</del> #1	Re-Aeration Tank #1	Re-Aeration Tank #1 <del>Surface Aerator Mixer</del> #1 Emergency Stop	DI	--	RTU-3	--	--	--	TRUE	--
SI-3141	Re-Aeration Tank #1 <del>Surface Aerator Mixer</del> #1	Re-Aeration Tank #1	Re-Aeration Tank #1 <del>Surface Aerator Mixer</del> #1 VFD Speed	AI	4-20 mA DC	RTU-3	0	100	%	FALSE	--
YS-3141	Re-Aeration Tank #1 <del>Surface Aerator Mixer</del> #1	Re-Aeration Tank #1	Re-Aeration Tank #1 <del>Surface Aerator Mixer</del> #1 Start/Stop	DO	--	RTU-3	--	--	--	FALSE	--
SC-3141	Re-Aeration Tank #1 <del>Surface Aerator Mixer</del> #1	Re-Aeration Tank #1	Re-Aeration Tank #1 <del>Surface Aerator Mixer</del> #1 VFD Speed Command	AO	4-20 mA DC	RTU-3	30	100	%	FALSE	--
YI-3142A	Re-Aeration Tank #1 <del>Surface Aerator Mixer</del> #2	Re-Aeration Tank #1	Re-Aeration Tank #1 <del>Surface Aerator Mixer</del> #2 HOA in Auto	DI	--	RTU-3	--	--	--	FALSE	--
YI-3142B	Re-Aeration Tank #1 <del>Surface Aerator Mixer</del> #2	Re-Aeration Tank #1	Re-Aeration Tank #1 <del>Surface Aerator Mixer</del> #2 Run Status	DI	--	RTU-3	--	--	--	FALSE	--

**IO AND ALARM LIST**

IO Tag No	Service	Location	IO Description	IO Type	IO Signal Range	CP Termination	LRL	URL	Units	Alarm List	Remarks
TSH-3142	Re-Aeration Tank #1 <del>Surface Aerator</del> Mixer #2	Re-Aeration Tank #1	Re-Aeration Tank #1 <del>Surface Aerator</del> Mixer #2 High Motor Temp.	DI	--	RTU-3	--	--	--	TRUE	--
YA-3142	Re-Aeration Tank #1 <del>Surface Aerator</del> Mixer #2	Re-Aeration Tank #1	Re-Aeration Tank #1 <del>Surface Aerator</del> Mixer #2 VFD Alarm	DI	--	RTU-3	--	--	--	TRUE	--
YI-3142C	Re-Aeration Tank #1 <del>Surface Aerator</del> Mixer #2	Re-Aeration Tank #1	Re-Aeration Tank #1 <del>Surface Aerator</del> Mixer #2 Emergency Stop	DI	--	RTU-3	--	--	--	TRUE	--
SI-3142	Re-Aeration Tank #1 <del>Surface Aerator</del> Mixer #2	Re-Aeration Tank #1	Re-Aeration Tank #1 <del>Surface Aerator</del> Mixer #2 VFD Speed	AI	4-20 mA DC	RTU-3	0	100	%	FALSE	--
YS-3142	Re-Aeration Tank #1 <del>Surface Aerator</del> Mixer #2	Re-Aeration Tank #1	Re-Aeration Tank #1 <del>Surface Aerator</del> Mixer #2 Start/Stop	DO	--	RTU-3	--	--	--	FALSE	--
SC-3142	Re-Aeration Tank #1 <del>Surface Aerator</del> Mixer #2	Re-Aeration Tank #1	Re-Aeration Tank #1 <del>Surface Aerator</del> Mixer #2 VFD Speed Command	AO	4-20 mA DC	RTU-3	30	100	%	FALSE	--
YI-3143A	Re-Aeration Tank #1 <del>Surface Aerator</del> Mixer #3	Re-Aeration Tank #1	Re-Aeration Tank #1 <del>Surface Aerator</del> Mixer #3 HOA in Auto	DI	--	RTU-3	--	--	--	FALSE	--
YI-3143B	Re-Aeration Tank #1 <del>Surface Aerator</del> Mixer #3	Re-Aeration Tank #1	Re-Aeration Tank #1 <del>Surface Aerator</del> Mixer #3 Run Status	DI	--	RTU-3	--	--	--	FALSE	--

**IO AND ALARM LIST**

IO Tag No	Service	Location	IO Description	IO Type	IO Signal Range	CP Termination	LRL	URL	Units	Alarm List	Remarks
TSH-3143	Re-Aeration Tank #1 <del>Surface Aerator Mixer</del> #3	Re-Aeration Tank #1	Re-Aeration Tank #1 <del>Surface Aerator Mixer</del> #3 High Motor Temp.	DI	--	RTU-3	--	--	--	TRUE	--
YA-3143	Re-Aeration Tank #1 <del>Surface Aerator Mixer</del> #3	Re-Aeration Tank #1	Re-Aeration Tank #1 <del>Surface Aerator Mixer</del> #3 VFD Alarm	DI	--	RTU-3	--	--	--	TRUE	--
YI-3143C	Re-Aeration Tank #1 <del>Surface Aerator Mixer</del> #3	Re-Aeration Tank #1	Re-Aeration Tank #1 <del>Surface Aerator Mixer</del> #3 Emergency Stop	DI	--	RTU-3	--	--	--	TRUE	--
SI-3143	Re-Aeration Tank #1 <del>Surface Aerator Mixer</del> #3	Re-Aeration Tank #1	Re-Aeration Tank #1 <del>Surface Aerator Mixer</del> #3 VFD Speed	AI	4-20 mA DC	RTU-3	0	100	%	FALSE	--
YS-3143	Re-Aeration Tank #1 <del>Surface Aerator Mixer</del> #3	Re-Aeration Tank #1	Re-Aeration Tank #1 <del>Surface Aerator Mixer</del> #3 Start/Stop	DO	--	RTU-3	--	--	--	FALSE	--
SC-3143	Re-Aeration Tank #1 <del>Surface Aerator Mixer</del> #3	Re-Aeration Tank #1	Re-Aeration Tank #1 <del>Surface Aerator Mixer</del> #3 VFD Speed Command	AO	4-20 mA DC	RTU-3	30	100	%	FALSE	--
YI-3144A	Re-Aeration Tank #1 Blower #1	Re-Aeration Tank #1	Re-Aeration Tank #1 Blower #1 HOA in Auto	DI	--	RTU-3	--	--	--	FALSE	--
YI-3144B	Re-Aeration Tank #1 Blower #1	Re-Aeration Tank #1	Re-Aeration Tank #1 Blower #1 Run Status	DI	--	RTU-3	--	--	--	FALSE	--

**IO AND ALARM LIST**

IO Tag No	Service	Location	IO Description	IO Type	IO Signal Range	CP Termination	LRL	URL	Units	Alarm List	Remarks
TSH-3144	Re-Aeration Tank #1 Blower #1	Re-Aeration Tank #1	Re-Aeration Tank #1 Blower #1 High Motor Temp.	DI	--	RTU-3	--	--	--	TRUE	--
YA-3144	Re-Aeration Tank #1 Blower #1	Re-Aeration Tank #1	Re-Aeration Tank #1 Blower #1 Overload	DI	--	RTU-3	--	--	--	TRUE	--
YI-3144C	Re-Aeration Tank #1 Blower #1	Re-Aeration Tank #1	Re-Aeration Tank #1 Blower #1 Emergency Stop	DI	--	RTU-3	--	--	--	TRUE	--
YI-3145A	Re-Aeration Tank #1 Blower #2	Re-Aeration Tank #1	Re-Aeration Tank #1 Blower #2 HOA in Auto	DI	--	RTU-3	--	--	--	FALSE	--
YI-3145B	Re-Aeration Tank #1 Blower #2	Re-Aeration Tank #1	Re-Aeration Tank #1 Blower #2 Run Status	DI	--	RTU-3	--	--	--	FALSE	--
TSH-3145	Re-Aeration Tank #1 Blower #2	Re-Aeration Tank #1	Re-Aeration Tank #1 Blower #2 High Motor Temp.	DI	--	RTU-3	--	--	--	TRUE	--
YA-3145	Re-Aeration Tank #1 Blower #2	Re-Aeration Tank #1	Re-Aeration Tank #1 Blower #2 Overload	DI	--	RTU-3	--	--	--	TRUE	--
YI-3145C	Re-Aeration Tank #1 Blower #2	Re-Aeration Tank #1	Re-Aeration Tank #1 Blower #2 Emergency Stop	DI	--	RTU-3	--	--	--	TRUE	--
YI-3146A	Re-Aeration Tank #1 Blower #3	Re-Aeration Tank #1	Re-Aeration Tank #1 Blower #3 HOA in Auto	DI	--	RTU-3	--	--	--	FALSE	--
YI-3146B	Re-Aeration Tank #1 Blower #3	Re-Aeration Tank #1	Re-Aeration Tank #1 Blower #3 Run Status	DI	--	RTU-3	--	--	--	FALSE	--



**IO AND ALARM LIST**

IO Tag No	Service	Location	IO Description	IO Type	IO Signal Range	CP Termination	LRL	URL	Units	Alarm List	Remarks
TSH-3146	Re-Aeration Tank #1 Blower #3	Re-Aeration Tank #1	Re-Aeration Tank #1 Blower #3 High Motor Temp.	DI	--	RTU-3	--	--	--	TRUE	--
YA-3146	Re-Aeration Tank #1 Blower #3	Re-Aeration Tank #1	Re-Aeration Tank #1 Blower #3 Overload	DI	--	RTU-3	--	--	--	TRUE	--
YI-3146C	Re-Aeration Tank #1 Blower #3	Re-Aeration Tank #1	Re-Aeration Tank #1 Blower #3 Emergency Stop	DI	--	RTU-3	--	--	--	TRUE	--
YI-3151A	Train #1 Anoxic Aerobic Mixer	Train #1 Anoxic Aerobic	Train #1 Anoxic Aerobic Mixer HOA in Auto	DI	--	RTU-3	--	--	--	FALSE	--
YI-3151B	Train #1 Anoxic Aerobic Mixer	Train #1 Anoxic Aerobic	Train #1 Anoxic Aerobic Mixer Run Status	DI	--	RTU-3	--	--	--	FALSE	--
MSH-3151	Train #1 Anoxic Aerobic Mixer	Train #1 Anoxic Aerobic	Train #1 Anoxic Aerobic Mixer Seal Leak	DI	--	RTU-3	--	--	--	TRUE	--
TSH-3151	Train #1 Anoxic Aerobic Mixer	Train #1 Anoxic Aerobic	Train #1 Anoxic Aerobic Mixer High Motor Temp.	DI	--	RTU-3	--	--	--	TRUE	--
YA-3151	Train #1 Anoxic Aerobic Mixer	Train #1 Anoxic Aerobic	Train #1 Anoxic Aerobic Mixer Overload	DI	--	RTU-3	--	--	--	TRUE	--
YI-3151C	Train #1 Anoxic Aerobic Mixer	Train #1 Anoxic Aerobic	Train #1 Anoxic Aerobic Mixer Emergency Stop	DI	--	RTU-3	--	--	--	TRUE	--
YI-3161A	Train #1 Recycle Pump #1	Train #1 Anoxic Tank	Train #1 Recycle Pump #1 HOA in Auto	DI	--	RTU-3	--	--	--	FALSE	--

**IO AND ALARM LIST**

<b>IO Tag No</b>	<b>Service</b>	<b>Location</b>	<b>IO Description</b>	<b>IO Type</b>	<b>IO Signal Range</b>	<b>CP Termination</b>	<b>LRL</b>	<b>URL</b>	<b>Units</b>	<b>Alarm List</b>	<b>Remarks</b>
YI-3161B	Train #1 Recycle Pump #1	Train #1 Anoxic Tank	Train #1 Recycle Pump #1 Run Status	DI	--	RTU-3	--	--	--	FALSE	--
MSH-3161	Train #1 Recycle Pump #1	Train #1 Anoxic Tank	Train #1 Recycle Pump #1 Seal Leak	DI	--	RTU-3	--	--	--	TRUE	--
TSH-3161	Train #1 Recycle Pump #1	Train #1 Anoxic Tank	Train #1 Recycle Pump #1 High Motor Temp.	DI	--	RTU-3	--	--	--	TRUE	--
YA-3161	Train #1 Recycle Pump #1	Train #1 Anoxic Tank	Train #1 Recycle Pump #1 VFD Alarm	DI	--	RTU-3	--	--	--	TRUE	--
YI-3161C	Train #1 Recycle Pump #1	Train #1 Anoxic Tank	Train #1 Recycle Pump #1 Emergency Stop	DI	--	RTU-3	--	--	--	TRUE	--
SI-3161	Train #1 Recycle Pump #1	Train #1 Anoxic Tank	Train #1 Recycle Pump #1 VFD Speed	AI	4-20 mA DC	RTU-3	0	100	%	FALSE	--
YS-3161	Train #1 Recycle Pump #1	Train #1 Anoxic Tank	Train #1 Recycle Pump #1 Start/Stop	DO	--	RTU-3	--	--	--	FALSE	--
SC-3161	Train #1 Recycle Pump #1	Train #1 Anoxic Tank	Train #1 Recycle Pump #1 VFD Speed Command	AO	4-20 mA DC	RTU-3	30	100	%	FALSE	--
YI-3162A	Train #1 Recycle Pump #2	Train #1 Anoxic Tank	Train #1 Recycle Pump #2 HOA in Auto	DI	--	RTU-3	--	--	--	FALSE	--
YI-3162B	Train #1 Recycle Pump #2	Train #1 Anoxic Tank	Train #1 Recycle Pump #2 Run Status	DI	--	RTU-3	--	--	--	FALSE	--

**IO AND ALARM LIST**

<b>IO Tag No</b>	<b>Service</b>	<b>Location</b>	<b>IO Description</b>	<b>IO Type</b>	<b>IO Signal Range</b>	<b>CP Termination</b>	<b>LRL</b>	<b>URL</b>	<b>Units</b>	<b>Alarm List</b>	<b>Remarks</b>
MSH-3162	Train #1 Recycle Pump #2	Train #1 Anoxic Tank	Train #1 Recycle Pump #2 Seal Leak	DI	--	RTU-3	--	--	--	TRUE	--
TSH-3162	Train #1 Recycle Pump #2	Train #1 Anoxic Tank	Train #1 Recycle Pump #2 High Motor Temp.	DI	--	RTU-3	--	--	--	TRUE	--
YA-3162	Train #1 Recycle Pump #2	Train #1 Anoxic Tank	Train #1 Recycle Pump #2 VFD Alarm	DI	--	RTU-3	--	--	--	TRUE	--
YI-3162C	Train #1 Recycle Pump #2	Train #1 Anoxic Tank	Train #1 Recycle Pump #2 Emergency Stop	DI	--	RTU-3	--	--	--	TRUE	--
SI-3162	Train #1 Recycle Pump #2	Train #1 Anoxic Tank	Train #1 Recycle Pump #2 VFD Speed	AI	4-20 mA DC	RTU-3	0	100	%	FALSE	--
YS-3162	Train #1 Recycle Pump #2	Train #1 Anoxic Tank	Train #1 Recycle Pump #2 Start/Stop	DO	--	RTU-3	--	--	--	FALSE	--
SC-3162	Train #1 Recycle Pump #2	Train #1 Anoxic Tank	Train #1 Recycle Pump #2 VFD Speed Command	AO	4-20 mA DC	RTU-3	30	100	%	FALSE	--
YI-3211A	Train #2 Anoxic Selector Mixer #1	Train #2 Anoxic Selector	Train #2 Anoxic Selector Mixer #1 HOA in Auto	DI	--	RTU-3	--	--	--	FALSE	--
YI-3211B	Train #2 Anoxic Selector Mixer #1	Train #2 Anoxic Selector	Train #2 Anoxic Selector Mixer #1 Run Status	DI	--	RTU-3	--	--	--	FALSE	--
MSH-3211	Train #2 Anoxic Selector Mixer #1	Train #2 Anoxic Selector	Train #2 Anoxic Selector Mixer #1 Seal Leak	DI	--	RTU-3	--	--	--	TRUE	--

**IO AND ALARM LIST**

<b>IO Tag No</b>	<b>Service</b>	<b>Location</b>	<b>IO Description</b>	<b>IO Type</b>	<b>IO Signal Range</b>	<b>CP Termination</b>	<b>LRL</b>	<b>URL</b>	<b>Units</b>	<b>Alarm List</b>	<b>Remarks</b>
TSH-3211	Train #2 Anoxic Selector Mixer #1	Train #2 Anoxic Selector	Train #2 Anoxic Selector Mixer #1 High Motor Temp.	DI	--	RTU-3	--	--	--	TRUE	--
YA-3211	Train #2 Anoxic Selector Mixer #1	Train #2 Anoxic Selector	Train #2 Anoxic Selector Mixer #1 Overload	DI	--	RTU-3	--	--	--	TRUE	--
YI-3211C	Train #2 Anoxic Selector Mixer #1	Train #2 Anoxic Selector	Train #2 Anoxic Selector Mixer #1 Emergency Stop	DI	--	RTU-3	--	--	--	TRUE	--
YS-3211	Train #2 Anoxic Selector Mixer #1	Train #2 Anoxic Selector	Train #2 Anoxic Selector Mixer #1 Start/Stop	DO	--	RTU-3	--	--	--	FALSE	--
YI-3212A	Train #2 Anoxic Selector Mixer #2	Train #2 Anoxic Selector	Train #2 Anoxic Selector Mixer #2 HOA in Auto	DI	--	RTU-3	--	--	--	FALSE	--
YI-3212B	Train #2 Anoxic Selector Mixer #2	Train #2 Anoxic Selector	Train #2 Anoxic Selector Mixer #2 Run Status	DI	--	RTU-3	--	--	--	FALSE	--
MSH-3212	Train #2 Anoxic Selector Mixer #2	Train #2 Anoxic Selector	Train #2 Anoxic Selector Mixer #2 Seal Leak	DI	--	RTU-3	--	--	--	TRUE	--
TSH-3212	Train #2 Anoxic Selector Mixer #2	Train #2 Anoxic Selector	Train #2 Anoxic Selector Mixer #2 High Motor Temp.	DI	--	RTU-3	--	--	--	TRUE	--
YA-3212	Train #2 Anoxic Selector Mixer #2	Train #2 Anoxic Selector	Train #2 Anoxic Selector Mixer #2 Overload	DI	--	RTU-3	--	--	--	TRUE	--
YI-3212C	Train #2 Anoxic Selector Mixer #2	Train #2 Anoxic Selector	Train #2 Anoxic Selector Mixer #2 Emergency Stop	DI	--	RTU-3	--	--	--	TRUE	--

**IO AND ALARM LIST**

<b>IO Tag No</b>	<b>Service</b>	<b>Location</b>	<b>IO Description</b>	<b>IO Type</b>	<b>IO Signal Range</b>	<b>CP Termination</b>	<b>LRL</b>	<b>URL</b>	<b>Units</b>	<b>Alarm List</b>	<b>Remarks</b>
YS-3212	Train #2 Anoxic Selector Mixer #2	Train #2 Anoxic Selector	Train #2 Anoxic Selector Mixer #2 Start/Stop	DO	--	RTU-3	--	--	--	FALSE	--
YI-3213A	Train #2 Anoxic Selector Mixer #3	Train #2 Anoxic Selector	Train #2 Anoxic Selector Mixer #3 HOA in Auto	DI	--	RTU-3	--	--	--	FALSE	--
YI-3213B	Train #2 Anoxic Selector Mixer #3	Train #2 Anoxic Selector	Train #2 Anoxic Selector Mixer #3 Run Status	DI	--	RTU-3	--	--	--	FALSE	--
MSH-3213	Train #2 Anoxic Selector Mixer #3	Train #2 Anoxic Selector	Train #2 Anoxic Selector Mixer #3 Seal Leak	DI	--	RTU-3	--	--	--	TRUE	--
TSH-3213	Train #2 Anoxic Selector Mixer #3	Train #2 Anoxic Selector	Train #2 Anoxic Selector Mixer #3 High Motor Temp.	DI	--	RTU-3	--	--	--	TRUE	--
YA-3213	Train #2 Anoxic Selector Mixer #3	Train #2 Anoxic Selector	Train #2 Anoxic Selector Mixer #3 Overload	DI	--	RTU-3	--	--	--	TRUE	--
YI-3213C	Train #2 Anoxic Selector Mixer #3	Train #2 Anoxic Selector	Train #2 Anoxic Selector Mixer #3 Emergency Stop	DI	--	RTU-3	--	--	--	TRUE	--
YS-3213	Train #2 Anoxic Selector Mixer #3	Train #2 Anoxic Selector	Train #2 Anoxic Selector Mixer #3 Start/Stop	DO	--	RTU-3	--	--	--	FALSE	--
YI-3231A	Secondary Anoxic Tank #2 Mixer #1	Secondary Anoxic Tank #2	Secondary Anoxic Tank #2 Mixer #1 HOA in Auto	DI	--	RTU-3	--	--	--	FALSE	--
YI-3231B	Secondary Anoxic Tank #2 Mixer #1	Secondary Anoxic Tank #2	Secondary Anoxic Tank #2 Mixer #1 Run Status	DI	--	RTU-3	--	--	--	FALSE	--

**IO AND ALARM LIST**

<b>IO Tag No</b>	<b>Service</b>	<b>Location</b>	<b>IO Description</b>	<b>IO Type</b>	<b>IO Signal Range</b>	<b>CP Termination</b>	<b>LRL</b>	<b>URL</b>	<b>Units</b>	<b>Alarm List</b>	<b>Remarks</b>
MSH-3231	Secondary Anoxic Tank #2 Mixer #1	Secondary Anoxic Tank #2	Secondary Anoxic Tank #2 Mixer #1 Seal Leak	DI	--	RTU-3	--	--	--	TRUE	--
TSH-3231	Secondary Anoxic Tank #2 Mixer #1	Secondary Anoxic Tank #2	Secondary Anoxic Tank #2 Mixer #1 High Motor Temp.	DI	--	RTU-3	--	--	--	TRUE	--
YA-3231	Secondary Anoxic Tank #2 Mixer #1	Secondary Anoxic Tank #2	Secondary Anoxic Tank #2 Mixer #1 Overload	DI	--	RTU-3	--	--	--	TRUE	--
YI-3231C	Secondary Anoxic Tank #2 Mixer #1	Secondary Anoxic Tank #2	Secondary Anoxic Tank #2 Mixer #1 Emergency Stop	DI	--	RTU-3	--	--	--	TRUE	--
YS-3231	Secondary Anoxic Tank #2 Mixer #1	Secondary Anoxic Tank #2	Secondary Anoxic Tank #2 Mixer #1 Start/Stop	DO	--	RTU-3	--	--	--	FALSE	--
YI-3232A	Secondary Anoxic Tank #2 Mixer #2	Secondary Anoxic Tank #2	Secondary Anoxic Tank #2 Mixer #2 HOA in Auto	DI	--	RTU-3	--	--	--	FALSE	--
YI-3232B	Secondary Anoxic Tank #2 Mixer #2	Secondary Anoxic Tank #2	Secondary Anoxic Tank #2 Mixer #2 Run Status	DI	--	RTU-3	--	--	--	FALSE	--
MSH-3232	Secondary Anoxic Tank #2 Mixer #2	Secondary Anoxic Tank #2	Secondary Anoxic Tank #2 Mixer #2 Seal Leak	DI	--	RTU-3	--	--	--	TRUE	--

**IO AND ALARM LIST**

IO Tag No	Service	Location	IO Description	IO Type	IO Signal Range	CP Termination	LRL	URL	Units	Alarm List	Remarks
TSH-3232	Secondary Anoxic Tank #2 Mixer #2	Secondary Anoxic Tank #2	Secondary Anoxic Tank #2 Mixer #2 High Motor Temp.	DI	--	RTU-3	--	--	--	TRUE	--
YA-3232	Secondary Anoxic Tank #2 Mixer #2	Secondary Anoxic Tank #2	Secondary Anoxic Tank #2 Mixer #2 Overload	DI	--	RTU-3	--	--	--	TRUE	--
YI-3232C	Secondary Anoxic Tank #2 Mixer #2	Secondary Anoxic Tank #2	Secondary Anoxic Tank #2 Mixer #2 Emergency Stop	DI	--	RTU-3	--	--	--	TRUE	--
YS-3232	Secondary Anoxic Tank #2 Mixer #2	Secondary Anoxic Tank #2	Secondary Anoxic Tank #2 Mixer #2 Start/Stop	DO	--	RTU-3	--	--	--	FALSE	--
YI-3241A	Re-Aeration Tank #2 <del>Surface Aerator</del> Mixer #1	Re-Aeration Tank #2	Re-Aeration Tank #2 <del>Surface Aerator</del> Mixer #1 HOA in Auto	DI	--	RTU-3	--	--	--	FALSE	--
YI-3241B	Re-Aeration Tank #2 <del>Surface Aerator</del> Mixer #1	Re-Aeration Tank #2	Re-Aeration Tank #2 <del>Surface Aerator</del> Mixer #1 Run Status	DI	--	RTU-3	--	--	--	FALSE	--
TSH-3241	Re-Aeration Tank #2 <del>Surface Aerator</del> Mixer #1	Re-Aeration Tank #2	Re-Aeration Tank #2 <del>Surface Aerator</del> Mixer #1 High Motor Temp.	DI	--	RTU-3	--	--	--	TRUE	--
YA-3241	Re-Aeration Tank #2 <del>Surface Aerator</del> Mixer #1	Re-Aeration Tank #2	Re-Aeration Tank #2 <del>Surface Aerator</del> Mixer #1 VFD Alarm	DI	--	RTU-3	--	--	--	TRUE	--

**IO AND ALARM LIST**

IO Tag No	Service	Location	IO Description	IO Type	IO Signal Range	CP Termination	LRL	URL	Units	Alarm List	Remarks
YI-3241C	Re-Aeration Tank #2 <del>Surface Aerator</del> Mixer #1	Re-Aeration Tank #2	Re-Aeration Tank #2 <del>Surface Aerator</del> Mixer #1 Emergency Stop	DI	--	RTU-3	--	--	--	TRUE	--
SI-3241	Re-Aeration Tank #2 <del>Surface Aerator</del> Mixer #1	Re-Aeration Tank #2	Re-Aeration Tank #2 <del>Surface Aerator</del> Mixer #1 VFD Speed	AI	4-20 mA DC	RTU-3	0	100	%	FALSE	--
YS-3241	Re-Aeration Tank #2 <del>Surface Aerator</del> Mixer #1	Re-Aeration Tank #2	Re-Aeration Tank #2 <del>Surface Aerator</del> Mixer #1 Start/Stop	DO	--	RTU-3	--	--	--	FALSE	--
SC-3241	Re-Aeration Tank #2 <del>Surface Aerator</del> Mixer #1	Re-Aeration Tank #2	Re-Aeration Tank #2 <del>Surface Aerator</del> Mixer #1 VFD Speed Command	AO	4-20 mA DC	RTU-3	30	100	%	FALSE	--
YI-3242A	Re-Aeration Tank #2 <del>Surface Aerator</del> Mixer #2	Re-Aeration Tank #2	Re-Aeration Tank #2 <del>Surface Aerator</del> Mixer #2 HOA in Auto	DI	--	RTU-3	--	--	--	FALSE	--
YI-3242B	Re-Aeration Tank #2 <del>Surface Aerator</del> Mixer #2	Re-Aeration Tank #2	Re-Aeration Tank #2 <del>Surface Aerator</del> Mixer #2 Run Status	DI	--	RTU-3	--	--	--	FALSE	--
TSH-3242	Re-Aeration Tank #2 <del>Surface Aerator</del> Mixer #2	Re-Aeration Tank #2	Re-Aeration Tank #2 <del>Surface Aerator</del> Mixer #2 High Motor Temp.	DI	--	RTU-3	--	--	--	TRUE	--
YA-3242	Re-Aeration Tank #2 <del>Surface Aerator</del> Mixer #2	Re-Aeration Tank #2	Re-Aeration Tank #2 <del>Surface Aerator</del> Mixer #2 VFD Alarm	DI	--	RTU-3	--	--	--	TRUE	--



**IO AND ALARM LIST**

IO Tag No	Service	Location	IO Description	IO Type	IO Signal Range	CP Termination	LRL	URL	Units	Alarm List	Remarks
YI-3242C	Re-Aeration Tank #2 <del>Surface Aerator</del> Mixer #2	Re-Aeration Tank #2	Re-Aeration Tank #2 <del>Surface Aerator</del> Mixer #2 Emergency Stop	DI	--	RTU-3	--	--	--	TRUE	--
SI-3242	Re-Aeration Tank #2 <del>Surface Aerator</del> Mixer #2	Re-Aeration Tank #2	Re-Aeration Tank #2 <del>Surface Aerator</del> Mixer #2 VFD Speed	AI	4-20 mA DC	RTU-3	0	100	%	FALSE	--
YS-3242	Re-Aeration Tank #2 <del>Surface Aerator</del> Mixer #2	Re-Aeration Tank #2	Re-Aeration Tank #2 <del>Surface Aerator</del> Mixer #2 Start/Stop	DO	--	RTU-3	--	--	--	FALSE	--
SC-3242	Re-Aeration Tank #2 <del>Surface Aerator</del> Mixer #2	Re-Aeration Tank #2	Re-Aeration Tank #2 <del>Surface Aerator</del> Mixer #2 VFD Speed Command	AO	4-20 mA DC	RTU-3	30	100	%	FALSE	--
YI-3243A	Re-Aeration Tank #2 <del>Surface Aerator</del> Mixer #3	Re-Aeration Tank #2	Re-Aeration Tank #2 <del>Surface Aerator</del> Mixer #3 HOA in Auto	DI	--	RTU-3	--	--	--	FALSE	--
YI-3243B	Re-Aeration Tank #2 <del>Surface Aerator</del> Mixer #3	Re-Aeration Tank #2	Re-Aeration Tank #2 <del>Surface Aerator</del> Mixer #3 Run Status	DI	--	RTU-3	--	--	--	FALSE	--
TSH-3243	Re-Aeration Tank #2 <del>Surface Aerator</del> Mixer #3	Re-Aeration Tank #2	Re-Aeration Tank #2 <del>Surface Aerator</del> Mixer #3 High Motor Temp.	DI	--	RTU-3	--	--	--	TRUE	--
YA-3243	Re-Aeration Tank #2 <del>Surface Aerator</del> Mixer #3	Re-Aeration Tank #2	Re-Aeration Tank #2 <del>Surface Aerator</del> Mixer #3 VFD Alarm	DI	--	RTU-3	--	--	--	TRUE	--

**IO AND ALARM LIST**

IO Tag No	Service	Location	IO Description	IO Type	IO Signal Range	CP Termination	LRL	URL	Units	Alarm List	Remarks
YI-3243C	Re-Aeration Tank #2 <del>Surface Aerator</del> Mixer #3	Re-Aeration Tank #2	Re-Aeration Tank #2 <del>Surface Aerator</del> Mixer #3 Emergency Stop	DI	--	RTU-3	--	--	--	TRUE	--
SI-3243	Re-Aeration Tank #2 <del>Surface Aerator</del> Mixer #3	Re-Aeration Tank #2	Re-Aeration Tank #2 <del>Surface Aerator</del> Mixer #3 VFD Speed	AI	4-20 mA DC	RTU-3	0	100	%	FALSE	--
YS-3243	Re-Aeration Tank #2 <del>Surface Aerator</del> Mixer #3	Re-Aeration Tank #2	Re-Aeration Tank #2 <del>Surface Aerator</del> Mixer #3 Start/Stop	DO	--	RTU-3	--	--	--	FALSE	--
SC-3243	Re-Aeration Tank #2 <del>Surface Aerator</del> Mixer #3	Re-Aeration Tank #2	Re-Aeration Tank #2 <del>Surface Aerator</del> Mixer #3 VFD Speed Command	AO	4-20 mA DC	RTU-3	30	100	%	FALSE	--
YI-3244A	Re-Aeration Tank #2 Blower #1	Re-Aeration Tank #2	Re-Aeration Tank #2 Blower #1 HOA in Auto	DI	--	RTU-3	--	--	--	FALSE	--
YI-3244B	Re-Aeration Tank #2 Blower #1	Re-Aeration Tank #2	Re-Aeration Tank #2 Blower #1 Run Status	DI	--	RTU-3	--	--	--	FALSE	--
TSH-3244	Re-Aeration Tank #2 Blower #1	Re-Aeration Tank #2	Re-Aeration Tank #2 Blower #1 High Motor Temp.	DI	--	RTU-3	--	--	--	TRUE	--
YA-3244	Re-Aeration Tank #2 Blower #1	Re-Aeration Tank #2	Re-Aeration Tank #2 Blower #1 Overload	DI	--	RTU-3	--	--	--	TRUE	--
YI-3244C	Re-Aeration Tank #2 Blower #1	Re-Aeration Tank #2	Re-Aeration Tank #2 Blower #1 Emergency Stop	DI	--	RTU-3	--	--	--	TRUE	--

**IO AND ALARM LIST**

<b>IO Tag No</b>	<b>Service</b>	<b>Location</b>	<b>IO Description</b>	<b>IO Type</b>	<b>IO Signal Range</b>	<b>CP Termination</b>	<b>LRL</b>	<b>URL</b>	<b>Units</b>	<b>Alarm List</b>	<b>Remarks</b>
YI-3245A	Re-Aeration Tank #2 Blower #2	Re-Aeration Tank #2	Re-Aeration Tank #2 Blower #2 HOA in Auto	DI	--	RTU-3	--	--	--	FALSE	--
YI-3245B	Re-Aeration Tank #2 Blower #2	Re-Aeration Tank #2	Re-Aeration Tank #2 Blower #2 Run Status	DI	--	RTU-3	--	--	--	FALSE	--
TSH-3245	Re-Aeration Tank #2 Blower #2	Re-Aeration Tank #2	Re-Aeration Tank #2 Blower #2 High Motor Temp.	DI	--	RTU-3	--	--	--	TRUE	--
YA-3245	Re-Aeration Tank #2 Blower #2	Re-Aeration Tank #2	Re-Aeration Tank #2 Blower #2 Overload	DI	--	RTU-3	--	--	--	TRUE	--
YI-3245C	Re-Aeration Tank #2 Blower #2	Re-Aeration Tank #2	Re-Aeration Tank #2 Blower #2 Emergency Stop	DI	--	RTU-3	--	--	--	TRUE	--
YI-3246A	Re-Aeration Tank #2 Blower #3	Re-Aeration Tank #2	Re-Aeration Tank #2 Blower #3 HOA in Auto	DI	--	RTU-3	--	--	--	FALSE	--
YI-3246B	Re-Aeration Tank #2 Blower #3	Re-Aeration Tank #2	Re-Aeration Tank #2 Blower #3 Run Status	DI	--	RTU-3	--	--	--	FALSE	--
TSH-3246	Re-Aeration Tank #2 Blower #3	Re-Aeration Tank #2	Re-Aeration Tank #2 Blower #3 High Motor Temp.	DI	--	RTU-3	--	--	--	TRUE	--
YA-3246	Re-Aeration Tank #2 Blower #3	Re-Aeration Tank #2	Re-Aeration Tank #2 Blower #3 Overload	DI	--	RTU-3	--	--	--	TRUE	--
YI-3246C	Re-Aeration Tank #2 Blower #3	Re-Aeration Tank #2	Re-Aeration Tank #2 Blower #3 Emergency Stop	DI	--	RTU-3	--	--	--	TRUE	--

**IO AND ALARM LIST**

<b>IO Tag No</b>	<b>Service</b>	<b>Location</b>	<b>IO Description</b>	<b>IO Type</b>	<b>IO Signal Range</b>	<b>CP Termination</b>	<b>LRL</b>	<b>URL</b>	<b>Units</b>	<b>Alarm List</b>	<b>Remarks</b>
YI-3251A	Train #2 Anoxic Aerobic Mixer	Train #2 Anoxic Aerobic	Train #2 Anoxic Aerobic Mixer HOA in Auto	DI	--	RTU-3	--	--	--	FALSE	--
YI-3251B	Train #2 Anoxic Aerobic Mixer	Train #2 Anoxic Aerobic	Train #2 Anoxic Aerobic Mixer Run Status	DI	--	RTU-3	--	--	--	FALSE	--
MSH-3251	Train #2 Anoxic Aerobic Mixer	Train #2 Anoxic Aerobic	Train #2 Anoxic Aerobic Mixer Seal Leak	DI	--	RTU-3	--	--	--	TRUE	--
TSH-3251	Train #2 Anoxic Aerobic Mixer	Train #2 Anoxic Aerobic	Train #2 Anoxic Aerobic Mixer High Motor Temp.	DI	--	RTU-3	--	--	--	TRUE	--
YA-3251	Train #2 Anoxic Aerobic Mixer	Train #2 Anoxic Aerobic	Train #2 Anoxic Aerobic Mixer Overload	DI	--	RTU-3	--	--	--	TRUE	--
YI-3251C	Train #2 Anoxic Aerobic Mixer	Train #2 Anoxic Aerobic	Train #2 Anoxic Aerobic Mixer Emergency Stop	DI	--	RTU-3	--	--	--	TRUE	--
YI-3261A	Train #2 Recycle Pump #1	Train #2 Anoxic Tank	Train #2 Recycle Pump #1 HOA in Auto	DI	--	RTU-3	--	--	--	FALSE	--
YI-3261B	Train #2 Recycle Pump #1	Train #2 Anoxic Tank	Train #2 Recycle Pump #1 Run Status	DI	--	RTU-3	--	--	--	FALSE	--
MSH-3261	Train #2 Recycle Pump #1	Train #2 Anoxic Tank	Train #2 Recycle Pump #1 Seal Leak	DI	--	RTU-3	--	--	--	TRUE	--
TSH-3261	Train #2 Recycle Pump #1	Train #2 Anoxic Tank	Train #2 Recycle Pump #1 High Motor Temp.	DI	--	RTU-3	--	--	--	TRUE	--
YA-3261	Train #2 Recycle Pump #1	Train #2 Anoxic Tank	Train #2 Recycle Pump #1 VFD Alarm	DI	--	RTU-3	--	--	--	TRUE	--

**IO AND ALARM LIST**

<b>IO Tag No</b>	<b>Service</b>	<b>Location</b>	<b>IO Description</b>	<b>IO Type</b>	<b>IO Signal Range</b>	<b>CP Termination</b>	<b>LRL</b>	<b>URL</b>	<b>Units</b>	<b>Alarm List</b>	<b>Remarks</b>
YI-3261C	Train #2 Recycle Pump #1	Train #2 Anoxic Tank	Train #2 Recycle Pump #1 Emergency Stop	DI	--	RTU-3	--	--	--	TRUE	--
SI-3261	Train #2 Recycle Pump #1	Train #2 Anoxic Tank	Train #2 Recycle Pump #1 VFD Speed	AI	4-20 mA DC	RTU-3	0	100	%	FALSE	--
YS-3261	Train #2 Recycle Pump #1	Train #2 Anoxic Tank	Train #2 Recycle Pump #1 Start/Stop	DO	--	RTU-3	--	--	--	FALSE	--
SC-3261	Train #2 Recycle Pump #1	Train #2 Anoxic Tank	Train #2 Recycle Pump #1 VFD Speed Command	AO	4-20 mA DC	RTU-3	30	100	%	FALSE	--
YI-3262A	Train #2 Recycle Pump #2	Train #2 Anoxic Tank	Train #2 Recycle Pump #2 HOA in Auto	DI	--	RTU-3	--	--	--	FALSE	--
YI-3262B	Train #2 Recycle Pump #2	Train #2 Anoxic Tank	Train #2 Recycle Pump #2 Run Status	DI	--	RTU-3	--	--	--	FALSE	--
MSH-3262	Train #2 Recycle Pump #2	Train #2 Anoxic Tank	Train #2 Recycle Pump #2 Seal Leak	DI	--	RTU-3	--	--	--	TRUE	--
TSH-3262	Train #2 Recycle Pump #2	Train #2 Anoxic Tank	Train #2 Recycle Pump #2 High Motor Temp.	DI	--	RTU-3	--	--	--	TRUE	--
YA-3262	Train #2 Recycle Pump #2	Train #2 Anoxic Tank	Train #2 Recycle Pump #2 VFD Alarm	DI	--	RTU-3	--	--	--	TRUE	--
YI-3262C	Train #2 Recycle Pump #2	Train #2 Anoxic Tank	Train #2 Recycle Pump #2 Emergency Stop	DI	--	RTU-3	--	--	--	TRUE	--

**IO AND ALARM LIST**

IO Tag No	Service	Location	IO Description	IO Type	IO Signal Range	CP Termination	LRL	URL	Units	Alarm List	Remarks
SI-3262	Train #2 Recycle Pump #2	Train #2 Anoxic Tank	Train #2 Recycle Pump #2 VFD Speed	AI	4-20 mA DC	RTU-3	0	100	%	FALSE	--
YS-3262	Train #2 Recycle Pump #2	Train #2 Anoxic Tank	Train #2 Recycle Pump #2 Start/Stop	DO	--	RTU-3	--	--	--	FALSE	--
SC-3262	Train #2 Recycle Pump #2	Train #2 Anoxic Tank	Train #2 Recycle Pump #2 VFD Speed Command	AO	4-20 mA DC	RTU-3	30	100	%	FALSE	--
ZSO-34011	Train #1 Biological Tanks Influent Slide Gate	Train #1 Biological Tanks	Train #1 Biological Tanks Influent Slide Gate Open	DI	--	RTU-3	--	--	--	FALSE	--
ZSC-34011	Train #1 Biological Tanks Influent Slide Gate	Train #1 Biological Tanks	Train #1 Biological Tanks Influent Slide Gate Closed	DI	--	RTU-3	--	--	--	FALSE	--
ZSO-34012	Train #2 Biological Tanks Influent Slide Gate	Train #2 Biological Tanks	Train #2 Biological Tanks Influent Slide Gate Open	DI	--	RTU-3	--	--	--	FALSE	--
ZSC-34012	Train #2 Biological Tanks Influent Slide Gate	Train #2 Biological Tanks	Train #2 Biological Tanks Influent Slide Gate Closed	DI	--	RTU-3	--	--	--	FALSE	--
ZSO-3431	Secondary Anoxic Tank #1 Influent Slide Gate	Secondary Anoxic Tank #1	Secondary Anoxic Tank #1 Influent Slide Gate Open	DI	--	RTU-3	--	--	--	FALSE	--

**IO AND ALARM LIST**

<b>IO Tag No</b>	<b>Service</b>	<b>Location</b>	<b>IO Description</b>	<b>IO Type</b>	<b>IO Signal Range</b>	<b>CP Termination</b>	<b>LRL</b>	<b>URL</b>	<b>Units</b>	<b>Alarm List</b>	<b>Remarks</b>
ZSC-3431	Secondary Anoxic Tank #1 Influent Slide Gate	Secondary Anoxic Tank #1	Secondary Anoxic Tank #1 Influent Slide Gate Closed	DI	--	RTU-3	--	--	--	FALSE	--
ZSO-3432	Secondary Anoxic Tank #2 Influent Slide Gate	Secondary Anoxic Tank #2	Secondary Anoxic Tank #2 Influent Slide Gate Open	DI	--	RTU-3	--	--	--	FALSE	--
ZSC-3432	Secondary Anoxic Tank #2 Influent Slide Gate	Secondary Anoxic Tank #2	Secondary Anoxic Tank #2 Influent Slide Gate Closed	DI	--	RTU-3	--	--	--	FALSE	--
ZSO-3441	Re-Aeration Tank #1 Influent Slide Gate	Re-Aeration Tank #1	Re-Aeration Tank #1 Influent Slide Gate Open	DI	--	RTU-3	--	--	--	FALSE	--
ZSC-3441	Re-Aeration Tank #1 Influent Slide Gate	Re-Aeration Tank #1	Re-Aeration Tank #1 Influent Slide Gate Closed	DI	--	RTU-3	--	--	--	FALSE	--
ZSO-3442	Re-Aeration Tank #2 Influent Slide Gate	Re-Aeration Tank #2	Re-Aeration Tank #2 Influent Slide Gate Open	DI	--	RTU-3	--	--	--	FALSE	--
ZSC-3442	Re-Aeration Tank #2 Influent Slide Gate	Re-Aeration Tank #2	Re-Aeration Tank #2 Influent Slide Gate Closed	DI	--	RTU-3	--	--	--	FALSE	--
ZSO-3443	Re-Aeration Tank #1 Effluent Slide Gate	Re-Aeration Tank #1	Re-Aeration Tank #1 Effluent Slide Gate Open	DI	--	RTU-3	--	--	--	FALSE	--
ZSC-3443	Re-Aeration Tank #1 Effluent Slide Gate	Re-Aeration Tank #1	Re-Aeration Tank #1 Effluent Slide Gate Closed	DI	--	RTU-3	--	--	--	FALSE	--

**IO AND ALARM LIST**

IO Tag No	Service	Location	IO Description	IO Type	IO Signal Range	CP Termination	LRL	URL	Units	Alarm List	Remarks
ZSO-3444	Re-Aeration Tank #2 Effluent Slide Gate	Re-Aeration Tank #2	Re-Aeration Tank #2 Effluent Slide Gate Open	DI	--	RTU-3	--	--	--	FALSE	--
ZSC-3444	Re-Aeration Tank #2 Effluent Slide Gate	Re-Aeration Tank #2	Re-Aeration Tank #2 Effluent Slide Gate Closed	DI	--	RTU-3	--	--	--	FALSE	--
AIT-3501	Train #1 Anoxic Selector #3 NO3 Level	Train #1 Anoxic Selector #3	Train #1 Anoxic Selector #3 NO3 Level	AI	4-20 mA DC	RTU-3	0.1	100	Mg/L	TRUE	AAHH, AAH, AAL, AALL
AIT-3502	Train #1 Anoxic Selector #3 pH Level	Train #1 Anoxic Selector #3	Train #1 Anoxic Selector #3 pH Level	AI	4-20 mA DC	RTU-3	0	14	pH	TRUE	AAHH, AAH, AAL, AALL
AIT-3503	Train #1 Anoxic Selector #3 DO Level	Train #1 Anoxic Selector #3	Train #1 Anoxic Selector #3 DO Level	AI	4-20 mA DC	RTU-3	0.01	20	Mg/L	TRUE	AAHH, AAH, AAL, AALL
AIT-3504	Train #1 Aerobic Zone #1 DO Level	Train #1 Aerobic Zone #1	Train #1 Aerobic Zone #1 DO Level	AI	4-20 mA DC	RTU-3	0.01	20	Mg/L	TRUE	AAHH, AAH, AAL, AALL
AIT-3505	Train #1 Aerobic Zone #2 DO Level	Train #1 Aerobic Zone #2	Train #1 Aerobic Zone #2 DO Level	AI	4-20 mA DC	RTU-3	0.01	20	Mg/L	TRUE	AAHH, AAH, AAL, AALL
AIT-3506	Train #1 Aerobic Zone #2 pH Level	Train #1 Aerobic Zone #2	Train #1 Aerobic Zone #2 pH Level	AI	4-20 mA DC	RTU-3	0	14	pH	TRUE	AAHH, AAH, AAL, AALL
AIT-3507	Train #1 Aerobic Zone #3 DO Level	Train #1 Aerobic Zone #3	Train #1 Aerobic Zone #3 DO Level	AI	4-20 mA DC	RTU-3	0.01	20	Mg/L	TRUE	AAHH, AAH, AAL, AALL
AIT-3508	Train #1 Aerobic Zone #3 NO3 Level	Train #1 Aerobic Zone #3	Train #1 Aerobic Zone #3 NO3 Level	AI	4-20 mA DC	RTU-3	0.1	100	Mg/L	TRUE	AAHH, AAH, AAL, AALL
AIT-350910	Train #1 Aerobic Zone #3 NH4 Level	Train #1 Aerobic Zone #3	Train #1 Aerobic Zone #3 NH4 Level	AI	4-20 mA DC	RTU-3	0.01	20	Mg/L	TRUE	AAHH, AAH, AAL, AALL



**IO AND ALARM LIST**

<b>IO Tag No</b>	<b>Service</b>	<b>Location</b>	<b>IO Description</b>	<b>IO Type</b>	<b>IO Signal Range</b>	<b>CP Termination</b>	<b>LRL</b>	<b>URL</b>	<b>Units</b>	<b>Alarm List</b>	<b>Remarks</b>
AIT-3511	Secondary Anoxic Tank #1 DO Level	Secondary Anoxic Tank #1	Secondary Anoxic Tank #1 DO Level	AI	4-20 mA DC	RTU-3	0.01	20	Mg/L	TRUE	AAHH, AAH, AAL, AALL
AIT-3512	Secondary Anoxic Tank #1 NO3 Level	Secondary Anoxic Tank #1	Secondary Anoxic Tank #1 NO3 Level	AI	4-20 mA DC	RTU-3	0.1	100	Mg/L	TRUE	AAHH, AAH, AAL, AALL
AIT-3513	Re-Aeration Tank #1 DO Level	Re-Aeration Tank #1	Re-Aeration Tank #1 DO Level	AI	4-20 mA DC	RTU-3	0.01	20	Mg/L	TRUE	AAHH, AAH, AAL, AALL
AIT-3521	Train #2 Anoxic Selector #3 NO3 Level	Train #2 Anoxic Selector #3	Train #2 Anoxic Selector #3 NO3 Level	AI	4-20 mA DC	RTU-3	0.1	100	Mg/L	TRUE	AAHH, AAH, AAL, AALL
AIT-3522	Train #2 Anoxic Selector #3 pH Level	Train #2 Anoxic Selector #3	Train #2 Anoxic Selector #3 pH Level	AI	4-20 mA DC	RTU-3	0	14	pH	TRUE	AAHH, AAH, AAL, AALL
AIT-3523	Train #2 Anoxic Selector #3 DO Level	Train #2 Anoxic Selector #3	Train #2 Anoxic Selector #3 DO Level	AI	4-20 mA DC	RTU-3	0.01	20	Mg/L	TRUE	AAHH, AAH, AAL, AALL
AIT-3524	Train #2 Aerobic Zone #1 DO Level	Train #2 Aerobic Zone #1	Train #2 Aerobic Zone #1 DO Level	AI	4-20 mA DC	RTU-3	0.01	20	Mg/L	TRUE	AAHH, AAH, AAL, AALL
AIT-3525	Train #2 Aerobic Zone #2 DO Level	Train #2 Aerobic Zone #2	Train #2 Aerobic Zone #2 DO Level	AI	4-20 mA DC	RTU-3	0.01	20	Mg/L	TRUE	AAHH, AAH, AAL, AALL
AIT-3526	Train #2 Aerobic Zone #2 pH Level	Train #2 Aerobic Zone #2	Train #2 Aerobic Zone #2 pH Level	AI	4-20 mA DC	RTU-3	0	14	pH	TRUE	AAHH, AAH, AAL, AALL
AIT-3527	Train #2 Aerobic Zone #3 DO Level	Train #2 Aerobic Zone #3	Train #2 Aerobic Zone #3 DO Level	AI	4-20 mA DC	RTU-3	0.01	20	Mg/L	TRUE	AAHH, AAH, AAL, AALL
AIT-3528	Train #2 Aerobic Zone #3 NO3 Level	Train #2 Aerobic Zone #3	Train #2 Aerobic Zone #3 NO3 Level	AI	4-20 mA DC	RTU-3	0.1	100	Mg/L	TRUE	AAHH, AAH, AAL, AALL

**IO AND ALARM LIST**

IO Tag No	Service	Location	IO Description	IO Type	IO Signal Range	CP Termination	LRL	URL	Units	Alarm List	Remarks
AIT-350930	Train #2 Aerobic Zone #3 NH4 Level	Train #2 Aerobic Zone #3	Train #2 Aerobic Zone #3 NH4 Level	AI	4-20 mA DC	RTU-3	0.01	20	Mg/L	TRUE	AAHH, AAH, AAL, AALL
AIT-3531	Secondary Anoxic Tank #2 DO Level	Secondary Anoxic Tank #2	Secondary Anoxic Tank #2 DO Level	AI	4-20 mA DC	RTU-3	0.01	20	Mg/L	TRUE	AAHH, AAH, AAL, AALL
AIT-3532	Secondary Anoxic Tank #2 NO3 Level	Secondary Anoxic Tank #2	Secondary Anoxic Tank #2 NO3 Level	AI	4-20 mA DC	RTU-3	0.1	100	Mg/L	TRUE	AAHH, AAH, AAL, AALL
AIT-3533	Re-Aeration Tank #2 DO Level	Re-Aeration Tank #2	Re-Aeration Tank #2 DO Level	AI	4-20 mA DC	RTU-3	0.01	20	Mg/L	TRUE	AAHH, AAH, AAL, AALL
YI-4101A	Final Clarifier #1	Final Clarifier #1	Final Clarifier #1 HOA in Auto	DI	--	RTU-4A	--	--	--	FALSE	--
YI-4101B	Final Clarifier #1	Final Clarifier #1	Final Clarifier #1 Run Status	DI	--	RTU-4A	--	--	--	FALSE	--
WSH-4101	Final Clarifier #1	Final Clarifier #1	Final Clarifier #1 High Torque	DI	--	RTU-4A	--	--	--	TRUE	--
YA-4101	Final Clarifier #1	Final Clarifier #1	Final Clarifier #1 Overload	DI	--	RTU-4A	--	--	--	TRUE	--
YI-4101C	Final Clarifier #1	Final Clarifier #1	Final Clarifier #1 Emergency Stop	DI	--	RTU-4A	--	--	--	TRUE	--
YS-4101	Final Clarifier #1	Final Clarifier #1	Final Clarifier #1 Start/Stop	DO	--	RTU-4A	--	--	--	FALSE	--
YI-4102A	Final Clarifier #2	Final Clarifier #2	Final Clarifier #2 HOA in Auto	DI	--	RTU-4A	--	--	--	FALSE	--
YI-4102B	Final Clarifier #2	Final Clarifier #2	Final Clarifier #2 Run Status	DI	--	RTU-4A	--	--	--	FALSE	--
WSH-4102	Final Clarifier #2	Final Clarifier #2	Final Clarifier #2 High Torque	DI	--	RTU-4A	--	--	--	TRUE	--
YA-4102	Final Clarifier #2	Final Clarifier #2	Final Clarifier #2 Overload	DI	--	RTU-4A	--	--	--	TRUE	--

**IO AND ALARM LIST**

IO Tag No	Service	Location	IO Description	IO Type	IO Signal Range	CP Termination	LRL	URL	Units	Alarm List	Remarks
YI-4102C	Final Clarifier #2	Final Clarifier #2	Final Clarifier #2 Emergency Stop	DI	--	RTU-4A	--	--	--	TRUE	--
YS-4102	Final Clarifier #2	Final Clarifier #2	Final Clarifier #2 Start/Stop	DO	--	RTU-4A	--	--	--	FALSE	--
YI-4111A	RAS Sludge Pump #1	Sludge Pumping Station #1	RAS Sludge Pump #1 HOA in Auto	DI	--	RTU-4A	--	--	--	FALSE	--
YI-4111B	RAS Sludge Pump #1	Sludge Pumping Station #1	RAS Sludge Pump #1 Run Status	DI	--	RTU-4A	--	--	--	FALSE	--
TSH-4111	RAS Sludge Pump #1	Sludge Pumping Station #1	RAS Sludge Pump #1 High Motor Temp.	DI	--	RTU-4A	--	--	--	TRUE	--
YA-4111	RAS Sludge Pump #1	Sludge Pumping Station #1	RAS Sludge Pump #1 VFD Alarm	DI	--	RTU-4A	--	--	--	TRUE	--
YI-4111C	RAS Sludge Pump #1	Sludge Pumping Station #1	RAS Sludge Pump #1 Emergency Stop	DI	--	RTU-4A	--	--	--	TRUE	--
PSH-4111	RAS Sludge Pump #1	Sludge Pumping Station #1	RAS Sludge Pump #1 Water Seal Failure	DI	--	RTU-4A	--	--	--	TRUE	--
SI-4111	RAS Sludge Pump #1	Sludge Pumping Station #1	RAS Sludge Pump #1 VFD Speed	AI	4-20 mA DC	RTU-4A	0	100	%	FALSE	--
YS-4111	RAS Sludge Pump #1	Sludge Pumping Station #1	RAS Sludge Pump #1 Start/Stop	DO	--	RTU-4A	--	--	--	FALSE	--
SC-4111	RAS Sludge Pump #1	Sludge Pumping Station #1	RAS Sludge Pump #1 VFD Speed Command	AO	4-20 mA DC	RTU-4A	30	100	%	FALSE	--

**IO AND ALARM LIST**

IO Tag No	Service	Location	IO Description	IO Type	IO Signal Range	CP Termination	LRL	URL	Units	Alarm List	Remarks
YI-4112A	RAS Sludge Pump #2	Sludge Pumping Station #1	RAS Sludge Pump #2 HOA in Auto	DI	--	RTU-4A	--	--	--	FALSE	--
YI-4112B	RAS Sludge Pump #2	Sludge Pumping Station #1	RAS Sludge Pump #2 Run Status	DI	--	RTU-4A	--	--	--	FALSE	--
TSH-4112	RAS Sludge Pump #2	Sludge Pumping Station #1	RAS Sludge Pump #2 High Motor Temp.	DI	--	RTU-4A	--	--	--	TRUE	--
YA-4112	RAS Sludge Pump #2	Sludge Pumping Station #1	RAS Sludge Pump #2 VFD Alarm	DI	--	RTU-4A	--	--	--	TRUE	--
YI-4112C	RAS Sludge Pump #2	Sludge Pumping Station #1	RAS Sludge Pump #2 Emergency Stop	DI	--	RTU-4A	--	--	--	TRUE	--
PSH-4112	RAS Sludge Pump #2	Sludge Pumping Station #1	RAS Sludge Pump #2 Water Seal Failure	DI	--	RTU-4A	--	--	--	TRUE	--
SI-4112	RAS Sludge Pump #2	Sludge Pumping Station #1	RAS Sludge Pump #2 VFD Speed	AI	4-20 mA DC	RTU-4A	0	100	%	FALSE	--
YS-4112	RAS Sludge Pump #2	Sludge Pumping Station #1	RAS Sludge Pump #2 Start/Stop	DO	--	RTU-4A	--	--	--	FALSE	--
SC-4112	RAS Sludge Pump #2	Sludge Pumping Station #1	RAS Sludge Pump #2 VFD Speed Command	AO	4-20 mA DC	RTU-4A	30	100	%	FALSE	--
YI-4113A	RAS Sludge Pump #3	Sludge Pumping Station #1	RAS Sludge Pump #3 HOA in Auto	DI	--	RTU-4A	--	--	--	FALSE	--
YI-4113B	RAS Sludge Pump #3	Sludge Pumping Station #1	RAS Sludge Pump #3 Run Status	DI	--	RTU-4A	--	--	--	FALSE	--

**IO AND ALARM LIST**

IO Tag No	Service	Location	IO Description	IO Type	IO Signal Range	CP Termination	LRL	URL	Units	Alarm List	Remarks
TSH-4113	RAS Sludge Pump #3	Sludge Pumping Station #1	RAS Sludge Pump #3 High Motor Temp.	DI	--	RTU-4A	--	--	--	TRUE	--
YA-4113	RAS Sludge Pump #3	Sludge Pumping Station #1	RAS Sludge Pump #3 VFD Alarm	DI	--	RTU-4A	--	--	--	TRUE	--
YI-4113C	RAS Sludge Pump #3	Sludge Pumping Station #1	RAS Sludge Pump #3 Emergency Stop	DI	--	RTU-4A	--	--	--	TRUE	--
PSH-4113	RAS Sludge Pump #3	Sludge Pumping Station #1	RAS Sludge Pump #3 Water Seal Failure	DI	--	RTU-4A	--	--	--	TRUE	--
SI-4113	RAS Sludge Pump #3	Sludge Pumping Station #1	RAS Sludge Pump #3 VFD Speed	AI	4-20 mA DC	RTU-4A	0	100	%	FALSE	--
YS-4113	RAS Sludge Pump #3	Sludge Pumping Station #1	RAS Sludge Pump #3 Start/Stop	DO	--	RTU-4A	--	--	--	FALSE	--
SC-4113	RAS Sludge Pump #3	Sludge Pumping Station #1	RAS Sludge Pump #3 VFD Speed Command	AO	4-20 mA DC	RTU-4A	30	100	%	FALSE	--
YI-4121A	WAS Sludge Pump #1	Sludge Pumping Station #1	WAS Sludge Pump #1 HOA in Auto	DI	--	RTU-4A	--	--	--	FALSE	--
YI-4121B	WAS Sludge Pump #1	Sludge Pumping Station #1	WAS Sludge Pump #1 Run Status	DI	--	RTU-4A	--	--	--	FALSE	--
TSH-4121	WAS Sludge Pump #1	Sludge Pumping Station #1	WAS Sludge Pump #1 High Motor Temp.	DI	--	RTU-4A	--	--	--	TRUE	--
YA-4121	WAS Sludge Pump #1	Sludge Pumping Station #1	WAS Sludge Pump #1 VFD Alarm	DI	--	RTU-4A	--	--	--	TRUE	--

**IO AND ALARM LIST**

IO Tag No	Service	Location	IO Description	IO Type	IO Signal Range	CP Termination	LRL	URL	Units	Alarm List	Remarks
YI-4121C	WAS Sludge Pump #1	Sludge Pumping Station #1	WAS Sludge Pump #1 Emergency Stop	DI	--	RTU-4A	--	--	--	TRUE	--
PSH-4121	WAS Sludge Pump #1	Sludge Pumping Station #1	WAS Sludge Pump #1 Water Seal Failure	DI	--	RTU-4A	--	--	--	TRUE	--
SI-4121	WAS Sludge Pump #1	Sludge Pumping Station #1	WAS Sludge Pump #1 VFD Speed	AI	4-20 mA DC	RTU-4A	0	100	%	FALSE	--
YS-4121	WAS Sludge Pump #1	Sludge Pumping Station #1	WAS Sludge Pump #1 Start/Stop	DO	--	RTU-4A	--	--	--	FALSE	--
SC-4121	WAS Sludge Pump #1	Sludge Pumping Station #1	WAS Sludge Pump #1 VFD Speed Command	AO	4-20 mA DC	RTU-4A	30	100	%	FALSE	--
YI-4122A	WAS Sludge Pump #2	Sludge Pumping Station #1	WAS Sludge Pump #2 HOA in Auto	DI	--	RTU-4A	--	--	--	FALSE	--
YI-4122B	WAS Sludge Pump #2	Sludge Pumping Station #1	WAS Sludge Pump #2 Run Status	DI	--	RTU-4A	--	--	--	FALSE	--
TSH-4122	WAS Sludge Pump #2	Sludge Pumping Station #1	WAS Sludge Pump #2 High Motor Temp.	DI	--	RTU-4A	--	--	--	TRUE	--
YA-4122	WAS Sludge Pump #2	Sludge Pumping Station #1	WAS Sludge Pump #2 VFD Alarm	DI	--	RTU-4A	--	--	--	TRUE	--
YI-4122C	WAS Sludge Pump #2	Sludge Pumping Station #1	WAS Sludge Pump #2 Emergency Stop	DI	--	RTU-4A	--	--	--	TRUE	--
PSH-4122	WAS Sludge Pump #2	Sludge Pumping Station #1	WAS Sludge Pump #2 Water Seal Failure	DI	--	RTU-4A	--	--	--	TRUE	--

**IO AND ALARM LIST**

<b>IO Tag No</b>	<b>Service</b>	<b>Location</b>	<b>IO Description</b>	<b>IO Type</b>	<b>IO Signal Range</b>	<b>CP Termination</b>	<b>LRL</b>	<b>URL</b>	<b>Units</b>	<b>Alarm List</b>	<b>Remarks</b>
SI-4122	WAS Sludge Pump #2	Sludge Pumping Station #1	WAS Sludge Pump #2 VFD Speed	AI	4-20 mA DC	RTU-4A	0	100	%	FALSE	--
YS-4122	WAS Sludge Pump #2	Sludge Pumping Station #1	WAS Sludge Pump #2 Start/Stop	DO	--	RTU-4A	--	--	--	FALSE	--
SC-4122	WAS Sludge Pump #2	Sludge Pumping Station #1	WAS Sludge Pump #2 VFD Speed Command	AO	4-20 mA DC	RTU-4A	30	100	%	FALSE	--
YI-4131A	Final Scum Pump #1	Sludge Pumping Station #1	Final Scum Pump #1 HOA in Auto	DI	--	RTU-4A	--	--	--	FALSE	--
YI-4131B	Final Scum Pump #1	Sludge Pumping Station #1	Final Scum Pump #1 Run Status	DI	--	RTU-4A	--	--	--	FALSE	--
TSH-4131	Final Scum Pump #1	Sludge Pumping Station #1	Final Scum Pump #1 High Motor Temp.	DI	--	RTU-4A	--	--	--	TRUE	--
YA-4131	Final Scum Pump #1	Sludge Pumping Station #1	Final Scum Pump #1 VFD Alarm	DI	--	RTU-4A	--	--	--	TRUE	--
YI-4131C	Final Scum Pump #1	Sludge Pumping Station #1	Final Scum Pump #1 Emergency Stop	DI	--	RTU-4A	--	--	--	TRUE	--
<b>PSH-4131</b>	<b>Final Scum Pump #1</b>	<b>Sludge Pumping Station #1</b>	<b>Final Scum Pump #1 Water Seal Failure</b>	<b>DI</b>	<b>--</b>	<b>RTU-4A</b>	<b>--</b>	<b>--</b>	<b>--</b>	<b>TRUE</b>	<b>--</b>
SI-4131	Final Scum Pump #1	Sludge Pumping Station #1	Final Scum Pump #1 VFD Speed	AI	4-20 mA DC	RTU-4A	0	100	%	FALSE	--
YS-4131	Final Scum Pump #1	Sludge Pumping Station #1	Final Scum Pump #1 Start/Stop	DO	--	RTU-4A	--	--	--	FALSE	--

**IO AND ALARM LIST**

IO Tag No	Service	Location	IO Description	IO Type	IO Signal Range	CP Termination	LRL	URL	Units	Alarm List	Remarks
SC-4131	Final Scum Pump #1	Sludge Pumping Station #1	Final Scum Pump #1 VFD Speed Command	AO	4-20 mA DC	RTU-4A	30	100	%	FALSE	--
LIT-4132	Final Scum Well #1 Level	Final Scum Well #1	Final Scum Well #1 Level	AI	4-20 mA DC	RTU-4A	0	20	Feet	TRUE	LAHH, LAH, LAL, LALL,
FIT-4151	WAS Sludge Flow	Pumping Station #1	WAS Sludge Flow Rate	AI	4-20 mA DC	RTU-4A	0	500	GPM	TRUE	FAHH, FAH, FAL, FALL
FIT-4161	RAS Sludge Flow	Pumping Station #1	RAS Sludge Flow Rate	AI	4-20 mA DC	RTU-4A	0	500	GPM	TRUE	FAHH, FAH, FAL, FALL
YI-4201A	Final Clarifier #3	Final Clarifier #3	Final Clarifier #3 HOA in Auto	DI	--	RTU-4B	--	--	--	FALSE	--
YI-4201B	Final Clarifier #3	Final Clarifier #3	Final Clarifier #3 Run Status	DI	--	RTU-4B	--	--	--	FALSE	--
WSH-4201	Final Clarifier #3	Final Clarifier #3	Final Clarifier #3 High Torque	DI	--	RTU-4B	--	--	--	TRUE	--
YA-4201	Final Clarifier #3	Final Clarifier #3	Final Clarifier #3 Overload	DI	--	RTU-4B	--	--	--	TRUE	--
YI-4201C	Final Clarifier #3	Final Clarifier #3	Final Clarifier #3 Emergency Stop	DI	--	RTU-4B	--	--	--	TRUE	--
YS-4201	Final Clarifier #3	Final Clarifier #3	Final Clarifier #3 Start/Stop	DO	--	RTU-4B	--	--	--	FALSE	--
YI-4202A	Final Clarifier #4	Final Clarifier #4	Final Clarifier #4 HOA in Auto	DI	--	RTU-4B	--	--	--	FALSE	--
YI-4202B	Final Clarifier #4	Final Clarifier #4	Final Clarifier #4 Run Status	DI	--	RTU-4B	--	--	--	FALSE	--
WSH-4202	Final Clarifier #4	Final Clarifier #4	Final Clarifier #4 High Torque	DI	--	RTU-4B	--	--	--	TRUE	--
YA-4202	Final Clarifier #4	Final Clarifier #4	Final Clarifier #4 Overload	DI	--	RTU-4B	--	--	--	TRUE	--
YI-4202C	Final Clarifier #4	Final Clarifier #4	Final Clarifier #4 Emergency Stop	DI	--	RTU-4B	--	--	--	TRUE	--



**IO AND ALARM LIST**

IO Tag No	Service	Location	IO Description	IO Type	IO Signal Range	CP Termination	LRL	URL	Units	Alarm List	Remarks
YS-4202	Final Clarifier #4	Final Clarifier #4	Final Clarifier #4 Start/Stop	DO	--	RTU-4B	--	--	--	FALSE	--
YI-4211A	RAS Sludge Pump #4	Sludge Pumping Station #2	RAS Sludge Pump #4 HOA in Auto	DI	--	RTU-4B	--	--	--	FALSE	--
YI-4211B	RAS Sludge Pump #4	Sludge Pumping Station #2	RAS Sludge Pump #4 Run Status	DI	--	RTU-4B	--	--	--	FALSE	--
TSH-4211	RAS Sludge Pump #4	Sludge Pumping Station #2	RAS Sludge Pump #4 High Motor Temp.	DI	--	RTU-4B	--	--	--	TRUE	--
YA-4211	RAS Sludge Pump #4	Sludge Pumping Station #2	RAS Sludge Pump #4 VFD Alarm	DI	--	RTU-4B	--	--	--	TRUE	--
YI-4211C	RAS Sludge Pump #4	Sludge Pumping Station #2	RAS Sludge Pump #4 Emergency Stop	DI	--	RTU-4B	--	--	--	TRUE	--
<b>PSH-4211</b>	<b>RAS Sludge Pump #4</b>	<b>Sludge Pumping Station #2</b>	<b>RAS Sludge Pump #4 Water Seal Failure</b>	<b>DI</b>	--	<b>RTU-4B</b>	--	--	--	<b>TRUE</b>	--
SI-4211	RAS Sludge Pump #4	Sludge Pumping Station #2	RAS Sludge Pump #4 VFD Speed	AI	4-20 mA DC	RTU-4B	0	100	%	FALSE	--
YS-4211	RAS Sludge Pump #4	Sludge Pumping Station #2	RAS Sludge Pump #4 Start/Stop	DO	--	RTU-4B	--	--	--	FALSE	--
SC-4211	RAS Sludge Pump #4	Sludge Pumping Station #2	RAS Sludge Pump #4 VFD Speed Command	AO	4-20 mA DC	RTU-4B	30	100	%	FALSE	--
YI-4212A	RAS Sludge Pump #5	Sludge Pumping Station #2	RAS Sludge Pump #5 HOA in Auto	DI	--	RTU-4B	--	--	--	FALSE	--

**IO AND ALARM LIST**

<b>IO Tag No</b>	<b>Service</b>	<b>Location</b>	<b>IO Description</b>	<b>IO Type</b>	<b>IO Signal Range</b>	<b>CP Termination</b>	<b>LRL</b>	<b>URL</b>	<b>Units</b>	<b>Alarm List</b>	<b>Remarks</b>
YI-4212B	RAS Sludge Pump #5	Sludge Pumping Station #2	RAS Sludge Pump #5 Run Status	DI	--	RTU-4B	--	--	--	FALSE	--
TSH-4212	RAS Sludge Pump #5	Sludge Pumping Station #2	RAS Sludge Pump #5 High Motor Temp.	DI	--	RTU-4B	--	--	--	TRUE	--
YA-4212	RAS Sludge Pump #5	Sludge Pumping Station #2	RAS Sludge Pump #5 VFD Alarm	DI	--	RTU-4B	--	--	--	TRUE	--
YI-4212C	RAS Sludge Pump #5	Sludge Pumping Station #2	RAS Sludge Pump #5 Emergency Stop	DI	--	RTU-4B	--	--	--	TRUE	--
<b>PSH-4212</b>	<b>RAS Sludge Pump #5</b>	<b>Sludge Pumping Station #2</b>	<b>RAS Sludge Pump #5 Water Seal Failure</b>	<b>DI</b>	<b>--</b>	<b>RTU-4B</b>	<b>--</b>	<b>--</b>	<b>--</b>	<b>TRUE</b>	<b>--</b>
SI-4212	RAS Sludge Pump #5	Sludge Pumping Station #2	RAS Sludge Pump #5 VFD Speed	AI	4-20 mA DC	RTU-4B	0	100	%	FALSE	--
YS-4212	RAS Sludge Pump #5	Sludge Pumping Station #2	RAS Sludge Pump #5 Start/Stop	DO	--	RTU-4B	--	--	--	FALSE	--
SC-4212	RAS Sludge Pump #5	Sludge Pumping Station #2	RAS Sludge Pump #5 VFD Speed Command	AO	4-20 mA DC	RTU-4B	30	100	%	FALSE	--
YI-4213A	RAS Sludge Pump #6	Sludge Pumping Station #2	RAS Sludge Pump #6 HOA in Auto	DI	--	RTU-4B	--	--	--	FALSE	--
YI-4213B	RAS Sludge Pump #6	Sludge Pumping Station #2	RAS Sludge Pump #6 Run Status	DI	--	RTU-4B	--	--	--	FALSE	--
TSH-4213	RAS Sludge Pump #6	Sludge Pumping Station #2	RAS Sludge Pump #6 High Motor Temp.	DI	--	RTU-4B	--	--	--	TRUE	--

**IO AND ALARM LIST**

IO Tag No	Service	Location	IO Description	IO Type	IO Signal Range	CP Termination	LRL	URL	Units	Alarm List	Remarks
YA-4213	RAS Sludge Pump #6	Sludge Pumping Station #2	RAS Sludge Pump #6 VFD Alarm	DI	--	RTU-4B	--	--	--	TRUE	--
YI-4213C	RAS Sludge Pump #6	Sludge Pumping Station #2	RAS Sludge Pump #6 Emergency Stop	DI	--	RTU-4B	--	--	--	TRUE	--
PSH-4213	RAS Sludge Pump #6	Sludge Pumping Station #2	RAS Sludge Pump #6 Water Seal Failure	DI	--	RTU-4B	--	--	--	TRUE	--
SI-4213	RAS Sludge Pump #6	Sludge Pumping Station #2	RAS Sludge Pump #6 VFD Speed	AI	4-20 mA DC	RTU-4B	0	100	%	FALSE	--
YS-4213	RAS Sludge Pump #6	Sludge Pumping Station #2	RAS Sludge Pump #6 Start/Stop	DO	--	RTU-4B	--	--	--	FALSE	--
SC-4213	RAS Sludge Pump #6	Sludge Pumping Station #2	RAS Sludge Pump #6 VFD Speed Command	AO	4-20 mA DC	RTU-4B	30	100	%	FALSE	--
YI-4221A	WAS Sludge Pump #3	Sludge Pumping Station #2	WAS Sludge Pump #3 HOA in Auto	DI	--	RTU-4B	--	--	--	FALSE	--
YI-4221B	WAS Sludge Pump #3	Sludge Pumping Station #2	WAS Sludge Pump #3 Run Status	DI	--	RTU-4B	--	--	--	FALSE	--
TSH-4221	WAS Sludge Pump #3	Sludge Pumping Station #2	WAS Sludge Pump #3 High Motor Temp.	DI	--	RTU-4B	--	--	--	TRUE	--
YA-4221	WAS Sludge Pump #3	Sludge Pumping Station #2	WAS Sludge Pump #3 VFD Alarm	DI	--	RTU-4B	--	--	--	TRUE	--
YI-4221C	WAS Sludge Pump #3	Sludge Pumping Station #2	WAS Sludge Pump #3 Emergency Stop	DI	--	RTU-4B	--	--	--	TRUE	--

**IO AND ALARM LIST**

IO Tag No	Service	Location	IO Description	IO Type	IO Signal Range	CP Termination	LRL	URL	Units	Alarm List	Remarks
PSH-4221	WAS Sludge Pump #3	Sludge Pumping Station #2	WAS Sludge Pump #3 Water Seal Failure	DI	--	RTU-4B	--	--	--	TRUE	--
SI-4221	WAS Sludge Pump #3	Sludge Pumping Station #2	WAS Sludge Pump #3 VFD Speed	AI	4-20 mA DC	RTU-4B	0	100	%	FALSE	--
YS-4221	WAS Sludge Pump #3	Sludge Pumping Station #2	WAS Sludge Pump #3 Start/Stop	DO	--	RTU-4B	--	--	--	FALSE	--
SC-4221	WAS Sludge Pump #3	Sludge Pumping Station #2	WAS Sludge Pump #3 VFD Speed Command	AO	4-20 mA DC	RTU-4B	30	100	%	FALSE	--
YI-4222A	WAS Sludge Pump #4	Sludge Pumping Station #2	WAS Sludge Pump #4 HOA in Auto	DI	--	RTU-4B	--	--	--	FALSE	--
YI-4222B	WAS Sludge Pump #4	Sludge Pumping Station #2	WAS Sludge Pump #4 Run Status	DI	--	RTU-4B	--	--	--	FALSE	--
TSH-4222	WAS Sludge Pump #4	Sludge Pumping Station #2	WAS Sludge Pump #4 High Motor Temp.	DI	--	RTU-4B	--	--	--	TRUE	--
YA-4222	WAS Sludge Pump #4	Sludge Pumping Station #2	WAS Sludge Pump #4 VFD Alarm	DI	--	RTU-4B	--	--	--	TRUE	--
YI-4222C	WAS Sludge Pump #4	Sludge Pumping Station #2	WAS Sludge Pump #4 Emergency Stop	DI	--	RTU-4B	--	--	--	TRUE	--
PSH-4222	WAS Sludge Pump #4	Sludge Pumping Station #2	WAS Sludge Pump #4 Water Seal Failure	DI	--	RTU-4B	--	--	--	TRUE	--
SI-4222	WAS Sludge Pump #4	Sludge Pumping Station #2	WAS Sludge Pump #4 VFD Speed	AI	4-20 mA DC	RTU-4B	0	100	%	FALSE	--

**IO AND ALARM LIST**

IO Tag No	Service	Location	IO Description	IO Type	IO Signal Range	CP Termination	LRL	URL	Units	Alarm List	Remarks
YS-4222	WAS Sludge Pump #4	Sludge Pumping Station #2	WAS Sludge Pump #4 Start/Stop	DO	--	RTU-4B	--	--	--	FALSE	--
SC-4222	WAS Sludge Pump #4	Sludge Pumping Station #2	WAS Sludge Pump #4 VFD Speed Command	AO	4-20 mA DC	RTU-4B	30	100	%	FALSE	--
YI-4231A	Final Scum Pump #2	Sludge Pumping Station #2	Final Scum Pump #2 HOA in Auto	DI	--	RTU-4B	--	--	--	FALSE	--
YI-4231B	Final Scum Pump #2	Sludge Pumping Station #2	Final Scum Pump #2 Run Status	DI	--	RTU-4B	--	--	--	FALSE	--
TSH-4231	Final Scum Pump #2	Sludge Pumping Station #2	Final Scum Pump #2 High Motor Temp.	DI	--	RTU-4B	--	--	--	TRUE	--
YA-4231	Final Scum Pump #2	Sludge Pumping Station #2	Final Scum Pump #2 VFD Alarm	DI	--	RTU-4B	--	--	--	TRUE	--
YI-4231C	Final Scum Pump #2	Sludge Pumping Station #2	Final Scum Pump #2 Emergency Stop	DI	--	RTU-4B	--	--	--	TRUE	--
PSH-4231	Final Scum Pump #2	Sludge Pumping Station #2	Final Scum Pump #2 Water Seal Failure	DI	--	RTU-4B	--	--	--	TRUE	--
SI-4231	Final Scum Pump #2	Sludge Pumping Station #2	Final Scum Pump #2 VFD Speed	AI	4-20 mA DC	RTU-4B	0	100	%	FALSE	--
YS-4231	Final Scum Pump #2	Sludge Pumping Station #2	Final Scum Pump #2 Start/Stop	DO	--	RTU-4B	--	--	--	FALSE	--
SC-4231	Final Scum Pump #2	Sludge Pumping Station #2	Final Scum Pump #2 VFD Speed Command	AO	4-20 mA DC	RTU-4B	30	100	%	FALSE	--

**IO AND ALARM LIST**

<b>IO Tag No</b>	<b>Service</b>	<b>Location</b>	<b>IO Description</b>	<b>IO Type</b>	<b>IO Signal Range</b>	<b>CP Termination</b>	<b>LRL</b>	<b>URL</b>	<b>Units</b>	<b>Alarm List</b>	<b>Remarks</b>
LIT-4232	Final Scum Well #2 Level	Final Scum Well #2	Final Scum Well #2 Level	AI	4-20 mA DC	RTU-4B	0	20	Feet	TRUE	LAHH, LAH, LAL, LALL,
FIT-4251	WAS Sludge Flow	Pumping Station #2	WAS Sludge Flow Rate	AI	4-20 mA DC	RTU-4B	0	500	GPM	TRUE	FAHH, FAH, FAL, FALL
FIT-4261	RAS Sludge Flow	Pumping Station #2	RAS Sludge Flow Rate	AI	4-20 mA DC	RTU-4B	0	500	GPM	TRUE	FAHH, FAH, FAL, FALL
LIT-5101	Sodium Hypochlorite Tank Level	Chemical Building	Sodium Hypochlorite Tank Level	AI	4-20 mA DC	RTU-5	0	20	Feet	TRUE	LAHH, LAH, LAL, LALL,
LSH-5102	Sodium Hypochlorite Tank	Chemical Building	Sodium Hypochlorite Tank Leak	DI		RTU-5	--	--	--	TRUE	--
YI-5201	Sodium Hypochlorite Pump #1	Chemical Building	Sodium Hypochlorite Pump #1 Run Status	DI	--	RTU-5	--	--	--	FALSE	--
YA-5201	Sodium Hypochlorite Pump #1	Chemical Building	Sodium Hypochlorite Pump #1 Alarm	DI	--	RTU-5	--	--	--	FALSE	--
YS-5201	Sodium Hypochlorite Pump #1	Chemical Building	Sodium Hypochlorite Pump #1 Start/Stop	DO	--	RTU-5	--	--	--	FALSE	--
SI-5201	Sodium Hypochlorite Pump #1	Chemical Building	Sodium Hypochlorite Pump #1 Pump Speed Feedback	AI	4-20 mA DC	RTU-5	0	100	%	FALSE	--
SC-5201	Sodium Hypochlorite Pump #1	Chemical Building	Sodium Hypochlorite Pump #1 Pump Speed Command	AO	4-20 mA DC	RTU-5	0	100	%	FALSE	--
YI-5202	Sodium Hypochlorite Pump #2	Chemical Building	Sodium Hypochlorite Pump #2 Run Status	DI	--	RTU-5	--	--	--	FALSE	--

**IO AND ALARM LIST**

<b>IO Tag No</b>	<b>Service</b>	<b>Location</b>	<b>IO Description</b>	<b>IO Type</b>	<b>IO Signal Range</b>	<b>CP Termination</b>	<b>LRL</b>	<b>URL</b>	<b>Units</b>	<b>Alarm List</b>	<b>Remarks</b>
YA-5202	Sodium Hypochlorite Pump #2	Chemical Building	Sodium Hypochlorite Pump #2 Alarm	DI	--	RTU-5	--	--	--	FALSE	--
YS-5202	Sodium Hypochlorite Pump #2	Chemical Building	Sodium Hypochlorite Pump #2 Start/Stop	DO	--	RTU-5	--	--	--	FALSE	--
SI-5202	Sodium Hypochlorite Pump #2	Chemical Building	Sodium Hypochlorite Pump #2 Pump Speed Feedback	AI	4-20 mA DC	RTU-5	0	100	%	FALSE	--
SC-5202	Sodium Hypochlorite Pump #2	Chemical Building	Sodium Hypochlorite Pump #2 Pump Speed Command	AO	4-20 mA DC	RTU-5	0	100	%	FALSE	--
YI-5203	Sodium Hypochlorite Pump #3	Chemical Building	Sodium Hypochlorite Pump #3 Run Status	DI	--	RTU-5	--	--	--	FALSE	--
YA-5203	Sodium Hypochlorite Pump #3	Chemical Building	Sodium Hypochlorite Pump #3 Alarm	DI	--	RTU-5	--	--	--	FALSE	--
YS-5203	Sodium Hypochlorite Pump #3	Chemical Building	Sodium Hypochlorite Pump #3 Start/Stop	DO	--	RTU-5	--	--	--	FALSE	--
SI-5203	Sodium Hypochlorite Pump #3	Chemical Building	Sodium Hypochlorite Pump #3 Pump Speed Feedback	AI	4-20 mA DC	RTU-5	0	100	%	FALSE	--
SC-5203	Sodium Hypochlorite Pump #3	Chemical Building	Sodium Hypochlorite Pump #3 Pump Speed Command	AO	4-20 mA DC	RTU-5	0	100	%	FALSE	--

**IO AND ALARM LIST**

IO Tag No	Service	Location	IO Description	IO Type	IO Signal Range	CP Termination	LRL	URL	Units	Alarm List	Remarks
LIT-5301	Sodium Bisulfite Tank Level	Chemical Building	Sodium Bisulfite Tank Level	AI	4-20 mA DC	RTU-5	0	20	Feet	TRUE	LAHH, LAH, LAL, LALL,
LSH-5302	Sodium Bisulfite Tank	Chemical Building	Sodium Bisulfite Tank Leak	DI		RTU-5	--	--	--	TRUE	--
YI-5401	Sodium Bisulfite Pump #1	Chemical Building	Sodium Bisulfite Pump #1 Run Status	DI	--	RTU-5	--	--	--	FALSE	--
YA-5401	Sodium Bisulfite Pump #1	Chemical Building	Sodium Bisulfite Pump #1 Alarm	DI	--	RTU-5	--	--	--	FALSE	--
YS-5401	Sodium Bisulfite Pump #1	Chemical Building	Sodium Bisulfite Pump #1 Start/Stop	DO	--	RTU-5	--	--	--	FALSE	--
SI-5401	Sodium Bisulfite Pump #1	Chemical Building	Sodium Bisulfite Pump #1 Pump Speed Feedback	AI	4-20 mA DC	RTU-5	0	100	%	FALSE	--
SC-5401	Sodium Bisulfite Pump #1	Chemical Building	Sodium Bisulfite Pump #1 Pump Speed Command	AO	4-20 mA DC	RTU-5	0	100	%	FALSE	--
YI-5402	Sodium Bisulfite Pump #2	Chemical Building	Sodium Bisulfite Pump #2 Run Status	DI	--	RTU-5	--	--	--	FALSE	--
YA-5402	Sodium Bisulfite Pump #2	Chemical Building	Sodium Bisulfite Pump #2 Alarm	DI	--	RTU-5	--	--	--	FALSE	--



**IO AND ALARM LIST**

<b>IO Tag No</b>	<b>Service</b>	<b>Location</b>	<b>IO Description</b>	<b>IO Type</b>	<b>IO Signal Range</b>	<b>CP Termination</b>	<b>LRL</b>	<b>URL</b>	<b>Units</b>	<b>Alarm List</b>	<b>Remarks</b>
YS-5402	Sodium Bisulfite Pump #2	Chemical Building	Sodium Bisulfite Pump #2 Start/Stop	DO	--	RTU-5	--	--	--	FALSE	--
SI-5402	Sodium Bisulfite Pump #2	Chemical Building	Sodium Bisulfite Pump #2 Pump Speed Feedback	AI	4-20 mA DC	RTU-5	0	100	%	FALSE	--
SC-5402	Sodium Bisulfite Pump #2	Chemical Building	Sodium Bisulfite Pump #2 Pump Speed Command	AO	4-20 mA DC	RTU-5	0	100	%	FALSE	--
YI-5501A	Chlorine Mixer	Chlorine Contact Tank Manhole	Chlorine Mixer HOA in Auto	DI	--	RTU-5	--	--	--	FALSE	--
YI-5501B	Chlorine Mixer	Chlorine Contact Tank Manhole	Chlorine Mixer Run Status	DI	--	RTU-5	--	--	--	FALSE	--
YA-5501	Chlorine Mixer	Chlorine Contact Tank Manhole	Chlorine Mixer Alarm	DI	--	RTU-5	--	--	--	TRUE	--
YS-5501	Chlorine Mixer	Chlorine Contact Tank Manhole	Chlorine Mixer Start/Stop	DO	--	RTU-5	--	--	--	FALSE	--
FIT-5502	Plant Effluent Flow	Chlorine Contact Tank	Plant Effluent Flow Rate	AI	4-20 mA DC	RTU-5	0	1000	GPM	TRUE	FAHH, FAH, FAL, FALL
FIT-5503	Plant Effluent Flow	Chlorine Contact Tank	Plant Effluent Flow Rate	AI	4-20 mA DC	RTU-5	0	1000	GPM	TRUE	FAHH, FAH, FAL, FALL
AIT-5504	Plant Effluent Chlorine Level	Chlorine Contact Tank	Plant Effluent Chlorine Level	AI	4-20 mA DC	RTU-5	0.05	5.00	ppm	TRUE	AAHH, AAH, AAL, AALL
AIT-5505	Pre-Chlorine Contact Chamber Chlorine level	Pre-Chlorine Contact Chamber	Pre-Chlorine Contact Chamber	AI	4-20 mA DC	RTU-5	0.05	5.00	ppm	TRUE	AAHH, AAH, AAL, AALL
YI-7101A	Gravity Thickener #1	Gravity Thickener #1	Gravity Thickener #1 HOA in Auto	DI	--	RTU-7	--	--	--	FALSE	--
YI-7101B	Gravity Thickener #1	Gravity Thickener #1	Gravity Thickener #1 Run Status	DI	--	RTU-7	--	--	--	FALSE	--

**IO AND ALARM LIST**

<b>IO Tag No</b>	<b>Service</b>	<b>Location</b>	<b>IO Description</b>	<b>IO Type</b>	<b>IO Signal Range</b>	<b>CP Termination</b>	<b>LRL</b>	<b>URL</b>	<b>Units</b>	<b>Alarm List</b>	<b>Remarks</b>
WSH-7101	Gravity Thickener #1	Gravity Thickener #1	Gravity Thickener #1 High Torque	DI	--	RTU-7	--	--	--	TRUE	--
YA-7101	Gravity Thickener #1	Gravity Thickener #1	Gravity Thickener #1 Overload	DI	--	RTU-7	--	--	--	TRUE	--
YI-7101C	Gravity Thickener #1	Gravity Thickener #1	Gravity Thickener #1 Emergency Stop	DI	--	RTU-7	--	--	--	TRUE	--
YS-7101	Gravity Thickener #1	Gravity Thickener #1	Gravity Thickener #1 Start/Stop	DO	--	RTU-7	--	--	--	FALSE	--
YI-7102A	Gravity Thickener #2	Gravity Thickener #2	Gravity Thickener #2 HOA in Auto	DI	--	RTU-7	--	--	--	FALSE	--
YI-7102B	Gravity Thickener #2	Gravity Thickener #2	Gravity Thickener #2 Run Status	DI	--	RTU-7	--	--	--	FALSE	--
WSH-7102	Gravity Thickener #2	Gravity Thickener #2	Gravity Thickener #2 High Torque	DI	--	RTU-7	--	--	--	TRUE	--
YA-7102	Gravity Thickener #2	Gravity Thickener #2	Gravity Thickener #2 Overload	DI	--	RTU-7	--	--	--	TRUE	--
YI-7102C	Gravity Thickener #2	Gravity Thickener #2	Gravity Thickener #2 Emergency Stop	DI	--	RTU-7	--	--	--	TRUE	--
YS-7102	Gravity Thickener #2	Gravity Thickener #2	Gravity Thickener #2 Start/Stop	DO	--	RTU-7	--	--	--	FALSE	--
YI-7201A	Thickened Sludge Pump #1	Solids Handling Building	Thickened Sludge Pump #1 HOA in Auto	DI	--	RTU-7	--	--	--	FALSE	--

**IO AND ALARM LIST**

<b>IO Tag No</b>	<b>Service</b>	<b>Location</b>	<b>IO Description</b>	<b>IO Type</b>	<b>IO Signal Range</b>	<b>CP Termination</b>	<b>LRL</b>	<b>URL</b>	<b>Units</b>	<b>Alarm List</b>	<b>Remarks</b>
YI-7201B	Thickened Sludge Pump #1	Solids Handling Building	Thickened Sludge Pump #1 Run Status	DI	--	RTU-7	--	--	--	FALSE	--
TSH-7201	Thickened Sludge Pump #1	Solids Handling Building	Thickened Sludge Pump #1 High Motor Temp.	DI	--	RTU-7	--	--	--	TRUE	--
PSH-7201	Thickened Sludge Pump #1	Solids Handling Building	Thickened Sludge Pump #1 Discharge Press. High	DI	--	RTU-7	--	--	--	TRUE	--
YA-7201	Thickened Sludge Pump #1	Solids Handling Building	Thickened Sludge Pump #1 VFD Alarm	DI	--	RTU-7	--	--	--	TRUE	--
YI-7201C	Thickened Sludge Pump #1	Solids Handling Building	Thickened Sludge Pump #1 Emergency Stop	DI	--	RTU-7	--	--	--	TRUE	--
SI-7201	Thickened Sludge Pump #1	Solids Handling Building	Thickened Sludge Pump #1 VFD Speed	AI	4-20 mA DC	RTU-7	0	100	%	FALSE	--
YS-7201	Thickened Sludge Pump #1	Solids Handling Building	Thickened Sludge Pump #1 Start/Stop	DO	--	RTU-7	--	--	--	FALSE	--
SC-7201	Thickened Sludge Pump #1	Solids Handling Building	Thickened Sludge Pump #1 VFD Speed Command	AO	4-20 mA DC	RTU-7	30	100	%	FALSE	--
YI-7202A	Thickened Sludge Pump #2	Solids Handling Building	Thickened Sludge Pump #2 HOA in Auto	DI	--	RTU-7	--	--	--	FALSE	--
YI-7202B	Thickened Sludge Pump #2	Solids Handling Building	Thickened Sludge Pump #2 Run Status	DI	--	RTU-7	--	--	--	FALSE	--

**IO AND ALARM LIST**

<b>IO Tag No</b>	<b>Service</b>	<b>Location</b>	<b>IO Description</b>	<b>IO Type</b>	<b>IO Signal Range</b>	<b>CP Termination</b>	<b>LRL</b>	<b>URL</b>	<b>Units</b>	<b>Alarm List</b>	<b>Remarks</b>
TSH-7202	Thickened Sludge Pump #2	Solids Handling Building	Thickened Sludge Pump #2 High Motor Temp.	DI	--	RTU-7	--	--	--	TRUE	--
PSH-7202	Thickened Sludge Pump #2	Solids Handling Building	Thickened Sludge Pump #2 Discharge Press. High	DI	--	RTU-7	--	--	--	TRUE	--
YA-7202	Thickened Sludge Pump #2	Solids Handling Building	Thickened Sludge Pump #2 VFD Alarm	DI	--	RTU-7	--	--	--	TRUE	--
YI-7202C	Thickened Sludge Pump #2	Solids Handling Building	Thickened Sludge Pump #2 Emergency Stop	DI	--	RTU-7	--	--	--	TRUE	--
SI-7202	Thickened Sludge Pump #2	Solids Handling Building	Thickened Sludge Pump #2 VFD Speed	AI	4-20 mA DC	RTU-7	0	100	%	FALSE	--
YS-7202	Thickened Sludge Pump #2	Solids Handling Building	Thickened Sludge Pump #2 Start/Stop	DO	--	RTU-7	--	--	--	FALSE	--
SC-7202	Thickened Sludge Pump #2	Solids Handling Building	Thickened Sludge Pump #2 VFD Speed Command	AO	4-20 mA DC	RTU-7	30	100	%	FALSE	--
FIT-7203	Thickened Sludge Pump #1 Flow	Solids Handling Building	Thickened Sludge Pump #1 Flow Rate	AI	4-20 mA DC	RTU-7	0	500	GPM	TRUE	FAHH, FAH, FAL, FALL
FIT-7204	Thickened Sludge Pump #2 Flow	Solids Handling Building	Thickened Sludge Pump #2 Flow Rate	AI	4-20 mA DC	RTU-7	0	500	GPM	TRUE	FAHH, FAH, FAL, FALL
YI-7205A	Thickened Sludge Grinder #1	Solids Handling Building	Thickened Sludge Grinder #1 HOA in Auto	DI	--	RTU-7	--	--	--	FALSE	--

**IO AND ALARM LIST**

<b>IO Tag No</b>	<b>Service</b>	<b>Location</b>	<b>IO Description</b>	<b>IO Type</b>	<b>IO Signal Range</b>	<b>CP Termination</b>	<b>LRL</b>	<b>URL</b>	<b>Units</b>	<b>Alarm List</b>	<b>Remarks</b>
YI-7205B	Thickened Sludge Grinder #1	Solids Handling Building	Thickened Sludge Grinder #1 Run Status	DI	--	RTU-7	--	--	--	FALSE	--
YA-7205	Thickened Sludge Grinder #1	Solids Handling Building	Thickened Sludge Grinder #1 Alarm	DI	--	RTU-7	--	--	--	TRUE	--
YI-7206A	Thickened Sludge Grinder #2	Solids Handling Building	Thickened Sludge Grinder #2 HOA in Auto	DI	--	RTU-7	--	--	--	FALSE	--
YI-7206B	Thickened Sludge Grinder #2	Solids Handling Building	Thickened Sludge Grinder #2 Run Status	DI	--	RTU-7	--	--	--	FALSE	--
YA-7206	Thickened Sludge Grinder #2	Solids Handling Building	Thickened Sludge Grinder #2 Alarm	DI	--	RTU-7	--	--	--	TRUE	--
YI-7303A	Screw Conveyor	Solids Handling Building	Screw Conveyor HOA in Auto	DI	--	RTU-7	--	--	--	FALSE	--
YI-7303B	Screw Conveyor	Solids Handling Building	Screw Conveyor Run Status	DI	--	RTU-7	--	--	--	FALSE	--
YA-7303	Screw Conveyor	Solids Handling Building	Screw Conveyor Alarm	DI	--	RTU-7	--	--	--	TRUE	--
YI-7305A	Leveler Screw Conveyor	Solids Handling Building	Leveler Screw Conveyor HOA in Auto	DI	--	RTU-7	--	--	--	FALSE	--
YI-7305B	Leveler Screw Conveyor	Solids Handling Building	Leveler Screw Conveyor Run Status	DI	--	RTU-7	--	--	--	FALSE	--
YA-7305	Leveler Screw Conveyor	Solids Handling Building	Leveler Screw Conveyor Alarm	DI	--	RTU-7	--	--	--	TRUE	--
YI-7401B	Scum Concentrator	Solids Handling Building	Scum Concentrator Run Status	DI	--	RTU-7	--	--	--	FALSE	--
YA-7401	Scum Concentrator	Solids Handling Building	Scum Concentrator Alarm	DI	--	RTU-7	--	--	--	TRUE	--

**IO AND ALARM LIST**

<b>IO Tag No</b>	<b>Service</b>	<b>Location</b>	<b>IO Description</b>	<b>IO Type</b>	<b>IO Signal Range</b>	<b>CP Termination</b>	<b>LRL</b>	<b>URL</b>	<b>Units</b>	<b>Alarm List</b>	<b>Remarks</b>
YI-7402A	Scum Macerator	Solids Handling Building	Scum Macerator HOA in Auto	DI	--	RTU-7	--	--	--	FALSE	--
YI-7402B	Scum Macerator	Solids Handling Building	Scum Macerator Run Status	DI	--	RTU-7	--	--	--	FALSE	--
YA-7402	Scum Macerator	Solids Handling Building	Scum Macerator Alarm	DI	--	RTU-7	--	--	--	TRUE	--
YS-7402	Scum Macerator	Solids Handling Building	Scum Macerator Start/Stop	DO	--	RTU-7	--	--	--	FALSE	--
YI-7500A	Polymer Level Control Panel	Solids Handling Building	Polymer Level Control Panel HOA in Auto	DI	--	RTU-7	--	--	--	FALSE	--
YI-7500B	Polymer Level Control Panel	Solids Handling Building	Polymer Level Control Panel Run Status	DI	--	RTU-7	--	--	--	FALSE	--
YA-7500	Polymer Level Control Panel	Solids Handling Building	Polymer Level Control Panel Alarm	DI	--	RTU-7	--	--	--	TRUE	--
YS-7500	Polymer Level Control Panel	Solids Handling Building	Polymer Level Control Panel Start/Stop	DO	--	RTU-7	--	--	--	FALSE	--
YI-7601A	Polymer Feed Pump #1	Solids Handling Building	Polymer Feed Pump #1 HOA in Auto	DI	--	RTU-7	--	--	--	FALSE	--
YI-7601B	Polymer Feed Pump #1	Solids Handling Building	Polymer Feed Pump #1 Run Status	DI	--	RTU-7	--	--	--	FALSE	--
YA-7601	Polymer Feed Pump #1	Solids Handling Building	Polymer Feed Pump #1 VFD Alarm	DI	--	RTU-7	--	--	--	TRUE	--
YI-7601C	Polymer Feed Pump #1	Solids Handling Building	Polymer Feed Pump #1 Emergency Stop	DI	--	RTU-7	--	--	--	TRUE	--
SI-7601	Polymer Feed Pump #1	Solids Handling Building	Polymer Feed Pump #1 VFD Speed	AI	4-20 mA DC	RTU-7	0	100	%	FALSE	--

**IO AND ALARM LIST**

IO Tag No	Service	Location	IO Description	IO Type	IO Signal Range	CP Termination	LRL	URL	Units	Alarm List	Remarks
YS-7601	Polymer Feed Pump #1	Solids Handling Building	Polymer Feed Pump #1 Start/Stop	DO	--	RTU-7	--	--	--	FALSE	--
SC-7601	Polymer Feed Pump #1	Solids Handling Building	Polymer Feed Pump #1 VFD Speed Command	AO	4-20 mA DC	RTU-7	30	100	%	FALSE	--
YI-7602A	Polymer Feed Pump #2	Solids Handling Building	Polymer Feed Pump #2 HOA in Auto	DI	--	RTU-7	--	--	--	FALSE	--
YI-7602B	Polymer Feed Pump #2	Solids Handling Building	Polymer Feed Pump #2 Run Status	DI	--	RTU-7	--	--	--	FALSE	--
YA-7602	Polymer Feed Pump #2	Solids Handling Building	Polymer Feed Pump #2 VFD Alarm	DI	--	RTU-7	--	--	--	TRUE	--
YI-7602C	Polymer Feed Pump #2	Solids Handling Building	Polymer Feed Pump #2 Emergency Stop	DI	--	RTU-7	--	--	--	TRUE	--
SI-7602	Polymer Feed Pump #2	Solids Handling Building	Polymer Feed Pump #2 VFD Speed	AI	4-20 mA DC	RTU-7	0	100	%	FALSE	--
YS-7602	Polymer Feed Pump #2	Solids Handling Building	Polymer Feed Pump #2 Start/Stop	DO	--	RTU-7	--	--	--	FALSE	--
SC-7602	Polymer Feed Pump #2	Solids Handling Building	Polymer Feed Pump #2 VFD Speed Command	AO	4-20 mA DC	RTU-7	30	100	%	FALSE	--
FIT-7603	Polymer Feed Pump #1 Flow	Solids Handling Building	Polymer Feed Pump #1 Flow Rate	AI	4-20 mA DC	RTU-7	0	100	GPM	TRUE	FAHH, FAH, FAL, FALL
FIT-7604	Polymer Feed Pump #2 Flow	Solids Handling Building	Polymer Feed Pump #2 Flow Rate	AI	4-20 mA DC	RTU-7	0	100	GPM	TRUE	FAHH, FAH, FAL, FALL

**IO AND ALARM LIST**

<b>IO Tag No</b>	<b>Service</b>	<b>Location</b>	<b>IO Description</b>	<b>IO Type</b>	<b>IO Signal Range</b>	<b>CP Termination</b>	<b>LRL</b>	<b>URL</b>	<b>Units</b>	<b>Alarm List</b>	<b>Remarks</b>
LSH-7605	Polymer Tank	Solids Handling Building	Polymer Tank Leak	DI		RTU-7	--	--	--	TRUE	--
YI-8101A	Headworks Odor Control Blower	Solids Handling Building	Headworks Odor Control Blower HOA in Auto	DI	--	RTU-7	--	--	--	FALSE	--
YI-8101B	Headworks Odor Control Blower	Solids Handling Building	Headworks Odor Control Blower Run Status	DI	--	RTU-7	--	--	--	FALSE	--
TSH-8101	Headworks Odor Control Blower	Solids Handling Building	Headworks Odor Control Blower High Motor Temp.	DI	--	RTU-7	--	--	--	TRUE	--
YA-8101	Headworks Odor Control Blower	Solids Handling Building	Headworks Odor Control Blower VFD Alarm	DI	--	RTU-7	--	--	--	TRUE	--
YI-8101C	Headworks Odor Control Blower	Solids Handling Building	Headworks Odor Control Blower Emergency Stop	DI	--	RTU-7	--	--	--	TRUE	--
SI-8101	Headworks Odor Control Blower	Solids Handling Building	Headworks Odor Control Blower VFD Speed	AI	4-20 mA DC	RTU-7	0	100	%	FALSE	--
YS-8101	Headworks Odor Control Blower	Solids Handling Building	Headworks Odor Control Blower Start/Stop	DO	--	RTU-7	--	--	--	FALSE	--
SC-8101	Headworks Odor Control Blower	Solids Handling Building	Headworks Odor Control Blower VFD Speed Command	AO	4-20 mA DC	RTU-7	30	100	%	FALSE	--



**IO AND ALARM LIST**

<b>IO Tag No</b>	<b>Service</b>	<b>Location</b>	<b>IO Description</b>	<b>IO Type</b>	<b>IO Signal Range</b>	<b>CP Termination</b>	<b>LRL</b>	<b>URL</b>	<b>Units</b>	<b>Alarm List</b>	<b>Remarks</b>
YI-8102A	Gravity Thickeners Odor Control Blower	Solids Handling Building	Gravity Thickeners Odor Control Blower HOA in Auto	DI	--	RTU-7	--	--	--	FALSE	--
YI-8102B	Gravity Thickeners Odor Control Blower	Solids Handling Building	Gravity Thickeners Odor Control Blower Run Status	DI	--	RTU-7	--	--	--	FALSE	--
TSH-8102	Gravity Thickeners Odor Control Blower	Solids Handling Building	Gravity Thickeners Odor Control Blower High Motor Temp.	DI	--	RTU-7	--	--	--	TRUE	--
YA-8102	Gravity Thickeners Odor Control Blower	Solids Handling Building	Gravity Thickeners Odor Control Blower VFD Alarm	DI	--	RTU-7	--	--	--	TRUE	--
YI-8102C	Gravity Thickeners Odor Control Blower	Solids Handling Building	Gravity Thickeners Odor Control Blower Emergency Stop	DI	--	RTU-7	--	--	--	TRUE	--
SI-8102	Gravity Thickeners Odor Control Blower	Solids Handling Building	Gravity Thickeners Odor Control Blower VFD Speed	AI	4-20 mA DC	RTU-7	0	100	%	FALSE	--
YS-8102	Gravity Thickeners Odor Control Blower	Solids Handling Building	Gravity Thickeners Odor Control Blower Start/Stop	DO	--	RTU-7	--	--	--	FALSE	--
SC-8102	Gravity Thickeners Odor Control Blower	Solids Handling Building	Gravity Thickeners Odor Control Blower VFD Speed Command	AO	4-20 mA DC	RTU-7	30	100	%	FALSE	--

**IO AND ALARM LIST**

<b>IO Tag No</b>	<b>Service</b>	<b>Location</b>	<b>IO Description</b>	<b>IO Type</b>	<b>IO Signal Range</b>	<b>CP Termination</b>	<b>LRL</b>	<b>URL</b>	<b>Units</b>	<b>Alarm List</b>	<b>Remarks</b>
YI-8103A	Solids Handling Odor Control Blower	Solids Handling Building	Solids Handling Odor Control Blower HOA in Auto	DI	--	RTU-7	--	--	--	FALSE	--
YI-8103B	Solids Handling Odor Control Blower	Solids Handling Building	Solids Handling Odor Control Blower Run Status	DI	--	RTU-7	--	--	--	FALSE	--
TSH-8103	Solids Handling Odor Control Blower	Solids Handling Building	Solids Handling Odor Control Blower High Motor Temp.	DI	--	RTU-7	--	--	--	TRUE	--
YA-8103	Solids Handling Odor Control Blower	Solids Handling Building	Solids Handling Odor Control Blower VFD Alarm	DI	--	RTU-7	--	--	--	TRUE	--
YI-8103C	Solids Handling Odor Control Blower	Solids Handling Building	Solids Handling Odor Control Blower Emergency Stop	DI	--	RTU-7	--	--	--	TRUE	--
SI-8103	Solids Handling Odor Control Blower	Solids Handling Building	Solids Handling Odor Control Blower VFD Speed	AI	4-20 mA DC	RTU-7	0	100	%	FALSE	--
YS-8103	Solids Handling Odor Control Blower	Solids Handling Building	Solids Handling Odor Control Blower Start/Stop	DO	--	RTU-7	--	--	--	FALSE	--
SC-8103	Solids Handling Odor Control Blower	Solids Handling Building	Solids Handling Odor Control Blower VFD Speed Command	AO	4-20 mA DC	RTU-7	30	100	%	FALSE	--

**IO AND ALARM LIST**

IO Tag No	Service	Location	IO Description	IO Type	IO Signal Range	CP Termination	LRL	URL	Units	Alarm List	Remarks
ZSO-8110	Solids Handling Building Solids Bay Door	Solids Handling Building	Solids Handling Solids Bay Door Open	DI	--	RTU-7	--	--	--	TRUE	--
FIT-9115	Plant Water to WAS	Solids Handling Building	Plant Water to WAS Flow Rate	AI	4-20 mA DC	RTU-72	0	100	GPM	TRUE	FAHH, FAH, FAL, FALL
XC-9116	Plant Water to WAS Flow Control Valve	Solids Handling Building	Plant Water to WAS Flow Control Valve	AO	4-20 mA DC	RTU-72	0	100	%	FALSE	--
YI-9201A	Sanitary Waste Pump #1	Chemical Building	Sanitary Waste Pump #1 HOA in Auto	DI	--	RTU-5	--	--	--	FALSE	--
YI-9201B	Sanitary Waste Pump #1	Chemical Building	Sanitary Waste Pump #1 Run Status	DI	--	RTU-5	--	--	--	FALSE	--
YA-9201	Sanitary Waste Pump #1	Chemical Building	Sanitary Waste Pump #1 Overload	DI	--	RTU-5	--	--	--	TRUE	--
YS-9201	Sanitary Waste Pump #1	Chemical Building	Sanitary Waste Pump #1 Start/Stop	DO	--	RTU-5	--	--	--	FALSE	--
YI-9202A	Sanitary Waste Pump #2	Chemical Building	Sanitary Waste Pump #2 HOA in Auto	DI	--	RTU-5	--	--	--	FALSE	--
YI-9202B	Sanitary Waste Pump #2	Chemical Building	Sanitary Waste Pump #2 Run Status	DI	--	RTU-5	--	--	--	FALSE	--
YA-9202	Sanitary Waste Pump #2	Chemical Building	Sanitary Waste Pump #2 Overload	DI	--	RTU-5	--	--	--	TRUE	--
YS-9202	Sanitary Waste Pump #2	Chemical Building	Sanitary Waste Pump #2 Start/Stop	DO	--	RTU-5	--	--	--	FALSE	--
LIT-9203	Sanitary Waste Well Level	Sanitary Waste Well	Sanitary Waste Well Level	AI	4-20 mA DC	RTU-5	0	20	Feet	TRUE	LAHH, LAH, LAL, LALL

**IO AND ALARM LIST**

<b>IO Tag No</b>	<b>Service</b>	<b>Location</b>	<b>IO Description</b>	<b>IO Type</b>	<b>IO Signal Range</b>	<b>CP Termination</b>	<b>LRL</b>	<b>URL</b>	<b>Units</b>	<b>Alarm List</b>	<b>Remarks</b>
FSH-9301	Sodium Hypochlorite Eyewash/Shower	Chemical Building	Eyewash Shower Activated	DI		RTU-5	--	--	--	TRUE	--
FSH-9302	Sodium Bisulfite Eyewash/Shower	Chemical Building	Eyewash Shower Activated	DI		RTU-5	--	--	--	TRUE	--
FSH-9303	Polymer Eyewash/Shower	Solids Handling Building	Eyewash Shower Activated	DI		RTU-7	--	--	--	TRUE	--
YI-9320A	Automatic Transfer Switch	Blower Building	ATS in Normal Position	DI	--	RTU-3	--	--	--	FALSE	--
YI-9320B	Automatic Transfer Switch	Blower Building	ATS in Emergency Position	DI	--	RTU-3	--	--	--	FALSE	--
YA-9301	Automatic Transfer Switch	Blower Building	Utility Power Loss	DI	--	RTU-3	--	--	--	TRUE	--
YI-9321A	Generator #1	Blower Building	Generator #1 Not in Auto	DI	--	RTU-3	--	--	--	FALSE	--
YI-9321B	Generator #1	Blower Building	Generator #1 Running	DI	--	RTU-3	--	--	--	FALSE	--
YA-9321A	Generator #1	Blower Building	Generator System Alarm	DI	--	RTU-3	--	--	--	TRUE	--
YA-9321B	Generator #1	Blower Building	Generator #1 Failure	DI	--	RTU-3	--	--	--	TRUE	--
YA-9321C	Generator #1	Blower Building	Generator #1 Low Fuel	DI	--	RTU-3	--	--	--	TRUE	--
YA-9321D	Generator #1	Blower Building	Generator #1 Fuel Leak	DI	--	RTU-3	--	--	--	TRUE	--
YI-9322A	Generator #2	Blower Building	Generator #2 Not in Auto	DI	--	RTU-3	--	--	--	FALSE	--
YI-9322B	Generator #2	Blower Building	Generator #2 Running	DI	--	RTU-3	--	--	--	FALSE	--
YA-9322A	Generator #2	Blower Building	Generator System Alarm	DI	--	RTU-3	--	--	--	TRUE	--

**IO AND ALARM LIST**

<b>IO Tag No</b>	<b>Service</b>	<b>Location</b>	<b>IO Description</b>	<b>IO Type</b>	<b>IO Signal Range</b>	<b>CP Termination</b>	<b>LRL</b>	<b>URL</b>	<b>Units</b>	<b>Alarm List</b>	<b>Remarks</b>
YA-9322B	Generator #2	Blower Building	Generator #2 Failure	DI	--	RTU-3	--	--	--	TRUE	--
YA-9322C	Generator #2	Blower Building	Generator #2 Low Fuel	DI	--	RTU-3	--	--	--	TRUE	--
YA-9322D	Generator #2	Blower Building	Generator #2 Fuel Leak	DI	--	RTU-3	--	--	--	TRUE	--
YI-9323A	Generator #3	Blower Building	Generator #3 Not in Auto	DI	--	RTU-3	--	--	--	FALSE	--
YI-9323B	Generator #3	Blower Building	Generator #3 Running	DI	--	RTU-3	--	--	--	FALSE	--
YA-9323A	Generator #3	Blower Building	Generator System Alarm	DI	--	RTU-3	--	--	--	TRUE	--
YA-9323B	Generator #3	Blower Building	Generator #3 Failure	DI	--	RTU-3	--	--	--	TRUE	--
YA-9323C	Generator #3	Blower Building	Generator #3 Low Fuel	DI	--	RTU-3	--	--	--	TRUE	--
YA-9323D	Generator #3	Blower Building	Generator #3 Fuel Leak	DI	--	RTU-3	--	--	--	TRUE	--
YA-9325	Plant Fire Alarm	Operations Building	Fire Alarm Activated	DI		RTU-2	--	--	--	TRUE	--
YI-9330	2ERV-1	Operations Building	2ERV-1 Running	DI	--	RTU-2	--	--	--	FALSE	--
YA-9330	2ERV-1	Operations Building	2ERV-1 Alarm	DI	--	RTU-2	--	--	--	TRUE	--
YI-9331	2ERV-2	Operations Building	2ERV-2 Running	DI	--	RTU-2	--	--	--	FALSE	--
YA-9331	2ERV-2	Operations Building	2ERV-2 Alarm	DI	--	RTU-2	--	--	--	TRUE	--
YI-9332	9ERV-1	Operations Building	9ERV-1 Running	DI	--	RTU-2	--	--	--	FALSE	--
YA-9332	9ERV-1	Operations Building	9ERV-1 Alarm	DI	--	RTU-2	--	--	--	TRUE	--
YI-9333	3ERV-1	Blower Building	3ERV-1 Running	DI	--	RTU-3	--	--	--	FALSE	--

**IO AND ALARM LIST**

<b>IO Tag No</b>	<b>Service</b>	<b>Location</b>	<b>IO Description</b>	<b>IO Type</b>	<b>IO Signal Range</b>	<b>CP Termination</b>	<b>LRL</b>	<b>URL</b>	<b>Units</b>	<b>Alarm List</b>	<b>Remarks</b>
YA-9333	3ERV-1	Blower Building	3ERV-1 Alarm	DI	--	RTU-3	--	--	--	TRUE	--
YI-9334	4ERV-1	Sludge Pumping Station #1	4ERV-1 Running	DI	--	RTU-4A	--	--	--	FALSE	--
YA-9334	4ERV-1	Sludge Pumping Station #1	4ERV-1 Alarm	DI	--	RTU-4A	--	--	--	TRUE	--
YI-9335	4ERV-2	Sludge Pumping Station #2	4ERV-2 Running	DI	--	RTU-4B	--	--	--	FALSE	--
YA-9335	4ERV-2	Sludge Pumping Station #2	4ERV-2 Alarm	DI	--	RTU-4B	--	--	--	TRUE	--
YI-9336	5ERV-1	Chemical Building	5ERV-1 Running	DI	--	RTU-5	--	--	--	FALSE	--
YA-9336	5ERV-1	Chemical Building	5ERV-1 Alarm	DI	--	RTU-5	--	--	--	TRUE	--
YI-9337	7ERV-1	Solids Handling Building	7ERV-1 Running	DI	--	RTU-7	--	--	--	FALSE	--
YA-9337	7ERV-1	Solids Handling Building	7ERV-1 Alarm	DI	--	RTU-7	--	--	--	TRUE	--
YI-9338	7ERV-2	Solids Handling Building	7ERV-2 Running	DI	--	RTU-7	--	--	--	FALSE	--
YA-9338	7ERV-2	Solids Handling Building	7ERV-2 Alarm	DI	--	RTU-7	--	--	--	TRUE	--
YI-9339	7ERV-3	Solids Handling Building	7ERV-3 Running	DI	--	RTU-7	--	--	--	FALSE	--
YA-9339	7ERV-3	Solids Handling Building	7ERV-3 Alarm	DI	--	RTU-7	--	--	--	TRUE	--
YI-9340	7ERV-4	Solids Handling Building	7ERV-4 Running	DI	--	RTU-7	--	--	--	FALSE	--
YA-9340	7ERV-4	Solids Handling Building	7ERV-4 Alarm	DI	--	RTU-7	--	--	--	TRUE	--
YI-9341	7MAU-1	Solids Handling Building	7MAU-1 Running	DI	--	RTU-7	--	--	--	FALSE	--
YA-9341	7MAU-1	Solids Handling Building	7MAU-1 Alarm	DI	--	RTU-7	--	--	--	TRUE	--

**IO AND ALARM LIST**

<b>IO Tag No</b>	<b>Service</b>	<b>Location</b>	<b>IO Description</b>	<b>IO Type</b>	<b>IO Signal Range</b>	<b>CP Termination</b>	<b>LRL</b>	<b>URL</b>	<b>Units</b>	<b>Alarm List</b>	<b>Remarks</b>
LSH-9350	Primary Pipe Gallery Water High Level	Primary Pipe Gallery	Primary Pipe Gallery Water Level High	DI		RTU-2	--	--	--	TRUE	--
LSH-9351	Operations Building Basement Water High Level	Operations Building Basement	Operations Building Basement Water Level High	DI		RTU-2	--	--	--	TRUE	--
LSH-9352	Sump Pump 4SP-1 High Level	Sludge Pumping Station #1	4SP-1 Sump Pit High Level	DI		RTU-4A	--	--	--	TRUE	--
LSH-9353	Sump Pump 4SP-2 High Level	Sludge Pumping Station #2	4SP-2 Sump Pit High Level	DI		RTU-4B	--	--	--	TRUE	--
LSH-9354	Sump Pump 5SP-1 High Level	Chemical Building	5SP-1 Sump Pit High Level	DI		RTU-5	--	--	--	TRUE	--
LSH-9355	Sump Pump 7SP-1 High Level	Solids Handling Building	7SP-1 Sump Pit High Level	DI		RTU-7	--	--	--	TRUE	--
LSH-9356	Thickened Sludge Pump Station Water High Level	Solids Handling Building	Thickened Sludge Pump Station Water Level High	DI		RTU-7	--	--	--	TRUE	--
LSH-9360	Blower Building Tight Tank Level High	Blower Building	Blower Building Tight Tank Level High	DI		RTU-3	--	--	--	TRUE	--

**Notes:**

1. Column with Exist. - Refer to existing configuration in the existing PLC control logic software.
2. The IO and Alarm List contains a list of the physical IO points. Refer to the Loop Descriptions in this Section for additional IO points. For example, elapsed time meters (KQI-xxx), flow totalizers (FQI-xxx), motor state disagreement alarms (YA-xxx), software-based selector switches, start/stop or reset pushbuttons (HS-xxx), software-based timers (KC-xxx), level set points (LS-xxx), etc.

3. The IO point has one or more alarm points when “TRUE” appears in the “Alarm List” column. If no ISA identification letters appear in the “Alarm Remarks” column, then the alarm tag is the same as the tag in the “IO Tag No” column. When multiple sets of ISA identification letters appear in the “Alarm Remarks” column, create an alarm point for each set of ISA identification letters. Refer to the examples below. IO points with multiple alarm points are typical for \*IT or \*T ISA identification letters in the “IO Tag No” column, where \* = first letter(s) of the set of ISA identification letters. Refer to the “Alarm Remarks” column for the specific alarms.

\*AHH = \* alarm high high. Initially set at LRL + 90% of span rising, adjustable  
\*AH = \* alarm high. Initially set at LRL + 80% of span rising, adjustable  
\*AL = \* alarm low. Initially set at LRL + 20% of span falling, adjustable  
\*ALL = \* alarm low low. Initially set at LRL + 10% of span falling, adjustable  
d\*/dt = high rate of change alarm. Initially set at 5% of span/second, adjustable  
\*DAH = set point deviation alarm. Initially set at 5% of set point, adjustable

END OF SECTION



## **DIVISION 14**

## SECTION 14600

### PUMP & MIXER HOISTING EQUIPMENT

#### PART 1 GENERAL

##### 1.01 SECTION INCLUDES

- A. Furnish, install, test and place in satisfactory operation the hoisting equipment, complete with all supports, fastenings, and other appurtenances, as indicated on the drawings and as herein specified.
- B. The specifications and drawings direct attention to certain required features of the equipment but do not purport to cover all details entering into its design and construction. Nevertheless, the Contractor shall furnish, shop test, deliver, install and field test all materials, equipment and appurtenances for the hoisting equipment complete in all details and ready for operation as specified herein, whether specifically mentioned in these specifications or not.

##### 1.02 RELATED SECTIONS

- A. SECTION 01300 – SUBMITTALS
- B. SECTION 01631 – USE OF OTHER THAN FIRST NAMED MANUFACTURER
- C. SECTION 05500 – METAL FABRICATIONS
- D. SECTION 01730 – OPERATION AND MAINTENANCE MANUALS
- E. SECTION 11301 – SUBMERSIBLE MIXERS
- F. SECTION 11315 – SUBMERSIBLE PROPELLER PUMPS

##### 1.03 QUALITY ASSURANCE

- A. The hoisting systems shall conform to the location, capacity, critical dimensions, and other pertinent data listed in the “Equipment Schedule” included herein.
- B. All structural steel members of the handling system shall be designed in accordance with the specifications of American Institute of Steel Construction, current edition, and any welded construction shall be in accordance with the standards of the American Welding Society.
- C. Castings, forgings, stampings, etc., shall have a safety factor of at least 5.

##### 1.04 SUBMITTALS

- A. Shop Drawings in accordance with specification Section 01300.
- B. Operation and Maintenance Manual in accordance with specification Section 01730.

#### PART 2 PRODUCTS

## 2.01 GENERAL

- A. All hoisting equipment shall conform to the current standards set forth by the following:
  - 1. American Institute of Steel Construction
  - 2. American Welding Society
  - 3. Crane Manufacturers Association of American Inc., (C.M.A.A.)
- B. All hoisting equipment parts shall be proportioned so that all stresses and vertical or lateral deflections will be within conservative limits with minimum vibration. Rated load safety factors of at least five, based upon ultimate strength of the materials used, shall be employed.
- C. The Contractor shall verify all dimensions and clearances in the field prior to erection of the hoisting equipment and shall be responsible for the proper fitting and operation of the equipment.
- D. The capacity of each hoist shall be permanently marked in a conspicuous manner.
- E. All hooks shall be safety type.

## 2.02 MANUFACTURERS

- A. Thern Incorporated
- B. Approved equal.
- C. Should equipment which differs from that named in this Section be offered and determined to be the equal of that specified, such equipment shall be acceptable only on the basis that any revision in the design and/or construction of the structure, piping, appurtenant equipment, electrical work, etc, required to accommodate such a substitution shall be made at no additional cost to the Owner and be as approved by the Engineer.

## 2.03 DESIGN

- A. Portable Davit Crane and Retrieval Winch
  - 1. The hoisting equipment for the internal recycle pumps shall be the Commander 1000 Series 5PT10G-M1 Davit Crane, as manufactured by Thern Incorporated of Winona Minnesota, or approved equal.
  - 2. The hoisting equipment for the submersible mixers and sump pumps shall be the Commander 500 Series 5PT5G-M1 Davit Crane, as manufactured by Thern Incorporated of Winona Minnesota, or approved equal.
  - 3. Capacity of the internal recycle pump and submersible mixer/sump pump galvanized steel davit cranes shall be up to 1,200 & 650 pounds, respectively, and shall have the following properties:
    - a. Crane shall have lift capabilities up to 23 feet.
    - b. Hooks shall be of high grade, forged steel, and shall have swivel, antifriction bearings.

4. Fasteners
  - a. Studs, nuts, washers, and fasteners shall be Type 304 stainless steel and shall be furnished with the hoisting equipment.
5. Cable
  - a. Cable shall be 1/4" 36 feet of 304 stainless steel wire rope.
6. Crane
  - a. Crane shall be of galvanized steel construction
  - b. Galvanized zinc-plated steel spur gear hand winch
  - c. Ratchet jack adjustable boom with lateral reach of 23.5" to 60.0" (min.).
  - d. Twenty-two (22) total galvanized steel pedestal bases. Sizes vary, see equipment schedule.
  - e. Twenty-two (22) total pedestal covers. Sizes vary, see equipment schedule.

<b>EQUIPMENT SCHEDULE</b>				
<b>Hoist Location</b>	<b>Biological Treatment Reactor</b>	<b>Biological Treatment Reactor</b>	<b>Secondary Anoxic Tanks</b>	<b>Re-Aeration Tanks</b>
Number Required	1 for 4 mount locations	1 for 11 mount locations	1 for 6 mount locations	1 for 2 mount locations
Rate Use	Outdoor	Outdoor	Outdoor	Outdoor
Suspension Type	Hook	Hook	Hook	Hook
Capacity (min.)	1,200 Pounds	650 Pounds	650 Pounds	650 Pounds
Hoist Type	Davit Crane	Davit Crane	Davit Crane	Davit Crane
Distance of lift below floor level	21 feet	23 feet	23 feet	15 feet

7. Davit cranes that require a vertical clearance of 90 inches above the operating floor to lift equipment will not be acceptable.

### PART 3 EXECUTION

#### 3.01 INSTALLATION

- A. All equipment shall be installed in accordance with the manufacturer's written instructions, as approved, and all equipment and materials required for proper installation shall be provided.
- B. It shall be the responsibility of the Contractor to coordinate the work included under this section of the specifications with other related work specified herein to ensure that all the equipment shall operate to perform the designated functions in a proper and acceptable manner.
- C. Anchor bolts, expansion bolts, studs, nuts, washers and fasteners shall be set as per manufacturer's recommendations.

#### 3.02 ADJUSTING

- A. Adjust crane to operate smoothly under all load conditions, without malfunction.

3.03 FIELD ACCEPTANCE TESTS

A. Test crane, at the rated load, in the presence of the Engineer.

3.04 TOOLS AND LUBRICANTS

A. Furnish a complete set of any special tools required for the maintenance and operation of this equipment, as designated by the equipment manufacturer.

B. A one-year supply of each type of lubricant required for each piece of equipment and one grease gun for each type lubricant required shall be furnished under this Section.

END OF SECTION

## SECTION 14600

### MONORAIL HOISTING EQUIPMENT

#### PART 1 GENERAL

##### 1.01 SECTION INCLUDES

- A. Furnish, install, test and place in satisfactory operation the hoisting equipment, complete with all supports, fastenings, and other appurtenances, as indicated on the drawings and as herein specified. One (1) monorail hoist for lifting sludge centrifuge equipment is to be supplied and installed.
- B. The specifications and drawings direct attention to certain required features of the equipment but do not purport to cover all details entering into its design and construction. Nevertheless, the Contractor shall furnish, shop test, deliver, install and field test all materials, equipment and appurtenances for the hoisting equipment complete in all details and ready for operation as specified herein, whether specifically mentioned in these specifications or not.

##### 1.02 RELATED SECTIONS

- A. SECTION 01300 – SUBMITTALS
- B. SECTION 01631 – USE OF OTHER THAN FIRST NAMED MANUFACTURER
- C. SECTION 05500 – METAL FABRICATIONS
- D. SECTION 01730 – OPERATION AND MAINTENANCE MANUALS

##### 1.03 QUALITY ASSURANCE

- A. The hoisting systems shall conform to the location, capacity, critical dimensions, and other pertinent data included herein.
- B. All structural steel members of the handling system shall be designed in accordance with the specifications of American Institute of Steel Construction, current edition, and any welded construction shall be in accordance with the standards of the American Welding Society.

##### 1.04 SUBMITTALS

- A. Shop Drawings in accordance with specification Section 01300.
- B. Operation and Maintenance Manual in accordance with specification Section 01730.

#### PART 2 PRODUCTS

##### 2.01 GENERAL

- A. All hoisting equipment shall conform to the current standards set forth by the following:

1. Crane Manufacturers Association of American Inc., (C.M.A.A.)
- B. All hoisting equipment parts shall be proportioned so that all stresses and vertical or lateral deflections will be within conservative limits with minimum vibration. Rated load safety factors of at least five, based upon ultimate strength of the materials used, shall be employed.
- C. The Contractor shall verify all dimensions and clearances in the field prior to erection of the hoisting equipment and shall be responsible for the proper fitting and operation of the equipment.
- D. The capacity of each hoist shall be permanently marked in a conspicuous manner.
- E. All hooks shall be safety type.

## 2.02 MANUFACTURERS

- A. Advantage Hoist
- B. Approved equal.
- C. Should equipment which differs from the first named in this Section be offered and determined to be the equal of that specified, such equipment shall be acceptable only on the basis that any revision in the design and/or construction of the structure, piping, appurtenant equipment, electrical work, etc, required to accommodate such a substitution shall be made at no additional cost to the Owner and be as approved by the Engineer.

## 2.03 DESIGN

- A. Low Headroom Monorail Wire Rope hoist
  1. The hoisting equipment for the centrifuges shall be a CMAA Class "D" duty low-headroom monorail wire rope hoist with a lifting capacity of 10,000 lbs. Hoist shall be 12 HP and shall utilize 460V, 3 phase, 60 Hz power.
  2. The trolley motor shall be heavy duty cast iron TENV, equipped with a DC trolley brake and designed for heavy duty Class D application.
  3. Hoist motor shall be totally enclosed heavy duty cast iron TENV oversized for long lasting operation. Hoist shall have a heavy duty DC holding brake.
  4. Hoist shall be equipped with a heavy duty hoist gear box with helical gearing and a mechanical load brake. The load brake shall be rated to stop the maximum rated load.
  5. Hoist shall be equipped with a push button pendant station with emergency E-stop.
  6. Cable and Hook
    - a. Lifting Cable shall be a double-reeved high strength wire rope rated for the full capacity of the hoist. Lifting cable shall be equipped with a high strength forged steel hook equipped with a safety latch and a thrust bearing to allow the hook to rotate 360 degrees.

7. Hoist shall be adjustable to accommodate a flange width of 5.9” to 11.8”.

### PART 3 EXECUTION

#### 3.01 INSTALLATION

- A. All equipment shall be installed in accordance with the manufacturer’s written instructions, as approved, and all equipment and materials required for proper installation shall be provided.
- B. It shall be the responsibility of the Contractor to coordinate the work included under this section of the specifications with other related work specified herein to ensure that all the equipment shall operate to perform the designated functions in a proper and acceptable manner.

#### 3.02 ADJUSTING

- A. Adjust crane to operate smoothly under all load conditions, without malfunction.

#### 3.03 FIELD ACCEPTANCE TESTS

- A. Test crane, at the rated load, in the presence of the Engineer.

#### 3.04 TOOLS AND LUBRICANTS

- A. Furnish a complete set of any special tools required for the maintenance and operation of this equipment, as designated by the equipment manufacturer.
- B. A one-year supply of each type of lubricant required for each piece of equipment and one grease gun for each type lubricant required shall be furnished under this Section.

END OF SECTION



## **DIVISION 15**

## SECTION 15050

### GAUGES

#### PART 1 GENERAL

##### 1.01 SECTION INCLUDES

- A. Requirements to furnish and install gauges at locations indicated on the Drawings and as specified.

#### PART 2 PRODUCTS

##### 2.01 GENERAL

- A. Gauges include pressure, vacuum and compound gauges of the dial indicating Bourdon tube-type.
- B. Pressure gauges shall be designed to indicate pressures above atmospheric pressure only.
- C. Vacuum gauges shall be designed to indicate pressures below atmospheric pressure only.
- D. Compound gauges shall be designed to indicate pressures above and below atmospheric pressure.

##### 2.02 MANUFACTURER

- A. Ashcroft Duragauge
- B. Approved equal.

##### 2.03 LOCATION

- A. Gauges shall be provided where shown on the Drawings, specified in the Specifications or required for a complete installation. Indicating pressure gauges shall be provided downstream of each pressure regulating valve where shown, specified or required; in the seal water piping of each pump; and on both the suction and discharge piping of each pump except where otherwise specified.

##### 2.04 ACCURACY

- A. Grades of accuracy shall conform to the requirements of American Standard A.S.A. B40.1. The Contractor shall submit manufacturer's certifications indicating that the gauges provided have met the accuracy requirements specified.
- B. Pressure, vacuum and compound gauges shall be Grade AA gauges with an error not exceeding  $\frac{1}{2}$  of 1 percent of full-scale range.

- C. Gauges with a flexible seal between the Bourdon tube and the medium to be measured shall have an overall accuracy of Grade A with an error not exceeding one percent of scale range for the middle half and 1-1/2 percent for the remainder of the scale.

## 2.05 GAUGE CONSTRUCTION

- A. Gauges shall be weatherproof, designed and constructed to meet all requirements for satisfactory operation.
- B. Pressure, vacuum and compound gauges shall be constructed of sound, durable material, free from all defects and imperfections that in any way may affect the accuracy and serviceability of the gauges.
- C. Gauge cases shall be of aluminum, phenolic or polypropylene. Dial shall be 4 1/2 inches nominal diameter with black lettering and scales on a white background, and shall bear a legend showing service and units of graduation. Gauge dial shall be clear and blemish free and sealed to prevent entrance of moist air. Bourdon tube shall be phosphor bronze with forged brass socket. Set point shall be of stainless steel. Socket stem shall extend at least 1-1/4 inches below the gauge case and shall have a large wrench flat.
- D. Pressure gauges shall be graduated in psi unless otherwise specified. Vacuum gauges shall be graduated in inches of mercury; compound gauges shall be graduated in inches of mercury, psi or feet of water as specified.
- E. Maximum scale reading for pressure and compound gauges shall be approximately twice the maximum operating pressure of the fluid to be measured. Vacuum and compound gauges shall have minimum scale readings at 30 inches of mercury unless otherwise shown or specified.
- F. Unless otherwise shown or specified, all pressure, vacuum and compound gauges shall have bottom 1/2-inch NPT male connections.

## 2.06 DIAPHRAGM PROTECTED GAUGES

- A. The Contractor shall provide diaphragm seals on sludge gauges to prevent the fluid to be measured from clogging or corroding the Bourdon tube of pressure, vacuum and compound gauges.
- B. Diaphragm seals shall be suitable for the gauge furnished; gauges to be used with diaphragm seals shall be Grade AA gauges conforming to the requirements specified herein. Chemical gauges shall have the diaphragm seal as an integral part. Overall accuracy for diaphragm protected units shall be Grade A.
- C. Diaphragms shall have an overall diameter of not less than 2-1/2 inches and shall be made of a material that is corrosion resistant and compatible with the process fluid. Diaphragm protected gauges shall be factory filled with Glycerin oil or approved equal and calibrated by the gauge manufacturer. Unless specified otherwise, diaphragm protected gauges shall be provided with sintered metal snubbers or pulsation dampers.
- D. Diaphragm housing assembly shall be of durable stainless or cadmium plated with a 3/4 inch NPT process connection. The lower housing shall have a 1/4 inch NPT flushing connection

and 1/4 inch NPT plug, to allow venting or the introduction of cleaning fluid on the process side of the diaphragm seal. The bottom housing shall be made of a material that is corrosion resistant and compatible with the process fluid. A clean out ring shall be provided to hold the diaphragm captive in the upper housing so that the assembly may be removed for recalibration or cleaning of the process side without loss of instrument fluid. Diaphragm protected gauges and seals shall be ACCO Helicoid Diaphragm Seal Type 100 HACF, Ashcroft Diaphragm Seal Type 101, or equal.

## 2.07 GAUGE PROTECTION AND ACCESSORIES

- A. Unless otherwise shown or specified, pressure gauges shall have under pressure protection and vacuum gauges shall have overpressure protection. For helical roller type pressure gauges, the gauge shall have a left hand movement for under pressure protection; for all other gauges, under pressure protection stops shall be provided. For vacuum gauges with helical roller movement, gauges shall have right hand movement for overpressure protection; all other gauges shall have suitable overpressure protection stops.
- B. Unless otherwise shown or specified, all pressure, vacuum and compound gauges shall be provided with stainless steel sintered metal snubbers of porosity suitable for this service. Snubbers shall be ACCO Helicoid No. S-2 or S-4, Ashcroft Chemquip No. 1112S or equal.
- C. Diaphragm protected gauges for normal service shall be provided with rough plumbing 3/4 inch stop valves for shut-off cocks, and 3/4 inch red brass pipe. Valves shall have a bronze body, stainless steel ball, and teflon seats, valves shall have a spring-closing handle.
- D. Gauges other than diaphragm protected gauges shall be installed complete with incidental shut-off cock and tees with test cock with a female outlet. All pipe and fittings shall be brass. The gauge shall be mounted directly in the outlet of the tee-bearing test cock.

END OF SECTION

## SECTION 15060

### PIPE HANGERS AND SUPPORTS

#### PART 1 - GENERAL

##### 1.01 SCOPE OF WORK

- A. Furnish all labor, materials, equipment and incidentals required to install, and make completely ready for operation, pipe hangers, supports, concrete inserts, and anchor bolts including, in general, all metallic hanging and supporting devices as specified herein and as shown on the Drawings.
- B. This section shall cover pipe hangers and support for piping other than the stainless steel piping for process air service. Pipe hangers and supports for this piping system are in Section 15066 – Stainless Steel Pipe and Fittings.
- C. **Items in this Specification are subject to the American Iron and Steel requirements of P.L. 113-76, the Consolidated Appropriations Act of 2014.**

##### 1.02 RELATED WORK

- A. Section 02618 - Ductile Iron Pipe and Fittings for Potable Water Service
- B. Section 03300 – Cast In Place Concrete
- C. Section 11961 – Interior and Exterior Process Piping
- D. Section 15066 – Stainless Steel Pipe and Fittings

##### 1.03 QUALIFICATIONS

- A. All hangers, supports and appurtenances shall conform to the latest requirements of the following listed references except as supplemented or modified by the requirements of this Specification.

###### References

1. Code for pressure piping, ANSI B 31.1.
  2. MSS-SP-58 pipe hangers and supports, materials design and manufacture.
  3. MSS-SP-69 pipe hangers and supports selection and application.
- B. Hangers and supports shall be of approved standard design where possible and shall be adequate to maintain the supported load in proper position under all operating conditions.

- C. All supporting equipment, with the exception of springs, shall be designed with a minimum working factor of safety of five based on the ultimate tensile strength of the material.

#### 1.04 SUBMITTALS

- A. Submit a representative catalog cut for each different type of pipe hanger or support indicating the materials of construction, important dimensions and range of pipe sizes for which that hanger is suitable. Where standard hangers are not suitable, submit detailed drawings showing materials and details of construction for each type.
- B. Submit complete piping drawings indicating type of hanger, location, and magnitude of load transmitted to the structure. Submittals shall use detail numbers as shown on the Drawings to indicate type of support proposed wherever possible.
- C. Design Certificate.

### PART 2 - PRODUCTS

#### 2.01 GENERAL

- A. All of the equipment specified herein is intended to support the various types of pipe and piping systems. The details shown on the Drawings are intended to indicate the generally desired methods of support under normal conditions. It shall be the responsibility of the Contractor to provide the services of a Licensed Professional Mechanical Engineer in the State of Rhode Island, with a minimum of 5 years of demonstrated experience in the design of support connections, necessary to design the supports and connections for all equipment for all weights and applied pressures as shown on the piping schedule in the plans. In the design of hangers, supports and anchors, pipe pressures shall be taken as the maximum rated pressure specified for pipe lines carrying gases and air and twice the maximum rated pressure specified for pipe lines carrying liquids. Payment for such design services shall be included in the prices bid for furnishing and installing pipe lines.

Design computations shall not be submitted for review. Any submittals shall be returned without comment. A design certificate shall be submitted prior to installation of any piping. Sample certificate is provided at the end of this Section.

- B. Where flexible couplings are required at equipment, tanks, etc. the end opposite to the piece of equipment, tank, etc. shall be rigidly supported.
- C. The Drawings and Specifications indicate general and specific methods and details of supporting the various piping systems. Any changes to the support details shown shall be submitted to the engineer for review.
- D. All pipe and appurtenances connected to the equipment shall be supported in a manner to prevent any strain from being imposed on the equipment or piping system.
- E. All pipe and tubing shall be supported as required to prevent damaging stresses in the pipe or tubing material, valves and fittings, and to support and secure the pipe in the intended position and alignment. All supports shall be designed to adequately secure the pipe against excessive dislocation due to thermal expansion and contraction, internal flow forces, and all probable external forces such as equipment, pipe, and personnel contact through 360 degrees in all three dimensions.
- F. Supports shall be sufficiently close together such that the sag of the pipe is within limits that will permit drainage and avoid excessive bending stresses from concentrated loads between supports.
- G. All uninsulated non-metallic piping such as PVC, fiberglass, etc. shall be protected from local stress concentrations at each support point. Protection shall be provided by galvanized steel protection shields or other method as approved by the engineer where pipes are bottom supported 180 degree arc shields shall be furnished. Where 360 degree arc support is required, such as U Bolts, protection shields shall have a 50 mils minimum thickness, not be less than 12 inches in length and be securely fastened to pipe with stainless steel or galvanized metal straps not less than 1/2 inch wide.
- H. All insulated pipe shall be furnished with a rigid foam insulating saddle at each pipe support location as specified under insulation. Provide galvanized protection shields as specified in Paragraph 2.01G above at each location.
- I. Where pipe hangers and supports come in contact with copper piping provide protection from galvanic corrosion by wrapping pipe with 60 mils thick neoprene sheet material and galvanized protection shield; isolators similar to Elcin figure number 228; or copper plated or PVC coated hangers and supports.
- J. Pipe supports shall be provided as follows:

1. Cast iron soil pipe shall be supported at a maximum support spacing of 5.0 feet with a minimum of one support per pipe section at the joints.
  2. Steel piping shall be supported at a maximum support spacing of 10 feet with a minimum of one support per pipe section at the joints.
  3. Fiberglass pipe shall be supported as recommended by the manufacturer except that support spacing shall not exceed 5 feet.
  4. PVC and CPVC pipe shall be supported as recommended by the manufacturer except that support spacing shall not exceed 3 feet. For pipe equal to or less than 1 inch in diameter and 5 feet for all other pipe sizes.
  5. Support spacing for steel pipe 2 inches and smaller and copper tubing shall not exceed 5 feet.
  6. Ductile iron piping shall be supported at a maximum support spacing of 10 feet with a minimum of one support per pipe section at the joints.
  7. All vertical pipe shall be supported at each floor or at intervals of not more than 12 feet by approved pipe collars, clamps, brackets, or wall rests, and at all points necessary to insure rigid construction.
  8. Pipe supports shall not induce point loadings but shall distribute pipe loads evenly along the pipe circumference.
  9. Effects of thermal expansion and contraction of the pipe shall be accounted for in the pipe support selection and installation.
- K. Unless otherwise specified herein, pipe hangers and supports shall be as manufactured by Grinnel Co., Inc., Providence, Rhode Island, USA; Carpenter & Patterson, Inc., Woburn, Massachusetts, USA; F&S Central, Brooklyn, New York, USA; Elcen Metal Products Co., Franklin Park, Illinois, USA, and Unistrut Northeast, Cambridge, Massachusetts, USA, or equal. Any reference to a specific figure number of a specific manufacturer is for the purpose of establishing a type and quality of product and shall not be considered as proprietary. Any item comparable in type, style, quality, design and performance shall be considered as equal.



## 2.02 SINGLE PIPE HANGERS

- A. Single pipes shall be supported by hangers suspended by galvanized steel rods from structural steel members, concrete ceilings and beams, bottom of trapeze hangers and wall mounted steel angle brackets.
- B. Hanger rods shall be hot rolled steel, machine threaded and galvanized after fabrication. The strength of the rod shall be based on its root diameter.
- C. Except as otherwise specified herein, pipe hangers shall be adjustable clevis type similar to Grinnell Figure Numbers 65,260, and 590 as required. Hangers shall be carbon steel with a galvanized finish.
- D. Hanger rods shall be attached to concrete structures using concrete inserts similar to F&S Figures 180, 571 or 150. Inserts shall be malleable iron, or steel with galvanized finish. Beam clamps, C clamps or welded beam attachments shall be used for attaching hanger rods to structural steel members. Where necessary and approved by the engineer double expansion shields shall be used for attaching to concrete structures.
- E. Where pipes are near walls, beams, columns, etc. and located an excessive distance from ceilings or underside of beams, welded steel wall brackets similar to Carpenter and Patterson Figure numbers 69-68, 84 or 139 shall be used for hanging pipe. Brackets shall be galvanized. Where single pipes rest on top of bracket pipe supports, attachments shall meet requirements as specified under multiple pipe hangers.

## 2.03 MULTIPLE PIPE HANGERS

- A. Suspended multiple pipes, running parallel in the same horizontal plane, which are adjacent to each other shall be suspended by trapeze type hangers or wall brackets. Trapeze hangers shall consist of galvanized structural steel channel supported from galvanized threaded rod or attached to concrete walls, columns or structural steel support members as required to meet the intent of this specification. Channel shall be similar to F&S Figure 710, rods, concrete inserts, "C" Clamps, beam clamps, welded beam attachments, and expansion shields shall be as specified in 2.02 Single Pipe Hangers.
- B. Except as otherwise specified herein pipe anchors used for attaching pipe to trapeze or multiple pipe wall brackets shall be anchor or pipe chair similar to F&S Figures 158, 419, 160A, 160B as required. Materials of construction shall be galvanized steel. Chair "U" bolts shall be tightened to allow freedom of movement for normal expansion and contraction

except when pipe must be anchored to control direction of movement or act as a thrust anchor.

#### 2.04 SINGLE AND MULTIPLE PIPE SUPPORTS

- A. Single pipes located in a horizontal plane close to the floor shall be supported by one of the methods specified herein or as shown on the Drawings.
- B. Pipes 3-inch diameter and larger shall be supported by adjustable stanchions similar to F&S Figure 427, constructed of galvanized steel. Stanchions shall provide at least 4-inch adjustment and be flange mounted to floor.
- C. Pipes less than 3-inches in diameter shall be held in position by supports fabricated from steel "C" channel, welded post base similar to Unistrut Figure P2072A and pipe clamps similar to Unistrut Figures P1109 thru P1126. Where required to assure adequate support, fabricate supports using two vertical members and post bases connected together by horizontal member of sufficient load capacity to support pipe. Wherever possible supports shall be fastened to nearby walls or other structural member to provide horizontal rigidity. More than one pipe may be supported from a common fabricated support. All supports unless specified elsewhere shall be galvanized.
- D. Where required, pipe shall be supported using concrete anchor posts. Pipe shall be securely fastened to concrete anchor posts using suitable metal straps as required and approved by the engineer.

#### 2.05 WALL SUPPORTED PIPES

- A. Single or multiple pipes located adjacent to walls, columns or other structural members shall whenever deemed necessary shall be supported using welded steel wall brackets similar to Carpenter and Patterson Figure numbers 69-78, 84, or 134; or "C" Channel with steel brackets similar to Unistrut pipe clamps. All members shall be securely fastened to wall, column, etc. using double expansion shields or other method as approved by the engineer.
- B. Pipe shall be attached to supports using methods hereinbefore specified to meet the intent of this Specification.
- C. All supports shall be galvanized.

#### 2.06 BASE ANCHOR SUPPORT

- A. Where pipes change direction from horizontal to vertical via a bend, a welded or cast base anchor support shall be installed at the bend to carry the load. The bend anchor shall be fastened to the floor with double expansion shields or other method as approved by the engineer.
- B. Where shown on the drawings, pipe bends shall be supported using concrete anchor posts. Pipes shall be securely fastened to concrete supports with suitable metal bands as required and approved by the engineer.

## 2.07 VERTICAL PIPE SUPPORTS

- A. Where vertical pipes are not supported by an Unistrut system as specified in Paragraph 2.08, they shall be supported in one of the following methods.
  - 1. For pipes 1/4-inch to 2-inch in diameter, an extension hanger ring shall be provided with an extension rod and hanger flange. The rod diameter shall be as recommended by the manufacturer for the type of pipe to be supported. The hanger ring shall be galvanized steel or PVC clad depending on the supported pipe. The hanger ring shall be equal to Carpenter & Peterson Figure number 81 or 81CT. The anchor flange shall be galvanized malleable iron similar to Carpenter & Patterson Figure number 85.
  - 2. For pipes equal to or greater than 1/2-inch in diameter extended pipe clamps similar to Carpenter and Patterson Figure number 267 may be used. The hanger shall be attached to concrete structures using double expansion shields, or to steel support members using welding lugs similar to Carpenter & Patterson Figure number 220.
  - 3. Pipe riser clamps shall be used to support all vertical pipes extending through floor slabs. Riser clamps shall be galvanized steel similar to Carpenter & Patterson Figure number 126. Copper clad or PVC coated clamps shall be used on copper pipes. Insulation shall be removed from insulated pipes prior to installing riser clamps.
  - 4. Unless otherwise specified, shown, or specifically approved by the engineer, vertical runs exceeding 11 feet, pipes shall be supported by approved pipe collars, clamps, brackets or wall rests at all points required to insure a rigid installation.

## 2.08 SPECIAL SUPPORTS

- A. Pipe supports shall be provided for closely spaced vertical piping systems as shown on the Drawings or as otherwise required to provide a rigid installation. The support system shall consist of a framework suitably anchored to floors, ceilings and walls and be as manufactured by the Unistrut Corporation, Globe-Strut as manufactured by the Metal Products Division of U.S. Gypsum, or equal.
- B. Vertical and horizontal supporting members shall be U shaped channels similar to Unistrut Series P1000. Vertical piping shall be secured to the horizontal members by pipe clamps or pipe straps equal to Unistrut Series P1100M and Series P2558. All components shall be of mild steel.
- C. The assemblies shall be furnished complete with all nuts, bolts, and fittings required for a complete assembly including end caps for all members.
- D. The design of each individual framing system shall be the responsibility of the Contractor. Shop drawings, as specified above shall be submitted and shall show all details of the installation, including dimensions and types of supports. In all instances the completed frame shall be adequately braced to provide a complete rigid structure when all the piping has been attached.
- E. Any required pipe supports for which the supports specified in this Section are not applicable shall be fabricated or constructed from standard structural steel shapes in accordance with AISC Specifications, have anchor hardware similar to items previously specified herein, shall meet the minimum requirements listed below and be subject to the approval of the engineer.
  - 1. Pipe support systems shall meet all requirements of this Section and all related Sections of the Specification.
  - 2. Complete design details of the entire pipe support systems shall be provided, for review by the engineer.
  - 3. The pipe support system shall not impose loads on the supporting structures in excess of the loads for which the supporting structure is designed.

## 2.09 SURFACE PREPARATION AND SHOP PAINTING

- A. All surfaces shall be prepared and shop painted as part of the work of this Section. Surface preparation and shop painting shall be as specified in Section 09900.

## PART 3 - EXECUTION

### 3.01 DELIVERY AND STORAGE

- A. All supports and hangers shall be crated, delivered and uncrated so as to protect against any damage.
- B. All parts shall be properly protected so that no damage or deterioration shall occur during a prolonged delay from the time of shipment until installation is completed.
- C. Finished iron or steel surfaces not galvanized or painted shall be properly protected to prevent rust and corrosion.

### 3.02 INSTALLATION

- A. All pipes, horizontal and vertical, requiring rigid support shall be supported from the building structure by approved methods. Supports shall be provided at changes in direction and elsewhere as shown in the Drawings or specific herein. No piping shall be supported from metal stairs, ladders and walkways unless specifically directed or authorized by the engineer.
- B. All pipe supports shall be designed with liberal strength and stiffness to support the respective pipes under the maximum combination of peak loading conditions to include pipe weight, liquid weight, liquid movement, and pressure forces; thermal expansion and contraction; vibrations; and all probable externally applied forces. Prior to installation, all pipe supports shall be approved by the engineer.
- C. Where additional structural members are required, they shall be designed for the specific loads they are to support in accordance with the requirements of Rhode Island Building Code.
- D. Pipe supports shall be provided to minimize lateral forces through valves, both sides of split type couplings and sleeve type couplings, and to minimize all pipe forces on pump housings. Pump housings shall not be utilized to support connection pipes.

**CERTIFICATE OF DESIGN FOR PIPE SUPPORTS (OTHER THAN AERATION SYSTEM PIPING)**

\_\_\_\_\_  
(Owner)

Contract Reference: \_\_\_\_\_

\_\_\_\_\_

\_\_\_\_\_, dated \_\_\_\_\_.

In accordance with the provisions of the above referenced Contract, as the designated Contractor, \_\_\_\_\_

\_\_\_\_\_  
(Contractor's Name and Address)

hereby certifies that \_\_\_\_\_

\_\_\_\_\_  
(Contractor's Name and Address)

- (1) Is properly licensed and currently registered as a Professional Engineer in the State (or Commonwealth) of \_\_\_\_\_;
- (2) Is fully qualified to design and supervise the \_\_\_\_\_

\_\_\_\_\_  
(Item of work and location)

In accordance with the provision specified under the appropriate Section and/or Subsections of the Contract Documents:

- (3) Has successfully designed and supervised \_\_\_\_\_

\_\_\_\_\_  
(Item of work)

before and demonstrates a minimum of ten (10) documented years of proven experience in such field;

- (4) Has personally examined the type(s) and locations(s) of the Work required under this Contract, and the overall conditions associated therewith, to the extent necessary to fully satisfy his or her professional responsibilities for designing and supervising the above referenced work;

- (5) Has prepared the attached design in full compliance with the applications and requirements of the Contract Documents, sound engineering practice, modern accepted principles of construction, and all applicable federal, state and local laws, regulations, rules and codes having jurisdiction over the Work;
- (6) Will provide sufficient supervision and technical guidance to the Contractor throughout the Work to ensure compliance with the design and all quality assurances necessary to successfully complete the Work;
- (7) Hereby indemnifies and holds harmless the \_\_\_\_\_

\_\_\_\_\_ and BETA Engineering, Inc.,  
 \_\_\_\_\_  
 (name of owner)

and their agents, employees and representatives, from and against any and all claims, whether directly or indirectly, arising out of, relating to or in connection with the Work; and

- (8) This "Certificate of Design" together with all applicable designs, drawings, details, specifications on other related documents necessary to complete the Work as specified, have been signed and sealed pursuant to applicable state law.

In recognition and observance of the above referenced statements, the undersigned parties hereby acknowledge and accept the responsibilities and obligations associated therewith.

CONTRACTOR:CONTRACTOR'S ENGINEER

\_\_\_\_\_  
 (Contractor's Name)

\_\_\_\_\_  
 (Engineer's Name)

\_\_\_\_\_

\_\_\_\_\_

By: \_\_\_\_\_

By: \_\_\_\_\_

\_\_\_\_\_  
 (Name and Title)

\_\_\_\_\_  
 (Name and Title)

Date: \_\_\_\_\_  
 (SEAL)

Date: \_\_\_\_\_  
 (P.E. STAMP)

(Note: Contractor to fully reference all attachments below)

---

---

---

---

---

---

---

END OF SECTION



## SECTION 15066

### STAINLESS STEEL PIPE AND FITTINGS

#### PART 1 - GENERAL

##### 1.01 RELATED DOCUMENTS

- A. Drawings and Division 1 Specification Sections apply to this section.
- B. Items in this Specification are subject to the American Iron and Steel requirements of P.L. 113-76, the Consolidated Appropriations Act of 2014.**

##### 1.02 SUMMARY

- A. Furnish, install, test and place into satisfactory operating condition, stainless steel piping, including supports and appurtenances, as indicated and specified.
- B. Related Sections: The following contain requirements that relate to this section:
  - 1. Section 02200 – Earth Excavation, Backfill, Fill, and Grading
  - 2. Section 11378 – Single Stage Centrifugal Air Blowers
  - 3. Section 11316 – Hyperboloid Mixer Aerators

##### 1.03 SUBMITTALS

- A. Shop Drawings: Submit the following in accordance with Section 01300 – Submittals:
  - 1. Pipe layouts in full detail.
  - 2. Large scale details of wall penetrations or special fittings.
  - 3. Schedules of pipe, fittings, expansion joints and other appurtenances.
  - 4. Detailed designs of pipe supports and anchorages. Submit calculations for record only.
  - 5. Certificate of Design for Aeration Pipe Support System (see end of this specification section).
  - 6. Certificates: Sworn certificates in duplicate showing compliance with material used and shop tests performed with appropriate standard.
  - 7. Catalog cuts and technical data for expansion joints, couplings, gaskets, pipe supports and other accessories.

8. Submit reports as required for welding certifications per ANSI B31.1 paragraph 127.6.

#### 1.04 QUALITY ASSURANCE

- A. Provide manufacturer's certification that materials meet or exceed minimum requirements as specified.
- B. Welder Qualifications: Quality and certify welding procedures, welders, and operators in accordance with ANSI B31.1, paragraph 127.5 for shop and project site welding of piping work.
- C. Coordinate dimensions and drillings of flanges with flanges for valves and other equipment to be installed in the piping systems. Coordinate locations for installation of weld-o-let type fittings with locations of air flowmeters and other indicating devices shown on the drawings.

### PART 2 - PRODUCTS

#### 2.01 STAINLESS STEEL PIPE

- A. Manufacturers:
  1. Douglas Brothers, Portland, ME.
  2. Felker Brothers, Marshfield, WI.
  3. BRISMET, Bristol, TN.
  4. Or acceptable equivalent.
- B. Material:
  1. Type 304L sheet and plate per ASTM 240.
  2. Maximum carbon content of 304L material limited to 0.03 percent.
  3. Finish: 2D. No. 1 HRAP per ASTM A480, or better and as allowed by product ASTM specifications.
- C. Fabrication:
  1. Fabricate in accordance with ASTM A778 in NPS sizes shown with dimensional tolerances per ASTM A530.
  2. Perform welding by qualified welders conforming to standard procedures. Weld piping with wall thickness up to 11 gauge (0.125-in.) with the TIG (GTAW) process. Properly bevel heavier walls and use a root pass with the TIG (GTAW) process followed by subsequent passes with the TIG (GTAW), MIG (GMAW), or Metallic Arc (SMAW) process.

3. Add filler wire of ELC grades to all welds to provide a cross section at the weld equal to or greater than the parent metal. Distribute smooth and evenly weld deposit and provide a crown of no more than 1/16 inch on the I.D. and 3/32 inch on the O.D. of the piping.
4. Concavity, undercut, cracks or crevices are not acceptable.
5. Butt Welds: Full penetration to the interior surface, with inert gas shielding provided to the interior and exterior of the joint.
6. Remove excessive weld deposits, slag, spatter, and projections by grinding.
7. Continuously weld angle face rings on both sides to the pipe or fitting.
8. Grind all welds on gasket surfaces smooth.
9. Contour pipe branches, taps and bosses to the radius of the main pipe run and bevel and weld with full penetration. No projections to the inside of the branch or main run are acceptable. Provide a smooth transition from ID of run to ID of branch.
10. Wire-brush outside weld area with brushes of stainless steel that are specifically designed for use only on stainless steel.
11. After manufacture, passivate stainless steel pipe, fittings, and appurtenances by immersion in a pickling solution of 6 percent nitric acid and 3 percent hydrofluoric acid. Temperature and detention time to be sufficient for removal of oxidation and ferrous contamination without more than superficial etch of surface. Perform a neutralizing operation by a clean water spray wash.
12. After fabrication, scrub welds with stainless steel wire brushes to remove weld discoloration and then wash clean.
13. Welding done in shop. Field welding not permitted.
14. Fittings: Butt weld type manufactured in accordance with ASTM-A-774 of the same raw material and in the same thicknesses as the pipe.
  - a. Elbows: Provide smooth flow, die formed, long radius; with centerline to end of elbow equal to 1.5 times the nominal pipe size.
15. Fabricate tees and branch connections true and square with wall thickness same as pipe.
16. Reducers evenly tapered with tangent ends for butt weld connection.
  - a. Reducers may be straight tapered cone construction.
17. Secure flanges to pipe ends and openings plugged before shipment.

D. Design:

1. Stainless steel pipe to be nominal pipe size diameter pipe fabricated of stainless steel sheets having the following schedule and plate thickness:

Nominal Pipe Size (Inches)	Actual O.D. (Inches)	Schedule	Nominal Wall Thickness (Inches)
4	4.500	10S	0.120
8	8.675	10S	0.148
10	10.750	10S	0.165
12	12.750	10S	0.180
14	14.000	10S	0.188
16	16.000	10S	0.188
18	18.000	10S	0.188
20	20.000	10S	0.218
24	24.000	10S	0.250
30	30.000	10S	0.312

2. Joints: Field joints for plain end pipe sections shall be made by sleeve type couplings as indicated. Sleeve type couplings shall be shouldered-type or 'Fixed x Expansion' (FxE) couplings by Victaulic. Split couplings requiring cut or roll grooving of the pipe will not be allowed unless specifically called for. Connections at valves shall be flanged.
3. Flanged joints of the Van Stone back-up flange type using 150 lb. ANSI B16.1 forged steel, carbon steel or ductile iron back-up flanges with hot-dipped galvanized finish having the following thicknesses:

Flange Size (Inches)	Thickness (Inches)
3 and 4	3/8
6 and 8	1/2
10 to 14	5/8
16 to 20	3/4
24 to 30	1

4. Fabricate flanged joint face rings fabricated of rolled stainless steel angles.

5. Use angle face rings with thickness equal to or greater than the wall of the pipe or fitting to which it is welded. Continuously weld on both sides to the pipe or fitting. Fabricate angle legs so as not to interfere with the flange bolt holes.

## 2.02 SHOULDERED COUPLINGS

### A. General

1. Couplings for joining pipe in a piping system where positive longitudinal locking action is required.
2. Couplings shall consist of four basic components: a one-piece housing, gasket assembly, bolts and nuts, and end rings for pipe restraint. Couplings shall be as manufactured by Victaulic to meet the system design requirements as indicated on the drawings.

### B. Housing

1. The housing shall be of a specific cross section, four inches wide, curved to close around pipe ends that are smooth and free of defects.
2. The housing shall be sized so that the inside diameter fits the outside diameter of the stainless steel pipe. The coupling thickness shall be sufficient to handle the service loads and prevent the pipe ends from separating and shall be not less than 0.120”.
3. As the coupling housing closes, it compresses the elastomeric gasket to create the seal and the closure plates close over the integral sealing plate to maintain the radial seal.
4. The integral shoulders of the coupling provide full circumferential bearing against the end rings welded to the stainless steel pipe. The integral shoulders and the end ring weld to the stainless steel pipe ends shall be sized properly to ensure total joint restraint to prevent any pipe axial movement.
5. Bolts and nuts as specified secure the closure plates.

### C. Gaskets

1. The gasket is a one-piece cross section designed to straddle the pipe joint, protect the inside of the coupling, and seal the joint when the coupling is closed properly over the gasket and joint. Internal pressure is not required to effect the joint seal.

### D. Materials

1. Housing and closure plates shall be manufactured from stainless steel conforming to ASTM A240 type 304.
2. Integral sealing plate shall be manufactured from ASTM A240 type 316L stainless steel.

3. Gaskets supplied shall be silicone for air service in the Blower Building and EPDM rubber for all other air service within the temperature range of -40 to 280 degrees F. Sealing Pad material shall be silicone. Gasket material shall meet or exceed the appropriate requirements of ASTM D2000.
4. Bolts and nuts shall be stainless steel conforming to the requirements of ASTM A276 type 304 with a minimum tensile strength of 75,000 psi.
5. End rings shall be welded to each stainless steel pipe end and shall meet the requirements of ASTM A276 type 316L.
6. Cleaning and descaling of stainless steel couplings shall conform to ASTM A380. Completed couplings shall be free of any carbon steel contamination.

## 2.03 F x E EXPANSION COUPLINGS

### A. General

1. Couplings for joining stainless steel pipe in a piping system where axial movement due to thermal expansion and contraction is required. Couplings shall be bolted, split-sleeve type and consist of four basic components: a one-piece housing, gasket assembly, bolts and nuts, and end rings as required to hold the coupling in place.
2. The couplings shall be Depend-O-Lok (D-O-L) Fixed x Expansion (F x E) Couplings as manufactured by Victaulic to meet the system design requirements as indicated on the drawings.

### B. Housing

1. The housing shall be one-piece with a double arch cross section that closes around one stainless steel pipe end that is smooth for expansion or contraction requirements and one stainless steel pipe end with stainless steel end ring(s) affixed to hold the coupling in place.
2. The housing shall be sized so that the inside diameter fits the outside diameter of the stainless steel pipe. The wall thickness shall be sufficient to handle the service loads and be a minimum of 0.120". Ten inch (10") wide type 1 housing shall provide for a minimum expansion/contraction of 1-1/2" and the twelve inch (12") wide type 2 housing shall provide for a minimum expansion/contraction of 2". The width provided shall be as indicated on the drawings.
3. As the coupling closes, it confines the elastomeric gaskets beneath the arches of the sleeve to create the radial seal. The axial seal is created by the sealing pad at the closure plates as the bolts pull the coupling snug around the pipe ends.
4. The integral shoulder of the coupling provide full circumferential

bearing against the end ring(s) welded to the stainless steel pipe end and provide for sliding on the stainless steel slip pipe.

5. Bolts and nuts as specified secure the closure plates.

C. Gaskets

1. The sealing members are comprised of two O-Ring gaskets and an elastomer-sealing pad bonded to the integral sealing plate. Internal pressure is not required to create the seal.

D. Materials

1. Housing and closure plates shall be manufactured from stainless steel conforming to ASTM A240 type 304.
2. Integral sealing plates shall be manufactured from ASTM A240 type 316L stainless steel.
3. "O" ring gaskets for air service in the Blower Building and all of the sealing pads shall be silicone. "O" ring gaskets for all other air service shall be EPDM rubber for air service within the temperature range of -40 to 280 degrees F. Gasket material shall meet or exceed the appropriate requirements of ASTM D2000.
4. Bolts and nuts shall conform to the requirements of ASTM A276 with a minimum tensile strength of 75,000 psi.
5. The end ring(s) shall be welded to the fixed side of stainless steel pipe and shall meet the requirements of ASTM A276 type 316L stainless steel. D-O-L F x E type 1 Expansion couplings require one end ring on the fixed stainless steel pipe end. D-O-L F x E type 2 Expansion couplings require two end rings on the fixed stainless steel pipe end. Provide type 1 or type 2 D-O-L F x E Expansion couplings with the corresponding stainless steel pipe end preparation as detailed on the drawings.
6. Cleaning and descaling of stainless steel couplings shall conform to ASTM A380. Completed couplings shall be free of any carbon steel contamination.
7. Slip pipe ends that are carbon steel or ductile iron pipe shall be clad with 12 gauge stainless steel conforming to ASTM A240 type 304.

## 2.04 BELLOWS TYPE EXPANSION JOINTS

A. General

1. Expansion joints for joining stainless steel pipe in a piping system where axial movement due to thermal expansion and contraction, angular deflection and lateral offset is required.
2. Expansion joints shall consist of three major components: expansion bellows designed for the specified expansion/contraction and lateral offset; bellows end preparation; and end connection of the expansion joint to the stainless steel pipe.

3. All expansion joints shall be selected and installed in accordance with manufacturers' recommendations.
- B. Expansion Bellows
1. The expansion bellows shall be produced from fully annealed stainless steel sheet stock, rolled into a tube, seam welded and formed into corrugations.
- C. Bellows End Preparation
1. The expansion bellows shall have ends prepared for the end conditions called for on the drawings.
- D. End Condition
1. Ends of expansion bellows shall be prepared for Shouldered Couplings or flanges as required.
- E. Anchors
1. Anchors or tie rods, where called for, are used to protect the expansion joint against excessive expansion and contraction forces, and shall be installed in accordance with the manufacturers' recommendation.
- F. Materials
1. Bellows shall be manufactured from stainless steel meeting ASTM A240 type 321.
  2. Bellows end preparation shall be stainless steel pipe ends conforming to ASTM A240 type 304 and shall be welded to the integral end of the bellows. Ends to be prepared for the specified end condition.
  3. End rings shall meet the requirements of ASTM A276 type 316L stainless steel.

## 2.05 PIPE SUPPORTS

- A. General:
1. Provide a complete system of pipe supports, guides and anchors complete with necessary inserts, bolts, nuts, restraining and hanger rods, washers, miscellaneous steel and other accessories.
  2. Pipe supports shall support stainless steel pipe in a piping system where axial movement due to thermal expansion and contraction is required.
  3. Fixed supports shall be utilized where necessary to resist pipe movement and sliding supports shall be installed where necessary to allow for pipeline movement.
  4. Supports, guides and anchors located as required by MSS-SP69.



5. Fabricate supports, guides and anchors in accordance with MSS-SP58.
- B. Anchors
1. Pipe supports shall be bolted to structures in accordance with the pipe support engineer's design. There shall be no field welding of stainless steel pipe joints or of the stainless steel supports to the stainless steel pipe.
- C. Materials
1. Supports shall be manufactured from stainless steel meeting the requirements of ASTM A240 type 304.
  2. Anchor bolts shall be type 316 stainless steel epoxy doweled type by Hilti or equal.

## 2.06 SHOP PAINTING

- A. Carbon steel, forged steel or ductile iron flanges and pipe support components shall be shop and finish coated.

## PART 3 - EXECUTION

### 3.01 INSTALLATION OF PIPE

- A. Install pipelines parallel to building walls wherever possible. Install piping to accurate lines and grades, adequately supported. Where temporary supports are used, ensure rigidity to prevent shifting or distortion of pipe. Provide for expansion where necessary.
- B. Pitch piping toward low points. Provide for draining low points.
- C. Before assembly, remove dirt and chips from inside pipe and fittings.
- D. Make flanged joints with bolts; bolt studs with nut on each end; or studs with nuts where one flange is tapped. Except as otherwise specified, number and size of bolts conforming to same ANSI standard as flanges. Grade B bolts and nuts conforming to ASTM A307. Bolt studs and nuts of same quality as machine bolts. Ring gaskets of rubber with cloth insertion, 1/16-in. thick gaskets. Before flanges pieces are assembled, remove rust resistant coating from machined surfaces, clean gaskets and smooth all burrs and other defects. Make up flanged joints tight, care being taken to prevent undue strain upon valves or other pieces of equipment.
- E. Install fixed pipe supports, pipe clamps or bridles when sleeve type couplings or fittings are used in piping system where indicated, and at changes in direction or other places as necessary, to prevent joints from pulling apart under pressure. Bridles and tie rods at least 3/4-in. in diameter,

expect where tie rods replace flange bolts of smaller size, in which case fit with nut on each side of pair of flanges.

### 3.02 INSTALLATION OF PIPE HANGERS AND SUPPORTS

- A. Where hanger location is not shown:
  - 1. Install hanger at each change of direction.
  - 2. Install additional hangers at concentrated loads.
  - 3. Hanger spacing in horizontal runs not to exceed 8 ft.
- B. Install supports to allow controlled movement of piping systems. Permit freedom of movement between pipe anchors, and facilitate action of expansion joints, expansion loops, expansion bends, and similar units.
- C. Support piping on trapeze hangers on rollers.
- D. Prevent contact between dissimilar metals. Where a concrete or metal pipe support is used, place a 1/8 in. thick Teflon, neoprene rubber, or plastic strip under piping at point of bearing. Cut to fit entire area of contact between pipe and support.
- E. Apply anti-seize compound to nuts and bolts.
- F. Support piping from structural framing, unless otherwise noted.
- G. Concrete Inserts:
  - 1. Locate inserts so that total load on insert does not exceed manufacturer's recommended maximum load. Location of inserts to be approved by Engineer.
  - 2. Where it is necessary to anchor supports to hardened concrete or completed masonry, use Type 316 stainless steel epoxy doweled anchor bolts.
- H. Do not support piping from other piping.
- I. Provide a minimum of two pipe supports for each pipe run.
- J. Where piping connects to equipment, support by a pipe support and not by equipment, unless approved by equipment manufacturer.
- K. Unless otherwise shown or authorized by Engineer, place piping running parallel to walls approximately 1-1/2 in. out from face of wall and at least 3 in. below ceiling.
- L. Provide adjustable pedestal pipe supports with stanchion, saddle, and anchoring flange.
- M. Support piping in a manner that will prevent undue strain on valves, fittings, or equipment. Provide pipe supports at changes in direction or elevation, adjacent to flexible couplings, adjacent to non-rigid joints, and where otherwise shown. Do not install pipe supports and hangers in equipment access areas.

### 3.03 FIELD TESTING

- A. Clean of dirt, dust, oil, grease and other foreign material, before pressure and leakage tests.

- B. Pressure and Leakage Tests:
1. Conduct combined pressure and leakage test in pipelines.
  2. Furnish and install temporary testing plugs or caps; pressure pumps, pipe connections, meters, gages, equipment, and labor.
  3. Test when desired and comply with Engineer's orders and specifications.
  4. Fill section of pipe with air and increase pressure to test pressure of 25 psi.
  5. Pressure and leakage test consists of first raising water pressure (based on elevation of lowest point of section under test and corrected to gage location) to pressure in psi numerically equal to test pressures as shown on the drawings.
  6. No visible leakage in joints.
  7. If unable to achieve and maintain specified pressure for one hour with no additional pumping, section failed to pass test.
  8. If section fails pressure and leakage test, locate, uncover, and repair or replace defective pipe, fitting, or joint, at no additional expense and without time extension. Conduct additional tests and repairs until section passes test.
  9. Modifications to test procedure only if permitted by Engineer.

END OF SECTION

## SECTION 15100

### ABOVE GROUND FUEL STORAGE SYSTEMS

#### PART 1 - GENERAL

##### 1.01 GENERAL

- A. The General Requirements apply to this Section and applicable parts thereof shall be included in the work.
- B. Refer to all Drawings and other Sections of these Specifications to determine the type and extent of work therein affecting the work of this Section whether or not such work is specifically mentioned herein.
- C. Tank systems shall be installed in strict accordance with manufacturers printed recommendations, local and state building code and as specified herein.

##### 1.02 WORK INCLUDED

- A. Installation of two (2) 10,000-gallon aboveground No. 2 fuel oil storage tanks. The tank shall also be fitted with fuel supply and return systems to serve existing oil-fired boilers.
- B. Miscellaneous piping, valves, fittings, pumps, instrumentation, control wiring and accessories for fully operational fuel systems.
- C. Start-up and testing of the completed systems to demonstrate and confirm operational acceptance.

##### 1.03 RELATED SECTIONS

- A. Division 1 – General Requirements
- B. Section 01735 - Services of Manufacturer's Representative
- C. Section 09900 - Painting
- D. Section 13320 – Operating and Monitoring Control System
- E. Section 13321 – Instrumentation and Control System
- F. Section 15060 - Pipe Hangers and Supports
- G. Section 15400 – Plumbing
- H. Section 15500 – HVAC - 2

##### 1.04 SUBMITTALS

- A. The Contractor shall prepare and submit detailed shop drawings for the above ground tank foundation slabs showing dimensions, reinforcing steel details, steel placement, etc.

- B. The Contractor shall prepare and submit shop drawings for the aboveground tanks and shall prepare and submit detailed erection drawings showing installation of the tank on the concrete foundation slab. Piping system layout shall be included in the submittal.

## 1.05 QUALIFICATIONS

- A. The Contractor shall provide data proving experience on at least three prior projects, which include types of activities similar to those in this project. Provide project titles, dates of projects, owners of projects, point of contact for each project, and telephone numbers of each point of contact.

## PART 2 - PRODUCTS

### 2.01 ABOVEGROUND STORAGE TANK SYSTEMS

- A. The fuel storage tanks shall be horizontal aboveground concrete vaulted units, designed and tested in strict accordance with UL 2085. The UL 2085 listing for insulated secondary containment aboveground tanks for flammable liquids shall encompass both fire-protected and fire-resistant approvals. The tank systems shall meet all local, state, and federal codes pertaining to aboveground storage of flammable and combustible liquids including NFPA 30 and 30A and the Uniform Fire Code 79-7. The storage tanks shall be delivered to the job site ready to use, requiring no additional construction activity. Only electrical and mechanical connections shall be required. Grounding of the concrete vaulted containment system shall be in strict accordance with local and state codes.
- B. The aboveground storage tank systems shall be 10,000 gallon by ConVault, or approved equal.
- C. Tank Construction
  1. Primary Tank: The primary tank shall be rectangular in shape, constructed with a minimum of 3/16-inch thick carbon steel, listed per U.L. Standard 142, and meet the requirements of NFPA 30. Welds shall be continuous on all sides conforming to the American Welding Society standard for continuous welds.
  2. Thermal and Corrosion Protection: The tank construction shall include thermal insulation equivalent to 0.25 inches of polystyrene to protect against temperature extremes, and to protect against corrosion by isolating the steel tank from the concrete. All exposed steel used to manufacture tank shall be powder coated.
  3. Secondary Containment with Leak Monitoring: The tank system shall include an impervious barrier of 30 mil high density polyethylene to contain leaks from the primary tank. A leak detection access tube shall be located between the inner tank and secondary barrier. A tank gauging system shall be provided which includes a clock type level gauge by Morrison Brothers 818C series drop tube or equivalent with reading in gallons suitable for top mounting.
  4. Concrete Encasement: The exterior shall consist of 6-inch-thick concrete encasement with a minimum design strength of 4000 psi. The concrete design

shall include the following for long term durability: less than 3% air entrainment, water-reducing admixture, fiber mesh reinforcement, and rebar reinforcement. The steel tank shall be pressurized at the factory by air pressure at 5 psi during concrete encasement to provide long term crack resistance. Vault enclosure shall have concrete support legs of unitized monolithic construction raising the vault a minimum of 6" above the ground to meet visual inspection requirements. Cold joint or other joint construction which could compromise the liquid tightness of the vault is not permitted.

5. Exterior Finish: The tank finish shall be exposed aggregate with two-part weather resistant coating. Tank shall be marked on all sides as per State and local codes. Signs will be manufactured using plastic injection process with U.V. stabilized plastic and hot stamp paint designed to last the life of the tank. Signs shall be recessed in concrete exterior to insure against damage during offloading, refueling or general functions.
6. Spill Containment Basin: The tank system shall include a U.L. listed 7-gallon spill/overflow container manufactured as an integral part of the primary tank, surrounding the fill pipe, and protected by the two hour fire rating of the concrete. The fill pipe shall be recessed into the container so that it is the lowest opening on the tank. The spill/overflow container shall include a normally closed manual drain valve and plunger assembly to release spilled product into the primary tank.
7. Overflow Protection: Overflow protection shall be provided by both of these methods:
  - a. Direct reading level gauge visible from the fill pipe access. Gauge shall be equal to Morrison 818C series with drop tube.
  - b. Overflow limiting valve rated for pressurized delivery located within fill pipe to close automatically at 90% full level. Valve shall be equal to Preferred Utilities Model 61F.
8. Pre-Cast Concrete Pad: Provide a pre-cast reinforced concrete pad to protect the tank against stresses from uneven settlement, and to assure that the tank supports allow for inspection beneath the tank. The pad dimensions shall be as shown on the drawings. The minimum thickness shall be 8 inches. The concrete strength shall be 3,000 psi. The Contractor will be responsible for the preparation of the tanks pad subgrade, which shall consist of undisturbed earth or compacted fill, free of organic material.
9. Access Platform: Provide manufacturer's standard galvanized stairs and platform package with the 10,000-gallon tanks. Standard hand railings shall be included with the package.
10. Tank Signage: Each fuel tank shall be marked with a permanent sign on the side closest to the fill pipe, indicating the capacity of the tank in gallons and type of fuel in the tank. Provide warning signs including NFPA 'diamond' in accordance with NFPA 704-96 and NFPA 49-94, and product identification signs as code required.

11. Remote Level Monitoring and Alarms: Tank systems shall be provided with continuous liquid level monitoring devices with 4-20 mA output for inventory control. Devices shall also be provided for each tank to transmit high and low liquid level alarms, and leak detection alarms. Devices shall be suitable for installation in accordance with NEC hazardous atmosphere requirements.
12. Appurtenances: Tank systems shall be provided with a 2-inch pressure/vacuum vent mounted a minimum of 12-feet above the ground surface and 8-inch primary and emergency vents, as manufactured by Clay & Bailey, in accordance with local jurisdictions and with NFPA 30 and 30A. Vent relief pressure shall be set at 1 psi.

#### 2.04 FUEL PIPING SYSTEM

- A. Primary supply and return piping between the 10,000-gallon No. 2 fuel oil AST and the existing boilers shall be flexible and run in continuous lengths from the transition sump to the boiler system. Primary piping and related fittings shall be of the size shown on the drawings and shall be APT XP-100-D or XP-150-D as noted on plans or approved equal.
- B. **All primary piping run underground shall be run in secondary containment piping.** Secondary containment piping shall be flexible pipe run in continuous. Secondary piping and related fittings shall be APT XP-200-SC or approved equal.
- C. Transition sump shall have 57 by 57 inch length by width and an overall height of 60 inches. The cover shall be designed so to direct water away from the unit. Transition sumps shall be Model B855 as manufactured by S. Bravo, or approved equal.
- D. All containment piping between the tank assembly and transition sump shall be adequately supported (both horizontally and vertically), as required and approved by the engineer. All penetrations to existing structures shall be properly sealed, producing a watertight, weatherproof installation.
- E. Anti-siphon valves shall be installed at the high point on the supply line. Valve shall be suitable for use with No. 2 fuel oil and be of the size stipulated in the contract drawings. Valves shall be of bronze construction with dash pot for noiseless operation and be suitable for outdoor installation, as manufactured by Preferred Utilities Manufacturing Corporation, Type A, or approved equal.
- F. An Oil Lever Gate Valve with a fusible link shall be installed in the building at the point where the fuel oil supply pipe enters the space. Valve shall be equal to Preferred Utilities Model 110.
- G. Shutoff valves shall be furnished and installed as shown on the plans and at the discharge of each submersible pump and on the supply pipe at the entrance of each building downstream of the Oil Lever Gate Valve. Shutoff valves shall be equal to Milwaukee Valve BA-475B series two piece full port valves, 600 WOG rating, UL listed, with blowout proof stem.

#### 2.05 SUBMERSIBLE FUEL PUMP

- A. Two submersible pumps – one service and one backup - shall be furnished and installed at each above ground storage tank. Pumps shall be submersible turbine type

equal to Red Jacket Alcohol Gas STP model, 4-inch diameter with a  $\frac{3}{4}$  horsepower 480 VAC 3 phase motor. Pumps shall be suitable to operate in a Class 1 Group D atmosphere.

- B. One submersible pump shall start and run upon a call for heat from the boiler burner. When the boiler burner stops, the submersible pump shall stop.
- C. A pump controller equal to Red Jacket Isotrol 1-6 shall be furnished, installed and wired for each pump.

## 2.06 LEVEL GAUGING, LEAK DETECTION AND ALARM SYSTEM

- A. Provide a system that will monitor and digitally display the product level in each storage tank. The system shall also monitor the high and low level in the storage tanks, alarm on high or low level and monitor the storage tanks' interstitial spaces for leaks. Provide a separate system for each storage tank. The No. 2 fuel oil tank systems shall provide the ability to disable the fuel dispensing system when the level in the tank is drawn down to a pre-set level.
- B. Provide the following system components for a complete and operational monitoring and alarm system.
  - 1. Provide a Level Indication and Alarm Panel suitable for wall mounting complete with, but not limited to:
    - a. Panel fabricated by a 508/698A UL recognized manufacturer
    - b. Digital display of tank level
    - c. Retransmission of 4-20 mA signal to Plant I&C System
    - d. Audible alarm buzzer for alarm conditions (overflow, high level, low level and leak detection)
    - e. Dry contact for wiring to SCADA system notification of low oil level in tank.
    - f. Buzzer silence button
    - g. Intrinsically safe alarm sensor circuitry
    - h. Visual indication of high level, low level and leak detection alarms
    - i. Contact closures for remote indication of alarms
    - j. Manually adjustable level setpoint for No. 2 fuel oil dispensing system disabling.
    - k. NEMA 4 enclosure
    - l. System shall be Preferred Utilities TG-EL-D4A or approved equal.
  - 2. Provide a wire float level sensor capable of continuous level detection, high-level indication and low-level indication. The level sensor shall be suitable for tank mounting and shall be complete with:
    - a. 1" MNPT aluminum fitting.
    - b. Rigid dual concentric probe with Teflon sheathed sensing element



- c. Suitable for connection to TG-ELD
  - d. Weather-proof housing
  - e. Factory precalibration
  - f. Intrinsically safe
  - g. Level sensor shall be Preferred Utilities Model WF-12 or approved equal.
3. Provide a leak sensor and sensor cap to detect product leaks into the interstitial spaces of the No. 2 fuel storage tank and the secondary containment pipe between the tank and the boiler at the transition sump. The leak detection systems shall be complete with:
- a. Preferred Utilities Model HD-A2-C or equivalent
  - b. Leak sensor suitable for detecting oil and water
  - d. Solid state detector with electro-optic technology
  - e. Integral cable

## 2.07 FUEL OIL CONTROL CENTER

- A. Provide a Fuel Oil Control Center (FOCC) mounted where indicated. FOCC shall be custom designed to accomplish the control strategy as outlined. To allow pump operation in the event of pump or pump control failure, provide hard wired safety interlocked Hand-Off-Auto manual switches for each pump. Provide safety interlocks to shut down both pumps in the event of leak detection at the tank, in the sump, or in the containment piping.
- B. The lead fuel pump shall be energized on a call for heat from the boiler. The pump shall continue to operate until the call for heat ends. Upon the next call for heat, the lead pump shall be automatically alternated. Upon failure of the lead pump (by loss of flow or pump motor overload) the lag pump shall be started, and the lead pump shall be deenergized. Flow switches shall be equal to model V6 by Industrial Fuel Systems LLC.

## PART 3 – EXECUTION

### 3.01 TANK INSTALLATION

- A. The tank systems including accessories shall be installed in strict accordance with the manufacturer's recommendations and applicable fire and environmental codes.
- B. Tanks shall be installed on reinforced concrete base slabs design to support the fully loaded tanks. Protective pipe bollards shall be installed where shown on the Drawings.

- C. The Contractor shall install the tanks, complete and operational, at the designated locations shown on the Contract Drawings and make all service connections including the No 2 fuel oil supply and return piping system.
- D. Remove debris and clean marks, dirt, or blemishes from all exposed sections.
- E. Field patch any chips or cracks. Field touch-up paint any chips, scratches and surface blemishes.
- F. The contractor shall be responsible for electrical and I&C system connection(s) to the storage tank systems, in accordance with all applicable local and state building code requirements and these specifications. The Contractor will be responsible to obtain all permits and applications.
- G. Tanks and vaults shall be shop-fabricated as single units at the factory and shall require no assembly, construction or completion at the installation site.
- H. Provide services of the Manufacturer's Representative in accordance with Specification Section 01735.

3.02 CONTRACT CLOSEOUT

- A. Provide in accordance with Section 01700.

END OF SECTION

## SECTION 15400

### PLUMBING

#### PART 1 GENERAL

##### 1.1 SCOPE

- A. The Work of this section includes all labor, tools, material, fittings, accessories and equipment necessary to provide plumbing system(s), complete and operable.
- B. Attention is directed to the DOCUMENT 00700, GENERAL CONDITIONS and all sections within DIVISION 1 – GENERAL REQUIREMENTS, which are hereby made a part of this section of the Specifications.
- C. The Work includes, without limiting the generality thereof:
  - 1. Water supply system
  - 2. Domestic cold water distribution system.
  - 3. Plumbing Fixtures.
  - 4. Floor Drain and Floor Sink repair and refurbishment where noted.
  - 5. Storm water drain piping.
  - 6. Roof drain replacements and new installation.
  - 7. Hose bibs.
  - 8. Sump pumps.
  - 9. Plumbing Demolition.

##### 1.2 SUBMITTALS

- A. Shop drawings, brochures and samples, as listed, shall be submitted for all items to be furnished in accordance with the provisions of DOCUMENT 01300, SUBMITTALS.
- B. Provide submittals for the following items consisting of manufacturer's published data. All submittals shall show compliance with the referenced specification.
  - 1. Water and drain piping and fittings
  - 2. Hangers and supports
  - 3. Sleeves and escutcheons
  - 4. Plumbing specialties

5. Valves
6. Plumbing Fixtures
7. Floor Drain and Floor Sink replacement grates
8. Stormwater piping and fittings
9. Roof drains
10. Cleanouts
11. Piping insulation
12. Sump pumps with wall bracket mounted float switches and control panels

### 1.3 RELATED WORK SPECIFIED ELSEWHERE

- A. SECTION 02220, EARTHWORK - Excavation, filling, sheeting, shoring, pumping, dewatering.
- B. SECTION 03300, CAST-IN-PLACE CONCRETE - for trench drains.
- C. SECTION 07002, ROOF AND FLASHING - for roof penetrations.
- D. SECTION 07841, PENETRATION FIRE STOPPING - for sleeves in floors and walls.
- E. SECTION 07920, JOINT SEALANTS – caulking for sleeves in floors and walls.
- F. SECTION 16120, WIRE AND CABLES - Power wiring.

### 1.4 ITEMS INSTALLED BUT NOT FURNISHED

- A. Install water meter as furnished by the Owner.

### 1.5 ITEM FURNISHED BUT NOT INSTALLED

- A. Furnish pipe sleeves for placement in concrete and masonry construction.

### 1.6 DESIGN CRITERIA

- A. The Work of this section shall comply with the requirements of the Massachusetts Uniform Plumbing Code (248 CMR) and of any other authorities having jurisdiction.
- B. The equipment covered by the Specifications is intended to be standard equipment of proven quality as manufactured by reputable concerns. Equipment shall be designed, constructed and installed in accordance with the best practice of the industry and shall operate satisfactorily when installed in accordance with the Contract Documents. The Specifications call attention to certain details, but do not purport to cover all details entering into the construction of the equipment.
- C. All material shall be new and shall bear the manufacturer's full identification.

D. Requirements of the Regulatory Agencies

1. The final, complete installation shall comply with all state and local statutory requirements having jurisdiction. Arrange for all necessary permits, pay all fees and arrange for all required inspections by local authorities. In general, all Work shall comply with the requirements of the rules, regulations, standards, codes, ordinances and laws of local, state and federal governments, and other authorities that have legal jurisdiction over the Project. Materials and equipment shall be manufactured, installed and tested as specified in latest editions of applicable publications, standards, rulings and determinations of:
  - a. Local and state building, plumbing, mechanical, electrical, fire and health department codes.
  - b. National Fire Protection Association (NFPA).
  - c. Occupational Safety and Health Act (OSHA).
  - d. Underwriter's Laboratories (UL).
  - e. Material and equipment shall be listed by Underwriter's Laboratories (UL) and approved by ASME and AGA for intended service.
2. When requirements cited in the Specifications conflict with each other or with Contract Documents, most stringent shall govern Work.
3. Most recent editions of applicable specifications and publications of the following organizations form part of Contract Documents:
  - a. American National Standards Institute (ANSI).
  - b. American Society of Mechanical Engineers (ASME).
  - c. National Electric Manufacturers Association (NEMA).
  - d. American Society for Testing and Materials (ASTM).
  - e. American Water Works Association (AWWA).
  - f. American Society for Heating, Refrigerating and Air Conditioning Engineers (ASHRAE).
  - g. American Society of Plumbing Engineers (ASPE).
  - h. Thermal Insulation Manufacturers Association (TIMA).
  - i. Institute of Electrical and Electronics Engineers (IEEE).
  - j. Insulated Cable Engineers Association (ICEA).

- k. Cast Iron Soil Pipe Institute (CISPI).
- l. Plumbing and Drainage Institute (PDI).
- m. National Association of Plumbing-Heating Cooling Sub-Contractors (NAPHCC).

#### 1.7 PRODUCT HANDLING

- A. All materials and equipment shall be shipped, stored, handled and installed in such manner as not to degrade quality, serviceability, or appearance.
- B. Store all materials and equipment on site in a location approved by the Engineer.
- C. Protect all Work, the Owner's property and the property of others from injury or loss caused by operations associated with the Work of this section. Make good any such injury or loss, at no cost to the party suffering the injury or loss.

#### 1.8 PROCEDURE

- A. Secure all permits, inspection, and approvals and pay all costs and fees.
- B. Unless the Specifications state "No Substitutions", substitutions will be considered for any specified item.
- C. Coordinate safety program with that of the Contractor. Cooperate with other trades to establish lines, levels, openings, chases, clearances, and locations to avoid interference, and to protect the Work.
- D. Deliver all materials as needed to avoid delaying any other contractor.
- E. Store all materials and equipment on the Project Site in a location approved by the Engineer.

#### 1.9 INTERPRETATION OF DRAWINGS

- A. Listing of Contract Drawings does not limit responsibility of determining full extent of Work required by Contract Documents. Refer to Architectural, Plumbing, Electrical, Structural and other Contract Drawings and other sections that indicate types of construction in which Work shall be installed and Work of other trades with which Work of this section must be coordinated.
- B. Except where modified by a specific notation to the contrary, it shall be understood that the indication and/or description of any item, in the Contract Drawings or Specifications or both, carries with it the instruction to provide the item, regardless of whether or not this instruction is explicitly stated as part of the indication or description.
- C. Item referred to in singular number in Contract Drawings shall be provided in quantities necessary to complete Work.
- D. Contract Drawings are diagrammatic. They are not intended to be absolutely precise; they

are not intended to specify or to show every offset, fitting and component. The purpose of the Contract Drawings is to indicate a systems concept, the main components of the system, and the approximate geometrical relationships, the Subcontractor shall provide all other components and materials necessary to make the systems fully complete and operational.

- E. Information and components shown on riser diagrams but not shown on the Contract Drawings and vice versa, shall be provided as if expressly required on both.
- F. Data that may be furnished electronically by the Engineer (on computer tape, diskette, or otherwise) is diagrammatic. Such electronically furnished information is subject to the same limitation of precision as heretofore described. If furnished, such data is for convenience and generalized reference, and shall not substitute for Engineer's sealed or stamped construction documents.

#### 1.10 DISCREPANCIES IN DOCUMENTS

- A. Where Contract Drawings or Specifications conflict or are unclear, advise the Engineer in writing before Award of Contract. Otherwise the Engineer interpretation of Contract Documents shall be final, and no additional compensation shall be permitted due to discrepancies or incongruities thus resolved.
- B. Where Contract Drawings or Specifications do not coincide with manufacturers' recommendations, or with applicable codes and standards, alert the Engineer in writing before installation. Otherwise, make changes in installed Work as the Engineer requires at no additional cost to the Owner.
- C. If the required material, installation or Work can be interpreted differently from drawing to drawing, or between Contract Drawings and Specifications, the Subcontractor shall provide that material, installation, or Work which is of the higher standard.
- D. Provide systems and components that are fully complete and operational and fully suitable for the intended use. There may be situations in the Contract Documents where insufficient information exists to precisely describe a certain component or subsystem, or the routing of a component. In cases such as this, where the Subcontractor has failed to notify the Engineer of the situation in accordance with the Specifications, the Subcontractor shall provide the specific component or subsystem with all parts necessary for the intended use, fully complete and operational, and installed in workmanlike manner either concealed or exposed per the design intent.
- E. In cases covered by the Contract Documents, where the Subcontractor needs engineering guidance, submit a sketch identifying the proposed solution to the Engineer for approval.

#### 1.11 MODIFICATIONS IN LAYOUT

- A. HVAC, Plumbing, and Electrical Drawings are diagrammatic. They indicate general arrangements of mechanical and electrical systems and other Work. They do not show all offsets required for coordination nor do they show the exact routings and locations needed to coordinate with structure and other trades and to meet Architectural requirements.
- B. In all spaces, prior to installation of visible material and equipment, including access panels, review Architectural Drawings for exact locations and where not definitely



indicated, request information from the Engineer.

- C. Check Contract Drawings as well as Shop Drawings of all trades to verify and coordinate spaces in which Work of this section will be installed.
- D. Maintain maximum headroom at all locations. All piping and associated components to be as tight to underside of structure as possible.
- E. Make reasonable modifications in layout and components needed to prevent conflict with Work of other trades and to coordinate as specified herein. Systems shall be run in a rectilinear fashion.
- F. Where conflicts or potential conflicts exist and engineering guidance is desired, submit sketch of proposed resolution to the Engineer for review and approval.

#### 1.12 RECORD DRAWINGS

- A. Refer to SECTION 01700, CONTRACT CLOSEOUT for record drawing requirements.
- B. As Work progresses and for duration of Contract, maintain complete and separate set of prints of Contract Drawings at Project Site at all times. Record Work completed and all changes from original Contract Drawings clearly and accurately including Work installed as a modification or addition to the original design.
- C. At Completion of Work prepare a complete set of reproducible record drawings.
- D. The Engineer will not certify the accuracy of the record drawings; this is the sole responsibility of the Contractor.
- E. Submit the record set for approval by the building department in a form acceptable to the department, when required by jurisdiction.
- F. Record drawings shall show record condition of details and corrections to schedules. Schedules shall show actual manufacturer and make and model numbers of final equipment installation.

#### 1.13 MATERIAL LIST

- A. Within 4 weeks of Award of Contract, the Subcontractor through the Contractor shall submit a "Plumbing Equipment and Material List".
- B. The list shall contain all categories of material required with names of intended manufacturers. The list does not replace submittals specified herein.

#### 1.14 WARRANTIES

- A. Submit manufacturer's standard replacement warranties for material and equipment furnished under this section. Such warranties shall be in addition to and not in lieu of all liabilities, which the manufacturer and the Subcontractor may have by law or by provisions of the Contract Documents.
- B. All materials, equipment and Work furnished under this section shall be guaranteed against

all defects in materials and workmanship for a minimum period of one year commencing with the Date of Substantial Completion. Any failure due to defective material, equipment or workmanship which may develop shall be corrected at no expense to the Owner including all damage to areas, materials and other systems resulting from such failures.

- C. Guarantee that all elements of each system meet the specified performance requirements as set forth herein or as indicated on the Contract Drawings.
- D. Upon receipt of notice from the Owner of the failure of any part of the systems during the guarantee period, the affected parts shall be replaced. Any equipment requiring excessive service shall be considered defective and shall be replaced.

#### 1.15 SURVEY AND MEASUREMENTS

- A. Base all required measurements, horizontal and vertical, from referenced points established by the Contractor and be responsible for correctly laying out the Work required under this section of the Specifications.
- B. In the event of discrepancy between actual measurements and those indicated, notify the Contractor, in writing, and do not proceed with the related Work until instructions have been issued.

#### 1.16 DELIVERY, STORAGE AND HANDLING

- A. Provide in accordance with Section 01600 MATERIALS AND EQUIPMENT.
- B. All manufactured materials shall be delivered to the Project Site in original packages or containers bearing the manufacturer's labels and product identification.
- C. Protect materials against dampness. Store off floors, under cover, and adequately protected from damage.
- D. Deliver products to the Project Site and store and protect same as recommended by the manufacturers'.
- E. Inspect all Plumbing equipment and materials, upon receipt at the Project Site, for damage and correctness.

#### 1.17 PROTECTION OF WORK AND PROPERTY

- A. Care and protect all Work included under this section until it has been tested and accepted.
- B. Protect all equipment and materials from damage from all causes including theft. All materials and equipment damaged or stolen shall be repaired or replaced with equal material or equipment.
- C. Protect all equipment, outlets and openings with temporary plugs, caps and covers. Protect work and materials of other trades from damage that might be caused by Work or workmen under this section and make good damage thus caused.

#### 1.18 SUPERVISION

- A. Supply the service of an experienced and competent supervisor who shall be in charge of the plumbing work at the Project Site.

#### 1.19 SAFETY PRECAUTIONS

- A. Comply with all of the safety requirements of OSHA throughout the entire construction period of the Project.
- B. Provide and maintain proper guards for prevention of accidents and any other necessary construction required to secure safety of life and/or property.

#### 1.20 SPARE PARTS

- A. Furnish spare parts data for each different item of equipment furnished. The data shall include a complete list of parts and supplies, with current unit prices and source of supply; a list of parts and supplies that are either normally furnished at no extra cost with the purchase of the equipment, or specified hereinafter to be furnished as part of the contract; and a list of additional items recommended by the manufacturer to assure efficient operation for a period of 180 days at the particular installation. The foregoing shall not relieve the Subcontractor of any responsibilities under the guarantees specified herein.

#### 1.21 HOISTING, SCAFFOLDING AND PLANKING

- A. The Work shall include the furnishing, set-up and maintenance of all derricks, hoisting machinery, scaffolds, staging, planking, ladders, etc. as required for the Work.

#### 1.22 SLEEVES, INSERTS, ANCHOR BOLTS, AND PLATES

- A. Be responsible for the location of and the maintaining in proper position all sleeves, inserts and anchor bolts supplied and/or set in place. In the event that failure to do so requires cutting and patching of finished work, it shall be done at this Subcontractor's expense without any additional cost to the Owner.

#### 1.23 SUPPLEMENTARY STEEL, CHANNELS AND SUPPORTS

- A. Provide all supplementary steel, channels and supports required for the proper installation, mounting and support of all plumbing equipment, piping, etc., required by the Specifications.
- B. Supplementary steel and channels shall be firmly connected to building construction in a manner approved by the Engineer. **All supplementary steel shall be 316 stainless.**
- C. The type and size of the supporting channels and supplementary steel shall be determined by the Sub-contractor and shall be of sufficient strength and size to allow only a minimum deflection in conformance with the manufacturer's requirements for loading.

#### 1.24 CERTIFICATES OF INSPECTION/APPROVAL

- A. Furnish upon completion of all Work, certificates of inspections from the manufacturers stating that authorized factory engineers have inspected and tested the operation of their respective equipment and found same to be in satisfactory operating conditions.

## 1.25 ACCESSIBILITY

- A. All Work shall be installed so that parts requiring inspection, operation, maintenance and repair are readily accessible. Minor deviations from the drawings may be made to accomplish this, but changes of substantial magnitude shall not be made prior to written approval from the Engineer.

## 1.26 DEFINITIONS

- A. As used in this section, the following terms are understood to have the following meanings:
  - 1. "Furnish" shall mean purchase and deliver to the project site, complete with every necessary accessory and support.
  - 2. "Install" shall mean unload at the delivery point at the site and perform all work necessary to establish secure mounting, proper location and operation in the project.
  - 3. "Provide" shall mean furnish and install.
  - 4. "Work" shall mean all labor, materials, equipment, apparatus, controls, accessories, and all other items required for a proper and complete installation.
  - 5. "Piping" shall mean, in addition to pipe or tubing, all fittings, flanges, unions, valves, strainers, drains, hangers and other accessories relative to such piping.
  - 6. "Concealed" shall mean hidden from sight in chases, furred spaces, shafts, embedded in construction or in crawl space.
  - 7. "Exposed" shall mean not installed underground or concealed as defined above.
  - 8. "Furnished by others" shall mean materials or equipment purchased and set in place under other sections of the general contract and connected to the systems covered by this section of the specifications by this trade contractor.
  - 9. "Coordinate" shall mean all work provided under this section of the specification shall be in compliance with work of other trades.

## PART 2 MATERIALS

### 2.1 DOMESTIC WATER SUPPLY PIPE AND FITTINGS

- A. Above floor piping shall be Type L copper tubing, ASTM B88, hard tempered, with wrought copper fittings and unions; joints shall be made up with 95/5 tin antimony solder and non-corrosive flux.
- B. Under ground and under slab piping (as applicable) shall be Type K copper tubing, soft annealed copper tubing with ANSI B16.18 or ASME B16.22 solder joint fittings. Provide minimum number of joints in buried copper tubing. Joints shall be brazed. Brazing filler metal shall conform to AWS A5.8, Type BAg-5 with AWS Type 3 flux, except Type BCuP-5 or BCuP-6 may be used for brazing copper-to-copper joints. Braze joint fittings

shall be specifically designed for brazing.

## 2.2 DRAIN WASTE VENT AND PUMPED DISCHARGE PIPE AND FITTINGS

- A. Below grade (as applicable) shall be service weight cast iron soil pipe and fittings, ASTM A74, coated with tar or asphaltum, resilient gasket joints.
- B. Above grade shall be service weight cast-iron with no hub joints, except piping two inch or smaller may be schedule 40 galvanized steel with 150 lb. galvanized malleable iron drainage fittings, or type DWV copper with wrought copper drainage fittings.
- C. Pumped discharge piping shall be schedule 40 galvanized steel with Class 125 galvanized cast iron fittings. Piping and fittings shall be joined by threaded connections.
- D. Cleanouts
  - 1. ANSI A112.36.2M; provide threaded bronze cleanout plugs.
  - 2. Floor Cleanouts
    - a. Provide cast-iron or ductile-iron floor cleanout with anchor flange, adjustable height polished bronze, nickel bronze, stainless steel, or chromium-plated copper alloy rim and scoriated floor plate with "CO" cast in the plate, and countersunk screws for installing floor plate flush with finished floor.

## 2.3 STORM DRAINAGE PIPING ABOVE FLOOR

- A. Piping shall be no-hub service weight cast iron soil pipe except at cleanouts and joints just prior to exiting the building which shall be service weight hub and spigot with lead and oakum joints.
- B. Couplings for joining no-hub cast iron soil pipe: Couplings shall have a shield constructed of corrugated 304 stainless steel and provide a shield thickness of 0.16 inches or greater. Shield shall be a minimum width of 3 inches for pipe sizes 1-1/2 inch through 4 inch, and a minimum width of 4 inches for pipe sizes 5 inch through 10 inches. Couplings with at least four (4) sealing bands shall require 80 inch pounds of torque per band. Tightening screws shall be 3/8 inch hexagon head. Couplings with only two (2) sealing bands on sizes 1-1/2 inch through 4 inches shall require 125 inch pound of torque per band. Gaskets shall be neoprene rubber conforming to ASTM C-564.

## 2.4 STORM DRAINAGE PIPING BELOW FLOOR (AS APPLICABLE)

- A. Piping below floor shall be service weight cast iron hub and spigot.
- B. Joints in cast iron soil piping below ground shall be code approved compression type, made with rubber gaskets conforming to ASTM Specification C564. Joints in cast iron soil pipe and fittings using a double seal, compression type molded neoprene gasket shall be provided with a modified hub as required to provide a positive seal. No-hub pipe will not be allowed below ground.

## 2.5 HANGERS AND SUPPORTS

- A. Pipe hangers shall conform to MSS SP 58 and SP 69. Pipe hangers for piping 4 inch and larger shall have rolls either of the Harvard type or 2 rod type. Pipe hangers for 3 inch pipe and under shall be clevis type. Pipe hangers for pipe less than 2 inch may be 1A band type in lieu of clevis type. Hangers in contact with copper tubing shall be copper plated.
- B. All hangers on insulated piping shall be sized to fit the outside of the covering. Provide spacer blocks and 16 gauge galvanized protection shields (12 inches long) at hangers, when pipe is installed.
- C. All hanger rods shall be hung from wood frame ceiling structure using wood screws designed for use with threaded rod adapters or through-bolted with double nuts and flat washers.
- D. Where support points are required to avoid other Work, provide a system of channels and angles between support points as required. Provide all necessary supports and cross framing. No part of piping, ductwork, equipment, and the building shall be stressed beyond its normal allowable working strength.

## 2.6 SLEEVES

- A. Sleeves shall be sized to allow 1/2 inch of annular space between the covering (or bare pipe) and the inside of the sleeve.
- B. Pipe penetrations through floors and exterior walls shall be sleeved and sealed using Thunderline Link-Seal wall sleeves and seals or approved equal.
- C. In other areas, pack the annular space with non-combustible (as defined by ASTM E136) fire stopping material, and seal with non-combustible caulking flush with finish surface.  
**NOTE: Owner shall engage special inspections of firestopping.**
- D. Sleeves in concrete construction shall be galvanized steel pipe, except where passing through exterior walls they shall be ductile iron. Sleeves passing through floors shall project 1 inch above the finish floor. Sleeves in frame and dry wall construction shall be 18 gauge galvanized steel sheet metal.
- E. Provide escutcheons at all exposed pipe penetrations in finished areas. Escutcheons shall be chrome plated, sized to cover the sleeve, with set screw.

## 2.7 PLUMBING SPECIALTIES

- A. Pressure reducing valves shall be Watts, U5BLP (or 223 SB) with integral removable stainless steel strainer, nickel alloy seat, and bronze body. Provide a 0-100 psi pressure gauge immediately downstream of the valve.
- B. Reduced pressure backflow preventers shall be Watts Series 909, Hersey Beeco, ITT Lawlor, or approved equal bronze body reduced pressure zone back flow type, 175 psi maximum working pressure, complete with replaceable seats, strainer, test cocks, shut off valves, union ends, and air gap fitting. Backflow preventers shall be ASSE, AWWA, and FCCCHR or USC approved.

- C. Vacuum breakers: Shall be provided in all hose bibb outlets, and in all other locations specified and as directed by the authority having jurisdiction.
- D. Water hammer arrestors shall be certified per PDI Standard WH-201 and have stainless steel shell and bellows, 250 psi rated as manufactured by Josam, Zurn, J.R. Smith, or approved equal.
- E. Provide dielectric couplings at all ferrous to non-ferrous joints.
- F. Pressure gauges shall be ASME B 40.1, liquid filled type, 1% accuracy or better, minimum 2 1/2 inch diameter casing, 0 to 100 psig range, with ball valve shutoff and snubber.

## 2.8 VALVES

- A. Butterfly Valves, 2-1/2 Inch and Larger: MSS SP-67; rated at 200 psi; cast iron body conforming to ASTM A 126, Class B. Provide valves with field replaceable EPDM sleeve, nickel-plated ductile iron disc (except aluminum bronze disc for valves installed in condenser water piping), stainless steel stem, and EPDM O ring stem seals. Provide lever operators with locks for sizes 2 through 6 inches and gear operators with position indicator for sizes 8 through 24 inches. Provide lug or wafer type as indicated. Drill and tap valves on dead end service or requiring additional body strength.
- B. Gate Valves 2-1/2 inch and larger: Class 175 iron body bronze mounted OS&Y with non-rising stem, bronze disk and flanged ends as manufactured by Jenkins, Crane, Stockham or approved equal.
- C. Gate Valves 2 inch and Smaller: MSS SP-80, Class 125, with bronze body and integral bronze seat, rising stem, screwed bonnet, solid wedge disk, and threaded ends as manufactured by Jenkins, Crane, Stockham, or approved equal.
- C. Ball Valves 2 inch and Smaller: MSS SP-110, 150 psi WSP, with 2 piece bronze body, PTFE seats and seals, full port, blowout proof pressure retaining stem, threaded ends, and vinyl covered carbon steel quarter-turn lever handle. Provide stainless steel ball and stem, with stem extension to accommodate thickness of pipe insulation.
- D. Check Valves 2 inch and Smaller: MSS SP-80, Class 150, with bronze body, swing check, thread-in cap, and threaded ends, designed for horizontal or vertical mounting.

## 2.9 PLUMBING FIXTURES

- A. Hose Bibb (HB-1)
  - 1. Hose Bibbs shall be 1/2 inch size X 3/4" garden hose connection, polycarbonate or metallic handle, female 1/2" NPT inlet with wall mounting flange, male hose thread outlet complete with bronze vacuum breaker. Hose bibb shall have rough chrome finish. Support hose bibb supply pipe 3" max above mounting height of hose bib.
- B. Large Hose Bibb (HB-2)
  - 1. Large Hose Bibbs shall be 1" inch size with female 1" NPT inlet and 1" male NST hose thread outlet. Hose bibb shall have rough brass finish.

## 2.10 EXISTING FLOOR DRAINS AND FLOOR SINKS

- A. Where noted on plans, remove and discard grates from existing floor drains and sinks. Furnish and install new grates of type compatible with the existing floor drain or sink and suitable for the floor type (Finish or Rough, as applicable.)

## 2.11 ROOF DRAINS AND ACCESSORIES

- A. General: Roof drains shall be Zurn, Jay R. Smith, Josam, Froet or approved equal. Manufacturer's catalog numbers specified herein for drains are intended only as a guide for the type and quality to be furnished under this Section of the Specifications.
  - 1. Roof drain shall be equal to Zurn figure Z121 with secured cast iron dome extension, sump receiver, underdeck clamp, and no-hub adapter.

## 2.12 PIPING INSULATION

- A. General
  - 1. The pipe covering specified herein for piping system shall be provided to strict accordance with the manufacturer's printed instructions, the best practice of the trade and to the full intent of this Specification.
  - 2. Flame/Smoke Ratings: Provide complete fibrous glass pipe insulation (insulation, jackets, coverings, sealers, mastics and adhesives) with flame spread index of 25 or less, and smoke developed index of 50 or less, as tested by ASTM E 84 (NFPA 255) method.
  - 3. Manufacturer: Subject to compliance with requirements, provide products of Armstrong World Industries, Inc., Knauf Fiber-Glass, Owens Corning or approved equal.
  - 4. Apply insulation after systems have been tested, proved tight and approved by Architect. Remove dirt, scale, oil, rust and foreign matter prior to installation of insulation.
  - 5. No leaks in vapor barrier or voids in insulation will be accepted.
  - 6. Insulation and vapor barrier on piping which passes through walls or partitions shall pass continuously through sleeve, except that piping between floors and through fire walls or smoke partitions shall have space allowed for application of approved packing between sleeves and ping, to provide firestop as required by NFPA. Seal ends to provide continuous vapor barrier where insulation is interrupted. **NOTE: Owner shall engage special inspections of firestopping.**
- B. Interior Cold Water Systems:
  - 1. 1 inch thickness fiberglass piping insulation
    - a. ASTM E-547, Class I



2. Fire retardant foil face jackets for piping insulation: ASTM C-921, Type I for piping with temperatures below ambient, Type II for piping with temperatures above ambient. Type I may be used for all piping at installation option.
3. Encase piping fittings insulation with one piece premolded PVC fitting covers, fastened as per manufacturer's recommendations.
4. Staples, Bands, Wires, and Cement: As recommended by insulation manufacturer for applications indicated.

## 2.13 SUMP PUMPS

- A. This Plumbing Contractor shall furnish and install two 2 inch submersible sump pumps as shown on the drawings. The sump pumps shall have a capacity of 20 GPM against a TDH of 40 feet. The sump pump shall be WEIL model 2443 or approved equal by Liberty or Zoeller.
1. Motors shall be not less than 1/2 HP, 480 volts, 3 phase, 3450 RPM.
  2. Pumps shall have a 20 foot cord.
  3. Motor(s) shall be housed in watertight cast iron shell. Oil filled motors will not be considered equal. Motor(s) shall have Class 'F' insulation and permanently lubricated double seal ball bearings. Motor(s) using sleeve type bearing will not be considered equal. Mating surfaces between the motor and bell, motor shell and seal housing shall be sealed by means of 'O' rings. The motor shaft shall be Series 300 stainless steel with keyway for positive positioning of the impeller. Carbon steel and 400 series stainless steel shafts are not considered equal.
  4. Impeller shall be multi-vane, semi-open type and accurately machined to the proper diameter. The impeller is to be trimmed to suit job conditions and then dynamically balanced.
  5. Controls to include:
    - a. 3-Float switches suspended from wall bracket
    - b. 1-8111 NEMA 4X Simplex control panel to include:
      - 1) Comb. Manual disconnect switches & motor circuit protectors
      - 2) Magnetic starters
      - 3) H/O/A Selector switches
      - 4) On/Off Pilot lights
      - 5) Control circuit transformer
      - 6) Alarm bell with silencer
      - 7) Numbered & wired terminal strip
      - 8) Set of isolated dry contacts for remote alarm.
      - 9) Through door main disconnect switch.
  6. Pit by others

## PART 3 EXECUTION

### 3.1 OPENINGS

- A. The responsibility for determining the exact size and location of openings is part of the Work of this section. If this responsibility is not met, cutting and patching to achieve the correct size and location of openings and chases is part of the Work of this section.

### 3.2 CUTTING AND PATCHING

- A. Do all cutting and patching required for the Work of the section, except cutting and patching of finish (visible) materials. Cutting and patching of masonry walls, partitions, ceilings and floors is included. Concrete cutting shall be done with abrasive wheels or saws, and coring with a diamond core bit. The use of jackhammers is prohibited.

### 3.3 INSTALLATION OF EQUIPMENT

- A. Equipment shall be installed in strict accordance with manufacturer's instructions, unless otherwise specified herein, or on the Contract Drawings. In case of discrepancies, contact the Engineer for instructions.
- A.
  1. Install roof drains at low points of roof area, in accordance with the roof membrane manufacturers installation instructions.
  2. Install drain flashing collar or flange so that no leakage occurs between roof drain and adjoining roofing. Maintain integrity of water proof membranes, where penetrated.
  3. Position roof drains so they are accessible and easy to maintain.
  4. Install Large Hose Bibbs in a separate piping loop downstream of a Backflow Preventer.

### 3.4 INSTALLATION OF PIPING

- A. Provide a shutoff valve on each pressure piping connection at each item of equipment, except vent and overflow connections.
- B. Do not install valves with the stem below horizontal.
- C. Provide a union or flange at each connection at each item of equipment.
- D. Install piping parallel to or perpendicular to the lines of the building.
- E. Pitch all pressurized water piping up 1 inch in 80 feet, or run dead level and provide an air vent every 40 feet.

### 3.5 CLEANING

- A. Clean all debris resulting from the work of the section, and remove it from the Project Site, daily.

- B. Close pipe openings with caps or plugs during installation. Tightly cover and protect fixtures and equipment against dirt, water and chemical or mechanical injury. At completion of all Work, thoroughly clean all fixtures, exposed materials and equipment.

### 3.6 TESTS

- A. Test water piping at 100 psi hydrostatic pressure before any covering is installed. Blank off or remove items which may be damaged by the test pressure. Correct all defects and retest as many times as is necessary to verify that all defects have been remedied. Neither peening nor the use of leak seals is permitted.
- B. Test drain-waste piping by tightly plugging all openings except for the highest opening in the system. Fill all systems to overflowing. Systems shall be tight throughout with no drop in water level for a minimum period of 2 hours.

### 3.7 DISINFECTION OF WATER SUPPLY SYSTEM

- A. Fill all systems with a water and chlorine solution which contains 50 parts per million of available chlorine and allow it to stand 6 hours before flushing. Fill each system with a solution which contains 100 parts per million of available chlorine; allow it to stand 2 hours and flush it.

### 3.8 PAINTING

- A. Clean all surfaces free of dirt, oil, grease, etc. Surfaces shall be clean and dry before any paint is applied.
- B. Restore to original condition and appearance any equipment which has sustained damage to the manufacturer's prime and/or finish coat.

### 3.9 OPERATING AND MAINTENANCE MANUALS

- A. Furnish to the Owner operations and maintenance instructions of all mechanical, electrical and manually operated equipment furnished and/or installed under the Contract, as specified. See SECTION 01730, OPERATION AND MAINTENANCE MANUALS.

END OF SECTION

## SECTION 15500

### HEATING, VENTILATION AND AIR CONDITIONING

#### PART 1 - GENERAL

##### 1.1 DESCRIPTION

- A. The Work of this section includes all labor, tools, material, fittings, accessories, and equipment necessary to provide the heating, ventilating and air conditioning systems, complete and operable.
- B. The Work includes, without limiting the generality thereof:
  - 1. Fuel Piping (except underground piping specified in section 15100)
  - 2. Energy Recovery Ventilation systems
  - 3. Wall Mounted electric heaters (As applicable)
  - 4. Supply and exhaust ventilation ductwork.
  - 5. Submersible Fuel Oil Pump (Section 15100)
  - 6. Aboveground Fuel Oil Storage Tank (Section 15100)
  - 7. Tank Gauge and Leak Detection System (Section 15100)
  - 8. Control wiring and conduit, including Tank Gauge and Leak Detection System, except SCADA dry contact.
  - 9. Testing, Adjusting and Balancing.
  - 10. HVAC Demolition.

##### 1.2 SUBMITTALS

- A. Submit the following in accordance with Section 01300:
  - 1. Energy Recovery Units
  - 2. Wall Mounted electric heaters
  - 3. Electric Unit Heaters
  - 4. Ductwork
  - 5. Ductwork accessories
  - 6. Submersible Fuel Oil Pump
  - 7. Aboveground Fuel Oil Storage Tank
  - 8. Tank Gauge and Leak Detection System
  - 9. Piping, Fittings Valves (except underground piping specified in section 15100)
  - 10. Insulation
  - 11. Testing, Adjusting and Balancing Report.

##### 1.3 RELATED WORK SPECIFIED ELSEWHERE

- A. Section 03300, Cast-In-Place Concrete, including equipment support pads.
- B. Section 05500, Metal Fabrications
- C. Section 09900, Painting
- D. Section 15100 Above Ground Fuel Storage Systems
- D. Section 16085, Miscellaneous Equipment
- E. Section 16120, Wire and Cables

1.4 ITEMS INSTALLED BUT NOT FURNISHED

- A. Duct Smoke Detectors – DIVISION 16 – ELECTRICAL.

1.5 ITEMS FURNISHED BUT NOT INSTALLED

- A. None.

1.6 DESIGN CRITERIA

- A. The Work of this section shall comply with the requirements of the Massachusetts State Building Code and of all other authorities having jurisdiction.
- B. The equipment covered by the Specifications is intended to be standard equipment of proven quality as manufactured by reputable concerns. Equipment shall be designed, constructed and installed in accordance with the best practice of the industry and shall operate satisfactorily when installed in accordance with the Contract Documents. The Specifications call attention to certain details, but do not purport to cover all details entering into the construction of the equipment.
- C. All material shall be new and shall bear the manufacturer's full identification.
- D. Requirements of Regulatory Agencies
  - 1. The final, complete installation shall comply with all state and local statutory requirements having jurisdiction. Arrange for all necessary permits, pay all fees and arrange for all required inspections by state and local authorities.
  - 2. In general, all Work shall comply with the requirements of rules, regulations, standards, codes, ordinances, and laws of local, state, and federal governments, and other authorities that have legal jurisdiction over the Project Site. Materials and equipment shall be manufactured, installed and tested as specified in latest editions of applicable publications, standards, rulings and determinations of:
    - a. Local and state building, HVAC, plumbing, mechanical, energy conservation, electrical, fire and health department codes.
    - b. National Fire Protection Association (NFPA).
    - c. Occupational Safety and Health Act (OSHA).
    - d. Underwriters' Laboratories (UL).
    - e. Material and equipment shall be listed by Underwriters' Laboratories (UL), and approved by ASME for intended service.
  - 3. When requirements cited in the Specifications conflict with each other or with Contract Documents, most stringent shall govern Work.
  - 4. Most recent editions of applicable specifications and publications of the following organizations form part of Contract Documents:
    - a. American National Standards Institute (ANSI).

- b. American Society of Mechanical Engineers (ASME).
- c. National Electric Manufacturers Association (NEMA).
- d. American Society for Testing and Materials (ASTM).
- e. American Society for Heating, Refrigerating and Air Conditioning Engineers (ASHRAE).
- f. Air Moving and Conditioning Association (AMCA).
- g. Sheet Metal and Air Conditioning Contractors National Association (SMACNA).
- h. Thermal Insulation Manufacturers Association (TIMA).
- i. Institute of Electrical and Electronics Engineers (IEEE).
- j. Insulated Cable Engineers Association (ICEA).

E. Tests, Adjusting and Balancing

1. Test all systems furnished under this section and repair or replace all defective Work. Make all necessary adjustments to the systems and instruct the Owner's personnel in the proper operation of all systems.
2. Defined to include, but not necessarily limited to, air distribution systems, and associated equipment and apparatus of mechanical Work. Work consists of setting speed and volume (flow) adjusting facilities provided for systems, recording data, conducting tests, preparing and submitting reports, and recommending modifications to Work as required by the Contract Documents.
3. Startup the following pieces of equipment in strict accordance with manufacturer instructions and with the manufacturer's representative.
  - a. Energy Recovery Unit(s)
4. Submit certified test reports signed by test and balance supervisor performing TAB Work.
5. Include identification and types of instruments used and most recent calibration date with submission of final test report.
6. Shop Drawings
  - a. Submit sample test data forms complete with certifying agency logo, identifying required test data, date, page number, system designation, system location, Project name, and balancer's name.
7. Tester's Qualifications: Firm with at least 3 years successful testing, adjusting, and balancing experience on projects with testing and balancing requirements similar to those required for the Project, not installer of system to be tested, and otherwise independent of the Project.

8. NEBB or AABC Compliance: Comply with either National Environmental Balancing Bureau (NEBB) or Associated Air Balance Council (AABC) Procedural Standards for Testing, Adjusting, and Balancing of Environmental Systems, as applicable to mechanical air distribution systems and associated equipment and apparatus.
9. Industry Standards: Comply with ASHRAE recommendations pertaining to measurements, instruments, and testing, adjusting, and balancing except as otherwise indicated.
10. Do not proceed with testing, adjusting, and balancing Work until each system is complete and operable. Ensure no later residual Work still to be completed.
11. Do not proceed until Work scheduled for testing, adjusting, and balancing is clean and free from debris, dirt, and discarded building materials.
12. The Engineer shall be immediately notified of any unfavorable test results or indication of faulty equipment. No piece of equipment shall be energized until the test data is evaluated and the equipment is proven acceptable.
13. Upon completion of the work herein described, the Testing Firm shall submit Test and Inspection Reports to the Engineer.
14. If the test and inspection data submitted should indicate deficiencies in the operation of the electrical apparatus or in the manufacturer thereof, promptly implement the necessary adjustments, corrections, modifications and/or replacements necessary to be made to meet the specified requirements.
15. Upon completion of the remedial work, the Testing Firm shall repeat all of the tests on components previously found deficient on the first test or any additional test if they be required. Have all remedial Work accomplished as may be required by second and/or additional tests.

#### 1.7 DELIVERY, STORAGE AND HANDLING

- A. Provide in accordance with Section 01600.
- B. All materials and equipment shall be shipped, stored, handled and installed in such manner as not to degrade quality, serviceability, or appearance.
- C. Protect all work, the Owner's property and the property of others from injury or loss caused by operations associated with the Work of this section. Make good any such injury or loss, at no cost to the party suffering the injury or loss.

#### 1.8 PROCEDURE

- A. Secure all required permits, inspections, and approvals and pay all costs and fees.
- B. Unless the Specifications state "No Substitutions", substitutions will be considered for any specified item.
- C. Coordinate safety program with that of the General Contractor. Cooperate with other

Subcontractors to establish lines, levels, openings, chases, clearances, and locations to avoid interference; and to protect the Work.

- D. Deliver all materials as needed to avoid delays.

## 1.9 INTERPRETATION OF DRAWINGS

- A. Listing of Drawings does not limit responsibility of determining full extent of Work required by the Contract Documents. Refer to Architectural, HVAC, Electrical, Structural, and other Contract Drawings and other sections that indicate types of construction in which Work shall be installed and Work of other trades with which Work of this section must be coordinated.
- B. Except where modified by a specific notation to the contrary, the indication and/or description of any item, in the Contract Drawings or Specifications or both, carries with it the instruction to provide the item, regardless of whether or not this instruction is explicitly stated as part of the indication or description.
- C. Items referred to in singular number in Contract Documents shall be provided in quantities necessary to complete Work.
- D. Drawings are diagrammatic. They are not intended to be absolutely precise; they are not intended to specify or to show every offset, fitting, and component. The purpose of the Contract Drawings is to indicate a systems concept, the main components of the systems, and the approximate geometrical relationships. Based on the systems concept, the main components, and the approximate geometrical relationships, the Contractor shall provide all other components and materials necessary to make the systems fully complete and operational.
- E. Data that may be furnished electronically by the Engineer (on computer tape, diskette, or otherwise) is diagrammatic. Such electronically furnished information is subject to the same limitation of precision as heretofore described. If furnished, such data is for convenience and generalized reference, and shall not substitute for the Engineer's sealed or stamped construction documents.

## 1.10 DISCREPANCIES IN DOCUMENTS

- A. Where Contract Drawings or Specifications conflict or are unclear, advise the Engineer in writing before Award of Contract. Otherwise, the Engineer's interpretation of Contract Documents shall be final, and no additional compensation shall be permitted due to discrepancies thus resolved.
- B. Where Contract Drawings or Specifications do not coincide with manufacturers' recommendations or with applicable codes and standards, alert the Engineer in writing before installation. Otherwise, make changes in installed Work as the Engineer requires at no additional cost to the Owner.
- C. If the required material, installation, or Work can be interpreted differently from drawing to drawing, or between Contract Drawings and Specifications, this Contractor shall provide that material, installation, or Work which is of the higher standard.
- D. Provide systems and components that are fully complete and operational and fully suitable for the intended use. There may be situations in the documents where



insufficient information exists to precisely describe a certain component or subsystem, or the routing of a component. In cases such as this, where the Contractor has failed to notify the Engineer of the situation as specified, provide the specific component or subsystem with all parts necessary for the intended use, fully complete and operational, and installed in workmanlike manner either concealed or exposed per the design intent.

- E. In cases covered by Paragraph (D) above, where the Contractor needs engineering guidance, submit a sketch identifying his proposed solution and the Engineer shall review, note if necessary, and approve the sketch.

#### 1.11 MODIFICATIONS IN LAYOUT

- A. Drawings are diagrammatic. They indicate general arrangements of mechanical and electrical systems and other Work. They do not show all offsets required for coordination nor do they show the exact routings and locations needed to coordinate with structure and other trades and to meet Architectural requirements.
- B. Check Contract Drawings as well as Shop Drawings of all trades to verify and coordinate spaces in which Work of this section will be installed.
- C. Maintain maximum headroom at all locations. All piping, duct, conduit, and associated components to be as tight to underside of structure as possible.
- D. Make reasonable modifications in layout and components needed to prevent conflict with Work of other trades and to coordinate as specified. Systems shall be run in a rectilinear fashion.
- E. Where conflicts or potential conflicts exist and engineering guidance is desired, submit sketch of proposed resolution to the Engineer for review and approval.

#### 1.12 RECORD DRAWINGS

- A. As work progresses and for duration of Contract, maintain complete and separate set of prints of Contract Drawings at job site at all times. Record work completed and all changes from original Contract Drawings clearly and accurately including work installed as a modification or addition to the original design. Record valve tags as they are installed. In addition, take photographs of all concealed equipment in gypsum board ceilings, shafts, underground (buried) piping routes and supports and other concealed, inaccessible work. At completion of work, make copies of photographs with written explanation on back. These shall become part of Record Documents.
- B. At completion of work prepare a complete set of record drawings on AutoCad format, showing all systems as actually installed. The design tracings will be made available for the contractor's copying, at his expense, into electronic media reproducible files to serve as backgrounds for the drawings. The quantity of design tracings which are made available shall in no way be interpreted as setting a limit to the number of drawings necessary to show the required information. Contractor's professional draftsman shall transfer changes to electronic disks; submit the disks and three sets of prints to Architect for comments as to compliance with this section.
- C. THE ARCHITECT WILL NOT CERTIFY THE ACCURACY OF THE RECORD DRAWINGS - THIS IS THE SOLE RESPONSIBILITY OF THE CONTRACTOR.

- D. This trade shall submit the record set for approval by the building department in a form acceptable to the department, when required by the jurisdiction.
- E. Drawings shall show record condition of details, sections, riser diagrams, control changes and corrections to schedules. Schedules shall show actual manufacturer and make and model numbers of final equipment installation.

#### 1.13 MANUFACTURER'S SERVICES

- A. Provide manufacturer's services for testing, training and start-up of the following equipment:
  - 1. Energy Recovery Units
- B. The time required for each system shall be as specified in this section. The time specified shall be used as directed by the Engineer and shall not be used by the manufacturer or contractor for field adjustments due to manufacturing or shipping defects.

#### 1.14 ELECTRICAL WORK

- A. Except for electrical apparatus specifically called for as part of this Section, paragraph 1.01.B, all wiring, conduit, switches and controllers required will be provided under DIVISION 16 - ELECTRICAL. (See specification paragraph 15500.2.20.G. for additional information.)
- B. All electrical apparatus and controls furnished as a part of the Work of this section shall conform to applicable requirements under DIVISION 16 - ELECTRICAL. Enclosure types shall be as indicated on the Contract Drawings.
- C. All electrical wiring and conduit necessary for the connections from the SCADA system dry contacts shall conform to the requirements of and be furnished by DIVISION 16 - ELECTRICAL. Enclosure types shall be as indicated on the Contract Drawings.
- D. All motors furnished under this section shall be furnished by the manufacturer of the equipment served and shall be mounted and aligned so as to run free and true. Each motor shall be built to conform to the latest applicable NEMA, ANSI and IEEE standards for the type and duty of service it is to perform.
- E. Each motor shall be designed to operate on 60 Hz., and each shall be expressly wound for the voltage specified. Each motor shall operate successfully as rated load and frequency with a voltage variation of plus or minus 10% of voltage specified.
- F. All motors shall be provided with adequate starting and protective equipment as specified, and each shall have a terminal box of adequate size to accommodate the required conduit and wires.
- G. All electrical apparatus furnished under this section shall be approved by UL and shall be labeled or listed where such is applicable.

#### 1.15 WARRANTIES

- A. Submit manufacturer's standard replacement warranties for material and equipment

furnished under this section. Such warranties shall be in addition to and not in lieu of all liabilities, which the manufacturer and the contractor may have by law or by provisions of the Contract Documents.

- B. All materials, equipment and work furnished under this section shall be guaranteed against all defects in materials and workmanship for a minimum period of 1 year commencing with the Date of Substantial Completion and Final Acceptance by the Owner. Any failure due to defective material, equipment or workmanship which may develop, shall be corrected at no expense to the Owner including all damage to areas, materials and other systems resulting from such failures.
- C. Guarantee that all elements of each system meet the specified performance requirements as set forth herein or as indicated on the Contract Drawings.
- D. Upon receipt of notice from the Owner of the failure of any part of the systems during the guarantee period, the affected parts shall be replaced. Any equipment requiring excessive service shall be considered defective and shall be placed.

#### 1.16 SURVEY AND MEASUREMENTS

- A. Base all required measurements, horizontal and vertical, from referenced points established by the Contractor and be responsible for correctly laying out the Work required under this section of the Specification.

#### 1.17 DELIVERY, STORAGE AND HANDLING

- A. Provide in accordance with Section 01610 and as specified herein.
- B. All manufactured materials shall be delivered to the Project Site in original packages or containers bearing the manufacturer's labels and product identification.
- C. Protect materials against dampness. Store off floors, under cover, and adequately protected from damage.
- D. Deliver products to the Project Site and store and protect same as recommended by the manufacturers'.
- E. Inspect all HVAC equipment and materials, upon receipt at the Project Site, for damage and correctness.

#### 1.18 PROTECTION OF WORK AND PROPERTY

- A. Care and protect for all Work included under this section until it has been tested and accepted.
- B. Protect all equipment and materials from damage from all causes including theft. All materials and equipment damaged or stolen shall be repaired or replaced with equal material or equipment.
- C. Protect all equipment, outlets and openings with temporary plugs, caps and covers. Protect work and materials of other trades from damage that might be caused by work or workmen under this section and make good damage thus caused.

1.19 SAFETY PRECAUTIONS

- A. Comply with all of the safety requirements of OSHA throughout the entire construction period of the Project.
- B. Provide and maintain proper guards for prevention of accidents and any other necessary construction required to secure safety of life and/or property.

1.20 SPARE PARTS

- A. Furnish spare-parts data for every component that is required to be maintained for normal service of equipment furnished. The data shall include a complete list of parts and supplies, with current unit prices and source of supply; a list of parts and supplies that are either normally furnished at no extra cost with the purchase of the equipment, or specified hereinafter to be furnished as part of the Contract; and a list of additional items recommended by the manufacturer to assure efficient operation for a period of 180 days at the particular installation. The foregoing shall not relieve the contractor of any responsibilities under the guarantees specified herein.

1.21 HOISTING, SCAFFOLDING AND PLANKING

- A. The Work to be done under this section of the Specifications shall include the furnishing, set-up and maintenance of all derricks, hoisting machinery, scaffolds, staging, planking, ladders, etc. as required for the Work.

1.22 SLEEVES, INSERTS, ANCHOR BOLTS, AND PLATES

- A. Be responsible for the location of and the maintaining in proper position all sleeves, inserts and anchor bolts supplied and/or set in place. In the event that failure to do so requires cutting and patching of finished Work, it shall be done at this Subcontractor's expense without any additional cost to the Owner.

1.23 SUPPLEMENTARY STEEL, CHANNELS AND SUPPORTS

- A. The HVAC Subcontractor shall provide all supplementary steel, including channels and supports required for the proper installation, mounting and support of all HVAC equipment, piping, etc., required by the Specifications.
- B. Supplementary steel and channels shall be firmly connected to building construction in a manner approved by the Engineer.
- C. The type and size of the supporting channels and supplementary steel shall be determined by the HVAC Subcontractor and shall be of sufficient strength and size to allow only a minimum deflection in conformance with the manufacturer's requirements for loading.
- D. **All steel used for supplementary steel, channels and supports shall be 316 stainless steel.**

1.24 CERTIFICATES OF INSPECTION/APPROVAL

- A. Furnish upon completion of all Work, certificates of inspections from the manufacturers stating that authorized factory engineers have inspected and tested the operation of their

respective equipment and found same to be in satisfactory operating conditions.

## 1.25 ACCESSIBILITY

- A. All Work shall be installed so that parts requiring inspection, operation, maintenance and repair are readily accessible. Minor deviations from the Contract Drawings may be made to accomplish this, but changes of substantial magnitude shall not be made prior to receipt of written approval from the Engineer.

## 1.26 DEFINITIONS

- A. As used in this section, the following terms are understood to have the following meanings:
  - 1. "Furnish" shall mean purchase and deliver to the project site, complete with every necessary accessory and support.
  - 2. "Install" shall mean unload at the delivery point at the site and perform all work necessary to establish secure mounting, proper location and operation in the project.
  - 3. "Provide" shall mean furnish and install.
  - 4. "Work" shall mean all labor, materials, equipment, apparatus,, controls, accessories, and all other items required for a proper and complete installation.
  - 5. "Piping" shall mean, in addition to pipe or tubing, all fittings, unions, valves, hangers and other accessories relative to such piping.
  - 6. "Concealed" shall mean hidden from sight in chases, furred spaces, shafts, embedded in construction or in crawl space.
  - 7. "Exposed" shall mean not installed underground or concealed as defined above.
  - 8. "Furnished by others" shall mean materials or equipment purchased and set in place under other sections of the general contract and connected to the systems covered by this section of the specifications by this trade contractor.
  - 9. "Coordinate" shall mean all work provided under this section of the specification shall be in compliance with work of other trades.

## PART 2 - MATERIALS

### 2.1 PIPE FITTINGS VALVES

- A. Fuel oil supply and return piping above ground shall be type A53 schedule 80 carbon steel pipe. Fittings 2 inches and smaller shall be malleable iron screwed fittings. Fittings 2-1/2 inches and larger shall be type A-234 steel butt-weld. See specification section 15100 for valves.
- B. Condensate drain piping shall be Type 1, Grade 1, Class 12454-B, Schedule 40 polyvinyl chloride (PVC) pipe conforming to ASTM D-1785. Drain piping shall have Schedule 40

PVC socket fittings conforming to ASTM D-2466. All joints between pipe and fittings shall be solvent cemented joints conforming to ASTM D-2235 and ASTM D-402. Provide protection for PVC piping exposed to weather from ultraviolet radiation.

## 2.2 HANGERS AND SUPPORTS

- A. All hangers and supports shall be 316 stainless steel (SS).
- B. Provide pipe stands, supports, hangers and other supporting devices in accordance with ANSI B31.9 and ANSI/MSS SP-58-2009, as necessary to support work required by Contract Documents.
- C. Secure vertical piping to building construction to prevent sagging or swinging.
- D. Space hangers for horizontal piping as follows:

Pipe Size	Rod Diameter	Maximum Spacing
Up to 1-1/4"	3/8"	7 ft.-0"
1-1/2 and 2"	3/8"	9 ft.-0"
2-1/2 and 3"	1/2"	10 ft.-0"
4 and 5"	5/8"	12 ft.-0"
6"	3/4"	12 ft.-0"

- E. Horizontal copper tubing shall have maximum hanger spacing of 5 ft. for tubing 1-1/4" dia. and smaller and 9 for tubing 1-1/2" and larger. Maximum spacing for PVC pipe hangers shall be 4'.
- F. Reduce spacing to a maximum of 10'- 0" apart, regardless of pipe size, as necessary for fittings, valves and other concentrated loads.
- G. Support piping 4" dia. and larger from structure with pipe roll hangers with adjustable steel rod hangers, sized to accommodate insulation.
- H. Support piping 3" dia. and under from structure with Carpenter and Patterson Fig. 100 clevis hangers or approved equal.
- I. Hangers shall be by Carpenter and Patterson, F & S, or Anvil Int. Figure numbers of Carpenter and Patterson are specified to establish standards of quality for performance and materials.
- J. All hangers on insulated piping shall be sized to fit the outside of the covering. Provide spacer blocks and 16 gauge SS protection shields (12 inches long) at hangers, when pipe is installed.
- K. Hangers for horizontal lines shall be vertically adjustable to obtain pitch requirements.
- L. In concealed locations where piping is installed through holes or notches in studs, joists, rafters or similar members less than 1-1/2 inches from the nearest edge of the member, shield plates shall be installed over the piping. The plates shall consist of 16 gage steel fastened in place over the pipe and shall extend not less than 2 inches above sole plates and below top plates.
- M. Duct hangers shall be in accordance with the "HVAC Duct Construction Standards" published by the Sheet Metal and Air Conditioning Contractors National Association, Incorporated (SMACNA).
- N. Where support points are required to avoid other Work, provide a system of channels and

angles between support points as required. Provide all necessary supports and cross framing. No part of piping, ductwork, equipment, and the building shall be stressed beyond its normal allowable working strength.

### 2.3 UNIONS

- A. Unions for PVC pipe 2 inch and smaller shall be Schedule 40 PVC.

### 2.4 PIPING SPECIALTIES

- A. Provide dielectric couplings or flanges in all copper to ferrous transitions.
- B. Sleeves
  1. Provide sleeves at all penetrations. Sleeves shall be aluminum or 316 stainless steel except in concrete as noted below. Sleeves shall be sized to allow 1/2 inch of annular space between the covering (or bare pipe) and the inside of the sleeve.
  2. Pipe penetrations of walls below grade shall be sleeved and sealed using Thunderline Link-Seal wall sleeves and seals.
  3. Pack the annular space with non-combustible (as defined by ASTM E136) fire stopping material, and seal with non-combustible caulking flush with finished surface.
  4. Sleeves in concrete construction shall be 316L steel pipe, except where passing through exterior walls and slabs-on-grade they shall be ductile iron. Sleeves passing through floors shall project two inches above the finish floor and sleeves passing through walls shall be trimmed flush with the wall surface.
  5. In other areas, pack the annular space with non-combustible (as defined by ASTM E136) fire stopping material, and seal with non-combustible caulking flush with finish surface. NOTE: Owner shall engage special inspections of firestopping.

### 2.5 ENERGY RECOVERY UNITS

- A. Provide a horizontal rotary wheel air-to-air energy recovery ventilator as manufactured by Haakon, Climate Craft, Greenheck, or equal. Unit shall be manufactured for outdoor construction because of wet environment. The unit shall include a rotary exchanger, supply air and exhaust air blowers, motors with starters and relays, air filters, heating coil and specified options, including Airflow Measuring Stations in the Outdoor Air and Exhaust Air streams.

#### B. References

1. ASTM E90 Standard Test Method for Laboratory Measurement of Airborne Sound Transmission Loss of Building Partitions and Elements
2. ASTM E1332 Standard Classification for Determination of Outdoor-Indoor Transmission Class
3. SMACNA HVAC Duct Construction Standards—Metal and Flexible

4. ARI 1060 Rating Air-To-Air Energy Recovery Ventilation Heat Exchangers
5. AMCA 210 Laboratory Methods of Testing Fans for Rating Purposes
6. NEMA MG1 Motors and Generators
7. AFBMA 9 Load Ratings and Fatigue Life for Ball Bearings
8. ARI 410 Forced-Circulation Air-Cooling and Air-Heating Coils
9. UL 1995 Heating and Cooling Equipment
10. ASHRAE 52-76 Method of Testing General Ventilation Air-Cleaning Devices for Removal Efficiency by Particle Size (ANSI/ASHRAE Approved) (for Filters)
11. ASHRAE 62.1 Ventilation for Acceptable Indoor Air Quality

C. Service for the unit shall be available locally either directly from the manufacturer or from the manufacturer's certified local representative. Provide two hours of on-site startup service and instruction.

D. Submittals

1. Drawings shall include accurately scaled CAD drawings of the entire unit with plan and elevation views and any required sub section or component thereof. Drawings shall be made available in electronic format either electronically or on disk.
2. Product performance data shall include unit dimensions, weights, capacities, component performance data, electrical data, construction details, required clearances and service access dimensions, field connection requirements and data, static pressure drops, methods of vibration isolation, included gages, performance data for each blower, and unit surface material and finish.
3. The submittal shall provide information on filters including pressure drop, efficiency, media description, frame details, and filter gage information.
4. Submittal shall include electrical data for the unit including full load amps for each unit component, maximum circuit ampacity, breaker and disconnect size, transformer size, and wiring diagrams for control panel wiring and unit component wiring that indicates factory and field installed wiring.
5. Submittal shall include the manufacturers recommended installation instructions.

E. Construction

1. Unit shall have an all-welded base frame constructed from aluminum or galvanized steel covered with a chemical resistant coating equal to Greenheck Hi-Pro-Polyester. The frame shall include formed supports constructed from welded structural steel under blowers and other components.



2. A 16 gauge interior floor shall be installed on the base frame. The floor shall be insulated and a 22 gauge galvanized steel sub-floor shall be installed under the insulation. Floor insulation shall be 2" thick and consist of a load-bearing, rigid, closed-cell foam core laminated to a black glass reinforced mat facer.
  3. All cabinet walls, access doors, floor and roof shall be fabricated of double wall, impact resistant, panels insulated with fiberglass or foam.
  4. Cabinet frame exterior shall be of formed 18 gauge (minimum) galvanized steel covered with a chemical resistant coating equal to Greenheck Hi-Pro-Polyester or aluminum of equivalent thickness. Panels (fixed and access) to be of 18 gauge steel covered with a chemical resistant coating equal to Greenheck Hi-Pro-Polyester or aluminum of equivalent thickness. Frame and panels to have an internal liner of 22 gauge (minimum) galvanized steel covered with a chemical resistant coating equal to Greenheck Hi-Pro-Polyester or the equivalent in aluminum and be sealed with silicone sealant to provide a complete vapor barrier and non-contaminating surface to all air streams. Unit exterior and interior finish shall be galvanized steel covered with a chemical resistant coating equal to Greenheck Hi-Pro-Polyester or aluminum of equivalent thickness.
- F. Insulation: Insulation shall be at least 2-inches thick, have a minimum density of 1-1/2 pounds/cubic foot and have a minimum R-value of 7.5. Foam insulation shall be tested in accordance with ASTM D-1929 for a minimum flash ignition temperature of 610°F. Insulation shall meet the flame and smoke generation requirements of NFPA-90A.
- G. Rotary Air-To-Air Heat Exchanger
1. Rotary air-to-air heat exchanger sensible recovery performance and leakage must be clearly measured and certified by AHRI in accordance with AHRI Standard 1060. The wheel's Exhaust Air Transfer Ratio, as measured and certified by AHRI, shall be 2.0 or lower. Exchanger shall be hygroscopic, mounted in housing with purge sector, variable speed drive, multifunction control system, and full season operational control.
  2. The unit must be provided with a factory set, field adjustable purge sector. The purge sector shall be designed such that, as measured according to AHRI Standard 1060, the Outdoor Air Correction Factor is less than 1.11 at a pressure differential of 0.00 inches w.g. This performance shall be certified and published by AHRI.
- H. Drive System/Speed Control
1. The rotor drive system shall consist of an adjustable belt around the rotor perimeter driven by an AC motor with gear reduction. The variable speed drive shall be specifically designed for heat wheel applications and include: an AC inverter, soft start/stop, rotation detection w/alarm contacts, automatic self cleaning function, and self testing capability.
  2. The speed controller shall be capable of accepting a potentiometer, VDC, or MA control signal.
  3. Motors shall be premium efficient, ODP, T-frame, 1750 rpm nominal with a

minimum service factor of 1.15 mounted on an adjustable base.

4. Motors, blowers, and frames shall be coated with covered with a chemical resistant coating equal to Greenheck Hi-Pro-Polyester.
  5. Supply and Exhaust air blowers shall be forward curved DWDI class I for quiet efficient operation arranged in a draw through configuration relative to exchanger. Motor and blower are to be mounted on common frame, isolated from the unit case with seismic restrained and flexible duct connections. Motors and blowers shall have Variable pitch sheaves.
- I. Airflow Measuring Stations shall consist of an airflow sensor such as an array or ring sensor, transmitter, and processor capable of transmitting the airflow quantity to the unit controls for display, logging and balancing.
- J. Heating Coil
1. Unit shall be furnished with an electric heating coil installed in the reheat configuration. Coil shall have capacity and performance as scheduled on the drawings.
- K. Air Filters: Outside and Return air filters shall be MERV 8 when evaluated under the guidelines of ASHRAE Standard 52.2-2017. Initial resistance to airflow shall not exceed 0.31" w.g. at an airflow of 500 fpm. The filter shall be classified by Underwriters Laboratories as UL Class 2. Filters shall be mounted within unit in galvanized holding frames upstream of exchanger and accessible through access panels or doors
- L. Dampers:
1. Actuated Dampers shall have heavy duty extruded aluminum frames, 4" extruded aluminum air-foil blades mounted on brass shafts, supported and inter-connected by fiberglass reinforced nylon gears.
  2. Low leakage dampers shall have hollow (thermoplastic elastomer (TPE)) rubber jamb seals built into both the blades and the frame. The side casings shall enclose the gears with ABS plastic covers that also serve as seals in the closed position.
  3. Outside Air Shut-Off Dampers: Outside air dampers shall be mounted on the inlet of the unit and operated by a spring return, direct-coupled on-off actuator with an end switch to be interlocked with the supply air motor relay. Dampers shall have parallel blades.
  4. Exhaust Air Shut-Off Dampers: Exhaust air damper shall be mounted on the outlet of the unit and operated by a spring return, direct-coupled on-off actuator with an end switch to be interlocked with the return air motor relay. Dampers shall have parallel blades.
  5. Energy Wheel Bypass Dampers: Dampers shall be mounted at the wheel and operated by spring return direct coupled actuator arranged to bypass the wheel when the outdoor air temperature is appropriate for economizer operation.
1. Two Position Spring Return Actuators shall be direct coupled type which require

no crankarm and linkage and be capable of direct mounting to the damper jackshaft. The actuators must be designed so that they may be used for either clockwise or counterclockwise fail-safe operation. Actuators shall use a brushless DC motor and be protected from overload at all angles of rotation. Actuators shall have reversing switch and manual override on the cover, and be protected from overload at all angles of rotation. As required, 1 or 2 SPDT auxiliary switches shall be provided having the capability of being adjustable. Actuators with auxiliary switches must be constructed to meet the requirements for Double Insulation so an electrical ground is not required to meet agency listings. Run time shall be constant and independent of torque. Actuators shall be UL listed and CSA certified, have a 5 year warranty, and be manufactured under ISO 9001 International Quality Control Standards.

M. Electrical

1. Electrical controls shall include for belt drive units: motor starters with overloads, fused branch circuit breakers, control transformer for low voltage controls, service switch, and terminal points/blocks all contained in a NEMA 3R, unit-mounted control panel.
2. A single main un-fused disconnect switch for single point power connection shall be provided. The disconnect switch shall be mounted through the access panel so that power will have to be shut-off before the access door can be opened.
3. The motor power and branch circuits shall be protected by circuit breakers so replaceable fuses will not be necessary.
4. All wiring and controls shall be factory tested before shipment.
5. The unit wiring diagram shall be provided in the panel.

N. Controls

1. Integral microprocessor controller, programmable and adjustable with both Ethernet and RS-485 communication ports.
2. A panel-mounted Touch-Screen Human-Machine Interface (HMI) device shall also be installed inside the unit and will allow users to change all unit operating parameters, execute schedules, and change control program variables.
  - i. **Furnish remote wall mounted panel microprocessor, including remote start/stop, occupied/unoccupied scheduling, alarm status and reset control, and supply air temperature reset. The panel shall be NEMA 4 construction.**
  - ii. Furnish factory mounted Airflow Measuring Stations in the Outdoor Air and Exhaust Air streams for balancing airflows.
1. Units shall come with factory mounted electronic speed control providing soft-start/stop, rotation detection and alarm, and self-cleaning jog functions.
2. **ERV controller shall include a digital output (dry contacts) for connection to**

**the SCADA system. System shall indicate run status and alarm status.**

5. The operational control system shall use remote temperature sensors mounted in the entering and leaving sides of both airstreams to monitor exchanger performance. Setpoints shall be adjustable at the provided HMI or by the building management system. The DDC controller shall modulate rotor speed to:
  - a. Prevent frost build-up. The controller shall monitor the temperature in the exhaust airstream leaving the exchanger and modulate wheel rotational speed to prevent the temperature from dropping below an adjustable, pre-programmed setpoint.
  - b. Outside Air and Exhaust Air Shut-Off dampers shall be operated by a two position spring return direct-coupled actuators with end switches to be interlocked with the supply and exhaust air motor relay or relays, respectively. Actuators to be controlled by the DDC control board.
  - d. Blowers shall be provided with motor starters with overloads controlled by the microprocessor.

## 2.6 WALL MOUNTED ELECTRIC HEATERS (AS APPLICABLE)

- A. Provide wall mounted electric heaters as manufactured by Broan, Qmark, Electromode, or approved equal. Basis of design is Q Mark Model CWH1101DSF.
- B. Heaters shall consist of the following:
  1. Steel enclosure with heavy steel grille.
  2. Integral thermostat with a range of 40 to 85 deg F.
  3. Manual reset thermal overload.
  4. On-off power switch for service.
  5. Permanently lubricated fan motor.

## 2.7 ELECTRIC UNIT HEATERS

- A. Provide Electric unit heaters as manufactured by Indeeco, Qmark, Electromode, or approved equal.
- B. Washdown heater is a reliable, rugged, self-contained, U.L. and CSA listed, corrosion resistant unit heater. This unit offers both corrosion protection in harsh environments and the ability to be hosed down for cleaning.
  1. All components are designed to be moisture and corrosion resistant. A sturdy stainless steel case surrounds industrial grade 316 stainless steel finned tubular elements. The motor is a totally enclosed, permanently lubricated, ball bearing type which is epoxy painted for moisture and corrosion resistance. The junction box which houses the built-in controls and element terminals is rated NEMA 4X. Air flow comes from a spark resistant, epoxy coated aluminum fan. Accessories:

Power contactor, motor contactor, epoxy sealed automatic over-temperature cutout, remote thermostat, pilot light to indicate when unit is in operation mode, and selector switch are standard (heater on, off, fan only).

2. Accessories:

- a. Disconnect Switch Rated 40 amps (factory mounted and wired).
- b. Secondary manual reset limit (factory mounted).
- c. Monel elements (factory mounted).
- d. Stainless steel universal type swivel mounting bracket.
- e. Fans shall have delay on both start and stop. Upon call for heat, fan start shall be delayed until heating element is warm. When thermostat is satisfied, fan stop shall be delayed until heating element is cool.
- f. Wall mounted thermostat.

C. Explosion Proof Unit heater shall be equal to model GUX by Q Mark or approved equal.

1. KW rating, voltage and phase shall be as scheduled. Unit heaters shall be fan forced type, UL and cUL Approved for Class 1, Divisions 1 and 2, Group C and D; Class II, Divisions 1 and 2, Groups E, F and G. The heat exchanger shall be liquid-to-air design, utilizing a steel tube core with integral aluminum fins. Nontoxic, inhibited, propylene glycol heat transfer fluid shall be used to provide freeze protection down to -49 deg F. A pressure relief plug shall be furnished and installed to provide overpressure protection. The heat exchanger shall include industrial grade electric heating elements. The heat exchanger and aluminum fan blade shall be enclosed in an industrial grade, corrosion resistant cabinet fabricated from polyester powder-coated 14-gauge steel. The heater shall have adjustable outlet louvers with minimum opening safety stops. The fan motor shall include permanently lubricated ball bearings and built-in thermal overload protection. Motor shall operate at line voltage and shall be prewired to the control enclosure to eliminate the need for separate field wiring to the motor.

2. Accessories:

- a. Disconnect Switch with external handle rated for 60 amps (factory mounted and wired).
- b. Manual reset thermal cutout for over temperature protection, controlling magnetic contactor and 24-volt control circuit transformer housed in a NEMA 7, 9 cast aluminum enclosure.
- c. Fan only switch (factory mounted and wired).
- d. Wall mounting kit designed to bear the weight of the scheduled unit heater assembly.
- e. Wall mounted explosion proof thermostat.

## 2.8 DUCTWORK

- A. Provide all sheet metal ductwork required for the various supply and exhaust air systems. Unless otherwise indicated on the Contract Drawings or in these specifications, ductwork shall be aluminum and all ductwork and sheet metal plenums shall be constructed meeting the requirements of ASTM B 209, lock-forming quality. All ductwork, except where specified otherwise herein, shall be fabricated in accordance with the "HVAC Duct Construction Standards for Metal Ducts" published by the Sheet Metal and Air Conditioning Contractors National Association, Incorporated (SMACNA), 2 inch water gauge Pressure Class.
- B. Ducts shall be true to the inside dimensions indicated on the Contract Drawings. Cross break all duct panels over 12 inches wide. Support ducts rigidly and securely. Support horizontal ducts not over 8 feet on center. Ducts shall be straight and smooth on the inside with neatly finished joints and all transverse joints and longitudinal seams of all low pressure ducts shall be sealed in conformance with SMACNA seal classification B.
- C. Elbows narrower than 16 inches shall be full radius elbows with inside radius equal to the dimension of the duct in the plane of the elbow or offset. Elbows wider than 16 inches may be full radius elbows or square elbows with air foil section turning vanes (Duct Manual Figure 2-3) and 6 inch inside radius. Vanes shall be "Runner" Type 2, 3 1/4 inches on centers. Install outside vane flush against the outside of the elbow.
- D. Transitions in duct mains and branches shall be made with sides sloping at not more than 1 inch in 7 inches on the side of the transformation for diverging transitions and 1 inch in 4 inches for converging transitions. Transitions in ductwork to pieces of equipment shall be made with a 20 degree maximum angle projected from the straight duct side on a diverging transition and a 30 degree maximum angle projected from the straight duct side on a converging transition. Any conditions requiring deviations from the above shall be brought to the attention of the Engineer for approval.
- E. All notches for connecting sections of duct, including longitudinal seam notches, shall not be cut any deeper than 1 7/8 inches to insure tight corners in 2 inch deep slip joints.
- F. Slips shall be at least 2 gauges heavier than the duct and all joints shall be made in a neat and workmanlike manner and in all cases shall be tight. All ducts shall have all joints sealed with EC-800 as manufactured by 3M, Hardcast or approved equal.

## 2.9 DUCTWORK ACCESSORIES

- A. Duct Flexible Connections: Provide 6 inch metal edge ventglas or thermafab flexible connections at fan and unit inlets and outlets. Leave 1 inch minimum slack, (this means 1/2 inch standing fold). Duct openings shall be lined up on either side of flexible connections.
- B. Wire Mesh Screen: 1/2 inch x 1/2 inch 316 series stainless steel welded wire mesh.
- C. Volume Dampers
  - 1. Provide volume dampers where indicated on the Contract Drawings.

2. Dampers less than 12 inches in height shall be Young Regulator manual adjustable rectangular opposed blade dampers.
3. Dampers 12 inch and larger in height shall be opposed multi-blade equal to Greenheck, Nailor, or Vent Products.
4. Damper frame shall be constructed of 316 series stainless steel channel with minimum thickness of .050 inches. Opposed damper blades shall be 316 series stainless steel with minimum thickness of .050 inches and shall include reinforcing ribs. Each blade shall be supported in the damper frame by individual Teflon axle bearings, and shall be driven by stainless steel connecting slide linkage controlled by 3/8 inch square steel control shaft.
5. Damper blades shall be 2 gauges heavier than adjoining ductwork, and shall be riveting to supporting rods. Hem over edges parallel to rods.
6. Brackets shall be galvanized metal, secured to ductwork with sheet metal screw with locking quadrant arms. Provide 2 inch handle extension for all dampers on externally insulated ductwork.

D. Sheet Metal Access Panels

1. Provide access panels of the proper size and at all locations in ductwork necessary to service control devices, fan bearings and as required to service all systems.
2. Access panels shall have foam gasketing, fixed hinges and compression type latches as manufactured by Ventlock, Duro-Dyne or approved equal. Access doors for insulated ducts shall be insulated with 1-inch thick 1 ½ lb density coated duct liner.

E. Louvers

1. Louvers shall be aluminum wind driven rain resistant with a minimum 45% open area and 0.15" w.g. pressure drop at full design airflow such as Ruskin EME520DD.

F. Air Filters

1. Unless otherwise specified, air filters shall be equal to a Farr 30/30 prefilter by Camfil and a final filter equal to Ultrasolve by Camfil or approved equal. Prefilter shall be 2" thick and shall have a clean pressure drop of 0.31" w.g. and shall be MERV 8. Final filter shall be 4" thick with a clean pressure drop of 0.17" MERV 13. Furnish and install a filter frame for filters in the ductwork at the unit inlet.

G. Diffusers, Registers and Grilles

1. Drum Louver:
  - a. Aluminum construction.
  - b. 1 1/4-inch margins, mitered corners, and countersunk mounting holes.
  - c. Single deflection.

- d. Vertical front blades.
- f. Mill finish.
- g. Louver to be provided with integral opposed blade type damper adjustable from face.
- h. Nailor 45DL-O.

2. Exhaust Registers, Exhaust Grilles:

- a. Minimum 22 gauge type 316 stainless steel construction.
- b. 1 1/4-inch margins, mitered corners, and countersunk mounting holes.
- c. Fixed vertical zero deflection bars.
- d. Mill finish.
- e. Register to be provided with integral opposed blade type 316 stainless steel damper adjustable from face.
- f. Nailor 6755-HD.

H. Control Dampers

1. Damper Assembly: Damper shall conform to SMACNA HVAC Duct Construction Standards. A single damper section shall have blades no longer than 48 inches and shall be no higher than 72 inches. Maximum damper blade width shall be 8 inches. Larger sizes shall consist of a combination of sections. Damper shall be 316 stainless steel. Flat blades shall be made rigid by folding the edges. Provide blades with compressible seals at points of contact. Provide channel frames of dampers with jamb seals to minimize air leakage. Dampers shall not leak in excess of 10 cfm per square foot at 4 inches water gage static pressure when closed. Seals shall be suitable for an operating temperature range of minus 40 degrees F to 200 degrees F. Dampers shall be rated at not less than 2000 fpm air velocity. Moving parts of operating linkage in contact with each other shall consist of dissimilar materials. Damper axles shall be 0.5 inches minimum plated steel rods supported in the damper frame by stainless steel or bronze bearings. Blades mounted vertically shall be supported by non-ferrous dissimilar thrust bearings. Pressure drop through dampers shall not exceed 0.05 inch water gage at 1,000 fpm in the wide-open position. Frames shall not be less than 2 inches wide. Dampers shall be tested in accordance with AMCA 500-D.
  
2. Operating Links: Operating links external to dampers, such as crank arms, connecting rods, and line shafting for transmitting motion from damper actuators or dampers, shall withstand a load equal to at least twice the maximum required damper-operating force. Rod lengths shall be adjustable. Links shall be brass, bronze, or stainless steel. Mating parts shall consist of dissimilar materials. Working parts of joints and clevises shall be brass, bronze, or stainless steel. Adjustments of crank arms shall control the open and closed positions of dampers.

2.10 VIBRATION ISOLATION

A. Manufacturer Responsibility

1. Manufacturer of vibration equipment shall have the following responsibilities:
  - a. Guarantee specified isolation system deflections.



- b. Provide installation instructions, drawings and field supervision to ensure proper installation and performance of systems.

B. Quality Assurance

1. All vibration isolators shall have calibration markings or some method to determine adjustment, the actual deflection under the imposed load after installation and adjustment.
2. All isolators shall operate within the linear position of their load vs. deflection curves. Load vs. deflection curves shall be furnished by the manufacturer and must be linear over a deflection range of not less than 50% above the design deflection.
3. The theoretical vertical natural frequency for each support point, based upon load per isolator and isolator stiffness, shall not differ from the design objectives for the equipment as a whole by more than  $\nabla 10\%$ .
4. Substitution of internally isolated equipment in lieu of the isolation specified in this section, is acceptable provided all conditions of this section are met. The equipment manufacture shall provide a letter of guarantee stating that the specified noise and vibration levels will be obtained or the cost of converting to the specified external vibration isolation shall be born by the equipment manufacturer.
5. The following specifications describe spring hanger with 30 degree misalignment feature. This requirement is mandatory. Replace any hangers without the 30 degree capability at no additional cost to the Owner.

C. Description

1. All vibration isolation devices shall be the product of a single manufacturer. Products of other manufacturers are acceptable provided their systems strictly comply with intent, structural design, performance, and deflections of the base manufacturer.
2. Acceptable manufacturers of vibration isolation products shall be: Mason Industries, Amber Booth Company, Peabody Noise Control, Korfund Dynamics Corporation, Vibration Mountings and Equipment, Vibration Eliminator Co., provided they meet the requirements of the Specifications. Mason Industries model numbers have been used in the Specifications to establish quality of components, but are in no way to limit competitive bidding by other manufacturers.
3. Refer to Table A at the end of this Article for application of the various types listed to appropriate equipment and efficiency level.

D. Vibration Isolation Types

1. Vibration Isolators

- a. Type A: Spring Isolator Mason Industries Type SLF
  - (1) Having a minimum OD to OH of 0.8:1.
  - (2) Springs cadmium plated, hardware cadmium plated and all other metal parts hot-dip galvanized.
  - (3) Reserve deflection (from loaded to solid height) of 50% of rated deflection.
  - (4) Minimum ¼ inch thick neoprene acoustical base pad on underside.
  - (5) Designed and installed so that ends of springs remain parallel.
  - (6) Non-resonant with equipment forcing frequencies or support structure natural frequency.

2. Mason Ind. Type ND or Rails Type DNR

- a. Type E: Elastomer hanger rod isolator.
  - (1) Molded (min. 1 ¾ inch thick) neoprene element with projecting bushing lining the rod clearance hole. Static deflection at rated load shall be a minimum of 0.35 inches.
  - (2) Steel retainer box encasing neoprene mounting capable of supporting equipment up to four times the rated capacity of the element.

3. Mason Ind. Type WF

- a. Type J: Steel Rails.
  - (1) Steel members of sufficient strength to prevent equipment flexure during operation.
  - (2) Height saving brackets as required to reduce operating height and cradle the unit.

E. Execution

- 1. General: Isolation systems just be installed in strict accordance with the manufacturer's written instructions. Vibration isolator shall not cause any change of position of equipment resulting in stress on equipment connections.
- 2. Equipment Installation
  - a. Equipment shall be isolated as per Table A below.
  - b. Additional requirements:

- (1) After the entire installation is complete, and under full operational load, the isolators shall be properly adjusted. Verify that there are no short circuits of the isolation. The equipment shall be free in all directions.
- (2) Install equipment with flexibility in wiring.

**TABLE A**

Equipment	Mounting	Isolation	Deflection	Base
Energy Recovery Unit	Clg	A	0.75	J
Unit Heater	Clg	E	0.30	-

NOTES:

1. "Isolation" and "Base" column indicates letter type as it appears in the Specifications.
2. "Mounting" refers to method of support of equipment from the structure.

2.11 INSULATION

- A. All insulation, adhesives, tape, etc. shall conform to NFPA 90A. No voids in insulation will be permitted.
- B. Pipe Insulation.
  1. Insulation shall comply with ASTM E84 or UL 723.
  2. Insulation shall have a thermal conductivity of 0.245 at 75 deg. F mean temperature and shall have a 25/50 Flame Spread and Smoke Developed Index.
  3. Insulation shall include antimicrobial protection for the inhibition of mold and mildew growth.
  4. Installation shall meet manufacturer's recommendations. Seal butt joints with insulation manufacturers approved adhesive.
  5. Outside above ground insulation shall be protected with two coats of approved vinyl lacquer coating over woven glass mesh adhered to insulation with Insulcolor or approved equal lagging adhesive, as recommended by manufacturer.
  6. Fuel oil supply and return lines, and cooling coil condensate lines shall be insulated with 1" thick rigid closed cell foam insulation, AP/Armaflex, Manville, Owens Corning or approved equal.
- C. Duct Insulation
  1. 2" thick, semi rigid fibrous glass boards with factory applied fire retardant foil reinforced kraft vapor barrier facing. Multiple layers shall be applied to result in an installed insulating value of R-12.
  2. Insulation density shall be 3 lb./cf with maximum K factor of 0.23 at 75°F mean

temperature.

3. Impale insulation on mechanical fasteners applied to duct surface on 12" centers. Use at least two rows of fasteners on each side of duct. Provide fastener rows within 3" of seams and edges. Secure insulation with suitable speed washers or clips firmly embedded in insulation. Provide additional fasteners as necessary on cross broken ducts.
4. Extend insulation to standing seams, reinforcing, and other vertical projections 1" and less; do not carry over. Vapor barrier jacket shall be continuous across seams, reinforcing and projections. Insulation and jacket shall be carried over projections that exceed insulation thickness.
5. Transverse joints shall be butted tightly. Longitudinal joints shall be butted, ship lapped or 45° mitered. Seal joints with 4" wide strips of approved vapor barrier patch material and adhesive, or with approved pressure sensitive vapor barrier tape.
6. Cover breaks, ribs and standing seam penetrations with patch of jacket material no less than 2" beyond break; secure with adhesive and staple. Seal staples and joints with brush coat of vapor barrier coating.
7. Fill voids in insulation at jacket penetrations and seal with vapor barrier coating.
8. Seal and flash terminations and punctures with fibrous glass cloth between two coats of vapor barrier coating.
9. Terminate vapor barrier and extend insulation at standoff brackets.
10. Outdoor ductwork shall be jacketed with a weatherproof covering equal to VentureClad.

## 2.12 AUTOMATIC CONTROLS

### A. General:

1. Provide a complete standalone electric/electronic temperature control system for each piece of HVAC equipment.
2. If a piece of HVAC equipment requires microprocessor control and microprocessor control is not available from the HVAC equipment manufacturer, then Terminal Equipment Controllers from Tekmar, Honeywell, Johnson Controls or other approved vendors shall be furnished, installed, connected and programmed by the HVAC Subcontractor to provide the functionality described in the Sequence of Operation in the following sections.

### B. Scope:

1. Control system shall consist of thermostats, humidistats, temperature sensors, microprocessor controllers, automatic valves and dampers, damper operators, control panels, electrical wiring and other components required to fill intent of Specifications and provide for complete and operable system. Control equipment shall be fully proportioning, except as noted otherwise. Sequence of operation

shall be as indicated below.

- C. The HVAC Subcontractor shall furnish, install or provide electric automatic control devices as indicated on the drawings and in these specifications.
- D. Furnish and Install:
  - 1. Automatic damper actuators. (Unless furnished with equipment)
  - 2. Temperature Control Valves (Unless furnished with equipment)
  - 3. Outdoor air inlet temperature sensor for ERVs.
  - 4. Outdoor air discharge temperature sensor for ERVs.
  - 5. Remote Wall Mounted Controller for ERV units.
  - 6. Discharge temperature for ERV units.
  - 7. Thermostats for unit heaters.
- E. Submittals
  - 1. The following shall be submitted for approval:
    - a. Data sheets for control system components.
- F. Instruction and Adjustment
  - 1. Upon Completion of the Work, the HVAC Subcontractor shall:
    - a. Completely adjust and ready for use: thermostats, controllers, actuators and other components and equipment provided under this section.
    - b. Furnish operation and maintenance manuals covering function and operation of control systems on project for use by Owner's operating personnel. Competent technician shall be provided for instruction purposes.
    - c. Provide adequate instruction (not less than 2 hours) to the Owners personnel by means of a competent technician. Obtain written confirmation from the Owner that adequate instructions for each system has been provided in an acceptable manner.
- G. **All temperature control wiring, wiring connections and rigid conduit shall be provided by DIVISION 15 - HVAC. All sensing and control wiring for the Tank Gauge Leak Detection system shall be provided by Division 15 - HVAC. See section 15100 for details of the TGLD system. All control wiring shall be run in rigid conduit. Conduit and wiring for power connections (including 120 VAC for SCADA interface panels) will be provided under DIVISION 16 - ELECTRICAL. Conduit and wiring for SCADA between contacts in panels and equipment and the SCADA system will be provided under DIVISION 16 - ELECTRICAL.**
- H. Provide components factory ordered for this project. Rebuilt equipment, warehoused equipment, or earlier generation equipment shall not be acceptable. Electrical and electronic shall have a NEMA 250 Type 4 enclosure in accordance with NEMA 250 unless otherwise indicated on the Contract Drawings. Actuators shall operate within limit ratings of minus 35 to 150 degrees F.

I. Actuators. Provide electric spring return actuators. Actuators shall function as required within 85% to 110% of their power supply rating. Actuators shall fail to their spring return positions on signal or power failure. Actuators shall have visible position indicators. Actuators shall open or close the devices to which they are applied within 60 seconds after a full scale signal input change. **All actuators shall be 24 VAC. HVAC Subcontractor shall provide all required 120/24 volt transformers for controls.**

1. Damper actuators shall be rated for at least 125% of the motive power necessary to operate the connected damper. The actuator stroke shall be limited by an adjustable stop in the direction of the return stroke. Actuators shall be provided with mounting and connecting hardware.

2. Confirm voltage with DIVISION15 prior to ordering actuators.

J. Thermostats

1. 25-Amps, 120 - 240 VAC
2. 22 - Amps, 277 VAC
3. Positive Snap-Action Switch for Heating Control
4. SPDT Contacts
5. NEMA 4X Weatherproof Enclosure
6. 40 - 100°F Temperature Range
7. 2.5°F Differential
8. Chromalox model WCRT-100

K. Humidistats

1. Honeywell model H46 model humidistat.
2. Fully enclosed, dust free, SPST, snap-acting switch
3. Impact- resistant, molded plastic cover mounts on wall
4. Positive on and off settings permit manual operation of controlled equipment.
5. 120 VAC, 7.5 A
6. 240 VAC, 15.0 A
7. Differential: 4 To 6 Percent RH
8. 50 To 125 Degrees F
9. Operating Humidity Range: 20 To 80 Percent RH
10. Dial Control

L. Temperature Sensors and Transmitters

1. Temperature sensors shall conform to the following minimum standards. Additional specifications are given for specific applications below.
  - a) Sensors shall be accurate to +0.25°F over minimum operating ranges.
  - b) Sensor, associated circuitry and readout shall have minimum resolution of 0.25°F.
  - c) Sensors shall withstand ambient temperatures of -30°F to 240°F, but performance requirements must be met only for ranges specified.
2. Provide thermistor (1000 ohms or greater) or resistance temperature detector (RTD) sensors, for the following applications and minimum operating ranges.

- a) Wall Mount Space Sensor 40° F to 100°F
  - b) Duct Mount Sensor 20°F to 120°F
3. Provide thermistor (1000 ohms or greater) or resistance temperature detector (RTD) sensors, for outside air temperature measurement. Sensor shall be mounted in 24 hour shade location, in proximity to a light colored wall, in an aspirated enclosure insulated with foam from thermal transfer with adjacent structure. Sensor shall operate within the following minimum range: -20°F to 120°F.
  4. Provide averaging resistance temperature detector (RTD) sensor only, for mixed air measurement. Sensor shall provide a minimum duct coverage of 1 foot per 2 feet of duct. Sensor shall not come in direct contact with coils. The sensor shall operate within the following range: 30°F to 120°F.

## 2.13 SEQUENCE OF OPERATION

A. Control sequences of operation shall be as follows:

### B. ENERGY RECOVERY UNITS

- a. The following sequence of control shall be programmed into the controller by the manufacturer at the factory.
- b. Provide a relay contact for the SCADA system to enable/disable the unit operation. The unit shall be locally started manually and run continuously until manually shut off. A remote wall mounted two position switch with pilot light shall control the unit as follows: when the switch is in the “Low Vent” (Unoccupied) position the unit fans shall run at a speed that provides 6 air changes in the served space. When the switch is in the “High Vent” (Occupied) position, the unit fans shall run at a speed that provides 12 air changes in the served space.
- c. The unit’s programmable DDC controller shall modulate the heat recovery wheel and heating coil in sequence to control supply air temperature. Supply air temperature is reset between occupied (60-degrees) or unoccupied (50-degrees) temperature setpoints by a remote two-position wall mounted manual switch.
- d. The unit Outdoor Air supply damper shall be controlled to open to supply an airflow equal to ½ the maximum airflow (“Low Vent”) as measured by the Airflow Station in the Outdoor Air Intake when the wall switch or SCADA input is set to Low Vent. The unit Outdoor Air supply damper shall be controlled to open to supply an airflow equal to the maximum airflow (“High Vent”) as measured by the Airflow Station in the Outdoor Air Intake when the wall switch or SCADA input is set to High Vent. The duct mounted static pressure sensor will control the supply fan motor speed to maintain a static pressure in the duct sufficient to supply the space supply airflows noted on the drawings.
- e. The unit exhaust fan shall be interlocked with the supply fan control to exhaust an amount of air that equals the Outdoor Air airflow. Airflow quantity shall be verified by the exhaust Airflow Station.

- e. A signal from the smoke detector mounted in the supply air duct shall shut down the unit and alarm to the Fire Alarm Control Panel. Upon shutdown the Outdoor Air and Exhaust Air dampers shall close.
  - f. When the outdoor air temperature is above 50 deg F but below 76 deg F, the wheel shall be stopped and the bypass dampers shall open to allow outdoor air to bypass the wheel and flow directly into the served space.
- C. ELECTRIC UNIT HEATERS:
- a. A local thermostat will close the contacts on a control relay and cycle the fan to maintain space temperature setpoint.

## PART 3 - EXECUTION

### 3.1 GENERAL

- A. Install all items specified under this section according to the manufacturer's requirements, shop drawings, the details as shown on the Contract Drawings and/or as specified.
- B. Install all Work so that parts requiring inspection, replacements, maintenance and repair shall be readily accessible. Minor deviations from the Contract Drawings may be made to accomplish this, but any substantial change shall not be made without prior written approval from the Owner.
- C. Equipment bases mounted on concrete slabs and pads, or mounted on stands, gratings, platforms, or other, shall not be set in any manner, except on the finished and permanent support.
- D. Support of equipment on studs or other means, and the placing or building of the supporting slab, pad, pier, stand, grating, or other "to the equipment", is prohibited.
- E. Concrete supporting structures shall have been constructed and cured a minimum of 14 days before equipment is mounted.

### 3.2 OPENINGS

- A. The responsibility for determining the exact size and location of openings is part of the Work of this section. If this responsibility is not met, cutting and patching to achieve the correct size and location of openings and chases is part of the work of this section.

### 3.3 CUTTING AND PATCHING

- A. Do all cutting and patching required except cutting and patching of finish (visible) materials. Cutting and patching of masonry walls, partitions, ceilings and floors is included. Concrete cutting shall be done with abrasive wheels or saws, and coring with a diamond core bit. Jackhammers are prohibited.

### 3.4 CONNECTIONS TO EQUIPMENT

- A. Connections shall be provided by the HVAC Subcontractor unless otherwise indicated.



Unless otherwise indicated, the size of the connections to each piece of equipment shall be not smaller than the connections on the equipment. No bushed connections shall be permitted. Change in sizes shall be made with reducers or increasers only.

3.5 Furnish and install and isolation valves on the refrigeration lines for each piece of refrigeration equipment. Each ACCU and each Fan Coil Unit shall be separately isolated. SUPPORTS

A. General

1. Hangers used to support piping 2 inches and larger shall be fabricated to permit adequate adjustment after erection while supporting the load.

B. Pipe Hangers and Supports

1. Pipe hangers and supports shall conform to MSS SP-58 and MSS SP-69, except as specified as follows:
  - a. Types 5, 12, and 26 shall not be used.
  - b. Type 3 shall not be used on insulated pipe which has a vapor barrier. Type 3 may be used on insulated pipe that does not have a vapor barrier if clamped directly to the pipe and if the clamp bottom does not extend through the insulation and the top clamp attachment does not contact the insulation during pipe movement.
  - c. Type 19 and 23 C-clamps shall be torqued per MSS SP-69 and have both locknuts and retaining devices, furnished by the manufacturer. Field-fabricated C-clamp bodies or retaining devices are not acceptable.
  - d. Type 20 attachments used on angles and channels shall be furnished with an added malleable iron heel plate or adapter.
  - e. Type 24 may be used only on trapeze hanger systems or on fabricated frames.
  - f. Horizontal pipe supports shall be spaced as specified in MSS SP-69 and a support shall be installed not over 1 foot from the pipe fitting joint at each change in direction of the piping. Pipe supports shall be spaced not over 5 feet apart at valves.
  - g. Vertical pipe shall be supported at intervals of not more than 15 feet, except that pipe shall be supported not more than 8 feet from end of risers, and at vent terminations.
  - h. Except for Type 3, pipe hangers on horizontal insulated pipe shall be the size of the outside diameter of the insulation.

3.6 PIPE EXPANSION

- A. The expansion of pipes shall be provided for by changes in the direction of the run of pipe to produce expansion loops and doglegs.

### 3.7 CONDENSATE PIPING

- A. Furnish and install condensate piping from the drain connection at each cooling coil drain pan to outside and terminate with a downward facing ell. Run piping in rectilinear fashion parallel to refrigeration piping.

### 3.8 DUCTWORK

- A. Installation shall be according to SMACNA HVAC DUCT CONSTRUCTION STANDARDS, latest edition unless otherwise indicated. Duct supports for sheet metal ductwork shall be according to SMACNA HVAC DUCT CONSTRUCTION STANDARDS, latest edition unless otherwise specified. Friction beam clamps indicated in SMACNA HVAC DUCT CONSTRUCTION STANDARDS, latest edition unless otherwise indicated shall not be used. Supports shall be attached only to structural framing members. Supports shall not be anchored to metal decking unless a means is provided and approved for preventing the anchor from puncturing the metal decking. Where supports are required between structural framing members, suitable intermediate metal framing shall be provided. Where C-clamps are used, retainer clips shall be provided.
- B. Dust Control: To prevent the accumulation of dust, debris and foreign material during construction, temporary dust control protection shall be provided. The distribution system (supply and return) shall be protected with temporary seal-offs at all inlets and outlets at the end of each day's Work. Temporary protection shall remain in place until system is ready for startup.

### 3.9 AIR SYSTEMS BALANCING

- A. The building shall be essentially complete with final ceiling, walls, windows, doors and partitions in place. Doors and windows surrounding each area to be balanced shall be closed during testing and balancing operations. Air systems shall be complete and operable with piping, registers, ducting, diffusers, returns, terminals and control components in place. Fans shall be operational. Air motion and distribution from air terminals shall be as shown. All data including deficiencies encountered and corrective action taken shall be recorded. If a system cannot be adjusted to meet the design requirements, promptly notify the Engineer in writing.
- B. The procedures followed for balancing of the air systems shall comply with and shall include the documentation forms of one of the following:
  - a. NEBB: "Procedural Standards for Testing, Adjusting, and Balancing of Environmental Systems".
  - b. AABC: "National Standards for Total System Balance."
  - c. SMACNA: "HVAC Systems Testing, Adjusting and Balancing."
- C. Air Systems
  - 1. Each system shall be adjusted until all flow quantities are within plus 10% and minus 0% and the results shall be recorded. Dampers shall be checked for tight shutoff. Air leakage around dampers shall be verified. Fans shall be checked for correct direction of rotation and proper speed shall be verified.

## 2. General Balancing Methods

- a. Air flow adjustments shall be made by first adjusting the fan speed to meet the design flow conditions. Flows shall be checked at all supply and exhaust outlets. All flows shall be recorded before and after each adjustment.

## C. Control Systems

1. Testing, adjusting, and balancing of the systems shall be coordinated with the control system installation. All control components shall be verified to be properly installed and operating as specified before proceeding with testing, adjusting, and balancing. Verification shall be in accordance with AABC MN-1.
2. Adjustment of the temperature controls shall be coordinated by the person in charge of the balancing and adjusting and shall be performed coincidental therewith. Simulate a complete cycle of operation for each system.

## 3.10 BASES AND SUPPORTS

- A. In addition to supports and hangers as mentioned in Section 05500, provide all bases and supports not part of the building structure, of required size, type, and strength, as approved by the Engineer, for all equipment and materials furnished by him. All equipment, bases and supports shall be adequately anchored to the building structure to prevent shifting of position under operating conditions.
- B. All concrete foundations and all concrete supports will be provided by the General Contractor. Furnish shop drawings and templates for all concrete foundations and supports for setting all required hanger and foundation bolts and other appurtenances necessary for the proper installation of his equipment.

## 3.11 CONCRETE SUPPORT PADS

- A. The HVAC Subcontractor shall forward to the General Contractor (GC) approved submittals of all HVAC equipment requiring concrete support pads. The submittals shall include the locations and size of anchor bolts. GC shall form and pour 4 inch high support concrete pads with the embedded anchors. Pads shall extend a minimum of 6 inches beyond the equipment footprint.

## 3.12 MISCELLANEOUS IRON AND STEEL

- A. All Work shall be cut, assembled, welded and finished by skilled mechanics. Welds shall be ground smooth. Stands, brackets, and framework shall be properly sized and firmly constructed.
- B. Measurements shall be taken on the job and worked out to suit adjoining and connecting Work. All Work shall be by experienced metal working mechanics. Members shall be straight and true and accurately fitted. Scale, rust, and burrs shall be removed. Welded joints shall be ground smooth where exposed. Drilling, cutting and fitting shall be done as required to properly install the work and accommodate the work of other trades as directed by them.

- C. Members shall be generally welded, except that bolting may be used for field assembly where welding would be impractical.
- D. All shop fabricated iron and steel work shall be cleaned and dried and given a shop coat of paint on all surfaces and in all openings and crevices.

### 3.13 PLACING IN SERVICE

- A. At the completion of performance tests and following approval of test result, recheck all equipment to see that each item is adequately lubricated and functioning correctly.

### 3.14 CLEANING AND ADJUSTING

- A. During the progress of the Work, clean up and remove all oil, grease, and other debris caused by the Work performed under this section.
- B. At the conclusion of the Project, clean and repair all areas and finishes as installed or affected by this installation of Work under this section.
- C. Equipment: Equipment shall be wiped clean, with all traces of oil, dust, dirt, or paint spots removed. System shall be maintained in this clean condition until final acceptance. Bearings shall be properly lubricated with oil or grease as recommended by the manufacturer. Belts shall be tightened to proper tension.

### 3.15 INSULATION

- A. Application - General
  1. Installation: Except as otherwise specified, material shall be installed in accordance with the manufacturer's written instructions. Insulation materials shall not be applied until tests specified in other sections of the Specifications are completed. Material such as rust, scale, dirt and moisture shall be removed from surfaces to receive insulation. Insulation shall be kept clean and dry. Insulation shall not be removed from its shipping containers until the day it is ready to use and shall be returned to like containers or equally protected from dirt and moisture at the end of each workday. Insulation that becomes dirty shall be thoroughly cleaned prior to use. If insulation becomes wet or if aforementioned cleaning does not restore the surfaces to like new condition, the insulation may be rejected, and if rejected, shall be immediately removed from the jobsite. Joints shall be staggered on multilayer insulation. Mineral fiber thermal insulating cement shall be mixed with demineralized water when used on stainless steel surfaces. Insulation, jacketing and accessories shall be installed in accordance with MICA-01 standard plates except where modified herein or on the Contract Drawings.
  2. Firestopping: Where pipes pass through fire walls and fire partitions, the penetration shall be sealed with firestopping materials as specified.
  3. Flexible Cellular Insulation: Flexible cellular insulation shall be installed with seams and joints sealed with a contact adhesive. Flexible cellular insulation shall not be used on surfaces greater than 200 degrees F.

## B. Pipe Insulation Installation

1. General: Pipe insulation shall be continuous and installed on fittings and appurtenances unless specified otherwise. Installation shall be with full length units of insulation and using a single cut piece to complete a run. Cut pieces or scraps abutting each other shall not be used.
2. Pipes Passing Through Sleeves
  - a. Pipe insulation shall be continuous through the sleeve.
  - b. An aluminum jacket with factory applied moisture barrier shall be provided over the insulation wherever penetrations require sealing.
  - c. Where penetrating interior walls, the aluminum jacket shall extend 2 inches beyond either side of the wall and shall be secured on each end with a band.
  - d. Where penetrating floors, the aluminum jacket shall extend from a point below the backup material to a point 10 inches above the floor with one band at the floor and one not more than 1 inch from the end of the aluminum jacket.
  - e. Where penetrating exterior walls, the aluminum jacket required for pipe exposed to weather shall continue through the sleeve to a point 2 inches beyond the interior surface of the wall.
3. Pipes Passing Through Hangers
  - a. Insulation, whether hot or cold application, shall be continuous through hangers. All horizontal pipes 2 inches and smaller shall be supported on hangers with the addition of a Type 40 protection shield to protect the insulation in accordance with MSS SP-69 whenever insulation shows signs of being compressed, or when the insulation or jacket shows visible signs of distortion at or near the support shield, insulation inserts as specified below for piping larger than 2 inches shall be installed.
  - b. Inserts shall be covered with a jacket material of the same appearance and quality as the adjoining pipe insulation jacket, shall overlap the adjoining pipe jacket 1-1/2 inches, and shall be sealed as required for the pipe jacket. The jacket material used to cover inserts in flexible cellular insulation shall conform to ASTM C 921, Type 1, and is allowed to be of a different material than the adjoining insulation material.
4. Flexible Cellular Pipe Insulation: Flexible cellular pipe insulation shall be tubular form. Sweat fittings shall be insulated with miter cut pieces the same size as on adjacent piping.

## C. Duct Insulation Installation

1. Insulate supply and exhaust ductwork outdoors from the roof or wall penetration to ERVs to a value of R-12. Cover outdoor ductwork with weatherproof jacketing equal to VentureClad.

2. Insulation shall be attached by applying Class 2 adhesive around the entire perimeter of the duct in 6 inch wide strips on 12 inch centers.
  3. For ducts and plena, 24 inches and larger insulation shall be additionally secured to bottom of ducts by the use of mechanical fasteners. Fasteners shall be spaced on 18-inch centers and not more than 18 inches from duct corners.
  4. Insulation shall be impaled on the mechanical fasteners where used and shall be pressed thoroughly into the adhesive. Care shall be taken to ensure vapor barrier jacket joints overlap 2 inches. The insulation shall not be compressed to a thickness less than that specified. Insulation shall be carried over standing seams and trapeze-type duct hanger. Self-locking washers shall be installed where mechanical fasteners are used. The pin shall be trimmed back and bent over.
  5. Jacket overlaps shall be secured under the overlap with Class 2 adhesive and stapled on 4 inch centers. Staples and seams shall be coated with a brush coat of vapor barrier coating.
  6. Breaks in the jacket material shall be covered with patches of the same material as the vapor barrier. The patches shall extend not less than 2 inches beyond the break or penetration in all directions and shall be secured with Class 2 adhesive and staples. Staples and joints shall be sealed with a brush coat of vapor barrier coating.
  7. At jacket penetrations such as hangers and damper operating rods, voids in the insulation shall be filled and the penetration sealed with a brush coat of vapor barrier coating.
  8. Insulation terminations and pin punctures shall be sealed and flashed with a reinforced vapor barrier coating finish. The coating shall overlap the adjoining insulation and uninsulated surface 2 inches. Pin puncture coatings shall extend 2 inches from the puncture in all directions.
  9. Where insulation standoff brackets occur, insulation shall be extended under the bracket and the jacket terminated at the bracket.
- D. Duct Test Holes: after duct systems have been tested, adjusted, and balanced, breaks in the insulation and jacket shall be repaired in accordance with the applicable section of this specification for the type of duct insulation to be repaired.

### 3.16 OPERATING AND MAINTENANCE INSTRUCTIONS

- A. Operation and Maintenance Manuals shall be provided in accordance with Section 01730. All operating equipment installed under this section shall be placed in operation and shall function continuously in an operating test for a period of one week without shutdown due to mechanical failure or necessity of adjustment. Prior to scheduling the Project Final Inspection and after completion of all installation and running adjustments, perform all work required to place the equipment in complete operating condition to meet all requirements under the Specifications.
- B. During this running test period, deliver to the designated representative of the Owner, through the Engineer, 6 complete sets of operating, service and replacement data for all

equipment which will require operating maintenance or replacement and one copy of this literature shall be available during the instruction of the operating personnel while the other is checked for completeness by the Engineer.

### 3.17 TRAINING

- A. Conduct a training course for the maintenance and operating staff. The training period of eight (8) hours normal working time shall start after the system is functionally complete but before the final acceptance tests. The training shall include all of the items contained in the operating and maintenance instructions as well as demonstrations of routine maintenance operations. The Engineer shall be given at least 2 weeks advance notice of such training.
- B. During all working hours of the one-week operating test, instruction personnel shall be available for and provide thorough and detailed training to the Owner's operating and maintenance personnel in operation, maintenance and adjustment of all equipment installed.
- C. Give sufficient notice to the designated operating personnel of the owner in advance of this period. Upon completion of instruction, obtain from such representatives written verification on that which the above-mentioned instruction has been performed, such verification to be forwarded to the Engineer.

END OF SECTION

## **DIVISION 16**



## SECTION 16000

### BASIC ELECTRICAL REQUIREMENTS

#### PART 1 – GENERAL

##### 1.1 DESCRIPTION

- A. The work of this section includes all labor, materials, tools, equipment, and accessory items and performing all operations necessary to furnish and install the complete electrical work in accordance with this section of these specifications, the drawings and the standards of the applicable codes listed herein.
- B. The work shall include, but not be limited to, furnishing and installation of equipment and items listed below and installation only of items furnished under other sections of these specifications.
  - 1. Conduit, wire and electrical connections are required on certain items specified in sections of these specifications other than the electrical section. This Contractor shall examine all sections of these specifications to determine the complete scope of the electrical work.
  - 2. Raceways and fittings
  - 3. Wires and cables
  - 4. Variable Frequency Drives
  - 5. Miscellaneous equipment
  - 6. Panelboards
  - 7. Motor Control Centers
  - 8. Lighting systems
  - 9. Underground system
  - 10. Grounding systems
  - 11. Fire Alarm system
  - 12. Demolition of existing electrical systems.
- C. Mount and wire operator's stations, power conversion equipment, and motor control systems furnished under other Divisions of these Specifications.
- D. Install and make all field connections to variable frequency drives, process instrument panels and other control panels furnished under other Divisions of these Specifications.

- E. Mount and wire process instruments and control cabinets furnished under other Divisions of these Specifications. Furnish and install all conduit, wire and interconnections between process instrumentation primary elements, transmitters, local indicators and receivers. Mount and wire all lightning and surge protection equipment at process instrumentation transmitters and receivers.
- F. Mount and make field connections to “packaged” equipment furnished under other Divisions of these Specifications.
- G. Provide conduit and power wiring for all HVAC (Heating, Ventilation and Air Conditioning) and Plumbing equipment furnished under other Divisions of these Specifications.
- H. Documents Applicable to the Work of this Section:
  - 1. Division 0 of the Contract Documents (Contract Forms and Requirements).
  - 2. Division 1 of the Technical Specifications.
  - 3. Technical Specifications: Section 16000 - Basic Electrical Requirements, and the following sub-sections:
    - a. Section 16060 – GROUNDING SYSTEM
    - b. Section 16080 – UNDERGROUND SYSTEMS
    - c. Section 16085 – MISCELLANEOUS EQUIPMENT
    - d. Section 16120 – WIRE AND CABLES
    - e. Section 16130 – RACEWAYS AND FITTINGS
    - f. Section 16442 – PANELBOARDS
    - g. Section 16495 – VARIABLE FREQUENCY DRIVES
    - h. Section 16500 – LIGHTING SYSTEM
    - i. Section 16721 – FIRE ALARM SYSTEMS

## 1.2 SUBMITTALS

- A. Submit the following in accordance with Section 01300:
  - 1. Circuit breakers
  - 2. Variable Frequency Drives
  - 3. Motor Control Centers
  - 4. Dry type transformers
  - 5. Panelboards
  - 6. Lighting fixtures
  - 7. Disconnect switches
  - 8. Control stations
  - 9. Miscellaneous equipment
  - 10. Fire Alarm System
- B. The manufacturer's data sheets with product designation or catalog numbers shall be submitted for the following material:
  - 1. Wire

2. Conduit
  3. Receptacles
  4. Boxes and fittings
- C. Submit all other data as specified herein.
- D. The responsibility for all dimensions to be confirmed and correlated at the job site and for coordination of this work with the work of all other trades is also included under the work of this Section 16000.
- E. No material shall be ordered or shop work started until the Engineer's approval of shop drawings has been given.
- F. Prior to submitting shop drawings for lighting fixtures, verify the type of ceiling suspension systems being installed. Notify Engineer of any discrepancies between fixture type specified and suspension system. Additional cost rising from failure to notify the Engineer will be the responsibility of the Contractor.
- G. Operation and Maintenance Manuals - Prepare manuals in accordance with Section 01730.
- H. Record Drawings - Prepare as specified in Part 1 of this Section.

### 1.3 DELIVERY, STORAGE AND HANDLING

- A. Provide in accordance with Section 01600 and as specified herein.
- B. Electrical equipment shall at all times during construction be adequately protected against mechanical injury or damage by water. Electrical equipment shall not be stored out-of-doors. Electrical equipment shall be stored in dry permanent shelters. If stored for more than two weeks, the equipment shall receive all maintenance considerations required by the manufacturer for the proper storage of equipment. Proper storage in this context shall include the provision of heaters and dehumidifiers to keep the equipment dry at all times. If any apparatus has been damaged, such damage shall be repaired at no additional cost to the Owner. If any apparatus has been subject to possible injury by water, it shall be thoroughly dried out and put through such special tests as directed by the Engineer, or shall be replaced at no additional cost to the Owner.

### 1.4 DESIGN CRITERIA

- A. Service Characteristics
1. Primary Utility Voltage: 13.8KV
  2. Secondary Building Voltage - High Level: 480/277 V
  3. Secondary Building Voltage - Low Level: 120/208V
  4. All equipment and wiring shall be suitable for the applied voltage.

B. Requirements of the Regulatory Agencies

1. The final, complete installation shall comply with all state and local statutory requirements having jurisdiction. The Contractor shall arrange for all necessary permits, pay all fees and arrange for all required inspections by local authorities. In general, all work shall comply with the requirements of the National Electrical Code, all state codes and the codes and ordinances of the city or town in which the work is to be done.

C. Tests and Settings

1. Test all systems furnished under DIVISION 16 - ELECTRICAL and repair or replace all defective work. Make all necessary adjustments to the systems and instruct the Owner's personnel in the proper operation of the system.
2. Make all circuit breaker and motor circuit protector settings based on the connected equipment manufacturer's recommendations.
3. The following minimum tests and checks shall be made prior to the energizing of electrical equipment. A certified test report shall be submitted stating that the equipment meets and operates in accordance with manufacturer's and job specifications, and that equipment and installation conforms to all applicable standards and specifications.
  - a. Testing of protective relays, static devices, transfer switches, circuit breakers and motor circuit protectors for calibration and proper operation and settings.
  - b. Over potential, high potential, insulation resistance and shield continuity tests for cables.
  - c. Mechanical inspection of switches, transfer switches and circuit breakers.
4. The Engineer shall be immediately notified of any unfavorable test results or indication of faulty equipment. No piece of equipment shall be energized until the test data is evaluated and the equipment is proven acceptable.
5. If the test and inspection data submitted should indicate deficiencies in the operation of the electrical apparatus or in the manufacturer thereof, the Contractor shall promptly implement the necessary adjustments, corrections, modifications and/or replacements necessary to be made to meet the specified requirements.

1.5 RELATED WORK NOT INCLUDED

- A. Concrete work, including concrete electrical duct encasement, is included under DIVISION 3 - CONCRETE of these Specifications.

1.6 SLEEVES AND FORMS FOR OPENINGS`

- A. Provide and place all sleeves for conduits penetrating floors, walls, partitions etc. When located in formed concrete walls locate all necessary slots for electrical work and form before concrete is poured.
- B. Provide waterproof sealing for the penetrations through exterior walls, etc.
- C. Provide fireproof sealing for penetrations through fireproof walls, etc.
- D. Foam type fire and water proofing is not allowed.

#### 1.7 CUTTING AND PATCHING

- A. All openings required by the work of these Sections shall be planned for in advance. Any cutting and patching required by the lack of such planning shall be done by the General Contractor at the expense of this Contractor. It will be the responsibility of this Contractor to keep the General Contractor informed of all required openings.

#### 1.8 CORING

- A. Provide all coring for conduits penetrating floors, walls, partitions etc.
- B. Provide waterproof sealing for the penetrations through exterior walls, etc.
- C. Provide fireproof sealing for penetrations through fireproof walls, etc.
- D. Foam type fire and water proofing is not allowed.

#### 1.9 ELECTRICAL HAZZARDOUS CLASSIFCATION AND NEMA RATINGS FOR ELECTRICAL INSTALATION AND ENCLOSURES

- A. Unclassified, NEMA Type 12 for Building interior except as noted below.
- B. Unclassified, NEMA Type 4X for Building interior for a radius of 15' within a room around process equipment.
- C. Unclassified, NEMA Type 4X for Building exterior.

#### 1.10 INTERPRETATION OF DRAWINGS

- A. The Drawings are not intended to show exact routing of conduit runs or terminations. Contractor shall determine exact location of conduit terminations by examinations of approved shop drawings. The Contractor shall not reduce the size or number of conduit runs indicated on the drawings.
- B. The final routing of raceways shall be determined by structural conditions, interferences with other trades and by terminal locations on apparatus. The Engineer reserves the right of a reasonable amount of shifting at no extra cost up until time of roughing in the work.

- C. Locate pull boxes, panelboards, control pushbuttons, terminal cabinets, safety switches and such other apparatus as may require periodic maintenance, operation, or inspection, so that they are easily accessible. If such items are shown on the drawings in locations which are found to be inaccessible, advise the Engineer of the situation before work is advanced to the point where extra costs will be involved.
- D. Each three-phase circuit shall be run in a separate conduit unless otherwise shown on the drawings.
- E. Unless otherwise approved by the Engineer conduits shown exposed shall be installed exposed; conduits shown concealed shall be installed concealed.
- F. Where circuits are shown as “home-runs” all necessary fittings and boxes shall be provided for a complete raceway installation.
- G. In general, wiring and raceway systems for lighting, receptacles, fire alarm, telephone and intercommunications systems are not indicated on the drawings but shall be furnished and installed under this section.
- H. Each branch circuit shall have its own neutral, dedicated to that circuit. A common neutral for more than one single phase circuit is not allowed.
- I. Verify with the Engineer the exact locations and mounting heights of lighting fixtures, switches and receptacles prior to installation.
- J. Any work installed contrary to drawings shall be subject to change as directed by the Engineer, and no extra compensation will be allowed for making these changes.
- K. The locations of equipment, fixtures, outlets, and similar devices shown on the drawings are approximate only. Exact locations shall be as approved by the Engineer during construction. Obtain in the field all information relevant to the placing of electrical work and in case of any interference with other work, proceed as directed by the Engineer and furnish all labor and materials necessary to complete the work in an approved manner.
- L. Circuits on three phase panelboards shall be field connected to result in evenly balanced loads on each phase.
- M. Surface mounted panel boxes, junction boxes, conduit, etc., shall be supported by spacers to provide a clearance between wall and equipment.
- N. Circuit layouts are not intended to show the number of fittings, or other installation details. Furnish all labor and materials necessary to install and place in satisfactory operation all power, lighting, and other electrical system shown. Additional circuits shall be wherever needed to conform to the specific requirements of the equipment.
- O. All connections to equipment shall be made as required, and in accordance with the approved shop and setting drawings.
- P. Schematic diagrams shown on the drawings indicate the required functions only. Standard circuits of the particular manufacturer may be used to accomplish the functions indicated without exact adherence to the schematic drawings shown. Additional wiring or conduit required for such deviations shall be furnished at Contractor's expense.

Contractor must ensure that all components necessary to accomplish the required function are provided.

#### 1.11 SIZE OF EQUIPMENT

- A. Investigate each space in the structure through which equipment must pass to reach its final location. If necessary, the manufacturer shall be required to ship his material in sections sized to permit passing through such restricted areas in the structure.
- B. The equipment shall be kept upright at all times. When equipment has to be tilted for ease of passage through restricted areas during transportation, the manufacturer shall be required to brace the equipment suitable, to insure that the tilting does not impair the functional integrity of the equipment.

#### 1.12 WORK IN EXISTING STRUCTURES

- A. Each bidder or his authorized representatives shall, before preparing his proposal, visit all areas of the existing structures in which work under this bid is to be performed and inspect carefully the present installation. The submission of the proposal by this bidder shall be considered evidence that he or his representative has visited the buildings and structures and noted the locations and conditions under which the work will be performed and that he takes full responsibility for a complete knowledge of all factors governing his work.
- B. In general, any or all existing electrical equipment and services are to remain in operation and shall not be disturbed unless otherwise noted in these Specifications and/or on the drawings or as required for the proper execution of the work.
- C. In each area of the work, disconnect and carefully remove the existing electrical equipment and devices so noted. With the exception of items indicated as having to be re-used, all such existing equipment and device shall be turned over to the Owner. If not required by the Owner, remove them from the premises and site. All existing electrical equipment and devices indicated as not removed or abandoned are to be maintained in operation and any circuits disturbed by the construction shall be restored.
- D. Maintain existing electrical services and systems to and in the buildings throughout the project and all "down-time" shall be scheduled at least three weeks in advance with the permission of the Owner and such scheduling shall be rigidly adhered to.

#### 1.13 TEMPORARY POWER AND LIGHTING

- A. The Electrical Subcontractor shall furnish and install feeders of sufficient size from the building's and or plant's power system for the electric light and power requirements for the project while under construction and until the permanent feeders and related equipment have been installed and are in operation. Temporary lighting shall be based on a minimum of one watt per square foot covering each and every square foot in the building. Sufficient wiring, lamps, and outlets shall be installed to insure proper lighting in all rooms, space, and stairwells. Minimum sized lamp used shall be 1500 lumens. Where higher lighting intensities are required by Federal or State Standards of Laws or otherwise specified, the above specified lumens shall be increased to provide these

increased intensities.

- B. All necessary transformers, meters, cables, panelboards, switches, temporary lamp replacements and accessories required for the temporary light and power installation shall be provided by the Electrical Subcontractor.
- C. The Electrical Subcontractor shall provide and maintain in each area of the building and the building exterior, a feeder or feeders of sufficient capacity for the requirements of the entire floor and he shall provide a sufficient number of outlets, located at convenient points, so that extension cords of not over 50 ft. in length will reach all work requiring temporary light or power.
- D. The Electrical Subcontractor shall install and maintain the wiring and accessories for the portable trailer office of the General Contractor.
- E. All temporary electrical work shall meet the requirements of the National Electrical Code Article 305 Temporary Wiring, the Local Utility Company, and all Federal Standards and Laws.
- F. All temporary wiring and accessories thereto installed by the Electrical Subcontractor shall be removed after their purposes have been served.
- G. The General Contractor will pay for the cost of electric energy consumed by himself and by all of his Subcontractors, unless otherwise indicated.
- H. Provide all temporary lighting and power required above during the normal working hours of the project or a total of ten (10) hours per normal working day; Saturdays, Sundays and legal holidays are excluded. The ten hours per day shall include manning the temporary power and lighting 2 hour before and 2 hour after a normal eight (8) hour working day. In addition to the above, provide and maintain, to the satisfaction of the local authorities having jurisdiction, all temporary lighting and power that may be required for safety purposes. The Electrical Subcontractor will be compensated by the General Contractor for any additional standby time, materials or equipment required by the General Contractor or other Subcontractors beyond the normal working hours, as defined above.

#### 1.14 RECORD DRAWINGS

- A. Record drawings shall be provided under this Section in accordance with Section 01780 and as specified herein.
- B. As work progresses and for the duration of the Contract, maintain a complete and separate set of prints of Contract Drawings at the job site at all times. On a daily basis, record work completed and all changes from original Contract Drawings clearly and accurately, including work installed as a modification or addition to the original design such as change orders, instructions issued by the Engineer, or conditions encountered in the field.
- C. Drawings shall show record condition of details, sections, and riser diagrams, and control changes. Schedules shall show actual manufacturer and make and model numbers of



final equipment installation. Remove all superceded data to show the completed work. Accurately indicate the location, size, type, and elevation of new utilities and their relationship to other utilities.

- D. The Record Drawings will be used as a guide for determining the progress of the Work installed. They shall be inspected on a regular basis and shall be corrected immediately if found inaccurate or incomplete. Requisitions for payment will not be approved until the Drawings are accurate and up-to-date.
- E. At completion of Work prepare a complete set of Record Drawings showing all systems as actually installed. The Contract Drawing electronic CAD files will be made available for this Contractor's copying, at his expense, into reproducibles to serve as backgrounds for the Record Drawings. Provide all drawings necessary to show the required as-built information. Submit three sets of prints to the Engineer for comments as to compliance with this Section. Make all modifications so noted by the Engineer.
- F. Certify the accuracy of the record drawings. Record Drawings shall become the property of the Owner.
- G. When required by jurisdiction, submit the record set for approval by the Authority Having Jurisdiction in a form acceptable to the jurisdiction.

#### 1.15 COMPONENT INTERCONNECTIONS

- A. Components of equipment furnished under this Specification will not be furnished as integrated systems.
- B. Analyze all systems components and their shop drawings; identify all terminals and prepare drawings or wiring tables necessary for component interconnection. Furnish two copies of interconnection wiring diagrams and tables to the Owner as part of the record drawings.
- C. Furnish and install all component interconnections.

#### 1.16 MANUFACTURER'S SERVICES

- A. Provide manufacturer's services for testing, training and start-up of the following equipment:
  - 1. Variable Frequency Drives.
  - 2. The time required for each system shall be as hereinafter specified. The time specified shall be used as directed by the Engineer and shall not be used by the manufacturer or Contractor for field adjustments due to manufacturing or shipping defects.

#### 1.17 MATERIALS

- A. Materials and equipment used shall be Underwriters Laboratories, Inc. listed wherever standards have been established by that agency. Written approval by the Engineer and local inspecting authority is required wherever UL Listed approval is not available.

B. Manufacturer of Principal Equipment

1. All lighting and power panelboards shall be made by one manufacturer.
2. All conduit of a given type shall be made by one manufacturer.
3. All wire and cables of a given type shall be made by one manufacturer.
4. All three phase magnetic motor starters furnished shall be made by one manufacturer.

1.18 WARRANTY

- A. Provide warranty and guarantee on all equipment furnished and work performed for a period of one (1) year from the date of substantial completion.

PART 2 (NOT USED)

PART 3 (NOT USED)

- END OF SECTION -

## SECTION 16060

### GROUNDING

### SYSTEMS

#### PART 1 – GENERAL

##### 1.1 DESCRIPTION

- A. The work of this section includes the furnishing and installing of a complete grounding system in strict accordance with Article 250 of the National Electrical Code and as specified herein and as shown on the drawings.

##### 1.2 SUBMITTALS

- A. Submit the following in accordance with Section 01300:
  - 1. Conduit
  - 2. Wire
  - 3. Ground bus bars

##### 1.3 DELIVERY, STORAGE AND HANDLING

- A. Provide in accordance with Section 01600.
- B. All materials shall be shipped, stored, handled and installed in such a manner as not to degrade quality, serviceability, or appearance.

#### PART 2 – PRODUCTS

##### 2.1 CONDUIT

- A. Conduit shall be as specified under Section 16130 (Raceways and Fittings).

##### 2.2 WIRE

- A. Wire shall be as specified under Section 16120 (Wire and Cables).

##### 2.3 GROUNDING BUS BARS

- A. Provide a grounding bus bar next to or below the main distribution board or main disconnect, ground bus bar to be approximately 8" above finished floor.
- B. Grounding bus bars shall be copper, not less than ¼ inch by 2 inch by 24 inch.
- C. All lugs, bolts and nuts shall be silicon bronze.

- D. Buses shall be mounted to the room wall with standoff isolators, standoff brackets, and mounting bolts.

## PART 3 – EXECUTION

### 3.1 INSTALLATION

- A. Grounding conductors shall be run with feeders where shown on the drawings or hereinafter specified.
- B. Liquid tight flexible metal conduit in sizes 1 inch and larger shall have bonding jumpers. Bonding jumpers shall be external, run parallel (not spiraled) and fastened with plastic tie wraps. Tie wraps shall be installed 12 inches apart and not more than 6 inches from ends.
- C. Connect the following equipment by separate wire or cable directly to the main electrical room grounding bus bar:
  - 1. Frame of each transformer
  - 2. Neutral of each transformer
- D. Connect the following equipment by separate wire or cable to the ground bus in the distribution equipment servicing the equipment:
  - 1. Panelboards
  - 2. Motor Control Centers
  - 3. Motors
  - 4. Control panels
  - 5. All feeders and branch circuits
- F. The following equipment shall be grounded through the metallic raceway systems with permanent and effective ground connections:
  - 1. All metal cases and support frames
  - 2. Lighting system
  - 3. 120 Volt motors
- G. All grounding connections shall be made by means of approved bronze clamps. Exposed connections between different metals shall be sealed with No-Oxide Paint Grade A, or equal.
- H. Light fixture bases shall be furnished with a grounding point.

### 3.2 TESTING

- A. The grounding system shall be tested under this section.

- B. The equipment grounding shall be checked to insure continuity of the ground return path.
- C. The ground grid systems shall be tested using the three terminal fall in potential method. A minimum of eight test points for each ground grid system shall be submitted for review by the Engineer. The test points shall be made along a straight line from the grid system to the reference terminal. The distance between the grid system and the reference terminal shall be consistent with normal practices for ground testing.
- D. All test equipment shall be furnished hereunder and shall be similar to Biddle Earth Tester No. 250220 or equal.
- E. These tests shall be performed during the dry season. Tests shall be performed before loaming and seeding or paving work has been performed.
- F. The Contractor shall notify the Engineer immediately if the ground grid system exceeds 5 ohms.

### 3.3 CLOSEOUT ACTIVITIES

- A. Provide in accordance with Section 01700.

- END OF SECTION

-

## SECTION 16080

### UNDERGROUND SYSTEMS

#### 1.0 PART 1 – GENERAL

##### 1.1 SCOPE

- A. The work of this section includes furnishing and installing of a complete underground system of raceways, handholes, and frames and covers as specified herein and as shown on the drawings.

##### 1.2 SUBMITTALS

- A. Submit the following in accordance with Section 01300:
  - 1. Raceways
  - 2. Warning Tape

##### 1.3 DELIVERY, STORAGE AND HANDLING

- A. Provide in accordance with Section 01600.
- B. All materials shall be shipped, stored, handled and installed in such a manner as not to degrade quality, serviceability, or appearance.

#### 2.0 PART 2 – PRODUCTS

##### 2.1 RACEWAYS

- A. Raceways shall be PVC schedule 40 conduit. Raceway materials shall be in accordance with Section 16130 (Raceways and Fittings).

##### 2.2 POLYETHYLENE WARNING TAPE

- A. Warning tape shall be red polyethylene film, 6 inch minimum width, Type XB-720 by W.H. Brady Co., or equal.

#### 3.0 PART 3 – EXECUTION

##### 3.1 INSTALLATION

- A. Raceways shall be installed to drain away from buildings. Raceways between handholes shall drain toward the handholes. Raceway slopes shall not be less than 3 inches per one hundred feet.
- B. Raceway banks shall be encased in concrete. Concrete shall be reinforced with steel rods.

- C. Plastic spacers shall be used to hold raceways in place. Spacers shall provide not less than two inch clearance between raceways.
- D. The minimum cover for raceway banks shall be 30 inches unless otherwise permitted by the Engineer.
- E. Raceway entrances to buildings and structures shall be made with steel conduit not less than ten feet long.
- F. Conduits in duct banks entering buildings and structures shall be spread to allow adequate room for conduit wall seals, pull and terminal boxes.
- G. Where bends in raceways are required, long radius elbows, sweeps and offsets shall be used. Sweeps at riser pole shall be rigid steel encased in concrete.
- H. All raceways shall be swabbed clean before cable installation.
- I. Spare raceways shall be plugged and sealed watertight at all buildings and structures.
- J. Raceways in use shall be sealed watertight at all buildings and structures.
- K. Rigid steel conduit shall be used for risers at the service pole and other locations shown on the drawings. Conduit sweep at pole base shall be rigid steel conduit.
- L. Raceway terminations at manholes shall be with end bells.
- M. Pulling-in irons shall be installed opposite all raceway entrances to manholes.
- N. All underground metallic conduit run underground in direct contact with earth shall be coated with asphaltum or bitumastic varnish or similar corrosion protection the entire length of the run.
- O. All underground raceways/ductbanks shall be marked with warning tape located approximately 12 inches below grade above the raceway/ductbank.

- END OF SECTION -

## SECTION 16085

### MISCELLANEOUS EQUIPMENT

#### PART 1 – GENERAL

##### 1.1 DESCRIPTION

- A. The work of this section includes the furnishing and installing of all miscellaneous equipment as specified herein and as shown on the drawings.

##### 1.2 SUBMITTALS

- A. Submit the following in accordance with Section 01300:
  - 1. Surge Suppression Devices
  - 2. Demand Power Meter
  - 3. Disconnect switches
  - 4. Motor starters
  - 5. Transformers
  - 6. Control stations
  - 7. Enclosure types
  - 8. Wireway
  - 9. Relays
  - 10. Nameplates
  - 11. Floor Mats
  - 12. Warning Signs
- B. Operation and Maintenance Manuals - Prepare manuals in accordance with Section 01730.
- C. Record Drawings - Prepare as specified in Section 16000.

##### 1.3 DELIVERY, STORAGE AND HANDLING

- A. Provide in accordance with Section 01600.
- B. All materials shall be shipped, stored, handled and installed in such a manner as not to degrade quality, serviceability, or appearance.

##### 1.4 DESIGN CRITERIA

- A. All circuit breakers, magnetic motor starters, and fuses furnished under this section shall be of the same manufacturer for each type of equipment.

#### PART 2 – PRODUCTS



2.1 SURGE PROTECTION DEVICE (SPD)

A. Electrical Service SPD

1. Certify unit listed to UL 1449, 3rd Edition and UL 1283.
2. SPD shall be UL labeled as Type 1, intended for use without need for external or supplemental overcurrent devices. Every suppression component of every mode, including N-G, shall be protected by internal overcurrent and thermal over-temperature controls. SPDs relying upon external or supplementary installed safety disconnectors do not meet the intent of this specification.
3. SPD to be enclosed, surfaced mount and to include surge counter, audible alarm and dry contact for remote status.
4. Minimum surge current capability (single pulse rated) per phase shall be 200kA
5. Voltage Protection Ratings (VPRs) shall not exceed the following:

System Voltage	L-N	L-G	L-L	N-G
208Y/120	700V	700V	1000V	600V
480Y/277	1200V	1200V	2000V	1200V

6. Maximum Continuous Operating Voltage (MCOV) (verifiable at UL.com):

System Voltage	Allowable System Voltage Fluctuation (%)	MCOV
208Y/120	25%	150V
480Y/277	15%	320V

7. SPD shall be installed per manufacturer's installation instructions with lead lengths as short (less than 24") and straight as possible. Gently twist conductors together.

2.2 KILOWATT-HOUR DEMAND METER

A. Meter

1. Kilowatt-Hour power meter shall have be housed in a steel enclosure with a digital display, keeps a 72 day data log, display the Kilowatt-Hours, Amps per phase, Volts per phase and peak demand and provide these values to remote monitoring systems.
2. The power meter shall communicate using Modbus TCP via an Ethernet RJ-45 port and be able connect to any host devices.

B. Provide small control wiring, necessary fuse blocks, suitable numbering strips and terminal blocks as required

- C. Provide current transformers for each meter. Current transformers shall be wired to shorting type terminal blocks. All transformers used for metering shall meet the requirements of IEEE C12.11 and IEEE C57.13.

### 2.3 DISCONNECT SWITCHES (VISIBLE BLADE TYPE)

- A. Visible blade type disconnect switches shall be heavy-duty, quick-make, quick-break, visible blades, 600 Volt, 3 pole with full cover interlock.
- B. Enclosure shall meet the area NEMA designation for which they are located.
- C. NEMA Type 12, 4X and 7 enclosures shall be as specified herein.
- D. Disconnect switches shall be as manufactured by Eaton Co., Square D, or General Electric Co.

### 2.4 DISCONNECT SWITCHES (TOGGLE TYPE)

- A. Toggle type disconnect switches shall be quick-make, quick-break with handle guard and lock-off feature.
- B. Switches shall be provided for resistance, non-motor type loads only. Switches shall not be installed where full load current of utilization equipment exceeds 18 Amperes.
- C. Switches shall be rated 20 Amperes at 600 Volts and 30 Amperes at 250 Volts, 60 Hertz, 2 or 3 pole.
- D. Enclosure shall meet the area NEMA designation for which they are located.
- E. NEMA Type 12, 4X and 7 enclosures shall be as specified herein.
- F. Disconnect switches shall be provided by Eaton Co., Square D., or General Electric Company.

### 2.5 MANUAL MOTOR STARTERS

- A. Manual starters shall be non-reversing, reversing or two speed type as shown on the drawings. Built-in control stations shall be provided where shown on the drawings.
- B. Enclosure shall meet the area NEMA designation for which they are located.
- C. NEMA Type 12, 4X and 7 enclosures shall be as specified herein.
- D. Provide handle guard kit with padlock provisions.
- E. Manual motor starters shall be as manufactured by the Eaton Co., Square D, or General Electric Co.

## 2.6 COMBINATION MAGNETIC MOTOR STARTERS FOR WALL MOUNTING

- A. Combination magnetic motor starters shall be a combination motor circuit protector and contactor. Contactors shall be three pole, three phase, 60 Hertz, 600 Volt, magnetically operated, full voltage non-reversing except as shown on the drawings. NEMA sizes shall be as required for the horsepower shown on the drawings. Disconnect switches shall be quick-make, quick-break with operating mechanism mounted on a fixed portion of the enclosure. Door mounted mechanisms will not be acceptable.
- B. Each motor starter shall have a 120 Volt operating coil and control power transformer. Three phase starters shall have three overload relays. Auxiliary contacts shall be provided as required.
- C. Overload relays shall be adjustable and manually reset.
- D. Control power transformers shall be sized for additional load where shown on the drawings. Transformer secondaries shall be equipped with time-delay fuses.
- E. Built-in control stations and indicating lights shall be furnished where shown on the drawings.
- F. Enclosure shall meet the area NEMA designation for which they are located.
- G. NEMA Type 12, 4X and 7 enclosures shall be as specified herein.
- H. Provide handle guard kit with padlock provisions.
- I. Combination magnetic motor starters shall be as manufactured by Eaton Co., Siemens Corp., or General Electric Co..

## 2.7 SOFT START MOTOR STARTERS

- A. Soft starters shall be three phase, 60 Hertz, 480 Volt, microprocessor based SCR controlled soft starter type with integral contactor bypass, overload protection, disconnect, and rated for motor horsepower size indicated on the drawings. Disconnect switches shall be quick-make, quick-break with operating mechanism mounted on a fixed portion of the enclosure. Door mounted mechanisms will not be acceptable.
- B. Each motor starter shall have a door mounted digital LCD interface module, control power transformer, run time meter, and status lights. Control relays, run and alarm status dry contacts shall be provided as indicated in the motor control wiring diagrams.
- C. The Soft Start Motor starters shall be capable of pump reduced voltage/current starting and then turning over to pump full rated voltage/current in line operation. Start up ramp timing, current limitations and pre-configured start curves can be adjustable and accessed via the digital interface module.

- D. Overload protection shall be adjustable and manually reset.
- E. Control power transformers shall be sized for additional load where shown on the drawings. Transformer secondaries shall be equipped with time-delay fuses.
- F. Built-in control stations and indicating lights shall be furnished where shown on the drawings.
- G. Enclosure shall meet the area NEMA designation for which they are located.
- H. NEMA Type 12, and 4X enclosures shall be as specified herein.
- I. Provide handle guard kit with padlock provisions.
- J. Soft start motor starters shall be as manufactured by Eaton, General Electric, or Schneider Electric.

## 2.8 DRY TYPE TRANSFORMERS

- A. Dry type transformers shall be dry type, copper, two-winding with KVA and voltage ratings as shown on the drawings.
- B. Transformers shall be furnished with full capacity primary voltage taps as follows:
  - 1. 0.25 KVA to 2 KVA - None
  - 2. 3 KVA to 10 KVA - Two - 5 percent below normal.
  - 3. 11 KVA to 500 KVA - Two - 2-1/2 percent below normal and two 2-1/2 percent above normal.
- C. Transformers shall be designed for indoor or outdoor service as required for the locations shown on the drawings.
- D. Transformers shall be designed in accordance with ANSI, IEEE and NEMA standards.
- E. Normal efficiency transformers shall be furnished in sized to 15 KVA. Maximum temperature rise of transformers as measured by resistance above a 40 degree C ambient shall not exceed:
  - 1. 115 degree C for transformers rated up to 25 KVA.
  - 2. 80 degree C for transformers rated up to 500 KVA.
- F. Energy efficient transformers shall be furnished in ratings 30 KVA and larger and certified to meet DOE 10 CFR Part 431:2016. Temperature rise of transformers above a 40 degree C ambient shall not exceed 80 degree C.
- G. All insulating materials shall be in accordance with NEMA standards for a 220 degree C

UL component recognized insulation system.

- H. Transformers shall be manufactured by Square D Co., General Electric Co., Hammond Corp., or equal.

## 2.9 CONTROL STATIONS

- A. Control stations shall be heavy-duty type, 30 mm, with full size operators.
- B. All control stations located at motors and where shown on the drawings shall have a padlock attachment for locking out the stop button or position.
- C. Enclosure shall meet the area NEMA designation for which they are located.
- D. NEMA Type 12, 4X and 7 enclosures shall be as specified herein.
- E. Control stations shall be CR104 Series by General Electric Co., or equal by Eaton Co. or Siemens Corp.

## 2.10 ENCLOSURE TYPE

- A. NEMA Type 12 enclosure shall be general purpose sheet steel.
- B. NEMA Type 4X enclosures shall be cast iron or stainless steel.
- C. NEMA Type 7 shall be cast iron.

## 2.11 WIREWAY

- A. Wireway shall be steel.
- B. Wireway shall be manufactured by General Electric Co., or equal by Siemens Corp or Hoffman Enclosures.

## 2.12 RELAYS

- A. Control relays shall be heavy duty machine tool type, with 10 Ampere, 300 Volt convertible contacts. Time delay relays shall be pneumatic, adjustable 0.2 to 180 seconds. Relays shall be Catalog No. 1CR122A as manufactured by the General Electric Co., equal by Eaton Company, or Allen Bradley Co.

## 2.13 NAMEPLATES

- A. Nameplates shall be provided for all special purpose tumbler switches, disconnect switches, remote control stations, motor starters, time clocks, panelboards, terminal cabinet, etc. to designate the equipment controlled and function.

B. Nameplates shall be black and white laminated, phenolic material having engraved letters approximately 1/4 inch high, extending through the black face into the white layer.

C. Nameplates shall be attached to the panel by self-tapping stainless steel screws or rivets.

#### 2.14 FLOOR MATS

A. Provide 1/4" x 36" corrugated all rubber insulating matting in front of new 480V power distribution equipment.

B. Matting shall be proof tested to 20,000 volts and conform to ASTM D178-93.

C. Matting to be manufactured by Biltrite or equal.

#### 2.15 WARNING SIGNS

A. Metal-enclosed switchgear, transformers, pull boxes, electric rooms, closets and similar locations and pieces of equipment shall be furnished with a warning sign. Sign shall read "DANGER HIGH VOLTAGE KEEP OUT!". Signs shall be as manufactured by Thomas & Betts, Seton, or equal.

### PART 3 – EXECUTION

#### 3.1 INSTALLATION

A. All field mounted devices shall be mounted four feet-six inches above the finished floor or grade. Devices shall be adequately supported on walls, columns or other supports. The Contractor shall furnish and install channel iron imbedded in the ground or floor to support devices where necessary.

B. All control equipment shall be identified as to the equipment it controls. Provide lamacoid nameplates at all equipment.

- END OF SECTION -

## SECTION 16120

### WIRES AND CABLES

#### PART 1 – GENERAL

##### 1.1 DESCRIPTION

- A. The work of this section includes the furnishing, installing and testing of all wire, cable and appurtenances as specified herein and as shown on the drawings. All wiring of a given type shall be the product of one manufacturer.

##### 1.2 SUBMITTALS

- A. Submit the following in accordance with Section 01300:
  - 1. Wire
  - 2. Cable
  - 3. Terminations
  - 4. Lugs
  - 5. Wire and Cable Markers

##### 1.3 DELIVERY, STORAGE AND HANDLING

- A. Provide in accordance with Section 01600.
- B. All materials shall be shipped, stored, handled and installed in such a manner as not to degrade quality, serviceability, or appearance.

##### 1.4 DESIGN CRITERIA

- A. Wire for single phase circuits shall be Type XHHW or THWN-THHN.
- B. Wire for three phase circuits shall be Type XHHW.
- C. Single conductor wire for control, indication and metering shall be Type THWN/THHN No. 12 or 14 AWG, stranded.
- D. Multi-conductor control cable shall be used for the underground system and shall be No. 12 or 14 AWG, stranded with an overall jacket.
- E. Wire for process instrumentation shall be twisted shielded pairs No. 16 AWG, stranded.
- F. Ground wires shall be Type THW, green. Bare ground wires shall be soft drawn copper, 98 percent conductivity.

##### 1.5 MINIMUM SIZES

- A. Except for control and signal wiring, no wire smaller than number 12 AWG shall be used.

## PART 2 – PRODUCTS

### 2.1 MATERIALS

- A. Wires and cables shall be of annealed, 98 percent conductivity, soft drawn copper.
- B. All conductors No. 8 AWG and larger sizes shall be stranded.

### 2.2 600 VOLT WIRE

- A. Type XHHW shall be cross-linked polyethylene, as manufactured by Prysmian Cable Corp., Collyer Insulated Wire Co., The Okonite Co. or equal.
- B. Type THWN/THHN shall be as manufactured by Prysmian Cable Corp., Collyer Insulated Wire Co., The Okonite Co. or equal.
- C. Multi-conductor control cable shall be stranded, 600 Volt, cross-linked polyethylene insulated, neoprene jacketed, as manufactured by Allied Wire and Cable, or equal.

### 2.3. INSULATED 15KV RATED WIRE.

- A. 15KV wire shall be single aluminum conductor, MV-105 type, ethylene-propylene rubber 133% insulated, polyvinyl chloride jacketed, 133% insulated, shielded by Okonite Company, Pirelli Cables & Systems, Southwire Company or equal.
- B. Shielding: Copper tape, helically applied over semiconducting insulation shield.
- C. Preformed stress cones shall be used for terminating 15 KV cable.
- D. Exterior of the cables shall bear repetitive markings along their entire length indicating conductor size, insulation type and voltage rating.

### 2.4 INSTRUMENTATION CABLE

- A. Process instrumentation wire shall be twisted pair, 600 Volts, polyethylene insulated, aluminum tape, tinned copper braid shielded, polyvinyl chloride jacketed, as manufactured by Okonite Co., Belden Corp., or equal.

### 2.5 FIBER OPTIC CABLE

- A. 50uM Multi Mode OM3 Type, ANSI/ICEA S-104-696 listed, Loose Tube, Gel-Free Plenum Cable, 6-Strand (OM3).
- B. Provide all end connectors and test complete cable end to end, all terminations and testing shall be by a certified fiber optic technician.



## 2.6 CONNECTORS AND TERMINAL LUGS

- A. Splices for No. 10 or No. 12 A.W.G. solid wires, such as for lighting branch circuits, shall be made with insulated wire connectors.
- B. Connectors and terminal lugs on wires No. 8 A.W.G. and larger shall be of the mechanical or clamp type.

## 2.7 WIRE AND CABLE MARKERS

- A. Wire and cable markers shall be "Omni-Grip" as manufactured by W.H. Brady Co., or equal.
- B. Wire and cables with diameters exceeding the capacity of the "Omni-Grip" shall be marked with pre-printed, self-adhesive vinyl tapes as manufactured by W.H. Brady Co., T&B Fasteners Inc., or equal.
- C. The "to" and "from" destinations shall be clearly identified on each cable at each termination and within manholes, pull boxes and junction boxes.

## PART 3 – EXECUTION

### 3.1 INSTALLATION

- A. All conductors shall be carefully handled to avoid kinks or damage to insulation.
- B. All wires, cables and each conductor of multi-conductor cables (except lighting and receptacle wiring) shall be uniquely identified at each end with wire and cable markers.
  - 1. Where wiring originates from a motor control center or process control panel the wire identification number shall incorporate the terminal numbers used in the control center or panel and a number to identify the motor control center or panel.
  - 2. Wires shall be identified at both ends and at intermediate junction boxes, terminal cabinets, etc. Wire identification numbers shall be unique.
  - 3. A typed list of the numbers used at each motor control center and control cabinet shall be submitted with the as built drawings.
- C. Lubrications shall be used to facilitate wire pulling. Lubricants shall be U.L. approved for use with the insulation specified.
- D. Shielded instrumentation wire shall be installed from terminal to terminal with no splicing at any intermediate point.
- E. Shielded instrumentation wire shall be installed in rigid steel conduit and pull boxes that contain only shielded instrumentation wire.
- F. Shielding on instrumentation wire shall be grounded at the transmitter end only.

- G. Each branch circuit shall have a dedicated neutral.
- H. Cables penetrating fire rated floors, walls, etc. shall be fireproofed. Fireproofing material shall be U.L. classified for three hour fire rating. Fire-proofing system shall be as manufactured by 3M Co., Thomas & Betts, or equal.
- I. Power conductors (other than lighting & receptacle) shall be run continuous and splicing should be kept to a minimum. The Engineer should be informed of where splices will occur.

### 3.2 TESTS

- A. All 600 Volt wire insulation shall be tested with a megohm meter after installation. Tests shall be made at not less than 500 Volts. Submit a written test report of the results to the Engineer.

- END OF SECTION -

## SECTION 16130

### RACEWAYS AND FITTINGS

#### PART 1 – GENERAL

##### 1.1 DESCRIPTION

- A. The work of this section includes the furnishing and installing of complete raceway systems as specified herein and as shown on the drawings.
- B. All raceway systems shall be complete with fittings, boxes or cabinets, and necessary connections to result in a complete system.
- C. Aluminum materials shall not be used.

##### 1.2 SUBMITTALS

- A. Submit the following in accordance with Section 01300:
  - 1. Raceways.
  - 2. Boxes and Fittings.

##### 1.3 DELIVERY, STORAGE AND HANDLING

- A. Provide in accordance with Section 01600.
- B. All materials shall be shipped, stored, handled and installed in such a manner as not to degrade quality, serviceability, or appearance.

##### 1.4 DESIGN CRITERIA

- A. Except where otherwise shown on the drawings, or hereinafter specified, all raceways installed exposed shall be rigid heavy wall galvanized steel conduit.
- B. Except where otherwise shown on the drawings, or hereinafter specified, all raceways installed within the Administration building shall be electrical metallic tubing.
- C. PVC coated galvanized rigid steel conduit shall be used within all wet wells.
- D. PVC Schedule 40 conduit shall be used underground except as specified herein and where otherwise indicated on the drawings.

- E. When routing signal cables in raceways, maintain 12” spacing from power raceways and only cross at a 90 degree angle. All VFD power feeds to motors shall be routed in rigid steel material, NO EXCEPTION.
- F. Unless otherwise hereinafter specified or shown on the drawings, all boxes shall be metal.
- G. Exposed switch, outlet and control station boxes and fittings shall be cast or malleable iron.
- H. Concealed switch, outlet and control station boxes in dry-wall finished areas shall be pressed steel.
- I. Terminal boxes, cabinets, junction boxes, pull boxes and wireways used in areas designated as NEMA 4X shall be stainless steel 316, gasketed.
- J. Combination expansion-deflection fittings shall be used where conduits cross structure expansion joints. Refer to Structural drawings for expansion joint locations.
- K. Conduit wall seals shall be used where underground conduits penetrate walls or at other locations shown on the drawings.
- L. Fire stops shall be used where cables or conduits penetrate through fire resistant rated walls, floors, ceilings or partitions. All fire stopping shall be inspected by an owner hired special inspector.
- M. PVC coated rigid steel conduit sweeps shall be used where concealed PVC conduits rise up out of floor slabs.

## PART 2 – PRODUCTS

### 2.1 MATERIALS

- A. Rigid Conduit
  - 1. Rigid heavy wall steel conduit shall be hot-dipped galvanized as manufactured by the Youngstown Sheet and Tube Co., Allied Tube and Conduit Corp., Wheeling-Pittsburgh Steel Corp., or equal.
  - 2. PVC conduit, up to 4 inch in diameter, where installed concealed in floor slabs, walls or underground shall be rigid polyvinyl chloride Schedule 40 as manufactured by Carlon, Phillips Petroleum Co., Triangle Pipe & Tube Co., Inc., or equal.
  - 3. PVC conduit, 5 inch in diameter and larger, used underground and at other locations shown on the Drawings shall be rigid polyvinyl chloride schedule 40 as manufactured by Carlon, Phillips Petroleum Co., Triangle Pipe & Tube Co., Inc., or equal.

4. PVC coated rigid steel conduit shall have a 0.040 inch thick, polyvinyl chloride coating permanently bonded to hot-dipped galvanized steel conduit, as manufactured by Calbond, Ocal, Robroy Industries, or equal.
- B. Electrical metallic tubing shall be hot-dipped galvanized steel as manufactured by Youngstown Sheet and Tube Co., Allied Tube and Conduit Corp., Wheatland Tube Co., or equal.
- C. Liquidtight, Flexible Metal Conduit, Couplings and Fittings.
1. Liquidtight, flexible metal conduit shall be Sealtite, Type UA, as manufactured by Anaconda American Brass Co., or equal by American Flexible Conduit Co., Inc., or equal.
  2. Fittings used with flexible conduit shall be of the screw-in type as manufactured by Thomas and Betts Co., Crouse-Hinds Co., O.Z. Manufacturing Co., or equal.
- D. Flexible couplings shall be as manufactured by Crouse-Hinds Co., Appleton Electric Co., O.Z. Manufacturing Co., or equal.
- E. Boxes and Fittings
1. Pressed steel switch and outlet boxes shall be hot-dipped galvanized as manufactured by Raco Manufacturing Co., Adalet Co., O.Z. Manufacturing Co., or equal.
  2. All boxes including, but not limited to, terminal boxes, junction boxes and pull boxes shall be sheet steel unless otherwise shown on the drawings. Boxes shall be galvanized and have continuously welded seams. Welds shall be ground smooth and galvanized. Box bodies shall be flanged and shall not have holes or knockouts. Box bodies shall not be less than 14 gauge metal and covers shall not be less than 12 gauge metal. Covers shall be gasketed and fastened with stainless steel screws. Boxes shall be as manufactured by Hoffman Engineering Co. or equal.
  3. All boxes and fittings used with PVC coated conduit shall be furnished with a PVC coating bonded to the metal. The tensile strength of the bond shall be not less than 2,000 pounds.
  4. All boxes and fittings used with PVC coated conduit shall be furnished with a PVC coating bonded to the metal, the same thickness as used on the coated steel conduit.
  5. Cast or malleable iron boxes and fittings shall be galvanized with cast galvanized covers and corrosion-proof screws as manufactured by the Crouse-Hinds Co., Appleton Electric Co., O.Z. Manufacturing Co., or equal.

6. PVC fittings shall be as manufactured by Carlon, An Indian Head Co., O.Z. Manufacturing Co., or equal.
  7. EMT fittings shall be watertight compression type. Set-screw type fittings are not acceptable
  8. Steel elbows and couplings shall be hot-dipped galvanized. Elbows and couplings used with PVC coated conduit shall be furnished with a PVC coating bonded to the steel, the same thickness as used on the coated steel conduit.
  9. Conduit hubs shall be as manufactured by Myers Electric Products, Inc., Raco Div., O.Z. Manufacturing Co., or equal.
  10. Conduit wall seals shall be Type WSK as manufactured by O.Z. Manufacturing, Co., or equal by Link Seal Co.
  11. Combination expansion-deflection fittings shall be Type XD as manufactured by Crouse-Hinds Co., or equal by Appleton Electric Co., O.Z. Manufacturing Co.
  12. Conduit seal bushings shall be Type CSB as manufactured by O.Z. Manufacturing Co., or equal by Crouse-Hinds Co.
  13. Fire stops shall be Type CFSF as manufactured by O.Z. Manufacturing Co., or equal by Crouse-Hinds Co., Appleton Electric Co.
  14. Explosion proof conduit seals shall be Type EYS as manufactured by O.Z. Manufacturing Co., or equal by Crouse-Hinds Co. and Appleton Electric Co.
- F. Conduit Mounting Equipment. Hangers, rods, backplates, beam clamps, fasteners, etc. shall be hot-dipped galvanized iron or steel for all areas except for the wet well. Mounting equipment shall be as manufactured by B-Line Co., Thomas and Betts Co., Unistrut Corp., or equal.
- G. Conduit Mounting Equipment. Hangers, rods, backplates, beam clamps, fasteners, etc. shall be stainless steel for within the wet well. Mounting equipment shall be as manufactured by B-Line Co., Thomas and Betts Co., Unistrut Corp., or equal.
- H. Corrosion Protection for Galvanized Conduit located exterior to buildings shall be provided. Corrosion protection for galvanized conduit shall be cold galvanized zinc based paint as manufactured by L.P.S. Co., Los Angeles, California, CRS Chemicals, Drecher, Pennsylvania, or equal.
- I. Watertight Silicone Type Sealant. Sealant shall be non slumping type silicone meeting UL water leakage test, W Rating and have excellent adhesion characteristics to most construction surfaces, including: concrete, gypsum, metal, plastic, wood and insulation

## PART 3 – EXECUTION

### 3.1 INSTALLATION

- A. No conduit smaller than 3/4 inch electrical trade size shall be used, nor shall any have more than three 90 degree bends in any one run. Approved factory elbows shall be used when sharper bends are necessary. Pull boxes shall be provided as required or directed.
- B. No wire shall be pulled until the conduit system is complete in all details; in the case of concealed work, until all rough plastering or masonry has been completed; in the case of exposed work, until the conduit system has been completed in every detail.
- C. The ends of all conduits shall be tightly plugged to exclude dust and moisture while the buildings are under construction.
- D. Conduit supports shall be spaced at intervals of eight feet or less, as required to obtain rigid construction.
- E. Single conduits shall be supported by means of one-hole pipe clamps in combination with one-screw back plates, to raise conduits from the surface. Plastic "CLIC" system supports are not acceptable. Multiple runs of conduits shall be supported on trapeze type hangers with steel horizontal members and threaded hanger rods. The rods shall be not less than 3/8 inch diameter. Wire hangers will not be accepted.
- F. Conduit hangers shall be attached to structural steel by means of beam or channel clamps. Where attached to concrete surfaces, concrete inserts of the spot type shall be provided.
- G. All conduits on exposed work and concealed above hung ceilings shall be run at right angles to or parallel with surrounding wall and shall conform to the form of the ceiling. Diagonal runs will not be allowed. Bends in parallel conduit runs shall be concentric. All conduit shall be run perfectly straight and true.
- H. Conduit terminating in pressed steel boxes shall have double locknuts and insulated bushings.
- I. PVC conduits shall be installed using a fusing cement process. Conduits shall be water tight.
- J. Conduit terminating in gasketed enclosures shall be terminated with conduit hubs.
- K. Metallic heavy wall conduits shall be installed using threaded fittings. Threadless fittings may be used in isolated instances when approved by the Engineer.
- L. Liquidtight flexible metal conduit shall be used for all motor terminations and other equipment where vibration is present.
- M. PVC coated rigid steel conduits shall extend a minimum of 12 inches above finished

slabs. Conduits penetrating walls shall be caulked gas tight on both sides.

- N. When a conduit has to be cut in the field, it shall be cut square using a hand or power hacksaw cutter, or an approved pipe cutter using knives. The use of pipe cutter wheels will not be permitted. The cut ends of the field cut conduit shall be reamed to remove burrs and sharp edges. Where threads have to be cut on conduit, the threads shall have the same effective length and shall have the same thread dimensions and taper as specified for factory cut threads on conduits. Field cut threads shall be protected by a field applied cold galvanizing compound.
- O. Conduits entering buildings below grade shall be furnished with a conduit seal bushing.
- P. Concealed conduits in floor slabs and walls and encased in concrete envelope shall be run in direct line with bends of largest possible radius.
- Q. Ducts installed in concrete slabs shall be installed as specified in Section 03300 (Cast-In-Place Concrete). Ducts shall be arranged to minimize crossings.
- R. Ducts shall not be installed in slabs where the slab is below the highest known groundwater level.
- S. Where ducts terminate at panelboards, terminal cabinets, etc. panel of sufficient width and depth shall be provided to maintain the 2 inch spacing between ducts or wireways shall be provided below panels, cabinets, etc.
- T. A ground wire shall be run in all runs of electric metallic tubing and PVC conduit.
- U. All bends in PVC conduit shall be made using a hotbox and bending guide tool.
- V. Conduits run underground below the highest known ground water level shall not enter buildings below this groundwater level without first being run through a drain manhole, handhole, or exterior pull box.

- END OF SECTION -



## SECTION 16442

### PANELBOARDS

#### PART 1 – GENERAL

##### 1.1 DESCRIPTION

- A. The work of this section includes the furnishing and installing of all panelboards as specified herein and as shown on the drawings. All panelboards shall be provided with the applicable NEMA enclosure in accordance with the Electrical Contract Drawings.

##### 1.2 SUBMITTALS

- A. Submit the following in accordance with Section 01300:
  - 1. Panelboards, including construction details and enclosures
  - 2. Terminals and lugs
  - 3. Trim
  - 4. Buses
  - 5. Circuit Breakers
  - 6. Groundfault Circuit Interrupter
  - 7. Metering

##### 1.3 DELIVERY, STORAGE AND HANDLING

- A. Provide in accordance with Section 01600.
- B. All materials shall be shipped, stored, handled and installed in such a manner as not to degrade quality, serviceability, or appearance.

##### 1.4 DESIGN CRITERIA

- A. Panelboard ratings shall be as shown on the drawings. All panelboards shall be rated for the intended voltage.
- B. Panelboards shall be in accordance with the Underwriter Laboratories, Inc. “Standard for Panelboards” and “Standard for Cabinets and Boxes” and shall be so labeled where procedures exist. Panelboards shall also comply with NEMA Standard for Panelboards and the National Electrical Code.

#### PART 2 – PRODUCTS

##### 2.1 PANELBOARD CONSTRUCTION

- A. Interiors
  - 1. All interiors shall be completely factory assembled with circuit breakers, wire

connectors, and buses. All wire connectors, except screw terminals, shall be of the anti-turn solderless type and all shall be suitable for copper wire of the sizes indicated.

2. Interiors shall be designed such that circuit breakers can be replaced without disturbing adjacent units and without removing the main bus connectors and shall be such that circuits may be changed without machining, drilling or tapping.
3. Branch circuits shall be arranged using double row construction except when narrow column panels are indicated. Branch circuits shall be numbered by the manufacturer.
4. A factory provided label shall be provided listing panel type, number of circuit breakers and ratings.
5. The main breaker shall be at the top or bottom of the bus construction and not a branch breaker.

**B. Buses**

1. Main bus shall be copper. Full size neutral bars shall be included. Phase bussing shall be full height without reduction. Cross connectors shall be copper. All buses shall be tinned.
2. Main bus shall be distribution phase sequence type configuration to allow installation of two or three pole circuit breakers at any location.
3. Neutral bussing shall have a suitable lug for each outgoing feeder requiring a neutral connection.
4. Spaces for future circuit breakers shall be bussed for the maximum device that can be fitted into them.
5. Solderless main lugs or main circuit breakers shall be furnished as shown on the drawings.
6. Bus bracing to be at least equal to the interrupting rating of lowest rated circuit breaker installed in panel. Series rated breakers and panels shall not be acceptable.

**C. Boxes**

1. Boxes shall be made from galvanized code gauge steel having multiple knockouts unless otherwise noted. Surface mounted boxes shall be painted to match the trim. Boxes shall be of sufficient size to provide a minimum gutter space of four inches on all sides.
2. Surface mounted boxes shall have an internal and external finish as specified herein. Surface mounted boxes shall be field punched for conduit entrances.
3. At least four interior mounting studs shall be provided.

4. Panelboards shall be "door-in-door" construction.

D. Trim

1. Hinged door-in-door construction shall enclose all circuit breaker handles and shall be included in all panel trims.
2. Doors shall have semi flush type cylinder lock and catch, except that doors over 48 inch in height shall have a vault handle and three point catch, complete with lock, arranged to fasten door at top, bottom and center. Door hinges shall be concealed. Two keys shall be supplied for each lock. All locks shall be keyed alike. A directory frame and card having a transparent cover shall be furnished on each door.
3. Trims shall be fabricated from code gauge sheet steel.
4. All exterior and interior steel surfaces of NEMA 1, 1A, 3R and 12 panelboards shall be properly cleaned and finished with ANSI Z55.1, No. 61 light gray paint over a rust-inhibiting phosphatized coating. The finish paint shall be of a type to which field applied paint will adhere.
5. Trims for flush panels shall overlap the box by at least 3/4 inch all around. Surface trims shall have the same width and height as the box. Trims shall be fastened with quarter turn clamps.

E. Manufacturer

1. 120/208 Volt and 277/480 Volt three phase distribution panelboards rated for 1200 Amps and less shall be Pow-R-Line 4X type as manufactured by Eaton, or equal by Square D and General Electrical. Equipment layouts are based on the dimensions on the Eaton Power R-Line 4X distribution panelboards.
2. 120/240 Volt, single phase, 3 wire, and 120/208 Volt three phase, 4 wire branch circuit panelboards rated for 225 Amps and less shall be Pow-R-Line 1X type as manufactured by Eaton, or equal by Square D and General Electrical.

## 2.2 CIRCUIT BREAKERS

- A. Panelboards shall be equipped with circuit breakers with frame size and trip settings as shown on the drawings. Circuit breaker mounting shall not exceed 78 inches above floor.
- B. Circuit breakers shall be molded case, bolt-in type.
- C. Circuit breakers installed in 120/240 Volt and 120/208 Volt panelboards shall have an interrupting capacity of not less than 10,000 Amperes, RMS symmetrical.
- D. Circuit breakers installed in 277/480 Volt panelboards shall have an interrupting capacity as shown on the Electrical Contract Drawings.
- E. Main circuit breaker shall be attached to the main vertical bus.

- F. Main and feeder breakers with frame rating of 250 Amps and greater shall have a solid state digital trip unit with adjustable long, short, instantaneous, and ground fault trip settings. Provide auxiliary contacts for trip status to remote alarm.

### 2.3 GROUND FAULT CIRCUIT INTERRUPTER (GFCI)

- A. GFCI shall be provided for circuits where indicated on the drawings. GFCI units shall be molded case, bolt-on breakers, incorporating a solid state ground fault interrupter circuit insulated and isolated from the breaker mechanism. The unit shall be U.L. listed Class A Group I device (5 milliamp sensitivity, 25 millisecond trip time), and an interrupting capacity matching the circuit breakers in the panelboards.

### 2.4 DIGITAL POWER METER

- A. Main Distribution panelboard shall be metered with a digital power meter.
- B. Digital Power Meter
  1. Digital power meter shall be true RMS type power monitor with features to data log (30 days) and communicate remotely the AC amperes on each phase, voltage, harmonic distortion, watts, volt amperes, bars, power factor, frequency, demand watts, demand volt ampere and watt hours; and capable of providing alarm status for phase loss, phase on balance, phase reversal and provides all data to remote monitoring systems.
  2. The power meter shall communicate using Modbus RTU via a RS-485 port and Ethernet protocol via a RJ-45 port and be able connect to any host devices.
- C. Provide small control wiring, necessary fuse blocks, suitable numbering strips and terminal blocks as required
- D. Provide current transformers for each meter. Current transformers shall be wired to shorting type terminal blocks. All transformers used for metering shall meet the requirements of IEEE C12.11 and IEEE C57.13.

## PART 3 – EXECUTION

### 3.1 INSTALLATION

- A. Boxes for surface mounted panelboards shall be mounted so there is at least ½ inch air space between the box and the wall.
- B. Circuit directories shall be typed identifying location and nature of load served.
- C. Panelboards installed in areas with finished walls shall be installed recessed into the wall with the front of the panel flush with the finished wall.

- END OF SECTION -

## SECTION 16443

### MOTOR CONTROL CENTERS

#### PART 1 – GENERAL

##### 1.1 DESCRIPTION

- A. The work of this section includes furnishing all labor, materials, tools and equipment necessary to furnish and install Motor Control Centers as shown on drawings, specified herein, or evidently required to complete the work.
- B. Refer to various DIVISION 11 - EQUIPMENT sections and contract drawing motor wiring diagrams for field device interface.

##### 1.2 SUBMITTALS

- A. Manufacturer's literature and brochures shall be submitted for all items to be furnished in accordance with Section 01300.
  - 1. Complete wiring diagrams, and elementary or control schematics of each compartment, including coordination with other electrical control devices operating in conjunction with the motor control center and suitable outline drawings shall be submitted for approval before proceeding with manufacture. Due to the complexity of the control functions, it is imperative the above drawings be clear, full-size and carefully prepared to facilitate interconnections with other equipment. Standard preprinted sheets or drawings simply marked to indicate applicability to this Contract will not be acceptable.
  - 2. Bill-of-material listing conductor material and insulation type as well as other hardware and equipment to be furnished.
  - 3. Catalog cut sheets and other necessary information on each device (relay, timer, circuit, breaker etc.) furnished and installed in or on the motor control center, to describe operating characteristics completely.
  - 4. Where it is not explicitly shown and completely obvious from the outline drawings the following items shall be verified in a written statement accompanying the submittal.
    - a. Type of terminal blocks used that the removal of plug-in compartments can be performed without disconnecting or removing wires
    - b. Plating of bus
    - c. Insulation and isolation of vertical bus
    - d. Underwriter's Laboratories (UL) approval.

5. Clear and concise information for storage, installation, operation, and care of the equipment. Non-applicable portions of standard publications shall be so marked.
6. Time current curves of each size and type of each overcurrent protective device.
7. Submit with the delivery of the MCC and Installation and Maintenance Manual and one (1) copy of the manufacturer's drawings per shipping block.

#### 1.4 REFERENCES

A. The motor control centers and protection devices in this specification shall be designed and manufactured according to latest revision of the following standards (unless otherwise noted).

1. ANSI/IEEE/NFPA 70 - National Electrical Code.
2. Federal Specification W-C-375, Rev. B, Amend. 1, Circuit Breakers, Molded Case; Branch Circuit and Service.
3. NEMA AB 1, Molded Case Circuit Breakers and Molded Case Switches.
4. NEMA AB 3, Molded Case Circuit Breakers and Their Application.
5. NEMA AB 4, Guidelines for Inspection and Preventive Maintenance of Molded Case Circuit Breakers Used in Commercial and Industrial Applications.
6. ANSI C84.1, Voltages Tolerances for North America.
7. NEMA Publication 250, Enclosures for Electrical Equipment.
8. UL 508, UL Standard for Safety Industrial Control Equipment.
9. UL 845, UL Standard for Motor Control Centers.
10. UL 50, UL Standard for Safety Enclosures for Electrical Equipment.
11. ANSI/NEMA ICS 6, Enclosures for Industrial Controls and Systems.
12. NEMA 250, Enclosures for Electrical Equipment.
13. NEMA ICS 2, General Standards for Industrial Control Systems.
14. NEMA ICS 3, Standards for Industrial Control Devices, Controllers and Assemblies.
15. NEMA ST 20, Dry Type Transformers for General Applications.
16. UL 508, Industrial Control Equipment.

#### 1.5 DELIVERY, STORAGE AND HANDLING

- A. Provide in accordance with Section 01600.
- B. Separate Motor Control Center into shipping splits of up to 3 vertical sections. Each shipping split shall include a removable lifting angle, or lifting tabs, for positioning equipment at job site.
- C. Store, protection, and handle motor control centers in accordance with recommended practices listed in manufacturer's Installation and Maintenance Manuals.
- D. Delivery each motor control center split on individual shipping skids wrapped for protection.
- E. Inspect and report concealed damage to carrier within specified time.
- F. Store MCCs in a clean, dry space. Maintain factory protection or cover with heavy canvas or plastic to keep out dirt, water, construction debris, and traffic. Provide heat to prevent condensation.

#### 1.6 DESIGN CRITERIA

- A. All motor control centers shall be furnished by a single motor control center manufacturer. Equipment modified by intermediate equipment assemblers will not be acceptable.
- B. All units and sections shall be U.L. labeled. Motor control centers designed for service entrance application shall be U.L. labeled "Suitable for Use as Service Equipment."
- C. Make all necessary field measurements to verify that equipment shall fit in allocate space in full compliance with minimum required clearances specified in National Electrical Code.
- D. Motor control centers as shown on the drawings are sized based upon the specified manufacturers. If the motor control centers actually furnished deviate from the sizes shown on the drawings, these deviations shall be clearly delineated as exceptions to the specifications, and will be subject to approval by the Engineer.
- E. MCC shall be inspected before shipment including structure, electrical conductors, bussing, general wiring, and devices.

### PART 2 – PRODUCTS

#### 2.1 MANUFACTURERS

- A. General Electric Company.
- B. Square D Corp.
- C. Cutler-Hammer Corp.



## 2.2 MATERIALS

- A. Each MCC shall consist of one or more vertical sections of heavy gauge steel bolted together to form a rigid, free-standing assembly.
- B. Steel material shall comply with UL 845 and CSA requirements.
- C. A removable 7 gauge structural steel lifting angle shall be mounted full width of the MCC lineup at the top. Removable 7 gauge bottom channel sills shall be mounted underneath front and rear of the vertical sections extending the full width of the lineup.
- D. Vertical sections made of welded side-frame assembly formed from a minimum of 12 gauge steel. Internal reinforcement structural parts shall be of 12 and 14 gauge steel to provide a strong, rigid assembly.
- E. The entire assembly shall be constructed and packaged to withstand normal stresses included in transit and during installation.

## 2.3 STRUCTURES

- A. Structures shall be totally enclosed, dead-front, free-standing assemblies. Motor control centers shall be designed for against-the-wall mounting. All wiring, bus joints and other mechanical parts requiring tightening or other maintenance shall be accessible from the front or top.
- B. Structures shall be capable of being bolted together to form a single assembly.
- C. The overall height of the MCC shall not exceed 90 in (2286 mm) (not including base channel or lifting angle).
- D. Base channels, of 1.5 in (38 mm) in height, and lifting angles, of 3 in (76 mm) in height, shall be removable.
- E. The total width of one section shall be 20 in or 21 in, minimum. Widths of 25 in (630 mm), 30 in (760 mm), and 35 in (890 mm) shall be used for large devices.
- F. Structures shall be NEMA type 12 gasketed.
- G. Each standard wide section shall have all the necessary hardware and bussing for modular plug-in units to be added and moved around. All unused space shall be covered by hinged blank doors and equipped to accept future units. Vertical bus openings shall be covered with manual bus shutters.
- H. Each section shall include a top plate and bottom plate. Top and bottom plates shall be removable for ease in cutting conduit entry openings.
- I. Vertical sections shall be mounted on steel channel sills continuous on four sides, or with steel channel sills on two sides and end cover plates.

## 2.4 WIREWAYS

- A. Structures shall contain a minimum 12 in (305 mm) high horizontal wireway at the top of each section and a minimum 6 in (152 mm) high horizontal wireway at the bottom of each section. These wireways shall run the full length of MCC to allow room for power and control cable to connect between units in different sections.
- B. A full-depth vertical wireway shall be provided in each MCC section that accepts modular plug-in units. The vertical wireway shall connect with both the top and bottom horizontal wireway and shall be isolated from unit interiors by a full height barrier. The vertical wireway shall be 4 in (102 mm) wide minimum with a separate hinged door. There should be a minimum of 4,000 cu. in. of cabling space available. Access to the wireways shall not require opening control unit doors.
- C. Structures that house a single, full section control unit are not required to have vertical wireways. Those control units must open directly into the MCC horizontal wireways.
- D. All openings used for wiring shall have insulating grommets.

## 2.5 BARRIERS

- A. All power bussing and splice connections shall be isolated from the unit compartments and the wireways.
- B. The horizontal bus shall be mounted onto a glass filled polyester support assembly that braces the bus against the forces generated during a short circuit.
- C. The horizontal bus shall be isolated from the top horizontal wireway by a two-piece grounded steel barrier. This barrier shall be removable to allow access to the bus and connections for maintenance.
- D. The vertical bus shall be housed in a molded glass-filled polyester support that provides bus insulation and braces the bus against the forces generated during a short circuit. These supports shall have openings every 3 in (75 mm) for unit stab-on connections.
- E. Each opening shall be provided with a manual shutter to close off the stab opening. These shutters shall be attached to the structure so that when they are removed (to allow a stab connection) they are retained in the structure and are readily accessible for use should a plug-in unit be removed from the MCC.
- F. Barriers shall be provided in the vertical structure and unit designs to prevent the contact of any energized bus or terminal by a fish tape inserted through the conduit or wireway areas.

## 2.6 BUSSING

- A. All bussing and connectors shall be tin-plated or silver-plated copper. All bolted bus

sections shall be silver-plated at the point of connection.

- B. The main horizontal bus shall be rated per the drawings and shall extend the full length of the MCC. Bus ratings shall be based on 65° C maximum temperature rise in a 40° C ambient. Provide copper compression lugs of appropriate ampacity. Bottom plates shall be furnished when neutral bus is specified.
- C. Provisions shall be provided for splicing future additional sections onto the ends of the MCC.
- D. The horizontal bus splice bars shall be pre-assembled into a captive bus stack. This bus stack is installed into the end of the MCC power bus to allow the installation of additional sections. The main bus splice shall utilize four bolts, two on each side of the bus split, for each phase. Additional bolts must not be required when splicing higher amperage bus.
- E. Each section that accepts plug-in units shall be provided with a vertical bus for distributing power from the main bus to the individual plug-in starter units. This bus shall be of the same material and plating as the main bus, and shall be rated at 300 A continuous minimum. Provide 600 A vertical bus where required by loads. The vertical bus shall be connected directly to the horizontal bus stack without the use of risers or other intervening connectors. When a back-to-back unit arrangement is utilized, separate vertical bus shall be provided for both the front and rear units.
- F. A tin-plated copper ground bus shall be provided that runs the entire length of the MCC. The ground bus shall be 0.25 in (6.0 mm) x 2.0 in (50 mm) and be rated for 600 amps.
- G. Copper compression lugs shall be provided in the MCC for a 4/0-250 kcmil ground cables, two per each lineup. The ground bus shall be provided with (6) 0.38 in (10 mm) holes for each vertical section to accept customer-supplied ground lugs for any loads requiring a ground conductor.
- H. Each vertical section shall have a tin-plated copper vertical ground bus that is connected to the horizontal ground bus. This vertical ground bus shall be installed so that the plug-in units engage the ground bus prior to engagement of the power stabs and shall disengage only after the power stabs are disconnected upon removal of the plug-in unit.
- I. MCC's shall be rated for the available short circuit capacity as indicated on the drawings.

## 2.7 TYPICAL UNIT CONSTRUCTION

- A. Units shall be service entrance rated and provided with:
  - 1. UL service entrance label.
  - 2. Ground bus.
- B. Provide NEMA Class IIS, type B wiring configuration. All wiring, relays, controls, ect. for each motor shall be located in the associated motor unit compartment.

- C. All surfaces (back, side and bottom plates) of the unit interior shall be painted white.
- D. Units with circuit breaker disconnects through 400 A frame, and fusible switch disconnects through 400 A, shall connect to the vertical bus through a spring reinforced stab-on connector. Units with larger disconnects shall be connected directly to the main horizontal bus with appropriately sized cable or riser bus. Stabs on all plug-on units shall be solidly bussed to the unit disconnect. Cabled stab assemblies are not permitted.
- E. All conducting parts on the line side of the unit disconnect shall be shrouded by a suitable insulating material to prevent accidental contact with those parts.
- F. Unit mounting shelves shall include hanger brackets to support the unit weight during installation and removal. All plug-on units shall use a twin-handle camming lever located at the top of the bucket to rack in and out the plug-on unit. The cam lever shall work in conjunction with the hanger brackets to ensure positive stab alignment.
- G. A handle operator must be provided on each disconnect. With the unit stabs engaged onto the vertical phase bus and the unit door closed, the handle mechanism shall allow complete ON/OFF control of the unit disconnect with clear indication of the disconnects status. All circuit breaker operators shall include a separate TRIPPED position to clearly indicate a circuit breaker trip condition. It shall be possible to reset a tripped circuit breaker without opening the control unit door.
- H. A mechanical interlock shall prevent the operator from opening the unit door when the disconnect is in the ON position. Another mechanical interlock shall prevent the operator from placing the disconnect in the ON position while the unit door is open. It shall be possible for authorized personnel to defeat these interlocks.
- I. A non-defeatable interlock shall be provided between the handle operator and the cam lever to prevent installing or removing a plug-on unit unless the disconnect is in the OFF position.
- J. The plug-in unit shall have a grounded stab-on connector which engages the vertical ground bus prior to, and releases after, the power bus stab-on connectors.
- K. Provisions shall be provided for locking all disconnects in the OFF position with up to three padlocks.
- L. Unit construction shall combine with the vertical wireway isolation barrier to provide fully compartmentalized design.
- M. All conducting parts on the line side of the unit disconnect shall be shrouded by a suitable insulating material.
- N. Unit mounting shelves shall include hanger brackets to support the unit weight during installation and removal.

- O. With the unit stabs engaged into the vertical phase bus and the unit door closed, the handle mechanism shall allow complete ON/OFF control of the unit disconnect with clear indication of the disconnects status.
- P. Unit construction shall combine with the vertical wireway isolation barrier to provide a fully-compartmentalized design.
- Q. Up to a maximum of twelve six-inch units can be installed per vertical section without placement restrictions in new or existing applications.
- R. Each compartment shall be provided with a hinged door of pan construction on the front and a door opening of sufficient size so as to allow for ready removal of any of the components in the compartment. Doors shall open at least 90 degrees, and far enough to remove units without removing doors. A minimum of two hinges per door shall be provided. Doors 36 to 48 inches in height shall have a minimum of three hinges. Doors in excess of 48 inches shall have a minimum of four hinges.
- S. Each unit to be provided with a control panel for up to a maximum of four pilot devices. Control panel to be removable by loosening two semi-captive fasteners for access.

## 2.8 MCC COMPONENTS

### A. Combination Starters:

1. All motor starters shall be combination motor circuit protector and contactor three pole, 60 Hertz, 600 Volt, magnetically operated, of the types shown on the drawings. All motor starters shall have a 120 Volt operating coil.
2. NEMA sizes shall be as required for the horsepower shown on the drawings, but shall not be less than NEMA Size 1. Verify final horsepower ratings before placing motor control centers into production.
3. All combination starters shall utilize a unit disconnect as specified above. Magnetic starters shall be furnished in all combination starter units.
4. All starters shall utilize NEMA rated contactors.
5. Starters shall be provided with a three-pole, external manual reset, overload relay for ambient compensated bimetallic thermal overload units.
6. Control circuit transformers shall be oversized, 100 VA minimum, and shall include two primary protection fuses and one secondary fuse (in the non-ground secondary conductor). The transformer shall be sized to accommodate the contactor(s), all connected control circuit loads, motor heaters and auxiliary relays and devices. The transformer rating shall be fully visible from the front when the unit door is opened.
7. When a unit control circuit transformer is not provided, the disconnect shall

include an electrical interlock for disconnection of externally powered control circuits.

8. Auxiliary control circuit interlocks shall be provided where indicated.
9. Auxiliary interlocks shall be field convertible to normally open or normally closed operation.
10. NEMA Size 1 through size 4 starters shall be mounted directly adjacent to the wireway so that power wiring (motor leads) shall connect directly to the starter terminals without the use of interposing terminals. Larger starters shall be arranged so that power wiring may exit through the bottom of the starter cubical without entering the vertical wireway.
11. Auxiliary control relays shall be 300V, miniature type to minimize unit compartment space requirements. Timing relays shall be true on and true off type time delay relays.
12. Motor circuit protectors shall be molded case 600 Volts, 3 Pole, 60 Hertz with adjustable magnetic trip settings. Motor circuit protectors shall have toggle type, quick-make/quick-break, overcenter switching mechanism and auxiliary disconnect contacts when used with starters having external control circuits. Rating selected shall provide complete protection of, and coordination with, motor starter overload relays and heaters. Electrical Contractor shall verify the motor horsepower and install rating as required by the NEC for the full load current of the motor actually installed. Motor circuit protectors shall be furnished with bolt on current limiting fuses.
14. All starters shall be provided with run timers Running time meters shall be 3-1/2 inch square case; non-reset, 99,999.9 hour range; Type 236 as manufactured by General Electric Co., equal by Allen Bradley, Cutler-Hammer, or equal.
15. Control stations shall be standard 30mm sizes, heavy-duty, oiltight, General Electrical type CR 104 series or equal.
16. Indicating light shall be LED type, with push-to-test features.
17. Provide all controls and accessories as shown on the equipment motor wiring diagrams in the contract drawings. Specialized interface relays supplied by the equipment manufacture shall be installed in the each associated motor MCC bucket by the MCC manufacture at the MCC manufacturing plant. Coordinate with the equipment manufacture for space requirements and delivery of the relays.

**B. Terminal Blocks**

1. Provide Type B wiring with all starter units provided with unit control terminal

blocks.

2. Terminal blocks shall be the pull-apart type 600 volt and rated at 25 amps.
3. All current carrying parts shall be tin-plated.
4. Terminals shall be accessible from inside the unit when the unit door is opened.

C. Nameplates and Identification

1. Provide engraved phenolic nameplates for each MCC and unit compartment screwed to the doors of each individual compartment and wiring diagrams pasted inside each door.
2. Compartments containing panel boards shall have a card-holder on the inside of the door. Compartments containing motor starters shall have an overload heater selection table pasted inside the door.
3. Provide with white background with black letters, measuring a minimum of 1.5 in (38 mm) x 6.25 in (159 mm).
4. Each motor control center shall be furnished with a sign marked "DANGER - HIGH VOLTAGE - KEEP OUT!". Letters shall be not less than one inch high. Signs shall be laminated plastic, engraved red letters with a white background.
5. All compartments with voltages from sources outside of the compartment shall have a sign on the compartment door marked "CAUTION - THIS UNIT CONTAINS A VOLTAGE FROM A SOURCE OUTSIDE THIS UNIT". Letters shall be black on a high visibility yellow background. Background shall be vinyl approximately three inches by five inches.

2.9 WIRING

- A. All wiring shall be copper.
- B. Compartment wiring shall be no. 14 AWG minimum, and connected to compartment mounted, plug-in terminal blocks that allow compartments to be withdrawn without having to remove wires from fixed terminal blocks.
- C. Power wiring shall be black in color, control wiring shall be red in color, wiring energized from sources other than the starter control power transformer shall be yellow in color. No deviations from this wiring scheme shall be accepted.

2.10 MCC FINISH

- A. All steel parts shall be provided with UL and CSA listed acrylic/alkyd baked enamel paint finish, except plated parts used in bus connections.
- B. All painted parts shall undergo a multi-stage treatment process, followed by the finishing

paint coat.

- C. Pre-treatment shall include:
  - 1. Hot alkaline cleaner to remove grease and oil.
  - 2. Iron phosphate treatment to improve adhesion and corrosion resistance.
- D. The paint shall be applied using an electro-deposition process to ensure a uniform paint coat with high adhesion.
- E. The standard paint finish shall be tested to UL 50 per ASTM B117 (5% ASTM Salt Spray) with no greater than 0.125 in (3 mm) loss of paint from a scribed line.
- F. Paint color shall be #61 light gray per ANSI standard Z55.1-967 (60-70 gloss) on all surfaces unless specified otherwise.
- G. Control station plates and escutcheon plates shall be painted a contrasting gray.
- H. All unit interior saddles shall be painted white for better visibility inside the unit.

## 2.11 QUALITY CONTROL

- A. The entire MCC shall go through a quality inspection before shipment. This inspection will include:
  - 1. Physical Inspection of Structure.
    - a. Bussing.
    - b. General wiring.
  - 2. Electrical Tests AC Dielectric Tests of:
    - a. Power circuits
    - b. Control circuits.
  - 3. Electrical Tests before shipment shall include:
    - a. Power circuit phasing.
    - b. Control circuit wiring
    - c. Instrument transformers
    - d. Meters.
    - e. Ground fault system.
    - f. Device electrical operation.
  - 4. Markings/Labels, include:
    - a. Instructional type.



- b. Underwriters Laboratory (UL)/Canadian Standards Association(CSA).
  - c. Inspector's stamps.
5. The manufacturer shall use integral quality control checks throughout the manufacturing process to ensure that the MCC meets operating specifications.

## PART 3 – EXECUTION

### 3.1 INSTALLATION

- A. Motor control centers shall be bolted to angle iron sills. The sills shall be imbedded in a smooth, level raised concrete pad on the on the two longest sides. The sills shall be the full length of the motor control center and shall be installed level in all directions. Where motor control centers are installed back to back, or against a wall they shall be secured to the wall or adjacent MCC by means of a channel support.
- B. Field installed interior wiring shall be neatly grouped by circuit and bound by plastic tie wraps. Circuit groups shall be supported such that circuit terminations are not stressed.
- C. Motor control centers shall be maintained in an upright position at all times. Lifting shall be only at the floor sills or the top mounted lifting angle.
- D. The motor control shall be protected against damage at all times. Any damage to the paint shall be carefully repaired using touch-up paint furnished by the motor control center manufacturer.
- E. Install all required interlock wiring.
- F. Motor control center section shall be arranged such that all large and/or heavy components are located in the lower spaces of the various section. Top heavy sections shall be avoided.

### 3.2 TESTS AND CHECKS

- A. The following minimum tests and checks shall be made before energizing the motor control center.
  - 1. Megger terminals and buses for grounds after disconnecting devices sensitive to megger voltage.

### 3.3 DEMONSTRATION

- A. Engage a factory-authorized service representative to explain programming and operation of all system components and to train Owner's maintenance personnel on procedures and schedules for maintaining, operating, adjusting, troubleshooting, and servicing equipment. Provide a minimum of eight hours training in operation and maintenance.

### 3.4 SPARE PARTS

A. Provide the following spare parts to the Owner.

1. Indicating lamps, 4 of each type.
2. Control switches, 2 of each type.
3. Overload heaters, 1 of each type installed.
4. Starter and relay coils, 2 of each type.
5. Fuses, 3 of each type.

- END OF SECTION -

## SECTION 16495

### VARIABLE FREQUENCY DRIVES

#### PART 1 – GENERAL

##### 1.1 DESCRIPTION

- A. The work of this section includes furnishing all labor, materials, tools and equipment necessary to furnish and install Variable Frequency Drives (VFD) as shown on drawings, specified herein, or evidently required to complete the work.
- B. Refer to various DIVISION 11 – EQUIPMENT sections and contract drawing motor wiring diagrams for field device interface.

##### 1.2 SUBMITTALS

- A. Shop Drawings and/or brochures shall be submitted to the Engineer in accordance with Section 01300.
- B. Submittals required under this section include, but are not limited to the following:
  - 1. Shop drawings showing complete fabrication and construction details, materials, electrical components, enclosures, input line reactors, harmonic filters, weights, dimensions, clearances, anchorage locations, piping and utility requirements, and step by step sequence of controls.
  - 2. Certified Performance and Efficiency Characteristics.
  - 3. The Contractor shall provide the VFD manufacturer with copies of all motor shop drawing submittals and or nameplate data. The VFD manufacturer shall review this data and shall certify in writing that the equipment has been coordinated with the variable frequency drives and motors for complete compatibility.
  - 4. Harmonic Analysis and written summary report.
  - 5. Complete master wiring diagrams, VFD layout drawings and control schematics, including required coordination with other electrical control devices operating in conjunction with each VFD and suitable outline drawings shall be furnished for each VFD being supplied for approval before proceeding with manufacture. Due to the complexity of the control functions, it is imperative the above drawings be clear and carefully prepared to facilitate interconnections with other equipment. Standard preprinted sheets or drawings simply marked to indicate applicability to this contract will not be acceptable.

##### 1.3 DELIVERY, STORAGE AND HANDLING

- A. All materials and equipment shall be shipped, stored, and handled in accordance with Section 01600.
- B. The materials and components shall be stored on a flat, clean surface to prevent damage and shall be covered to prevent exposure to adverse conditions prior to installation.
- C. All materials shall be shipped, stored, handled and installed in such a manner as not to degrade quality, serviceability, or appearance.

#### 1.4 DESIGN CRITERIA

- A. The materials and equipment covered by this specification are intended to be standard materials and equipment of demonstrated successful performance, as manufactured by reputable concerns. Equipment shall be designed and constructed in accordance with the highest standards of the industry and shall be installed in accordance with the manufacturer's recommendations and the Contract Documents. The specifications call attention to certain features but do not purport to cover all details entering into the construction of the equipment.
- C. Provide individual constant torque VFD's with LCL line filters, low harmonic drives, and soft starter by-pass. Each individual VFD requires all these devices to be factory mounted within its enclosure. Field mounting of drive related accessories is unacceptable.
- D. All equipment submitted shall be provided with enclosures that can be installed in the spaces shown on the drawings. Enclosures that exceed the allowable space provided shall be subject to rejection.
- E. Heat dissipation from VFD enclosures shall meet all requirements of the specifications.
- F. All VFDs shall be passive filtered low harmonic drives for the wastewater and water industry meeting the requirements of IEEE-519 as manufactured by ABB, Eaton, General Electric, or Schneider Electric.
- G. Each VFD unit shall be U.L. listed or labeled.

#### 1.5 HARMONIC REQUIREMENTS

- A. Under normal operating conditions, the line harmonics introduced into the power system from the AC VFD unit(s) shall be within the distortion limits as defined in IEEE 519 and less than %5 Ithd. The point of common coupling shall be the main distribution panel.

### PART 2 – PRODUCTS

#### 2.1 DRIVES

- A. This specification is intended to outline the overall physical features, performance and functional requirements of the VFD equipment required under this section, consisting of a variable speed adjustable frequency converter, by-pass contactor, filters, accessories,

and enclosure. The VFD system shall be fully tested by the manufacturer before initial startup with all components compatible in function and appearance.

B. Variable Speed Adjustable Frequency Converter. The adjustable frequency drive shall be UL Listed solid state type in a NEMA 12 filtered enclosure and blower cooled. The filter element shall be of the removable and replaceable type for each drive unit. Front access shall be provided. Top, rear and side access shall not be required. The enclosure shall be coated with an epoxy resin base and acrylic resin enamel finish. The drive shall meet applicable provisions of DIVISION 16, ELECTRICAL, the National Electric Code and NEMA. The drive shall be arranged for 480 Volts plus 10 percent to minus 5 percent, three phase, 57 to 63 Hertz input converted into adjustable frequency/Voltage output in an ambient temperature of -10 to 40 degrees C. The VFD shall be capable of sustaining operation with a line voltage dip of 15 percent of normal operating voltage on a constant torque or variable torque load. During line dip the VFD shall automatically provide a speed drop allowing maximum capable speed for the duration of the input voltage dip. Each individual drive shall be mounted in a separate enclosure. The drive efficiency shall be 97 percent or better at full speed and full load. Fundamental power factor shall be 0.98 at all speeds and loads. Each individual drive and associated equipment shall be mounted in a single and individual enclosure unless otherwise specified. The following features shall be included with each adjustable frequency drive:

1. Control. The control method shall be sinusoidal Pulse Width Modulation. Output Voltage shall be three phase, 480 Volts and output frequency shall be 0.1 to 66 Hz when shipped. Frequency shall be selectable by a digital keypad. The frequency resolution shall be 0.1 Hz and the accuracy shall be within 1.0 percent of the maximum frequency at 25 degrees plus or minus 10 degrees C. Voltage/frequency (V/f) characteristics shall be characterized by selectable patterns. Up to 82 control functions shall be programmed. The overload capacity shall be 110 percent continuous and a minimum two minute rating of 150 percent of rated current. The frequency setting signal shall be 4 to 20 mA. The VFD shall employ a full wave rectifier to prevent input line notching, DC bus choke, DC bus capacitors, and Insulated Gate Bipolar Transistors (IGBT's) as the output switching device. SCRs, GTOs and Darlington transistors are not acceptable.
2. Function. The adjustable parameters consisting of: accelerating time, decelerating time, upper and lower limit of output frequency, and 4 to 20 mA reference bias and reference gain shall be indicated on a digital display. Braking shall be achieved through capacitor charging and starting shall be achieved by external contact. The VFD shall be software configurable to automatically restart following power outage, overcurrent and overvoltage detection. Soft stall shall occur when motor runs continuously at overload.
3. Protection. The drive shall be protected from stalling, overcurrent, overload, short circuit, overvoltage, undervoltage, loss of one (1) phase of input power, instantaneous power failure (approximately 30 msec), overheating, fuse burnout protection and earth (ground) fault detection. The fault cause shall be displayed (flickering) for overcurrent, short circuit, overload, overvoltage, overheating and earth (ground) fault. There shall be a main capacitor charging indicator for

internal circuit. Fault shall be reset by a reset push button on the printed circuit board and an external reset contact.

4. Displays. The digital display shall be a 2 line, 40 character unit with readout in plain English. A separate LED indicator shall be provided for capacitor charge. Display shall be located on the door of the VFD enclosure.
5. Internally mounted set point control shall be provided to receive either a 4 to 20 mA dc or 0 to 10 vdc analog input control signal from a process panel to control the speed of the motor. An external digital display shall be provided outside of the inverter. The following control devices shall be available for external control of the inverter; frequency/speed meter, frequency setting variable resistor, knob for frequency setting variable resistor and drive switch. The drive shall be capable of receiving a dry contact input to override the analog input control signal and control the flow rate to 95%.
6. A bypass motor starter and VFD VFD/Bypass switch shall be provided to allow VFD bypass and straight in line full load motor operation. A solid state bypass soft start style motor starter shall be provided for all motors 30HP and greater. The line and load sides of the soft start motor starter shall be electrically isolated from incoming power and motor respectively with contactors in which will not close until the bypass switch is in the bypass position.
7. A lockable main load break disconnect switch interlocked with the enclosure door with through the door handle to provide positive disconnect of incoming AC power shall be furnished for each individual drive and enclosure. The circuit breaker shall be rated at a minimum 25,000 amperes at 480 volts, RMS symmetrical.
8. Each drive shall be provided with the following accessories:
  - a. "Local-Off-Remote" keypad switch for local/remote speed control. In the "Remote" mode, the motor speed shall be adjusted in response to the related remote 4 to 20 mA pacing signal. In "Local" mode the motor speed shall be adjusted in response to keypad entry speed and the VFD shall run when the "Hand-Off-Auto" selector switch is in "HAND". . In "Off" mode the VFD shall not run.
  - b. Provide a 4-20 mA speed feedback output signal.
  - c. Provide four (4) Type C dry contacts at each VFD for remote indication of motor running status.
  - d. "Hand-Off-Auto" selector switch located on the door of the VFD enclosure. In the "Auto" position the VFD shall be started and stopped remote via an external dry contact. In the "Hand" position the VFD shall run. In "Off" mode the VFD shall not run.
  - e. Elapsed time meters located on the door of the VFD enclosure.

- f. Provide two (2) type C contacts at each VFD for remote indication of VFD run and fault conditions.
- g. Motor running indicating light located on the door of the VFD enclosure.
- h. Motor off indicating light located on the door of the VFD enclosure.
- i. Drive failure indicating light located on the door of the VFD enclosure.
- j. Provide a bypass contractor operation indicating light located on the door of the VFD enclosure.
- k. All indication lights shall be LED push to test type.
- l. All time delay relays shall be true on and true off type that utilize the control signal for relay power.
- i. Provide all controls and accessories as shown on the equipment motor wiring diagrams in the contract drawings. Specialized interface relays supplied by the equipment manufacture shall be installed in the VFD cabinet by the VFD manufacture at the VFD manufacturing plant. Coordinate with the equipment manufacture for space requirements and delivery of the relays.

## PART 3 – EXECUTION

### 3.1 VERIFICATION OF CONDITIONS

- A. Before the start of the work of this Section, verify that the project is ready for this work.
- B. Verify that field measurements are as shown on approved shop drawings and/or manufacturer's instructions.
- C. Verify that the equipment or material is in conformance with the approved shop drawings and specifications and resolve any deviations.
- D. Notify subcontractors involved or affected by this work and coordinate the work with them.

### 3.2 INSTALLATION

- A. All materials and equipment shall be installed in a neat, workmanlike manner.
- B. Minimum requirements of all wiring of the equipment shall be as specified under DIVISION 16 -ELECTRICAL of these specifications.
- C. Installation of the equipment shall be in accordance with written instructions provided by

the manufacturer and as approved.

### 3.3 PAINTING

- A. Shop painting and the surface preparation is a part of the work specified herein. Enclosures shall be coated with an electrostatically-applied epoxy enamel.

### 3.4 CLEAN UP

- A. Prior to start-up and field testing, all foreign matter shall be removed from the equipment. Spillage of lubricants used in servicing the system shall be cleaned from all equipment and concrete surfaces.

### 3.5 MANUFACTURER'S FIELD SERVICES

- A. Manufacturer's Field Services shall be provided for field programming and startup for all the VFDs provided.

### 3.6 MANUFACTURER'S TRAINING

- A. Manufacturer's training shall be provided for training of Owner's personnel for each type of VFD provided in accordance with Section 01700.
- C. Manufacturer's Training of Owner's Personnel shall be a minimum of two (2) calendar days performed at the project site.

### 3.7 SPARE PARTS

- A. One set of spare parts shall be provided for each VFD size.
- B. Spare parts for each VFD Size:
  - 1. One (1) control interface.
  - 2. Three (3) fuses.
  - 3. One (1) VFD module each size provided without enclosure

### 3.8 WARRANTY

- A. A manufacturer's warranty for three years shall be provided for each VFD.

- END OF SECTION -



## SECTION 16500

### LIGHTING

### SYSTEMS

#### PART 1 – GENERAL

##### 1.1 DESCRIPTION

- A. The work of this section includes the furnishing and installing of complete lighting systems including panelboards, transformers, lighting fixtures, receptacles, switches, and all accessories and appurtenances required as specified herein and as shown on the drawings.

##### 1.2 SUBMITTALS

- A. Submit the following in accordance with Section 01300:
  - 1. Light Switches
  - 2. Receptacles
  - 3. Astronomical Time Clock Switch
  - 4. Lighting Fixtures
  - 5. Device Plates
  - 6. Emergency Lighting Battery Units and Exit Lights

##### 1.3 DELIVERY, STORAGE AND HANDLING

- A. Provide in accordance with Section 01600.
- B. All materials shall be shipped, stored, handled and installed in such a manner as not to degrade quality, serviceability, or appearance.

##### 1.4 DESIGN CRITERIA

- A. All lighting fixtures shall be in accordance with the National Electrical Code and shall be constructed in accordance with the Underwriters Laboratories “Standards for Safety, Electric Lighting Fixtures.” All lighting fixtures shall be Underwriters Laboratories labeled.

#### PART 2 – PRODUCTS

##### 2.1 WIRE:

- A. Wire shall be as specified under Section 16120, Wire and Cables.

##### 2.2 CONDUIT

- A. Conduit shall be as specified under Section 16130, Raceways and Fittings.

### 2.3 PANELBOARDS

- A. Panelboards shall be as specified under Section 16442, Panelboards.

### 2.4 LIGHT SWITCHES

- A. NEMA WD 1, UL 20, Heavy-Duty, AC only general-use toggle switch.
- B. Rated 20 Amperes, 120/277 Volts for inductive and resistive loads.
- C. Motor rated up to 80 percent of ampere rating.
- D. Totally enclosed in a phenolic base and cover.
- E. U.L. and CSA Listed.
- F. Explosion-proof Switches: Provide explosion proof, 20 Ampere, 125 Volt, front operated switch in all NEMA 7 areas. Switches shall be UL listed rated for Class I, Division 1, Groups C and D hazardous areas.

### 2.5 RECEPTACLES

- A. NEMA WD 1, UL 498, Heavy-duty general use receptacle.
- B. GFCI Receptacle: UL 943, Convenience receptacle with integral ground fault circuit interrupter and indication light that is lighted when device is not tripped.
- C. NEMA WD 6, straight blade type for rated current and phases as indicated on drawings.
- D. Weatherproof Cover Plate: NEMA 3R, thermoplastic while use type covers by Hubbell or equal.
- E. Explosion-proof Receptacles: Provide explosion proof, 20 Ampere, 125 Volt, 3-pole, 2-wire, simplex type receptacles with hinged cover in all NEMA 7 areas. Furnish matching explosion proof plug with mechanical cable grip for every two receptacles installed (minimum of one). Receptacles and plugs shall be UL listed rated for Class I, Division 1, Groups C and D hazardous areas.

### 2.6 ASTRONOMICAL TIME CLOCK SWITCH

- A. Astronomical Time Clock Switch shall be programmable astronomically controlled switch front LCD time display and programmable buttons mounted in a standard back box.
- B. The switch shall be 1-pole, 15 Amp rated and capable of 7-day week time scheduling, equal to Leviton VPT24-1PZ Vizia by Leviton or equal by Hubbell or Legrand.

- C. Operation: Exterior lights shall be energized when the astronomical dusk time of day dial is past time. The lights shall remain energized until either the "Off" time of day or astronomical dawn time of day is past time.

## 2.7 DEVICE PLATES

- A. Plates for shall be of the required number of gangs for the application involved and shall be Type 302 (18-8) stainless steel of the same manufacturer as the device.

## 2.8 LIGHTING FIXTURES

- A. Lighting fixture shall be LED illuminated and of type as shown on the drawings. The catalog numbers listed are given as a guide to the design and quality of fixture desired. Equivalent designs and equal quality fixtures of other manufacturers will be acceptable.
- B. The fixture shall be tested to IESNA LM-79-08 and LM-80 Testing Standards at 25° C ambient temperature
- C. The LED package shall be designed around the lumen maintenance of 87% at 60,000 hrs. and is to be expected to achieve L70 at 100,000 hrs.
- D. The Light Engine shall be a high efficacy LED light engine equipped with brand-name LEDs available in outputs of 100%, 85%, 70% and 55%.
- E. The LED Drivers shall be Electronic Class 2, high efficiency, with the following power factor correction (PFC):
  - 1. Standard Non-Dimming Driver (PFC>0.95).
  - 2. Dimming Drivers (PFC>0.90).

## 2.9 EMERGENCY LIGHTING BATTERY UNITS AND EXIT SIGNS

- A. Emergency lighting units shall be fully automatic with nickel cadmium or lithium ion batteries. The wattage of the unit shall be sufficient to power the remote lamps as shown on the Contract Drawings, plus 20% spare capacity, for 1-1/2 hour upon loss of AC power. Units shall be designed for 120 Volt, 60 Hertz input and have an automatic clock timer and solid state charger, ready/off switch, press-to-test switch, amber "ready" light, red "charge" light and required number of supervisory relays.
- B. Provide Holophane DeSoto DSL46 series emergency lighting units, in NEMA 4 or 4X areas, Holophane DeSoto DSL3 series in NEMA 12 areas, and Holophane Cortez CZQ6L in NEMA 1 areas. Units manufactured by Hubbell, Dual Lite or approved equal are also acceptable. Lighting heads shall be 1100 lumens, LED type.
- C. Provide exit signs with LED lamps, nickel cadmium battery, battery charger, white background with red lettering. In NEMA 1 and 12 areas provide Holophane QM-LED series and in NEMA 4X areas provide Holophane DLTX series. Equivalent units manufactured by Dual Lite, Sure Lite or approved equal are acceptable.
- D. In NEMA 7 areas provide emergency exit signs series HDX by Holophane. Equivalent

units manufactured by Hubbell, Dual Lite or approved equal are acceptable

- E. In non NEMA 7 areas provide remote wall mounted lamp heads sealed thermoplastic, 1100 lumens, LED type with weatherproof mounting base by Holophane. Equivalent units manufactured by Hubbell, Dual Lite or approved equal are acceptable.
- F. In NEMA 7 areas provide emergency lighting dual remote lamp heads Series DSHRD, 12 volts, 12 watts halogen, by Holophane. Equivalent units manufactured by Hubbell, Dual Lite or approved equal are acceptable.

## PART 3 – EXECUTION

### 3.1 INSTALLATION

- A. Each fixture shall be a completely finished unit with all components, mounting and/or hanging devices necessary, for the proper installation of the particular fixture in its designated location and shall be completely wired ready for Connection to the branch circuit wires at the outlet. All pendant mounted fixtures shall be mounted plumb with floors and walls.
- B. When fixtures are noted to be installed flush, they shall be complete with the proper accessories for installing in the particular ceiling involved. All flush mounted fixtures shall be supported from the structure and shall not be dependent on the hung ceilings for their support.
- C. Flexible fixture hangers shall be used for all pendant mounted fixtures. Pendant mounted fixtures shall be supported from 3/4 inch galvanized rigid steel conduit.
- D. Receptacles and switches shall be mounted at 45” above finished floor.
- E. Mounting heights given are to the bottom of the fixture.

### 3.2 CLEANING UP

- A. All fixtures shall be left in a clean condition, free of dirt and defects, before acceptance by the Engineer.

- END OF SECTION -

## SECTION 16721

### FIRE ALARM SYSTEMS

#### 1.0 PART 1 – GENERAL

#### 1.1 SCOPE

- A. The work of this subsection includes the furnishing and installing of a complete addressable fire alarm system for the buildings as specified herein and as shown on the drawings. The system shall be capable of standalone operation and being networked via fiber optics with future fire alarm panels in the plant and act as one overall plant facility fire alarm system. The system shall be electrically supervised, connected, tested and left in first class operating condition.
- B. The system shall consist of, but shall not be limited to, fire alarm control panels and associated data highway, fire and smoke detection devices, manual pull stations, audible/visual alarms, alarm annunciator, fiber optic network, conduit, fittings, outlet boxes and wire, operating instructions and maintenance instructions.
- D. The General Contractor and Electrical Contractor shall meet with the local fire department prior to submitting any shop drawings for this project

#### 1.2 SUBMITTALS

- A. Submit the following in accordance with Section 01300:
  - 1. The system riser diagram shall indicate every alarm control panel, terminal panel, actuating device, annunciator panel and the required interconnecting wiring with wire type, quantity and raceways sizes.
  - 2. Description of system operation, of each panel and device.
  - 3. Original copies of catalog cuts of all devices, modules, batteries, battery chargers, etc. Copies of internet based data shall not be acceptable.
  - 4. Battery load calculations for each panel.
  - 5. Operating instructions and maintenance procedures. Operating instructions shall be furnished separate from manufacturers standard catalog literature and shall include recommended customer troubleshooting procedures. Maintenance procedures shall be furnished separate from manufacturer's standard catalog literature and shall include battery maintenance, lamp and fuse replacement, detector periodic checking and reset procedures, and other applicable procedures.

#### 1.3 DELIVERY, STORAGE AND HANDLING:

- A. Provide in accordance with Section 01600.
- B. All materials shall be shipped, stored, handled and installed in such a manner as not to degrade quality, serviceability, or appearance.

#### 1.4 DESIGN CRITERIA

- A. The equipment and completed installation shall be in compliance with local and national codes, authorities having jurisdiction, the local Fire Department, and in accordance with applicable sections of the latest edition of NFPA 72 for Fire Alarm Systems.
- B. All equipment shall be listed by National Fire Protection Association, Underwriters Laboratories and/or the Factory Mutual System.
- C. The equipment manufacturer shall have a local branch office within 75 miles staffed with trained, full time employees who are capable of performing testing, inspecting, repair and maintenance services for the life of the fire alarm system.
- D. All components of the system shall have been tested for compatibility with each other to ensure the system performs all intended functions.
- E. System Operation
  - 1. The operation of a manual station or activation of any automatic alarm initiating device (system smoke, heat) shall automatically:
    - a. Initiate the transmission of the alarm via a radio masterbox.
    - b. Sound a code 3 temporal evacuation signal over all audio circuits.
    - c. Flash all visual signals throughout the building in a synchronized manner.
    - d. Flash an alarm LED and sound an audible signal at the Fire Alarm Control Panel (FACP). Upon Acknowledgment, the alarm LED shall light steadily and the audible shall silence. Subsequent alarms shall re-initiate this sequence.
    - e. Visually indicate the alarm initiating device type and location via the LCD display located at the FACP.
    - f. Automatically shut down or control HVAC equipment. Manual override controls and programmable relay interface shall serve as an interface to the HVAC equipment.
    - g. Activate the exterior weatherproof beacon.
    - h. Alert the facility SCADA system via a dry contact fire alarm output.

2. The operation of a carbon monoxide detector shall automatically:
  - a. Sound a code 4 temporal evacuation signal over the detector's sounder base.
  - b. Illuminate the red alarm LED on the detector.
  - c. Flash an alarm LED and sound an audible signal at the FACP. Upon Acknowledgment, the alarm LED shall light steadily and the audible shall silence. Subsequent alarms shall re-initiate this sequence.
  - d. Visually indicate the alarm initiating device type and location via the LCD display located at the FACP.
3. The activation of a system trouble condition (system battery, broken circuit, ground fault, device failure, communication failure ect.)
  - a. Initiate the transmission of the trouble condition to an approved private monitoring station via a Digital Alarm Communicator/Transmitter (DACT).
  - b. Indicate the trouble condition and sound an audible signal at the FACP.

C. System Wiring

1. The system shall be wired, connected, and left in first class operating condition. Wiring shall be provided and installed in accordance with the manufacturers drawings. The contract drawings indicate the devices required for each building, the types of devices to be installed, and the general method for connecting the system devices together. The actual number of wires to be installed in each raceway and the size of each raceway shall be in accordance with the manufacturer's drawings.
2. Initiating circuits shall be addressable type.
3. Addressable loop wiring shall support all devices shown and allow for a minimum of 25% spare capacity and be wired in a Class X style.
4. As a minimum, power supplies and notification appliance circuits shall operate all devices shown plus 25% spare capacity, and be wired in a Class A style.

D. Fiber Optic networking cable shall be per manufacture recommendations.

E. System shall be addressable microprocessor based and shall provide the following features:

1. Sufficient memory to perform as specified and as shown for addressable system.

2. Individual identity of each addressable device for the following conditions: alarm; trouble; open; short; and appliances missing/failed remote detector - sensitivity adjustment from the panel for smoke detectors.
3. Capability of each addressable device being individually disabled or enabled from the panel.

## 1.5 SPARE PARTS

- A. Provide one detector and one audio/visual device of each type to the town at the conclusion of all work.

## 2.0 PART 2 – PRODUCTS

### 2.1 MANUFACTURERS

- A. The basis of design is based on the Notifier NFS-320 fire alarm system similar networking type systems by Gamewell and Faraday are acceptable. Systems by Siemens and Simplex are not allowed.

### 2.2 FIRE ALARM CONTROL PANEL

- A. Provide and install Fire Alarm Control Panels (FACP). The system shall support analog/addressable devices, expandable in a true peer-to-peer network (multi-panel) configuration.
  1. Monitor all initiating devices, report to each network node, annunciate the alarmed device and its' location, capture elevators, conduct smoke control functions, and initiate the audio/visual evacuation signaling and control sequences as described herein.
  2. Conduct municipal notification as described herein.
  3. Initiating devices shall respond with their condition. Control relays shall be individually addressable by the system to respond automatically in the event of an alarm of related sensors. Manual override of control relays shall be individually addressable by the operator.
- B. Control Configuration: All fire alarm control portions of the system shall be housed in red locking, semi-flush mounted enclosures. All panel initiating and control status indicators shall be visible through a clear Lexan window. Access to the control panel shall be by keys issued to the Fire Department and authorized personnel. Each panel shall incorporate an operator interface, CPU, addressable loop interface cards, audio control/microphone, amplifiers, power supply and batteries to perform the system operation as described herein.
- C. Primary Operator Control: The FACP shall provide an operator interface module consisting of a backlit LCD display to display all system alarm, trouble and supervisory



conditions, and shall provide common control switches for system status scrolling, alarm acknowledge, trouble acknowledge, reset, and system drill. The unit shall have LED indicators for Normal Power Status, Alarm, Supervisory, Trouble and Test/Program.

- D. Addressable Loop Interface: Provide an addressable loop interface card for each addressable signaling line circuit. Each circuit shall support digital communications with addressable field devices. The addressable loop interface shall support the following features and functions:
1. Provide full digital communications with analog field devices.
  2. An integral alarm relay which will support alarm operation in the event of a failure of addressable loop data communications.
  3. The interface card shall support the retrieval of the following information from each individual analog system device:
    - a. Device serial number
    - b. Device address
    - c. Device type and personality code
    - d. Date of manufacture
    - e. Hours in use
    - f. Number of alarms and troubles
    - g. Time and date of last alarm
    - h. Amount of environmental compensation left/used
    - i. Last maintenance date
    - j. Current detector sensitivity values
    - k. Diagnostic information (trouble codes)
- E. Auxiliary Control / Annunciation: Provide auxiliary annunciator switch and LED modules for simple LED annunciation, zone disconnect, HVAC override, or other related monitoring and control functions. These are intended for use by the Fire Department during an event, or by authorized personnel during testing periods. Keypad entered commands for these functions shall not be an acceptable substitute. Alarm LEDs and zone disconnect switches shall be provided by type of device on a per floor/zone basis. Provide a minimum of 64 discreet programmable alarm LEDs, and 32 discreet programmable 2-position control switches with corresponding LED indicators.
- F. System Power Supplies: Integral system power supplies shall provide 12amps of 24VDC operating and emergency power to each panel. Each supply shall contain brownout, low battery detection, system ground fault, and LED indicators for loss of AC or CPU failure.

### 2.3 INTELLIGENT SYSTEM DEVICES

- A. Provide intelligent analog devices where shown and required. Each device shall retain operating characteristics in non-volatile memory and conduct algorithms to distinguish real fire conditions from unwanted nuisance alarms. All analog devices shall provide dual LED indicators, a green LED shall flash to denote active communication, and a red LED shall flash to denote an alarm condition. Devices shall be interchangeable with twist-lock

bases which may include a supervised remote LED output, fault isolation circuitry, or an auxiliary relay contact. In the event of an addressable loop communications failure, devices shall remain capable of initiating an alarm sequence.

- B. Multi-sensing Smoke Detector: Provide multi sensing analog smoke detectors employing photoelectric and thermal sensing principles.
- C. Heat Detectors: Provide fixed temperature 135 degrees F vapor-tight industrial grade units connected to monitor modules.
- D. Explosion Proof Heat Detectors: Provide fixed temperature 135 degrees F explosion proof units connect to monitor modules in all NEMA 7 areas. Units shall be rated for Class I, Division 1, Groups C and D hazardous areas.
- E. Carbon Monoxide Detector: Provide analog carbon monoxide detectors shall employ an electrochemical sensing cell. The detector shall have a red LED alarm notification and audio sounder base.
- F. Analog Duct Smoke Detector: Provide analog photoelectric duct smoke detectors mounted in air ducts where shown on contract drawings. Each detector shall be supplied with duct mounting plate, remote test station/indicator and sampling tubes sized according to duct width. Provide the required auxiliary relay outputs or addressable relay control modules with each detector in order to accomplish the required HVAC control and override functions.
- G. Intelligent Manual Pull Stations: Provide intelligent addressable double action type manual stations with screw terminals, toggle switch, and integral addressable electronics. The station shall be constructed of red Lexan with white raised letters and a key reset switch. The station shall be keyed alike to the FACP.
- H. Explosion Proof Manual Pull Stations: Provide double action type explosion proof units connect to monitor modules in all NEMA 7 areas. Units shall be rated for Class I, Division 1, Groups C and D hazardous areas and be constructed of a red colored copper-free cast aluminum alloy with either white lettering or red lettering in a white background.
- I. Monitor Module: Provide addressable input monitor modules to monitor related systems or integrate conventional initiating devices onto the addressable loop.
- J. Control Module: Provide addressable output control modules to supervise and control conventional devices and interface with other equipment over the addressable loop. Control modules shall provide a supervised output rated for 1, 2 or 5 amps @ 24VDC and 120VAC, as required by the conventional device.
- K. Isolation Modules: Provide Isolator Modules to protect circuit integrity in the event of a wiring fault. Provide a minimum of one module per floor/zone, or one for every 25 devices; whichever is greater.

## 2.4 PRIMARY NOTIFICATION APPLIANCES

- A. Primary Notification Appliances: Flush mounted combination Audio/Visual Horn/Strobe type signaling appliances. Standalone devices may be used to augment combination units when necessary. Specific audible and visual characteristics shall be as follows:
  - 1. Visual Signals shall be self-synchronizing xenon strobes in compliance with NFPA 72. Strobes shall have an effective intensity rating of 15 candela in corridors and other areas up to 20' x 20', 30 candela in areas up to 30' x 30' and 110 candela in areas up to 50' x 50'.
  - 2. Audible Signals shall be horns in compliance with NFPA 72, 24 Volt dc polarized type with a minimum sound output shall be 90 db at 10 feet
- B. Explosion Proof Horn & Strobe: Provide explosion proof units consisting of a separate horn with and strobe device in all NEMA 7 areas. Units shall be rated for Class I, Division 1, Groups C and D hazardous areas and conform to the candela and db ratings listed paragraph 2.03.A.
- C. Exterior Strobe: Provide a flashing weatherproof strobe with a minimum 150,000 candlepower output where shown. The strobe shall be properly installed on a weatherproof backbox.

## 2.5 SYSTEM ACCESSORIES

- A. Municipal Connection: Provide a multi-zone Radio Masterbox for municipal reporting as required by the local authority having jurisdiction.
- B. Monitoring Connection: Provide a Digital Alarm Communicator/Transmitter with phone line connections to an approved Central watch station.
- C. Terminal Cabinets: Provide fire alarm terminal cabinets where necessary. The cabinets, which shall have a removable hinged cover with key lock and red finish are intended to house analog/addressable modules and facilitate field wiring junctions.
- D. Remote Alarm Indicators: Provide remote LED indicators for smoke detectors where indicated on contract drawings. Provide a permanent label on each indicator identifying the device type and actual location.
- E. Auxiliary Power Supplies: Where the power requirements exceed that which is supplied by the FACP, auxiliary power supplies may be used. Each auxiliary power supply shall be supervised for loss of AC power and Battery Fail, and each notification circuit served shall be individually supervised.
- F. Key Repository (Knox Box): Provide a key repository where shown and in accordance with local requirements. Box to surface mount type for mounting on existing walls.

## 3.0 PART 3 – EXECUTION

### 3.1 INSTALLATION

- A. Installation shall be supervised and tested by the system supplier. The work shall be performed by skilled technicians under the direction of experienced engineers, all of whom are properly trained and qualified.
- B. All wiring for the system shall be in accordance with Articles 760, 725, and 800 of the National Electrical Code and local electrical codes.
- C. Wiring shall be No. 14AWG Type XHHW copper type. All wiring shall be color coded. All wiring shall be tagged at each junction point. Proper connectors shall be installed at terminations to accept the No. 14 AWG wiring.
- D. Provide complete wiring and conduit between all equipment. All devices shall be mounted upon and splices made in UL listed boxes. Wiring splices and transposing or changing of colors will not be permitted. All wiring shall be installed in raceway as specified in SECTION 16130, RACEWAYS AND FITTINGS
- E. No conduit smaller than  $\frac{3}{4}$  inch shall be installed.
- F. All fire alarm raceway system including junction boxes shall be painted red.
- G. Conduit sizes and wire quantities shall be suitable for the equipment furnished. The Electrical Subcontractor shall review the proper installation of each type of device with the equipment supplier.
- H. Fire Alarm control systems and equipment shall be connected to separate dedicated branch circuits, sized as required for proper service. Circuits shall be labeled 'FIRE ALARM'.

### 3.2 FINAL TESTS / WARRANTY

- A. The system shall be fully tested by a UL certified testing company, in accordance with UL guidelines and NFPA standards. Each and every device shall be tested.
- B. A copy of the final test report and UL certificate shall be submitted indicating proper functioning of the system and conformance to the specifications. The test shall be performed by UL certified and factory-trained qualified technicians. Each and every device shall be tested, and standalone operation of remote panels shall be verified. Final testing [and UL certification] shall be performed by the same company that will hold and execute the Test and Inspection contract.
- C. The manufacturer shall guarantee all system equipment for a period of three (3) years from the date of final acceptance.
- D. The contractor shall guarantee all raceways and wiring to be free from inherent mechanical or electrical defects for one (1) year from the date of final acceptance of the system.

### 3.3 FIRE ALARM TEST AND INSPECTION CONTRACT

- A. Each contractor shall include as part of their base bid the cost of a one-year test and inspection contract. This contract shall provide for quarterly tests according to UL, NFPA and local requirements. Upon its' expiration, the contract shall be renewable by the town.

### 3.4 TRAINING

- A. The contractor shall provide the services of the manufacturer's representative for a period of 4 hours, during normal business hours, to instruct the owner's designated personnel and fire department response teams on the operation of the system.

- END OF SECTION -

**APPENDIX A**  
**GEOTECHNICAL REPORT**



Known for excellence. Built on trust.



## GEOTECHNICAL REPORT

# TAUNTON WASTE WATER TREATMENT FACILITY West Water Street Taunton, Massachusetts

November 2019

File No. 03.0034664.00



### PREPARED FOR:

BETA Group, Inc.

Lincoln, Rhode Island

### **GZA GeoEnvironmental, Inc.**

188 Valley Street, Suite 300 | Providence, RI 02909  
401-421-4140

30 Offices Nationwide  
[www.gza.com](http://www.gza.com)

Copyright© 2019 GZA GeoEnvironmental, Inc



Known for excellence.  
Built on trust.

GEOTECHNICAL  
ENVIRONMENTAL  
ECOLOGICAL  
WATER  
CONSTRUCTION  
MANAGEMENT

188 Valley Street  
Suite 300  
Providence, RI 02909  
T: 401.421.4140  
F: 401.751.8613  
www.gza.com

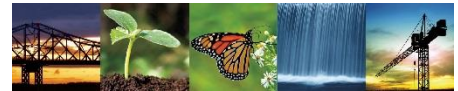

November 12, 2019  
GZA File No. 03.0034664.00

Mr. Steven Richtarik  
BETA Group, Inc.  
701 George Washington Highway  
Lincoln, Rhode Island 02865

Re: Geotechnical Report  
Taunton Waste Water Treatment Facility  
825 West Water Street  
Taunton, Massachusetts

Dear Mr. Richtarik:

GZA GeoEnvironmental, Inc. (GZA) is pleased to provide this geotechnical report for the above-referenced project. This report was prepared in accordance with our proposal dated August 26, 2019. The recommendations presented in this report are subject to the Limitations and Terms and Conditions in **Appendix A**.

## BACKGROUND

The site is the existing Taunton Waste Water Treatment Facility (WWTF), which is located at 825 West Water Street, Taunton Massachusetts 02780. **Figure 1, Locus Plan**, presents the site location.

The proposed project involves site improvements to the existing WWTF including:

1. a 12-foot diameter, 50-foot tall, lime silo;
2. a 3,350 square foot (s.f.) primary clarifier / settling tank, with the lowest piping at elevation 18.25 feet;
3. a 2,800 s.f. secondary anoxic tank, with a finish floor at elevation 10 feet;
4. a 33,000 s.f. biological treatment tank, with a finish floor at elevation 9.5 feet;
5. a 2,100 s.f., slab-on-grade, blower building;
6. two 1,500 s.f. chlorine tanks, with finish floors at elevation 3.5 feet;
7. modifications to the existing screenings building superstructure; and
8. a future 3,950 s.f. CSO storage tank.

We understand that no modifications to the screenings building foundations are proposed, and that the CSO storage tank will be constructed in a future phase of work. Geotechnical recommendations for these structures are therefore not included in this report.

Unless indicated otherwise, elevations presented in this report are referenced to the Taunton City Base datum.





## **GEOLOGIC SETTING**

The 2018 Surficial Materials Map of the Taunton Quadrangle and the 1916 Preliminary Geologic Map of Massachusetts and Rhode Island were reviewed for geologic information. A summary of the geologic conditions described on the above-mentioned maps at the site is presented in the following paragraphs.

### SURFICIAL GEOLOGY

The Surficial Materials Map indicates that the naturally deposited soils in the project area consist of granular deposits of glacial outwash. The granular deposits depicted on the western portion of the site, along with the fine-grained deposits depicted on the eastern portion of the site, were likely deposited via the meltwater of receding glaciers. The coarse-grained granular deposits are further described as poorly sorted to well sorted layers of sand and gravel. The fine-grained deposits are further described as interbedded, alternating layers of fine sands, silts, and clay.

The Surficial Materials Map indicates that five buildings located in the eastern portion of the site. Although the map is dated 2011, source information dates back to 1963.

### BEDROCK GEOLOGY

The Bedrock Geologic Map indicates the bedrock at the site is the Rhode Island formation, which consists of “black shale, sandstone, conglomerate and beds of coal.”

## **SUBSURFACE INVESTIGATIONS**

### PREVIOUS SUBSURFACE EXPLORATIONS

Test borings were drilled between 8/19/71 and 8/21/71 by American Drilling & Boring Co., Inc. Of these, the boring logs of 17 test borings, designated BH-1 through BH-17, are available. However, the test boring locations of BH-14 through BH-17 are not depicted on the “Boring Location Plan”, by CE Maguire, Inc. dated July 1974. The borings were advanced to depths ranging from 10.5 to 71.5 feet below ground surface (bgs). Split spoon samples were generally obtained at 5-foot intervals and appear to be in conformance with ASTM D-1586, the Standard Penetration Test (SPT). The test consists of driving a 1-3/8 inch inside diameter standard split spoon sampler at least 18 inches with a 140-pound hammer dropping from a height of 30 inches. The standard penetration value (N-value) is the number of blows required to drive the split spoon sampler from 6 to 18 inches of penetration and is a commonly used indicator of the relative density and consistency.

Three test borings, designated B-1 through B-3 were drilled between 2/4/2019 and 2/6/19, and were logged by BETA Group, Inc. The borings were advanced from 0 to 5 feet using an air compressor, and from 5 to 50 feet using hollow stem augers. Split spoon samples were generally obtained at 5-foot intervals.

Logs and locations of the previous explorations were provided by BETA Group, Inc. The previous boring logs are included in **Appendix B**, and their locations are shown on the attached **Figure 2, Exploration Location Plan**.

### RECENT SUBSURFACE EXPLORATIONS

Ten test borings, designated GZ-1 through GZ-10, were drilled for the proposed facility improvements. The test borings were drilled from September 23, 2019 to September 30, 2019 by Northern Drill Service Inc. of Northborough MA. The explorations were located using tape measurements from existing site features. The ground surface elevations at the test boring locations were interpolated from contours shown on the plan titled “WWTF Concept Site Plan Alt. 1.” This data should be considered



accurate to the degree implied by the method used. Logs of the recent test borings are included in **Appendix C**, and the locations are shown on the attached **Figure 2, Exploration Location Plan**.

A track-mounted drill rig was utilized to advance the borings to depths ranging from 21 to 51 feet below existing ground surface. The borings were advanced utilizing drive and wash techniques with 4-inch inside diameter flush-joint casing. Split spoon samples were generally obtained continuously or at 5-foot intervals in conformance with ASTM D-1586, the Standard Penetration Test (SPT). Groundwater monitoring wells, consisting of 2-inch PVC well screen and riser pipe, were installed in the completed test borings GZ-3 (OW), GZ-4(OW), GZ-5(OW), GZ-6(OW), GZ-7(OW) and GZ-8(OW). The borings were observed and logged by GZA personnel.

Twelve (12) soil samples were tested for grain size gradation. The results of the laboratory testing were used to confirm visual field classifications of soils and to perform hydraulic conductivity calculations. Refer to **Appendix D** for the laboratory test results.

### **GENERALIZED SUBSURFACE CONDITIONS**

The generalized subsurface profile at the site, in descending order of depth, consists of topsoil or asphalt, underlain by existing fill, glacial outwash, and bedrock. Peat was noted in boring logs BH-12 and BH-17. BH-12 is not located at one of the proposed site improvements; the location of BH-17 is unknown. Peat was not observed in the recent test borings, that were drilled at the locations of the proposed site improvements. It is noted that the site grading has changed since the 1974 test borings were drilled, and that current depths to each stratum may therefore vary. Subsurface conditions are described in greater detail below. Refer to the test boring logs in **Appendices B and C** for more specific information.

#### Asphalt

A 2-inch thick layer of asphalt was encountered at the ground surface of test boring GZ-1.

#### Topsoil

Up to one foot of topsoil was observed in the recent test borings. Up to two feet of topsoil was noted in the previous test boring logs. The topsoil generally consisted of brown, fine to medium sand with up to about 35 percent silt, and with trace amounts of gravel and roots.

#### Existing Fill

The locations and thicknesses of existing fill, presumably placed during construction in the 1970s, was estimated by comparing the topography shown on the drawing "Boring Location Plan", by CE Maguire, Inc. dated July 1974, and the topography shown on the drawing "WWTF Site Plan Alt. 1", by BETA Group, Inc. dated April 2019. Through this comparison, it is presumed that the placement of fill from 1974 through present day varies by location with thicknesses ranging from 0 to 17 feet.

Existing granular fill was observed in the recent test borings below the asphalt/topsoil. Cobbles and concrete were observed in the existing fill at some locations. An approximate 2-foot-thick layer of buried concrete was observed in test boring GZ-9 from 2 to 4 feet below ground surface. The observed concrete is assumed to be a remnant of a previous foundation. Foundation remnants may also be within the existing fill at locations other than the recent test boring locations. The fill extended to depths



ranging from 4 to 17 feet below grade. The fill generally consisted of brown, fine to coarse sand, with up to about 35 percent gravel and 35 percent silt.

Peat

A two-inch-thick peat lens was noted in boring BH-12. In boring BH-17, soft to stiff silt with peat, and trace amounts of wood were encountered from 3 to 22 feet below grade. The location and ground surface elevation of test boring BH-17 is unknown. Peat was not encountered in the recent test borings.

Naturally Deposited Glacial Outwash

The naturally deposited materials below the existing fill consist of glacial outwash. The top of the naturally deposited materials was encountered ranging from 0.5 to 22 feet below grade in the historic borings and 4 to 17 feet below grade in the recent test borings. The naturally deposited glacial outwash is medium dense to dense, brown-gray, fine to coarse sand, with varying amounts of silt and gravel. In borings BH-2, BH-4, BH-12, BH-17, GZ-5 and GZ-8 the material was interbedded with silt and clayey silt layers.

Bedrock

Bedrock was encountered below the naturally deposited materials in historic boring BH-1, at 61.5 feet below grade. The bedrock consisted of medium hard, gray, shale. Bedrock was not encountered in the recent test borings, which were advanced up to about 51 feet below grade.

Groundwater

The following table presents groundwater measurements that were taken in the wells that were installed in the completed test borings.

Test Boring	Date	Groundwater Depth (ft)	Groundwater Elevation (ft)
BH-2	8/20/1971	26	-4
GZ-3	10/11/2019	25.6	1
GZ-4	10/11/2019	17.6	1
GZ-5	10/11/2019	19.2	1
GZ-6	10/11/2019	18.6	1
GZ-7	10/11/2019	13.3	1
GZ-8	10/11/2019	10.6	1

Groundwater levels were not measured at the time of drilling in test borings because drilling fluid was introduced into the borehole. Drilling fluid can affect groundwater readings. It is anticipated that groundwater levels will vary due to variations in rainfall and other factors different than those prevailing at the time the explorations were performed, and the measurements were made.

Hydraulic Conductivity

Slug tests were performed in the monitoring wells to estimate the hydraulic conductivity of the aquifer. The tests were performed by removing a slug of water (using a bailer) and then recording the hydraulic response (well recharge rate) using a



pressure transducer and data logger. The data was evaluated using AQUESOLV software to estimate the hydraulic conductivity using the Bouwer-Rice method. The AQUESOLV data sheets are provided in **Appendix E** and a summary of the hydraulic conductivity estimates are provided in the table below.

Well ID	Hydraulic Conductivity (ft/day)
GZ-3(OW)	6
GZ-4(OW)	30
GZ-5(OW)	13
GZ-6(OW)	15
GZ-7(OW)	36
GZ-8(OW)	47

The hydraulic conductivity of the soil was also estimated using Kozeny-Carmen equation. The Kozeny-Carmen equations uses effective grain size diameter (D10) from the laboratory soil gradation tests and soil relative density from the SPT blow counts, to estimate the hydraulic conductivity of the soil. Our calculations are summarized in **Appendix F** and the hydraulic conductivity estimates are summarized in the table below.

Test Boring	Depth (ft)	Elevation (ft)	Soil Description	Hydraulic Conductivity (ft/day)
GZ-3	24 to 26	1 to 3	Gray fine to medium SAND and SILT	1
GZ-4	14 to 16	3 to 5	Gray, fine SAND, little Silt	6
GZ-5	24 to 26	-4 to -6	Gray fine to coarse SAND, and fine to coarse Gravel, trace Silt	11
GZ-6	19 to 21	-1 to 1	Brown fine to medium SAND, little Silt, trace fine Gravel	1
GZ-7	18 to 20	-4 to -6	Light brown, fine to coarse SAND, little fine Gravel, trace Silt	18
GZ-8	14 to 16	-3 to -5	Gray, fine to medium SAND, trace Silt, trace fine Gravel	31

**IMPLICATIONS OF SUBSURFACE CONDITIONS**

Subsurface conditions anticipated to impact the design and construction of the proposed structures include:

- The existing topsoil and fill are not considered suitable support for new foundations.
- An existing foundation remnant was observed in test boring GZ-9. Buried foundation/structure remnants and existing utilities are present and are not suitable for support of new foundations. The exception to this is the new lime silo, which could be constructed over the former septage tank, provided the below-described stipulations do not preclude this option.
- Excavations for foundation subgrades are up to about 20 feet below grade. Temporary support of excavation may be required to reduce the volume of excavation, to reduce the amount of pumped water during construction, and/or to support adjacent structures.



- Onsite soils have a variable and sometimes high silt content, are not anticipated to consistently meet typical gradations required for structural fill and may be difficult to reuse as on-site fill. Likewise, excavation subgrades are anticipated to be susceptible to disturbance from moisture and construction traffic.
- Construction dewatering may be necessary for deeper excavations (for the new chlorine tanks and new deeper utilities), and could yield significant volumes of water, given that the site is adjacent to the Taunton River.

The following table describes the implications of the subsurface conditions, relative to each of the proposed new structures.

Structure Details			Geotechnical Implications					
Proposed Structure	Presumed Slab Elevation (ft)	Presumed Bottom of Foundation Elevation (ft)	Thickness of Existing Fill Below Slab (ft)	Thickness of Existing Fill Below Foundation (ft)	Excavations Below Ground-water	Existing Buried Structures or Utilities	Excavation Depth to Subgrade (ft)	Difficulty of Reuse of Onsite Soils
Lime Silo	39	35	12	8	---	Structures*	4	Yes
Primary Settling Tank No. 4	18	16	5	3	---	Utilities	17	Yes
Secondary Anoxic	10	8	0	0	---	Utilities	19	Yes
Biological Treatment Tank	9.5	8	1.5	0	---	Utilities	17	Yes
Blower building	22	18	8	4	---	Structures / Utilities	4	Yes
Western Chlorine Tank	3.5	2	0	0	Within 1' of GW	Utilities	13	Yes
Eastern Chlorine Tank	3.5	2	0	0	Within 1' of GW	Utilities	10	Yes

\*Currently proposed construction is to demolish and fill in the former septage tank and construct the lime silo above the former septage tank.

## CONCLUSIONS AND RECOMMENDATIONS

The geotechnical design recommendations presented below are based on GZA’s evaluation of the available subsurface data and our understanding of the proposed development. Our recommendations are based on the International Building Code (IBC) 2015 and the Massachusetts State Building Code (MSBC) 9<sup>th</sup> Edition amendments to the 2015 IBC, and are subject to the limitations in **Appendix A**.

The following table provides recommended foundation support types for each of the proposed site improvements. The following sections of this report describe each foundation type in more detail.



<b>Proposed Structure</b>	<b>Recommended Foundation Support</b>	<b>Recommended Slab Support</b>
Lime Silo	Shallow Foundations or Drilled Micropiles	Slab-on-Grade or Pile Cap
Primary Settling Tank No. 4	Shallow Foundations, Following Overexcavation and Replacement of Existing Fill	Slab-on-Grade, Following Partial Overexcavation and Replacement of Existing Fill
Secondary Anoxic	Shallow Foundations Bearing on Glacial Outwash	Slab-On-Grade Bearing on Glacial Outwash
Biological Treatment Tank	Shallow Foundations Bearing on Glacial Outwash	Slab-On-Grade Bearing on Glacial Outwash
Blower building	Shallow Foundations, Following Overexcavation and Replacement of Existing Fill	Slab-on-Grade, Following Partial Overexcavation and Replacement of Existing Fill
New Western Chlorine Tank	Shallow Foundations Bearing on Glacial Outwash	Slab-On-Grade Bearing on Glacial Outwash
New Eastern Chlorine Tank	Shallow Foundations Bearing on Glacial Outwash	Slab-On-Grade Bearing on Glacial Outwash

SUPPORT OF LIME SILO

This section presents two alternatives for support of the new lime silo. The proposed silo will be constructed above the filled in former septage tank; the silo could be supported on shallow foundations, given the provisions below. If these provisions are not practical, given the layouts of the new silo and former septage tank, structural design loads, impacts to existing structures, environmental considerations of the former septage tank area, and economics, drilled micropiles are recommended.

Shallow Foundations

The lime silo could be supported on shallow foundations, with a slab on grade, if the following considerations are evaluated:

- Debris and liquid should be removed from within the former septage tank;
- The former septage tank should be structurally inspected for signs of deterioration and distress;
- The differences in the loading conditions should be evaluated (i.e. comparison of previous tank loads to new silo loads; the recommended allowable bearing pressure of the new silo is equal to the recommended allowable bearing pressure presented in the “Structure Foundations and Slabs” section below;
- The area of the septage tank foundation should be compared to the area of the new silo foundation. The loads imposed on the existing tank walls should be evaluated relative to tank wall capacity and contact bearing pressure exerted at base of wall
- The distribution of overturning and shear forces imposed on the remaining tank foundation should be evaluated:
- septage tank walls that underlie the new silo foundations should be removed from within 3 feet vertically of the new silo foundation and slabs;
- Holes should be drilled in the septage tank floor slab, to prevent water from accumulating below the new foundation, and;
- The area within the septage tank should be backfilled with compacted Granular Fill, up to the bottom of footing and bottom of slab base course elevations;

The design recommendations presented in the “Structure Foundations and Slabs” section below, can then be used for the design of shallow foundations and slabs-on-grade.



### Drilled Micropiles

Drilled micropiles (DMPs) are considered a high-capacity pile type that can be installed with low construction vibrations. The lime silo can be supported on a single pile cap, which in-turn bears on the micropiles. The pile cap could be designed as the floor of the silo as well.

DMPs consist of a concrete pile with a center steel rebar and an outer steel casing. Drilled micropiles are relatively small diameter piles with typical casing outside diameters of about 7 to 10 inches. DMPs should be drilled to the design depth, below the bottom of the former septage tank, with a steel casing, then grouted using tremie or pressure grouting methods. The DMP installation methods and tooling should be selected as needed to penetrate the reinforced concrete of the former septage tank floor slab. The casing should be subsequently withdrawn in part to create the micropile bond length. The casing should be left in place, to create a permanently cased section, extending to at least 2 feet below the bottom of the former septage tank slab. The required resistance is obtained by bonding of the concrete and surrounding soil (below the bottom of the former septage tank). End bearing is usually neglected in DMP design.

At this site, DMPs would be drilled through the existing fill and the filled in former septage tank, and would develop their axial resistance in the glacial outwash. It is anticipated that the micropiles can derive allowable design capacities on the order of 100 kips in compression and uplift; micropile design should consider wind loading on the silo that would result in a moment or coupled compression/tension forces on the micropiles. These capacities include a minimum factor of safety of 2.0 for compression and do not include downdrag. Based on Section 1810 of the MSBC, load testing DMPs will be required. When static load tests are performed, the IBC requires that the piles be tested to (and support) at least two times the allowable design capacity. These pile types are usually tested in tension rather than compression due to the substantially lower cost of the test setup. The tension testing is somewhat conservative for the design compression capacity; however, it also gives direct results for tension resistance in the same test.

### STRUCTURE FOUNDATIONS AND SLABS

This section provides recommendations for the remaining structure foundations (other than the lime silo, if shallow foundations are not practical).

The remaining structure foundations can be supported on conventional shallow foundations, bearing on:

1. The naturally deposited glacial outwash; or
2. Compacted structural fill overlying the glacial outwash, following the overexcavation of existing fill and buried structures / utilities.

The remaining structure slabs, can be constructed as slabs-on-grade, bearing on a minimum 8-inch thick base course of Sand-Gravel Fill, overlying:

1. The naturally deposited glacial outwash; or
2. Compacted structural fill overlying heavily surface compacted existing fill, overlying the glacial outwash, following the partial overexcavation of existing fill.

The following sections of this report provide additional details for support of shallow foundations and slabs-on-grade.



## Shallow Foundations

Subgrade preparation for spread footings should consist of the following.

1. The existing fill and buried structures / utilities (where present) should be over excavated down to the natural glacial outwash deposits.
2. These unsuitable materials should be completely removed and replaced within the footing and slab influence zones, which are defined as a slope that extends outwards and downward at a 1 horizontal to 1 vertical (1H:1V) slope from the edge of the footings and slabs.
3. The subgrades should be heavily surface compacted with at least 10 passes of a minimum 10,000 pound (minimum static weight) vibratory roller capable of at least 15,000 pounds of dynamic force. In confined areas, surface-compact with a minimum of ten passes of a heavy (700-pound) vibratory plate compactor or walk-behind vibratory roller with a static weight of at least 1,000 lbs. When near the water table, surface-compaction should be performed at the discretion of the geotechnical engineer and may need to be performed using static (non-vibratory) methods to limit disturbance of the subgrade.
4. Loose or unstable soils identified during surface compaction should be over-excavated and replaced with compacted structural fill (Granular Fill, Sand-Gravel, or Crushed Stone wrapped in filter fabric).
5. Structural Fill should then be placed in compacted lifts, up to the bottom of footing elevations.
6. Subgrades will be easily disturbed when wet and will require stabilization measures such as a mud mat or working mat of Crushed Stone. Crushed Stone placed in excess of 4 inches thick should be wrapped all-around in non-woven geotextile filter fabric.

A maximum net allowable bearing pressure of 4,000 pounds per square foot (psf) is recommended for design of footings. For footings less than three feet in width, the bearing capacity should be reduced proportionately, and in no case should continuous footings be less than 18 inches wide, nor isolated footings be less than 24 inches wide. For frost protection, exterior footings should extend at least 4 feet below final exterior grade. Interior footings should be constructed at least 18 inches below the bottom of the slab to develop sufficient bearing capacity. Total settlements of foundations constructed on subgrades prepared as recommended in this report are anticipated to be less than 1-inch and may be expected to occur during construction.

## Slabs on Grade

The slab subgrade preparation should consist of the following:

1. The existing fill (where present below slabs) should be overexcavated:
  - a. To at least 2 feet below the bottom of slab elevation; and
  - b. To within 3 feet above the natural glacial outwash deposits (i.e. 3 feet of existing fill may remain), provided that oversized (greater than 8 inches) and nested particles are removed.
2. The lateral extent of overexcavation should be as described above for shallow foundations.
3. The resulting subgrades should then be heavily surface compacted, as described above, and loose or unstable soils should be over-excavated and replaced with compacted structural fill.
4. Structural Fill should then be placed in compacted lifts, up to the bottom of base course elevation.

An 8-inch thick slab base course layer, consisting of compacted Sand & Gravel Fill should be placed directly below the floor slab. The Sand & Gravel Fill base course should be compacted to 95% of the maximum dry density as determined by ASTM D-1557 (modified Proctor test). For slab design, a subgrade modulus value of 100 pounds per cubic inch is recommended, due to the fact that existing fill will remain below many of the slabs.





## SEISMIC DESIGN

The seismic Site Class was evaluated using the average SPT resistance method as described in Chapter 20.4 of ASCE-7-10. For seismic design, we recommend Site Class D be used to evaluate the spectral response acceleration parameters. In accordance with the MSBC 9<sup>th</sup> Edition, the structure should be designed using the following seismic parameters:

$S_5 = 0.183g$	$S_{D5} = 0.195g$
$S_1 = 0.062g$	$S_{D1} = 0.099g$
$PGA = 0.098g$	$PGA_M = 0.157g$

Where:

- $S_5$  and  $S_{D5}$  are the spectral acceleration and design spectral response acceleration parameters at 0.2-second period, respectively;
- $S_1$  and  $S_{D1}$  are the spectral acceleration and design spectral response acceleration parameters at 1.0-second period, respectively; and
- $PGA$  and  $PGA_M$  are the peak ground acceleration and the maximum considered earthquake peak ground acceleration, respectively.

The soils at this site are not considered susceptible to liquefaction.

## LATERAL EARTH PRESSURES

Buried foundation walls for this site that are subject to unbalanced earth-loading conditions should be designed to resist lateral earth pressures. In accordance with Section 1610.2 of the 9<sup>th</sup> Edition of MSBC, it is recommended that the design earth pressures for fixed (braced at the top and bottom), below-grade walls be designed using an equivalent fluid pressure of 60 pounds per cubic foot (pcf). If walls are cantilevered or free to move at the top, we recommend that the design earth pressures for such below-grade walls be designed using an equivalent fluid pressure of 40 pcf.

The above values do not include hydrostatic pressure on the walls; the hydrostatic pressure, based on the design flood elevation, should be added to the equivalent fluid pressures. Alternatives to designing the walls for the full hydrostatic pressure due to the design flood, the foundation walls could be:

- Designed and constructed with pressure relieving ports. In the event that the tank structures (settling tank, anoxic tank, biologic treatment tank, and chlorine tanks) are empty – during construction or for maintenance – pressure relieving ports could be used to temporarily flood the tanks, as needed to resist buoyant uplift forces during a flood event or heavy precipitation; or
- The walls could be constructed with toe drains and free draining backfill, such that hydrostatic pressure would not act on the walls.

Where the calculated earth pressure behind the wall is less than 250 pounds per square foot (psf), it should be increased to 250 psf to account for stresses created by compaction within 5 feet of the wall. Walls should also be designed for appropriate sloping backfill, surcharge (e.g., floor loads), and to support the hydrostatic pressure along the entire height of the wall if a toe drain is not installed at the base of the wall.



Below-grade foundation walls should also be designed to resist an earthquake force  $F_w$  evaluated in accordance with Section 1610.2 of the MSBC 9<sup>th</sup> edition as follows:

$$F_w = 0.1 (S_s)(F_a)(\gamma_t)(H^2)$$

Where:

- $S_s$  is the spectral response acceleration parameters at 0.2-second period as described above;
- $F_a$  is the site coefficient from Table 1613.3.3(1) of 2015 IBC ( $F_a=1.6$  for Seismic Site Class D);
- $\gamma_t$  is the soil total unit weight ( $\gamma_t=135$  pcf for compacted Sand and Gravel fill);
- $H$  is the height of the foundation wall.

DEMOLITION OF EXISTING BELOW GRADE STRUCTURES

Demolition of below grade former structures and relocation of existing utilities (to remain in service) will be required, at locations where they conflict with the locations of the proposed construction. The remnants of existing structures, shallow foundations, and abandoned underground utilities should be demolished and completely removed from the site prior to commencing earthwork operations for new construction. Existing foundations and slabs are not suitable for support of new structures and should not be reused for proposed structures.

DRIVEWAYS AND PAVEMENT

Roadway areas should be stripped of surficial topsoil and cut to the planned subgrade elevation. Existing fill may remain in place below a depth of 3 feet below final grades, at the discretion of the geotechnical engineer based on the stability of the material under heavy surface compaction. The exposed subgrade should be heavily surface compacted, as described above, and under the observation of the Geotechnical Engineer. The excavated area should be backfilled with compacted Granular fill. Based on the anticipated subgrade conditions, we recommend the following minimum cross-sections for new bituminous pavement areas:

Pavement Layer	Flexible Pavement Layer Thickness	
	Standard Duty (Cars, Parking Lots)	Heavy Duty (Trucks, Access Roadways)
Finish Course	1-1/2 inches	1-1/2 inches
Binder Course	2-1/2 inches	3-1/2 inches
Base Course ("Sand-Gravel Fill")	6 inches	6 inches
Subbase Course ("Granular Fill")	10 inches	12 inches

FILL MATERIAL AND COMPACTION

Placement of fill and backfill should be performed in horizontal lifts and compacted with vibratory equipment to at least the degree shown in the table below, as determined by ASTM D-1557 (modified Proctor test). The maximum loose lift thickness should be 12 inches for large vibratory rollers and 6 inches for hand-operated equipment. Specifications should require that lift thicknesses be adjusted in order to attain the specified degree of compaction. When used, Crushed Stone should be placed in maximum 6-inch-thick lifts, compacted to a visually unyielding surface, and wrapped all-around in non-woven geotextile filter fabric. Backfill should not be placed over excessively wet, saturated, unstable and/or frozen soil.



Location	Degree of Compaction based on ASTM D-1557 (modified Proctor test)
Below Structures, Within Structure Foundations Backfill Limits, and in other structural applications	95 %
Bedding Under and Around Utilities	95 %
Within 3 feet of pavement surface	95 %
Below 3 feet of pavement surface	92 %
Landscaped Areas	90 %

Underground pipes and utilities should be placed on bedding in accordance with the manufacturer's specifications. Where utility trenches or other excavations are backfilled within the bearing zone of building footings (limit defined by a 1 horizontal to 1 vertical slope extending downward and outward from two feet outside the edges of the exterior footings), trench backfill material should consist of soil materials meeting the gradation requirements of "Granular Fill".

"Granular Fill" should be placed in lifts on the sides and above the utilities and compacted to at least 92% of the maximum dry density as determined in accordance with ASTM D-1557 (modified Proctor test), or to the percentage of maximum dry density as shown in the table above, whichever is more stringent. Compaction should be performed with hand-operated equipment with lift thickness depending on the size of equipment used.

Should utilities be placed below or within the influence zone of building slabs and foundations, backfill material should be compacted to at least 95% of the maximum dry density. The 95% compaction should also be carried out on the base and subbase courses, where utilities are placed below pavements.

If construction occurs during the winter months, utility trenches should be excavated and backfilled before saturated materials on the bottom of the trench can freeze. If frost develops in disturbed saturated soils, these soils may not be able to be properly compacted, and post-construction settlement of the subgrade may occur upon thawing of the frost.

All fill should be free from ice, snow, roots, sod, rubbish, and other deleterious or organic matter. Gradation requirements should meet the requirements described below. The below described fill materials should be used for the following purposes:

- Granular Fill: For use within structure and building areas, and below slab base course.
- Sand Gravel Fill: For use as slab and pavement base course, and backfill within three feet laterally of retaining walls.
- Crushed Stone: For use in bottom of excavations to aid in construction dewatering and maintaining subgrade stability during wet conditions, backfill behind walls, and in confined areas.
- Ordinary Fill: For use in landscaped areas.



Percent Finer by Weight			
Sieve Size	Sand-Gravel Fill	Granular Fill	¾-Inch Crushed Stone
*	100	100	-
1½-Inch	-	-	-
1¼-Inch	-	-	-
¾-Inch	-	-	90-100
½-Inch	50-85	-	10-50
No. 4	40-75	-	0-5
No. 10	30-60	30-95	-
No. 40	10-35	10-70	-
No. 100	5-20**	-	-
No. 200	0-8	0-10	-

\* The maximum recommended stone size is 3 inches where used as a base course below slabs and pavement; elsewhere, maximum stone sizes should be 2/3 of the loose lift thickness.

\*\* The amount passing the No. 100 sieve should be between forty percent (40%) and seventy percent (70%) of that amount passing the No. 40 sieve.

Ordinary Fill shall be free from trash, ice, snow, tree stumps, roots, organic materials, and other deleterious matter. Ordinary Fill shall contain no stone greater than two-thirds ( $\frac{2}{3}$ ) the loose lift thickness with a maximum stone size of eight (8) inches in diameter and contain no more than 30% passing the No. 200 sieve. It shall have physical properties such that it can be readily spread and compacted during filling.

Extra care should be used when compacting adjacent to foundation walls and footings. Where walls are buried on both sides, backfill and compaction should proceed on both sides of the wall so that the difference in top of fill on either side of the wall does not exceed 2 feet. Where buried walls are backfilled only on one side, only hand-operated rollers or plate compactors weighing not more than 250 pounds should be used within a lateral distance of 5 feet of walls.

**EXCAVATION SUBGRADES AND REUSE OF ONSITE MATERIALS**

Care must be taken if subgrade soils are wet so as not to cause weaving and disturbance of the subgrade during compaction. If subgrade soils are saturated, static rolling may be appropriate. If saturated soils resulting from precipitation or groundwater are encountered at subgrade elevations and cannot be compacted, the subgrade could either be left to dry to a workable moisture content and be re-compacted, or the subgrade should be replaced with suitable compacted materials, such as crushed stone wrapped in filter fabric.

The existing fill is not anticipated to meet the gradation criteria for Granular Fill or Sand-Gravel Fill due to the presence of oversized particles, foundation remnants, and a high fines content. The on-site materials may be re-used as site as structural fill (i.e. Granular Fill), provided they are culled of oversized particles, debris, and other deleterious materials, and can be compacted in stable lifts to the recommended percent of the maximum dry density. These soils will be particularly difficult to work with when wet and may require discing or harrowing to reduce the moisture content prior to compaction. Re-use of onsite soils will require careful protection of the onsite soils, planning and extra care to adjust, and maintain, moisture content to near the optimum moisture when stockpiled, and protect from wet weather with proper sloping and sealing during and following placement and compaction. It is not recommended that the on-site soils be used where free draining materials are desired, such as retaining wall backfill, pavement or slab base and subbase layers, or where Sand Gravel Fill is recommended.



If off-site disposal of soil is required, the disposal should be performed by the contractor in accordance with applicable federal, state and local regulations.

#### CONSTRUCTION DEWATERING

Groundwater was measured to within a few feet of the anticipated excavation subgrade elevations at the proposed new chlorine tank locations. Groundwater may also be encountered during excavations for the installation of deeper utilities. For excavations that extend only a few feet below groundwater, pumping from sumps should be able to manage groundwater, provided the excavation is sized appropriately for the planned pumping system. However, these excavations are in the proximity of the Taunton River, which may yield significant quantities of groundwater; this may require the use of multiple sumps and pumps, and reduced excavation sizes to limit the required dewatering volumes.

Sumps should be located outside a zone defined by 2H:1V lines extending downward and outward from foundations. Installation and operation of the contractor's dewatering system should be integrated with other earthwork operation and sequence of excavation, foundation construction, and backfilling. The Contractor may want to sequence excavations such that limited areas are open near or below the water table at any one time. To remove suspended solids, the dewatering system should also include the use of settling tanks.

The Contractor should control water seepage, precipitation, infiltration, and surface water inflow within excavations to limit disturbance to, and to maintain, the integrity of soil bearing surfaces, and to allow foundation construction in-the-dry. It is recommended that temporary control measures be implemented to reduce the amount of surface water (from rainfall runoff) from potentially entering and ponding in the excavations. Temporary measures may include, but are not limited to, construction of drainage ditches and/or berms to divert and/or reduce the amount of surface water flowing over exposed subgrades during construction.

#### PERMANENT GROUNDWATER CONTROL

Roof drain and surface water runoff should be directed away from the building / structure areas.

Damp-proofing of the structure slabs and below-grade foundation walls should be in accordance with Section 1805.2 of the 2015 IBC. Slabs and below-grade walls should also be waterproofed where they extend below the flood elevation.

#### EXCAVATION SLOPES AND TEMPORARY EARTH SUPPORT

Where space is not available to safely slope back excavations, a temporary earth support system will be required. Where deep excavations would result in an excessive volume of soil needed to slope back excavations, a temporary earth support system should be considered, as needed to reduce the volume of excavated spoils. Temporary earth support systems, if required, should be selected by the contractor and be designed by an experienced Professional Engineer registered in the Commonwealth of Massachusetts and retained by the Contractor.

The Owner and the Contractor should make themselves aware of and become familiar with applicable local, state, and federal safety regulations, including the current Occupational Safety and Health Administration (OSHA) Excavation and Trench Safety Standards. Construction site safety generally is the sole responsibility of the Contractor, who shall also be solely responsible for the means, methods, and sequencing of construction operations. We are providing this information solely as a service to our Client. Under no circumstances should the information provided herein be interpreted to mean that GZA is assuming or implying responsibility for construction site safety or the Contractor's activities; such responsibility is not being implied and should not be inferred.



The Contractor should be aware that slope height, slope inclination, or excavation depths (including utility trench excavations) should in no case exceed those specified in local, state, or federal safety regulations, e.g. OSHA Health and Safety Standards for Excavations, 29 CFR Part 1926, or successor regulations. Such regulations are strictly enforced and, if they are not followed, the Owner, Contractor, and/or earthwork and utility subcontractors could be liable for substantial penalties.

As a safety measure, it is recommended that all vehicles and soil stockpiles be kept a minimum lateral distance from the crest of the slope equal to no less than the slope height. Exposed slope faces should also be protected against the elements.

CLOSURE

We trust that this report addresses the pertinent geotechnical issues for this project at this time. Please contact Jason Ressler at 401-427-2748 or Jason.ressler@gza.com if you have any questions.

Very truly yours,

GZA GEOENVIRONMENTAL, INC.

Jason E. Ressler P.E.  
Senior Project Manager

David R. Carchedi, Ph.D., P.E.<sup>RI</sup>  
Consultant Reviewer

Russell J. Morgan, P.E.  
Senior Principal

- |              |             |  |
|--------------|-------------|--|
| Attachments: | Figure 1:   | Locus  |
|              | Figure 2:   | Exploration Location Plan  |
|              | Appendix A: | Limitations  |
|              | Appendix B: | Previous Test Boring Logs  |
|              | Appendix C: | Recent Test Boring Logs  |
|              | Appendix D: | Geotechnical Laboratory Tests                                    |
|              | Appendix E: | AQUESOLV Data Sheets   |
|              | Appendix F: | Hydraulic Conductivity Calculations Using Kozeny-Carmen equation |



## FIGURES

© 2019 - GZA GeoEnvironmental, Inc. GZA-J:\GEO\34664\ER\FIGURES\CAD\DWGS\34664.00\_F1-LOCUS.DWG FIGURE 1 LOCUS NOVEMBER 6, 2019 LISA THERIAULT

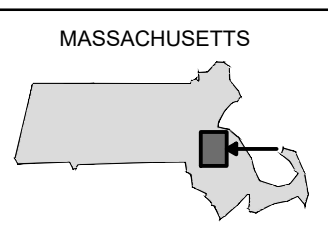
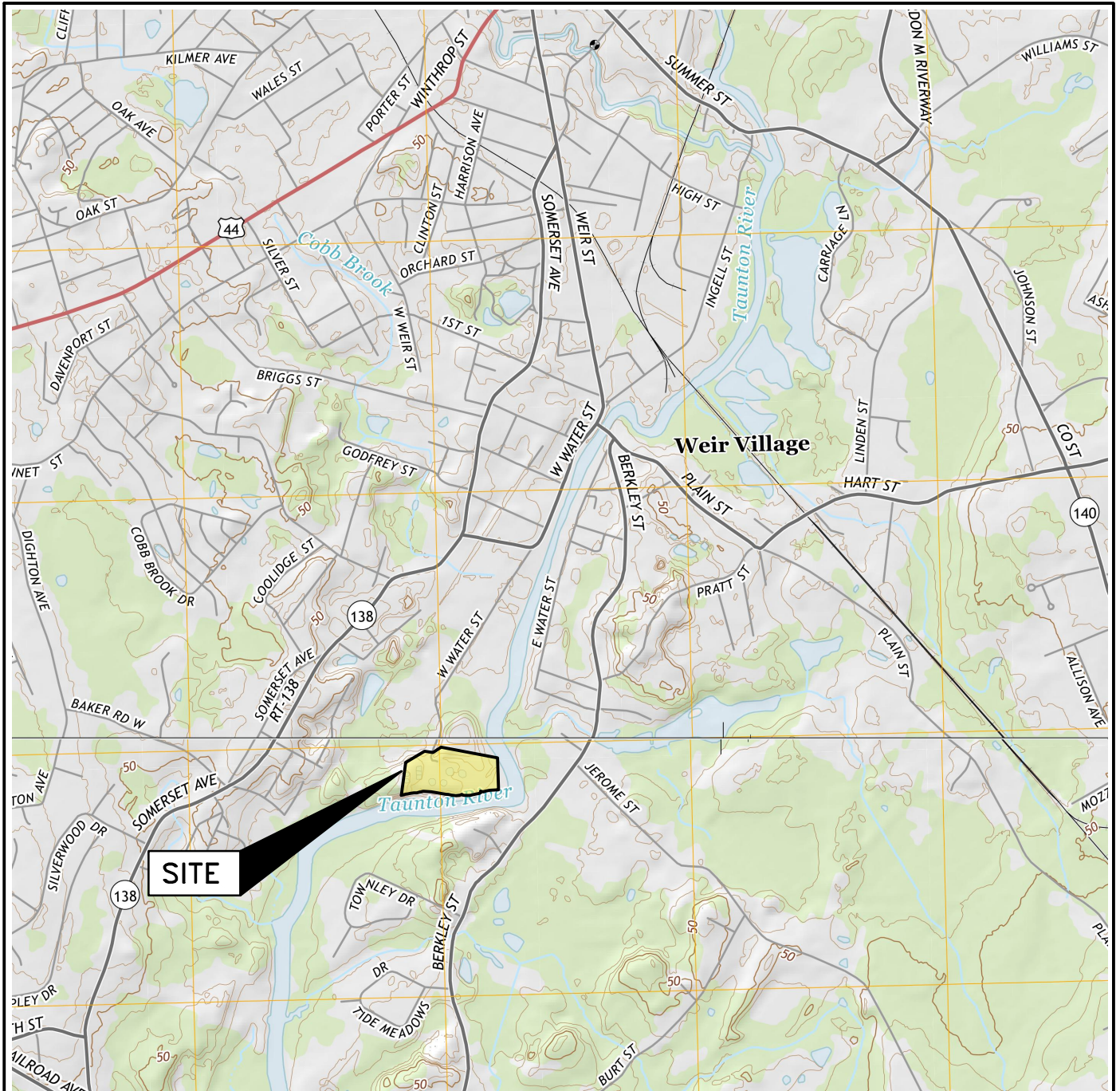

QUADRANGLE LOCATION

**SOURCE:**  
**BASE MAP FROM THE FOLLOWING USGS QUADRANGLE MAPS:**  
**TAUNTON MA. (2015) & ASSONET, MA (2015)**  
 DIGITAL TOPOGRAPHIC MAPS PROVIDED BY USGSSTORE.GOV.

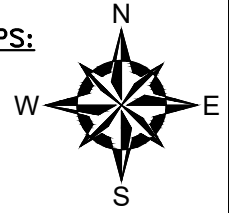

**CONTOUR ELEVATIONS REFERENCE NAVD 88,**  
**CONTOURS ARE SHOWN IN FEET AT 10' INTERVALS**

UNLESS SPECIFICALLY STATED BY WRITTEN AGREEMENT, THIS DRAWING IS THE SOLE PROPERTY OF GZA GEOENVIRONMENTAL, INC. (GZA). THE INFORMATION SHOWN ON THE DRAWING IS SOLELY FOR USE BY GZA'S CLIENT OR THE CLIENT'S DESIGNATED REPRESENTATIVE FOR THE SPECIFIC PROJECT AND LOCATION IDENTIFIED ON THE DRAWING. THE DRAWING SHALL NOT BE TRANSFERRED, REUSED, COPIED, OR ALTERED IN ANY MANNER FOR USE AT ANY OTHER LOCATION OR FOR ANY OTHER PURPOSE WITHOUT THE PRIOR WRITTEN CONSENT OF GZA. ANY TRANSFER, REUSE, OR MODIFICATION TO THE DRAWING BY THE CLIENT OR OTHERS, WITHOUT THE PRIOR WRITTEN EXPRESS CONSENT OF GZA, WILL BE AT THE USER'S SOLE RISK AND WITHOUT ANY RISK OR LIABILITY TO GZA.

**TAUNTON WASTEWATER TREATMENT FACILITY**  
**WEST WATER STREET**  
**TAUNTON, MASSACHUSETTS**

PREPARED BY:  
 **GZA** GeoEnvironmental, Inc.  
 Engineers and Scientists  
 www.gza.com

PREPARED FOR:  
 BETA GROUP, INC.

**LOCUS PLAN**

PROJ MGR: JER	REVIEWED BY: JER	CHECKED BY: HEH
DESIGNED BY: NH	DRAWN BY: CRB	SCALE: AS NOTED
DATE: NOVEMBER, 2019	PROJECT NO. 34664.00	REVISION NO. 0

**FIGURE 1**  
 SHEET NO. 1 OF 2



©2019 - GZA GeoEnvironmental, Inc. GZA-J:GEO\34664.JER\FIGURES\CAD\DWGS\34664.00\_0 - NEH.DWG FIGURE 2 - 17X11 NOVEMBER 12, 2019 LSA THERIAULT

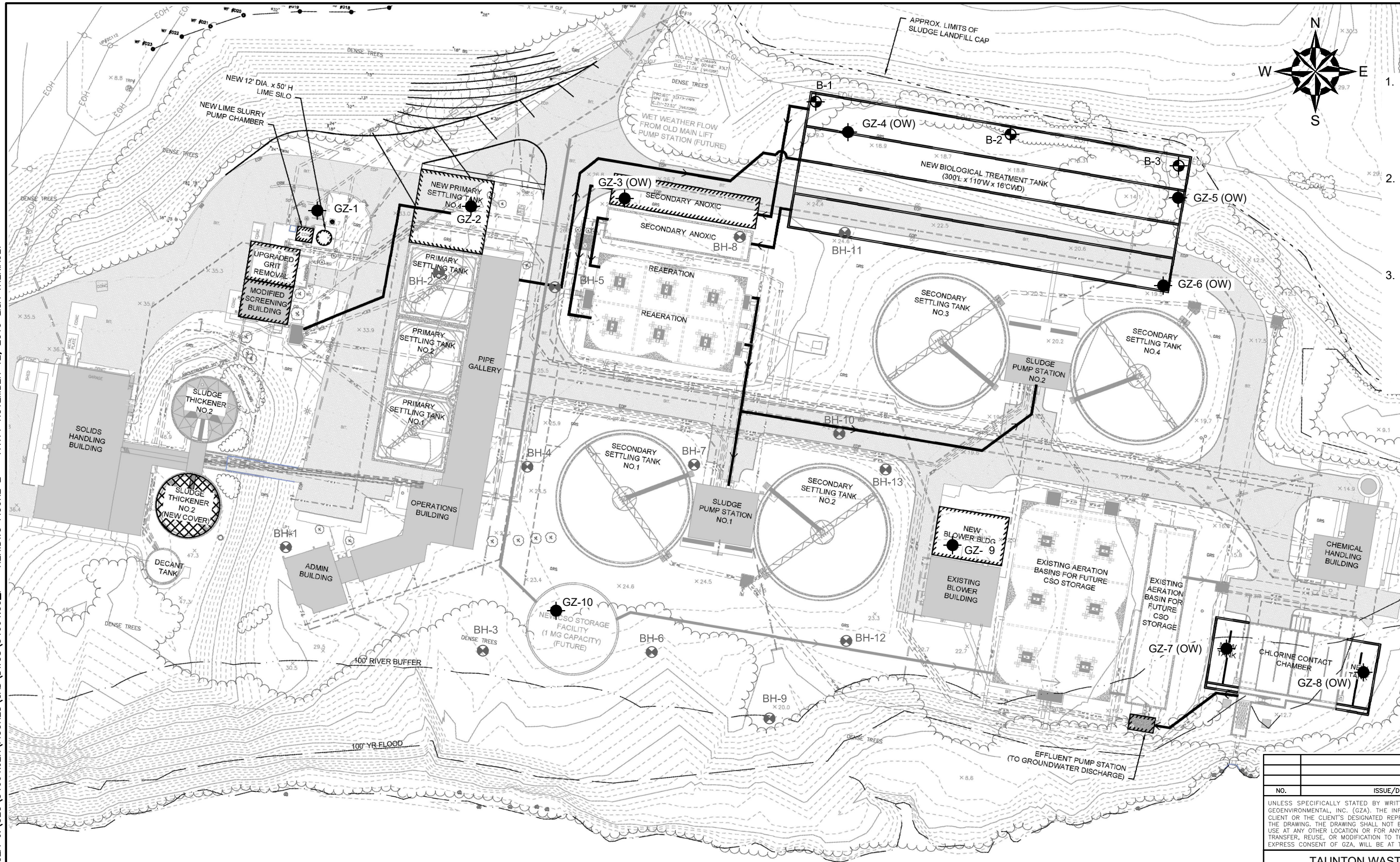

**GENERAL NOTES**

1. BASE MAP AND B-SERIES BORING LOCATIONS SUPPLIED BY BETA ENGINEERS TITLED "WWTF SITE PLAN ALT. 1", ORIGINAL SCALE 1"=40', SHEET C-1.1, DATED APRIL 10, 2019.
2. LOCATION OF EXISTING HISTORIC BORINGS (BH-SERIES) FROM CE MAGUIRE PLAN TITLED "BORING LOCATION PLAN", DRAWING NO. G-6, ORIGINAL SCALE 1"=50', DATED JULY 1974.
3. THE LOCATION OF EXPLORATIONS GZ-1 THROUGH GZ-10 WERE MEASURED BY LINE OF SIGHT AND TAPE MEASUREMENTS FROM EXISTING TOPOGRAPHIC AND MAN MADE FEATURES. DATA SHOULD BE CONSIDERED ACCURATE ONLY TO THE DEGREE IMPLIED BY THE METHOD USED.

**LEGEND**

- B-1 INDICATES BORINGS OBSERVED BY BETA GROUP, INC. FROM FEBRUARY 4, 2019 TO FEBRUARY 5, 2019.
- BH-2 INDICATES HISTORIC BORINGS DRILLED BY AMERICAN DRILLING & BORING CO., INC FROM AUGUST 19, 1971 TO AUGUST 21, 1971.
- GZ-3 INDICATES BORINGS DRILLED BY NORTHERN DRILL SERVICE FROM SEPTEMBER 23, 2019 TO SEPTEMBER 30, 2019 AND OBSERVED AND LOGGED BY GZA.

NO.	ISSUE/DESCRIPTION	BY	DATE

UNLESS SPECIFICALLY STATED BY WRITTEN AGREEMENT, THIS DRAWING IS THE SOLE PROPERTY OF GZA GEOENVIRONMENTAL, INC. (GZA). THE INFORMATION SHOWN ON THE DRAWING IS SOLELY FOR USE BY GZA'S CLIENT OR THE CLIENT'S DESIGNATED REPRESENTATIVE FOR THE SPECIFIC PROJECT AND LOCATION IDENTIFIED ON THE DRAWING. THE DRAWING SHALL NOT BE TRANSFERRED, REUSED, COPIED, OR ALTERED IN ANY MANNER FOR USE AT ANY OTHER LOCATION OR FOR ANY OTHER PURPOSE WITHOUT THE PRIOR WRITTEN CONSENT OF GZA. ANY TRANSFER, REUSE, OR MODIFICATION TO THE DRAWING BY THE CLIENT OR OTHERS, WITHOUT THE PRIOR WRITTEN EXPRESS CONSENT OF GZA, WILL BE AT THE USER'S SOLE RISK AND WITHOUT ANY RISK OR LIABILITY TO GZA.

**TAUNTON WASTEWATER TREATMENT FACILITY  
WEST WATER STREET  
TAUNTON, MASSACHUSETTS**

**EXPLORATION LOCATION PLAN**

PREPARED BY: <b>GZA</b> GeoEnvironmental, Inc. Engineers and Scientists www.gza.com	PREPARED FOR: BETA GROUP, INC.
PROJ MGR: JER DESIGNED BY: NEH DATE: NOVEMBER, 2019	REVIEWED BY: JER DRAWN BY: CRB PROJECT NO.: 34664.00
CHECKED BY: NEH SCALE: AS NOTED REVISION NO.: 0	SHEET <b>2</b> SHEET NO. 2 OF 2

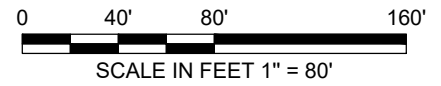

TAUNTON RIVER

TAUNTON RIVER



## **APPENDIX A**

### LIMITATIONS



## USE OF REPORT

1. GZA GeoEnvironmental, Inc. (GZA) prepared this report on behalf of, and for the exclusive use of our Client for the stated purpose(s) and location(s) identified in the Proposal for Services and/or Report. Use of this report, in whole or in part, at other locations, or for other purposes, may lead to inappropriate conclusions; and we do not accept any responsibility for the consequences of such use(s). Further, reliance by any party not expressly identified in the contract documents, for any use, without our prior written permission, shall be at that party's sole risk, and without any liability to GZA.

## STANDARD OF CARE

2. GZA's findings and conclusions are based on the work conducted as part of the Scope of Services set forth in Proposal for Services and/or Report, and reflect our professional judgment. These findings and conclusions must be considered not as scientific or engineering certainties, but rather as our professional opinions concerning the limited data gathered during the course of our work. If conditions other than those described in this report are found at the subject location(s), or the design has been altered in any way, GZA shall be so notified and afforded the opportunity to revise the report, as appropriate, to reflect the unanticipated changed conditions .
3. GZA's services were performed using the degree of skill and care ordinarily exercised by qualified professionals performing the same type of services, at the same time, under similar conditions, at the same or a similar property. No warranty, expressed or implied, is made.
4. In conducting our work, GZA relied upon certain information made available by public agencies, Client and/or others. GZA did not attempt to independently verify the accuracy or completeness of that information. Inconsistencies in this information which we have noted, if any, are discussed in the Report.

## SUBSURFACE CONDITIONS

5. The generalized soil profile(s) provided in our Report are based on widely-spaced subsurface explorations and are intended only to convey trends in subsurface conditions. The boundaries between strata are approximate and idealized, and were based on our assessment of subsurface conditions. The composition of strata, and the transitions between strata, may be more variable and more complex than indicated. For more specific information on soil conditions at a specific location refer to the exploration logs. The nature and extent of variations between these explorations may not become evident until further exploration or construction. If variations or other latent conditions then become evident, it will be necessary to reevaluate the conclusions and recommendations of this report.
6. In preparing this report, GZA relied on certain information provided by the Client, state and local officials, and other parties referenced therein which were made available to GZA at the time of our evaluation. GZA did not attempt to independently verify the accuracy or completeness of all information reviewed or received during the course of this evaluation.
7. Water level readings have been made in test holes (as described in this Report) and monitoring wells at the specified times and under the stated conditions. These data have been reviewed and interpretations have been made in this Report. Fluctuations in the level of the groundwater however occur due to temporal or spatial variations in areal recharge rates, soil heterogeneities, the presence of subsurface utilities, and/or natural or artificially induced perturbations. The water table encountered in the course of the work may differ from that indicated in the Report.
8. GZA's services did not include an assessment of the presence of oil or hazardous materials at the property. Consequently, we did not consider the potential impacts (if any) that contaminants in soil or groundwater may have on construction activities, or the use of structures on the property.



9. Recommendations for foundation drainage, waterproofing, and moisture control address the conventional geotechnical engineering aspects of seepage control. These recommendations may not preclude an environment that allows the infestation of mold or other biological pollutants.

#### **COMPLIANCE WITH CODES AND REGULATIONS**

10. We used reasonable care in identifying and interpreting applicable codes and regulations. These codes and regulations are subject to various, and possibly contradictory, interpretations. Compliance with codes and regulations by other parties is beyond our control.

#### **COST ESTIMATES**

11. Unless otherwise stated, our cost estimates are only for comparative and general planning purposes. These estimates may involve approximate quantity evaluations. Note that these quantity estimates are not intended to be sufficiently accurate to develop construction bids, or to predict the actual cost of work addressed in this Report. Further, since we have no control over either when the work will take place or the labor and material costs required to plan and execute the anticipated work, our cost estimates were made by relying on our experience, the experience of others, and other sources of readily available information. Actual costs may vary over time and could be significantly more, or less, than stated in the Report.

#### **ADDITIONAL SERVICES**

12. GZA recommends that we be retained to provide services during any future: site observations, design, implementation activities, construction and/or property development/redevelopment. This will allow us the opportunity to: i) observe conditions and compliance with our design concepts and opinions; ii) allow for changes in the event that conditions are other than anticipated; iii) provide modifications to our design; and iv) assess the consequences of changes in technologies and/or regulations.



## **APPENDIX B**

### **PREVIOUS TEST BORING LOGS**



### American Drilling & Boring Co., Inc.

100 WATER STREET EAST PROVIDENCE, R. I.

TO **C.A. Maguire & Assoc., Inc.** ADDRESS **Providence, R.I.**  
 PROJECT NAME **Sewage Treatment Plant** LOCATION **Taunton, Mass.**  
 REPORT SENT TO **above Expansion** PROJ. NO. \_\_\_\_\_  
 SAMPLES SENT TO **"** OUR JOB NO. **71-356**

SHEET 1 OF 1  
 DATE \_\_\_\_\_  
 HOLE NO. **BH-2**  
 LINE & STA. \_\_\_\_\_  
 OFFSET \_\_\_\_\_  
 SURF. ELEV. **22.3**

GROUND WATER OBSERVATIONS				Code-"AW"	CASING	SAMPLER	CORE BAR	Date		Time
At	after	Hours	START					COMPLETE		
At <b>28'</b>	after	<b>0</b>	Hours	<b>6" H.S.</b>	<b>S/S</b>	<b>1 3/8"</b>	<b>140#</b>	<b>30"</b>	<b>8/19/71</b>	<b>8/19/71</b>
At <b>26'</b> on	after		Hours							

#### LOCATION OF BORING:

DEPTH	Casing Blows per foot	Sample Depths From - To	Type of Sample	Blows per 6" on Sampler			Moisture Density or Consist.	Strata Change Elev.	SOIL IDENTIFICATION Remarks include color, gradation, Type of soil etc. Rock-color, type, condition, hardness, Drilling time, seams and etc	SAMPLE		
				From 0-6	6-12	12-18				No	Pen	Rec.
		0'-1'6"	D	2	6	7	Dry medium dense		6" TOPSOIL - brown fine SAND trace silt, trace fine gravel	1	18"	16"
		5'-6'6"	D	2	5	6	Moist medium dense	7'			2	18" 18"
10		10'-11'6"	D	6	6	10	"		Brown fine to medium SAND, trace silt & fine gravel	3	18"	16"
		15'-16'6"	D	6	8	10	"	17'			4	18" 18"
20		20'-21'6"	D	8	10	12	"		Brown fine to coarse SAND trace silt	5	18"	14"
		25'-26'6"	D	5	7	9	Wet medium dense	25'	Brown SILT, some fine sand & clay layers	6	18"	15"
30		30'-31'6"	D	6	8	12	"	31'		7	18"	12"
									Bottom of boring 31'6"			
5									Note: Installed well point at 31'			

GROUND SURFACE TO		USED		"CASING: THEN		SUMMARY:	
Sample Type	Proportions Used	140lb Wt. x 30" fall on 2" O.D. Sampler	Cohesionless Density	Cohesive Consistency	Earth Boring	Rock Coring	Samples
D=Dry C=Cored W=Washed	trace 0 to 10%	0-10 Loose	0-4 Soft	30+ Hard	31'6"		7
UP=Undisturbed Piston	little 10 to 20%	10-30 Med. Dense	4-8 M/Stiff				
TP=Test Pit A=Auger V=Vane Test	some 20 to 35%	30-50 Dense	8-15 Stiff				
UT=Undisturbed Thinwall	and 35 to 50%	50+ Very Dense	15-30 V-Stiff				

TOWN PRESS - EAST PROV.

HOLE NO. **BH-2**

### American Drilling & Boring Co., Inc.

100 WATER STREET EAST PROVIDENCE, R. I.

TO **C.A. Maguire & Assoc., Inc.** ADDRESS **Providence, R.I.**  
 PROJECT NAME **Sewage Treatment Plant** LOCATION **Taunton, Mass.**  
 REPORT SENT TO **above Expansion** PROJ. NO. \_\_\_\_\_  
 SAMPLES SENT TO **"** OUR JOB NO. **71-356**

SHEET 1 OF 1  
 DATE \_\_\_\_\_  
 HOLE NO. **BH-3**  
 LINE & STA. \_\_\_\_\_  
 OFFSET \_\_\_\_\_  
 SURF. ELEV. **26.4**

GROUND WATER OBSERVATIONS				Code-"AW"	CASING	SAMPLER	CORE BAR	Date		Time
At	after	Hours	START					COMPLETE		
At <b>None</b>	after		Hours	<b>6" H.S.</b>	<b>S/S</b>	<b>1 3/8"</b>	<b>140#</b>	<b>30"</b>	<b>8/20/71</b>	<b>8/20/71</b>
At	after		Hours							

#### LOCATION OF BORING:

DEPTH	Casing Blows per foot	Sample Depths From - To	Type of Sample	Blows per 6" on Sampler			Moisture Density or Consist.	Strata Change Elev.	SOIL IDENTIFICATION Remarks include color, gradation, Type of soil etc. Rock-color, type, condition, hardness, Drilling time, seams and etc	SAMPLE		
				From 0-6	6-12	12-18				No	Pen	Rec.
		0'-1'6"	D	2	3	4	Moist loose		4" TOPSOIL - brown fine SAND, little silt	1	18"	16"
		5'-6'6"	D	10	11	10	Moist medium dense		Gray-brown fine SAND and silt	2	18"	14"
10		10'-11'6"	D	12	12	21	Moist dense	10'	Gray-brown fine SAND, trace silt	3	18"	18"
		15'-16'6"	D	13	19	27	"			4	18"	16"
20		19'-20'6"	D	19	21	42	Moist very dense	20'6"		5	18"	17"
									Bottom of boring 20'6"			
25												

GROUND SURFACE TO		USED		"CASING: THEN		SUMMARY:	
Sample Type	Proportions Used	140lb Wt. x 30" fall on 2" O.D. Sampler	Cohesionless Density	Cohesive Consistency	Earth Boring	Rock Coring	Samples
D=Dry C=Cored W=Washed	trace 0 to 10%	0-10 Loose	0-4 Soft	30+ Hard	20'6"		5
UP=Undisturbed Piston	little 10 to 20%	10-30 Med. Dense	4-8 M/Stiff				
TP=Test Pit A=Auger V=Vane Test	some 20 to 35%	30-50 Dense	8-15 Stiff				
UT=Undisturbed Thinwall	and 35 to 50%	50+ Very Dense	15-30 V-Stiff				

TOWN PRESS - EAST PROV.

HOLE NO. **BH-3**

**American Drilling & Boring Co., Inc.**

100 WATER STREET EAST PROVIDENCE, R I

TO C.A. Maguire & Assoc., Inc. ADDRESS Providence, R.I.  
 PROJECT NAME Sewage Treatment Plant LOCATION Taunton, Mass.  
 REPORT SENT TO above Expansion PROJ NO \_\_\_\_\_  
 SAMPLES SENT TO " OUR JOB NO. 71-356

SHEET 1 OF 1  
 DATE \_\_\_\_\_  
 HOLE NO. BH-4  
 LINE & STA. \_\_\_\_\_  
 OFFSET \_\_\_\_\_  
 SURF. ELEV. 23.9

GROUND WATER OBSERVATIONS				CASING	SAMPLER	CORE BAR	Date		Time
At	None	after	Hours				START	COMPLETE	
At	None	after	Hours	<u>6" H.S.</u>	<u>S/S</u>	<u>1 3/8"</u>	<u>140#</u>	<u>30"</u>	<u>BIT</u>
				Type	Size I D	Hammer Wt	TOTAL HRS.		SOILS ENGR.
				Reeds-"AW"	Hammer Fall	BORING FOREMAN <u>Quaglinroll</u>		INSPECTOR <u>Dave Erickson</u>	

DEPTH	LOCATION OF BORING:										SAMPLE			
	Casing Blows per foot	Sample Depths From - To	Type of Sample	Blows per 6" on Sampler			Moisture Density or Consist	Strata Change Elev.	SOIL IDENTIFICATION			No	Pen	Rec
				From 0-6"	6-12"	12-18"			Remarks include color, gradation, Type of soil etc. Rack-color, type, condition, hardness, Drilling time, seams and etc					
	0'-1'6"	D	6	8	8	Dry medium dense	3'	Brown fine SAND, trace silt & fine gravel			1	18"	18"	
	5'-6'6"	D	9	9	10	Moist medium dense	8'	Gray-brown SILT, little fine sand			2	18"	15"	
10	10'-11'6"	D	8	12	13	"		Brown fine SAND, trace silt & fine gravel			3	18"	16"	
	15'-16'6"	D	17	33	40	Moist very dense	17'				4	18"	18"	
20	18'6"-20'	D	25	33	46	"	20'	Dark brown fine to coarse SAND, little fine to coarse gravel, trace silt			5	18"	14'	
								Bottom of boring 20'						

GROUND SURFACE TO		USED	"CASING: THEN		SUMMARY:	
Sample Type	Proportions Used	140lb Wt. x 30" fall on 2" O.D. Sampler	Cohesionless Density	Cohesive Consistency	Earth Boring	<u>20'</u>
D=Dry C=Cored W=Washed	trace 0 to 10%	0-10 Loose	0-4 Soft	30+ Hard	Rock Coring	<u>5</u>
UP=Undisturbed Piston	little 10 to 20%	10-30 Med. Dense	4-8 M/Stiff		Samples	<u>5</u>
TP=Test Pit A=Auger V=Vane Test	some 20 to 35%	30-50 Dense	8-15 Stiff			
UT=Undisturbed Thinwall	and 35 to 50%	50+ Very Dense	15-30 V-Stiff			
					HOLE NO. <u>BH-4</u>	

**American Drilling & Boring Co., Inc.**

100 WATER STREET EAST PROVIDENCE, R I

TO C.A. Maguire & Assoc., Inc. ADDRESS Providence, R.I.  
 PROJECT NAME Sewage Treatment Plant LOCATION Taunton, Mass.  
 REPORT SENT TO above PROJ NO \_\_\_\_\_  
 SAMPLES SENT TO " OUR JOB NO. 71-356

SHEET 1 OF 1  
 DATE \_\_\_\_\_  
 HOLE NO. BH-5  
 LINE & STA. \_\_\_\_\_  
 OFFSET \_\_\_\_\_  
 SURF. ELEV. 14.7

GROUND WATER OBSERVATIONS				CASING	SAMPLER	CORE BAR	Date		Time
At	None	after	Hours				START	COMPLETE	
At	None	after	Hours	<u>6" Auger</u>	<u>S/S</u>	<u>1 3/8"</u>	<u>140#</u>	<u>30"</u>	<u>BIT</u>
				Type	Size I D	Hammer Wt	TOTAL HRS.		SOILS ENGR.
				Reeds-"AW"	Hammer Fall	BORING FOREMAN <u>Quaglinroll</u>		INSPECTOR <u>Dave Erickson</u>	

DEPTH	LOCATION OF BORING:										SAMPLE			
	Casing Blows per foot	Sample Depths From - To	Type of Sample	Blows per 6" on Sampler			Moisture Density or Consist	Strata Change Elev.	SOIL IDENTIFICATION			No	Pen	Rec
				From 0-6"	6-12"	12-18"			Remarks include color, gradation, Type of soil etc. Rack-color, type, condition, hardness, Drilling time, seams and etc					
	0'-1'6"	D	2	2	4	Moist loose		1' TOPSOIL - brown fine to medium SAND, trace silt & fine gravel			1	18"	16"	
	5'-6'6"	D	6	6	6	Moist medium dense					2	18"	15"	
10	10'-11'6"	D	10	10	10	"					3	18"	11'	
	15'-16'6"	D	6	6	10	Wet medium dense					4	18"	18"	
20	18'6"-20'	D	11	16	18	wet dense	18'6"	red-brown fine to medium SAND, trace silt			5	18"	18"	
								Bottom of boring 20'						

GROUND SURFACE TO		USED	"CASING: THEN		SUMMARY:	
Sample Type	Proportions Used	140lb Wt. x 30" fall on 2" O.D. Sampler	Cohesionless Density	Cohesive Consistency	Earth Boring	<u>20'</u>
D=Dry C=Cored W=Washed	trace 0 to 10%	0-10 Loose	0-4 Soft	30+ Hard	Rock Coring	<u>5</u>
UP=Undisturbed Piston	little 10 to 20%	10-30 Med. Dense	4-8 M/Stiff		Samples	<u>5</u>
TP=Test Pit A=Auger V=Vane Test	some 20 to 35%	30-50 Dense	8-15 Stiff			
UT=Undisturbed Thinwall	and 35 to 50%	50+ Very Dense	15-30 V-Stiff			
					HOLE NO. <u>BH-5</u>	



# American Drilling & Boring Co., Inc.

100 WATER STREET EAST PROVIDENCE, R I

TO C.A. Maguire & Assoc., Inc. ADDRESS Providence, R.I.  
 PROJECT NAME Sewage Treatment Plant LOCATION Taunton, Mass.  
 REPORT SENT TO above Expansion PROJ. NO. \_\_\_\_\_  
 SAMPLES SENT TO " OUR JOB NO. 71-356

SHEET 1 OF 1  
 DATE \_\_\_\_\_  
 HOLE NO. BH-6  
 LINE & STA. \_\_\_\_\_  
 OFFSET \_\_\_\_\_  
 SURF. ELEV. 27.1

GROUND WATER OBSERVATIONS		Rods-"AW" Type Size I.D. Hammer Wt Hammer Fall	CASING 6" H.S. Auger	SAMPLER S/S 1 3/8" 140# 30"	CORE BAR	Date	
At <u>None</u>	after _____ Hours					START <u>8/19/71</u>	Time _____ a.m. p.m.
						COMPLETE <u>8/20/71</u>	Time _____ a.m. p.m.
						TOTAL HRS. _____	
						BORING FOREMAN <u>Quagliaroli</u>	
						INSPECTOR <u>Dave Erickson</u>	
						SOILS ENGR. _____	

### LOCATION OF BORING

DEPTH	Casing Blows per foot	Sample Depths From - To	Type of Sample	Blows per 6" on Sampler			Moisture Density or Consist	Strata Change Elev.	SOIL IDENTIFICATION Remarks include color, gradation, Type of soil etc. Rock-color, type, condition, hardness, Drilling time, seams and etc	SAMPLE		
				From 0-6	6-12	12-18				No	Pen	Rec
		0'-1'6"	D	2	3	4	Dry loose	2'	4" TOPSOIL - red-brown fine SAND & silt (root matter)	1	18"	14"
		5'-6'	D	72	101		Dry very dense	7'	Brown fine to coarse SAND, some fine to coarse gravel trace silt (cobble)	2	12"	10"
10		10'-11'6"	D	10	12	13	Moist medium dense		Gray-brown fine SAND, little silt	3	18"	14"
		15'-16'6"	D	11	14	12	"			4	18"	13"
20		20'-21'6"	D	15	15	16	"	20'	Brown F-H SAND, trace silt & fine gravel	5	18"	16"
25								21'6"	Bottom of boring 21'6"			

GROUND SURFACE TO _____	USED _____	"CASING: THEN _____	SUMMARY: Earth Boring <u>21'6"</u> Rock Coring _____ Samples <u>5</u>
Sample Type D=Dry C=Cored W=Washed UP=Undisturbed Piston TP=Test Pit A=Auger V=Vane Test UT=Undisturbed Thinwall	Proportions Used trace 0 to 10% little 10 to 20% some 20 to 35% and 35 to 50%	140 lb Wt. x 30" fall on 2" O.D. Sampler Cohesionless Density 0-10 Loose 10-30 Med. Dense 30-50 Dense 50+ Very Dense	4" O.D. Sampler Cohesive Consistency 0-4 Soft 30+ Hard 4-8 M/Stiff 8-15 Stiff 15-30 V-Stiff
TOWN PRESS - EAST PROV.			HOLE NO. <u>BH-6</u>

# American Drilling & Boring Co., Inc.

100 WATER STREET EAST PROVIDENCE, R I

TO C.A. Maguire & Assoc., Inc. ADDRESS Providence, R.I.  
 PROJECT NAME Sewage Treatment Plant LOCATION Taunton, Mass.  
 REPORT SENT TO above PROJ. NO. \_\_\_\_\_  
 SAMPLES SENT TO " OUR JOB NO. 71-356

SHEET 1 OF 1  
 DATE \_\_\_\_\_  
 HOLE NO. BH-7  
 LINE & STA. \_\_\_\_\_  
 OFFSET \_\_\_\_\_  
 SURF. ELEV. 21.1

GROUND WATER OBSERVATIONS		Rods-"AW" Type Size I.D. Hammer Wt Hammer Fall	CASING 6" Auger H.S. 1 3/8"	SAMPLER S/S 1 3/8" 140# 30"	CORE BAR	Date	
At <u>None</u>	after <u>0</u> Hours					START <u>8/23/71</u>	Time _____ a.m. p.m.
						COMPLETE <u>8/23/71</u>	Time _____ a.m. p.m.
						TOTAL HRS. _____	
						BORING FOREMAN <u>Quagliaroli</u>	
						INSPECTOR <u>Dave Erickson</u>	
						SOILS ENGR. _____	

### LOCATION OF BORING

DEPTH	Casing Blows per foot	Sample Depths From - To	Type of Sample	Blows per 6" on Sampler			Moisture Density or Consist	Strata Change Elev.	SOIL IDENTIFICATION Remarks include color, gradation, Type of soil etc. Rock-color, type, condition, hardness, Drilling time, seams and etc	SAMPLE		
				From 0-6	6-12	12-18				No	Pen	Rec
		0'-1'6"	D	2	4	6	Moist loose		Brown fine SAND, trace silt & fine gravel	1	18"	16"
		5'-6'6"	D	6	18	26	Moist dense	5'6"	Brown medium to fine SAND, some fine to coarse gravel trace silt	2	18"	15"
10		10'-11'6"	D	16	20	24	"	10'	Brown fine SAND, trace silt & fine gravel	3	18"	16"
		15'-16'6"	D	50	36	42	Moist very dense	15'	Brown fine to coarse SAND some fine to medium gravel trace silt	4	18"	17"
20		19'-20'6"	D	26	29	46	"	20'6"	Bottom of boring 20'6"	5	18"	16"
25												

GROUND SURFACE TO _____	USED _____	"CASING: THEN _____	SUMMARY: Earth Boring <u>20'6"</u> Rock Coring _____ Samples <u>5</u>
Sample Type D=Dry C=Cored W=Washed UP=Undisturbed Piston TP=Test Pit A=Auger V=Vane Test UT=Undisturbed Thinwall	Proportions Used trace 0 to 10% little 10 to 20% some 20 to 35% and 35 to 50%	140 lb Wt. x 30" fall on 2" O.D. Sampler Cohesionless Density 0-10 Loose 10-30 Med. Dense 30-50 Dense 50+ Very Dense	4" O.D. Sampler Cohesive Consistency 0-4 Soft 30+ Hard 4-8 M/Stiff 8-15 Stiff 15-30 V-Stiff
TOWN PRESS - EAST PROV.			HOLE NO. <u>BH-7</u>

# American Drilling & Boring Co., Inc.

100 WATER STREET EAST PROVIDENCE, R. I.

TO C.A. Maguire & Assoc., Inc. ADDRESS Providence, R.I.  
 PROJECT NAME Sewage Treatment Plant LOCATION Taunton, Mass.  
 REPORT SENT TO above Expansion PROJ. NO. \_\_\_\_\_  
 SAMPLES SENT TO " OUR JOB NO. 71-356

SHEET 1 OF 1  
 DATE \_\_\_\_\_  
 HOLE NO. BH-8  
 LINE & STA. \_\_\_\_\_  
 OFFSET \_\_\_\_\_  
 SURF. ELEV. 9.9

GROUND WATER OBSERVATIONS				Date		Time	
At <u>11'6"</u>	after <u>0</u> Hours	Rods-" <u>AW</u> " Type	CASING <u>6" H.S.</u>	SAMPLER <u>S/S</u>	START <u>8/19/71</u>		<u>a.m.</u>
At _____	after _____ Hours	Size I.D. <u>1 3/8"</u>	Auger	<u>140#</u>	COMPLETE <u>8/19/71</u>		<u>p.m.</u>
		Hammer Wt.		BIT	TOTAL HRS.		
		Hammer Fall			BORING FOREMAN <u>Quagliaroli</u>		
					INSPECTOR <u>Dave Erickson</u>		
					SOILS ENGR. _____		

## LOCATION OF BORING

DEPTH	Casing Blows per foot	Sample Depths From - To	Type of Sample	Blows per 6" on Sampler			Moisture Density or Consist	Strata Change Elev	SOIL IDENTIFICATION Remarks include color, gradation, Type of soil etc. Rock-color, type, condition, hardness, Drilling time, seams and etc.	SAMPLE		
				From 0-6	6-12	12-18				No	Pen	Rec
		<u>0'-1'6"</u>	<u>D</u>	<u>1</u>	<u>2</u>	<u>4</u>	<u>dry loose</u>	<u>1'6"</u>	<u>6" TOPSOIL - br. fine SAND some silt, trace root matter</u>	<u>1</u>	<u>18"</u>	<u>14"</u>
								<u>4'</u>	<u>Brown fine to medium SAND, trace fine gravel</u>			
		<u>5'-6'6"</u>	<u>D</u>	<u>5</u>	<u>5</u>	<u>8</u>	<u>Moist medium dense</u>		<u>Brown fine to medium SAND trace of silt</u>	<u>2</u>	<u>18"</u>	<u>14"</u>
10		<u>10'-11'6"</u>	<u>D</u>	<u>3</u>	<u>7</u>	<u>9</u>	<u>Wet medium dense</u>			<u>3</u>	<u>18"</u>	<u>14"</u>
								<u>14'</u>				
		<u>15'-16'6"</u>	<u>D</u>	<u>3</u>	<u>7</u>	<u>9</u>			<u>Brown fine to coarse SAND, trace silt &amp; fine gravel</u>	<u>4</u>	<u>18"</u>	<u>14"</u>
								<u>18'</u>				
20		<u>20'-21'6"</u>	<u>D</u>	<u>9</u>	<u>9</u>	<u>10</u>			<u>Brown fine SAND, little silt</u>	<u>5</u>	<u>18"</u>	<u>16"</u>
								<u>21'6"</u>	<u>Bottom of boring 21'6"</u>			

GROUND SURFACE TO		USED	CASING: THEN		SUMMARY:	
Sample Type	Proportions Used	140lb Wt. x 30" fall on 2" O.D. Sampler	Cohesionless Density	Cohesive Consistency	Earth Boring	<u>21'6"</u>
D=Dry C=Cored W=Washed	trace 0 to 10%		0-10 Loose	0-4 Soft 30+ Hard	Rock Coring	
UP=Undisturbed Piston	little 10 to 20%		10-30 Med. Dense	4-8 M/Shiff	Samples	<u>5</u>
TP=Test Pit A=Auger V=Vane Test	some 20 to 35%		30-50 Dense	8-15 Stiff		
UT=Undisturbed Thinwall	and 35 to 50%		50+ Very Dense	15-30 V-Stiff		

TOWN PRESS - EAST PROV.

# American Drilling & Boring Co., Inc.

100 WATER STREET EAST PROVIDENCE, R. I.

TO C.A. Maguire & Assoc., Inc. ADDRESS Providence, R.I.  
 PROJECT NAME Sewage Treatment Plant LOCATION Taunton, Mass.  
 REPORT SENT TO above Expansion PROJ. NO. \_\_\_\_\_  
 SAMPLES SENT TO " OUR JOB NO. 71-356

SHEET 1 OF 1  
 DATE \_\_\_\_\_  
 HOLE NO. BH-9  
 LINE & STA. \_\_\_\_\_  
 OFFSET \_\_\_\_\_  
 SURF. ELEV. 22.1

GROUND WATER OBSERVATIONS				Date		Time	
At <u>20'</u>	after <u>0</u> Hours	Rods-" <u>AW</u> " Type	CASING <u>6" Auger</u>	SAMPLER <u>S/S</u>	START <u>8/20/71</u>		<u>a.m.</u>
At _____	after _____ Hours	Size I.D. <u>1 3/8"</u>	Auger	<u>140#</u>	COMPLETE <u>8/20/71</u>		<u>p.m.</u>
		Hammer Wt.		BIT	TOTAL HRS.		
		Hammer Fall			BORING FOREMAN <u>Quagliaroli</u>		
					INSPECTOR <u>Dave Erickson</u>		
					SOILS ENGR. _____		

## LOCATION OF BORING

DEPTH	Casing Blows per foot	Sample Depths From - To	Type of Sample	Blows per 6" on Sampler			Moisture Density or Consist	Strata Change Elev	SOIL IDENTIFICATION Remarks include color, gradation, Type of soil etc. Rock-color, type, condition, hardness, Drilling time, seams and etc.	SAMPLE		
				From 0-6	6-12	12-18				No	Pen	Rec
		<u>0'-1'6"</u>	<u>D</u>	<u>2</u>	<u>3</u>	<u>4</u>	<u>Moist loose</u>	<u>1'</u>	<u>4" TOPSOIL - brown fine SAND, some silt, 1/ root matter</u>	<u>1</u>	<u>18"</u>	<u>14"</u>
		<u>5'-6'6"</u>	<u>D</u>	<u>7</u>	<u>12</u>	<u>17</u>	<u>Moist medium dense</u>		<u>Brown medium to fine SAND, trace silt &amp; fine gravel</u>	<u>2</u>	<u>18"</u>	<u>17"</u>
10		<u>10'-11'6"</u>	<u>D</u>	<u>11</u>	<u>13</u>	<u>25</u>	<u>Moist dense</u>			<u>3</u>	<u>18"</u>	<u>16"</u>
								<u>15'</u>				
		<u>15'-16'6"</u>	<u>D</u>	<u>9</u>	<u>10</u>	<u>21</u>	<u>Moist dense</u>	<u>16'</u>	<u>Brown fine SAND, little silt</u>	<u>4</u>	<u>18"</u>	<u>16"</u>
									<u>Brown coarse to fine SAND, little F-C gravel, trace silt in layers</u>			
20		<u>18'6"-20'</u>	<u>D</u>	<u>13</u>	<u>14</u>	<u>16</u>	<u>Wet dense</u>	<u>20'</u>	<u>Bottom of boring 20'</u>	<u>5</u>	<u>18"</u>	<u>16"</u>

GROUND SURFACE TO		USED	CASING: THEN		SUMMARY:	
Sample Type	Proportions Used	140lb Wt. x 30" fall on 2" O.D. Sampler	Cohesionless Density	Cohesive Consistency	Earth Boring	<u>20'</u>
D=Dry C=Cored W=Washed	trace 0 to 10%		0-10 Loose	0-4 Soft 30+ Hard	Rock Coring	
UP=Undisturbed Piston	little 10 to 20%		10-30 Med. Dense	4-8 M/Shiff	Samples	<u>5</u>
TP=Test Pit A=Auger V=Vane Test	some 20 to 35%		30-50 Dense	8-15 Stiff		
UT=Undisturbed Thinwall	and 35 to 50%		50+ Very Dense	15-30 V-Stiff		

TOWN PRESS - EAST PROV.

# American Drilling & Boring Co., Inc.

100 WATER STREET EAST PROVIDENCE, R. I.

TO C.A. Maguire & Assoc., Inc. ADDRESS Providence, R.I.  
 PROJECT NAME Sewage Treatment Plant LOCATION Taunton, Mass.  
 REPORT SENT TO above Expansion PROJ. NO. \_\_\_\_\_  
 SAMPLES SENT TO " OUR JOB NO. 71-356

SHEET 1 OF 1  
 DATE \_\_\_\_\_  
 HOLE NO. BH-10  
 LINE & STA. \_\_\_\_\_  
 OFFSET \_\_\_\_\_  
 SURF. ELEV. 21.3

GROUND WATER OBSERVATIONS			CASING	SAMPLER	CORE BAR	Date		Time
At		after				START	COMPLETE	
At <u>26'</u>		after <u>0</u> Hours	Rods-"AW" Type <u>6"Auger</u> Size I.D. <u>H/S</u> Hammer Wt <u>140#</u> Hammer Fall _____	<u>S/S</u> <u>1 3/8"</u>	_____	<u>8/20/71</u>	<u>8/20/71</u>	a.m. p.m.
At _____		after _____ Hours	_____	_____	_____	_____	_____	a.m. p.m.

BORING FOREMAN Quagliaroli  
 INSPECTOR Dave Erickson  
 SOILS ENGR. \_\_\_\_\_

### LOCATION OF BORING

DEPTH	Casing Blows per foot	Sample Depths From - To	Type of Sample	Blows per 6" on Sampler			Moisture Density or Consist.	Strata Change Elev.	SOIL IDENTIFICATION Remarks include color, gradation, Type of soil etc. Rock-color, type, condition, hardness, Drilling time, seams and etc.	SAMPLE		
				From 0-6"	6-12"	12-18"				No.	Pen	Rec.
		<u>0'-1'6"</u>	<u>D</u>	<u>5</u>	<u>6</u>	<u>8</u>	<u>Dry M.dense</u>	<u>2'6"</u>	<u>2" TOPSOIL - Brown loamy fine sand</u>	<u>1</u>	<u>18"</u>	<u>16'</u>
		<u>5'-6'6"</u>	<u>D</u>	<u>89</u>	<u>27</u>	<u>37</u>	<u>Dry very dense</u>		<u>Brown fine to coarse SAND trace fine to coarse gravel trace silt</u>	<u>2</u>	<u>18"</u>	<u>16'</u>
10		<u>10'-11'6"</u>	<u>D</u>	<u>89</u>	<u>27</u>	<u>29</u>	"			<u>3</u>	<u>18"</u>	<u>18'</u>
		<u>15'-16'6"</u>	<u>D</u>	<u>23</u>	<u>24</u>	<u>22</u>	<u>Dry dense</u>	<u>15'</u>	<u>Brown fine to coarse SAND some F-C gravel, trace silt</u>	<u>4</u>	<u>18"</u>	<u>16'</u>
20		<u>18'6"-20'</u>	<u>D</u>	<u>25</u>	<u>20</u>	<u>16</u>	<u>Wet dense</u>	<u>20'</u>		<u>5</u>	<u>18"</u>	<u>11'</u>
									<u>Bottom of boring 20'</u>			

GROUND SURFACE TO _____		USED _____		"CASING: THEN _____	
Sample Type	Proportions Used	140lb Wt. x 30" fall on 2" O.D. Sampler	Cohesionless Density	Cohesive Consistency	SUMMARY:
D=Dry C=Cored W=Washed	trace 0 to 10%	0-10 Loose	0-4 Soft	30+ Hard	Earth Boring <u>20'</u>
UP=Undisturbed Piston	little 10 to 20%	10-30 Med. Dense	4-8 M/Stiff		Rock Coring _____
TP=Test Pit A=Auger V=Vane Test	some 20 to 35%	30-50 Dense	8-15 Stiff		Samples <u>5</u>
UT=Undisturbed Thinwall	and 35 to 50%	50+ Very Dense	15-30 V-Stiff		HOLE NO. <u>BH-10</u>

TOWN PRESS - EAST PROV.

# American Drilling & Boring Co., Inc.

100 WATER STREET EAST PROVIDENCE, R. I.

TO C.A. Maguire & Assoc., Inc. ADDRESS Providence, R.I.  
 PROJECT NAME Sewage Treatment Plant LOCATION Taunton, Mass.  
 REPORT SENT TO above PROJ. NO. \_\_\_\_\_  
 SAMPLES SENT TO " OUR JOB NO. 71-356

SHEET 1 OF 1  
 DATE \_\_\_\_\_  
 HOLE NO. BH-11  
 LINE & STA. \_\_\_\_\_  
 OFFSET \_\_\_\_\_  
 SURF. ELEV. 11.1

GROUND WATER OBSERVATIONS			CASING	SAMPLER	CORE BAR	Date		Time
At		after				START	COMPLETE	
At <u>13'</u>		after <u>0</u> Hours	Rods-"AW" Type <u>6"Auger</u> Size I.D. <u>H.S.</u> Hammer Wt <u>140#</u> Hammer Fall _____	<u>S/S</u> <u>1 3/8"</u>	_____	<u>8/20/71</u>	<u>8/23/71</u>	a.m. p.m.
At _____		after _____ Hours	_____	_____	_____	_____	_____	a.m. p.m.

BORING FOREMAN Quagliaroli  
 INSPECTOR Dave Erickson  
 SOILS ENGR. \_\_\_\_\_

### LOCATION OF BORING

DEPTH	Casing Blows per foot	Sample Depths From - To	Type of Sample	Blows per 6" on Sampler			Moisture Density or Consist.	Strata Change Elev.	SOIL IDENTIFICATION Remarks include color, gradation, Type of soil etc. Rock-color, type, condition, hardness, Drilling time, seams and etc.	SAMPLE		
				From 0-6"	6-12"	12-18"				No.	Pen	Rec.
		<u>0'-1'6"</u>	<u>D</u>	<u>2</u>	<u>2</u>	<u>3</u>	<u>Moist loose</u>	<u>3'</u>	<u>3" TOPSOIL - brown fine SAND, little silt</u>	<u>1</u>	<u>18"</u>	<u>14"</u>
		<u>5'-6'6"</u>	<u>D</u>	<u>7</u>	<u>7</u>	<u>12</u>	<u>Moist medium dense</u>		<u>Gray-brown fine SAND and silt</u>	<u>2</u>	<u>18"</u>	<u>16'</u>
10		<u>10'-11'6"</u>	<u>D</u>	<u>7</u>	<u>9</u>	<u>12</u>	<u>Wet medium dense</u>	<u>10'</u>	<u>Gray fine SAND, little silt</u>	<u>3</u>	<u>18"</u>	<u>16'</u>
		<u>15'-16'6"</u>	<u>D</u>	<u>7</u>	<u>7</u>	<u>10</u>	"		<u>at 15' color brown</u>	<u>4</u>	<u>18"</u>	<u>15'</u>
20		<u>19'-20'6"</u>	<u>D</u>	<u>6</u>	<u>10</u>	<u>12</u>	"	<u>20'6"</u>		<u>5</u>	<u>18"</u>	<u>16'</u>
									<u>Bottom of boring 20'6"</u>			

GROUND SURFACE TO _____		USED _____		"CASING: THEN _____	
Sample Type	Proportions Used	140lb Wt. x 30" fall on 2" O.D. Sampler	Cohesionless Density	Cohesive Consistency	SUMMARY:
D=Dry C=Cored W=Washed	trace 0 to 10%	0-10 Loose	0-4 Soft	30+ Hard	Earth Boring <u>20'6"</u>
UP=Undisturbed Piston	little 10 to 20%	10-30 Med. Dense	4-8 M/Stiff		Rock Coring _____
TP=Test Pit A=Auger V=Vane Test	some 20 to 35%	30-50 Dense	8-15 Stiff		Samples <u>5</u>
UT=Undisturbed Thinwall	and 35 to 50%	50+ Very Dense	15-30 V-Stiff		HOLE NO. <u>BH-11</u>

TOWN PRESS - EAST PROV.

# American Drilling & Boring Co., Inc.

100 WATER STREET EAST PROVIDENCE, R. I.

SHEET 1 OF 1  
 DATE \_\_\_\_\_  
 HOLE NO. BH-12  
 LINE & STA. \_\_\_\_\_  
 OFFSET \_\_\_\_\_  
 SURF. ELEV. 22.8

TO C.A. Maguire & Assoc., Inc. ADDRESS Providence, R.I.  
 PROJECT NAME Sewage Treatment Plant LOCATION Taunton, Mass.  
 REPORT SENT TO above Expansion PROJ. NO. \_\_\_\_\_  
 SAMPLES SENT TO " OUR JOB NO. 71-356

GROUND WATER OBSERVATIONS		CASING <b>Rods-"AW"</b> Type <b>6" Auger</b> Size: D <b>H.S.</b> Hammer Wt <b>140#</b> Hammer Fall <b>30"</b>	SAMPLER <b>S/S</b> <b>1 3/8"</b> <b>140#</b> <b>30"</b>	CORE BAR _____	Date START <u>8/20/71</u> COMPLETE <u>8/20/71</u> TOTAL HRS. _____ BORING FOREMAN <u>Quagliaroli</u> INSPECTOR <u>Dave Erickson</u> SOILS ENGR. _____
At <u>19'6"</u> after <u>0</u> Hours					

DEPTH	Casing Blows per foot	Sample Depths From - To	Type of Sample	Blows per 6" on Sampler			Moisture Density or Consist.	Strata Change Elev.	SOIL IDENTIFICATION Remarks include color, gradation, Type of soil etc. Rock-color, type, condition, hardness, Drilling time, seams and etc.	SAMPLE		
				0-6"	6-12"	12-18"				No	Pen	Rec
		<u>0'-1'6"</u>	<u>D</u>	<u>2</u>	<u>4</u>	<u>5</u>	<u>Moist loose</u>	<u>10'</u>	<u>4" TOPSOIL - brown fine SAND &amp; silt, trace fine gravel</u>	<u>1</u>	<u>18"</u>	<u>14"</u>
		<u>6'6"-8'</u>	<u>D</u>	<u>7</u>	<u>10</u>	<u>11</u>	<u>Moist medium dense</u>		<u>Brown fine SAND, some silt trace fine to med. gravel</u>	<u>2</u>	<u>18"</u>	<u>15"</u>
<u>10</u>		<u>10'-11'6"</u>	<u>D</u>	<u>10</u>	<u>12</u>	<u>20</u>	<u>Moist dense</u>		<u>Brown fine SAND, trace silt &amp; fine gravel</u>	<u>3</u>	<u>18"</u>	<u>16"</u>
		<u>15'@16'6"</u>	<u>D</u>	<u>10</u>	<u>11</u>	<u>12</u>	<u>Moist medium dense</u>		<u>same except 2" peat lens</u>	<u>4</u>	<u>18"</u>	<u>16"</u>
<u>20</u>		<u>20'-21'6"</u>	<u>D</u>	<u>18</u>	<u>24</u>	<u>38</u>	<u>Wet V.dense</u>	<u>21'</u>	<u>Gray-br. silt, trace fine sand</u> <u>Bottom of boring 21'6"</u>	<u>5</u>	<u>18"</u>	<u>16"</u>

GROUND SURFACE TO _____	USED _____	"CASING: THEN _____	SUMMARY: _____
Sample Type _____	Proportions Used _____	140lb Wt. x 30" fall on 2" O.D. Sampler _____	Earth Boring <u>21'6"</u>
D=Dry C=Cored W=Washed _____	trace 0 to 10% _____	Cohesionless Density _____	Rock Coring _____
UP=Undisturbed Piston _____	little 10 to 20% _____	0-10 Loose _____	Samples <u>5</u>
TP=Test Pit A=Auger V=Vane Test _____	some 20 to 35% _____	10-30 Med. Dense _____	
UT=Undisturbed Thinwall _____	and 35 to 50% _____	30-50 Dense _____	
		50+ Very Dense _____	
		0-4 Soft _____	
		4-8 M/Stiff _____	
		8-15 Stiff _____	
		15-30 V-Stiff _____	

TOWN PRESS - EAST PROV.

# American Drilling & Boring Co., Inc.

100 WATER STREET EAST PROVIDENCE, R. I.

SHEET 1 OF 1  
 DATE \_\_\_\_\_  
 HOLE NO. BH-13  
 LINE & STA. \_\_\_\_\_  
 OFFSET \_\_\_\_\_  
 SURF. ELEV. 22.0

TO C.A. Maguire & Assoc., Inc. ADDRESS Providence, R.I.  
 PROJECT NAME Sewage Treatment Plant LOCATION Taunton, Mass.  
 REPORT SENT TO above Expansion PROJ. NO. \_\_\_\_\_  
 SAMPLES SENT TO " OUR JOB NO. 71-356

GROUND WATER OBSERVATIONS		CASING <b>Rods-"AW"</b> Type <b>6" Auger</b> Size: D <b>H.S.</b> Hammer Wt <b>140#</b> Hammer Fall <b>30"</b>	SAMPLER <b>S/S</b> <b>1 3/8"</b> <b>140#</b> <b>30"</b>	CORE BAR _____	Date START <u>8/19/71</u> COMPLETE <u>8/19/71</u> TOTAL HRS. _____ BORING FOREMAN <u>Quagliaroli</u> INSPECTOR <u>Dave Erickson</u> SOILS ENGR. _____
At <u>None</u> after <u>0</u> Hours					

DEPTH	Casing Blows per foot	Sample Depths From - To	Type of Sample	Blows per 6" on Sampler			Moisture Density or Consist.	Strata Change Elev.	SOIL IDENTIFICATION Remarks include color, gradation, Type of soil etc. Rock-color, type, condition, hardness, Drilling time, seams and etc.	SAMPLE		
				0-6"	6-12"	12-18"				No	Pen	Rec
		<u>0'-1'6"</u>	<u>D</u>	<u>2</u>	<u>6</u>	<u>14</u>	<u>Dry medium dense</u>	<u>3'6"</u>	<u>6" TOPSOIL - brown fine SAND &amp; silt, trace fine gravel</u>	<u>1</u>	<u>18"</u>	<u>14"</u>
		<u>5'-6'6"</u>	<u>D</u>	<u>26</u>	<u>54</u>	<u>72</u>	<u>Dry very dense</u>	<u>8'</u>	<u>Brown fine to coarse SAND, some fine to coarse gravel trace silt (cobble)</u>	<u>2</u>	<u>18"</u>	<u>17"</u>
<u>10</u>		<u>10'-11'6"</u>	<u>D</u>	<u>8</u>	<u>16</u>	<u>19</u>	<u>Dry dense</u>		<u>Brown fine SAND, some silt layers</u>	<u>3</u>	<u>18"</u>	<u>14"</u>
		<u>13'6"-14'6"</u>	<u>D</u>	<u>8</u>	<u>10</u>		<u>Moist M.dense</u>			<u>4</u>	<u>12"</u>	<u>10"</u>
<u>15</u>		<u>14'6"</u>	<u>D</u>	<u>30/No Pen.</u>				<u>15'</u>	<u>Refusal on spoon at 14'6" Auger To 15" Bottom of boring 15'</u>			

GROUND SURFACE TO _____	USED _____	"CASING: THEN _____	SUMMARY: _____
Sample Type _____	Proportions Used _____	140lb Wt. x 30" fall on 2" O.D. Sampler _____	Earth Boring <u>15'</u>
D=Dry C=Cored W=Washed _____	trace 0 to 10% _____	Cohesionless Density _____	Rock Coring _____
UP=Undisturbed Piston _____	little 10 to 20% _____	0-10 Loose _____	Samples <u>4</u>
TP=Test Pit A=Auger V=Vane Test _____	some 20 to 35% _____	10-30 Med. Dense _____	
UT=Undisturbed Thinwall _____	and 35 to 50% _____	30-50 Dense _____	
		50+ Very Dense _____	
		0-4 Soft _____	
		4-8 M/Stiff _____	
		8-15 Stiff _____	
		15-30 V-Stiff _____	

TOWN PRESS - EAST PROV.

### American Drilling & Boring Co., Inc.

100 WATER STREET EAST PROVIDENCE, R. I.

SHEET 1 OF 1  
 DATE \_\_\_\_\_  
 HOLE NO. BH-14  
 LINE & STA. \_\_\_\_\_  
 OFFSET \_\_\_\_\_  
 SURF. ELEV. \_\_\_\_\_

TO C.A. Maguire & Assoc., Inc. ADDRESS Providence, R.I.  
 PROJECT NAME Sewage Treatment Plant LOCATION Taunton, Mass.  
 REPORT SENT TO above PROJ. NO. \_\_\_\_\_  
 SAMPLES SENT TO " OUR JOB NO. 71-356

GROUND WATER OBSERVATIONS		RODS-"AW" Type Size: D Hammer Wt. Hammer Fall	CASING 6" Auger H/S	SAMPLER S/S 1 3/8" 140# 30"	CORE BAR BIT 30"	Date		START 8/23/71 COMPLETE 8/23/71 TOTAL HRS. BORING FOREMAN <u>Quagliaroli</u> INSPECTOR <u>Dave Erickson</u> SOILS ENGR. _____
At	after					Time	Time	
At <u>9'</u>	after <u>0</u> Hours							
At _____	after _____ Hours							

#### LOCATION OF BORING

DEPTH	Casing Blows per foot	Sample Depths From - To	Type of Sample	Blows per 6" on Sampler			Moisture Density or Consist.	Strata Change Elev.	SOIL IDENTIFICATION Remarks include color, gradation, Type of soil etc. Rock-color, type, condition, hard- ness, Drilling time, seams and etc.	SAMPLE		
				From 0-6"	6-12"	To 12-18"				No.	Pen.	Rec.
10		0'-1'6"	D	10	22	18	Dry dense	6'	Brown fine to coarse SAND little fine to coarse grave trace silt	1	18"	16"
		5'-6'6"	D	48	18	9	Moist medium dense			2	18"	18"
		9'-10'6"	D	5	6	7	"			3	18"	18"
							10'6"	Bottom of boring 10'6"				

GROUND SURFACE TO		USED	"CASING: THEN	SUMMARY:
Sample Type	Proportions Used	140lb Wt. x 30" fall on 2" O.D. Sampler	Cohesionless Density	Earth Boring <u>10'6"</u>
D=Dry C=Cored W=Washed	trace 0 to 10%	0-10 Loose	Cohesive Consistency	Rock Coring
UP=Undisturbed Piston	little 10 to 20%	10-30 Med. Dense	0-4 Soft	Samples <u>3</u>
TP=Test Pit A=Auger V=Vane Test	some 20 to 35%	30-50 Dense	4-8 M/Stiff	
UT=Undisturbed Thinwall	and 35 to 50%	50+ Very Dense	8-15 Stiff	HOLE NO. <u>BH-14</u>
			15-30 V-Stiff	

TOWN PRESS - EAST PROV.

### American Drilling & Boring Co., Inc.

100 WATER STREET EAST PROVIDENCE, R. I.

SHEET 1 OF 1  
 DATE \_\_\_\_\_  
 HOLE NO. BH-15  
 LINE & STA. \_\_\_\_\_  
 OFFSET \_\_\_\_\_  
 SURF. ELEV. \_\_\_\_\_

TO C.A. Maguire & Assoc., Inc. ADDRESS Providence, R.I.  
 PROJECT NAME Sewage Treatment Plant LOCATION Taunton, Mass.  
 REPORT SENT TO above PROJ. NO. \_\_\_\_\_  
 SAMPLES SENT TO " OUR JOB NO. 71-356

GROUND WATER OBSERVATIONS		RODS-"AW" Type Size: D Hammer Wt. Hammer Fall	CASING 6" Auger H/S	SAMPLER S/S 1 3/8" 140# 30"	CORE BAR BIT 30"	Date		START 8/23/71 COMPLETE 8/23/71 TOTAL HRS. BORING FOREMAN <u>Quagliaroli</u> INSPECTOR <u>Dave Erickson</u> SOILS ENGR. _____
At	after					Time	Time	
At <u>None</u>	after <u>0</u> Hours							
At _____	after _____ Hours							

#### LOCATION OF BORING

DEPTH	Casing Blows per foot	Sample Depths From - To	Type of Sample	Blows per 6" on Sampler			Moisture Density or Consist.	Strata Change Elev.	SOIL IDENTIFICATION Remarks include color, gradation, Type of soil etc. Rock-color, type, condition, hard- ness, Drilling time, seams and etc.	SAMPLE		
				From 0-6"	6-12"	To 12-18"				No.	Pen.	Rec.
10		0'-1'6"	D	5	5	8	Wet medium dense	3'	Brown fine SAND, trace silt	1	18"	13"
		5'-6'6"	D	6	5	6	Moist medium dense			2	18"	14"
		10'-11'6"	D	10	11	14	"			3	18"	16"
20		15'-16'6"	D	17	18	21	Moist dense	16'	Brown fine to medium SAND, trace silt & fine gravel	4	18"	15"
		19'-20'6"	D	7	7	12	Moist medium dense			5	18"	17"
							20'6"	Bottom of boring 20'6"				

GROUND SURFACE TO		USED	"CASING: THEN	SUMMARY:
Sample Type	Proportions Used	140lb Wt. x 30" fall on 2" O.D. Sampler	Cohesionless Density	Earth Boring <u>20'6"</u>
D=Dry C=Cored W=Washed	trace 0 to 10%	0-10 Loose	Cohesive Consistency	Rock Coring
UP=Undisturbed Piston	little 10 to 20%	10-30 Med. Dense	0-4 Soft	Samples <u>5</u>
TP=Test Pit A=Auger V=Vane Test	some 20 to 35%	30-50 Dense	4-8 M/Stiff	
UT=Undisturbed Thinwall	and 35 to 50%	50+ Very Dense	8-15 Stiff	HOLE NO. <u>BH-15</u>
			15-30 V-Stiff	

TOWN PRESS - EAST PROV.

### American Drilling & Boring Co., Inc.

100 WATER STREET EAST PROVIDENCE, R. I.

TO C.A. Maguire & Assoc., Inc. ADDRESS Providence, R.I.  
 PROJECT NAME Sewage Treatment Plant LOCATION Taunton, Mass.  
 REPORT SENT TO above PROJ. NO. \_\_\_\_\_  
 SAMPLES SENT TO " OUR JOB NO. 71-356

SHEET 1 OF 1  
 DATE \_\_\_\_\_  
 HOLE NO. BH-16  
 LINE & STA. \_\_\_\_\_  
 OFFSET \_\_\_\_\_  
 SURF. ELEV. \_\_\_\_\_

GROUND WATER OBSERVATIONS		Rods-"AW" Type Size I.D. Hammer Wt Hammer Fall	CASING 6" Auger M/S	SAMPLER S/S 1 3/8" 140# 30"	CORE BAR	Date Time	
At	after					START	Time
At	5'6"	after	0	Hours	START	8/23/71	a.m.
COMPLETE	8/23/71						p.m.
TOTAL HRS.							
BORING FOREMAN <u>Quagliaroli</u>							
INSPECTOR <u>Dave Erickson</u>							
SOILS ENGR. _____							

#### LOCATION OF BORING

DEPTH	Casing Blows per foot	Sample Depths From - To	Type of Sample	Blows per 6" on Sampler			Moisture Density or Consist.	Strata Change Elev.	SOIL IDENTIFICATION Remarks include color, gradation, Type of soil etc. Rock-color, type, condition, hardness, Drilling time, seams and etc.	SAMPLE		
				From 0-6"	6-12"	12-18"				No.	Pen	Rec
		0'-1'6"	D	2	3	5	Moist loose		6" TOPSOIL - brown fine SAND & silt	1	18"	16"
		5'-6'6"	D	5	6	6	Moist medium dense	5'	Gray-brown fine SAND & silt trace fine gravel	2	18"	15"
10		9'-10'6"	D	6	6	10	wet M.dense	9'6" 10'6"	Gray C-f SAND, some F-C gravel, trace silt Bottom of boring 10'6"	3	18"	16"

GROUND SURFACE TO USED		"CASING: THEN	
Sample Type	Proportions Used	140lb Wt. x 30" fall on 2" O.D. Sampler	SUMMARY:
D=Dry C=Cored W=Washed	trace 0 to 10%	Cohesionless Density	Earth Boring <u>10'6"</u>
UP=Undisturbed Piston	little 10 to 20%	0-10 Loose	Rock Coring
TP=Test Pit A=Auger V=Vane Test	some 20 to 35%	10-30 Med. Dense	Samples <u>3</u>
UT=Undisturbed Thinwall	and 35 to 50%	30-50 Dense	
		50+ Very Dense	
		0-4 Soft 30+ Hard	HOLE NO. <u>16</u>
		4-8 M/Stiff	
		8-15 Stiff	
		15-30 V-Stiff	

TOWN PRESS - EAST PROV.

### American Drilling & Boring Co., Inc.

100 WATER STREET EAST PROVIDENCE, R. I.

TO C. A. Maguire & Assoc., Inc. ADDRESS Providence, R.I.  
 PROJECT NAME Sewage Treatment Plant LOCATION Taunton, Mass.  
 REPORT SENT TO above PROJ. NO. \_\_\_\_\_  
 SAMPLES SENT TO " OUR JOB NO. 71-356

SHEET 1 OF 1  
 DATE \_\_\_\_\_  
 HOLE NO. BH-17  
 LINE & STA. \_\_\_\_\_  
 OFFSET \_\_\_\_\_  
 SURF. ELEV. \_\_\_\_\_

GROUND WATER OBSERVATIONS		Rods-"AW" Type Size I.D. Hammer Wt. Hammer Fall	CASING 6" Auger S/S H/S 1 3/8" 140# 30"	SAMPLER S/S 1 3/8" 140# 30"	CORE BAR	Date Time	
At	after					START	Time
At	8'2"	after	0	Hours	START	8/23/71	a.m.
COMPLETE	8/23/71						p.m.
TOTAL HRS.							
BORING FOREMAN <u>Quagliaroli</u>							
INSPECTOR <u>Dave Erickson</u>							
SOILS ENGR. _____							

#### LOCATION OF BORING

DEPTH	Casing Blows per foot	Sample Depths From - To	Type of Sample	Blows per 6" on Sampler			Moisture Density or Consist.	Strata Change Elev.	SOIL IDENTIFICATION Remarks include color, gradation, Type of soil etc. Rock-color, type, condition, hardness, Drilling time, seams and etc.	SAMPLE		
				From 0-6"	6-12"	12-18"				No.	Pen	Rec
		0'-1'6"	D	2	12	6	Moist medium dense		Brown fine to medium SAND, little silt, little fine to coarse gravel (6"-8" Macadam)	1	18"	14"
5		5'-6'6"	D	3	2	2	Moist soft		Gray SILT, some peat, trace of fine sand, trace of fine gravel	-	18"	0"
		6'6"-8'	D	2	2	2	"		(Note: Oil odor noted)	2	18"	10"
10		10'-11'6"	D	6	6	6	Moist stiff		Color change to Gray Brown	3	18"	15"
15		15'-16'6"	D	1	2	2	Moist soft			4	18"	14"
20		20'-21'6"	D	1	2	4	Moist medium stiff	22'	Gray brown SILT, trace of fine sand, trace of fine gravel, trace of wood	5	18"	13"
25		25'-26'6"	D	2	4	6	Wet medium dense	28'	Gray brown coarse to fine SAND, some silt, trace of fine to medium gravel	6	18"	15"
30		30'-31'6"	D	4	5	6	Wet medium dense		Gray medium to fine SAND, trace of silt	7	18"	15"
		35'-36'6"	D	7	13	15	"	36'	(Note: Spoon refusal at 39'2" - Ran Auger to 40')			
35		39'-39'2"	D	100			W/v/d	39'	At 35' Gray Clay	8	18"	16"
40								40'	Gray fine to coarse SAND, some fine to coarse gravel, trace of silt			
									Gray F-C SAND, little fine gravel, trace silt (Cemented)	9	2"	2"

GROUND SURFACE TO USED		"CASING: THEN	
Sample Type	Proportions Used	140lb Wt. x 30" fall on 2" O.D. Sampler	SUMMARY:
D=Dry C=Cored W=Washed	trace 0 to 10%	Cohesionless Density	Earth Boring <u>40'</u>
UP=Undisturbed Piston	little 10 to 20%	0-10 Loose	Rock Coring
TP=Test Pit A=Auger V=Vane Test	some 20 to 35%	10-30 Med. Dense	Samples <u>9</u>
UT=Undisturbed Thinwall	and 35 to 50%	30-50 Dense	
		50+ Very Dense	
		0-4 Soft 30+ Hard	HOLE NO. <u>BH-17</u>
		4-8 M/Stiff	
		8-15 Stiff	
		15-30 V-Stiff	

TOWN PRESS - EAST PROV.

**SOIL BORING REPORT**

PROJECT: Taunton WWTF	BORING NO. SB-1 (B-1)
LOCATION: Taunton, MA	PAGE 1 OF 2
DRILLING CO: TDS	DATE STARTED: 2/4/2019
EQUIPMENT: Air Compressor/Hollow Stem Auger	DATE FINISHED: 2/4/2019
DRILLED BY: Donnie + Chris	SURFACE ELEVATION: unknown
INSPECTED BY: Scott Nee	

<b>GROUNDWATER OBSERVATIONS</b>		CASING	SAMPLER	CORE BARREL
NOT ENCOUNTERED: _____		TYPE: _____	SIZE ID: _____	HAMMER WT: _____
DEPTH: -13'	STABILIZATION TIME: _____	HAMMER FALL: _____		

**SAMPLE DATA**

DEPTH (ft)	SAMPLING DEPTH FROM - TO	HAMMER BLOWS ON SAMPLER (inches)				STRATA CHANGE (ft)	LITHOLOGY (Description of materials)	SAMPLE ID	PEN/RECOV (in./in.)	HNU (ppm.) Lamp 10.6 eV.
		0-6	6-12	12-18	18-24					
5.0							Air compressor used to clear to 5' to minimize potential risk of encountering landfill cap. Landfill cap or any other blockages not encountered. Use of air compressor results in inexact lithographic profiling, though all sediment observed in this interval was a tan poorly graded, fine grained sand (SP).			
	6-8	5	5	5	4		tan fine grained sand, moist (SP)		24/14	
	8-10	5	5	5	9		tan fine grained sand, moist (SP)		24/16	
10.0	10-12	4	6	6	6		tan silty sand, moist (SM)		24/20	
15.0	15-17	2	2	3	2		tan silty sand, wet (SM)		24/13	
20.0	20-22	3	5	5	7		16" tan silty sand, wet (SM) 8" tan coarse grained sand w/gravel, wet (SW)		24/24	
25.0	25-27	2	2	9	10		tan/gray coarse grained sand w/gravel, wet (SW)		24/24	

Notes:

**SOIL BORING REPORT**

PROJECT: Taunton WWTF  
 LOCATION: Taunton, MA  
 DRILLING CO: TDS  
 EQUIPMENT: Air Compressor/Hollow Stem Auger  
 DRILLED BY: Donnie + Chris  
 INSPECTED BY: Scott Nee

BORING NO. SB-1 (B-1)  
 PAGE 2 OF 2  
 DATE STARTED: 2/4/2019  
 DATE FINISHED: 2/4/2019  
 SURFACE ELEVATION: unknown

**GROUNDWATER OBSERVATIONS**

NOT ENCOUNTERED: \_\_\_\_\_  
 DEPTH | STABILIZATION TIME  
 ~13' | \_\_\_\_\_

CASING SAMPLER CORE BARREL  
 TYPE: \_\_\_\_\_  
 SIZE ID: \_\_\_\_\_  
 HAMMER WT: \_\_\_\_\_  
 HAMMER FALL: \_\_\_\_\_

**SAMPLE DATA**

DEPTH (ft)	SAMPLING DEPTH FROM - TO	HAMMER BLOWS ON SAMPLER (inches)				STRATA CHANGE (ft)	LITHOLOGY (Description of materials)	SAMPLE ID	PEN/RECOV (in./in.)	HNU (ppm) Lamp 10.6 eV.
		0-6	6-12	12-18	18-24					
30.0	30-32						gray coarse grained sand w/gravel, wet (SW)		24/24	
35.0	33-35						poorly graded gravel w/gray coarse grained sand (GP)		24/5	
40.0	38-40						well graded gravel w/red coarse grained sand, wet (GW)		24/6	
45.0	43-45						well graded gravel, wet (GW)		24/2	
50.0	48-50						well graded gravel, wet (GW)		24/1	

Notes:



**SOIL BORING REPORT**

PROJECT: Taunton WWTF  
 LOCATION: Taunton, MA  
 DRILLING CO: TDS  
 EQUIPMENT: Air Compressor/Hollow Stem Auger  
 DRILLED BY: Donnie + Chris  
 INSPECTED BY: Scott Nee

BORING NO. SB-2 (B-2)  
 PAGE 1 OF 2  
 DATE STARTED: 2/5/2019  
 DATE FINISHED: 2/5/2019  
 SURFACE ELEVATION: unknown

**GROUNDWATER OBSERVATIONS**

NOT ENCOUNTERED: \_\_\_\_\_  
 DEPTH | STABILIZATION TIME  
 ~13' | \_\_\_\_\_

CASING SAMPLER CORE BARREL

TYPE: \_\_\_\_\_  
 SIZE ID: \_\_\_\_\_  
 HAMMER WT: \_\_\_\_\_  
 HAMMER FALL: \_\_\_\_\_

**SAMPLE DATA**

DEPTH (ft)	SAMPLING DEPTH FROM - TO	HAMMER BLOWS ON SAMPLER (inches)				STRATA CHANGE (ft)	LITHOLOGY (Description of materials)	SAMPLE ID	PEN/RECOV (in./in.)	HNU (ppm.) Lamp 10.6 eV.
		0-6	6-12	12-18	18-24					
5.0							Air compressor used to clear to 5' to minimize potential risk of encountering landfill cap. Landfill cap or any other blockages not encountered. Use of air compressor results in inexact lithographic profiling, though all sediment observed in this interval was a tan poorly graded, fine grained sand (SP).			
	6-8	2	7	8	11		tan silty sand, moist (SM)		24/14	
	8-10	10	13	14	17		tan silty sand, moist (SM)		24/18	
10.0	10-12	5	10	14	19		tan silty sand, moist (SM)		24/16	
15.0	15-17	4	6	10	14		tan silty sand w/gravel, wet (SW)		24/18	
20.0	20-22	4	3	4	7		tan coarse grained sand w/gravel and silts, wet (SW)		24/24	
25.0	25-27	2	12	17	23		brown coarse grained sand w/gravel, wet (SW)		24/24	

Notes:

**SOIL BORING REPORT**

PROJECT: Taunton WWTF  
 LOCATION: Taunton, MA  
 DRILLING CO: TDS  
 EQUIPMENT: Air Compressor/Hollow Stem Auger  
 DRILLED BY: Donnie + Chris  
 INSPECTED BY: Scott Nee

BORING NO. SB-2 (B-2)  
 PAGE 2 OF 2  
 DATE STARTED: 2/5/2019  
 DATE FINISHED: 2/5/2019  
 SURFACE ELEVATION: unknown

**GROUNDWATER OBSERVATIONS**

NOT ENCOUNTERED: \_\_\_\_\_  
 DEPTH | STABILIZATION TIME  
 ~13' | \_\_\_\_\_

CASING SAMPLER CORE BARREL  
 TYPE: \_\_\_\_\_  
 SIZE ID: \_\_\_\_\_  
 HAMMER WT: \_\_\_\_\_  
 HAMMER FALL: \_\_\_\_\_

**SAMPLE DATA**

DEPTH (ft)	SAMPLING DEPTH FROM - TO	HAMMER BLOWS ON SAMPLER (inches)				STRATA CHANGE (ft)	LITHOLOGY (Description of materials)	SAMPLE ID	PEN/ RECOV (in./in.)	HNU (ppm) Lamp 10.6 eV.
		0-6	6-12	12-18	18-24					
30.0	28-30	32	33	41	30	red well graded gravel, wet (GW)		24/14		
35.0	33-35	15	30	40	45	red/gray well graded gravel w/coarse grained sand, wet (GW)		24/15		
40.0	38-40	9	12	14	14	black coarse grained sand w/gravel, wet (SP)		24/10		
45.0	43-45	10	12	14	17	black coarse grained sand w/gravel, wet (SP)		24/12		
50.0	48-50	11	12	15	15	black coarse grained sand w/gravel, wet (SP)		24/9		

Notes:

**SOIL BORING REPORT**

PROJECT: Taunton WWTF  
 LOCATION: Taunton, MA  
 DRILLING CO: TDS  
 EQUIPMENT: Air Compressor/Hollow Stem Auger  
 DRILLED BY: Donnie + Chris  
 INSPECTED BY: Scott Nee

BORING NO. SB-3 (B-3)  
 PAGE 1 OF 2  
 DATE STARTED: 2/5/2019  
 DATE FINISHED: 2/6/2019  
 SURFACE ELEVATION: unknown

**GROUNDWATER OBSERVATIONS**

NOT ENCOUNTERED: \_\_\_\_\_  
 DEPTH | STABILIZATION TIME  
 -5' | \_\_\_\_\_

CASING SAMPLER CORE BARREL

TYPE: \_\_\_\_\_  
 SIZE ID: \_\_\_\_\_  
 HAMMER WT: \_\_\_\_\_  
 HAMMER FALL: \_\_\_\_\_

**SAMPLE DATA**

DEPTH (ft)	SAMPLING DEPTH FROM - TO	HAMMER BLOWS ON SAMPLER (inches)				STRATA CHANGE (ft)	LITHOLOGY (Description of materials)	SAMPLE ID	PEN/RECOV (in./in.)	HNU (ppm.) Lamp 10.6 eV.
		0-6	6-12	12-18	18-24					
5.0						▽ —	Air compressor used to clear to 5' to minimize potential risk of encountering landfill cap. Landfill cap or any other blockages not encountered. Use of air compressor results in inexact lithographic profiling, though all sediment observed in this interval was a tan silty sand (SM).			
	6-8	12	17	21	17		brown fine grained sand w/organics, wet (SP)		24/3	
	8-10	21	18	18	21		brown silty sand w/organics, wet (SM)		24/10	
10.0	10-12	15	16	18	18		brown silty sand w/organics, wet (SM)		24/2	
15.0	15-17	3	4	5	7		gray fine grained sand w/silts, wet (SP)		24/18	
20.0	20-22	13	18	21	26	14" black coarse grained sand w/silts, wet (SP) 4" gray well graded gravel w/sand, wet (GW) 6" brown coarse grained sand w/gravel, wet (SW)		24/24		
25.0	25-27	7	6	8	11	brown coarse grained sand w/gravel, wet (SW)		24/8		

Notes: Boring completed after multiple days of abnormally high temperatures, heavy melting observed in near surficial soils across site. 0-25' completed on 2/5/2019, 25-50' completed on 2/6/2019.

**SOIL BORING REPORT**

PROJECT: Taunton WWTF  
 LOCATION: Taunton, MA  
 DRILLING CO: TDS  
 EQUIPMENT: Air Compressor/Hollow Stem Auger  
 DRILLED BY: Donnie + Chris  
 INSPECTED BY: Scott Nee

BORING NO. SB-3 (B-3)  
 PAGE 2 OF 2  
 DATE STARTED: 2/5/2019  
 DATE FINISHED: 2/6/2019  
 SURFACE ELEVATION: unknown

**GROUNDWATER OBSERVATIONS**

NOT ENCOUNTERED: \_\_\_\_\_  
 DEPTH | STABILIZATION TIME  
 -5' | \_\_\_\_\_

CASING SAMPLER CORE BARREL

TYPE: \_\_\_\_\_  
 SIZE ID: \_\_\_\_\_  
 HAMMER WT: \_\_\_\_\_  
 HAMMER FALL: \_\_\_\_\_

**SAMPLE DATA**

DEPTH (ft)	SAMPLING DEPTH FROM - TO	HAMMER BLOWS ON SAMPLER (inches)				STRATA CHANGE (ft)	LITHOLOGY (Description of materials)	SAMPLE ID	PEN/RECOV (in./in.)	HNU (ppm) Lamp 10.6 eV.
		0-6	6-12	12-18	18-24					
30.0	28-30	9	10	13	12		gray coarse grained sand, wet (SP)		24/9	
35.0	33-35	13	16	19	17		gray sandy silts, wet (ML)		24/20	
40.0	38-40	5	10	13	17		gray sandy silts, wet (ML)		24/15	
45.0	43-45	14	18	21	22		gray coarse grained sand w/silts, wet (SM)		24/18	
50.0	48-50	11	17	20	30		black coarse grained sand w/silts, wet (SM)		24/14	

Notes: Boring completed after multiple days of abnormally high temperatures, heavy melting observed in near surficial soils across site. 0-25' completed on 2/5/2019, 25-50' completed on 2/6/2019.



## **APPENDIX C**

### **RECENT TEST BORING LOGS**

### TEST BORING LOG



**GZA**  
**GeoEnvironmental, Inc.**  
*Engineers and Scientists*

Beta Group, Inc.  
Taunton Waste Water Treatment Facility  
West Water Street  
Taunton, Massachusetts

EXPLORATION NO.: GZ-1  
SHEET: 1 of 1  
PROJECT NO: 03.34664.00  
REVIEWED BY: JER

**Logged By:** Ian Dakers  
**Drilling Co.:** Northern Drill Service Inc  
**Foreman:** Tim Tucker

**Type of Rig:** ATV  
**Rig Model:** B-48  
**Drilling Method:**  
Drive&Wash

**Boring Location:** See Plan  
**Ground Surface Elev. (ft.):** 39  
**Final Boring Depth (ft.):** 21  
**Date Start - Finish:** 9/27/2019 - 9/27/2019

**H. Datum:** N/A  
**V. Datum:** Taunton  
City Base

**Hammer Type:** Automatic Hammer  
**Hammer Weight (lb.):** 140  
**Hammer Fall (in.):** 30  
**Auger or Casing O.D./I.D Dia (in.):** 4.5"/4"

**Sampler Type:** SS  
**Sampler O.D. (in.):** 2.0  
**Sampler Length (in.):** 24  
**Rock Core Size:** N/A

#### Groundwater Depth (ft.)

Date	Time	Stab. Time	Water	Casing
Not Measured				

Depth (ft)	Casing Blows/ (Core Rate)	Sample					SPT Value	Sample Description Modified Burmister	Remark	Field Test Data	Stratum Description Elev. (ft.)	Equipment Installed
		No.	Depth (ft.)	Pen. (in)	Rec. (in)	Blows (RQD)						
5		S1	0.0-1.5	18	10	4 8 5	12	S1: Medium dense, brown, fine to coarse SAND and GRAVEL, trace Silt, moist	1	38.8	No Equipment Installed	
		S2	2.0-4.0	24	9	3 2 3 5	5					S2: Loose, brown with orange staining, fine to medium SAND, some Silt, moist
		S3	4.0-6.0	24	11	4 4 5 7	9	S3: Loose, brown, fine to medium SAND, some Silt, moist				
		S4	9.0-11.0	24	9	2 3 3 3	6	S4: Loose, brown-grey, fine to coarse SAND, little Silt, moist				
		S5	14.0-16.0	24	10	2 6 7 10	13	S5: Medium dense, brown-grey, fine to coarse SAND, trace fine Gravel, little Silt, moist				
		S6	19.0-21.0	24	11	7 12 15 20	27	S6: Medium dense, brown-grey, fine SAND, some Silt, moist				
							End of exploration at 21 feet.	2				

**REMARKS**  
1 - Driller excavated from 0' to 0.5' below ground surface (bgs) prior to driving sample S1. A two inch layer of asphalt was observed at the ground surface.

2 - End of exploration at 21' bgs. Boring backfilled with drill cuttings.  
- Drilling fluid introduced into borehole. Groundwater therefore not measured.

See Log Key for exploration of sample description and identification procedures. Stratification lines represent approximate boundaries between soil and bedrock types. Actual transitions may be gradual. Water level readings have been made at the times and under the conditions stated. Fluctuations of groundwater may occur due to other factors than those present at the times the measurements were made.

**Exploration No.:**  
**GZ-1**

### TEST BORING LOG



**GZA**  
**GeoEnvironmental, Inc.**  
*Engineers and Scientists*

**Beta Group, Inc.**  
**Taunton Waste Water Treatment Facility**  
**West Water Street**  
**Taunton, Massachusetts**

**EXPLORATION NO.: GZ-2**  
**SHEET: 1 of 1**  
**PROJECT NO: 03.34664.00**  
**REVIEWED BY: JER**

**Logged By:** Ian Dakers  
**Drilling Co.:** Northern Drill Service Inc  
**Foreman:** Tim Tucker

**Type of Rig:** ATV  
**Rig Model:** B-48  
**Drilling Method:**  
Drive&Wash

**Boring Location:** See Plan  
**Ground Surface Elev. (ft.):** 30  
**Final Boring Depth (ft.):** 31  
**Date Start - Finish:** 9/27/2019 - 9/27/2019

**H. Datum:** N/A  
**V. Datum:** Taunton City Base

**Hammer Type:** Automatic Hammer  
**Hammer Weight (lb.):** 140  
**Hammer Fall (in.):** 30  
**Auger or Casing O.D./I.D Dia (in.):** 4.5"/4"

**Sampler Type:** SS  
**Sampler O.D. (in.):** 2.0  
**Sampler Length (in.):** 24  
**Rock Core Size:** N/A

**Groundwater Depth (ft.)**

Date	Time	Stab. Time	Water	Casing
Not Measured				

Depth (ft)	Casing Blows/ (Core Rate)	Sample					SPT Value	Sample Description Modified Burmister	Remark	Field Test Data	Stratum		Equipment Installed	
		No.	Depth (ft.)	Pen. (in)	Rec. (in)	Blows (RQD)					Depth (ft.)	Description Elev. (ft.)		
5		S1	0.0-2.0	24	21	2 6 9 10	15	S1: A (Top 10"): Brown, fine to medium SAND, little Silt, trace Root Fibers, moist			1	TOPSOIL	No Equipment Installed	
		S2	2.0-4.0	24	20	8 14 10 11	24		B (Bottom 11"): Brown-grey, fine to medium SAND, little Silt, moist					
		S3	4.0-6.0	24	12	3 4 3 3	7	S2: Medium dense, brown/grey, fine to medium SAND, trace Silt, moist S3: Loose, brown-grey, fine to medium SAND, little Silt, moist				FILL		
		S4	9.0-11.0	24	12	1 1 1 1	2	S4: Very loose, brown, fine to medium SAND, little Silt, trace Roots, moist			11	19.0		
		S5	11.0-13.0	24	9	3 5 4 5	9	S5: Loose, brown-grey, fine to medium SAND, trace Silt, moist						POSSIBLE FILL
		S6	14.0-16.0	24	7	4 4 4 4	8	S6: Loose, grey, fine to medium SAND, little fine Gravel, trace Silt, moist			17	13.0		
		S7	19.0-21.0	24	8	4 5 7 9	12	S7: Medium dense, grey, fine to coarse SAND, trace Silt, wet						GLACIAL OUTWASH
		S8	24.0-26.0	24	9	6 8 11 10	19	S8: Medium dense, grey, fine to medium SAND, little Silt, wet						
		S9	29.0-31.0	24	0	5 5 5 6	10	S9: NO RECOVERY A (3" Spoon): Grey, fine to medium SAND, some Silt, wet	1		31	-1.0		
							End of exploration at 31 feet.	2						

**REMARKS**  
1 - No recovery on sample S9. Initial sample interval resampled with 3" split spoon sampler as sample S9A.  
2 - End of exploration at 31' below ground surface. Boring backfilled with drill cuttings.  
- Drilling fluid introduced into borehole. Groundwater therefore not measured.

See Log Key for exploration of sample description and identification procedures. Stratification lines represent approximate boundaries between soil and bedrock types. Actual transitions may be gradual. Water level readings have been made at the times and under the conditions stated. Fluctuations of groundwater may occur due to other factors than those present at the times the measurements were made.

**Exploration No.:**  
**GZ-2**

**TEST BORING LOG**



**GZA**  
**GeoEnvironmental, Inc.**  
*Engineers and Scientists*

**Beta Group, Inc.**  
**Taunton Waste Water Treatment Facility**  
**West Water Street**  
**Taunton, Massachusetts**

**EXPLORATION NO.:** GZ-3  
**SHEET:** 1 of 2  
**PROJECT NO:** 03.34664.00  
**REVIEWED BY:** JER

**Logged By:** Ian Dakers  
**Drilling Co.:** Northern Drill Service Inc  
**Foreman:** Tim Tucker

**Type of Rig:** ATV  
**Rig Model:** B-48  
**Drilling Method:**  
Drive&Wash

**Boring Location:** See Plan  
**Ground Surface Elev. (ft.):** 27  
**Final Boring Depth (ft.):** 41  
**Date Start - Finish:** 9/30/2019 - 9/30/2019

**H. Datum:** N/A  
**V. Datum:** Taunton City Base

**Hammer Type:** Automatic Hammer  
**Hammer Weight (lb.):** 140  
**Hammer Fall (in.):** 30  
**Auger or Casing O.D./I.D Dia (in.):** 4.5"/4"

**Sampler Type:** SS  
**Sampler O.D. (in.):** 2.0  
**Sampler Length (in.):** 24  
**Rock Core Size:** N/A

**Groundwater Depth (ft.)**

Date	Time	Stab. Time	Water	Casing
10/11/19	1700	11 Days	25.6	Well

Depth (ft)	Casing Blows/ (Core Rate)	Sample					SPT Value	Sample Description Modified Burmister	Remark	Field Test Data	Stratum Description Elev. (ft.)	Equipment Installed
		No.	Depth (ft.)	Pen. (in)	Rec. (in)	Blows (RQD)						
5		S1	0.0-2.0	24	22	2 9 20 19	29	S1: A (Top 5"): Brown, fine to medium SAND, little Silt, moist B (Bottom 17"): Brown, fine to medium SAND, some fine to coarse Gravel, trace Silt, moist			0.5 --- TOPSOIL --- 26.5	Solid Riser Pipe Bentonite
		S2	2.0-4.0	24	22	14 17 22 20	39	S2: Dense, brown, fine to medium SAND, little fine to coarse Gravel, trace Silt, moist				
		S3	4.0-6.0	24	14	14 16 16 20	32	S3: Dense, brown, fine to medium SAND, little fine to coarse Gravel, trace Silt, moist			FILL	
10		S4	9.0-11.0	24	5	5 4 3 2	7	S4: Loose, brown-grey, fine to coarse SAND, little Silt, wet	1		12 --- 15.0	
15		S5	14.0-16.0	24	0	6 7 10 10	17	S5: NO RECOVERY A (3" Spoon): Brown, fine to coarse SAND and GRAVEL, little Silt, wet	2			
20		S6	19.0-21.0	24	9	6 10 11 12	21	S6: Medium dense, brown-grey, fine to coarse SAND, trace fine Gravel, little Silt, wet			GLACIAL OUTWASH	Filter Sand
25		S7	24.0-26.0	24	11	8 6 6 7	12	S7: Medium dense, grey, fine to medium SAND and SILT, wet				
30		S8	29.0-	24	20	4 7		S8: Medium dense, grey, fine to				

**REMARKS**

- 1 - Gravel observed in tip of sample S4.
- 2 - No recovery on sample S5. Initial sample interval resampled with 3" split spoon sampler as sample S5A.
- 3 - Two inch lens of fine gravel observed at approximate midpoint of sample S8.

See Log Key for exploration of sample description and identification procedures. Stratification lines represent approximate boundaries between soil and bedrock types. Actual transitions may be gradual. Water level readings have been made at the times and under the conditions stated. Fluctuations of groundwater may occur due to other factors than those present at the times the measurements were made.

**Exploration No.:**  
**GZ-3**



### TEST BORING LOG



**GZA**  
**GeoEnvironmental, Inc.**  
*Engineers and Scientists*

Beta Group, Inc.  
Taunton Waste Water Treatment Facility  
West Water Street  
Taunton, Massachusetts

**EXPLORATION NO.:** GZ-3  
**SHEET:** 2 of 2  
**PROJECT NO:** 03.34664.00  
**REVIEWED BY:** JER

**Logged By:** Ian Dakers  
**Drilling Co.:** Northern Drill Service Inc  
**Foreman:** Tim Tucker

**Type of Rig:** ATV  
**Rig Model:** B-48  
**Drilling Method:**  
Drive&Wash

**Boring Location:** See Plan  
**Ground Surface Elev. (ft.):** 27  
**Final Boring Depth (ft.):** 41  
**Date Start - Finish:** 9/30/2019 - 9/30/2019

**H. Datum:** N/A  
**V. Datum:** Taunton  
City Base

**Hammer Type:** Automatic Hammer  
**Hammer Weight (lb.):** 140  
**Hammer Fall (in.):** 30  
**Auger or Casing O.D./I.D Dia (in.):** 4.5"/4"

**Sampler Type:** SS  
**Sampler O.D. (in.):** 2.0  
**Sampler Length (in.):** 24  
**Rock Core Size:** N/A

**Groundwater Depth (ft.)**

Date	Time	Stab. Time	Water	Casing
10/11/19	1700	11 Days	25.6	Well

Depth (ft)	Casing Blows/ (Core Rate)	Sample					SPT Value	Sample Description Modified Burmister	Remark	Field Test Data	Stratum Description	Equipment Installed
		No.	Depth (ft.)	Pen. (in)	Rec. (in)	Blows (RQD)						
			31.0			8 11	15	medium SAND and SILT, wet	3			
35		S9	34.0-36.0	24	12	8 9 11 11	20	S9: A (Top 6"): Brown-grey, fine to medium SAND and SILT, wet B (Bot 6"): Brown-grey, fine to coarse SAND, trace Silt, wet			GLACIAL OUTWASH	
40		S10	39.0-41.0	24	10	5 6 8 8	14	S10: Medium dense, brown, fine to coarse SAND, trace Silt, wet	4		41	
								End of exploration at 41 feet.			-14.0	

**REMARKS**  
4 - End of exploration at 41' below ground surface. Observation well installed upon completion of boring; 2" diameter slotted PVC pipe installed from 40' bgs to 25'bgs, solid PVC pipe installed from 25' bgs to 0' bgs. Filter sand installed from 40' bgs to 2' bgs; Bentonite clay installed from 2' bgs to 1' bgs. Observation well fixed in place by road box and concrete at ground surface.

See Log Key for exploration of sample description and identification procedures. Stratification lines represent approximate boundaries between soil and bedrock types. Actual transitions may be gradual. Water level readings have been made at the times and under the conditions stated. Fluctuations of groundwater may occur due to other factors than those present at the times the measurements were made.

**Exploration No.:**  
**GZ-3**

**TEST BORING LOG**



**GZA**  
**GeoEnvironmental, Inc.**  
*Engineers and Scientists*

**Beta Group, Inc.**  
**Taunton Waste Water Treatment Facility**  
**West Water Street**  
**Taunton, Massachusetts**

**EXPLORATION NO.: GZ-4**  
**SHEET: 1 of 2**  
**PROJECT NO: 03.34664.00**  
**REVIEWED BY: JER**

**Logged By:** Nicholas Hettland  
**Drilling Co.:** Northern Drill Service Inc  
**Foreman:** Tim Tucker

**Type of Rig:** ATV  
**Rig Model:** B-48  
**Drilling Method:**  
Drive&Wash

**Boring Location:** See Plan  
**Ground Surface Elev. (ft.):** 19  
**Final Boring Depth (ft.):** 36  
**Date Start - Finish:** 9/23/2019 - 9/23/2019

**H. Datum:** N/A  
**V. Datum:** Taunton City Base

**Hammer Type:** Automatic Hammer  
**Hammer Weight (lb.):** 140  
**Hammer Fall (in.):** 30  
**Auger or Casing O.D./I.D Dia (in.):** 4.5"/4"

**Sampler Type:** SS  
**Sampler O.D. (in.):** 2.0  
**Sampler Length (in.):** 24  
**Rock Core Size:** N/A

**Groundwater Depth (ft.)**

Date	Time	Stab. Time	Water	Casing
9/27/19	1600	4 Days	17.5	Well
9/30/19	1400	7 Days	17.5	Well
10/11/19	1330	18 Days	17.6	Well

Depth (ft)	Casing Blows/ (Core Rate)	Sample					SPT Value	Sample Description Modified Burmister	Remark	Field Test Data	Stratum Description Elev. (ft.)	Equipment Installed		
		No.	Depth (ft.)	Pen. (in)	Rec. (in)	Blows (RQD)								
5		S1	0.0-2.0	24	18	3 6 7 7	13	S1: A (Top 6"): Brown, fine to medium SAND, some Silt, trace Root Fibers, moist			0.5	TOPSOIL	18.5	Bentonite
		S2	2.0-4.0	24	18	6 9 7 8	16	B (Bot 12"): Brown, fine to coarse SAND, little fine Gravel, trace Silt, moist			4	FILL	15.0	
10		S3	4.0-6.0	24	13	6 6 5 5	11	S2: A (Top 12"): Brown, fine to coarse SAND, little fine Gravel, trace Silt, moist B (Bot 6"): Brown with orange staining, fine to medium SAND, little Silt, moist					Solid PVC Riser	
		S4	9.0-11.0	24	7	6 7 8 8	15	S3: A (Top 5"): Brown with orange, fine to medium SAND, little Silt, moist B (Bot 8"): Brown, fine to coarse SAND, little fine Gravel, little Silt, wet S4: Medium dense, brown, fine to medium SAND, little Silt, wet						
15		S5	14.0-16.0	24	8	5 6 6 6	12	S5: Medium dense, brown, fine SAND, little Silt, wet					Filter Sand	
		S6	19.0-21.0	24	4	10 5 4 5	9	S6: Loose, brown, fine to coarse SAND, some fine Gravel, little Silt, wet						
25		S7	24.0-26.0	24	10	6 8 10 9	18	S7: Medium dense, brown, fine to medium SAND, little Silt, wet					Slotted PVC Pipe	
		S8	29.0-	24	8	6 4		S8: Medium dense, brown, fine to						

**REMARKS**  
1 - Driller observed increase in drill bit chatter at 18.5' below ground surface (bgs).

See Log Key for exploration of sample description and identification procedures. Stratification lines represent approximate boundaries between soil and bedrock types. Actual transitions may be gradual. Water level readings have been made at the times and under the conditions stated. Fluctuations of groundwater may occur due to other factors than those present at the times the measurements were made.

**Exploration No.:**  
**GZ-4**

GZA TEMPLATE TEST BORING W/ EQUIP.; 11/5/2019; 2:42:24 PM

**TEST BORING LOG**



**GZA**  
**GeoEnvironmental, Inc.**  
*Engineers and Scientists*

Beta Group, Inc.  
Taunton Waste Water Treatment Facility  
West Water Street  
Taunton, Massachusetts

**EXPLORATION NO.:** GZ-4  
**SHEET:** 2 of 2  
**PROJECT NO:** 03.34664.00  
**REVIEWED BY:** JER

**Logged By:** Nicholas Hettland  
**Drilling Co.:** Northern Drill Service Inc  
**Foreman:** Tim Tucker

**Type of Rig:** ATV  
**Rig Model:** B-48  
**Drilling Method:**  
Drive&Wash

**Boring Location:** See Plan  
**Ground Surface Elev. (ft.):** 19  
**Final Boring Depth (ft.):** 36  
**Date Start - Finish:** 9/23/2019 - 9/23/2019

**H. Datum:** N/A  
**V. Datum:** Taunton  
City Base

**Hammer Type:** Automatic Hammer  
**Hammer Weight (lb.):** 140  
**Hammer Fall (in.):** 30  
**Auger or Casing O.D./I.D Dia (in.):** 4.5"/4"

**Sampler Type:** SS  
**Sampler O.D. (in.):** 2.0  
**Sampler Length (in.):** 24  
**Rock Core Size:** N/A

**Groundwater Depth (ft.)**

Date	Time	Stab. Time	Water	Casing
9/27/19	1600	4 Days	17.5	Well
9/30/19	1400	7 Days	17.5	Well
10/11/19	1330	18 Days	17.6	Well

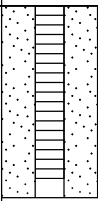
Depth (ft)	Casing Blows/ (Core Rate)	Sample					SPT Value	Sample Description Modified Burmister	Remark	Field Test Data	Depth (ft)	Stratum Description Elev. (ft.)	Equipment Installed
		No.	Depth (ft.)	Pen. (in)	Rec. (in)	Blows (RQD)							
			31.0			6 9	10	coarse SAND, little Gravel, trace Silt, wet					
35		S9	34.0-36.0	24	7	6 5 4 10	9	S9: Loose, grey, fine to coarse SAND, little Silt, trace fine Gravel, wet	2		36	-17.0	
								End of exploration at 36 feet.					
40													
45													
50													
55													
60													

**REMARKS**  
2 - End of exploration at 36' bgs. Observation well installed upon completion of boring; 2" diameter slotted pvc pipe installed from 35' bgs to 20' bgs; solid pvc pipe installed from 20' bgs to 0' bgs. Filter sand installed from 35' bgs to 2' bgs; bentonite clay installed from 2' bgs to 1'bgs. Observation well fixed in place by roadbox and concrete at ground surface.

See Log Key for exploration of sample description and identification procedures. Stratification lines represent approximate boundaries between soil and bedrock types. Actual transitions may be gradual. Water level readings have been made at the times and under the conditions stated. Fluctuations of groundwater may occur due to other factors than those present at the times the measurements were made.

**Exploration No.:**  
**GZ-4**



**TEST BORING LOG**



**GZA**  
**GeoEnvironmental, Inc.**  
*Engineers and Scientists*

Beta Group, Inc.  
Taunton Waste Water Treatment Facility  
West Water Street  
Taunton, Massachusetts

**EXPLORATION NO.:** GZ-5  
**SHEET:** 2 of 2  
**PROJECT NO:** 03.34664.00  
**REVIEWED BY:** JER

**Logged By:** Ian Dakers  
**Drilling Co.:** Northern Drill Service Inc  
**Foreman:** Tim Tucker

**Type of Rig:** ATV  
**Rig Model:** B-48  
**Drilling Method:**  
Drive&Wash

**Boring Location:** See Plan  
**Ground Surface Elev. (ft.):** 20  
**Final Boring Depth (ft.):** 51  
**Date Start - Finish:** 9/23/2019 - 9/24/2019

**H. Datum:** N/A  
**V. Datum:** Taunton  
City Base

**Hammer Type:** Automatic Hammer  
**Hammer Weight (lb.):** 140  
**Hammer Fall (in.):** 30  
**Auger or Casing O.D./I.D Dia (in.):** 4.5"/4"

**Sampler Type:** SS  
**Sampler O.D. (in.):** 2.0  
**Sampler Length (in.):** 24  
**Rock Core Size:** N/A

**Groundwater Depth (ft.)**

Date	Time	Stab. Time	Water	Casing
9/27/19	1600	3 Days	19.1	Well
9/30/19	1400	6 Days	19.0	Well
10/11/19	1400	18 Days	19.2	Well

Depth (ft)	Casing Blows/ (Core Rate)	Sample					SPT Value	Sample Description Modified Burmister	Remark	Field Test Data	Stratum Description	Equipment Installed
		No.	Depth (ft.)	Pen. (in)	Rec. (in)	Blows (RQD)						
			31.0			12 12	23	coarse SAND and GRAVEL, little Clayey Silt, wet			GLACIAL OUTWASH	
35		S9	34.0-36.0	24	12	8 10 13 16	23	S9: Medium dense, grey, fine to medium SAND, little Silt, wet				
40		S10	39.0-41.0	24	12	14 12 7 6	19	S10: A (Top 6"): Grey, fine to coarse SAND, little fine Gravel, trace Silt, wet B (Bot 6"): Grey, fine to medium SAND, little Silt, wet				
45		S11	44.0-46.0	24	12	14 18 22 29	40	S11: Dense, grey, fine to coarse SAND, some fine Gravel, trace Silt, wet				
50		S12	49.0-51.0	24	13	26 32 37 30	69	S12: Very dense, grey, fine to coarse SAND and GRAVEL, trace Silt, wet				
								End of exploration at 51 feet.	2	51	-31.0	
55												
60												

**REMARKS**  
2 - End of exploration at 51' below ground surface (bgs). Observation well installed upon completion of boring; 2" diameter slotted pvc pipe installed from 35' bgs to 20' bgs; solid pvc pipe installed from 20' bgs to 0' bgs. Filter sand installed from 50' bgs to 2' bgs; bentonite clay installed from 2' bgs to 1' bgs. Observation well fixed in place by roadbox and concrete at ground surface.

See Log Key for exploration of sample description and identification procedures. Stratification lines represent approximate boundaries between soil and bedrock types. Actual transitions may be gradual. Water level readings have been made at the times and under the conditions stated. Fluctuations of groundwater may occur due to other factors than those present at the times the measurements were made.

**Exploration No.:**  
**GZ-5**



**TEST BORING LOG**



**GZA**  
**GeoEnvironmental, Inc.**  
*Engineers and Scientists*

Beta Group, Inc.  
Taunton Waste Water Treatment Facility  
West Water Street  
Taunton, Massachusetts

**EXPLORATION NO.:** GZ-6  
**SHEET:** 2 of 2  
**PROJECT NO:** 03.34664.00  
**REVIEWED BY:** JER

**Logged By:** Ian Dakers  
**Drilling Co.:** Northern Drill Service Inc  
**Foreman:** Tim Tucker

**Type of Rig:** ATV  
**Rig Model:** B-48  
**Drilling Method:**  
Drive&Wash

**Boring Location:** See Plan  
**Ground Surface Elev. (ft.):** 20  
**Final Boring Depth (ft.):** 36  
**Date Start - Finish:** 9/24/2019 - 9/24/2019

**H. Datum:** N/A  
**V. Datum:** Taunton  
City Base

**Hammer Type:** Automatic Hammer  
**Hammer Weight (lb.):** 140  
**Hammer Fall (in.):** 30  
**Auger or Casing O.D./I.D Dia (in.):** 4.5"/4"

**Sampler Type:** SS  
**Sampler O.D. (in.):** 2.0  
**Sampler Length (in.):** 24  
**Rock Core Size:** N/A

**Groundwater Depth (ft.)**

Date	Time	Stab. Time	Water	Casing
9/27/19	1600	3 Days	18.5	Well
9/30/19	1400	6 Days	18.3	Well
10/11/19	1430	17 Days	18.6	Well

Depth (ft)	Casing Blows/ (Core Rate)	Sample						Sample Description Modified Burmister	Remark	Field Test Data	Depth (ft)	Stratum Description Elev. (ft.)	Equipment Installed
		No.	Depth (ft.)	Pen. (in)	Rec. (in)	Blows (RQD)	SPT Value						
35	S9	31.0				9 7	18	SAND, little fine Gravel, trace Silt, wet B (Bot 2"): Grey, fine to medium SAND, little Clayey Silt, wet	2	36	-16.0		
		34.0-36.0	24	4	11 15 12 13	27	S9: Medium dense, grey, fine to coarse SAND, trace Silt, wet						
								End of exploration at 36 feet.	3				

**REMARKS**  
2 - Gravel observed in tip of sample S9.  
3 - End of exploration at 36' below ground surface (bgs). Observation well installed upon completion of boring; 2" diameter slotted PVC pipe installed from 35' bgs to 20' bgs; solid PVC pipe installed from 20' bgs to 0' bgs. Filter sand installed from 35' bgs to 2' bgs; Bentonite clay installed from 2' bgs to 1' bgs. Observation well fixed in place by roadbox and concrete at ground surface.

See Log Key for exploration of sample description and identification procedures. Stratification lines represent approximate boundaries between soil and bedrock types. Actual transitions may be gradual. Water level readings have been made at the times and under the conditions stated. Fluctuations of groundwater may occur due to other factors than those present at the times the measurements were made.

**Exploration No.:**  
**GZ-6**

GZA TEMPLATE TEST BORING W/ EQUIP.; 11/5/2019; 2:42:29 PM

**TEST BORING LOG**



**GZA**  
**GeoEnvironmental, Inc.**  
*Engineers and Scientists*

**Beta Group, Inc.**  
**Taunton Waste Water Treatment Facility**  
**West Water Street**  
**Taunton, Massachusetts**

**EXPLORATION NO.: GZ-7**  
**SHEET: 1 of 2**  
**PROJECT NO: 03.34664.00**  
**REVIEWED BY: JER**

**Logged By:** Ian Dakers  
**Drilling Co.:** Northern Drill Service Inc  
**Foreman:** Tim Tucker

**Type of Rig:** ATV  
**Rig Model:** B-48  
**Drilling Method:**  
Drive&Wash

**Boring Location:** See Plan  
**Ground Surface Elev. (ft.):** 14  
**Final Boring Depth (ft.):** 34  
**Date Start - Finish:** 9/25/2019 - 9/25/2019

**H. Datum:** N/A  
**V. Datum:** Taunton City Base

**Hammer Type:** Automatic Hammer  
**Hammer Weight (lb.):** 140  
**Hammer Fall (in.):** 30  
**Auger or Casing O.D./I.D Dia (in.):** 4.5"/4"

**Sampler Type:** SS  
**Sampler O.D. (in.):** 2.0  
**Sampler Length (in.):** 24  
**Rock Core Size:** N/A

Groundwater Depth (ft.)				
Date	Time	Stab. Time	Water	Casing
9/27/19	1200	2 Days	13.4	Well
9/30/19	1330	5 Days	12.6	Well
10/11/19	1600	16 Days	13.3	Well

Depth (ft)	Casing Blows/ (Core Rate)	Sample					SPT Value	Sample Description Modified Burmister	Remark	Field Test Data	Stratum Description Elev. (ft.)	Equipment Installed
		No.	Depth (ft.)	Pen. (in)	Rec. (in)	Blows (RQD)						
5 10 15 20 25 30		S1	0.0-2.0	24	20	1 4 11 19	15	S1: A (Top 4"): Brown, fine to medium SAND, trace Silt, trace Root Fibers, moist			0.5 --- TOPSOIL --- 13.5	
		S2	2.0-4.0	24	20	15 13 9 7	22	B (Bot 16"): Brown, fine to medium SAND, little Gravel, trace Silt, moist				Bentonite
		S3	4.0-6.0	24	13	4 5 10 11	15	S2: Medium dense, brown, fine to medium SAND, little Silt, moist S3: A (Top 5"): Brown, fine to coarse SAND, trace Silt, moist B (Bot 8"): Brown, fine to medium SAND, little Silt, moist			FILL	
		S4	9.0-11.0	24	15	19 26 23 39	49	S4: Dense, brown, fine to medium SAND, little Silt, moist			7 --- 7.0	Solid Riser Pipe
		S5	14.0-16.0	24	0	8 14 11 12	25	S5: NO RECOVERY				
		S6	16.0-18.0	24	16	14 18 10 11	28	S6: A (Top 9"): Brown, fine to coarse SAND, little fine to coarse Gravel, trace Silt, wet				Filter Sand
		S7	18.0-20.0	24	10	9 13 10 9	23	B (Bot 7"): Brown with orange, fine to coarse SAND, trace Silt, wet			GLACIAL OUTWASH	
		S8	20.0-22.0	24	7	6 7 7 7	14	S7: Medium dense, brown with orange, fine to coarse SAND, little fine Gravel, trace Silt, wet				
		S9	22.0-24.0	24	7	7 8 9 12	17	S8: Medium dense, brown with orange, fine to coarse SAND, trace Silt, wet				Screened PVC Pipe
		S10	24.0-26.0	24	3	9 14 17 12	31	S9: Medium dense, brown-grey, fine to coarse SAND, trace Silt, wet				
		S11	26.0-28.0	24	10	13 7 8 10	15	S10: Dense, brown, fine to coarse SAND and GRAVEL, trace Silt, wet				
		S12	28.0-30.0	24	6	8 6 7 7	13	S11: A (Top 6"): Brown, fine to coarse SAND, little fine Gravel, little Silt, wet B (Bot 4"): Grey, fine to coarse, SAND				

**REMARKS**

See Log Key for exploration of sample description and identification procedures. Stratification lines represent approximate boundaries between soil and bedrock types. Actual transitions may be gradual. Water level readings have been made at the times and under the conditions stated. Fluctuations of groundwater may occur due to other factors than those present at the times the measurements were made.

**Exploration No.:**  
**GZ-7**



**TEST BORING LOG**



**GZA**  
**GeoEnvironmental, Inc.**  
*Engineers and Scientists*

Beta Group, Inc.  
Taunton Waste Water Treatment Facility  
West Water Street  
Taunton, Massachusetts

**EXPLORATION NO.:** GZ-7  
**SHEET:** 2 of 2  
**PROJECT NO:** 03.34664.00  
**REVIEWED BY:** JER

**Logged By:** Ian Dakers  
**Drilling Co.:** Northern Drill Service Inc  
**Foreman:** Tim Tucker

**Type of Rig:** ATV  
**Rig Model:** B-48  
**Drilling Method:**  
Drive&Wash

**Boring Location:** See Plan  
**Ground Surface Elev. (ft.):** 14  
**Final Boring Depth (ft.):** 34  
**Date Start - Finish:** 9/25/2019 - 9/25/2019

**H. Datum:** N/A  
**V. Datum:** Taunton City Base

**Hammer Type:** Automatic Hammer  
**Hammer Weight (lb.):** 140  
**Hammer Fall (in.):** 30  
**Auger or Casing O.D./I.D Dia (in.):** 4.5"/4"

**Sampler Type:** SS  
**Sampler O.D. (in.):** 2.0  
**Sampler Length (in.):** 24  
**Rock Core Size:** N/A

**Groundwater Depth (ft.)**

Date	Time	Stab. Time	Water	Casing
9/27/19	1200	2 Days	13.4	Well
9/30/19	1330	5 Days	12.6	Well
10/11/19	1600	16 Days	13.3	Well

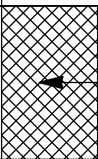
Depth (ft)	Casing Blows/ (Core Rate)	Sample					SPT Value	Sample Description Modified Burmister	Remark	Field Test Data	Depth (ft.)	Stratum Description Elev. (ft.)	Equipment Installed
		No.	Depth (ft.)	Pen. (in)	Rec. (in)	Blows (RQD)							
35		S13	30.0-32.0	24	12	6 5 5 7	10	and GRAVEL, trace Silt, wet S12: Medium dense, grey, fine to coarse SAND, trace fine Gravel, little Silt, wet			34	-20.0	 Drill Cuttings
		S14	32.0-34.0	24	16	2 4 5 5	9	S13: Medium dense, grey, fine SAND, some Silt, wet S14: Loose, grey, fine SAND, some Silt, wet					
								End of exploration at 34 feet.	1				

**REMARKS**  
1 - End of exploration at 34' below ground surface (bgs). Observation well installed upon completion of boring; slotted pvc pipe installed from 30' bgs to 15' bgs; solid pvc pipe installed from 15' bgs to 0' bgs. Drill cutting used as backfill from 34' bgs to 30' bgs; Clean filter sand installed from 30' bgs to 2' bgs; Bentonite clay installed from 2' bgs to 1' bgs. Observation well fixed in place by roadbox and concrete at ground surface.

See Log Key for exploration of sample description and identification procedures. Stratification lines represent approximate boundaries between soil and bedrock types. Actual transitions may be gradual. Water level readings have been made at the times and under the conditions stated. Fluctuations of groundwater may occur due to other factors than those present at the times the measurements were made.

**Exploration No.:**  
**GZ-7**

**TEST BORING LOG**



**GZA**  
**GeoEnvironmental, Inc.**  
*Engineers and Scientists*

**Beta Group, Inc.**  
**Taunton Waste Water Treatment Facility**  
**West Water Street**  
**Taunton, Massachusetts**

**EXPLORATION NO.: GZ-8**  
**SHEET: 1 of 1**  
**PROJECT NO: 03.34664.00**  
**REVIEWED BY: JER**

**Logged By:** Ian Dakers  
**Drilling Co.:** Northern Drill Service Inc  
**Foreman:** Tim Tucker

**Type of Rig:** ATV  
**Rig Model:** B-48  
**Drilling Method:**  
Drive&Wash

**Boring Location:** See Plan  
**Ground Surface Elev. (ft.):** 11  
**Final Boring Depth (ft.):** 31  
**Date Start - Finish:** 9/25/2019 - 9/25/2019

**H. Datum:** N/A  
**V. Datum:** Taunton City Base

**Hammer Type:** Automatic Hammer  
**Hammer Weight (lb.):** 140  
**Hammer Fall (in.):** 30  
**Auger or Casing O.D./I.D Dia (in.):** 4.5"/4"

**Sampler Type:** SS  
**Sampler O.D. (in.):** 2.0  
**Sampler Length (in.):** 24  
**Rock Core Size:** N/A

**Groundwater Depth (ft.)**

Date	Time	Stab. Time	Water	Casing
9/27/19	1600	2 Days	10.5	Well
9/30/19	1330	5 Days	10.1	Well
10/11/19	1630	16 Days	10.6	Well

Depth (ft)	Casing Blows/ (Core Rate)	Sample					SPT Value	Sample Description Modified Burmister	Remark	Field Test Data	Stratum Description Elev. (ft.)	Equipment Installed
		No.	Depth (ft.)	Pen. (in)	Rec. (in)	Blows (RQD)						
5		S1	0.0-2.0	24	22	3 6 13 12	19	S1: A (Top 6"): Brown, fine to medium SAND, little Silt, trace Root Fibers, moist			0.5 TOPSOIL 10.5	
		S2	2.0-4.0	24	19	11 30 29 27	59	B (Bot 16"): Brown, fine to medium SAND, little Silt, moist			4 7.0	
		S3	4.0-6.0	24	18	22 26 34 57	60	S2: Very dense, brown, fine to medium SAND, trace fine Gravel, little Silt, moist S3: Very dense, brown, fine to medium SAND, little Silt, moist				
10		S4	9.0-11.0	24	12	8 9 10 9	19	S4: Medium dense, brown, fine to medium SAND, trace Silt, moist				
15		S5	14.0-16.0	24	12	5 5 6 6	11	S5: Medium dense, grey, fine to medium SAND, trace Silt, trace fine Gravel, wet				
20		S6	19.0-21.0	24	14	5 5 5 4	10	S6: Medium dense, grey SILT, little fine Sand, wet				
25		S7	24.0-26.0	24	9	4 8 9 9	17	S7: Medium dense, grey, fine to coarse SAND, trace Silt, wet				
30		S8	29.0-31.0	24	12	3 4 4 10	8	S8: Loose, grey, fine to medium SAND, trace Silt, wet				
								End of exploration at 31 feet.	1		31 -20.0	

**REMARKS** 1 - End of exploration at 31' below ground surface (bgs). Observation well installed upon completion of boring; 2" diameter slotted PVC pipe installed from 30' bgs to 10' bgs; Solid PVC pipe installed from 10' bgs to 0' bgs. Filter sand installed from 30' bgs to 2' bgs; Bentonite clay installed from 2' bgs to 1' bgs. Observation well fixed in place by roadbox and concrete at ground surface.

See Log Key for exploration of sample description and identification procedures. Stratification lines represent approximate boundaries between soil and bedrock types. Actual transitions may be gradual. Water level readings have been made at the times and under the conditions stated. Fluctuations of groundwater may occur due to other factors than those present at the times the measurements were made.

**Exploration No.:**  
**GZ-8**

GZA TEMPLATE TEST BORING W/ EQUIP.; 11/5/2019; 2:42:32 PM

### TEST BORING LOG



**GZA**  
**GeoEnvironmental, Inc.**  
*Engineers and Scientists*

Beta Group, Inc.  
 Taunton Waste Water Treatment Facility  
 West Water Street  
 Taunton, Massachusetts

EXPLORATION NO.: GZ-9  
 SHEET: 1 of 1  
 PROJECT NO: 03.34664.00  
 REVIEWED BY: JER

**Logged By:** Ian Dakers  
**Drilling Co.:** Northern Drill Service Inc  
**Foreman:** Tim Tucker

**Type of Rig:** ATV  
**Rig Model:** B-48  
**Drilling Method:**  
 Drive&Wash

**Boring Location:** See Plan  
**Ground Surface Elev. (ft.):** 22  
**Final Boring Depth (ft.):** 21  
**Date Start - Finish:** 9/26/2019 - 9/26/2019

**H. Datum:** N/A  
**V. Datum:** Taunton  
 City Base

**Hammer Type:** Automatic Hammer  
**Hammer Weight (lb.):** 140  
**Hammer Fall (in.):** 30  
**Auger or Casing O.D./I.D Dia (in.):** 4.5"/4"

**Sampler Type:** SS  
**Sampler O.D. (in.):** 2.0  
**Sampler Length (in.):** 24  
**Rock Core Size:** N/A

**Groundwater Depth (ft.)**

Date	Time	Stab. Time	Water	Casing
Not Measured				

Depth (ft)	Casing Blows/ (Core Rate)	Sample					SPT Value	Sample Description Modified Burmister	Remark	Field Test Data	Stratum		Equipment Installed					
		No.	Depth (ft.)	Pen. (in)	Rec. (in)	Blows (RQD)					Depth (ft.)	Description		Elev. (ft.)				
5		S1	0.0-1.0	12	8	5 23	68	S1: Medium dense, brown, fine to coarse SAND and GRAVEL, trace Silt, moist	1	2	1	COBBLES	21.0	No Equipment Installed				
						2					FILL	20.0						
						4					CONCRETE	18.0						
						8					FILL	14.0						
						21					GLACIAL OUTWASH	1.0						
		S2	4.0-6.0	24	13	5 23 45 46	53	S2: Very dense, brown, fine to coarse SAND and GRAVEL, trace Silt, moist										
		S3	9.0-11.0	24	15	29 26 27 28			38	S3: Very dense, brown-grey, fine to medium SAND, little Silt, trace fine Gravel, moist								
		S4	14.0-16.0	24	13	14 13 25 34					64	S4: Dense, brown, fine to medium SAND, little fine Gravel, little Silt, moist						
		S5	19.0-21.0	24	14	17 28 36 37							3	S5: Very dense, grey-brown, fine to coarse SAND, little fine Gravel, trace Silt, wet				
		End of exploration at 21 feet.																

**REMARKS**

- 1 - Cobbles were removed from 0'-1' below ground surface (bgs) prior to driving sampler S1. Concrete observed in tip of sample S1.
- 2 - Drill bit used to advance through concrete from 2' to 4' bgs.
- 3 - End of exploration at 21' bgs. Boring backfilled with drill cuttings.
- Drilling fluid introduced into borehole. Groundwater therefore not measured.

See Log Key for exploration of sample description and identification procedures. Stratification lines represent approximate boundaries between soil and bedrock types. Actual transitions may be gradual. Water level readings have been made at the times and under the conditions stated. Fluctuations of groundwater may occur due to other factors than those present at the times the measurements were made.

**Exploration No.:**  
**GZ-9**

### TEST BORING LOG



**GZA**  
**GeoEnvironmental, Inc.**  
*Engineers and Scientists*

**Beta Group, Inc.**  
**Taunton Waste Water Treatment Facility**  
**West Water Street**  
**Taunton, Massachusetts**

**EXPLORATION NO.: GZ-10**  
**SHEET: 1 of 1**  
**PROJECT NO: 03.34664.00**  
**REVIEWED BY: JER**

**Logged By:** Ian Dakers  
**Drilling Co.:** Northern Drill Service Inc  
**Foreman:** Tim Tucker

**Type of Rig:** ATV  
**Rig Model:** B-48  
**Drilling Method:**  
Drive&Wash

**Boring Location:** See Plan  
**Ground Surface Elev. (ft.):** 24  
**Final Boring Depth (ft.):** 31  
**Date Start - Finish:** 9/26/2019 - 9/26/2019

**H. Datum:** N/A  
**V. Datum:** Taunton City Base

**Hammer Type:** Automatic Hammer  
**Hammer Weight (lb.):** 140  
**Hammer Fall (in.):** 30  
**Auger or Casing O.D./I.D Dia (in.):** 4.5"/4"

**Sampler Type:** SS  
**Sampler O.D. (in.):** 2.0  
**Sampler Length (in.):** 24  
**Rock Core Size:** N/A

#### Groundwater Depth (ft.)

Date	Time	Stab. Time	Water	Casing
Not Measured				

Depth (ft)	Casing Blows/ (Core Rate)	Sample						Sample Description Modified Burmister	Remark	Field Test Data	Stratum		Equipment Installed	
		No.	Depth (ft.)	Pen. (in)	Rec. (in)	Blows (RQD)	SPT Value				Depth (ft.)	Description Elev. (ft.)		
5		S1	0.0-2.0	24	18	WOH 3 5 6	8	S1: A (Top 7"): Brown, fine to medium SAND, little Silt, little Root Fibers, moist			0.5	TOPSOIL 23.5	No Equipment Installed	
		S2	2.0-4.0	24	22	6 9 10 8	19	B (Bot 11"): Brown-grey, fine to medium SAND, little Silt, moist			4	FILL 20.0		
		S3	4.0-6.0	24	13	6 9 12 12	21	S2: Medium dense, brown/grey, fine SAND, little Silt, moist S3: A (Top 4"): Brown-grey, fine SAND, some Silt, moist B (Bot 9"): Brown-grey, fine SAND, little Silt, moist						
		S4	9.0-11.0	24	12	6 12 13 15	25	S4: Medium dense, brown-grey, fine to medium SAND, little Silt, moist						
		S5	14.0-16.0	24	12	9 14 17 19	31	S5: Dense, brown/grey, fine to medium SAND, little Silt, moist						
		S6	19.0-21.0	24	3	19 18 16 20	34	S6: Dense, brown-grey, fine to medium SAND, some fine Gravel, some Silt, wet	2					
		S7	24.0-26.0	24	13	7 11 14 12	25	S7: A (Top 9"): Brown, fine to coarse SAND, little Silt, wet B (Bottom 4"): Brown-grey, fine to medium SAND, little Silt, wet						
		S8	29.0-31.0	24	15	10 15 20 19	35	S8: Dense, brown-gray, fine to coarse SAND, trace Silt, wet			31	-7.0		
							End of exploration at 31 feet.	1 3 4						

**REMARKS**

- 2 - Gravel chunk observed in tip of sample S6.
- 1 - WOH=Weight of hammer.
- 3 - Drilling fluid introduced into borehole. Groundwater therefore not measured.
- 4 - End of exorption at 31' below ground surface (bgs). Boring backfilled with drill cuttings.

See Log Key for exploration of sample description and identification procedures. Stratification lines represent approximate boundaries between soil and bedrock types. Actual transitions may be gradual. Water level readings have been made at the times and under the conditions stated. Fluctuations of groundwater may occur due to other factors than those present at the times the measurements were made.

**Exploration No.:**  
**GZ-10**



## **APPENDIX D**

### **GEOTECHNICAL LABORATORY TESTS**



195 Frances Avenue  
 Cranston RI, 02910  
 Phone: (401)-467-6454  
 Fax: (401)-467-2398  
[thielsch.com](http://thielsch.com)  
*Let's Build a Solid Foundation*

Client Information:  
 GZA GeoEnvironmental  
 Providence, RI  
 PM: J. Ressler  
 Assigned By: N. Hetland  
 Collected By: Ian Dakers

Project Information:  
**Taunton Waste Water Treatment Plant**  
**Providence, RI**  
 GZA Project Number: 03.0034664.00  
 Summary Page: 1 of 1  
 Report Date: 10.23.19

**LABORATORY TESTING DATA SHEET, Report No.: 7419-K-167**

Boring No.	Sample No.	Depth (Ft)	Laboratory No.	Identification Tests								Proctor / CBR / Permeability Tests							Laboratory Log and Soil Description	
				As Received Water Content %	LL %	PL %	Gravel %	Sand %	Fines %	Org. %	G <sub>s</sub>	Dry unit wt. pcf	Test Water Content %	$\gamma_d$ MAX (pcf) W <sub>opt</sub> (%)	$\gamma_d$ MAX (pcf) W <sub>opt</sub> (%) (Corr.)	Target Test Setup as % of Proctor	CBR @ 0.1"	CBR @ 0.2"		Perme-ability cm/sec
				D2216	D4318		D6913			D2974	D854			D1557						
GZ-8	S-5B	14-16	19-S-2220				0.3	92.1	7.6										Gray f-m SAND, trace Silt, trace fine Gravel	
GZ-7	S-7	18-20	19-S-2221				17.1	74.2	8.7										Light Brown f-c SAND, little fine Gravel, trace Silt	
GZ-6	S-6	19-21	19-S-2222				0.4	86.0	13.6										Brown f-m SAND, little Silt, trace fine Gravel	
GZ-5	S-7	24-26	19-S-2223				39.3	53.1	7.6										Gray f-c SAND and f-c GRAVEL, trace Silt	
GZ-4	S-5	14-16	19-S-2224				0.0	84.7	15.3										Gray fine SAND, little Silt	
GZ-10	S-4	9-11	19-S-2025				0.0	85.3	14.7										Brown f-m SAND, little Silt	
GZ-3	S-7	24-26	19-S-2226				0.0	56.9	43.1										Gray f-m SAND and SILT	
GZ-2	S-6	14-16	19-S-2227				10.8	89.1	0.1										Gray f-m SAND, little fine Gravel, trace Silt	
GZ-1	S-3	4-6	19-S-2228				0.0	75.9	24.1										Gray f-m SAND, some Silt	
GZ-5	S-4	9-11	19-S-2229				0.0	61.0	39.0										Light Brown fine SAND and SILT	
GZ-9	S-3	9-11	19-S-2230				1.9	81.7	16.4										Gray f-m SAND, little Silt, trace fine Gravel	
GZ-6	S-2	2-4	19-S-2231				8.2	59.2	32.6										Brown f-m SAND, some Silt, trace fine Gravel	

Date Received: 10.15.19

Reviewed By: *SKW*

Date Reviewed: 10.24.19

# Particle Size Distribution Report

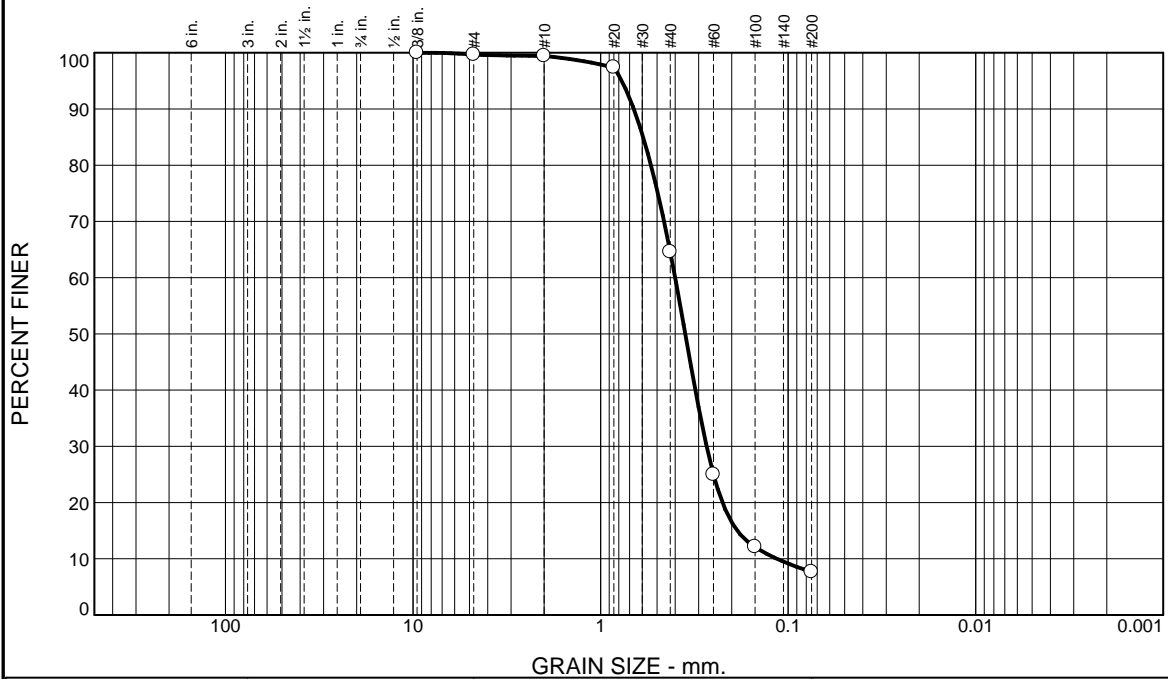

% +3"	% Gravel		% Sand			% Fines	
	Coarse	Fine	Coarse	Medium	Fine	Silt	Clay
0.0	0.0	0.3	0.3	34.8	57.0	7.6	

Test Results (D6913 & ASTM D 1140)			
Opening Size	Percent Finer	Spec.* (Percent)	Pass? (X=Fail)
0.375"	100.0		
#4	99.7		
#10	99.4		
#20	97.4		
#40	64.6		
#60	25.0		
#100	12.1		
#200	7.6		

\* (no specification provided)

**Material Description**

Gray f-m SAND, trace Silt, trace fine Gravel

**Atterberg Limits (ASTM D 4318)**

PL= NP                      LL= NV                      PI= NP

**Classification**

USCS (D 2487)= SP-SM    AASHTO (M 145)= A-3

**Coefficients**

D <sub>90</sub> = 0.6652	D <sub>85</sub> = 0.5933	D <sub>60</sub> = 0.4003
D <sub>50</sub> = 0.3536	D <sub>30</sub> = 0.2719	D <sub>15</sub> = 0.1869
D <sub>10</sub> = 0.1148	C <sub>u</sub> = 3.49	C <sub>c</sub> = 1.61

**Remarks**

Date Received: 10.15.19      Date Tested: 10.22.19

Tested By: IA

Checked By: Steven Accetta

Title: Laboratory Coordinator

Source of Sample: Boring      Depth: 14-16'  
 Sample Number: GZ-8 / S-5B

Date Sampled:

<b>Thielsch Engineering Inc.</b>  <b>Cranston, RI</b>	Client: GZA GeoEnvironmental Project: Taunton Waste Water Treatment Plant Taunton, MA Project No: 03.0034664.00
Figure 19-S-2220	

# Particle Size Distribution Report

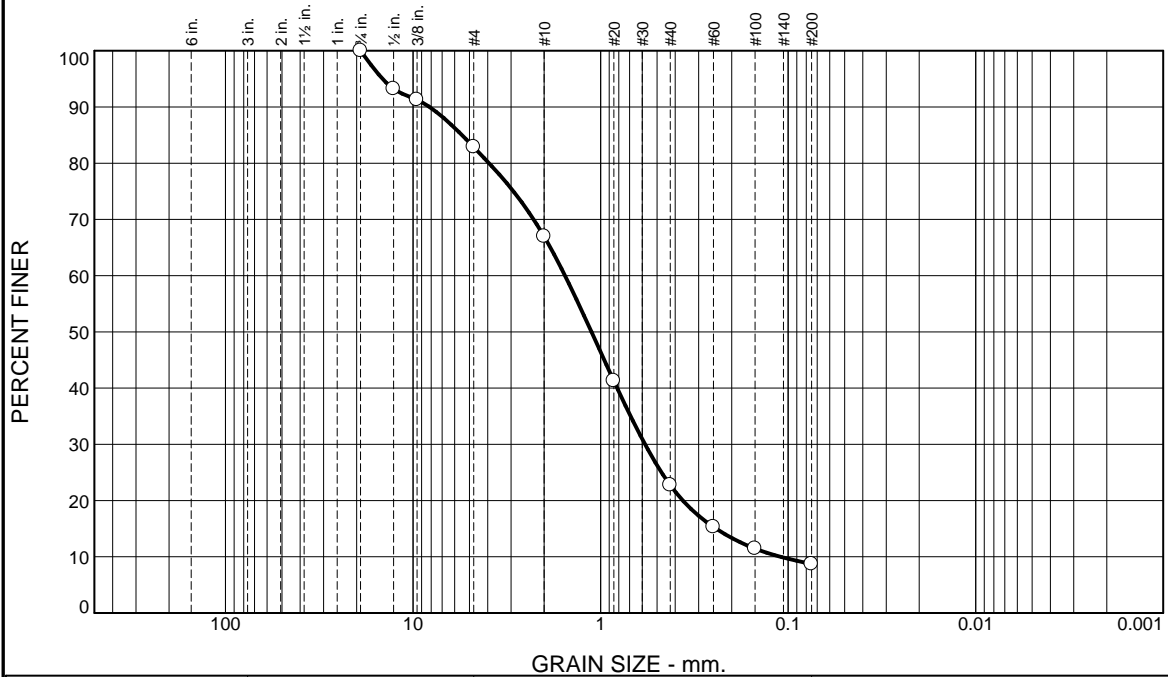

% +3"	% Gravel		% Sand			% Fines	
	Coarse	Fine	Coarse	Medium	Fine	Silt	Clay
0.0	0.0	17.1	15.9	44.3	14.0	8.7	

Test Results (D6913 & ASTM D 1140)			
Opening Size	Percent Finer	Spec.* (Percent)	Pass? (X=Fail)
0.75"	100.0		
0.5"	93.2		
0.375"	91.3		
#4	82.9		
#10	67.0		
#20	41.3		
#40	22.7		
#60	15.3		
#100	11.4		
#200	8.7		

**Material Description**

Light Brown f-c SAND, little fine Gravel, trace Silt

**Atterberg Limits (ASTM D 4318)**

PL= NP                      LL= NV                      PI= NP

**Classification**

USCS (D 2487)= SW-SM    AASHTO (M 145)= A-1-b

**Coefficients**

D <sub>90</sub> = 8.1616	D <sub>85</sub> = 5.4830	D <sub>60</sub> = 1.5473
D <sub>50</sub> = 1.1185	D <sub>30</sub> = 0.5794	D <sub>15</sub> = 0.2421
D <sub>10</sub> = 0.1099	C <sub>u</sub> = 14.08	C <sub>c</sub> = 1.97

Remarks

Date Received: 10.15.19      Date Tested: 10.22.19

Tested By: IA

Checked By: Steven Accetta

Title: Laboratory Coordinator

\* (no specification provided)

Source of Sample: Boring      Depth: 18-20'  
 Sample Number: GZ-7 / S-7

Date Sampled:

<b>Thielsch Engineering Inc.</b>  <b>Cranston, RI</b>	Client: GZA GeoEnvironmental Project: Taunton Waste Water Treatment Plant Taunton, MA Project No: 03.0034664.00
Date Sampled: _____ Figure 19-S-2221	



# Particle Size Distribution Report

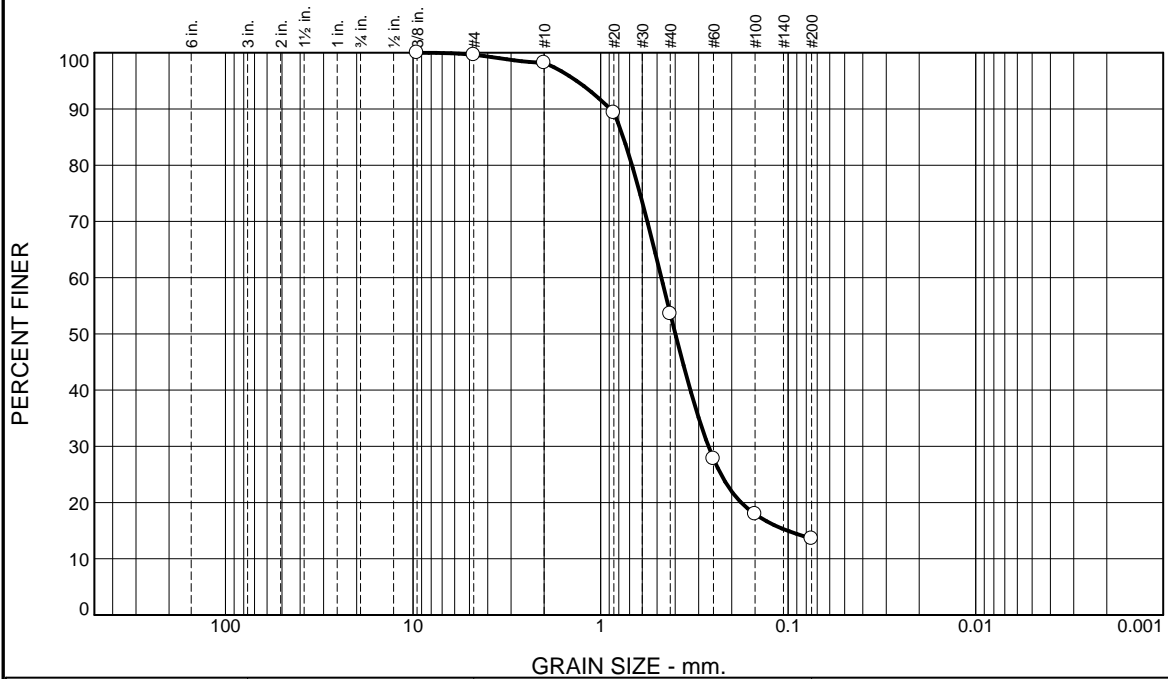

% +3"	% Gravel		% Sand			% Fines	
	Coarse	Fine	Coarse	Medium	Fine	Silt	Clay
0.0	0.0	0.4	1.4	44.6	40.0	13.6	

Test Results (D6913 & ASTM D 1140)			
Opening Size	Percent Finer	Spec.* (Percent)	Pass? (X=Fail)
0.375"	100.0		
#4	99.6		
#10	98.2		
#20	89.4		
#40	53.6		
#60	27.8		
#100	17.9		
#200	13.6		

**Material Description**

Brown f-m SAND, little Silt, trace fine Gravel

**Atterberg Limits (ASTM D 4318)**

PL= NP      LL= NV      PI= NP

**Classification**

USCS (D 2487)= SM      AASHTO (M 145)= A-2-4(0)

**Coefficients**

D<sub>90</sub>= 0.8888      D<sub>85</sub>= 0.7584      D<sub>60</sub>= 0.4743  
D<sub>50</sub>= 0.3993      D<sub>30</sub>= 0.2658      D<sub>15</sub>= 0.1009  
D<sub>10</sub>=              C<sub>u</sub>=              C<sub>c</sub>=

Remarks

---

Date Received: 10.15.19      Date Tested: 10.22.19

Tested By: IA

Checked By: Steven Accetta

Title: Laboratory Coordinator

\* (no specification provided)

Source of Sample: Boring      Depth: 19-21'  
Sample Number: GZ-6/S-6

Date Sampled:

<b>Thielsch Engineering Inc.</b>	Client: GZA GeoEnvironmental
<b>Cranston, RI</b>	Project: Taunton Waste Water Treatment Plant Taunton, MA
	Project No: 03.0034664.00      Figure 19-S-2222

# Particle Size Distribution Report

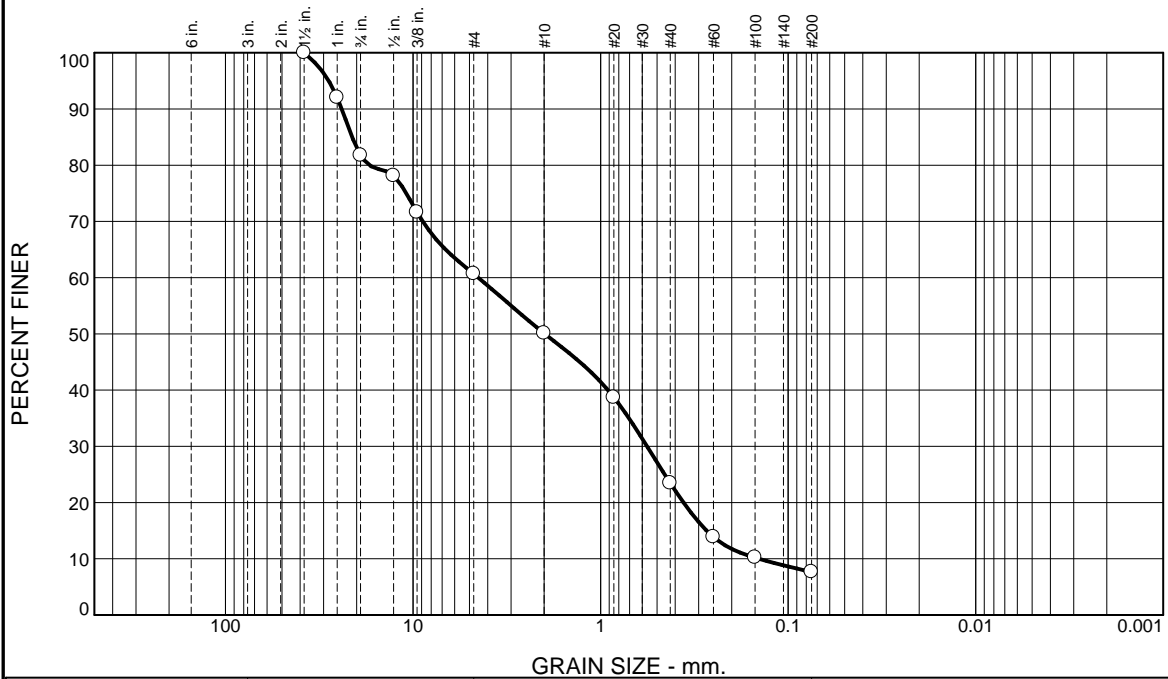

% +3"	% Gravel		% Sand			% Fines	
	Coarse	Fine	Coarse	Medium	Fine	Silt	Clay
0.0	18.2	21.1	10.6	26.6	15.9	7.6	

Test Results (D6913 & ASTM D 1140)			
Opening Size	Percent Finer	Spec.* (Percent)	Pass? (X=Fail)
1-1/2"	100.0		
1"	92.1		
3/4"	81.8		
1/2"	78.1		
3/8"	71.6		
#4	60.7		
#10	50.1		
#20	38.7		
#40	23.5		
#60	13.9		
#100	10.2		
#200	7.6		

\* (no specification provided)

**Material Description**

Gray f-c SAND and f-c GRAVEL, trace Silt

**Atterberg Limits (ASTM D 4318)**

PL= NP                      LL= NV                      PI= NP

**Classification**

USCS (D 2487)= SP-SM    AASHTO (M 145)= A-1-a

**Coefficients**

D<sub>90</sub>= 24.0020      D<sub>85</sub>= 21.1093      D<sub>60</sub>= 4.4902  
D<sub>50</sub>= 1.9839      D<sub>30</sub>= 0.5653      D<sub>15</sub>= 0.2718  
D<sub>10</sub>= 0.1428      C<sub>u</sub>= 31.44      C<sub>c</sub>= 0.50

Remarks

Date Received: 10.15.19      Date Tested: 10.22.19

Tested By: IA

Checked By: Steven Accetta

Title: Laboratory Coordinator

Source of Sample: Boring      Depth: 24-26'  
Sample Number: GZ-5 / S-7

Date Sampled:

<b>Thielsch Engineering Inc.</b>  <b>Cranston, RI</b>	<b>Client:</b> GZA GeoEnvironmental <b>Project:</b> Taunton Waste Water Treatment Plant Taunton, MA <b>Project No:</b> 03.0034664.00
<b>Figure</b> 19-S-2223	

# Particle Size Distribution Report

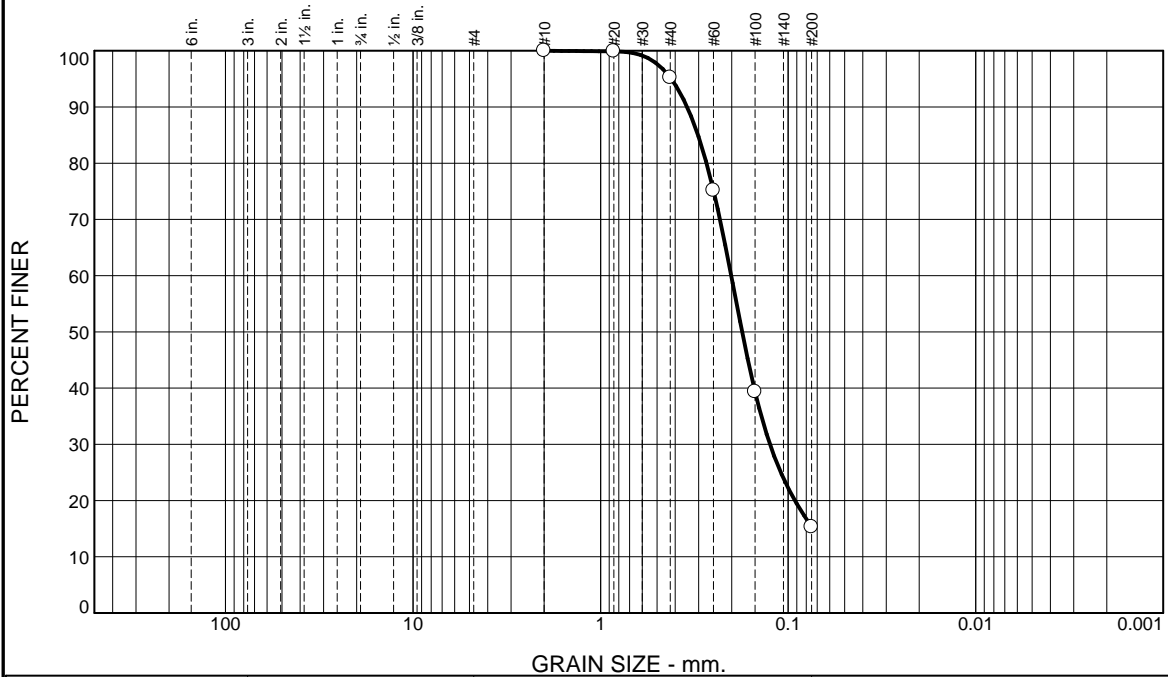

% +3"	% Gravel		% Sand			% Fines	
	Coarse	Fine	Coarse	Medium	Fine	Silt	Clay
0.0	0.0	0.0	0.0	4.8	79.9	15.3	

Test Results (D6913 & ASTM D 1140)			
Opening Size	Percent Finer	Spec.* (Percent)	Pass? (X=Fail)
#10	100.0		
#20	99.9		
#40	95.2		
#60	75.2		
#100	39.3		
#200	15.3		

**Material Description**

Gray fine SAND, little Silt

**Atterberg Limits (ASTM D 4318)**

PL= NP                      LL= NV                      PI= NP

**Classification**

USCS (D 2487)= SM                      AASHTO (M 145)= A-2-4(0)

**Coefficients**

D<sub>90</sub>= 0.3455                      D<sub>85</sub>= 0.3022                      D<sub>60</sub>= 0.2011  
D<sub>50</sub>= 0.1757                      D<sub>30</sub>= 0.1249                      D<sub>15</sub>=  
D<sub>10</sub>=                                      C<sub>u</sub>=                                      C<sub>c</sub>=

Remarks

---

Date Received: 10.15.19                      Date Tested: 10.22.19

Tested By: IA

Checked By: Steven Accetta

Title: Laboratory Coordinator

\* (no specification provided)

Source of Sample: Boring                      Depth: 14-16'  
Sample Number: GZ-4 / S-5

Date Sampled:

<b>Thielsch Engineering Inc.</b>	Client: GZA GeoEnvironmental
<b>Cranston, RI</b>	Project: Taunton Waste Water Treatment Plant Taunton, MA
	Project No: 03.0034664.00                      Figure 19-S-2224

# Particle Size Distribution Report

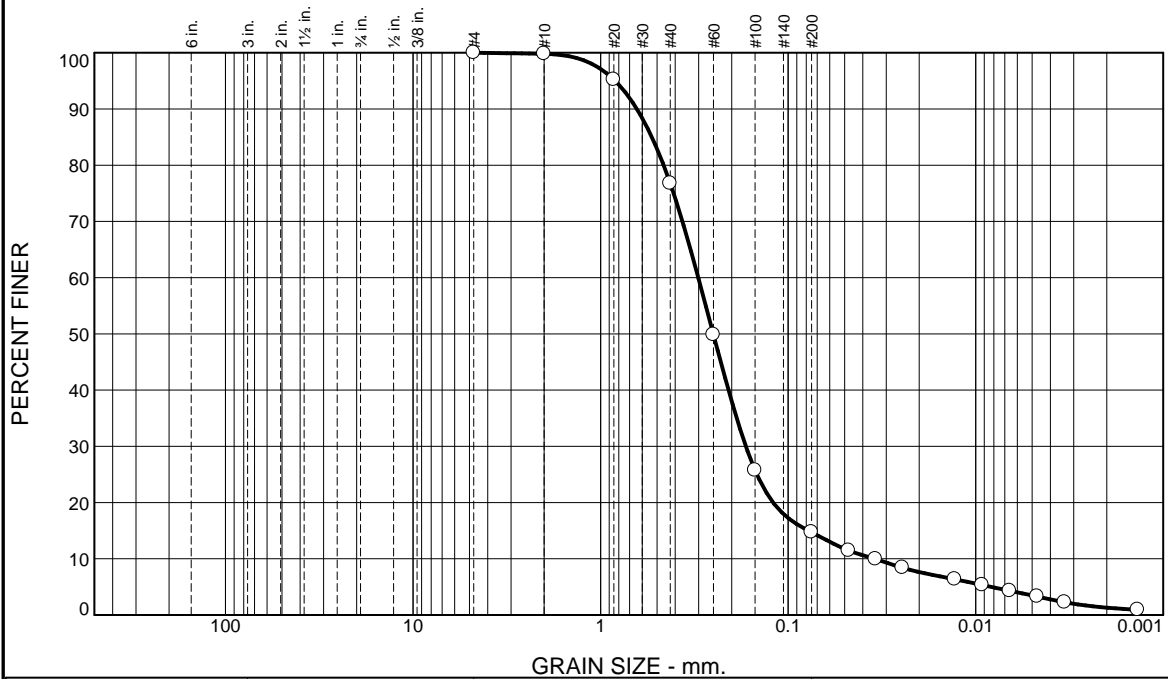

% +3"	% Gravel		% Sand			% Fines	
	Coarse	Fine	Coarse	Medium	Fine	Silt	Clay
0.0	0.0	0.0	0.2	23.0	62.1	13.4	1.3

Test Results (D7928 & ASTM D 1140)			
Opening Size	Percent Finer	Spec.* (Percent)	Pass? (X=Fail)
#4	100.0		
#10	99.8		
#20	95.2		
#40	76.8		
#60	49.9		
#100	25.7		
#200	14.7		
0.0476 mm.	11.5		
0.0342 mm.	9.9		
0.0245 mm.	8.4		
0.0129 mm.	6.4		
0.0092 mm.	5.3		
0.0066 mm.	4.3		
0.0047 mm.	3.3		
0.0034 mm.	2.3		
0.0014 mm.	0.9		

\* (no specification provided)

**Material Description**

Brown f-m SAND, little Silt

**Atterberg Limits (ASTM D 4318)**

PL= NP                      LL= NV                      PI= NP

**Classification**

USCS (D 2487)= SM                      AASHTO (M 145)= A-2-4(0)

**Coefficients**

D<sub>90</sub>= 0.6407                      D<sub>85</sub>= 0.5330                      D<sub>60</sub>= 0.3013  
D<sub>50</sub>= 0.2507                      D<sub>30</sub>= 0.1680                      D<sub>15</sub>= 0.0778  
D<sub>10</sub>= 0.0347                      C<sub>u</sub>= 8.69                      C<sub>c</sub>= 2.70

**Remarks**

Date Received: 10.15.19                      Date Tested: 10.23.19

Tested By: IA / JF

Checked By: Steven Accetta

Title: Laboratory Coordinator

Source of Sample: Boring                      Depth: 9-11'  
Sample Number: GZ-10 / S-4

Date Sampled:

<b>Thielsch Engineering Inc.</b>	Client: GZA GeoEnvironmental
<b>Cranston, RI</b>	Project: Taunton Waste Water Treatment Plant Taunton, MA
	Project No: 03.0034664.00
	Figure 19-S-2225

# Particle Size Distribution Report

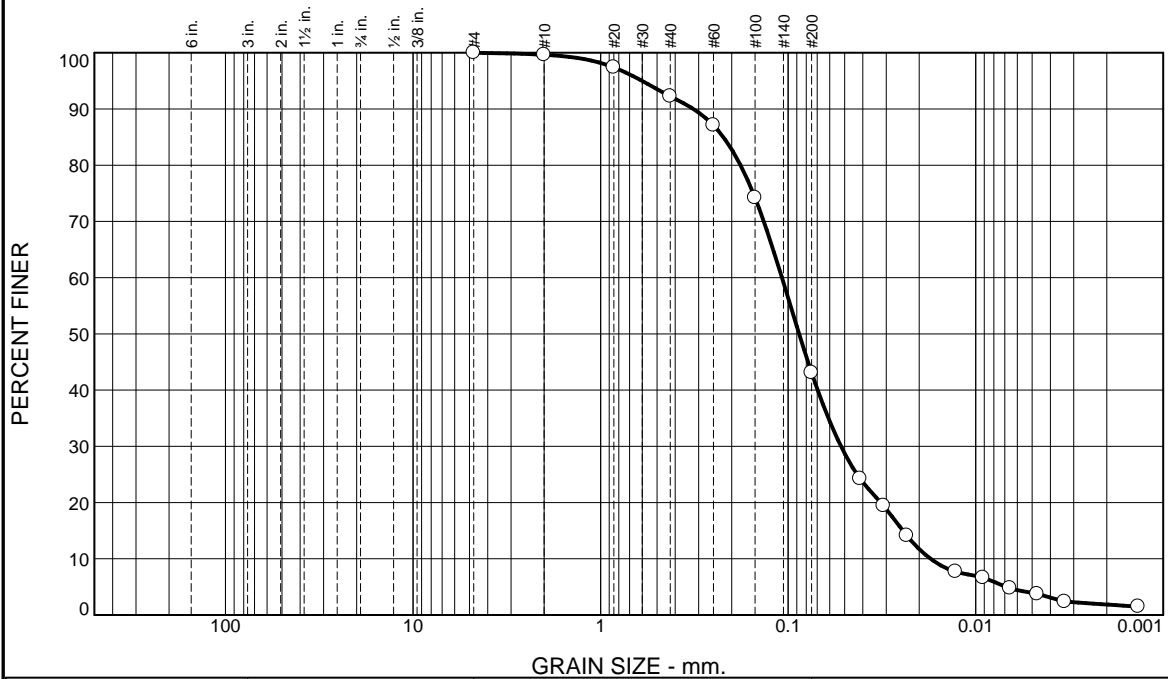

% +3"	% Gravel		% Sand			% Fines	
	Coarse	Fine	Coarse	Medium	Fine	Silt	Clay
0.0	0.0	0.0	0.4	7.3	49.2	41.2	1.9

Test Results (D7928 & ASTM D 1140)			
Opening Size	Percent Finer	Spec.* (Percent)	Pass? (X=Fail)
#4	100.0		
#10	99.6		
#20	97.4		
#40	92.3		
#60	87.1		
#100	74.2		
#200	43.1		
0.0413 mm.	24.2		
0.0310 mm.	19.4		
0.0233 mm.	14.1		
0.0128 mm.	7.7		
0.0091 mm.	6.6		
0.0066 mm.	4.8		
0.0047 mm.	3.7		
0.0034 mm.	2.4		
0.0014 mm.	1.5		

\* (no specification provided)

**Material Description**

Gray f-m SAND and SILT

**Atterberg Limits (ASTM D 4318)**

PL= NP                      LL= NV                      PI= NP

**Classification**

USCS (D 2487)= SM                      AASHTO (M 145)= A-4(0)

**Coefficients**

D<sub>90</sub>= 0.3197                      D<sub>85</sub>= 0.2215                      D<sub>60</sub>= 0.1079  
D<sub>50</sub>= 0.0874                      D<sub>30</sub>= 0.0522                      D<sub>15</sub>= 0.0245  
D<sub>10</sub>= 0.0174                      C<sub>u</sub>= 6.20                      C<sub>c</sub>= 1.45

**Remarks**

Sample visually classified as non-plastic.

Date Received: 10.15.19                      Date Tested: 10.23.19

Tested By: IA / JF

Checked By: Steven Accetta

Title: Laboratory Coordinator

Source of Sample: Boring                      Depth: 24-26'  
Sample Number: GZ-3 / S-7

Date Sampled:

<b>Thielsch Engineering Inc.</b>	Client: GZA GeoEnvironmental
<b>Cranston, RI</b>	Project: Taunton Waste Water Treatment Plant Taunton, MA
	Project No: 03.0034664.00
	Figure 19-S-2226

# Particle Size Distribution Report

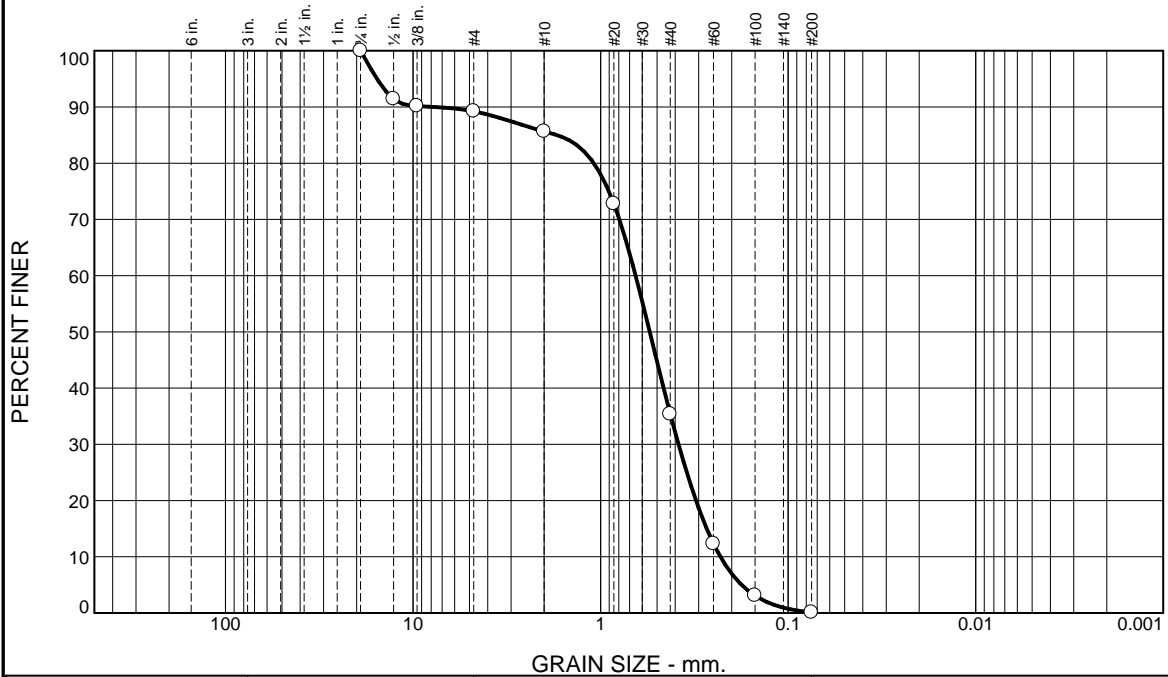

% +3"	% Gravel		% Sand			% Fines	
	Coarse	Fine	Coarse	Medium	Fine	Silt	Clay
0.0	0.0	10.8	3.6	50.2	35.3	0.1	

Test Results (D6913 & ASTM D 1140)			
Opening Size	Percent Finer	Spec.* (Percent)	Pass? (X=Fail)
0.75"	100.0		
0.5"	91.4		
0.375"	90.2		
#4	89.2		
#10	85.6		
#20	72.8		
#40	35.4		
#60	12.3		
#100	3.1		
#200	0.1		

**Material Description**

Gray f-m SAND, little fine Gravel, trace Silt

**Atterberg Limits (ASTM D 4318)**

PL= NP                      LL= NV                      PI= NP

**Classification**

USCS (D 2487)= SP                      AASHTO (M 145)= A-1-b

**Coefficients**

D<sub>90</sub>= 7.7003                      D<sub>85</sub>= 1.7096                      D<sub>60</sub>= 0.6508  
 D<sub>50</sub>= 0.5468                      D<sub>30</sub>= 0.3841                      D<sub>15</sub>= 0.2716  
 D<sub>10</sub>= 0.2297                      C<sub>u</sub>= 2.83                      C<sub>c</sub>= 0.99

Remarks

---

Date Received: 10.15.19                      Date Tested: 10.22.19

Tested By: IA

Checked By: Steven Accetta

Title: Laboratory Coordinator

\* (no specification provided)

Source of Sample: Boring                      Depth: 14-16'  
 Sample Number: GZ-2 / S-6

Date Sampled:

<b>Thielsch Engineering Inc.</b>	Client: GZA GeoEnvironmental
<b>Cranston, RI</b>	Project: Taunton Waste Water Treatment Plant Taunton, MA
	Project No: 03.0034664.00                      Figure 19-S-2227

# Particle Size Distribution Report

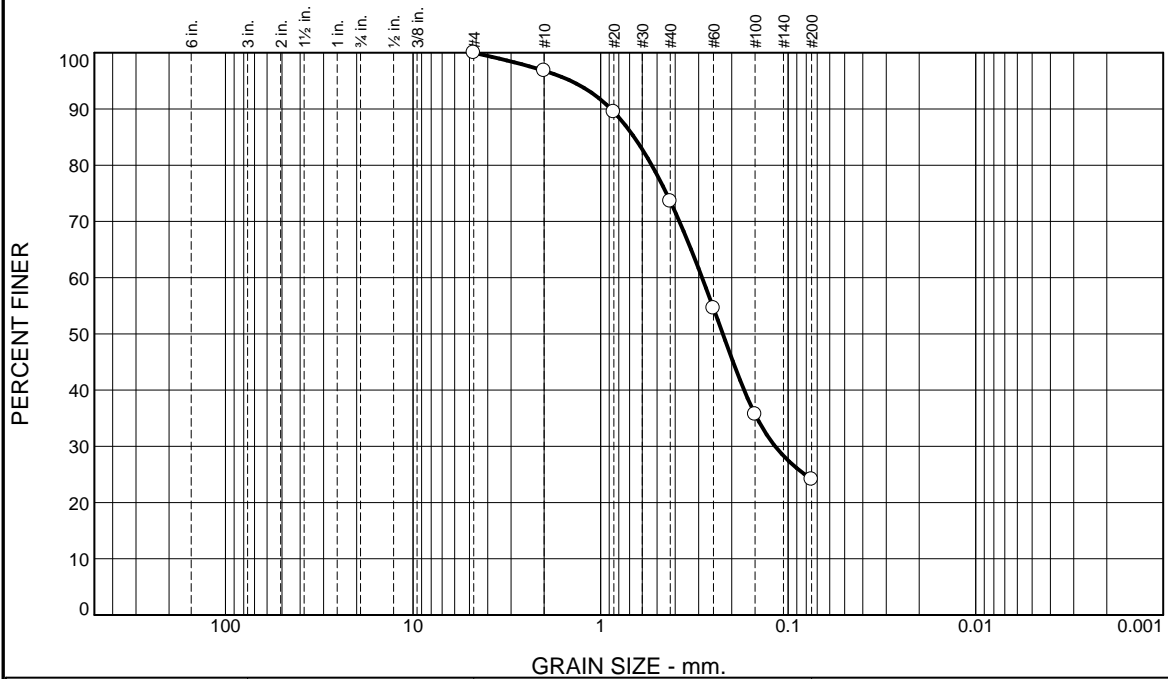

% +3"	% Gravel		% Sand			% Fines	
	Coarse	Fine	Coarse	Medium	Fine	Silt	Clay
0.0	0.0	0.0	3.2	23.2	49.5	24.1	

Test Results (D6913 & ASTM D 1140)			
Opening Size	Percent Finer	Spec.* (Percent)	Pass? (X=Fail)
#4	100.0		
#10	96.8		
#20	89.5		
#40	73.6		
#60	54.6		
#100	35.7		
#200	24.1		

\* (no specification provided)

**Material Description**

Gray f-m SAND, some Silt

**Atterberg Limits (ASTM D 4318)**

PL= NP                      LL= NV                      PI= NP

**Classification**

USCS (D 2487)= SM                      AASHTO (M 145)= A-2-4(0)

**Coefficients**

D<sub>90</sub>= 0.8808                      D<sub>85</sub>= 0.6625                      D<sub>60</sub>= 0.2875  
D<sub>50</sub>= 0.2230                      D<sub>30</sub>= 0.1173                      D<sub>15</sub>=  
D<sub>10</sub>=                                      C<sub>u</sub>=                                      C<sub>c</sub>=

Remarks

Date Received: 10.15.19                      Date Tested: 10.22.19

Tested By: IA

Checked By: Steven Accetta

Title: Laboratory Coordinator

Source of Sample: Boring                      Depth: 4-6'  
Sample Number: GZ-1 / S-3

Date Sampled:

<b>Thielsch Engineering Inc.</b>	Client: GZA GeoEnvironmental
<b>Cranston, RI</b>	Project: Taunton Waste Water Treatment Plant Taunton, MA
	Project No: 03.0034664.00
	Figure 19-S-2228

# Particle Size Distribution Report

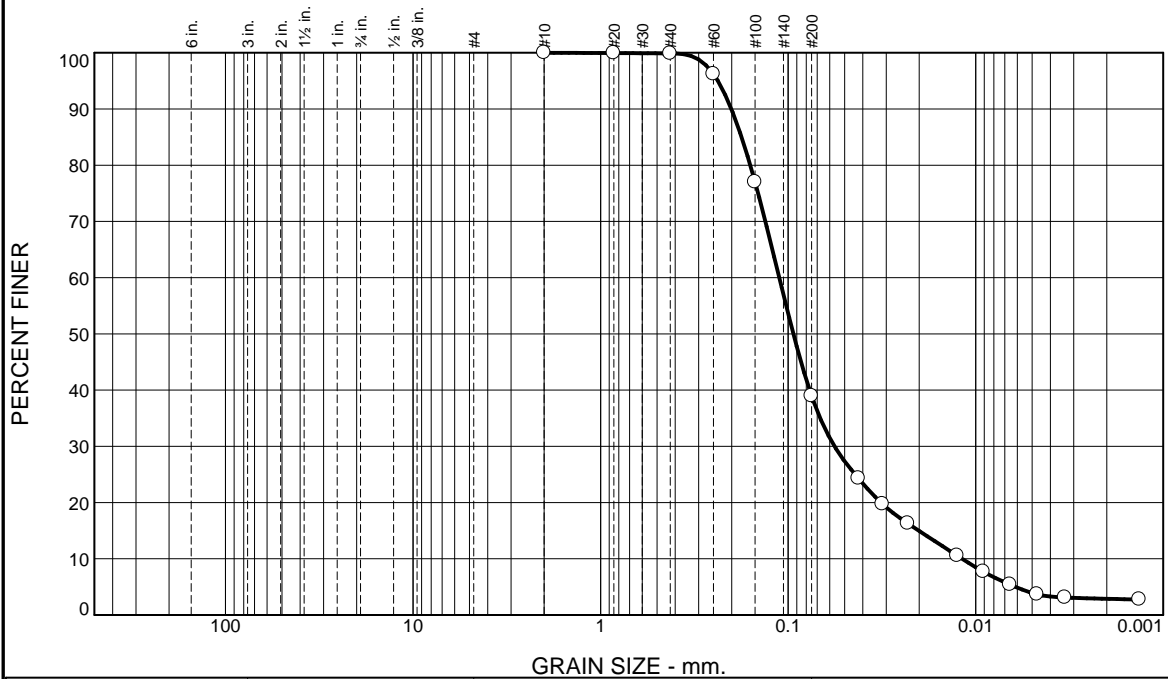

% +3"	% Gravel		% Sand			% Fines	
	Coarse	Fine	Coarse	Medium	Fine	Silt	Clay
0.0	0.0	0.0	0.0	0.1	60.9	36.1	2.9

Test Results (D7928 & ASTM D 1140)			
Opening Size	Percent Finer	Spec.* (Percent)	Pass? (X=Fail)
#10	100.0		
#20	100.0		
#40	99.9		
#60	96.2		
#100	77.0		
#200	39.0		
0.0422 mm.	24.3		
0.0314 mm.	19.7		
0.0230 mm.	16.3		
0.0125 mm.	10.6		
0.0091 mm.	7.7		
0.0066 mm.	5.4		
0.0047 mm.	3.7		
0.0033 mm.	3.1		
0.0013 mm.	2.8		

\* (no specification provided)

**Material Description**

Light Brown fine SAND and SILT

**Atterberg Limits (ASTM D 4318)**

PL= NP                      LL= NV                      PI= NP

**Classification**

USCS (D 2487)= SM                      AASHTO (M 145)= A-4(0)

**Coefficients**

D<sub>90</sub>= 0.2008                      D<sub>85</sub>= 0.1771                      D<sub>60</sub>= 0.1115  
D<sub>50</sub>= 0.0938                      D<sub>30</sub>= 0.0565                      D<sub>15</sub>= 0.0201  
D<sub>10</sub>= 0.0118                      C<sub>u</sub>= 9.45                      C<sub>c</sub>= 2.43

**Remarks**

Sample visually classified as non-plastic.

Date Received: 10.15.19                      Date Tested: 10.23.19

Tested By: IA / JF

Checked By: Steven Accetta

Title: Laboratory Coordinator

Source of Sample: Boring                      Depth: 9-11'  
Sample Number: GZ-5 / S-4

Date Sampled:

<b>Thielsch Engineering Inc.</b>  <b>Cranston, RI</b>	<b>Client:</b> GZA GeoEnvironmental <b>Project:</b> Taunton Waste Water Treatment Plant Taunton, MA <b>Project No:</b> 03.0034664.00
<b>Figure</b> 19-S-2229	



# Particle Size Distribution Report

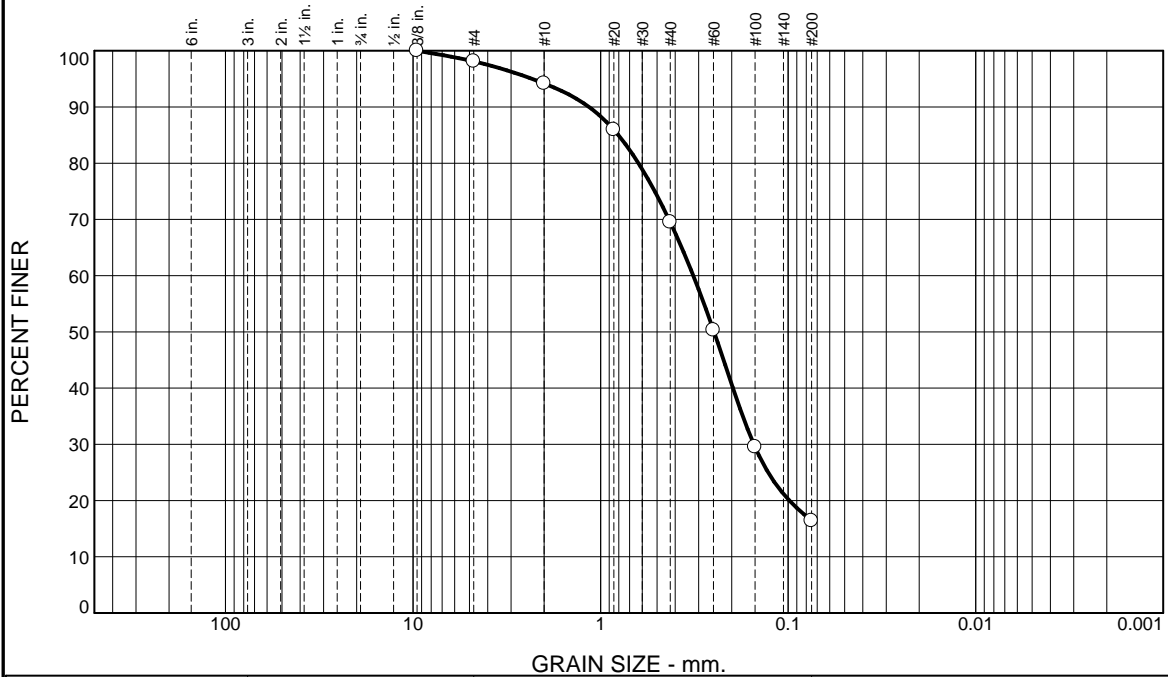

% +3"	% Gravel		% Sand			% Fines	
	Coarse	Fine	Coarse	Medium	Fine	Silt	Clay
0.0	0.0	1.9	3.9	24.7	53.1	16.4	

Test Results (D6913 & ASTM D 1140)			
Opening Size	Percent Finer	Spec.* (Percent)	Pass? (X=Fail)
0.375"	100.0		
#4	98.1		
#10	94.2		
#20	85.9		
#40	69.5		
#60	50.3		
#100	29.5		
#200	16.4		

\* (no specification provided)

**Material Description**

Gray f-m SAND, little Silt, trace fine Gravel

**Atterberg Limits (ASTM D 4318)**

PL= NP                      LL= NV                      PI= NP

**Classification**

USCS (D 2487)= SM                      AASHTO (M 145)= A-2-4(0)

**Coefficients**

D<sub>90</sub>= 1.1522                      D<sub>85</sub>= 0.8039                      D<sub>60</sub>= 0.3203  
D<sub>50</sub>= 0.2483                      D<sub>30</sub>= 0.1522  
D<sub>10</sub>=                                      C<sub>u</sub>=                                      C<sub>c</sub>=

Remarks

Date Received: 10.15.19                      Date Tested: 10.22.19

Tested By: IA

Checked By: Steven Accetta

Title: Laboratory Coordinator

Source of Sample: Boring                      Depth: 9-11'  
Sample Number: GZ-9/S-3

Date Sampled:

<b>Thielsch Engineering Inc.</b>	Client: GZA GeoEnvironmental
<b>Cranston, RI</b>	Project: Taunton Waste Water Treatment Plant Taunton, MA
	Project No: 03.0034664.00                      Figure 19-S-2230

# Particle Size Distribution Report

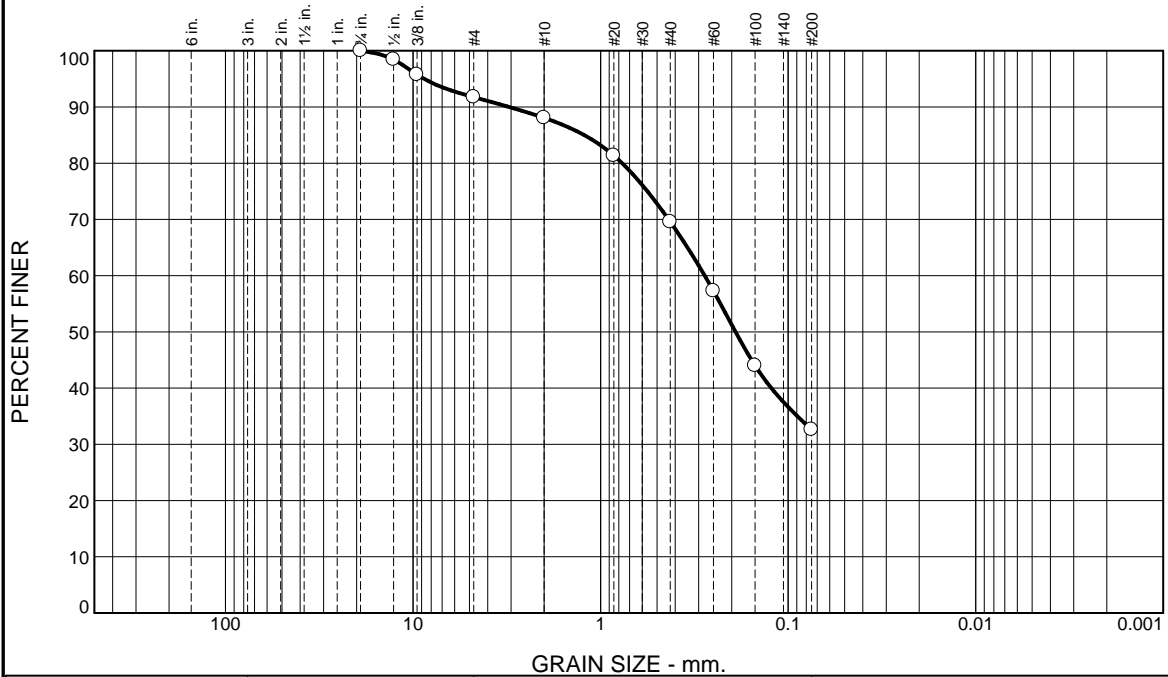

% +3"	% Gravel		% Sand			% Fines	
	Coarse	Fine	Coarse	Medium	Fine	Silt	Clay
0.0	0.0	8.2	3.7	18.5	37.0	32.6	

Test Results (D6913 & ASTM D 1140)			
Opening Size	Percent Finer	Spec.* (Percent)	Pass? (X=Fail)
0.75"	100.0		
0.5"	98.4		
0.375"	95.8		
#4	91.8		
#10	88.1		
#20	81.3		
#40	69.6		
#60	57.3		
#100	44.0		
#200	32.6		

**Material Description**

Brown f-m SAND, some Silt, trace fine Gravel

**Atterberg Limits (ASTM D 4318)**

PL= NP      LL= NV      PI= NP

**Classification**

USCS (D 2487)= SM      AASHTO (M 145)= A-2-4(0)

**Coefficients**

D<sub>90</sub>= 3.0668      D<sub>85</sub>= 1.2199      D<sub>60</sub>= 0.2783  
D<sub>50</sub>= 0.1907      D<sub>30</sub>=              D<sub>15</sub>=  
D<sub>10</sub>=              C<sub>u</sub>=              C<sub>c</sub>=

**Remarks**

Sample visually classified as non-plastic.

---

Date Received: 10.15.19      Date Tested: 10.22.19

Tested By: IA

Checked By: Steven Accetta

Title: Laboratory Coordinator

\* (no specification provided)

Source of Sample: Boring      Depth: 2-4'  
Sample Number: GZ-6/S-2

Date Sampled:

<b>Thielsch Engineering Inc.</b>	Client: GZA GeoEnvironmental
<b>Cranston, RI</b>	Project: Taunton Waste Water Treatment Plant Taunton, MA
	Project No: 03.0034664.00      Figure 19-S-2231



## **APPENDIX E**

### **AQUESOLV DATA SHEETS**

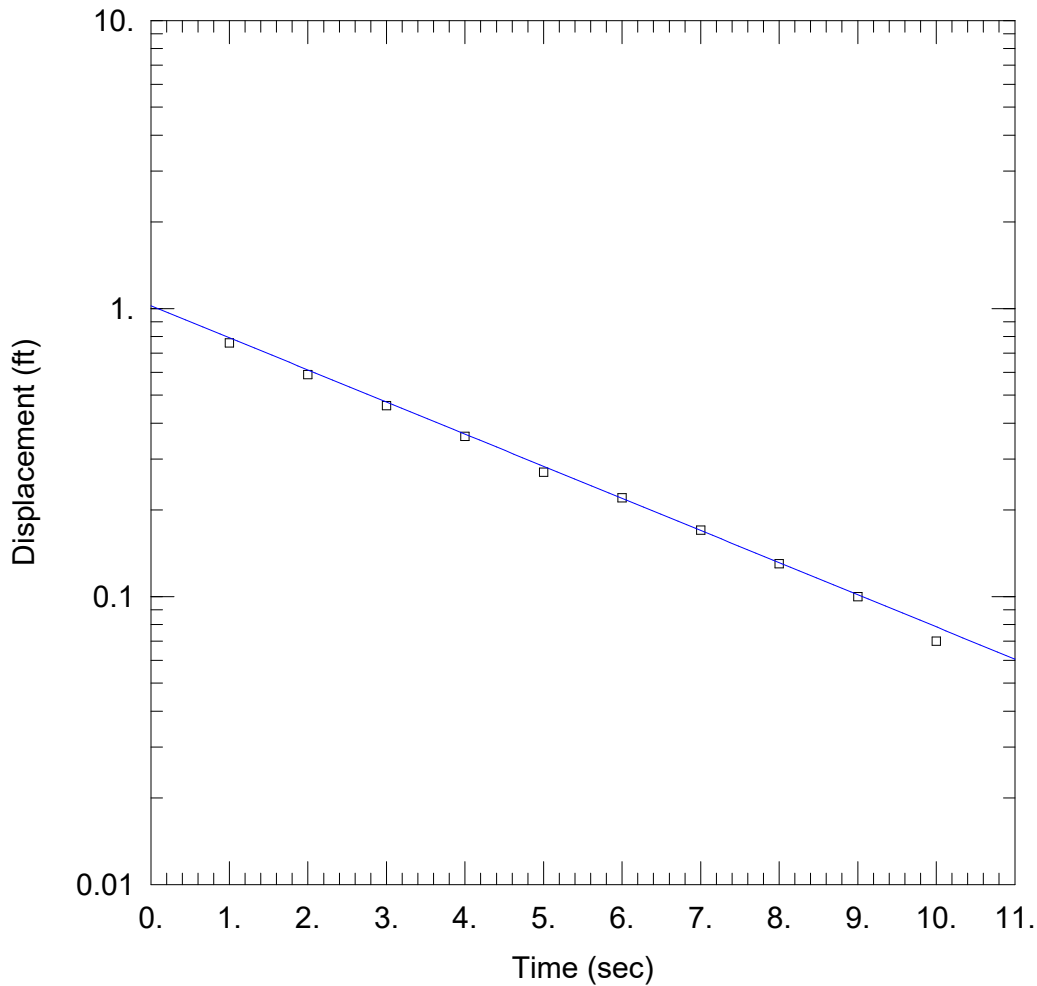

GZ-3

Data Set: J:\Geo\34664.jer\Work\Well Measurements\GZ-3.aqt  
 Date: 11/05/19 Time: 15:20:29

PROJECT INFORMATION

Company: GZA  
 Test Well: GZ-3  
 Test Date: 10/11

AQUIFER DATA

Saturated Thickness: 20 ft Anisotropy Ratio (Kz/Kr): 0.1

WELL DATA (GZ-3)

Initial Displacement: 1.6 ft Static Water Column Height: 14.3 ft  
 Total Well Penetration Depth: 15 ft Screen Length: 14.3 ft  
 Casing Radius: 0.08 ft Well Radius: 0.08 ft

SOLUTION

Aquifer Model: Unconfined Solution Method: Bower-Rice  
 K = 5.593 ft/day y0 = 1.022 ft

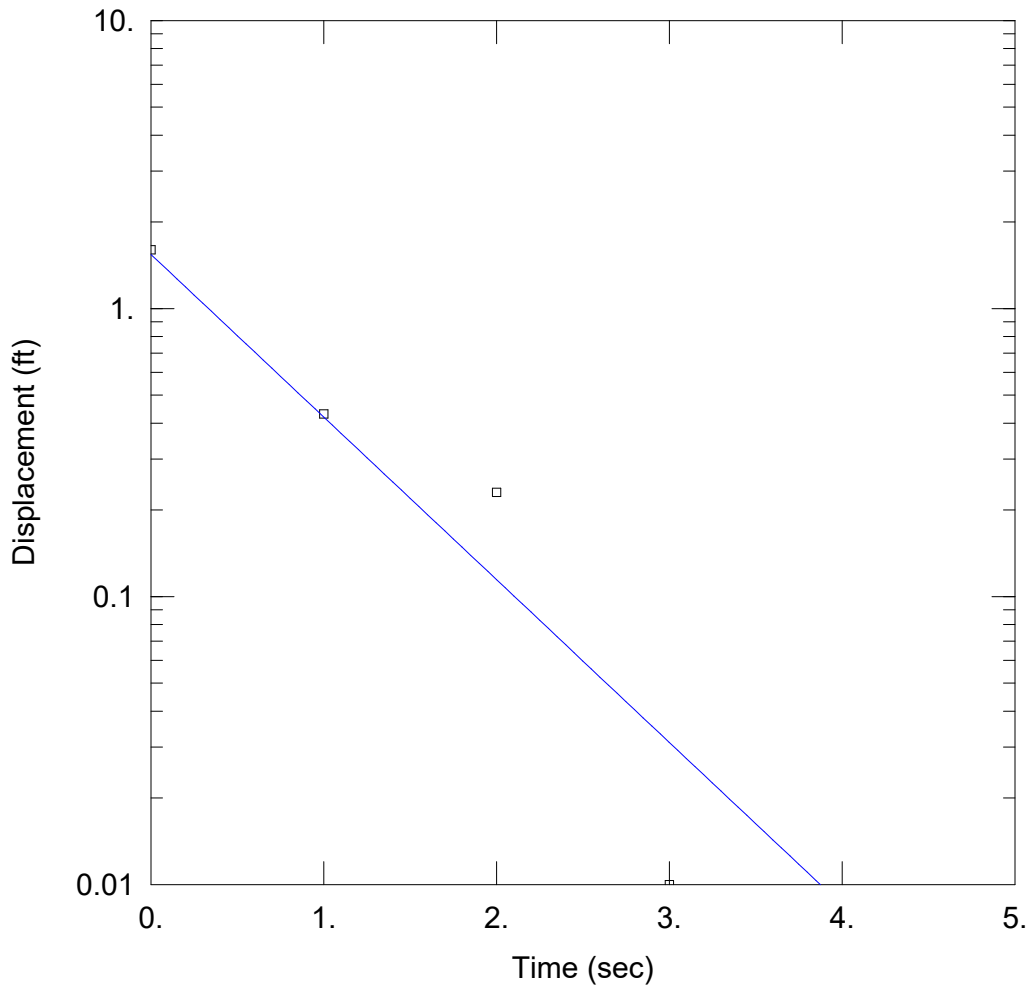

GZ-4

Data Set: J:\Geo\34664.jer\Work\Well Measurements\GZ-4.aqt  
 Date: 11/05/19 Time: 15:20:57

PROJECT INFORMATION

Company: GZA  
 Client: BETA Group  
 Project: 34664  
 Location: Taunton, MA  
 Test Well: GZ-4  
 Test Date: 10/11

AQUIFER DATA

Saturated Thickness: 15. ft Anisotropy Ratio (Kz/Kr): 0.1

WELL DATA (GZ-4)

Initial Displacement: 1.6 ft Static Water Column Height: 17.4 ft  
 Total Well Penetration Depth: 17.4 ft Screen Length: 15. ft  
 Casing Radius: 0.08 ft Well Radius: 0.08 ft

SOLUTION

Aquifer Model: Unconfined Solution Method: Bouwer-Rice  
 K = 30. ft/day  $y_0 =$  1.54 ft

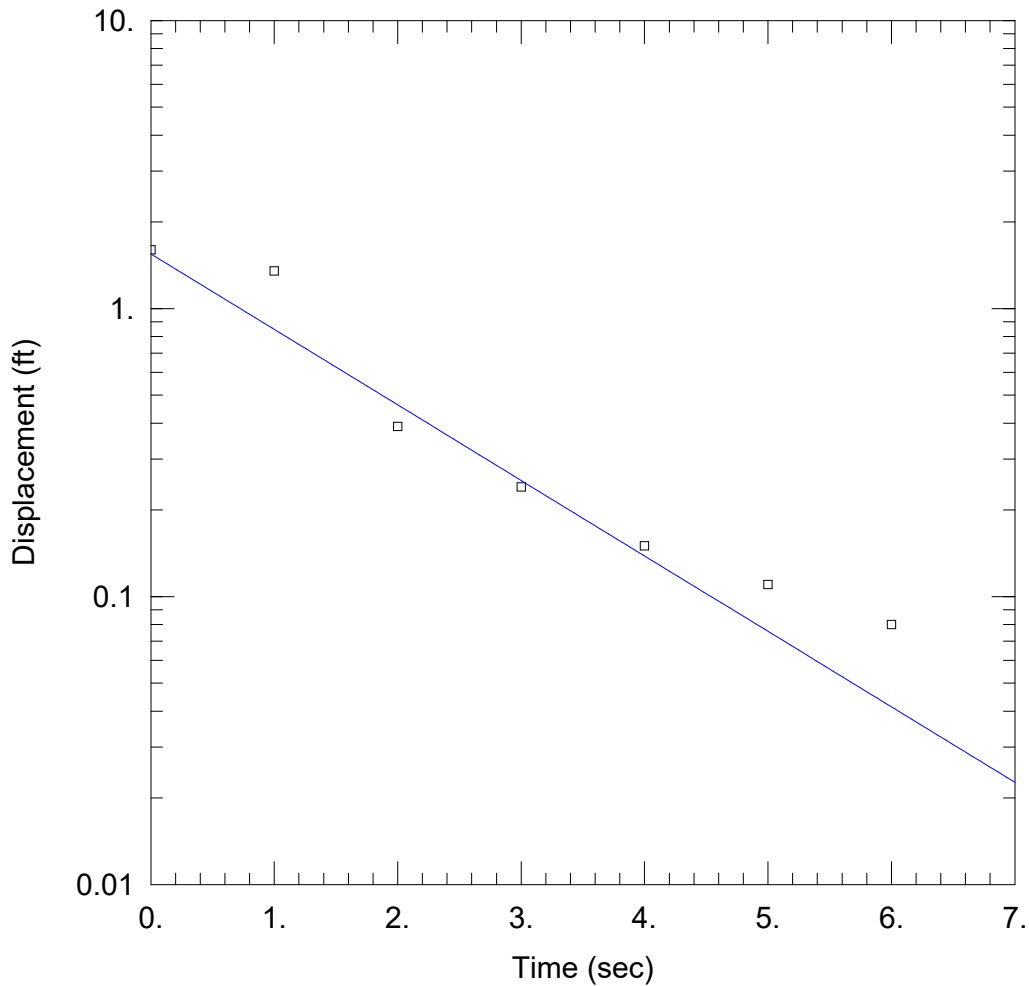

GZ-5

Data Set: J:\Geo\34664.jer\Work\Well Measurements\GZ-5.aqt  
 Date: 11/05/19 Time: 15:21:13

PROJECT INFORMATION

Company: GZA  
 Client: BETA Group  
 Project: 34664  
 Location: Taunton, MA  
 Test Well: GZ-5  
 Test Date: 10/11

AQUIFER DATA

Saturated Thickness: 20. ft Anisotropy Ratio (Kz/Kr): 0.1

WELL DATA (GZ-5)

Initial Displacement: 1.6 ft Static Water Column Height: 15.8 ft  
 Total Well Penetration Depth: 15.8 ft Screen Length: 15. ft  
 Casing Radius: 0.08 ft Well Radius: 0.08 ft

SOLUTION

Aquifer Model: Unconfined Solution Method: Bouwer-Rice  
 K = 12.72 ft/day y0 = 1.546 ft

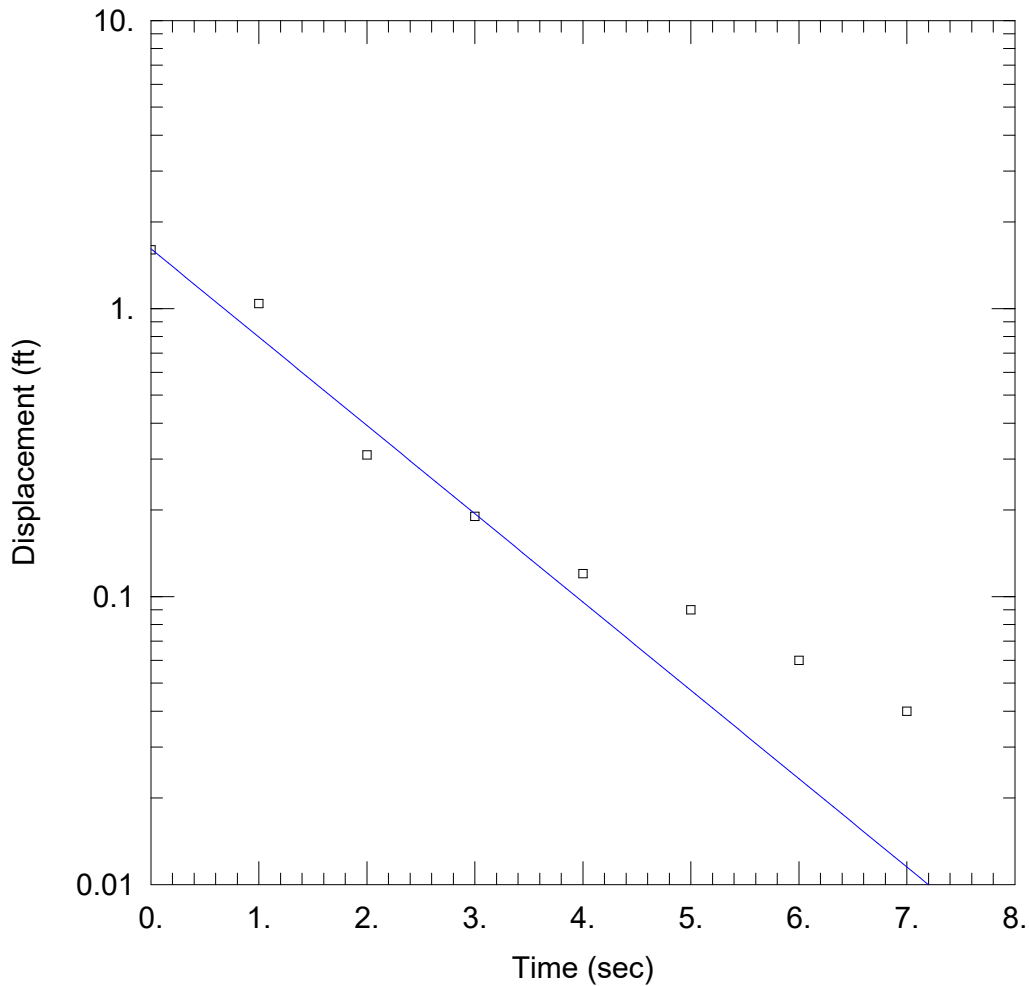

GZ-6

Data Set: J:\Geo\34664.jer\Work\Well Measurements\GZ-6.aqt  
 Date: 11/05/19 Time: 15:21:30

PROJECT INFORMATION

Company: GZA  
 Client: BETA Group  
 Project: 34664  
 Location: Taunton, MA  
 Test Well: GZ-6  
 Test Date: 10/11

AQUIFER DATA

Saturated Thickness: 20. ft Anisotropy Ratio (Kz/Kr): 0.1

WELL DATA (GZ-6)

Initial Displacement: 1.6 ft Static Water Column Height: 16.4 ft  
 Total Well Penetration Depth: 16.4 ft Screen Length: 15. ft  
 Casing Radius: 0.08 ft Well Radius: 0.08 ft

SOLUTION

Aquifer Model: Unconfined Solution Method: Bouwer-Rice  
 K = 15. ft/day y0 = 1.611 ft

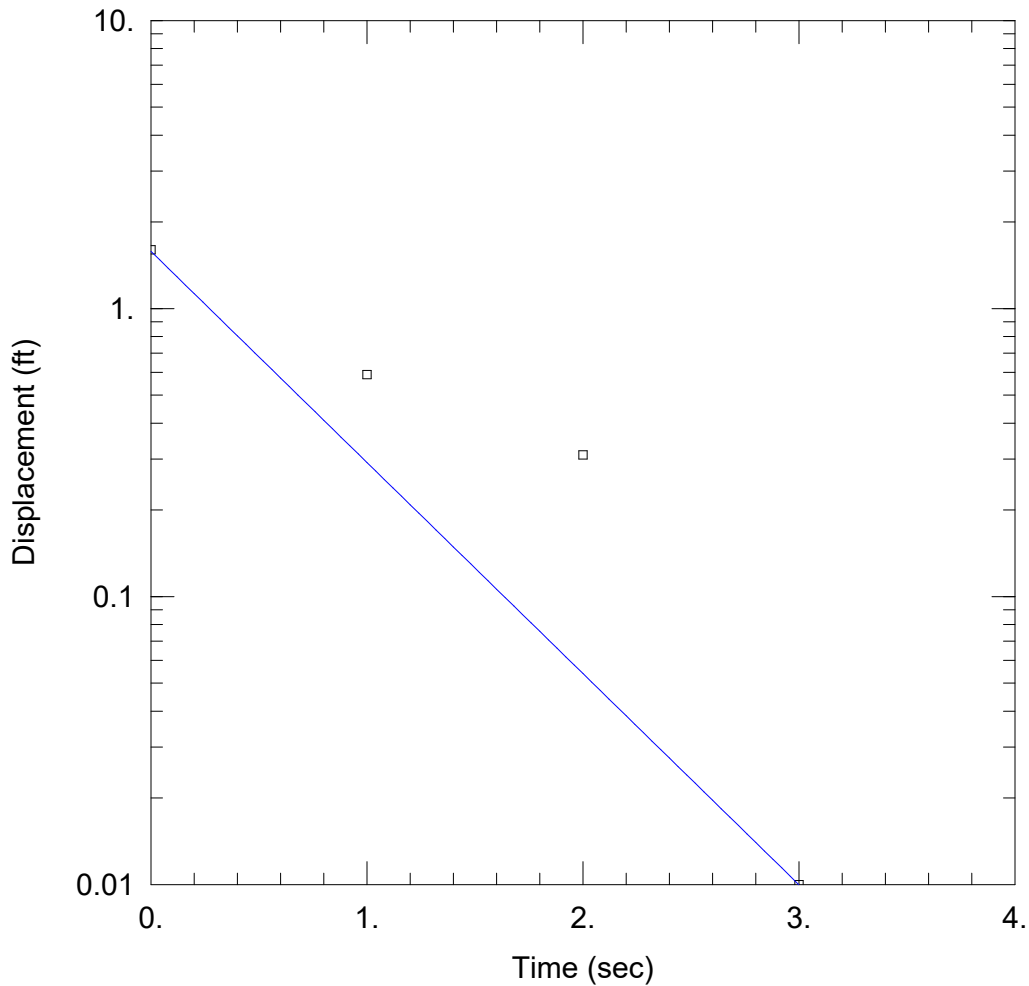

GZ-7

Data Set: J:\Geo\34664.jer\Work\Well Measurements\GZ-7.aqt  
 Date: 11/05/19 Time: 15:21:45

PROJECT INFORMATION

Company: GZA  
 Client: BETA Group  
 Project: 34664  
 Location: Taunton, MA  
 Test Well: GZ-7  
 Test Date: 10/11

AQUIFER DATA

Saturated Thickness: 20. ft Anisotropy Ratio (Kz/Kr): 0.1

WELL DATA (New Well)

Initial Displacement: 1.6 ft Static Water Column Height: 16.7 ft  
 Total Well Penetration Depth: 16.7 ft Screen Length: 15. ft  
 Casing Radius: 0.08 ft Well Radius: 0.08 ft

SOLUTION

Aquifer Model: Unconfined Solution Method: Bouwer-Rice  
 K = 36. ft/day y0 = 1.579 ft



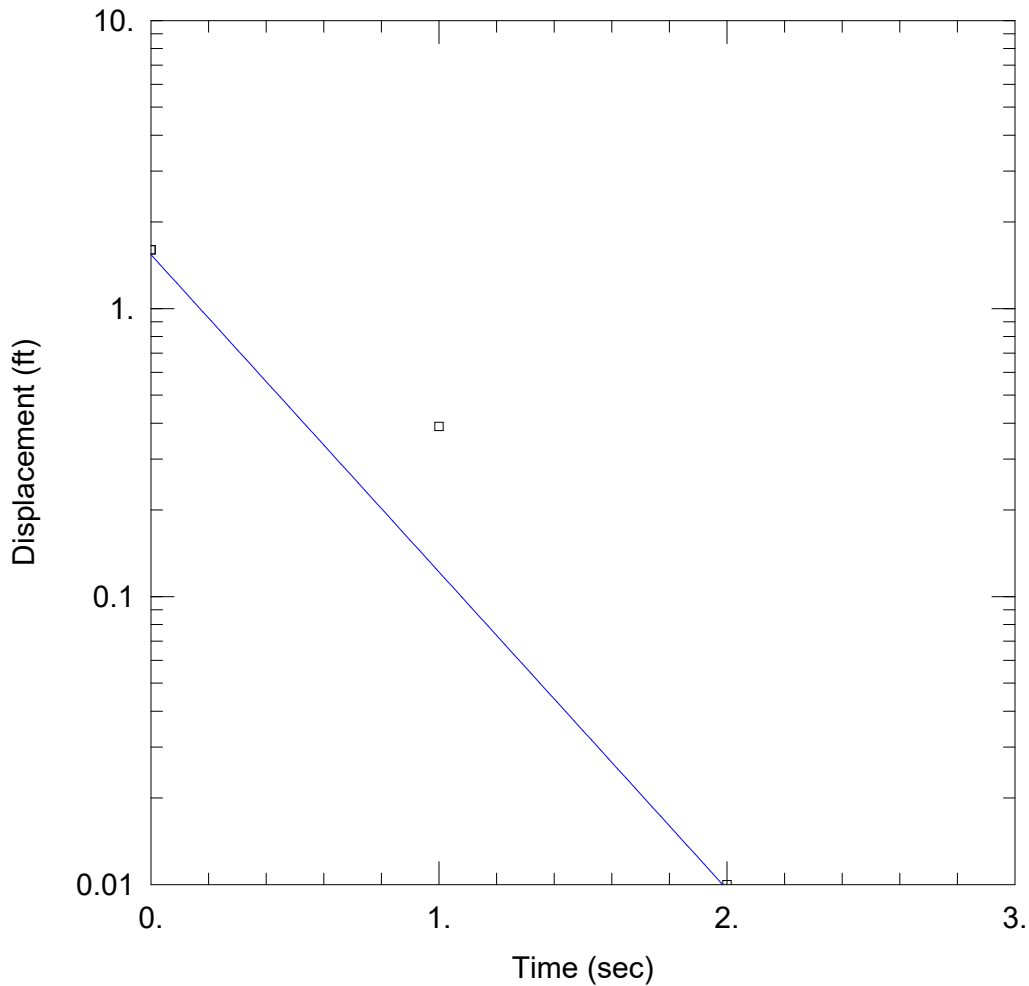

GZ-8

Data Set: J:\Geo\34664.jer\Work\Well Measurements\GZ-8.aqt  
 Date: 11/05/19 Time: 15:21:59

PROJECT INFORMATION

Company: GZA  
 Client: BETA Group  
 Project: 34664  
 Location: Taunton, MA  
 Test Well: GZ-8  
 Test Date: 10/11

AQUIFER DATA

Saturated Thickness: 20. ft Anisotropy Ratio (Kz/Kr): 0.1

WELL DATA (New Well)

Initial Displacement: 1.6 ft Static Water Column Height: 19.4 ft  
 Total Well Penetration Depth: 20. ft Screen Length: 19.4 ft  
 Casing Radius: 0.08 ft Well Radius: 0.08 ft

SOLUTION

Aquifer Model: Unconfined Solution Method: Bouwer-Rice  
 K = 47. ft/day y0 = 1.539 ft



## **APPENDIX F**

### **HYDRAULIC CONDUCTIVITY CALCULATIONS USING KOZENY-CARMEN EQUATION**

## Estimate Hydraulic Conductivity from Grain Size

### GZ-3

#### Assumed Basic Properties

$e_{max} := .90$	Maximum void Ratio	$Dr := 0.35$	Relative Density (95 % modified proctor)
$e_{min} := 0.3$	Minimum void Ratio	$G_s := 2.67$	Specific gravity of the solids (Gs)

#### Effective Grain Size from Lab Testing

Using  $D_{10} := 0.00174$  (cm)

#### Computed Void Ratio

$$e := e_{max} - Dr \cdot (e_{max} - e_{min})$$

$$e = 0.69$$

#### Calculate Porosity

$$n := \frac{e}{1 + e}$$

$$n = 0.73$$

#### Estimate Hydraulic Conductivity (Kozeny- Carman)

$\rho := .999$	Unit weight of water ( g/cc )
$\mu := 0.011$	Viscosity of water (g/sec-cm)
$g := 981.5$	Gravity (cm/sec^2)
$c_s := 1.68$	Shape Constant ( unitless )
$T_o := 1.85$	Tortuosity ( unitless )
$D_e := D_{10}$	Effective particle diameter (cm^2)
$S_s := \frac{6}{D_e}$	Specific Surface (1/cm) 6/d for spheres or cubes
$e = 0.69$	Void Ratio

$$K_{kc} := \frac{\rho \cdot g}{\mu} \cdot \frac{1}{c_s \cdot T_o^2 \cdot S_s^2} \cdot \left( \frac{e^3}{1 + e} \right)$$

$$K_{kc} = 2.534 \times 10^{-4} \text{ cm/sec} \quad K_{kc} := K_{kc} \cdot 2835$$

$$K_{kc} = 1 \text{ ft/day}$$

## Estimate Hydraulic Conductivity from Grain Size

### GZ-4

#### Assumed Basic Properties

$e_{max} := .90$	Maximum void Ratio	$Dr := 0.35$	Relative Density (95 % modified proctor)
$e_{min} := 0.3$	Minimum void Ratio	$G_s := 2.67$	Specific gravity of the solids (Gs)

#### Effective Grain Size from Lab Testing

Using  $D_{10} := 0.005$  (cm)

#### Computed Void Ratio

$$e := e_{max} - Dr \cdot (e_{max} - e_{min})$$

$$e = 0.69$$

#### Calculate Porosity

$$n := \frac{e}{1 + e}$$

$$n = 0.73$$

#### Estimate Hydraulic Conductivity (Kozeny- Carman)

$\rho := .999$	Unit weight of water ( g/cc )
$\mu := 0.011$	Viscosity of water (g/sec-cm)
$g := 981.5$	Gravity (cm/sec^2)
$c_s := 1.68$	Shape Constant ( unitless )
$T_o := 1.85$	Tortuosity ( unitless )
$D_e := D_{10}$	Effective particle diameter (cm^2)
$S_s := \frac{6}{D_e}$	Specific Surface (1/cm) 6/d for spheres or cubes
$e = 0.69$	Void Ratio

$$K_{kc} := \frac{\rho \cdot g}{\mu} \cdot \frac{1}{c_s \cdot T_o^2 \cdot S_s^2} \cdot \left( \frac{e^3}{1 + e} \right)$$

$$K_{kc} = 2.093 \times 10^{-3} \text{ cm/sec} \quad K_{kc} := K_{kc} \cdot 2835$$

$$K_{kc} = 6 \text{ ft/day}$$

## Estimate Hydraulic Conductivity from Grain Size

### GZ-5

#### Assumed Basic Properties

$e_{max} := .85$	Maximum void Ratio	$Dr := 0.65$	Relative Density (95 % modified proctor)
$e_{min} := 0.14$	Minimum void Ratio	$G_s := 2.67$	Specific gravity of the solids (Gs)

#### Effective Grain Size from Lab Testing

Using  $D_{10} := 0.01428$  (cm)

#### Computed Void Ratio

$$e := e_{max} - Dr \cdot (e_{max} - e_{min})$$

$e = 0.389$

#### Calculate Porosity

$$n := \frac{e}{1 + e}$$

$n = 0.73$

#### Estimate Hydraulic Conductivity (Kozeny- Carman)

$\rho := .999$	Unit weight of water ( g/cc )
$\mu := 0.011$	Viscosity of water (g/sec-cm)
$g := 981.5$	Gravity (cm/sec^2)
$c_s := 1.68$	Shape Constant ( unitless )
$T_o := 1.85$	Tortuosity ( unitless )
$D_e := D_{10}$	Effective particle diameter (cm^2)
$S_s := \frac{6}{D_e}$	Specific Surface (1/cm) 6/d for spheres or cubes
$e = 0.389$	Void Ratio

$$K_{kc} := \frac{\rho \cdot g}{\mu} \cdot \frac{1}{c_s \cdot T_o^2 \cdot S_s^2} \cdot \left( \frac{e^3}{1 + e} \right)$$

$K_{kc} = 3.708 \times 10^{-3}$  cm/sec       $K_{kc} := K_{kc} \cdot 2835$

$K_{kc} = 11$  ft/day

## Estimate Hydraulic Conductivity from Grain Size

### GZ-6

#### Assumed Basic Properties

$e_{max} := .90$	Maximum void Ratio	$D_r := 0.75$	Relative Density (95 % modified proctor)
$e_{min} := 0.3$	Minimum void Ratio	$G_s := 2.67$	Specific gravity of the solids (Gs)

#### Effective Grain Size from Lab Testing

Using  $D_{10} := 0.003$  (cm)

#### Computed Void Ratio

$$e := e_{max} - D_r \cdot (e_{max} - e_{min})$$

$$e = 0.45$$

#### Calculate Porosity

$$n := \frac{e}{1 + e}$$

$$n = 0.73$$

#### Estimate Hydraulic Conductivity (Kozeny- Carman)

$\rho := .999$	Unit weight of water ( g/cc )
$\mu := 0.011$	Viscosity of water (g/sec-cm)
$g := 981.5$	Gravity (cm/sec^2)
$c_s := 1.68$	Shape Constant ( unitless )
$T_o := 1.85$	Tortuosity ( unitless )
$D_e := D_{10}$	Effective particle diameter (cm^2)
$S_s := \frac{6}{D_e}$	Specific Surface (1/cm) 6/d for spheres or cubes
$e = 0.45$	Void Ratio

$$K_{kc} := \frac{\rho \cdot g}{\mu} \cdot \frac{1}{c_s \cdot T_o^2 \cdot S_s^2} \cdot \left( \frac{e^3}{1 + e} \right)$$

$$K_{kc} = 2.436 \times 10^{-4} \text{ cm/sec} \quad K_{kc} := K_{kc} \cdot 2835$$

$$K_{kc} = 1 \text{ ft/day}$$

## Estimate Hydraulic Conductivity from Grain Size

### GZ-7

#### Assumed Basic Properties

$e_{max} := .95$	Maximum void Ratio	$Dr := 0.5$	Relative Density (95 % modified proctor)
$e_{min} := 0.2$	Minimum void Ratio	$G_s := 2.67$	Specific gravity of the solids (Gs)

#### Effective Grain Size from Lab Testing

Using  $D_{10} := 0.01099$  (cm)

#### Computed Void Ratio

$$e := e_{max} - Dr \cdot (e_{max} - e_{min})$$

$$e = 0.575$$

#### Calculate Porosity

$$n := \frac{e}{1 + e}$$

$$n = 0.73$$

#### Estimate Hydraulic Conductivity (Kozeny- Carman)

$\rho := .999$	Unit weight of water ( g/cc )
$\mu := 0.011$	Viscosity of water (g/sec-cm)
$g := 981.5$	Gravity (cm/sec^2)
$c_s := 1.68$	Shape Constant ( unitless )
$T_o := 1.85$	Tortuosity ( unitless )
$D_e := D_{10}$	Effective particle diameter (cm^2)
$S_s := \frac{6}{D_e}$	Specific Surface (1/cm) 6/d for spheres or cubes
$e = 0.575$	Void Ratio

$$K_{kc} := \frac{\rho \cdot g}{\mu} \cdot \frac{1}{c_s \cdot T_o^2 \cdot S_s^2} \cdot \left( \frac{e^3}{1 + e} \right)$$

$$K_{kc} = 6.278 \times 10^{-3} \text{ cm/sec} \quad K_{kc} := K_{kc} \cdot 2835$$

$$K_{kc} = 18 \text{ ft/day}$$

## Estimate Hydraulic Conductivity from Grain Size

### GZ-8

#### Assumed Basic Properties

$e_{max} := .95$	Maximum void Ratio	$Dr := 0.35$	Relative Density (95 % modified proctor)
$e_{min} := 0.2$	Minimum void Ratio	$G_s := 2.67$	Specific gravity of the solids (Gs)

#### Effective Grain Size from Lab Testing

Using  $D_{10} := 0.01148$  (cm)

#### Computed Void Ratio

$$e := e_{max} - Dr \cdot (e_{max} - e_{min})$$

$$e = 0.688$$

#### Calculate Porosity

$$n := \frac{e}{1 + e}$$

$$n = 0.73$$

#### Estimate Hydraulic Conductivity (Kozeny- Carman)

$\rho := .999$	Unit weight of water ( g/cc )
$\mu := 0.011$	Viscosity of water (g/sec-cm)
$g := 981.5$	Gravity (cm/sec^2)
$c_s := 1.68$	Shape Constant ( unitless )
$T_o := 1.85$	Tortuosity ( unitless )
$D_e := D_{10}$	Effective particle diameter (cm^2)
$S_s := \frac{6}{D_e}$	Specific Surface (1/cm) 6/d for spheres or cubes
$e = 0.688$	Void Ratio

$$K_{kc} := \frac{\rho \cdot g}{\mu} \cdot \frac{1}{c_s \cdot T_o^2 \cdot S_s^2} \cdot \left( \frac{e^3}{1 + e} \right)$$

$$K_{kc} = 0.011 \quad \text{cm/sec} \quad K_{kc} := K_{kc} \cdot 2835$$

$$K_{kc} = 31 \quad \text{ft/day}$$